

FCC Test Report

(PART 22)

Report No.: RF170428C03-6

FCC ID: MSQA006

Test Model: ASUS_A006

Received Date: Apr. 28, 2017

Test Date: May 22, 2017 ~ May 23, 2017

Issued Date: Jun. 02, 2017

Applicant: ASUSTek COMPUTER INC.

Address: 4F, No. 150, LI-TE Rd., PEITOU, TAIPEI 112, TAIWAN

Issued By: Bureau Veritas Consumer Products Services (H.K.) Ltd., Taoyuan Branch

Lab Address: No. 47-2, 14th Ling, Chia Pau Vil., Lin Kou Dist., New Taipei City, Taiwan
(R.O.C)

Test Location (1): No. 19, Hwa Ya 2nd Rd, Wen Hwa Tsuen, Kwei Shan Hsiang, Taoyuan
Hsien 333, Taiwan, R.O.C.

Test Location (2): No.215, Sec. 3, Beixin Rd., Xindian Dist., New Taipei City 231, Taiwan,
R.O.C



This report is for your exclusive use. Any copying or replication of this report to or for any other person or entity, or use of our name or trademark, is permitted only with our prior written permission. This report sets forth our findings solely with respect to the test samples identified herein. The results set forth in this report are not indicative or representative of the quality or characteristics of the lot from which a test sample was taken or any similar or identical product unless specifically and expressly noted. Our report includes all of the tests requested by you and the results thereof based upon the information that you provided to us. You have 60 days from date of issuance of this report to notify us of any material error or omission caused by our negligence, provided, however, that such notice shall be in writing and shall specifically address the issue you wish to raise. A failure to raise such issue within the prescribed time shall constitute your unqualified acceptance of the completeness of this report, the tests conducted and the correctness of the report contents. Unless specific mention, the uncertainty of measurement has been explicitly taken into account to declare the compliance or non-compliance to the specification. The report must not be used by the client to claim product certification, approval, or endorsement by TAF or any government agencies

Table of Contents

Release Control Record	3
1 Certificate of Conformity	4
2 Summary of Test Results	5
2.1 Measurement Uncertainty	5
2.2 Test Site and Instruments	6
3 General Information	8
3.1 General Description of EUT	8
3.2 Configuration of System under Test	9
3.2.1 Description of Support Units	9
3.3 Test Mode Applicability and Tested Channel Detail	10
3.4 EUT Operating Conditions	12
3.5 General Description of Applied Standards	12
4 Test Types and Results	13
4.1 Output Power Measurement	13
4.1.1 Limits of Output Power Measurement	13
4.1.2 Test Procedures	13
4.1.3 Test Setup	14
4.1.4 Test Results	15
4.2 Frequency Stability Measurement	20
4.2.1 Limits of Frequency Stability Measurement	20
4.2.2 Test Procedure	20
4.2.3 Test Setup	20
4.2.4 Test Results	21
4.3 Occupied Bandwidth Measurement	28
4.3.1 Test Procedure	28
4.3.2 Test Setup	28
4.3.3 Test Result	29
4.4 Band Edge Measurement	32
4.4.1 Limits of Band Edge Measurement	32
4.4.2 Test Setup	32
4.4.3 Test Procedures	32
4.4.4 Test Results	33
4.5 Peak to Average Ratio	38
4.5.1 Limits of Peak to Average Ratio Measurement	38
4.5.2 Test Setup	38
4.5.3 Test Procedures	38
4.5.4 Test Results	39
4.6 Conducted Spurious Emissions	42
4.6.1 Limits of Conducted Spurious Emissions Measurement	42
4.6.2 Test Setup	42
4.6.3 Test Procedure	42
4.6.4 Test Results	43
4.7 Radiated Emission Measurement	50
4.7.1 Limits of Radiated Emission Measurement	50
4.7.2 Test Procedure	50
4.7.3 Deviation from Test Standard	50
4.7.4 Test Setup	50
4.7.5 Test Results	51
5 Pictures of Test Arrangements	75
Appendix – Information on the Testing Laboratories	76

Release Control Record

Issue No.	Description	Date Issued
RF170428C03-6	Original Release	Jun. 02, 2017

1 Certificate of Conformity

Product: ASUS Phone

Brand: ASUS

Test Model: ASUS_A006

Sample Status: Identical Prototype

Applicant: ASUSTek COMPUTER INC.

Test Date: May 22, 2017 ~ May 23, 2017

Standards: FCC Part 22, Subpart H

The above equipment has been tested by **Bureau Veritas Consumer Products Services (H.K.) Ltd., Taoyuan Branch**, and found compliance with the requirement of the above standards. The test record, data evaluation & Equipment Under Test (EUT) configurations represented herein are true and accurate accounts of the measurements of the sample's EMC characteristics under the conditions specified in this report.

Prepared by :  , **Date:** Jun. 02, 2017
Ivonne Wu / Supervisor

Approved by :  , **Date:** Jun. 02, 2017
David Huang / Project Engineer

2 Summary of Test Results

Applied Standard: FCC Part 22 & Part 2			
FCC Clause	Test Item	Result	Remarks
2.1046 22.913 (a)	Effective Radiated Power	Pass	Meet the requirement of limit.
---	Peak to Average Ratio	Pass	Meet the requirement of limit.
2.1055 22.355	Frequency Stability	Pass	Meet the requirement of limit.
2.1049	Occupied Bandwidth	Pass	Meet the requirement of limit.
22.917	Band Edge Measurements	Pass	Meet the requirement of limit.
2.1051 22.917	Conducted Spurious Emissions	Pass	Meet the requirement of limit.
2.1053 22.917	Radiated Spurious Emissions	Pass	Meet the requirement of limit. Minimum passing margin is -33.68 dB at 2472.60 MHz.

2.1 Measurement Uncertainty

Where relevant, the following measurement uncertainty levels have been estimated for tests performed on the EUT as specified in CISPR 16-4-2:

Measurement	Frequency	Expanded Uncertainty (k=2) (±)
Conducted Emissions at mains ports	150 kHz ~ 30 MHz	2.44 dB
Radiated Emissions up to 1 GHz	30 MHz ~ 200 MHz	2.0153 dB
	200 MHz ~ 1000 MHz	2.0224 dB
Radiated Emissions above 1 GHz	1 GHz ~ 18 GHz	1.0121 dB
	18 GHz ~ 40 GHz	1.1508 dB

2.2 Test Site and Instruments

Description & Manufacturer	Model No.	Serial No.	Date of Calibration	Due Date of Calibration
Test Receiver Agilent Technologies	N9038A	MY52260177	Jun. 21, 2016	Jun. 20, 2017
Spectrum Analyzer ROHDE & SCHWARZ	FSU43	101261	Dec. 13, 2016	Dec. 12, 2017
BILOG Antenna SCHWARZBECK	VULB9168	9168-472	Dec. 16, 2016	Dec. 15, 2017
HORN Antenna ETS-Lindgren	3117	00143293	Dec. 29, 2016	Dec. 28, 2017
Double Ridge Guide Horn Antenna EMCO	3115	5619	Dec. 27, 2016	Dec. 26, 2017
BILOG Antenna SCHWARZBECK	VULB 9168	9168-153	Dec. 13, 2016	Dec. 12, 2017
HORN Antenna SCHWARZBECK	BBHA 9170	9170-480	Dec. 14, 2016	Dec. 13, 2017
Fixed Attenuator Mini-Circuits	BW-N10W5+	NA	Jul. 08, 2016	Jul. 07, 2017
MXG Vector signal generator Agilent	N5182B	MY53050430	Oct. 19, 2016	Oct. 18, 2017
Preamplifier Agilent	310N	187226	Jun. 24, 2016	Jun. 23, 2017
Preamplifier Agilent	83017A	MY39501357	Jun. 24, 2016	Jun. 23, 2017
Power Meter Anritsu	ML2495A	1232002	Sep. 08, 2016	Sep. 07, 2017
Power Sensor Anritsu	MA2411B	1207325	Sep. 08, 2016	Sep. 07, 2017
RF signal cable ETS-LINDGREN	5D-FB	Cable-CH1-01(R FC-SMS-100-SM S-120+RFC-SMS -100-SMS-400)	Jun. 24, 2016	Jun. 23, 2017
RF signal cable ETS-LINDGREN	8D-FB	Cable-CH1-02(R FC-SMS-100-SM S-24)	Jun. 24, 2016	Jun. 23, 2017
Software BV ADT	E3 8.130425b	NA	NA	NA
Antenna Tower MF	NA	NA	NA	NA
Turn Table MF	NA	NA	NA	NA
Antenna Tower & Turn Table Controller MF	MF-7802	NA	NA	NA
Communications Tester-Wireless Agilent	8960 Series 10	MY53201073	Jul. 03, 2015	Jul. 02, 2017
Radio Communication Analyzer Anritsu	MT8820C	6201300640	Aug. 10, 2015	Aug. 09, 2017

- Note:
1. The calibration interval of the above test instruments is 12 / 24 months and the calibrations are traceable to NML/ROC and NIST/USA.
 2. The test was performed in HsinTien Chamber 1.
 3. The horn antenna and preamplifier (model: 83017A) are used only for the measurement of emission frequency above 1 GHz if tested.
 4. The FCC Site Registration No. is 149147.
 5. The IC Site Registration No. is IC7450I-1.

3 General Information

3.1 General Description of EUT

Product	ASUS Phone	
Brand	ASUS	
Test Model	ASUS_A006	
Status of EUT	Identical Prototype	
Power Supply Rating	5.0 Vdc (host equipment) 5.0 Vdc or 9 Vdc (adapter) 3.85 Vdc (Li-ion battery)	
Modulation Type	GSM/GPRS	GMSK
	EDGE	GMSK, 8PSK
	WCDMA	QPSK
	LTE	QPSK, 16QAM
Frequency Range	GSM/GPRS/EDGE	824.2 ~ 848.8 MHz
	WCDMA	826.4 ~ 846.6 MHz
	LTE 5 (Channel Bandwidth: 1.4 MHz)	824.7 ~ 848.3 MHz
	LTE 5 (Channel Bandwidth: 3 MHz)	825.5 ~ 847.5 MHz
	LTE 5 (Channel Bandwidth: 5 MHz)	826.5 ~ 846.5 MHz
	LTE 5 (Channel Bandwidth: 10 MHz)	829 ~ 844 MHz
Max. ERP Power	GSM/GPRS	515.47 mW
	EDGE	102.61 mW
	WCDMA	65.43 mW
	LTE 5 (Channel Bandwidth: 1.4 MHz)	50.70 mW
	LTE 5 (Channel Bandwidth: 3 MHz)	50.84 mW
	LTE 5 (Channel Bandwidth: 5 MHz)	51.52 mW
	LTE 5 (Channel Bandwidth: 10 MHz)	51.14 mW
Emission Designator	GSM/GPRS	247KGXW
	EDGE	248KG7W
	WCDMA	4M15F9W
	LTE 5 (Channel Bandwidth: 1.4 MHz)	1M09W7D
	LTE 5 (Channel Bandwidth: 3 MHz)	2M70G7D
	LTE 5 (Channel Bandwidth: 5 MHz)	4M49W7D
	LTE 5 (Channel Bandwidth: 10 MHz)	8M97W7D
Antenna Type	Fixed Internal Antenna	
Accessory Device	Refer to Note as below	
Data Cable Supplied	Refer to Note as below	

Note:

1. The EUT's accessories list refers to Ext. Pho.
2. The above EUT information is declared by manufacturer and for more detailed features description, please refer to the manufacturer's specifications or user's manual.

3.2 Configuration of System under Test

<Radiated Emission Test>

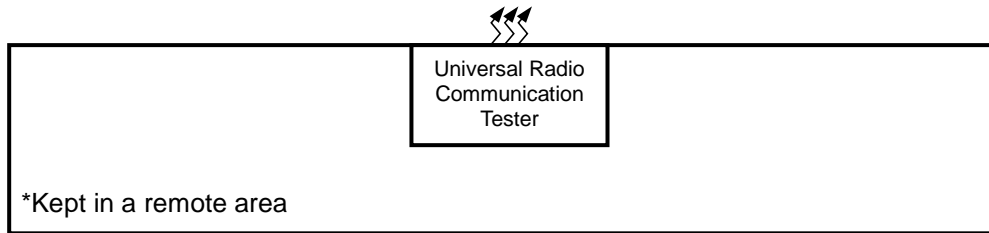
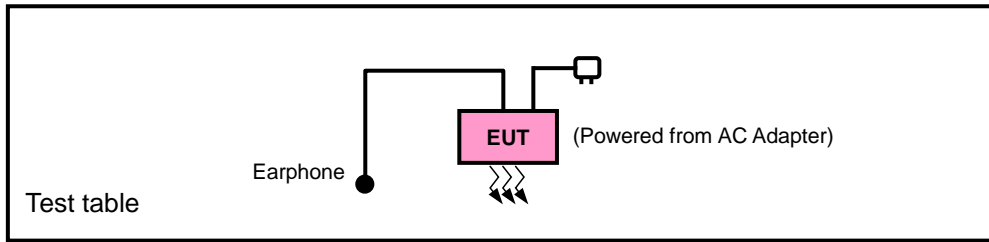

<E.R.P. Test>

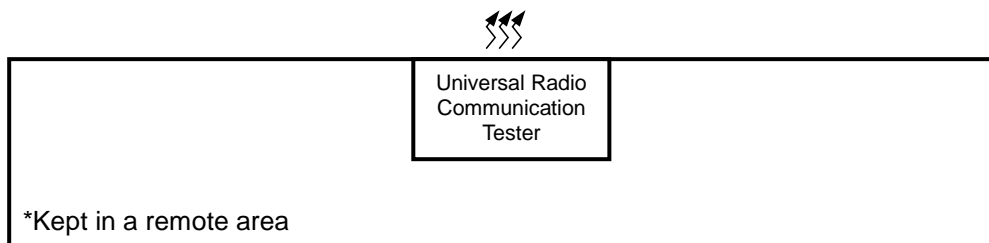
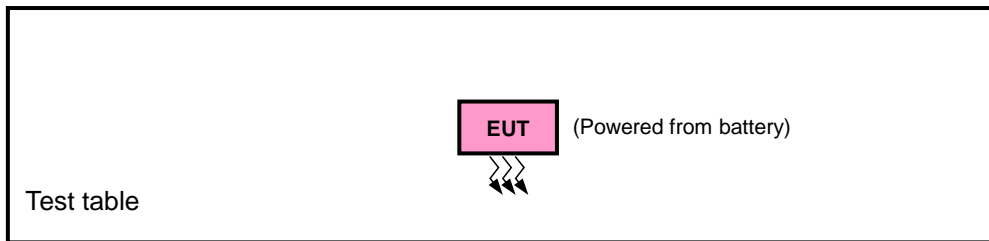

3.2.1 Description of Support Units

The EUT has been tested as an independent unit together with other necessary accessories or support units. The following support units or accessories were used to form a representative test configuration during the tests.

No.	Product	Brand	Model No.	Serial No.	FCC ID
1.	Earphone	FUNKEY	FK-130102	N/A	N/A

No.	Signal Cable Description Of The Above Support Units
1.	N/A

Note:

1. All power cords of the above support units are non-shielded (1.8m).

3.3 Test Mode Applicability and Tested Channel Detail

Pre-Scan has been conducted to determine the worst-case mode from all possible combinations between available modulations, data rates, XYZ axis, and antenna ports.

The worst case was found when positioned as the table below. Following channel(s) was (were) selected for the final test as listed below:

Band	ERP	Radiated Emission
GSM	Y-plane	X-axis
EDGE	Y-plane	X-axis
WCDMA	Y-plane	X-axis
LTE Band 5	Y-plane	Z-axis

GSM

EUT Configure Mode	Test Item	Available Channel	Tested Channel	Mode
-	ERP	128 to 251	128, 189, 251	GSM, EDGE
-	Frequency Stability	128 to 251	128, 251	GSM, EDGE
-	Occupied Bandwidth	128 to 251	128, 189, 251	GSM, EDGE
-	Band Edge	128 to 251	128, 251	GSM, EDGE
-	Peak to Average Ratio	128 to 251	128, 189, 251	GSM, EDGE
-	Condcudeted Emission	128 to 251	128, 189, 251	GSM, EDGE
-	Radiated Emission	128 to 251	128, 189, 251	GSM, EDGE

WCDMA

EUT Configure Mode	Test Item	Available Channel	Tested Channel	Mode
-	ERP	4132 to 4233	4132, 4182, 4233	WCDMA
-	Frequency Stability	4132 to 4233	4132, 4233	WCDMA
-	Occupied Bandwidth	4132 to 4233	4132, 4182, 4233	WCDMA
-	Band Edge	4132 to 4233	4132, 4233	WCDMA
-	Peak to Average Ratio	4132 to 4233	4132, 4182, 4233	WCDMA
-	Condcudeted Emission	4132 to 4233	4132, 4182, 4233	WCDMA
-	Radiated Emission	4132 to 4233	4132, 4182, 4233	WCDMA

LTE Band 5

EUT Configure Mode	Test Item	Available Channel	Tested Channel	Channel Bandwidth	Modulation	Mode		
-	ERP	20407 to 20643	20407, 20525, 20643	1.4 MHz	QPSK, 16QAM	1 RB / 2 RB Offset		
		20415 to 20635	20415, 20525, 20635	3 MHz	QPSK, 16QAM	1 RB / 7 RB Offset		
		20425 to 20625	20425, 20525, 20625	5 MHz	QPSK, 16QAM	1 RB / 12 RB Offset		
		20450 to 20600	20450, 20525, 20600	10 MHz	QPSK, 16QAM	1 RB / 24 RB Offset		
-	Frequency Stability	20407 to 20643	20407, 20643	1.4 MHz	QPSK	1 RB / 2 RB Offset		
		20415 to 20635	20415, 20635	3 MHz	QPSK	1 RB / 7 RB Offset		
		20425 to 20625	20425, 20625	5 MHz	QPSK	1 RB / 12 RB Offset		
		20450 to 20600	20450, 20600	10 MHz	QPSK	1 RB / 24 RB Offset		
-	Occupied Bandwidth	20407 to 20643	20407, 20525, 20643	1.4 MHz	QPSK, 16QAM	6 RB / 0 RB Offset		
		20415 to 20635	20415, 20525, 20635	3 MHz	QPSK, 16QAM	15 RB / 0 RB Offset		
		20425 to 20625	20425, 20525, 20625	5 MHz	QPSK, 16QAM	25 RB / 0 RB Offset		
		20450 to 20600	20450, 20525, 20600	10 MHz	QPSK, 16QAM	50 RB / 0 RB Offset		
-	Band Edge	20407 to 20643	20407	1.4MHz	QPSK	1 RB / 0 RB Offset 6 RB / 0 RB Offset		
			20643	1.4MHz	QPSK	1 RB / 5 RB Offset 6 RB / 0 RB Offset		
		20415 to 20635	20415	3 MHz	QPSK	1 RB / 0 RB Offset 15 RB / 0 RB Offset		
			20635	3 MHz	QPSK	1 RB / 14 RB Offset 15 RB / 0 RB Offset		
		20425 to 20625	20425	5 MHz	QPSK	1 RB / 0 RB Offset 25 RB / 0 RB Offset		
			20625	5 MHz	QPSK	1 RB / 24 RB Offset 25 RB / 0 RB Offset		
		20450 to 20600	20450	10 MHz	QPSK	1 RB / 0 RB Offset 50 RB / 0 RB Offset		
			20600	10 MHz	QPSK	1 RB / 49 RB Offset 50 RB / 0 RB Offset		
		-	Peak to Average Ratio	20407 to 20643	20407, 20525, 20643	1.4 MHz	QPSK, 16QAM	1 RB / 2 RB Offset
				20415 to 20635	20415, 20525, 20635	3 MHz	QPSK, 16QAM	1 RB / 7 RB Offset
				20425 to 20625	20425, 20525, 20625	5 MHz	QPSK, 16QAM	1 RB / 12 RB Offset
				20450 to 20600	20450, 20525, 20600	10 MHz	QPSK, 16QAM	1 RB / 24 RB Offset
-	Conducted Emission	20407 to 20643	20407, 20525, 20643	1.4 MHz	QPSK	1 RB / 2 RB Offset		
		20415 to 20635	20415, 20525, 20635	3 MHz	QPSK	1 RB / 7 RB Offset		
		20425 to 20625	20425, 20525, 20625	5 MHz	QPSK	1 RB / 12 RB Offset		
		20450 to 20600	20450, 20525, 20600	10 MHz	QPSK	1 RB / 24 RB Offset		
-	Radiated Emission	20450 to 20600	20450, 20525, 20600	10 MHz	QPSK	1 RB / 24 RB Offset		

Note: This device was tested under all bandwidths, RB configurations and modulations. The worst case was found in QPSK modulation.

Test Condition:

Test Item	Environmental Conditions	Input Power	Tested By
ERP	25 deg. C, 65 % RH	3.85 Vdc	Karl Lee & Harry Hsueh
Frequency Stability	25 deg. C, 65 % RH	3.85 Vdc	Carlos Chen
Occupied Bandwidth	25 deg. C, 65 % RH	3.85 Vdc	Carlos Chen
Band Edge	25 deg. C, 65 % RH	3.85 Vdc	Carlos Chen
Peak to Average Ratio	25 deg. C, 65 % RH	3.85 Vdc	Carlos Chen
Condcudeted Emission	25 deg. C, 65 % RH	3.85 Vdc	Carlos Chen
Radiated Emission	25 deg. C, 65 % RH	120 Vac, 60 Hz	Karl Lee & Harry Hsueh

3.4 EUT Operating Conditions

The EUT makes a call to the communication simulator. The communication simulator station system controlled a EUT to export maximum output power under transmission mode and specific channel frequency.

3.5 General Description of Applied Standards

The EUT is a RF Product. According to the specifications of the manufacturer, it must comply with the requirements of the following standards:

FCC 47 CFR Part 2

FCC 47 CFR Part 22

KDB 971168 D01 Power Meas License Digital Systems v02r02

ANSI/TIA/EIA-603-D 2010

Note: All test items have been performed and recorded as per the above standards.

4 Test Types and Results

4.1 Output Power Measurement

4.1.1 Limits of Output Power Measurement

Mobile / Portable station are limited to 7 watts e.r.p.

4.1.2 Test Procedures

EIRP / ERP Measurement:

- a. All measurements were done at low, middle and high operational frequency range. RBW and VBW is 1 MHz for GSM, GPRS & EDGE, and 5 MHz for WCDMA, and 10 MHz for LTE mode.
- b. Substitution method is used for E.I.R.P measurement. In the semi-anechoic chamber, EUT placed on the 0.8 m height of Turn Table, rotated the table around 360 degrees to search the maximum radiation power and receiver antenna shall be rotated vertical and horizontal polarization and moved height from 1 m to 4 m to find the maximum polar radiated power. The "Read Value" is the spectrum reading the maximum power value.
- c. The substitution horn antenna is substituted for EUT at the same position and signals generator export the CW signal to the substitution antenna via a tx cable. Rotated the Turn Table and moved receiving antenna to find the maximum radiation power. Adjust output power level of S.G to get a Value of spectrum reading equal to "Read Value" of step b. Record the power level of S.G.
- d. $EIRP = \text{Output power level of S.G} - \text{TX cable loss} + \text{Antenna gain of substitution horn}$. E.R.P power can be calculated from E.I.R.P power by subtracting the gain of dipole, $E.R.P \text{ power} = E.I.P.R \text{ power} - 2.15 \text{ dBi}$.

Conducted Power Measurement:

The EUT was set up for the maximum power with GSM, GPRS, EDGE, WCDMA, and LTE link data modulation and link up with simulator. Set the EUT to transmit under low, middle and high channel and record the power level shown on simulator.

4.1.3 Test Setup

EIRP / ERP Measurement:

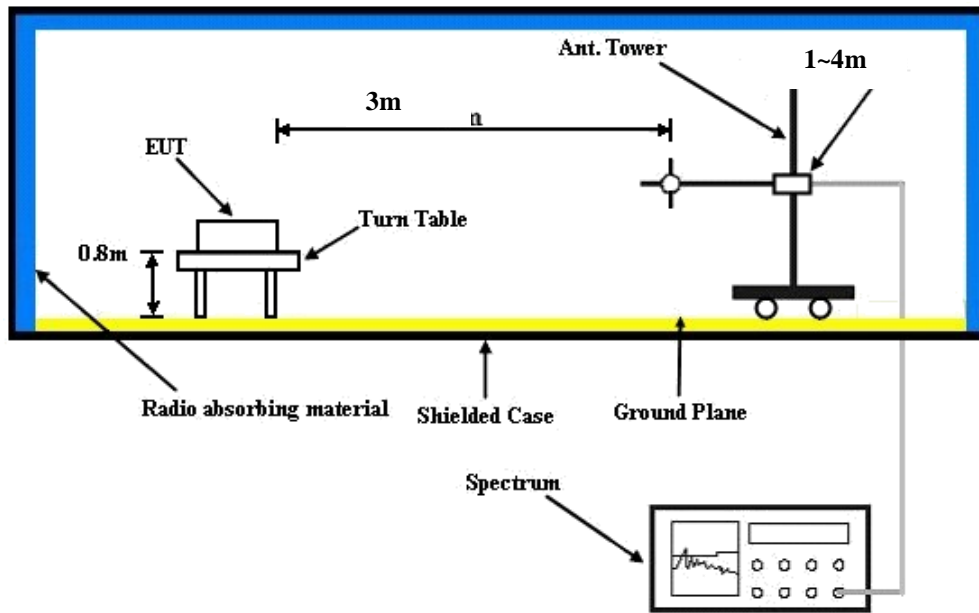

For the actual test configuration, please refer to the attached file (Test Setup Photo).

Conducted Power Measurement:

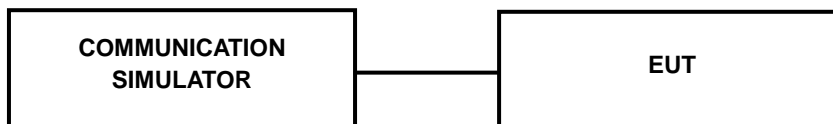

4.1.4 Test Results

Conducted Output Power (dBm)

Band	GSM850		
	128	189	251
Channel	824.2	836.4	848.8
Frequency (MHz)	824.2	836.4	848.8
GSM (GMSK, 1Tx-slot)	32.58	32.64	32.70
GPRS (GMSK, 1Tx-slot)	32.54	32.62	32.69
GPRS (GMSK, 2Tx-slot)	30.81	30.87	30.98
GPRS (GMSK, 3Tx-slot)	28.70	28.74	28.83
GPRS (GMSK, 4Tx-slot)	26.41	26.46	26.57
EDGE (8PSK, 1Tx-slot)	26.70	26.76	26.81
EDGE (8PSK, 2Tx-slot)	25.16	25.20	25.27
EDGE (8PSK, 3Tx-slot)	22.97	23.01	23.09
EDGE (8PSK, 4Tx-slot)	21.69	21.73	21.85

Band	WCDMA V		
	4132	4182	4233
Channel	826.4	836.4	846.6
Frequency (MHz)	826.4	836.4	846.6
RMC 12.2K	23.34	23.25	23.38
HSDPA Subtest-1	22.26	22.18	22.30
HSDPA Subtest-2	22.22	22.14	22.27
HSDPA Subtest-3	21.79	21.70	21.85
HSDPA Subtest-4	21.77	21.68	21.81
HSUPA Subtest-1	22.26	22.17	22.29
HSUPA Subtest-2	20.23	20.17	20.35
HSUPA Subtest-3	21.23	21.15	21.28
HSUPA Subtest-4	20.28	20.19	20.41
HSUPA Subtest-5	22.25	22.20	22.32

Band / BW	RB Size	RB Offset	QPSK			3GPP MPR (dB)	16QAM			3GPP MPR (dB)
			Low Ch 20407	Mid Ch 20525	High Ch 20643		Low Ch 20407	Mid Ch 20525	High Ch 20643	
			824.7 MHz	836.5 MHz	848.3 MHz		824.7 MHz	836.5 MHz	848.3 MHz	
5 / 1.4M	1	0	22.62	22.78	22.71	0	21.63	21.80	21.78	1
	1	2	22.67	22.85	22.83	0	21.70	21.91	21.85	1
	1	5	22.65	22.79	22.74	0	21.56	21.83	21.74	1
	3	0	22.47	22.56	22.49	0	21.41	21.58	21.47	1
	3	1	22.60	22.73	22.68	0	21.58	21.73	21.67	1
	3	3	22.52	22.71	22.64	0	21.49	21.70	21.65	1
	6	0	21.59	21.73	21.70	1	20.53	20.72	20.68	2

Band / BW	RB Size	RB Offset	QPSK			3GPP MPR (dB)	16QAM			3GPP MPR (dB)
			Low Ch 20415	Mid Ch 20525	High Ch 20635		Low Ch 20415	Mid Ch 20525	High Ch 20635	
			825.5 MHz	836.5 MHz	847.5 MHz		825.5 MHz	836.5 MHz	847.5 MHz	
5 / 3M	1	0	22.75	22.85	22.80	0	21.73	21.89	21.82	1
	1	7	22.82	22.91	22.88	0	21.86	21.96	21.92	1
	1	14	22.71	22.88	22.79	0	21.67	21.92	21.82	1
	8	0	21.70	21.81	21.75	1	20.64	20.77	20.68	2
	8	3	21.81	21.95	21.89	1	20.79	20.90	20.87	2
	8	7	21.77	21.91	21.86	1	20.75	20.88	20.85	2
	15	0	21.75	21.86	21.82	1	20.67	20.83	20.75	2

Band / BW	RB Size	RB Offset	QPSK			3GPP MPR (dB)	16QAM			3GPP MPR (dB)
			Low Ch 20425	Mid Ch 20525	High Ch 20625		Low Ch 20425	Mid Ch 20525	High Ch 20625	
			826.5 MHz	836.5 MHz	846.5 MHz		826.5 MHz	836.5 MHz	846.5 MHz	
5 / 5M	1	0	22.80	22.89	22.86	0	21.84	21.95	21.89	1
	1	12	22.87	22.96	22.91	0	21.90	22.01	21.97	1
	1	24	22.81	22.91	22.86	0	21.80	21.97	21.92	1
	12	0	21.86	21.93	21.88	1	20.81	20.94	20.84	2
	12	6	21.94	22.03	22.00	1	20.94	21.05	21.01	2
	12	13	21.91	22.02	21.97	1	20.87	21.04	21.00	2
	25	0	21.89	21.97	21.93	1	20.86	20.97	20.91	2

Band / BW	RB Size	RB Offset	QPSK			3GPP MPR (dB)	16QAM			3GPP MPR (dB)
			Low Ch 20450	Mid Ch 20525	High Ch 20600		Low Ch 20450	Mid Ch 20525	High Ch 20600	
			829.0 MHz	836.5 MHz	844.0 MHz		829.0 MHz	836.5 MHz	844.0 MHz	
5 / 10M	1	0	22.90	22.97	22.95	0	21.92	22.02	21.99	1
	1	24	22.96	23.01	22.99	0	21.95	22.06	22.04	1
	1	49	22.92	22.98	22.95	0	21.86	22.03	21.97	1
	25	0	21.99	22.06	22.04	1	20.96	21.04	21.00	2
	25	12	22.06	22.13	22.11	1	21.04	21.14	21.10	2
	25	25	22.04	22.12	22.09	1	21.02	21.11	21.08	2
	50	0	22.03	22.09	22.07	1	20.99	21.08	21.05	2

ERP Power (dBm)

GSM							
Plane	Channel	Frequency (MHz)	LVL (dBm)	Correction Factor (dB)	ERP (dBm)	ERP (mW)	Polarization (H/V)
Y	128	824.2	-2.01	31.208	27.05	506.76	H
	189	836.4	-2.11	31.3	27.04	505.82	
	251	848.8	-1.95	31.222	27.12	515.47	
	128	824.2	-5.22	31.504	24.13	259.06	V
	189	836.4	-4.86	31.117	24.11	257.45	
	251	848.8	-5.70	31.922	24.07	255.39	

EDGE							
Plane	Channel	Frequency (MHz)	LVL (dBm)	Correction Factor (dB)	ERP (dBm)	ERP (mW)	Polarization (H/V)
Y	128	824.2	-9.01	31.208	20.05	101.11	H
	189	836.4	-9.06	31.3	20.09	102.09	
	251	848.8	-8.96	31.222	20.11	102.61	
	128	824.2	-12.30	31.504	17.05	50.75	V
	189	836.4	-11.85	31.117	17.12	51.49	
	251	848.8	-12.70	31.922	17.07	50.96	

WCDMA							
Plane	Channel	Frequency (MHz)	LVL (dBm)	Correction Factor (dB)	ERP (dBm)	ERP (mW)	Polarization (H/V)
Y	4132	826.4	-10.90	31.208	18.16	65.43	H
	4182	836.4	-11.02	31.3	18.13	65.01	
	4233	846.6	-11.03	31.222	18.04	63.71	
	4132	826.4	-14.26	31.504	15.09	32.31	V
	4182	836.4	-13.88	31.117	15.09	32.26	
	4233	846.6	-14.69	31.922	15.08	32.23	

LTE Band 5							
Channel Bandwidth: 1.4 MHz / QPSK							
Plane	Channel	Frequency (MHz)	LVL (dBm)	Correction Factor (dB)	ERP (dBm)	ERP (mW)	Polarization (H/V)
Y	20407	824.7	-12.06	31.208	17.00	50.10	H
	20525	836.5	-12.10	31.3	17.05	50.70	
	20643	848.3	-12.06	31.222	17.01	50.26	
	20407	824.7	-15.29	31.504	14.06	25.49	V
	20525	836.5	-14.93	31.117	14.04	25.33	
	20643	848.3	-15.74	31.922	14.03	25.30	
Channel Bandwidth: 1.4 MHz / 16QAM							
Y	20407	824.7	-13.05	31.208	16.01	39.88	H
	20525	836.5	-13.11	31.3	16.04	40.18	
	20643	848.3	-13.06	31.222	16.01	39.92	
	20407	824.7	-16.24	31.504	13.11	20.48	V
	20525	836.5	-15.94	31.117	13.03	20.08	
	20643	848.3	-16.62	31.922	13.15	20.66	

LTE Band 5							
Channel Bandwidth: 3 MHz / QPSK							
Plane	Channel	Frequency (MHz)	LVL (dBm)	Correction Factor (dB)	ERP (dBm)	ERP (mW)	Polarization (H/V)
Y	20415	825.5	-12.02	31.208	17.04	50.56	H
	20525	836.5	-12.12	31.3	17.03	50.47	
	20635	847.5	-12.01	31.222	17.06	50.84	
	20415	825.5	-15.24	31.504	14.11	25.79	V
	20525	836.5	-14.92	31.117	14.05	25.39	
	20635	847.5	-15.70	31.922	14.07	25.54	
Channel Bandwidth: 3 MHz / 16QAM							
Y	20415	825.5	-12.95	31.208	16.11	40.81	H
	20525	836.5	-13.13	31.3	16.03	40.04	
	20635	847.5	-12.98	31.222	16.09	40.66	
	20415	825.5	-16.26	31.504	13.09	20.39	V
	20525	836.5	-15.93	31.117	13.04	20.12	
	20635	847.5	-16.74	31.922	13.03	20.10	

LTE Band 5							
Channel Bandwidth: 5 MHz / QPSK							
Plane	Channel	Frequency (MHz)	LVL (dBm)	Correction Factor (dB)	ERP (dBm)	ERP (mW)	Polarization (H/V)
Y	20425	826.5	-12.03	31.208	17.03	50.44	H
	20525	836.5	-12.03	31.3	17.12	51.52	
	20625	846.5	-11.98	31.222	17.09	51.19	
	20425	826.5	-15.22	31.504	14.13	25.91	V
	20525	836.5	-14.96	31.117	14.01	25.16	
	20625	846.5	-15.71	31.922	14.06	25.48	
Channel Bandwidth: 5 MHz / 16QAM							
Y	20425	826.5	-13.02	31.208	16.04	40.16	H
	20525	836.5	-13.11	31.3	16.04	40.18	
	20625	846.5	-12.96	31.222	16.11	40.85	
	20425	826.5	-16.27	31.504	13.08	20.34	V
	20525	836.5	-15.92	31.117	13.05	20.17	
	20625	846.5	-16.68	31.922	13.09	20.38	

LTE Band 5							
Channel Bandwidth: 10 MHz / QPSK							
Plane	Channel	Frequency (MHz)	LVL (dBm)	Correction Factor (dB)	ERP (dBm)	ERP (mW)	Polarization (H/V)
Y	20450	829.0	-11.97	31.208	17.09	51.14	H
	20525	836.5	-12.12	31.3	17.03	50.47	
	20600	844.0	-12.02	31.222	17.05	50.72	
	20450	829.0	-15.26	31.504	14.09	25.67	V
	20525	836.5	-14.96	31.117	14.01	25.16	
	20600	844.0	-15.73	31.922	14.04	25.36	
Channel Bandwidth: 10 MHz / 16QAM							
Y	20450	829.0	-12.96	31.208	16.10	40.72	H
	20525	836.5	-13.12	31.3	16.03	40.09	
	20600	844.0	-13.02	31.222	16.05	40.29	
	20450	829.0	-16.21	31.504	13.14	20.63	V
	20525	836.5	-15.93	31.117	13.04	20.12	
	20600	844.0	-16.71	31.922	13.06	20.24	

4.2 Frequency Stability Measurement

4.2.1 Limits of Frequency Stability Measurement

1.5 ppm is for base and fixed station. 2.5 ppm is for mobile station.

4.2.2 Test Procedure

- Device is placed at the oven room. The oven room could control the temperatures and humidity. Power warm up is at least 15 min and power applied should perform before recording frequency error.
- EUT is connected the external power supply to control the DC input power. The test voltage range is from minimum to maximum working voltage. Each step shall be record the frequency error rate.
- The temperature range step is 10 degrees in this test items. All temperature levels shall be hold the ± 0.5 °C during the measurement testing. The each temperature step shall be at least 0.5 hours, consider the EUT could be test under the stability condition.

NOTE: The frequency error was recorded frequency error from the communication simulator.

4.2.3 Test Setup

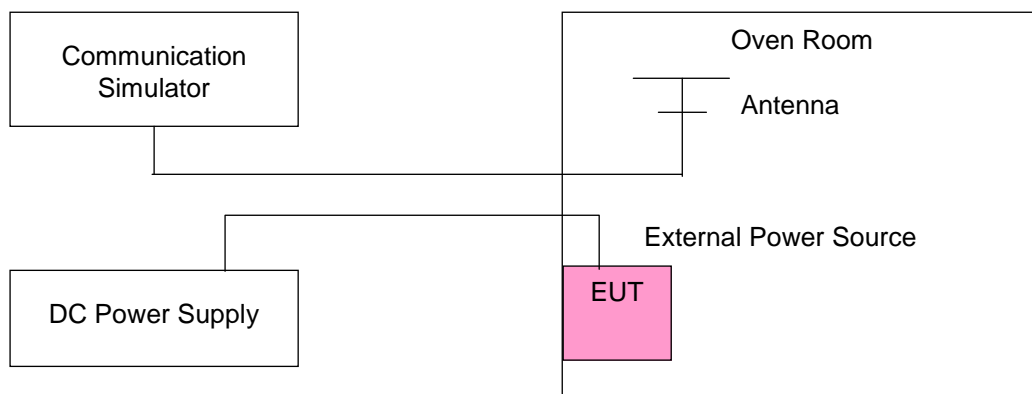

4.2.4 Test Results

Frequency Error vs. Voltage

Voltage (Volts)	GSM				Limit (ppm)
	Low Channel		High Channel		
	Frequency (MHz)	Frequency Error (ppm)	Frequency (MHz)	Frequency Error (ppm)	
3.85	824.200003	0.004	1909.800003	0.002	2.5
3.7	824.200003	0.003	1909.800001	0.001	2.5
4.30	824.200001	0.002	1909.800001	0.001	2.5

Note: The applicant defined the normal working voltage of the battery is from 3.7 Vdc to 4.3 Vdc.

Frequency Error vs. Temperature

Temp. (°C)	GSM				Limit (ppm)
	Low Channel		High Channel		
	Frequency (MHz)	Frequency Error (ppm)	Frequency (MHz)	Frequency Error (ppm)	
-30	824.200001	0.001	1909.800002	0.001	2.5
-20	824.200002	0.002	1909.800003	0.002	2.5
-10	824.200002	0.002	1909.800002	0.001	2.5
0	824.200002	0.002	1909.800002	0.001	2.5
10	824.199999	-0.001	1909.799997	-0.002	2.5
20	824.199998	-0.003	1909.799998	-0.001	2.5
30	824.199997	-0.004	1909.799998	-0.001	2.5
40	824.199999	-0.002	1909.799999	-0.001	2.5
50	824.199997	-0.004	1909.799997	-0.001	2.5

Frequency Error vs. Voltage

Voltage (Volts)	EDGE				Limit (ppm)
	Low Channel		High Channel		
	Frequency (MHz)	Frequency Error (ppm)	Frequency (MHz)	Frequency Error (ppm)	
3.85	824.200004	0.005	1909.800002	0.001	2.5
3.7	824.200003	0.004	1909.800002	0.001	2.5
4.30	824.200001	0.001	1909.800003	0.002	2.5

Note: The applicant defined the normal working voltage of the battery is from 3.7 Vdc to 4.3 Vdc.

Frequency Error vs. Temperature

Temp. (°C)	EDGE				Limit (ppm)
	Low Channel		High Channel		
	Frequency (MHz)	Frequency Error (ppm)	Frequency (MHz)	Frequency Error (ppm)	
-30	824.200002	0.003	1909.800004	0.002	2.5
-20	824.200001	0.001	1909.800003	0.002	2.5
-10	824.200004	0.005	1909.800002	0.001	2.5
0	824.200001	0.001	1909.800002	0.001	2.5
10	824.199998	-0.002	1909.799998	-0.001	2.5
20	824.199997	-0.004	1909.799996	-0.002	2.5
30	824.199998	-0.003	1909.799996	-0.002	2.5
40	824.199997	-0.003	1909.799998	-0.001	2.5
50	824.199996	-0.004	1909.799996	-0.002	2.5

Frequency Error vs. Voltage

Voltage (Volts)	WCDMA				Limit (ppm)
	Low Channel		High Channel		
	Frequency (MHz)	Frequency Error (ppm)	Frequency (MHz)	Frequency Error (ppm)	
3.85	826.400003	0.004	846.600002	0.002	2.5
3.7	826.400002	0.002	846.600004	0.005	2.5
4.30	826.400003	0.003	846.600001	0.001	2.5

Note: The applicant defined the normal working voltage of the battery is from 3.7 Vdc to 4.3 Vdc.

Frequency Error vs. Temperature

Temp. (°C)	WCDMA				Limit (ppm)
	Low Channel		High Channel		
	Frequency (MHz)	Frequency Error (ppm)	Frequency (MHz)	Frequency Error (ppm)	
-30	826.400003	0.004	846.600004	0.005	2.5
-20	826.400001	0.001	846.600002	0.002	2.5
-10	826.400003	0.003	846.600002	0.002	2.5
0	826.400003	0.004	846.600001	0.001	2.5
10	826.399996	-0.004	846.599997	-0.004	2.5
20	826.399997	-0.003	846.599996	-0.004	2.5
30	826.399998	-0.003	846.599998	-0.003	2.5
40	826.399997	-0.003	846.599998	-0.002	2.5
50	826.399998	-0.002	846.599998	-0.003	2.5

Frequency Error vs. Voltage

Voltage (Volts)	LTE Band 5				Limit (ppm)
	Channel Bandwidth: 1.4 MHz				
	Low Channel		High Channel		
	Frequency (MHz)	Frequency Error (ppm)	Frequency (MHz)	Frequency Error (ppm)	
3.85	824.700003	0.003	848.300002	0.003	2.5
3.7	824.700001	0.001	848.300003	0.004	2.5
4.30	824.700004	0.004	848.300001	0.002	2.5

Note: The applicant defined the normal working voltage of the battery is from 3.7 Vdc to 4.3 Vdc.

Frequency Error vs. Temperature

Temp. (°C)	LTE Band 5				Limit (ppm)
	Channel Bandwidth: 1.4 MHz				
	Low Channel		High Channel		
	Frequency (MHz)	Frequency Error (ppm)	Frequency (MHz)	Frequency Error (ppm)	
-30	824.700004	0.005	848.300004	0.004	2.5
-20	824.700002	0.002	848.300003	0.003	2.5
-10	824.700002	0.003	848.300003	0.004	2.5
0	824.700003	0.003	848.300002	0.002	2.5
10	824.699999	-0.002	848.299997	-0.004	2.5
20	824.699997	-0.004	848.299998	-0.002	2.5
30	824.699999	-0.001	848.299996	-0.004	2.5
40	824.699998	-0.002	848.299998	-0.003	2.5
50	824.699998	-0.003	848.299998	-0.003	2.5

Frequency Error vs. Voltage

Voltage (Volts)	LTE Band 5				Limit (ppm)
	Channel Bandwidth: 3 MHz				
	Low Channel		High Channel		
	Frequency (MHz)	Frequency Error (ppm)	Frequency (MHz)	Frequency Error (ppm)	
3.85	825.500002	0.002	847.500002	0.003	2.5
3.7	825.500003	0.003	847.500003	0.003	2.5
4.30	825.500004	0.005	847.500001	0.001	2.5

Note: The applicant defined the normal working voltage of the battery is from 3.7 Vdc to 4.3 Vdc.

Frequency Error vs. Temperature

Temp. (°C)	LTE Band 5				Limit (ppm)
	Channel Bandwidth: 3 MHz				
	Low Channel		High Channel		
	Frequency (MHz)	Frequency Error (ppm)	Frequency (MHz)	Frequency Error (ppm)	
-30	825.500001	0.002	847.500002	0.002	2.5
-20	825.500002	0.002	847.500002	0.003	2.5
-10	825.500002	0.003	847.500003	0.003	2.5
0	825.500002	0.002	847.500003	0.004	2.5
10	825.499998	-0.003	847.499997	-0.004	2.5
20	825.499997	-0.003	847.499996	-0.004	2.5
30	825.499996	-0.005	847.499997	-0.004	2.5
40	825.499998	-0.002	847.499998	-0.003	2.5
50	825.499996	-0.005	847.499997	-0.004	2.5

Frequency Error vs. Voltage

Voltage (Volts)	LTE Band 5				Limit (ppm)
	Channel Bandwidth: 5 MHz				
	Low Channel		High Channel		
	Frequency (MHz)	Frequency Error (ppm)	Frequency (MHz)	Frequency Error (ppm)	
3.85	826.500004	0.005	846.500002	0.002	2.5
3.7	826.500003	0.003	846.500003	0.004	2.5
4.30	826.500003	0.003	846.500003	0.004	2.5

Note: The applicant defined the normal working voltage of the battery is from 3.6 Vdc to 4.35 Vdc.

Frequency Error vs. Temperature

Temp. (°C)	LTE Band 5				Limit (ppm)
	Channel Bandwidth: 5 MHz				
	Low Channel		High Channel		
	Frequency (MHz)	Frequency Error (ppm)	Frequency (MHz)	Frequency Error (ppm)	
-30	826.500003	0.003	846.500003	0.004	2.5
-20	826.500001	0.002	846.500004	0.004	2.5
-10	826.500001	0.001	846.500003	0.003	2.5
0	826.500003	0.004	846.500001	0.001	2.5
10	826.499996	-0.004	846.499998	-0.002	2.5
20	826.499999	-0.001	846.499998	-0.002	2.5
30	826.499999	-0.002	846.499999	-0.002	2.5
40	826.499997	-0.003	846.499997	-0.003	2.5
50	826.499996	-0.004	846.499999	-0.001	2.5

Frequency Error vs. Voltage

Voltage (Volts)	LTE Band 5				Limit (ppm)
	Channel Bandwidth: 10 MHz				
	Low Channel		High Channel		
	Frequency (MHz)	Frequency Error (ppm)	Frequency (MHz)	Frequency Error (ppm)	
3.85	829.000003	0.003	844.000002	0.002	2.5
3.7	829.000002	0.003	844.000004	0.005	2.5
4.30	829.000002	0.002	844.000002	0.002	2.5

Note: The applicant defined the normal working voltage of the battery is from 3.7 Vdc to 4.3 Vdc.

Frequency Error vs. Temperature

Temp. (°C)	LTE Band 5				Limit (ppm)
	Channel Bandwidth: 10 MHz				
	Low Channel		High Channel		
	Frequency (MHz)	Frequency Error (ppm)	Frequency (MHz)	Frequency Error (ppm)	
-30	829.000002	0.003	844.000001	0.002	2.5
-20	829.000001	0.002	844.000001	0.002	2.5
-10	829.000004	0.004	844.000003	0.003	2.5
0	829.000001	0.002	844.000001	0.002	2.5
10	828.999998	-0.003	843.999997	-0.004	2.5
20	828.999999	-0.002	843.999998	-0.003	2.5
30	828.999997	-0.004	843.999997	-0.003	2.5
40	828.999996	-0.005	843.999996	-0.005	2.5
50	828.999997	-0.004	843.999996	-0.005	2.5

4.3 Occupied Bandwidth Measurement

4.3.1 Test Procedure

The EUT makes a call to the communication simulator. All measurements were done at low, middle and high operational frequency range. The communication simulator station system controlled a EUT to export maximum output power under transmission mode and specific channel frequency. Use OBW measurement function of Spectrum analyzer to measure 99 % occupied bandwidth.

4.3.2 Test Setup

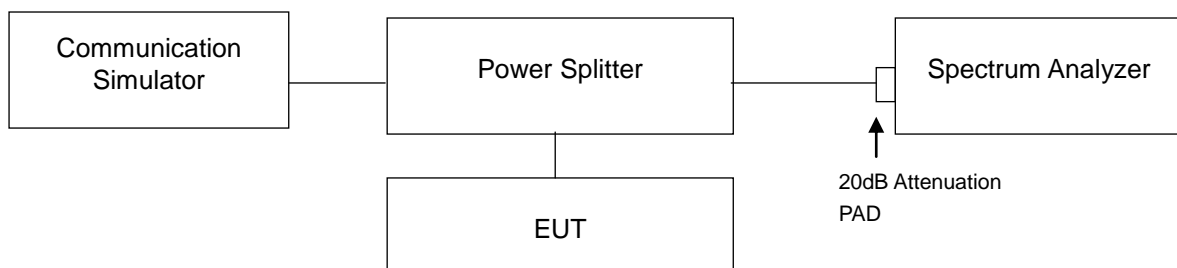

4.3.3 Test Result

Channel	Frequency (MHz)	99 % Occupied Bandwidth (kHz)		Channel	Frequency (MHz)	99 % Occupied Bandwidth (MHz)
		GSM	EDGE			WCDMA
128	824.2	245.84	247.64	4132	826.4	4.1463
189	836.4	246.79	245.78	4182	836.4	4.1523
251	848.8	244.75	247.75	4233	846.6	4.1546

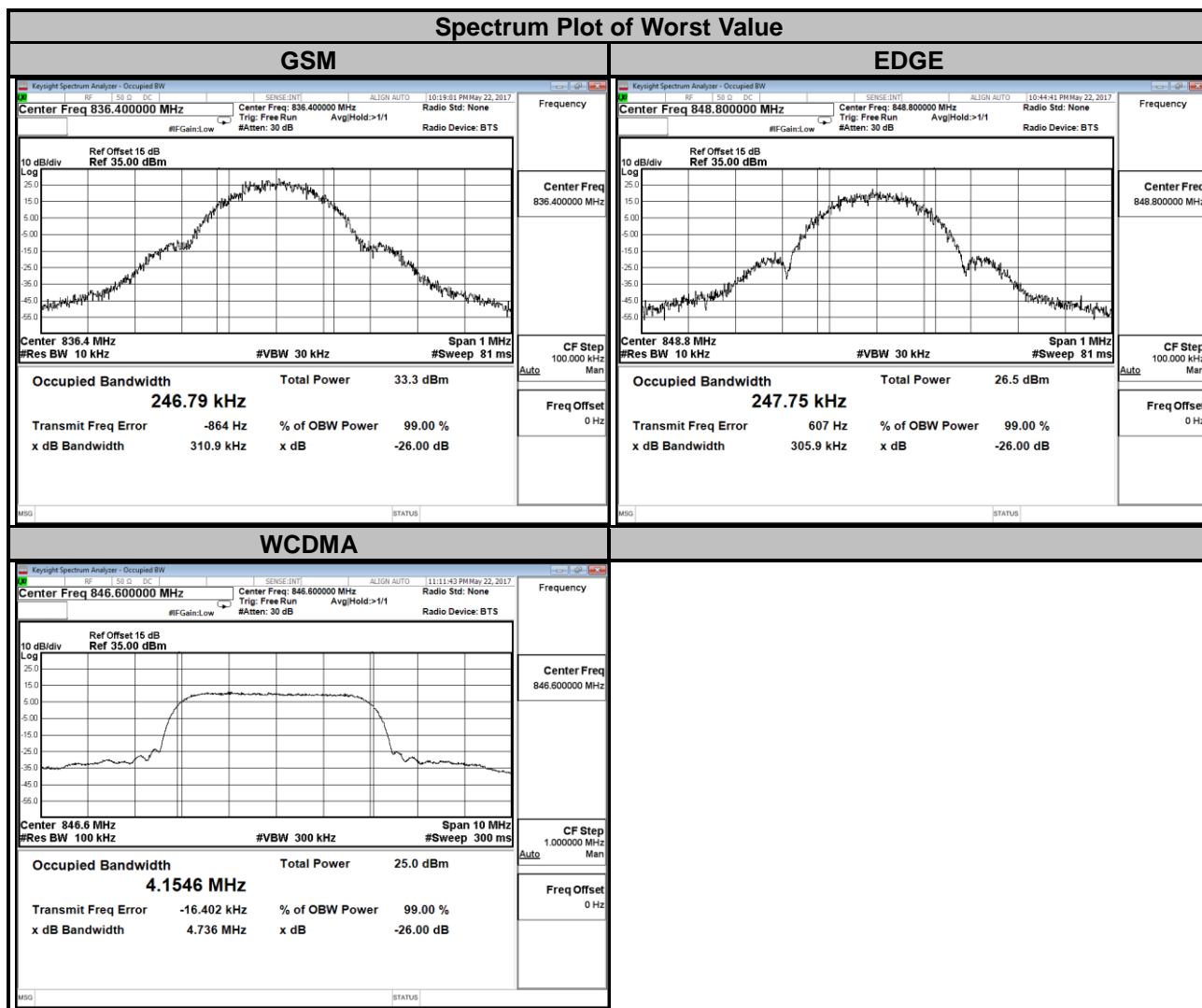

LTE Band 5							
Channel Bandwidth: 1.4 MHz				Channel Bandwidth: 3 MHz			
Channel	Frequency (MHz)	99 % Occupied Bandwidth (MHz)		Channel	Frequency (MHz)	99 % Occupied Bandwidth (MHz)	
		QPSK	16QAM			QPSK	16QAM
20407	824.7	1.0874	1.0870	20415	825.5	2.7019	2.6959
20525	836.5	1.0855	1.0874	20525	836.5	2.7011	2.6968
20643	848.3	1.0870	1.0892	20635	847.5	2.7019	2.6975

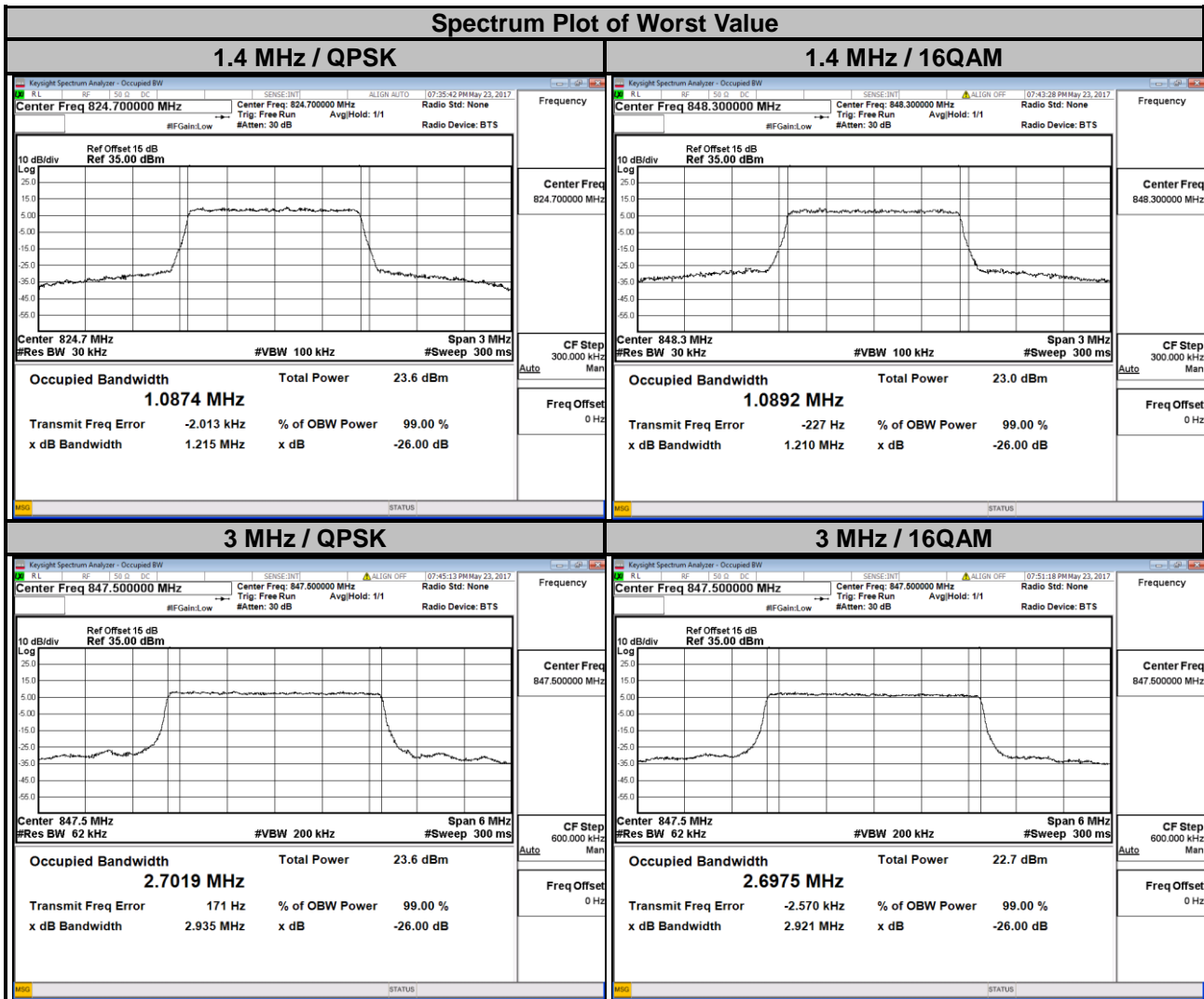

LTE Band 5

Channel Bandwidth: 5 MHz				Channel Bandwidth: 10 MHz			
Channel	Frequency (MHz)	99 % Occupied Bandwidth (MHz)		Channel	Frequency (MHz)	99 % Occupied Bandwidth (MHz)	
		QPSK	16QAM			QPSK	16QAM
20425	826.5	4.4898	4.4916	20450	829.0	8.9664	8.9687
20525	836.5	4.4892	4.4898	20525	836.5	8.9673	8.9699
20625	846.5	4.4892	4.4869	20600	844.0	8.9525	8.9567

Spectrum Plot of Worst Value

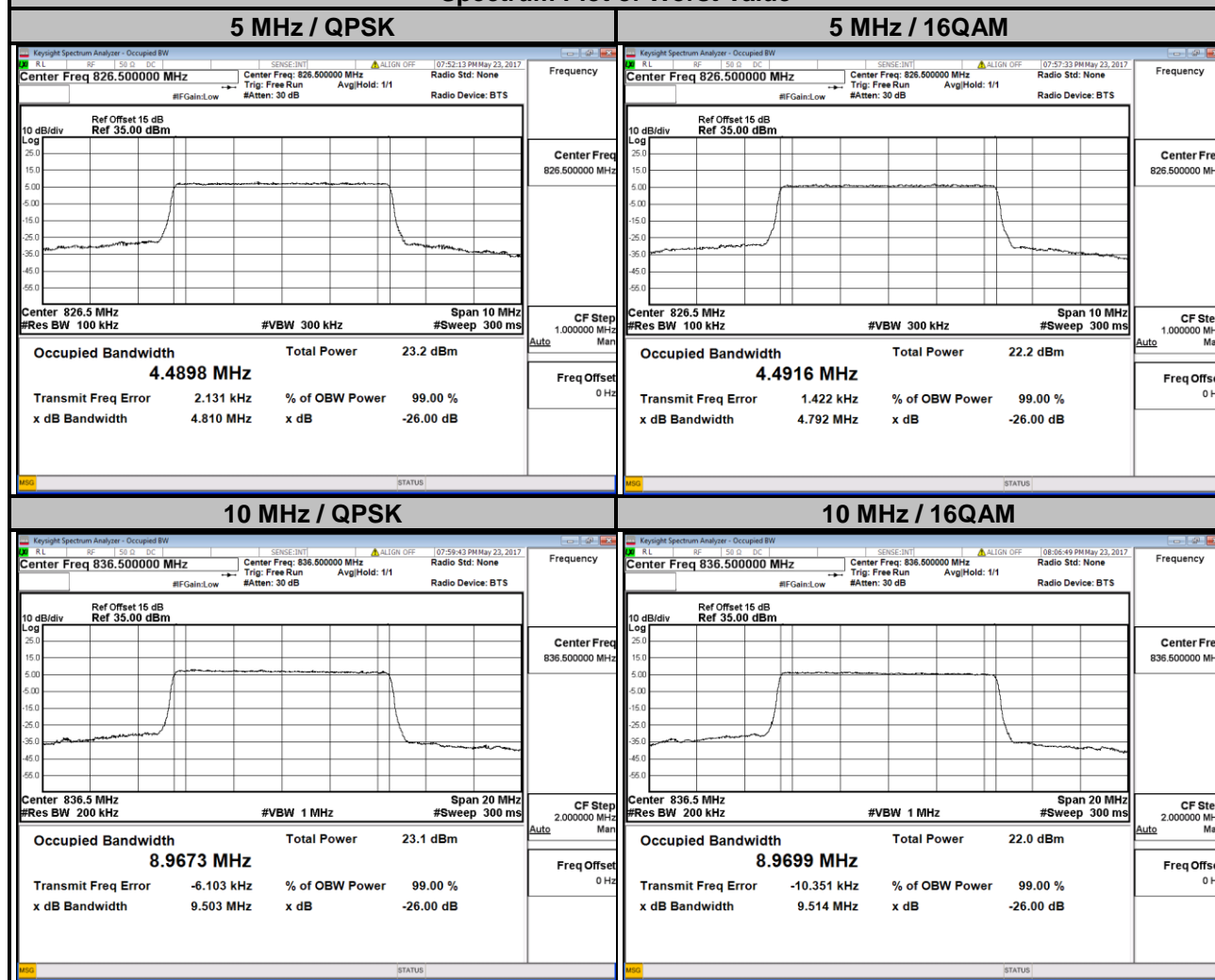

4.4 Band Edge Measurement

4.4.1 Limits of Band Edge Measurement

Power of any emission outside of the authorized operating frequency ranges must be attenuated below the transmitting power (P) by a factor of at least $43 + 10 \log(P)$ dB. In the 1 MHz bands immediately outside and adjacent to the frequency block a resolution bandwidth of at least one percent of the emission bandwidth of the fundamental emission of the transmitter may be employed.

4.4.2 Test Setup

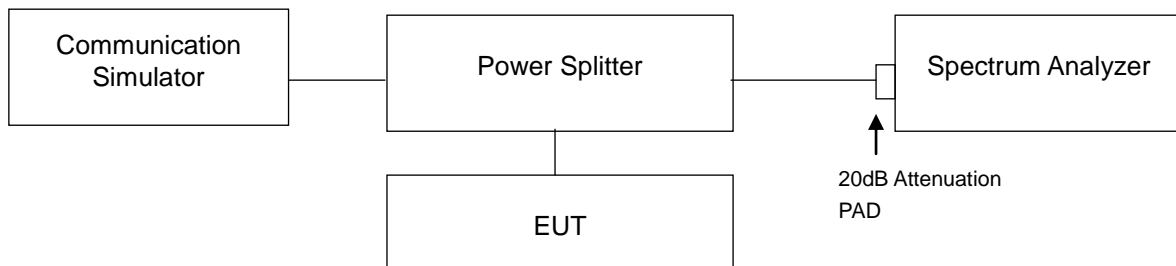

4.4.3 Test Procedures

- a. All measurements were done at low and high operational frequency range.
- b. The center frequency of spectrum is the band edge frequency and span is 1 MHz. RB of the spectrum is 10 kHz and VB of the spectrum is 30 kHz (GSM/GPRS/EDGE).
- c. The center frequency of spectrum is the band edge frequency and span is 5 MHz. RB of the spectrum is 100 kHz and VB of the spectrum is 300 kHz (WCDMA).
- d. The center frequency of spectrum is the band edge frequency and span is 1 MHz. RB of the spectrum is 13 kHz and VB of the spectrum is 51 kHz (LTE Bandwidth 1.4 MHz).
- e. The center frequency of spectrum is the band edge frequency and span is 1 MHz. RB of the spectrum is 30 kHz and VB of the spectrum is 100 kHz (LTE Bandwidth 3 MHz).
- f. The center frequency of spectrum is the band edge frequency and span is 1 MHz. RB of the spectrum is 100 kHz and VB of the spectrum is 300 kHz (LTE Bandwidth 5 MHz/10 MHz).
- g. Record the max trace plot into the test report.

4.4.4 Test Results

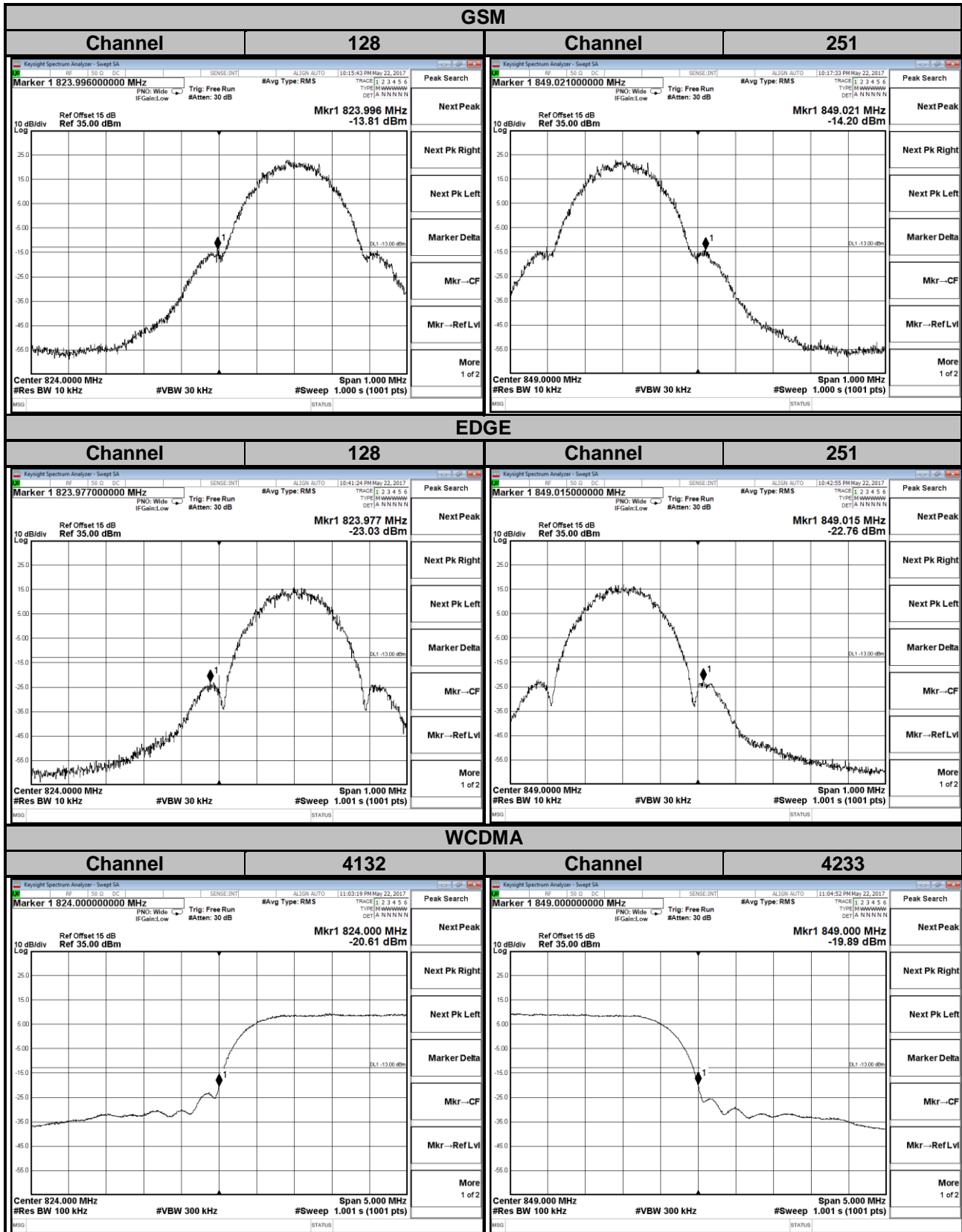

LTE Band 5
Channel Bandwidth: 1.4 MHz

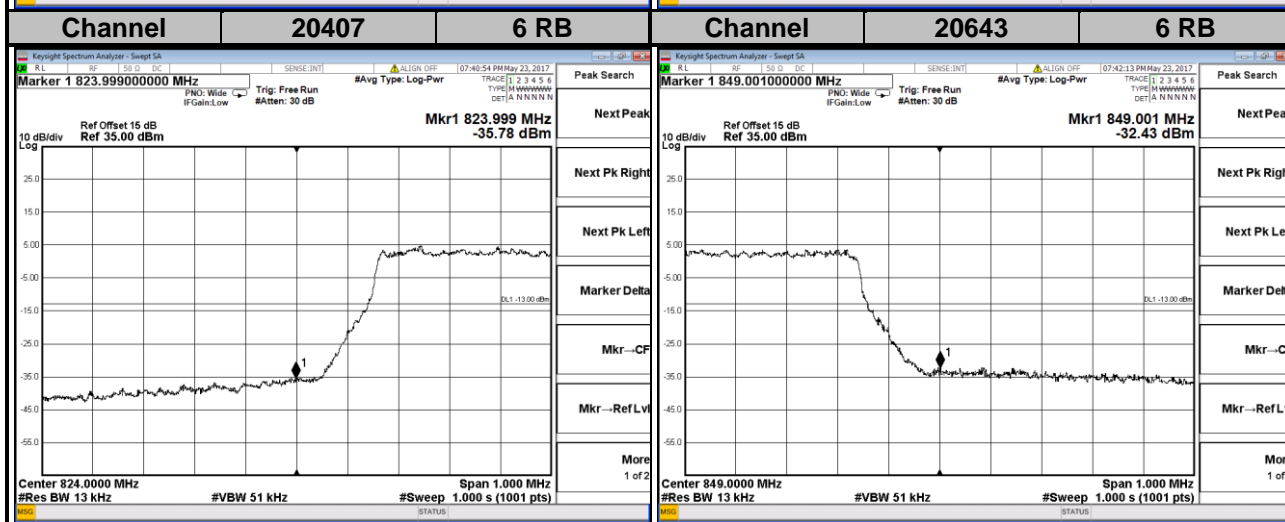
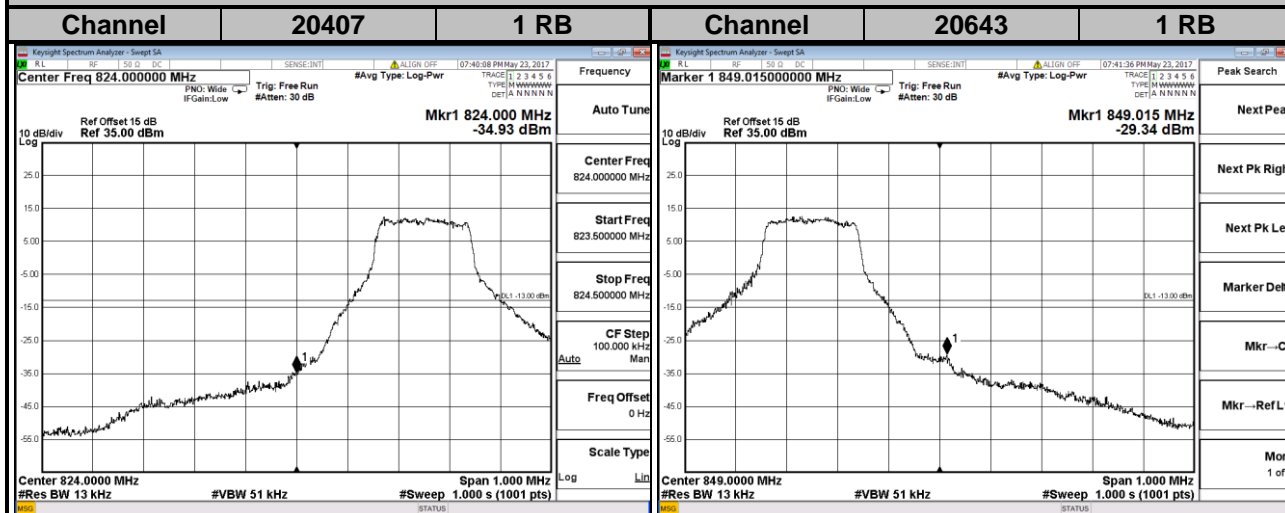

LTE Band 5
Channel Bandwidth: 3 MHz

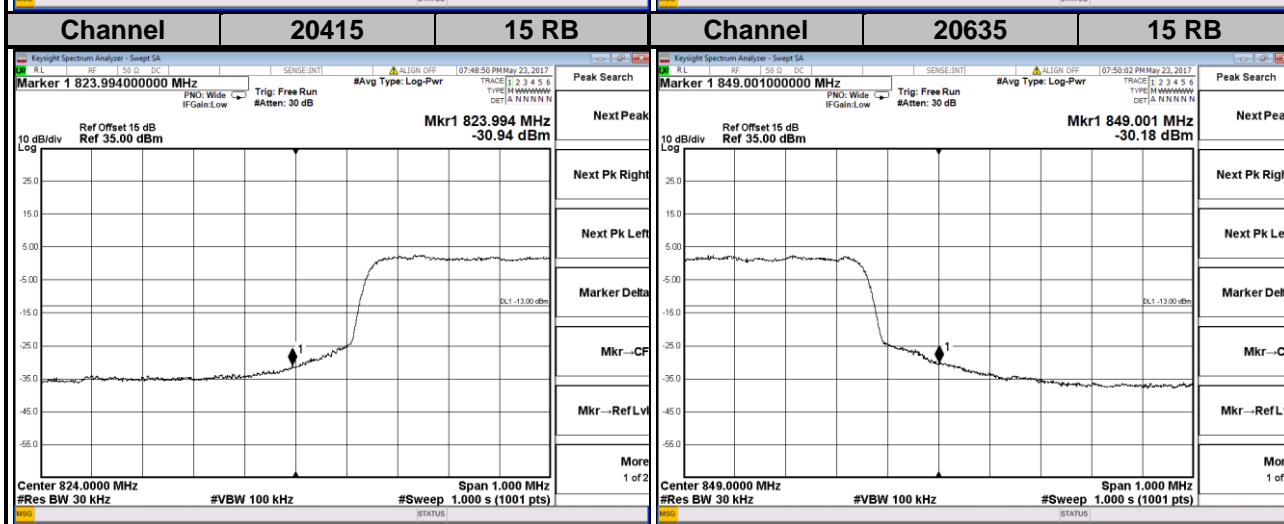
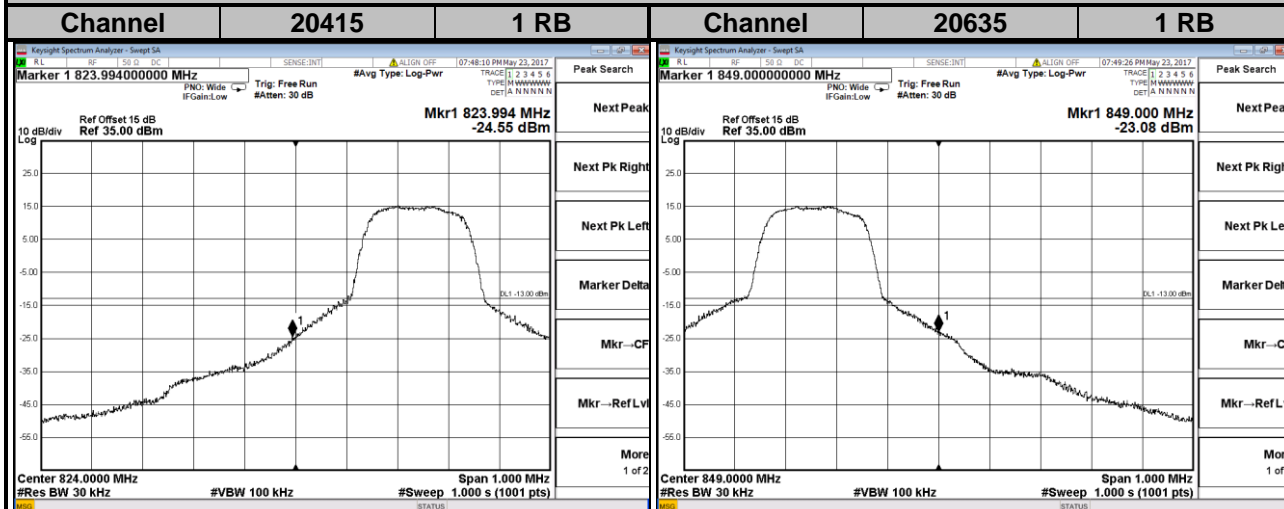

LTE Band 5
Channel Bandwidth: 5 MHz

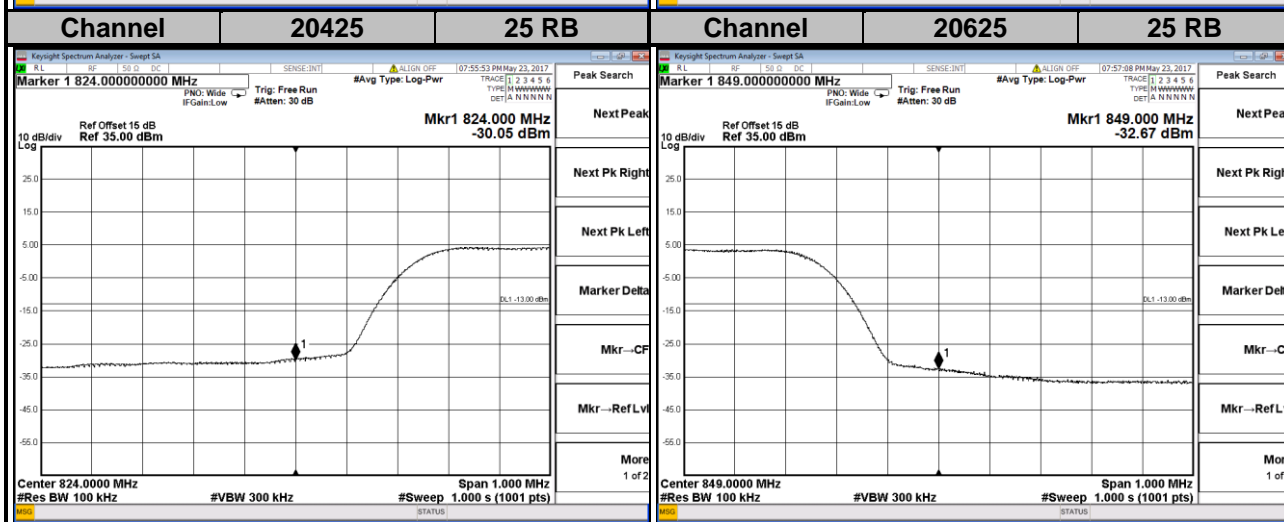
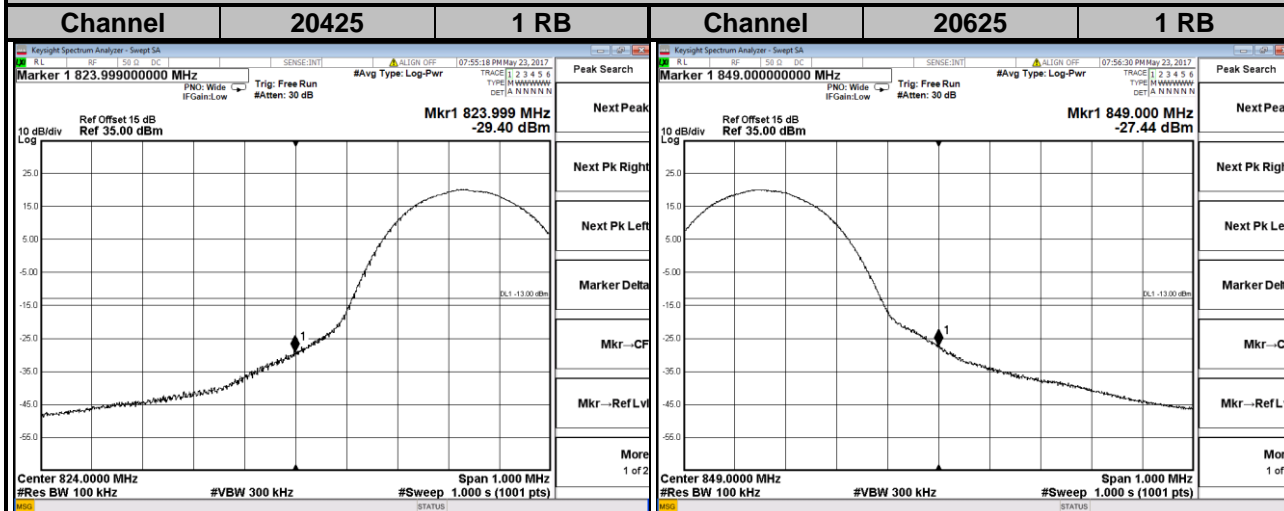

LTE Band 5
Channel Bandwidth: 10 MHz

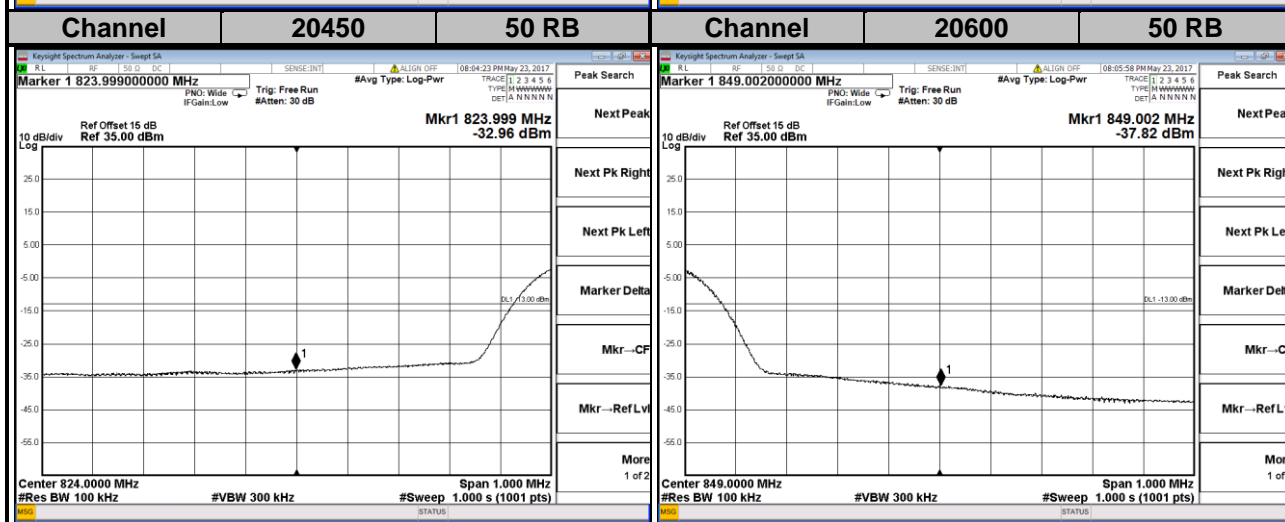
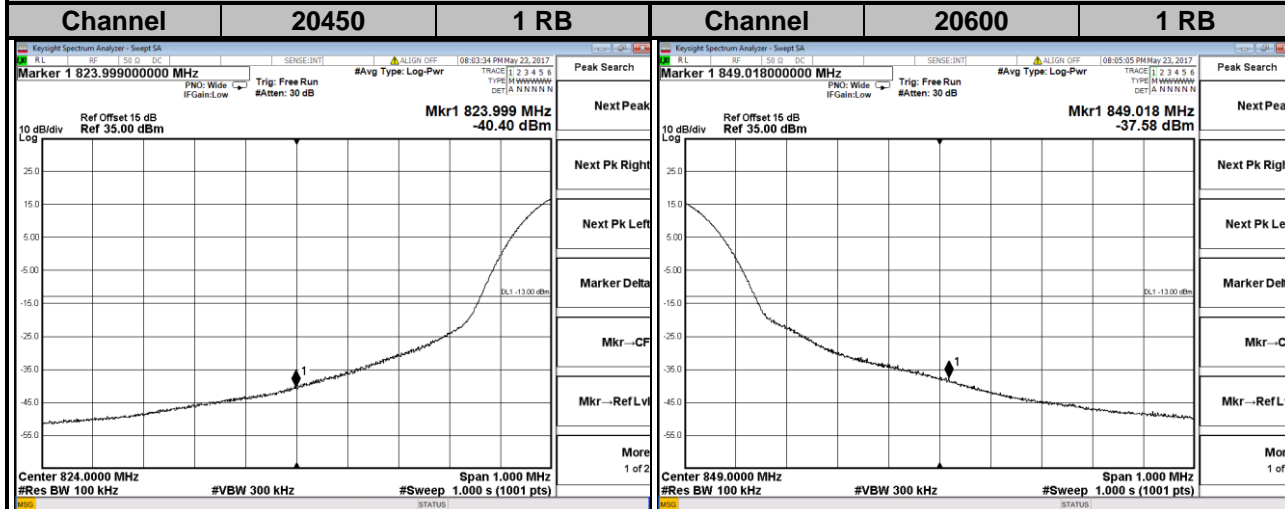

4.5 Peak to Average Ratio

4.5.1 Limits of Peak to Average Ratio Measurement

In measuring transmissions in this band using an average power technique, the peak to-average ratio (PAR) of the transmission may not exceed 13 dB.

4.5.2 Test Setup

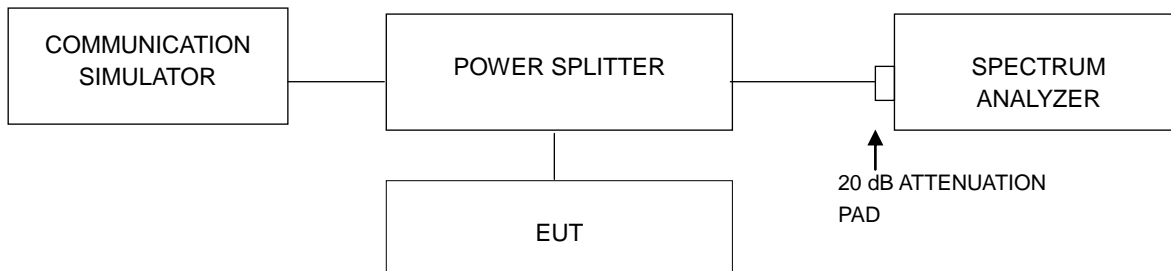

4.5.3 Test Procedures

1. Set resolution/measurement bandwidth \geq signal's occupied bandwidth;
2. Set the number of counts to a value that stabilizes the measured CCDF curve;
3. Record the maximum PAPR level associated with a probability of 0.1 %.

4.5.4 Test Results

Channel	Frequency (MHz)	Peak to Average Ratio (dB)		Channel	Frequency (MHz)	Peak to Average Ratio (dB)
		GSM	EDGE			
128	824.2	0.25	3.19	4132	826.4	3.16
189	836.4	0.25	3.20	4182	836.4	3.06
251	848.8	0.24	3.16	4233	846.6	2.88

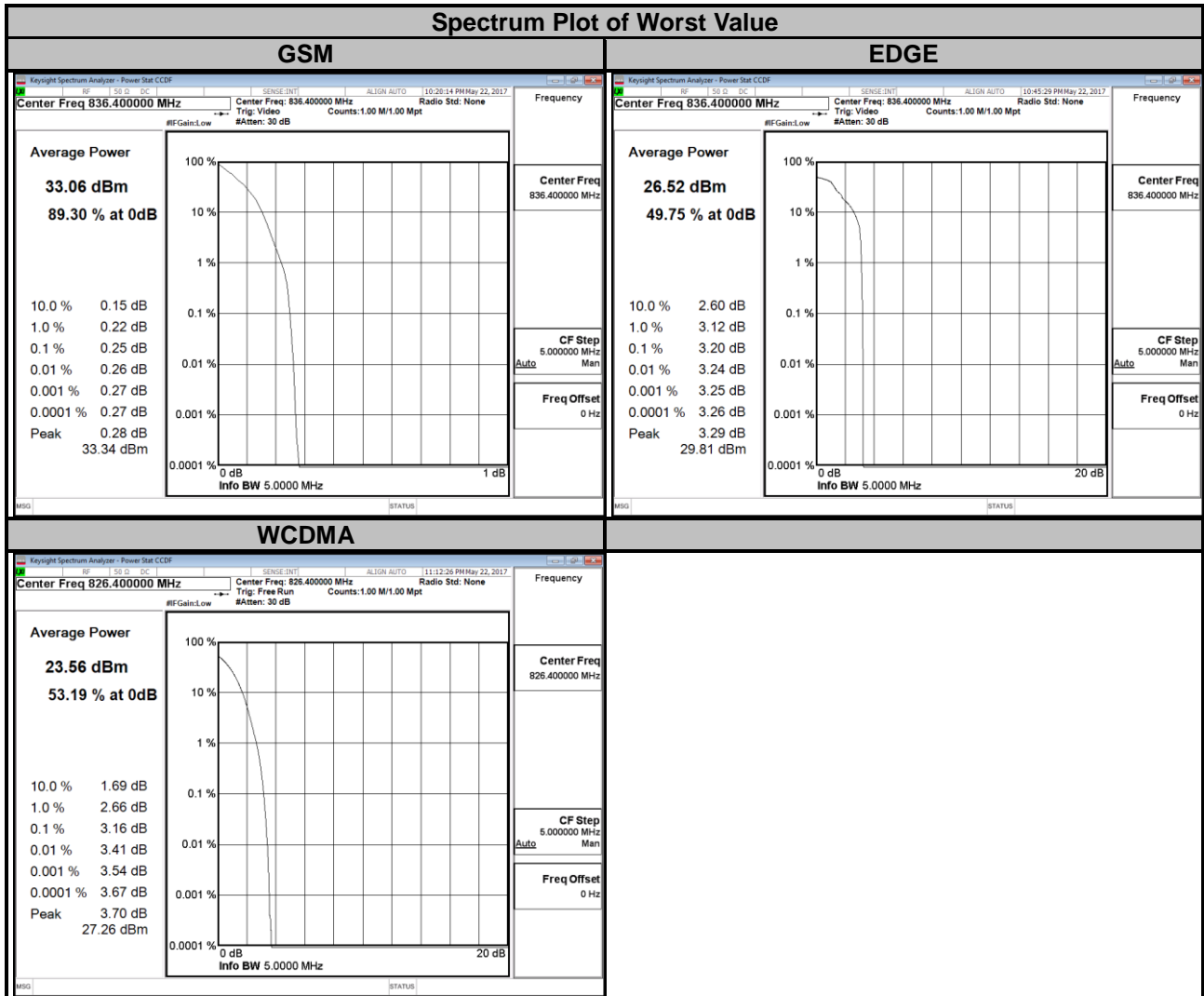

LTE Band 5

Channel Bandwidth: 1.4 MHz

Channel Bandwidth: 3 MHz

Channel	Frequency (MHz)	Peak to Average Ratio (dB)		Channel	Frequency (MHz)	Peak to Average Ratio (dB)	
		QPSK	16QAM			QPSK	16QAM
20407	824.7	3.97	4.78	20415	825.5	3.78	4.59
20525	836.5	3.80	4.60	20525	836.5	3.63	4.46
20643	848.3	3.39	4.11	20635	847.5	3.33	4.10

Spectrum Plot of Worst Value

1.4 MHz / QPSK

1.4 MHz / 16QAM

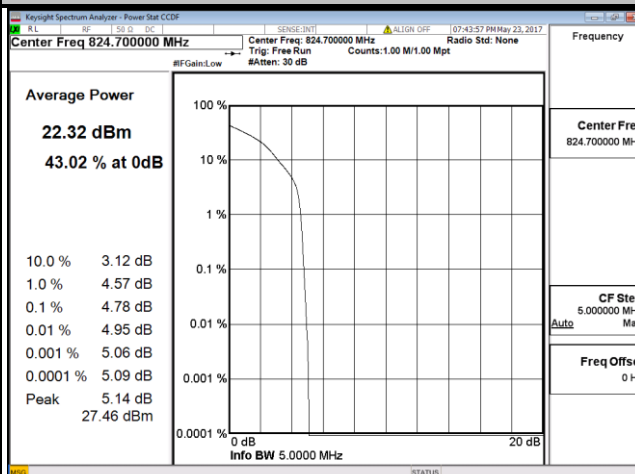
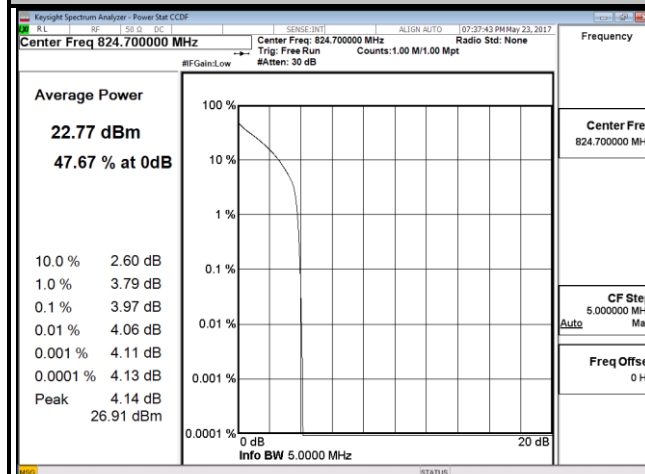

3 MHz / QPSK

3 MHz / 16QAM

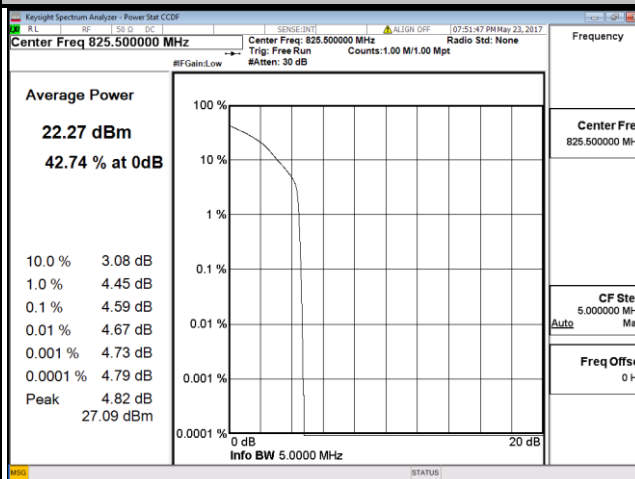
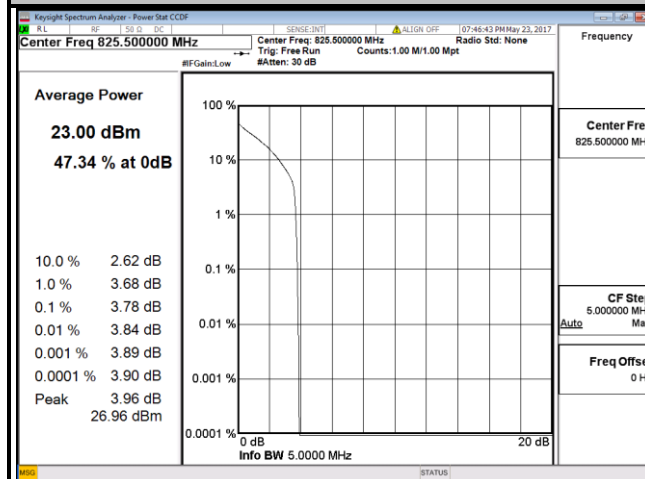

LTE Band 5

Channel Bandwidth: 5 MHz				Channel Bandwidth: 10 MHz			
Channel	Frequency (MHz)	Peak to Average Ratio (dB)		Channel	Frequency (MHz)	Peak to Average Ratio (dB)	
		QPSK	16QAM			QPSK	16QAM
20425	826.5	3.78	4.57	20450	829.0	3.71	4.54
20525	836.5	3.65	4.45	20525	836.5	3.71	4.51
20625	846.5	3.65	4.45	20600	844.0	3.60	4.42

Spectrum Plot of Worst Value

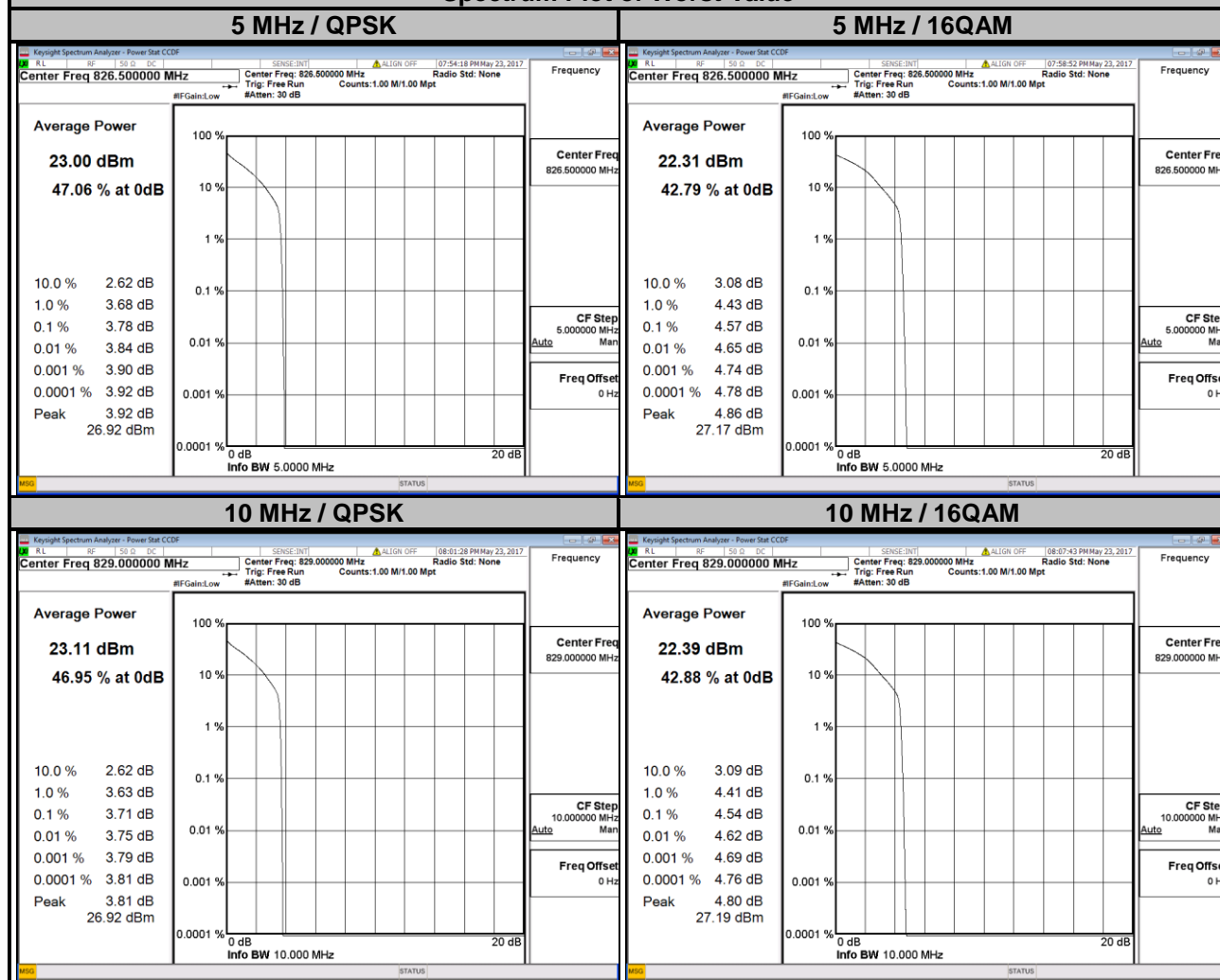

4.6 Conducted Spurious Emissions

4.6.1 Limits of Conducted Spurious Emissions Measurement

The power of any emission outside of the authorized operating frequency ranges must be attenuated below the transmitting power (P) by a factor of at least $43 + 10 \log(P)$ dB. The emission limit equal to -13 dBm.

4.6.2 Test Setup

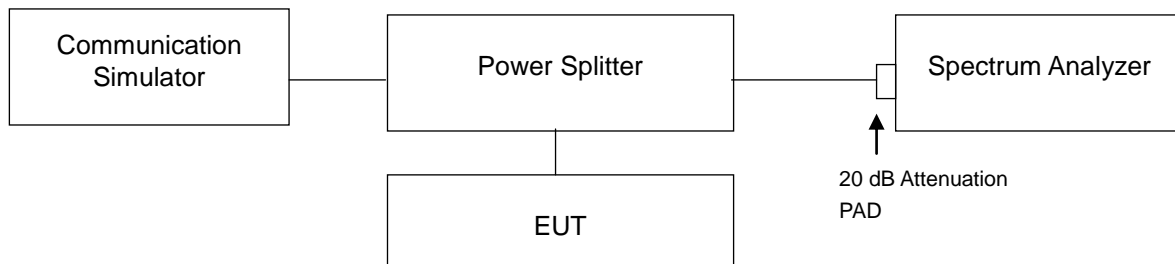

4.6.3 Test Procedure

- The EUT makes a phone call to the communication simulator. All measurements were done at low, middle and high operational frequency range.
- Measuring frequency range is from 9 kHz to 9 GHz. 20 dB attenuation pad is connected with spectrum. RBW=1 MHz and VBW=3 MHz is used for conducted emission measurement.

4.6.4 Test Results

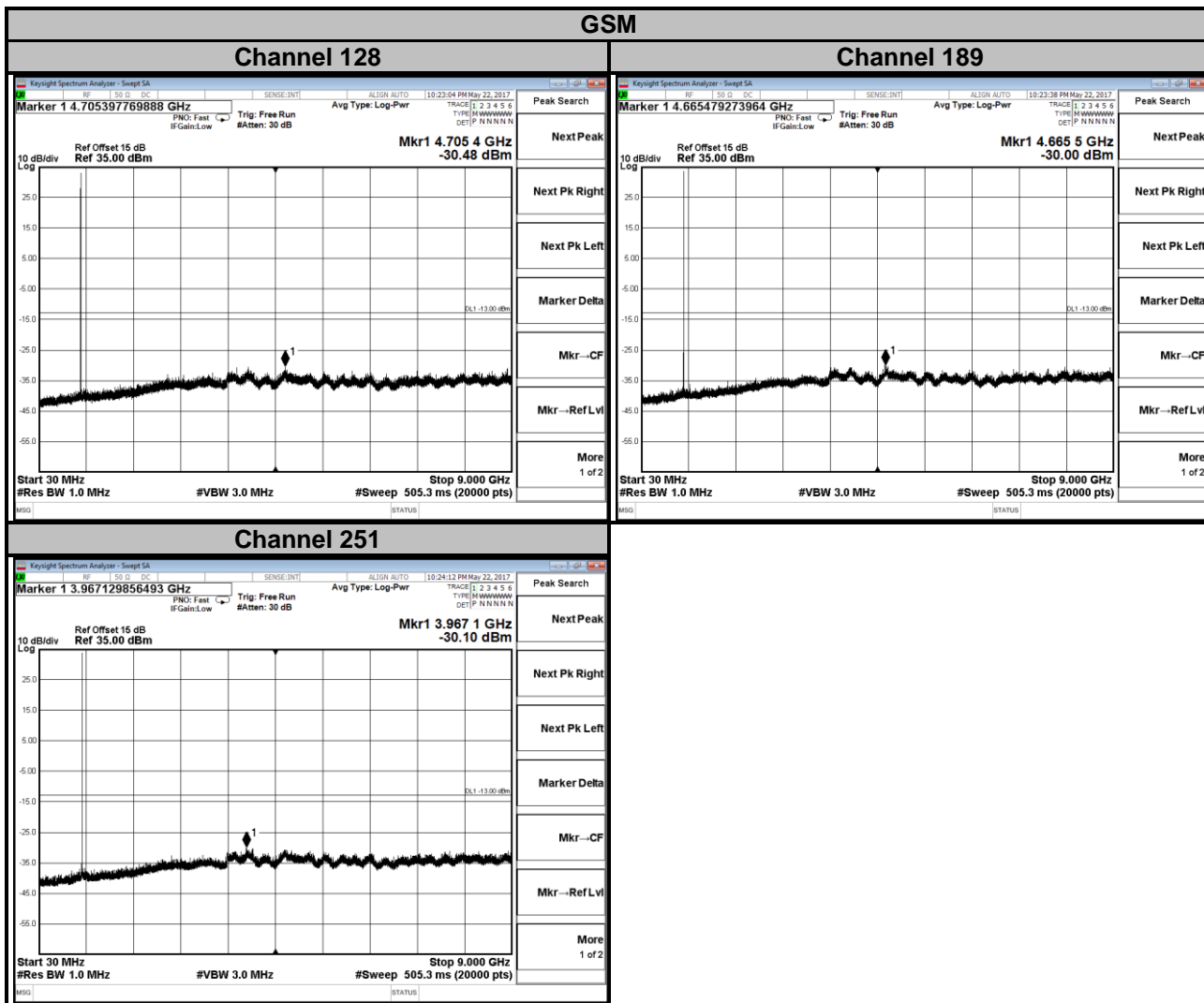

EDGE

Channel 128

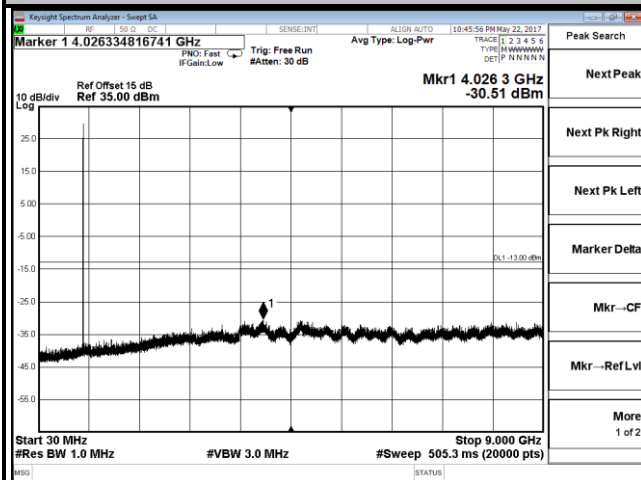

Channel 189

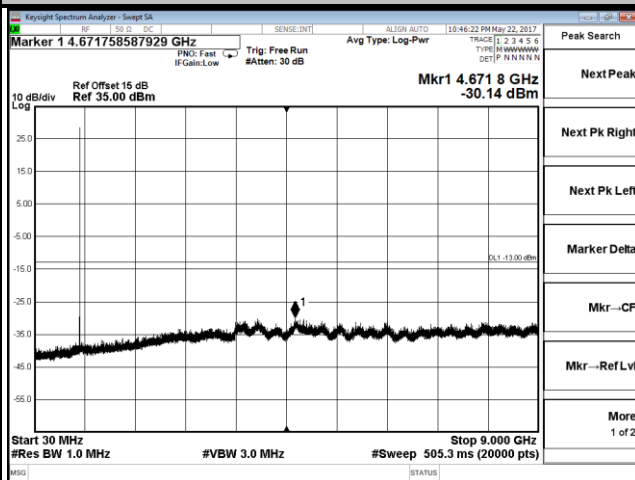

Channel 251

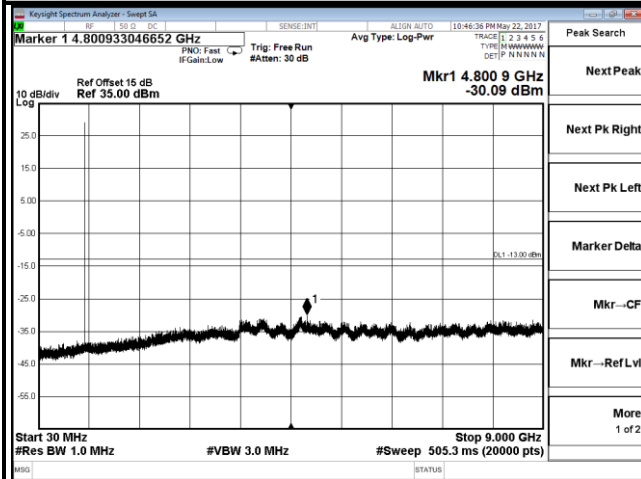

WCDMA

Channel 4132

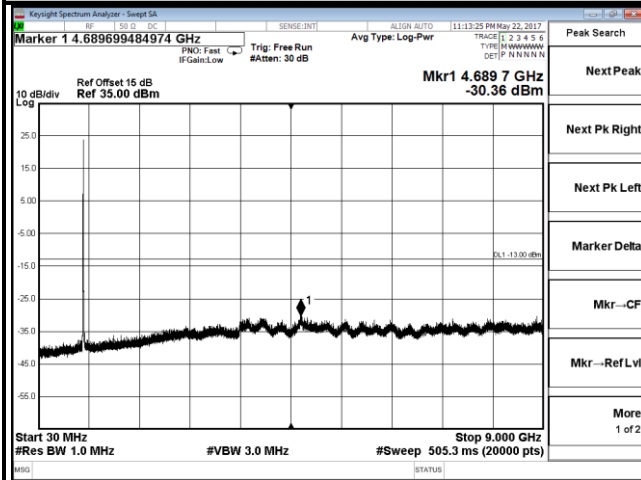

Channel 4182

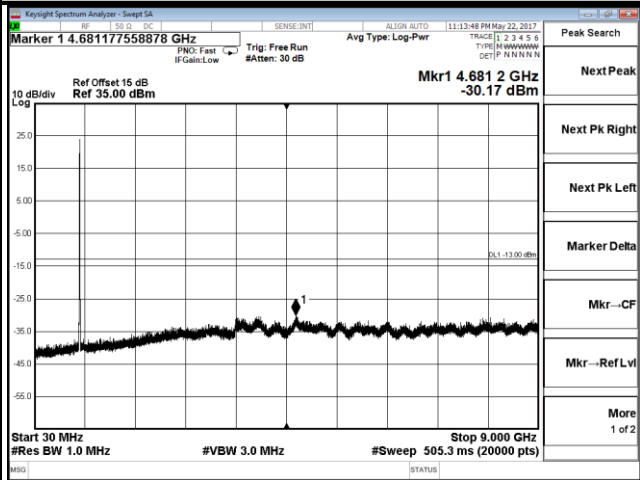

Channel 4233

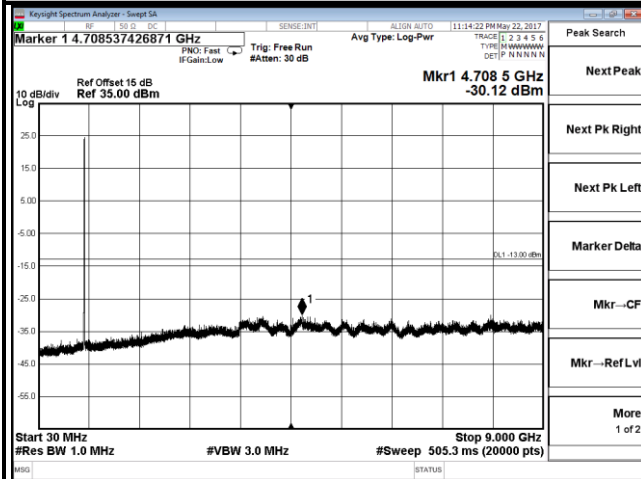

LTE Band 5
Channel Bandwidth: 1.4 MHz

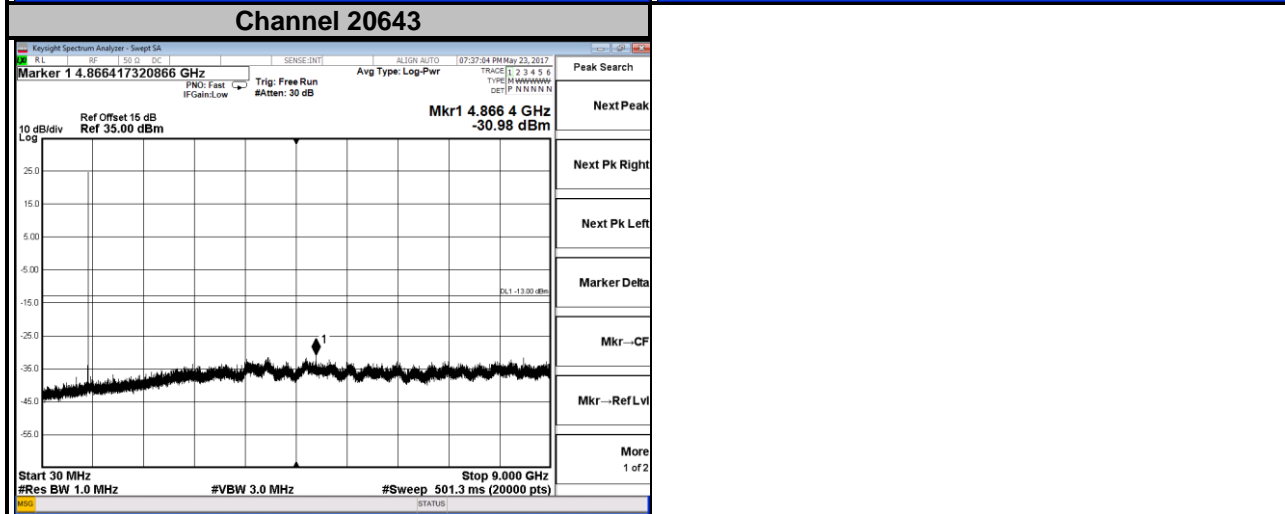
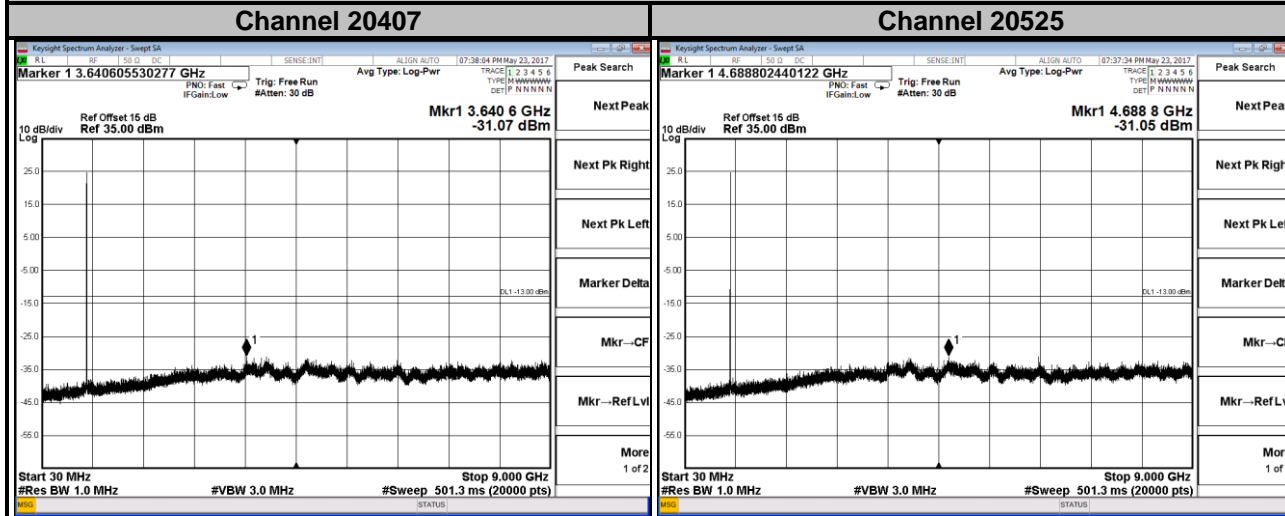

LTE Band 5
Channel Bandwidth: 3 MHz

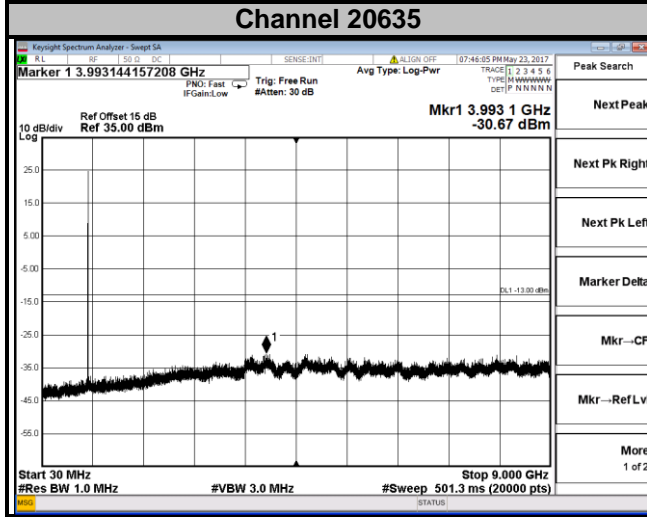
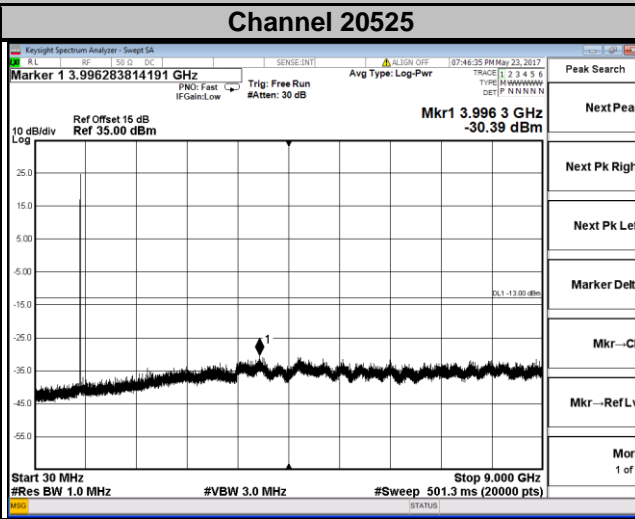
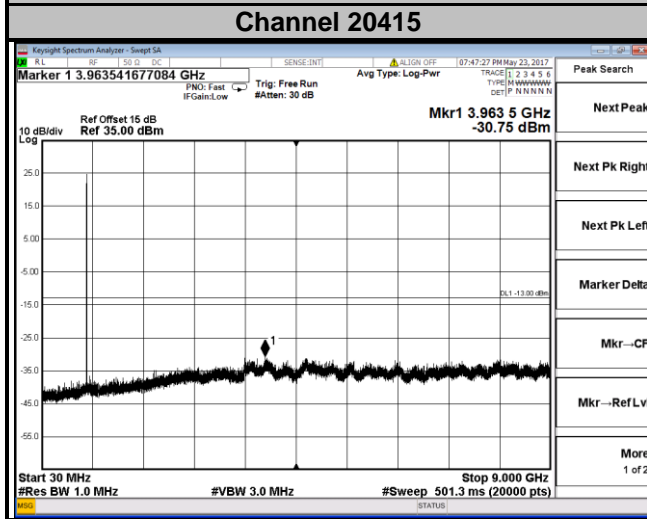

LTE Band 5
Channel Bandwidth: 5 MHz

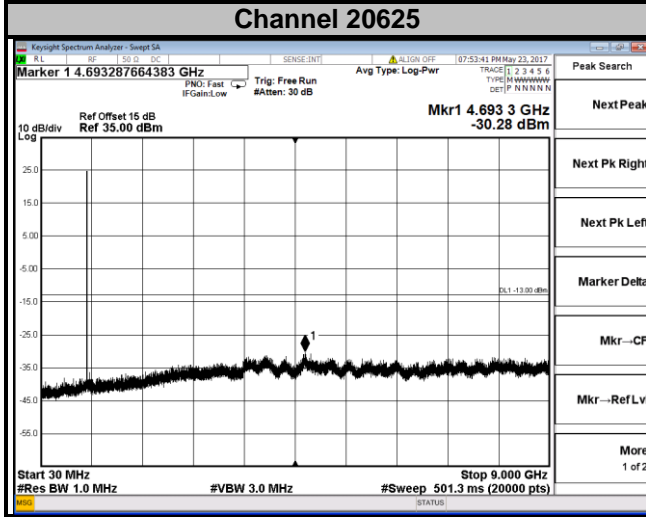
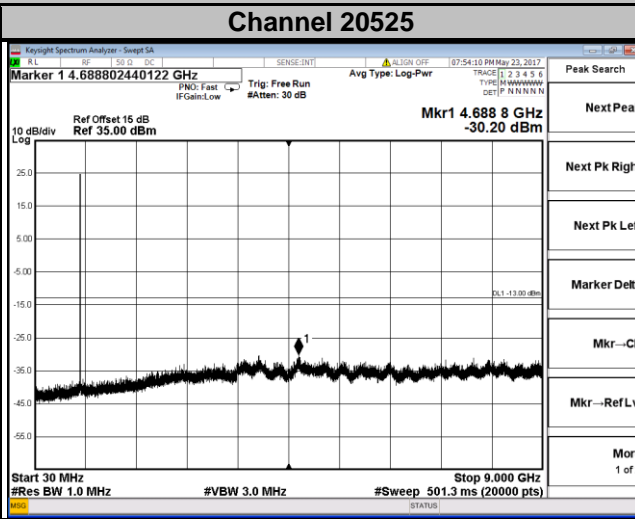
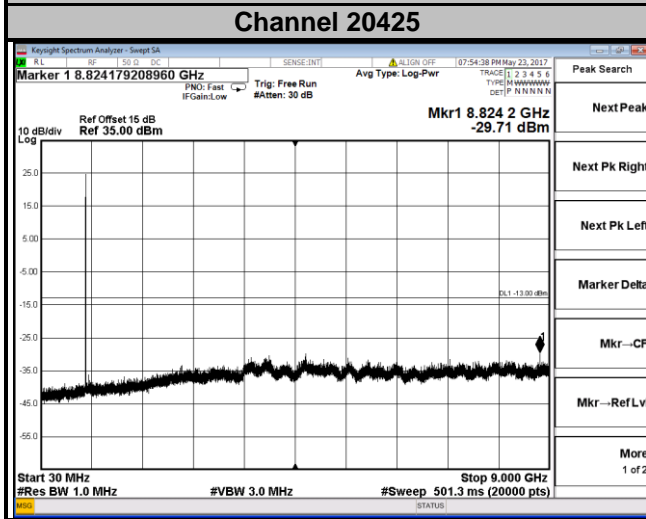

LTE Band 5

Channel Bandwidth: 10 MHz

Channel 20450

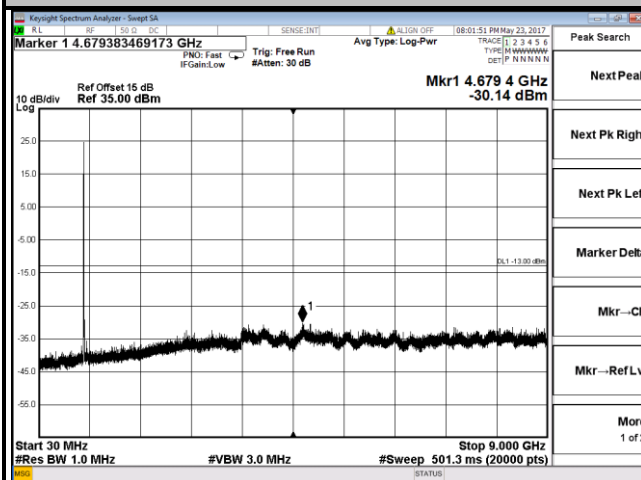

Channel 20525

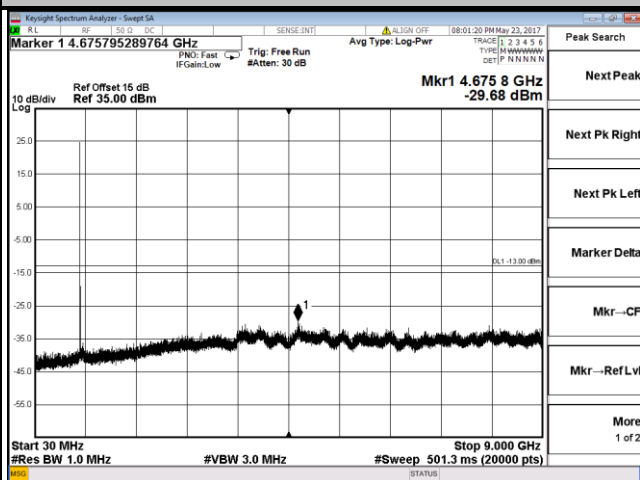

Channel 20600

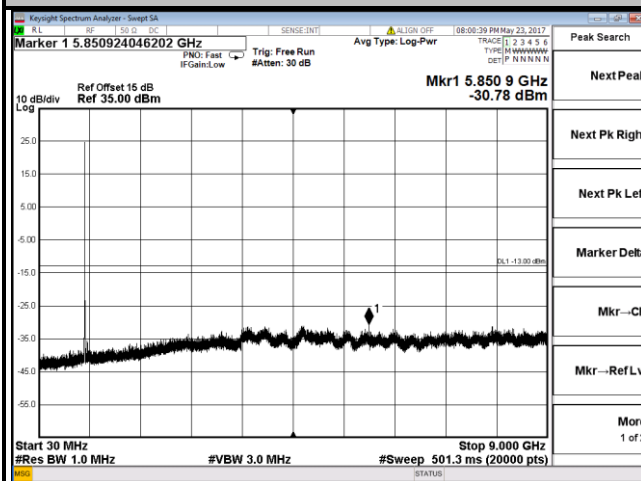

4.7 Radiated Emission Measurement

4.7.1 Limits of Radiated Emission Measurement

The power of any emission outside of the authorized operating frequency ranges must be attenuated below the transmitting power (P) by a factor of at least $43 + 10 \log(P)$ dB. The emission limit is equal to -13 dBm.

4.7.2 Test Procedure

- Substitution method is used for E.I.R.P measurement. In the semi-anechoic chamber, EUT placed on the 0.8 m height of Turn Table, rotated the table around 360 degrees to search the maximum radiation power and receiver antenna shall be rotated vertical and horizontal polarization and moved height from 1 m to 4 m to find the maximum polar radiated power. The "Read Value" is the spectrum reading the maximum power value.
- The substitution horn antenna is substituted for EUT at the same position and signals generator export the CW signal to the substitution antenna via a TX cable. Rotated the Turn Table and moved receiving antenna to find the maximum radiation power. Adjust output power level of S.G to get a Value of spectrum reading equal to "Read Value" of step a. Record the power level of S.G
- $EIRP = \text{Output power level of S.G} - \text{TX cable loss} + \text{Antenna gain of substitution horn.}$
- E.R.P power can be calculated form E.I.R.P power by subtracting the gain of dipole, $E.R.P \text{ power} = E.I.P.R \text{ power} - 2.15 \text{ dBi.}$

NOTE: The resolution bandwidth and video bandwidth of test receiver/spectrum analyzer is 1 MHz/3 MHz.

4.7.3 Deviation from Test Standard

No deviation.

4.7.4 Test Setup

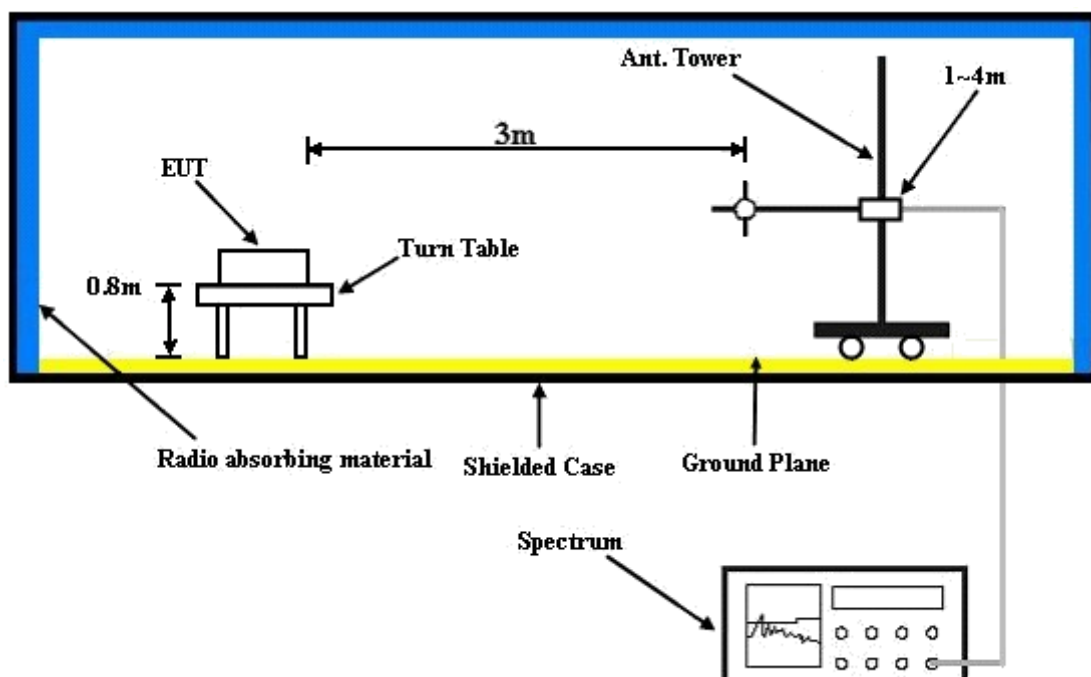

For the actual test configuration, please refer to the attached file (Test Setup Photo).

4.7.5 Test Results

GSM:
Low Channel



Bureau Veritas Consumer Products Services Ltd., Taoyuan Branch

A D T

Data: 9

Date: 2017-05-22

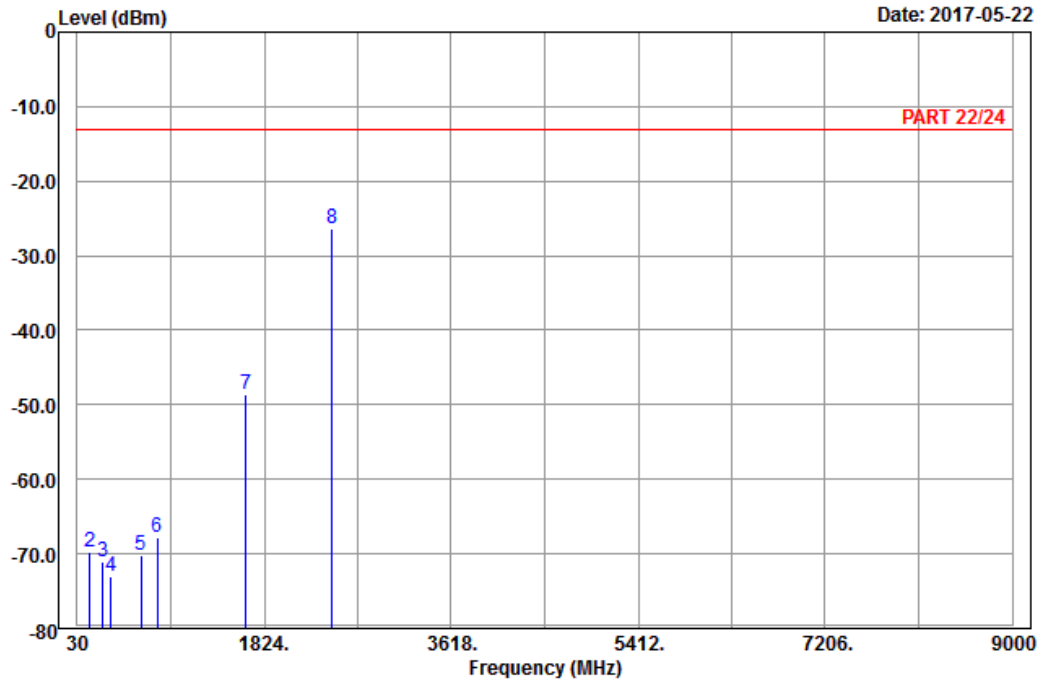

Site : 966 chamber 1
 Condition: PART 22/24 Horizontal
 Remark : GSM 850_Link_CH128
 Tested by: Karl Lee

	Freq	Level	Read Level	Limit Line	Over Limit	Factor	Remark
	MHz	dBm	dBm	dBm	dB	dB	
1	72.39	-83.13	-70.70	-13.00	-70.13	-12.43	Peak
2	147.99	-69.65	-61.75	-13.00	-56.65	-7.90	Peak
3	275.43	-71.08	-65.34	-13.00	-58.08	-5.74	Peak
4	353.20	-73.12	-67.90	-13.00	-60.12	-5.22	Peak
5	645.10	-70.16	-70.08	-13.00	-57.16	-0.08	Peak
6	799.10	-67.83	-69.78	-13.00	-54.83	1.95	Peak
7	1648.40	-48.55	-56.28	-13.00	-35.55	7.73	Peak
8 pp	2472.60	-26.27	-37.30	-13.00	-13.27	11.03	Peak



Bureau Veritas Consumer Products Services Ltd., Taoyuan Branch

A D T

Data: 10

Date: 2017-05-22

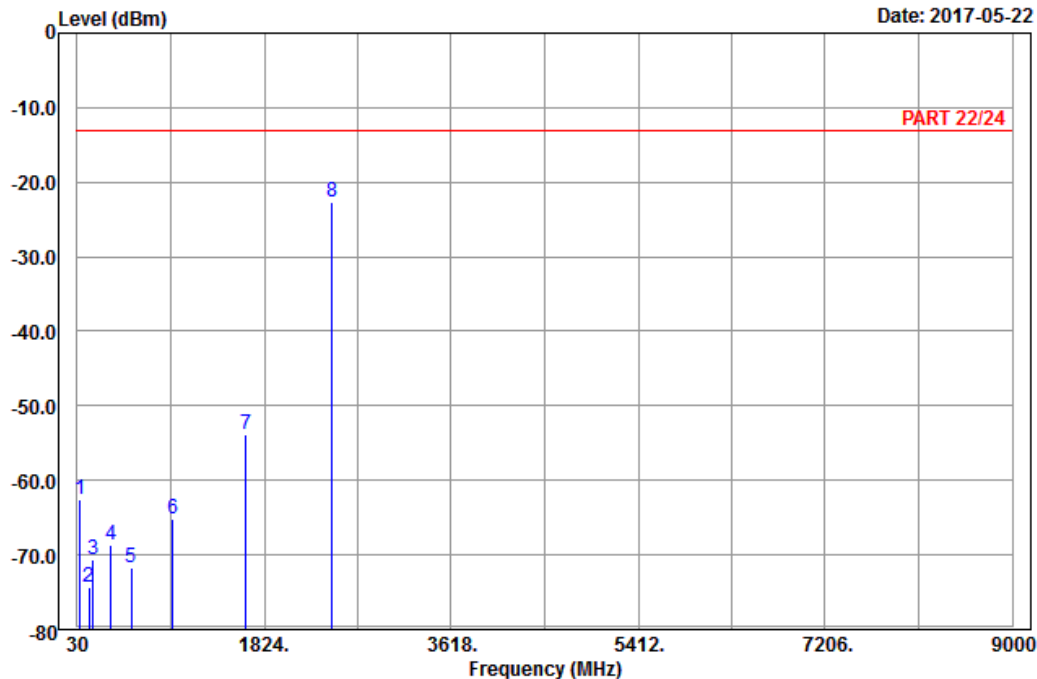

Site : 966 chamber 1
 Condition: PART 22/24 Vertical
 Remark : GSM 850_Link_CH128
 Tested by: Karl Lee

	Freq	Level	Read Level	Limit Line	Over Limit	Factor	Remark
	MHz	dBm	dBm	dBm	dB	dB	
1	59.97	-62.55	-48.48	-13.00	-49.55	-14.07	Peak
2	140.97	-74.42	-66.70	-13.00	-61.42	-7.72	Peak
3	183.09	-70.58	-64.96	-13.00	-57.58	-5.62	Peak
4	351.10	-68.77	-63.44	-13.00	-55.77	-5.33	Peak
5	548.50	-71.66	-69.93	-13.00	-58.66	-1.73	Peak
6	948.90	-65.08	-70.14	-13.00	-52.08	5.06	Peak
7	1648.40	-53.77	-61.50	-13.00	-40.77	7.73	Peak
8 pp	2472.60	-22.65	-33.68	-13.00	-9.65	11.03	Peak

Middle Channel



Bureau Veritas Consumer Products Services Ltd., Taoyuan Branch

A D T

Data: 5

Date: 2017-05-22

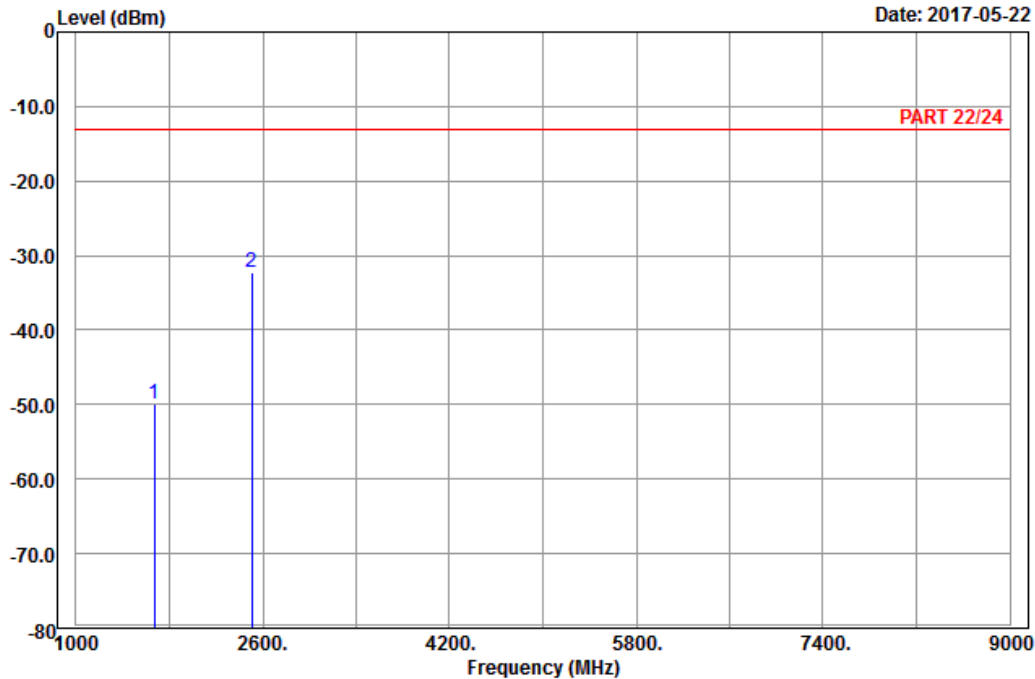

Site : 966 chamber 1
 Condition: PART 22/24 Horizontal
 Remark : GSM 850_Link_CH189
 Tested by: Karl Lee

	Freq	Level	Read Level	Limit Line	Over Limit	Factor	Remark
	MHz	dBm	dBm	dBm	dB	dB	
1	1672.80	-49.82	-57.73	-13.00	-36.82	7.91	Peak
2	2509.20	-32.17	-43.45	-13.00	-19.17	11.28	Peak



Bureau Veritas Consumer Products Services Ltd., Taoyuan Branch

A D T

Data: 6

Date: 2017-05-22

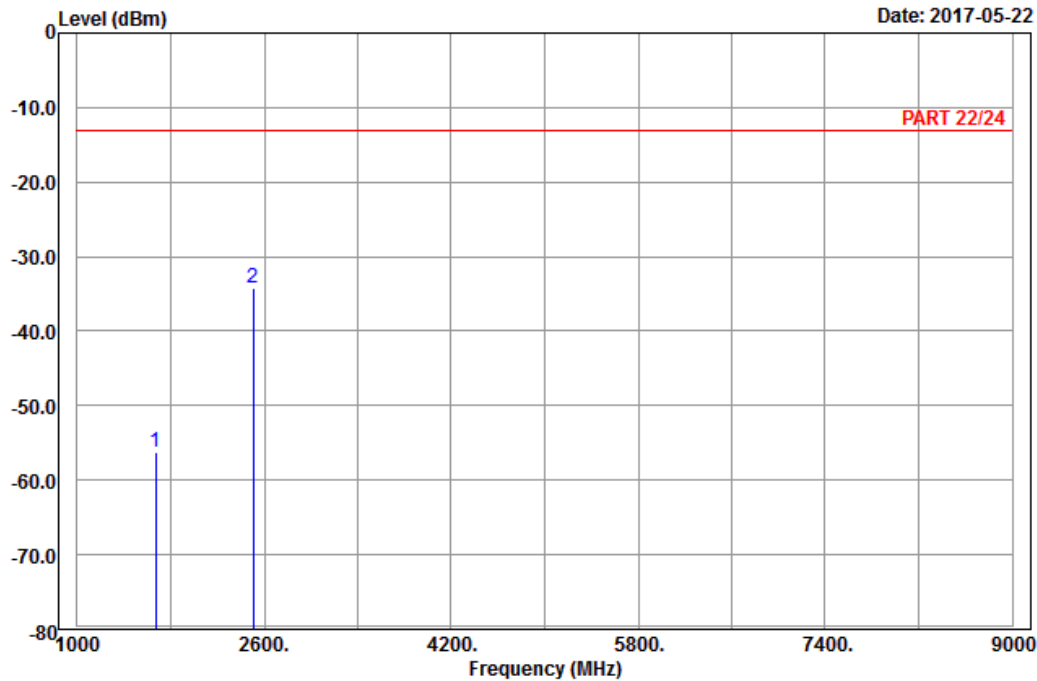

Site : 966 chamber 1
 Condition: PART 22/24 Vertical
 Remark : GSM 850_Link_CH189
 Tested by: Karl Lee

	Freq	Level	Read Level	Limit Line	Over Limit	Factor	Remark
	MHz	dBm	dBm	dBm	dB	dB	
1	1672.80	-56.32	-64.23	-13.00	-43.32	7.91	Peak
2 pp	2509.20	-34.24	-45.52	-13.00	-21.24	11.28	Peak

High Channel



Bureau Veritas Consumer Products Services Ltd., Taoyuan Branch

A D T

Data: 5

Date: 2017-05-22

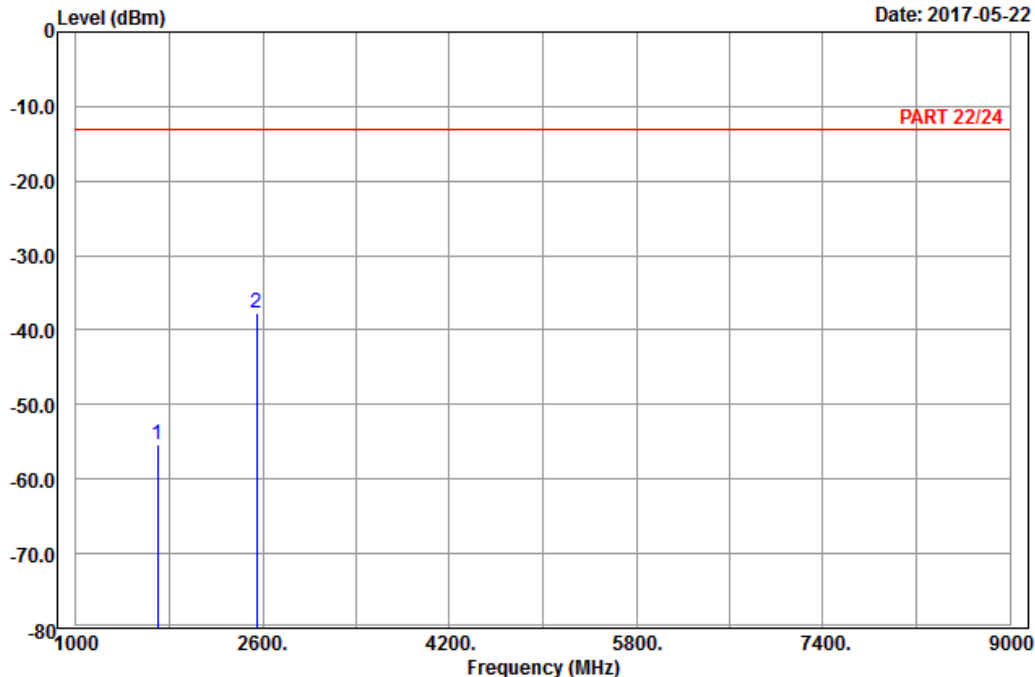

Site : 966 chamber 1
 Condition: PART 22/24 Horizontal
 Remark : GSM 850_Link_CH251
 Tested by: Karl Lee

	Freq	Level	Read Level	Limit Line	Over Limit	Factor	Remark
	MHz	dBm	dBm	dBm	dB	dB	
1	1697.60	-55.32	-63.46	-13.00	-42.32	8.14	Peak
2	2546.40	-37.65	-49.12	-13.00	-24.65	11.47	Peak



Bureau Veritas Consumer Products Services Ltd., Taoyuan Branch

A D T

Data: 6

Date: 2017-05-22

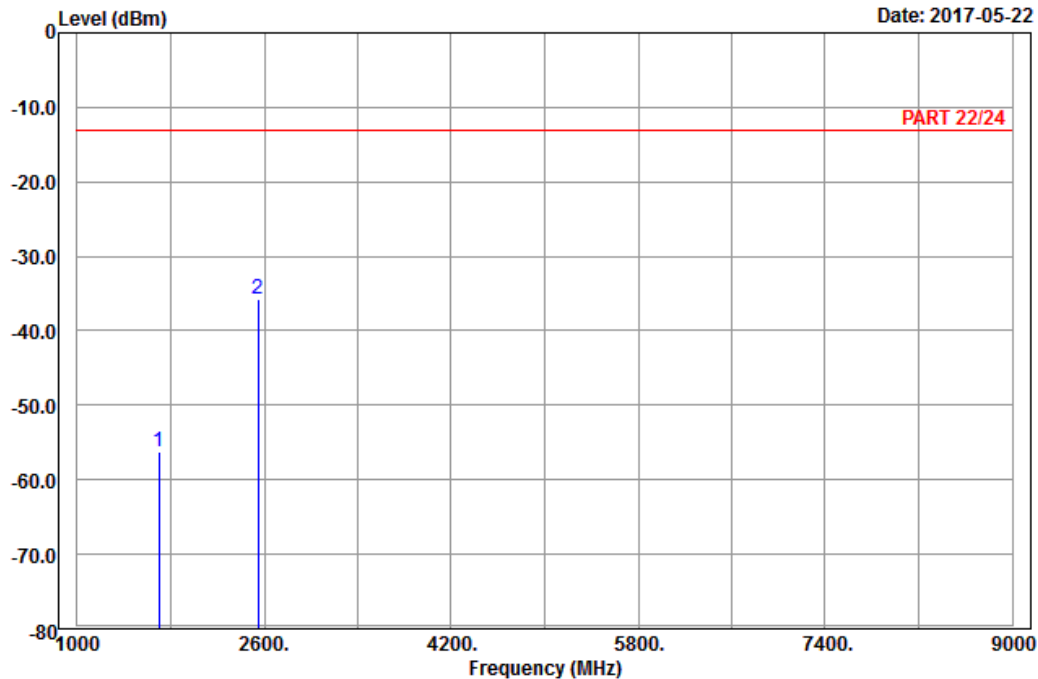

Site : 966 chamber 1
 Condition: PART 22/24 Vertical
 Remark : GSM 850_Link_CH251
 Tested by: Karl Lee

	Freq	Level	Read Level	Limit Line	Over Limit	Factor	Remark
	MHz	dBm	dBm	dBm	dB	dB	
1	1697.60	-56.22	-64.36	-13.00	-43.22	8.14	Peak
2 pp	2546.40	-35.71	-47.18	-13.00	-22.71	11.47	Peak

EDGE:
Low Channel



Bureau Veritas Consumer Products Services Ltd., Taoyuan Branch

A D T

Data: 5

Date: 2017-05-22

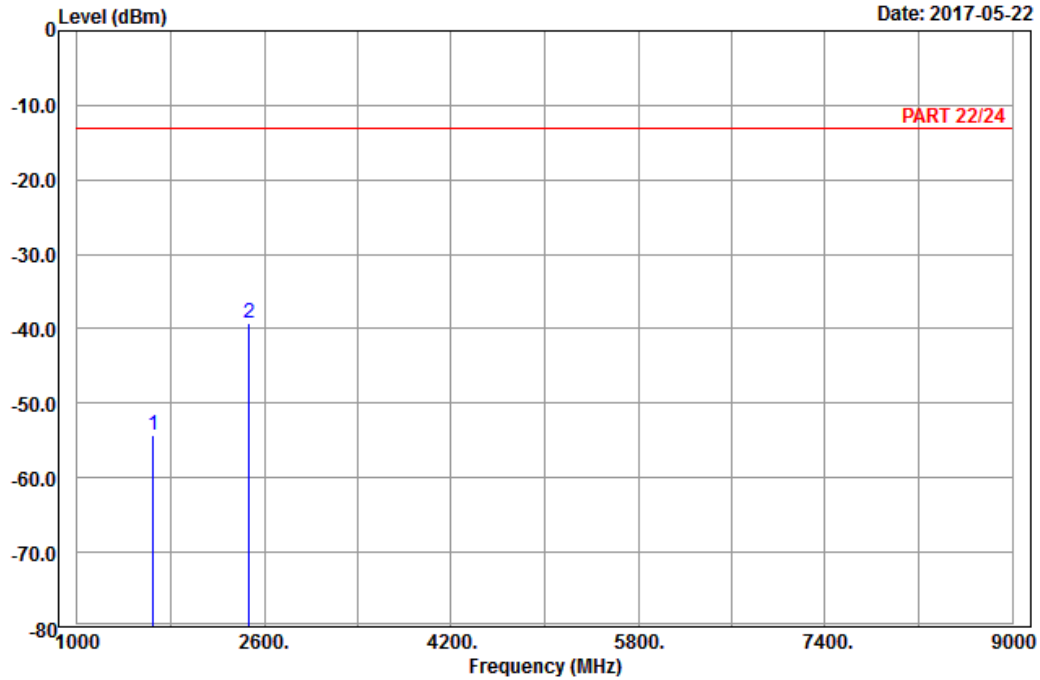

Site : 966 chamber 1
Condition: PART 22/24 Horizontal
Remark : EDGE 850_Link_CH128
Tested by: Karl Lee

	Freq	Level	Read Level	Limit Line	Over Limit	Factor	Remark
	MHz	dBm	dBm	dBm	dB	dB	
1	1648.40	-54.33	-62.06	-13.00	-41.33	7.73	Peak
2 pp	2472.60	-39.27	-50.30	-13.00	-26.27	11.03	Peak



Bureau Veritas Consumer Products Services Ltd., Taoyuan Branch

A D T

Data: 6

Date: 2017-05-22

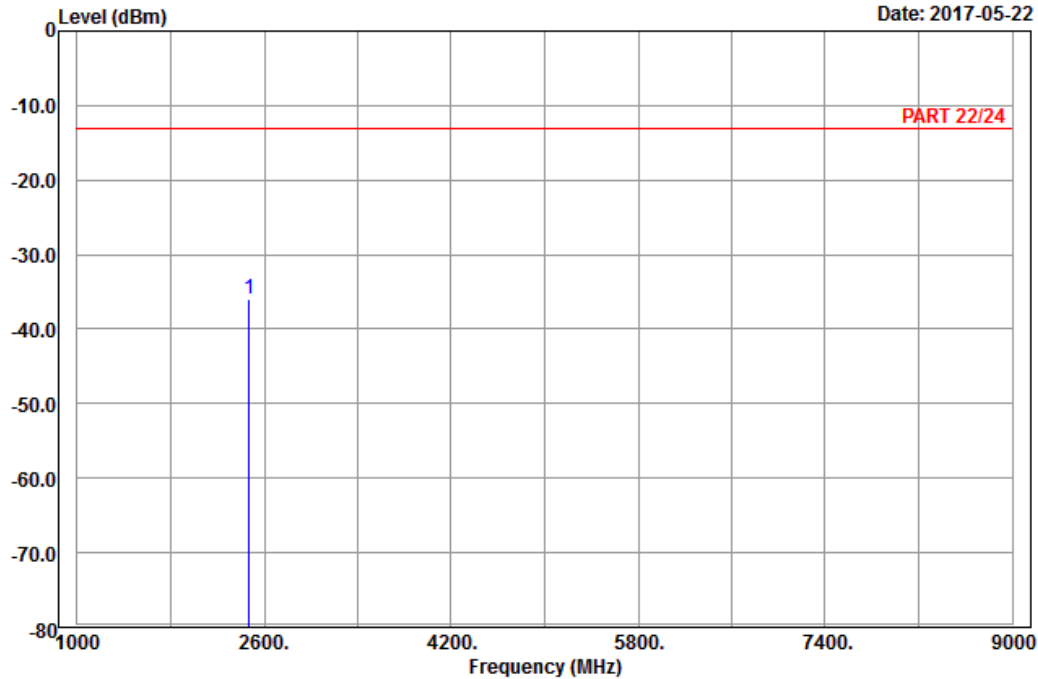

Site : 966 chamber 1
 Condition: PART 22/24 Vertical
 Remark : EDGE 850_Link_CH128
 Tested by: Karl Lee

	Freq	Level	Read Level	Limit Line	Over Limit	Factor	Remark
	MHz	dBm	dBm	dBm	dB	dB	
1	pp 2472.60	-35.97	-47.00	-13.00	-22.97	11.03	Peak

Middle Channel



Bureau Veritas Consumer Products Services Ltd., Taoyuan Branch

A D T

Data: 5

Date: 2017-05-22

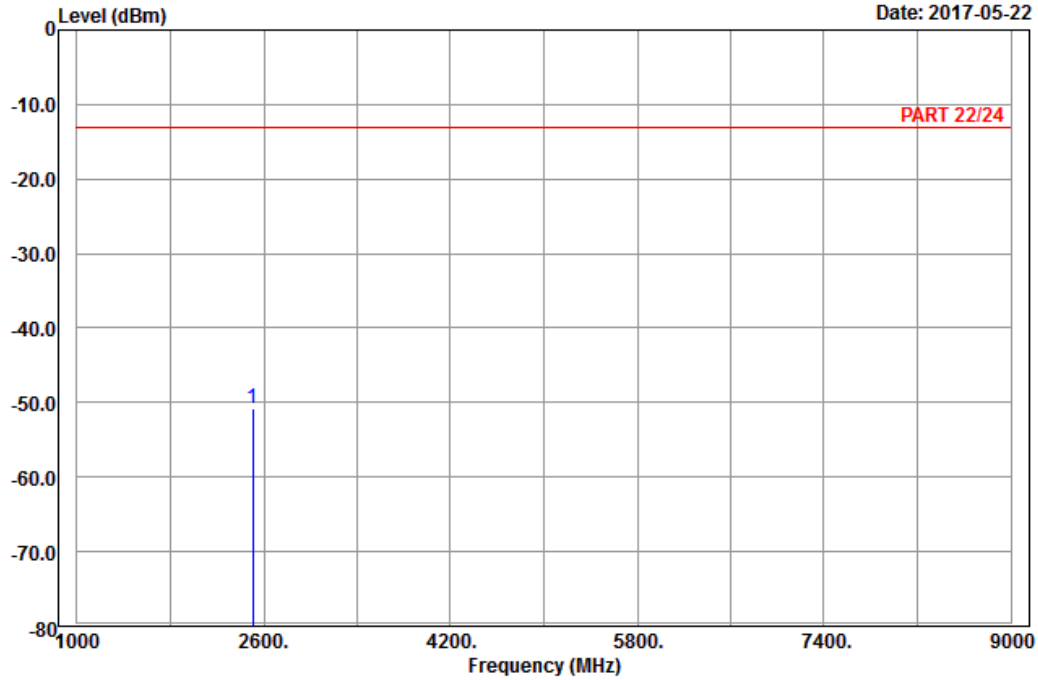

Site : 966 chamber 1
 Condition: PART 22/24 Horizontal
 Remark : EDGE 850_Link_CH189
 Tested by: Karl Lee

Freq	Level	Read Level	Limit Line	Over Limit	Factor	Remark
MHz	dBm	dBm	dBm	dB	dB	
1 pp 2509.20	-50.81	-62.09	-13.00	-37.81	11.28	Peak



Bureau Veritas Consumer Products Services Ltd., Taoyuan Branch

A D T

Data: 6

Date: 2017-05-22

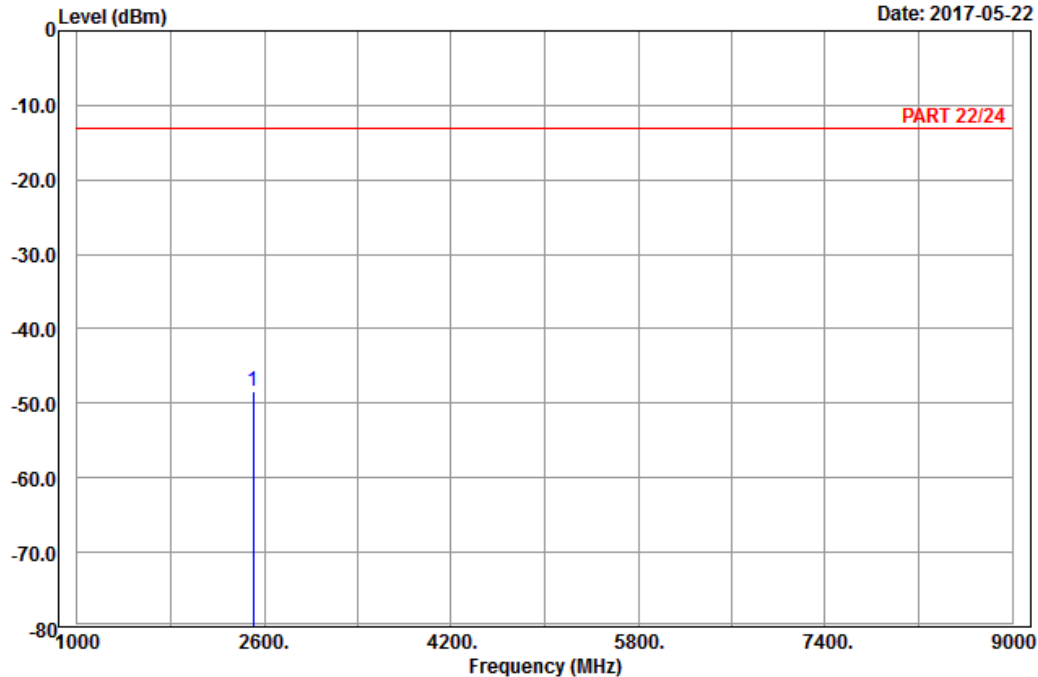

Site : 966 chamber 1
 Condition: PART 22/24 Vertical
 Remark : EDGE 850_Link_CH189
 Tested by: Karl Lee

	Freq	Level	Read Level	Limit Line	Over Limit	Factor	Remark
	MHz	dBm	dBm	dBm	dB	dB	
1	pp 2509.20	-48.47	-59.75	-13.00	-35.47	11.28	Peak

High Channel



Bureau Veritas Consumer Products Services Ltd., Taoyuan Branch

A D T

Data: 5

Date: 2017-05-22

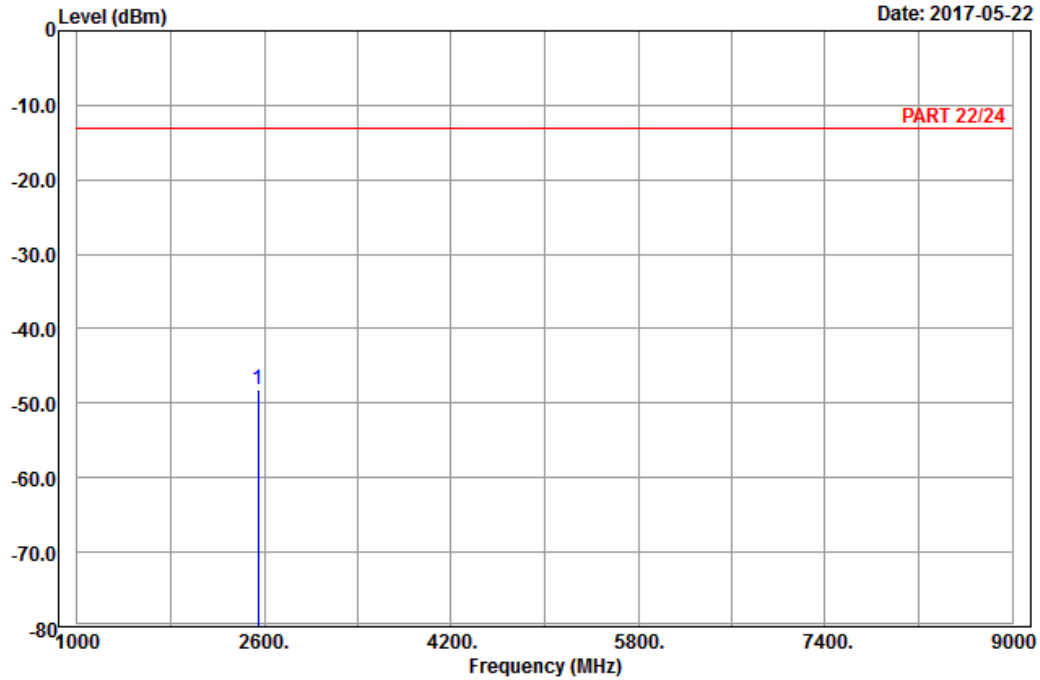

Site : 966 chamber 1
 Condition: PART 22/24 Horizontal
 Remark : EDGE 850_Link_CH251
 Tested by: Karl Lee

Freq	Level	Read Level	Limit Line	Over Limit	Factor	Remark
MHz	dBm	dBm	dBm	dB	dB	
1 pp 2546.40	-48.12	-59.59	-13.00	-35.12	11.47	Peak



Bureau Veritas Consumer Products Services Ltd., Taoyuan Branch

A D T

Data: 6

Date: 2017-05-22

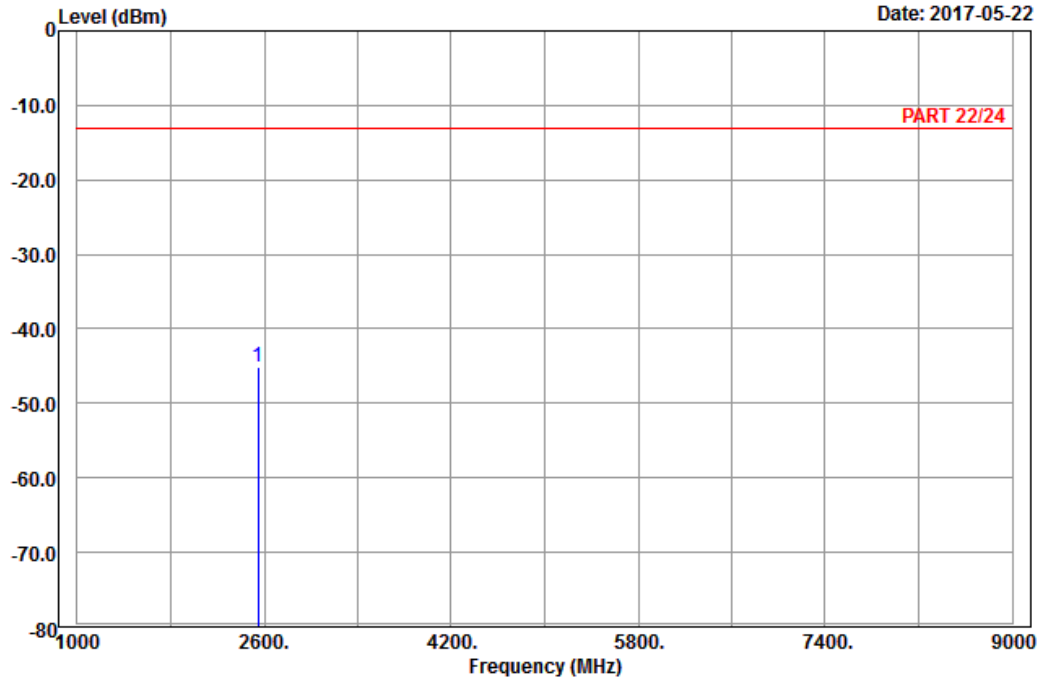

Site : 966 chamber 1
 Condition: PART 22/24 Vertical
 Remark : EDGE 850_Link_CH251
 Tested by: Karl Lee

	Freq	Level	Read Level	Limit Line	Over Limit	Factor	Remark
	MHz	dBm	dBm	dBm	dB	dB	
1	pp 2546.40	-45.20	-56.67	-13.00	-32.20	11.47	Peak

WCDMA:
Low Channel



Bureau Veritas Consumer Products Services Ltd., Taoyuan Branch

A D T

Data: 5

Date: 2017-05-23

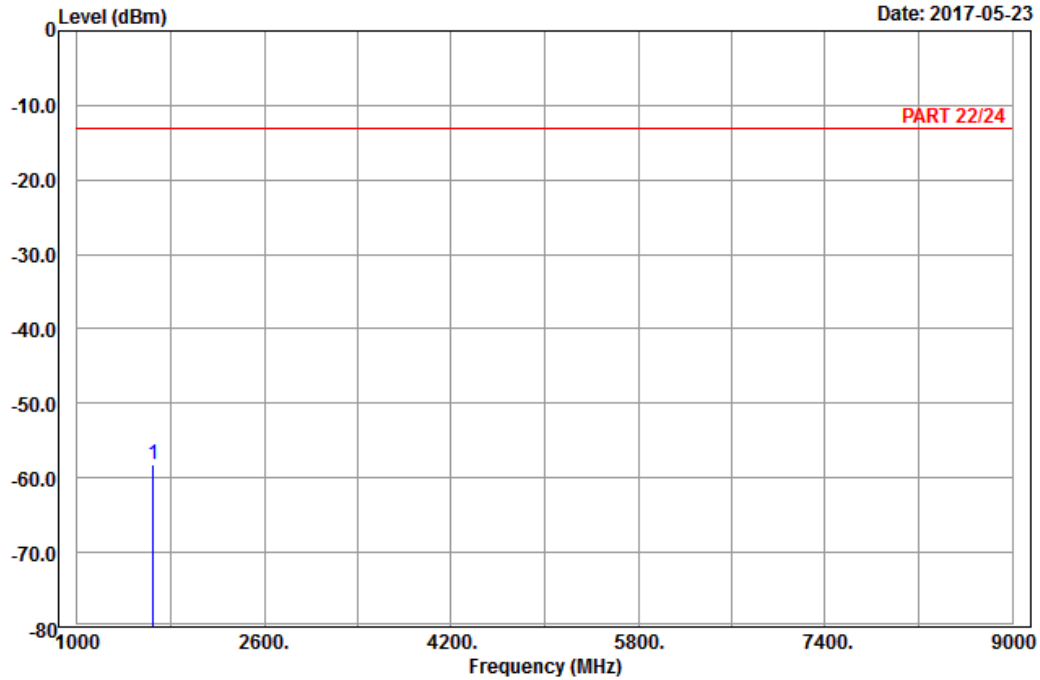

Site : 966 chamber 1
Condition: PART 22/24 Horizontal
Remark : Band V_Link_CH4132
Tested by: Karl Lee

	Freq	Level	Read Level	Limit Line	Over Limit	Factor	Remark
	MHz	dBm	dBm	dBm	dB	dB	
1	pp 1652.80	-58.21	-65.94	-13.00	-45.21	7.73	Peak



Bureau Veritas Consumer Products Services Ltd., Taoyuan Branch

A D T

Data: 6

Date: 2017-05-23

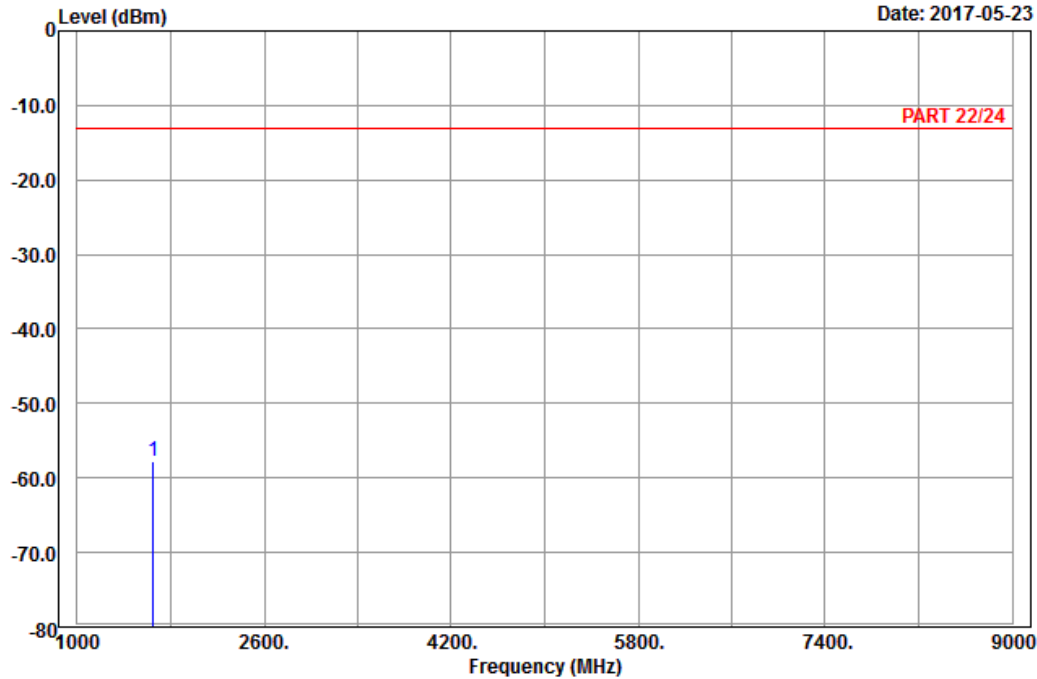

Site : 966 chamber 1
 Condition: PART 22/24 Vertical
 Remark : Band V_Link_CH4132
 Tested by: Karl Lee

	Freq	Level	Read Level	Limit Line	Over Limit	Factor	Remark
	MHz	dBm	dBm	dBm	dB	dB	
1	pp 1652.80	-57.76	-65.49	-13.00	-44.76	7.73	Peak

Middle Channel



Bureau Veritas Consumer Products Services Ltd., Taoyuan Branch

A D T

Data: 5

Date: 2017-05-23

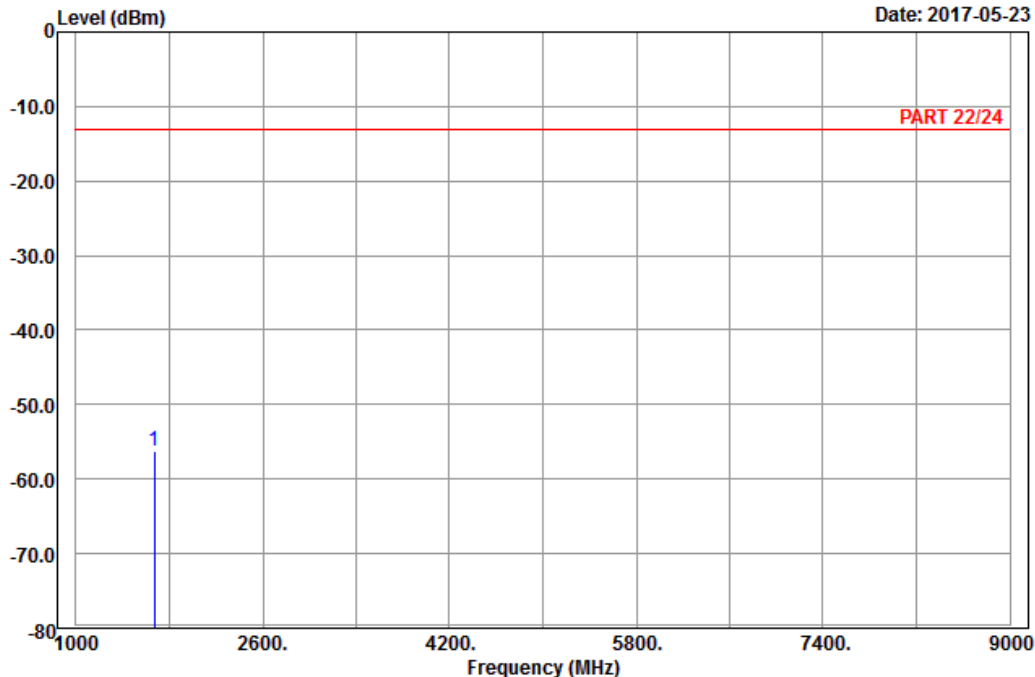

Site : 966 chamber 1
 Condition: PART 22/24 Horizontal
 Remark : Band V_Link_CH4182
 Tested by: Karl Lee

Freq	Level	Read Level	Limit Line	Over Limit	Factor	Remark
MHz	dBm	dBm	dBm	dB	dB	
1 pp 1672.80	-56.30	-64.21	-13.00	-43.30	7.91	Peak



Bureau Veritas Consumer Products Services Ltd., Taoyuan Branch

A D T

Data: 6

Date: 2017-05-23

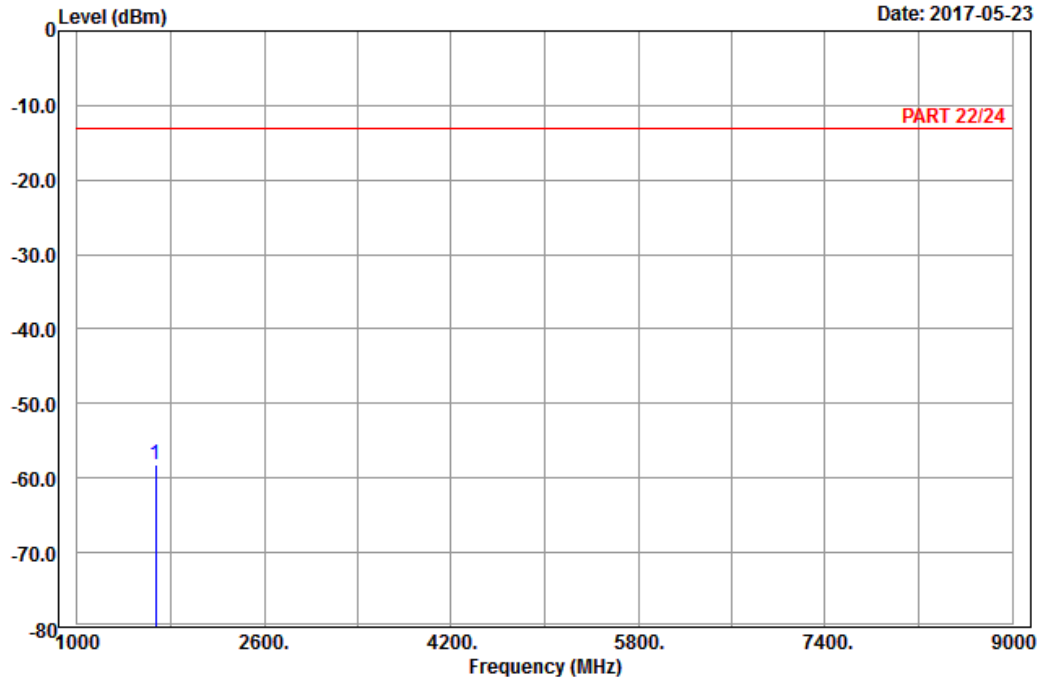

Site : 966 chamber 1
 Condition: PART 22/24 Vertical
 Remark : Band V_Link_CH4182
 Tested by: Karl Lee

	Freq	Level	Read Level	Limit Line	Over Limit	Factor	Remark
	MHz	dBm	dBm	dBm	dB	dB	
1	pp 1672.80	-58.12	-66.03	-13.00	-45.12	7.91	Peak

High Channel



Bureau Veritas Consumer Products Services Ltd., Taoyuan Branch

A D T

Data: 5

Date: 2017-05-23

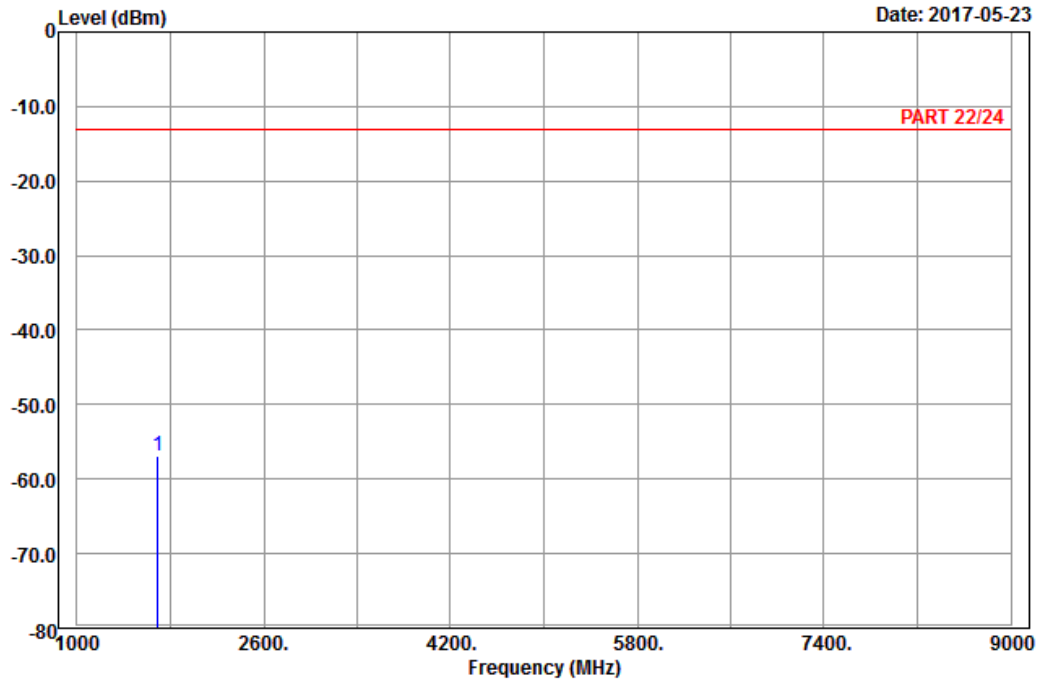

Site : 966 chamber 1
 Condition: PART 22/24 Horizontal
 Remark : Band V_Link_CH4233
 Tested by: Karl Lee

Freq	Level	Read Level	Limit Line	Over Limit	Factor	Remark
MHz	dBm	dBm	dBm	dB	dB	
1 pp 1693.20	-56.85	-64.99	-13.00	-43.85	8.14	Peak



Bureau Veritas Consumer Products Services Ltd., Taoyuan Branch

A D T

Data: 6

Date: 2017-05-23

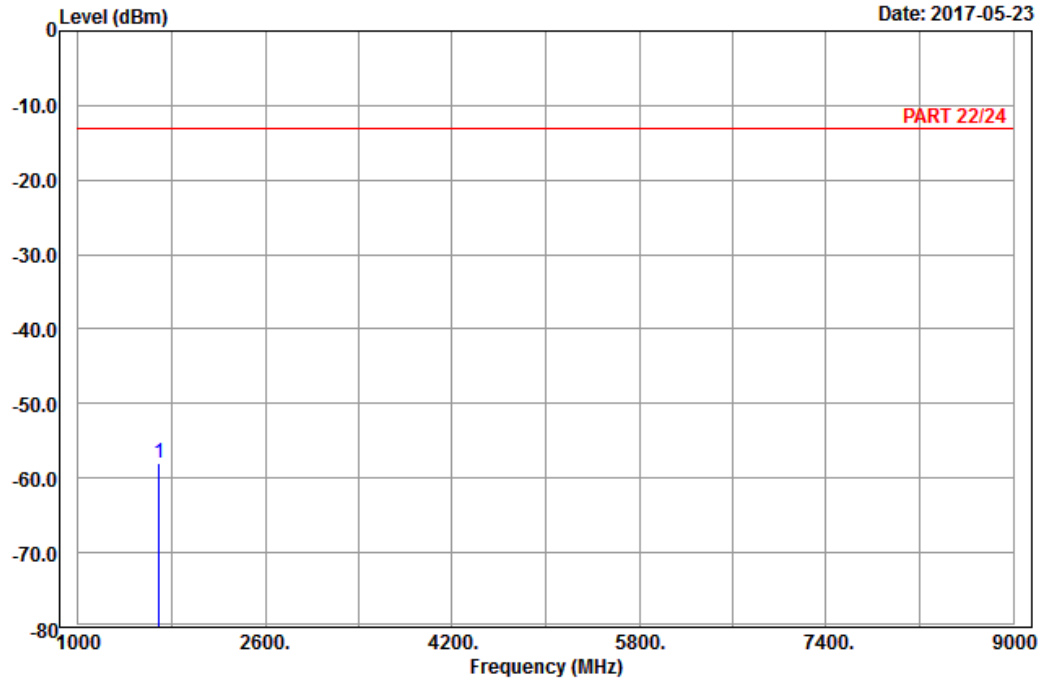

Site : 966 chamber 1
 Condition: PART 22/24 Vertical
 Remark : Band V_Link_CH4233
 Tested by: Karl Lee

	Freq	Level	Read Level	Limit Line	Over Limit	Factor	Remark
	MHz	dBm	dBm	dBm	dB	dB	
1	pp 1693.20	-58.06	-66.20	-13.00	-45.06	8.14	Peak

LTE Band 5
 Channel Bandwidth: 10 MHz / QPSK
 Low Channel



Bureau Veritas Consumer Products Services Ltd., Taoyuan Branch

A D T

Data: 5

Date: 2017-05-23

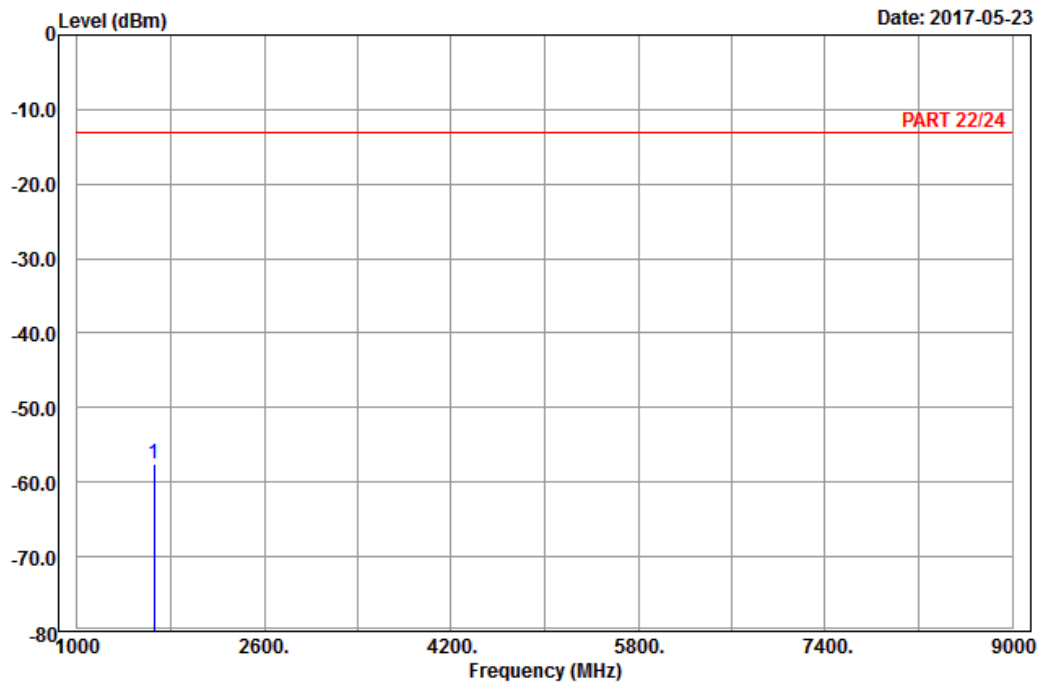

Site : 966 chamber 1
 Condition: PART 22/24 Horizontal
 Remark : LTE_Band 5_Link_CH20450
 Tested by: Harry Hsueh

	Read	Limit	Over		
Freq	Level	Level	Line	Limit	Factor Remark
MHz	dBm	dBm	dBm	dB	dB
1 pp 1658.00	-57.44	-65.35	-13.00	-44.44	7.91 Peak



Bureau Veritas Consumer Products Services Ltd., Taoyuan Branch

A D T

Data: 6

Date: 2017-05-23

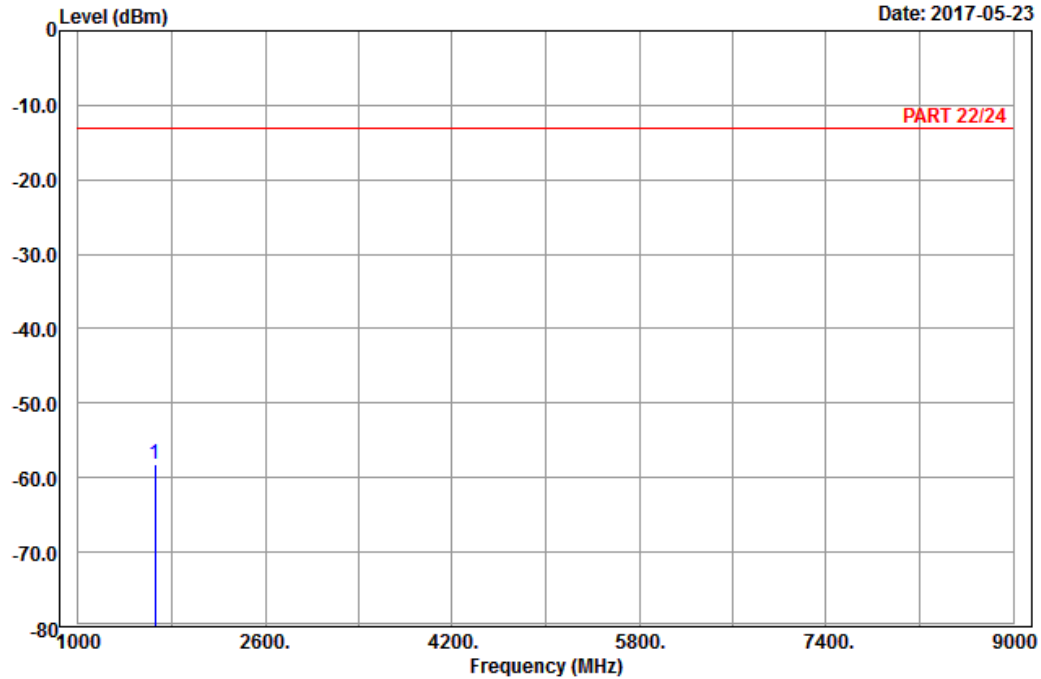

Site : 966 chamber 1
 Condition: PART 22/24 Vertical
 Remark : LTE_Band 5_Link_CH20450
 Tested by: Harry Hsueh

	Freq	Level	Read Level	Limit Line	Over Limit	Factor	Remark
	MHz	dBm	dBm	dBm	dB	dB	
1	pp 1658.00	-58.22	-66.13	-13.00	-45.22	7.91	Peak

Middle Channel



Bureau Veritas Consumer Products Services Ltd., Taoyuan Branch

A D T

Data: 5

Date: 2017-05-23

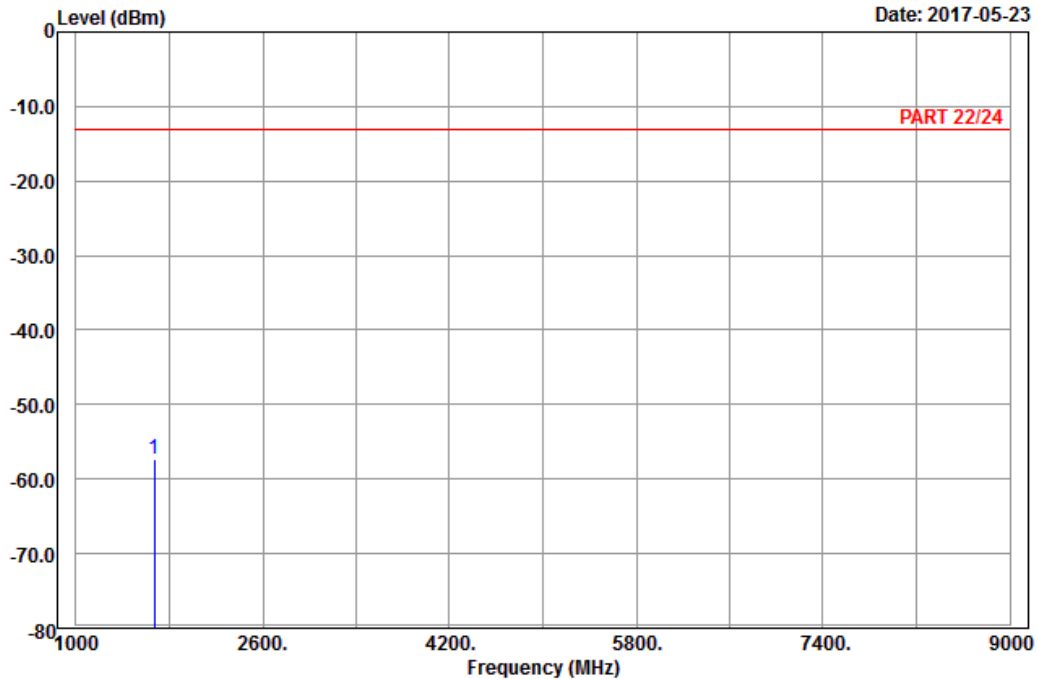

Site : 966 chamber 1
 Condition: PART 22/24 Horizontal
 Remark : LTE_Band 5_Link_CH20525
 Tested by: Harry Hsueh

	Read	Limit	Over			
Freq	Level	Level	Line	Limit	Factor	Remark
MHz	dBm	dBm	dBm	dB	dB	
1 pp 1673.00	-57.29	-65.20	-13.00	-44.29	7.91	Peak



A D T

Data: 6

Date: 2017-05-23

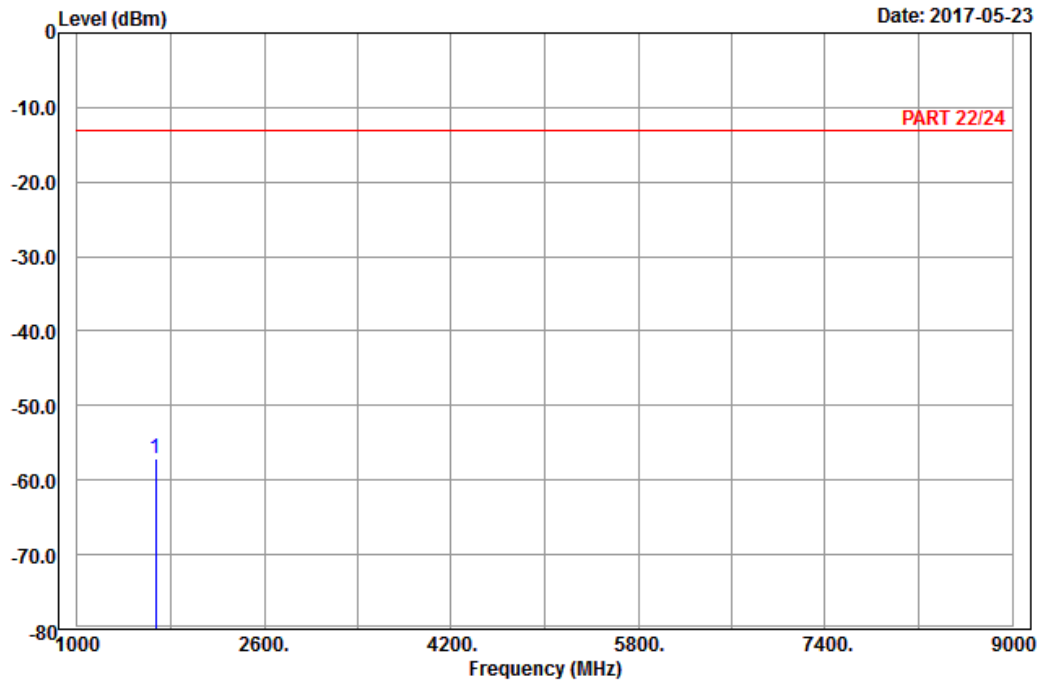

Site : 966 chamber 1
 Condition: PART 22/24 Vertical
 Remark : LTE_Band 5_Link_CH20525
 Tested by: Harry Hsueh

	Freq	Level	Read Level	Limit Line	Over Limit	Factor	Remark
	MHz	dBm	dBm	dBm	dB	dB	
1	pp 1673.00	-57.10	-65.01	-13.00	-44.10	7.91	Peak

High Channel



Bureau Veritas Consumer Products Services Ltd., Taoyuan Branch

A D T

Data: 9

Date: 2017-05-23

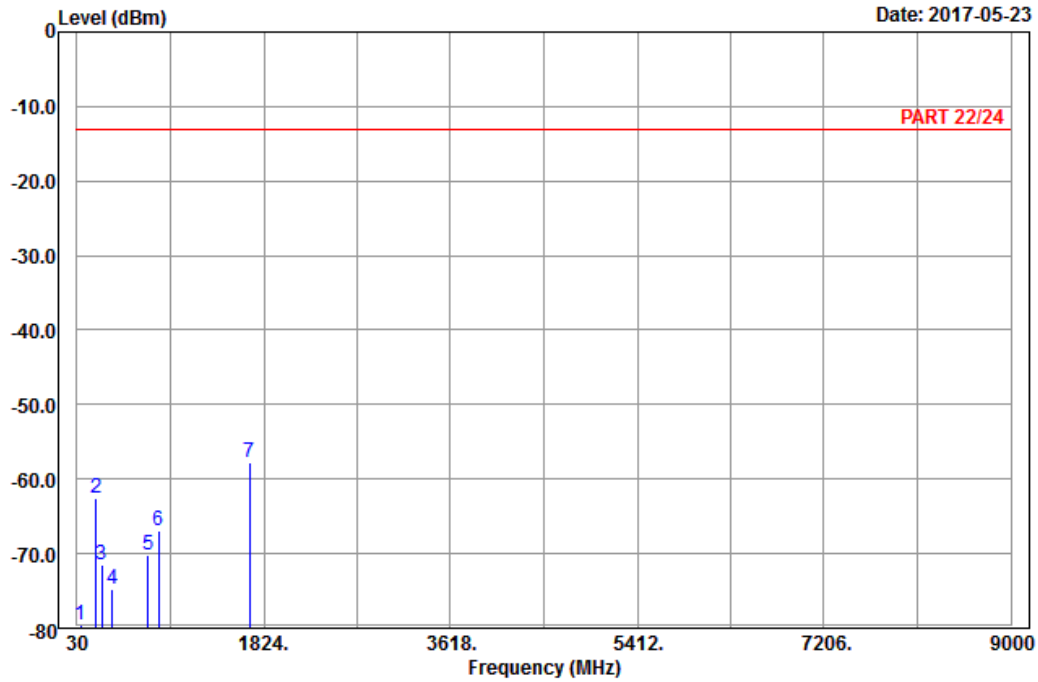

Site : 966 chamber 1
 Condition: PART 22/24 Horizontal
 Remark : LTE_Band 5_Link_CH20600
 Tested by: Harry Hsueh

	Read	Limit	Over				
Freq	Level	Level	Line	Limit	Factor	Remark	
MHz	dBm	dBm	dBm	dB	dB		
1	67.26	-79.65	-66.55	-13.00	-66.65	-13.10	Peak
2	214.95	-62.58	-56.60	-13.00	-49.58	-5.98	Peak
3	265.71	-71.47	-65.82	-13.00	-58.47	-5.65	Peak
4	366.50	-74.69	-70.19	-13.00	-61.69	-4.50	Peak
5	711.60	-70.10	-69.50	-13.00	-57.10	-0.60	Peak
6	812.40	-66.95	-68.82	-13.00	-53.95	1.87	Peak
7 pp	1688.00	-57.86	-65.88	-13.00	-44.86	8.02	Peak



Bureau Veritas Consumer Products Services Ltd., Taoyuan Branch

A D T

Data: 10

Date: 2017-05-23

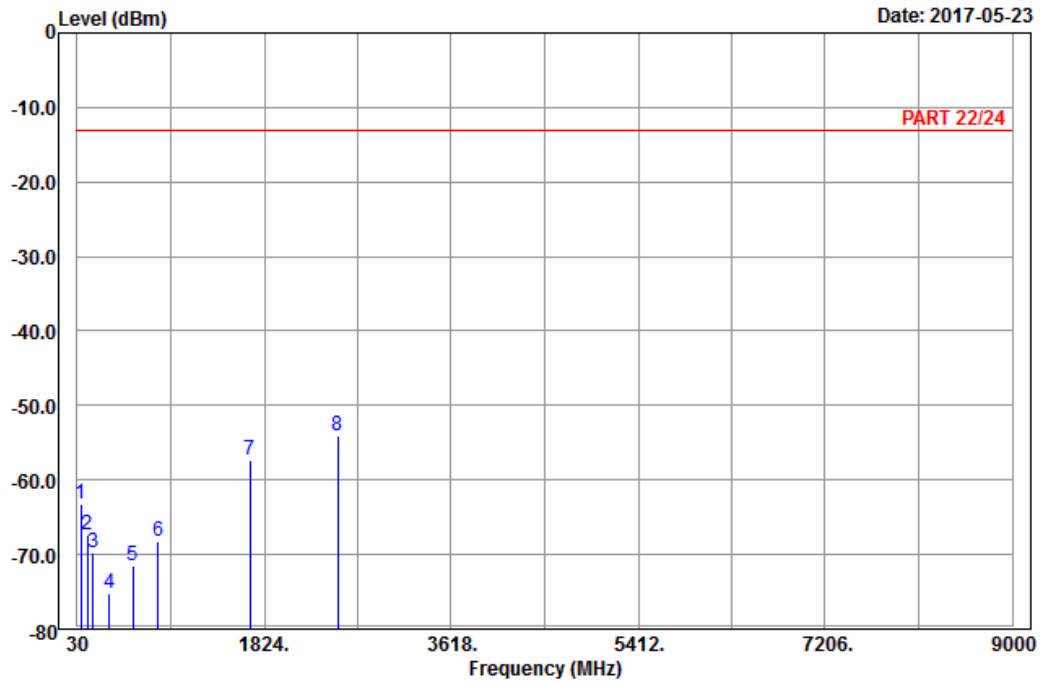

Site : 966 chamber 1
 Condition: PART 22/24 Vertical
 Remark : LTE_Band 5_Link_CH20600
 Tested by: Harry Hsueh

	Freq	Level	Read Level	Limit Line	Over Limit	Factor	Remark
	MHz	dBm	dBm	dBm	dB	dB	
1	62.40	-63.13	-49.34	-13.00	-50.13	-13.79	Peak
2	128.82	-67.37	-59.66	-13.00	-54.37	-7.71	Peak
3	185.79	-69.73	-64.06	-13.00	-56.73	-5.67	Peak
4	334.30	-75.18	-69.62	-13.00	-62.18	-5.56	Peak
5	566.00	-71.50	-70.52	-13.00	-58.50	-0.98	Peak
6	802.60	-68.34	-70.33	-13.00	-55.34	1.99	Peak
7	1688.00	-57.36	-65.38	-13.00	-44.36	8.02	Peak
8 pp	2532.00	-54.03	-65.41	-13.00	-41.03	11.38	Peak

5 Pictures of Test Arrangements

Please refer to the attached file (Test Setup Photo).

Appendix – Information on the Testing Laboratories

We, Bureau Veritas Consumer Products Services (H.K.) Ltd., Taoyuan Branch, were founded in 1988 to provide our best service in EMC, Radio, Telecom and Safety consultation. Our laboratories are accredited and approved according to ISO/IEC 17025.

If you have any comments, please feel free to contact us at the following:

Linko EMC/RF Lab

Tel: 886-2-26052180

Fax: 886-2-26051924

Hsin Chu EMC/RF/Telecom Lab

Tel: 886-3-6668565

Fax: 886-3-6668323

Hwa Ya EMC/RF/Safety

Tel: 886-3-3183232

Fax: 886-3-3270892

Email: service.adt@tw.bureauveritas.com

Web Site: www.bureauveritas-adt.com

The address and road map of all our labs can be found in our web site also.

--- END ---