

## FCC Test Report

**Report No.:** RF161228C16-6

**FCC ID:** MSQA002A

**Test Model:** ASUS\_A002A

**Received Date:** Dec. 28, 2016

**Test Date:** Jan. 08, 2017 ~ Feb. 15, 2017

**Issued Date:** Mar. 07, 2017

**Applicant:** ASUSTek COMPUTER INC.

**Address:** 4F, No. 150, LI-TE Rd., PEITOU, TAIPEI 112, TAIWAN

**Issued By:** Bureau Veritas Consumer Products Services (H.K.) Ltd., Taoyuan Branch

**Lab Address:** No. 47-2, 14th Ling, Chia Pau Vil., Lin Kou Dist., New Taipei City, Taiwan  
( R.O.C )

**Test Location (1):** No. 19, Hwa Ya 2nd Rd, Wen Hwa Tsuen, Kwei Shan Hsiang, Taoyuan  
Hsien 333, Taiwan, R.O.C.

**Test Location (2):** No.215, Sec. 3, Beixin Rd., Xindian Dist., New Taipei City 231, Taiwan,  
R.O.C



This report is for your exclusive use. Any copying or replication of this report to or for any other person or entity, or use of our name or trademark, is permitted only with our prior written permission. This report sets forth our findings solely with respect to the test samples identified herein. The results set forth in this report are not indicative or representative of the quality or characteristics of the lot from which a test sample was taken or any similar or identical product unless specifically and expressly noted. Our report includes all of the tests requested by you and the results thereof based upon the information that you provided to us. You have 60 days from date of issuance of this report to notify us of any material error or omission caused by our negligence, provided, however, that such notice shall be in writing and shall specifically address the issue you wish to raise. A failure to raise such issue within the prescribed time shall constitute your unqualified acceptance of the completeness of this report, the tests conducted and the correctness of the report contents. Unless specifically mentioned, the uncertainty of measurement has been explicitly taken into account to declare the compliance or non-compliance to the specification.

## Table of Contents

<b>Release Control Record .....</b>	<b>4</b>
<b>1 Certificate of Conformity .....</b>	<b>5</b>
<b>2 Summary of Test Results.....</b>	<b>6</b>
2.1 Measurement Uncertainty.....	6
2.2 Modification Record .....	6
<b>3 General Information .....</b>	<b>7</b>
3.1 General Description of EUT .....	7
3.2 Description of Test Modes.....	8
3.2.1 Test Mode Applicability and Tested Channel Detail.....	9
3.3 Description of Support Units .....	11
3.3.1 Configuration of System under Test .....	11
3.4 General Description of Applied Standards.....	11
<b>4 Test Types and Results .....</b>	<b>12</b>
4.1 Radiated Emission and Bandedge Measurement .....	12
4.1.1 Limits of Radiated Emission and Bandedge Measurement .....	12
4.1.2 Test Instruments .....	13
4.1.3 Test Procedures.....	14
4.1.4 Deviation from Test Standard .....	14
4.1.5 Test Set Up .....	15
4.1.6 EUT Operating Conditions.....	15
4.1.7 Test Results .....	16
4.2 Conducted Emission Measurement.....	22
4.2.1 Limits of Conducted Emission Measurement .....	22
4.2.2 Test Instruments .....	22
4.2.3 Test Procedures.....	22
4.2.4 Deviation from Test Standard .....	22
4.2.5 TEST SETUP.....	23
4.2.6 EUT Operating Conditions.....	23
4.2.7 Test Results .....	24
4.3 6 dB Bandwidth Measurement.....	28
4.3.1 Limits of 6 dB Bandwidth Measurement.....	28
4.3.2 Test Setup.....	28
4.3.3 Test Instruments .....	28
4.3.4 Test Procedure .....	28
4.3.5 Deviation from Test Standard .....	28
4.3.6 EUT Operating Conditions.....	28
4.3.7 Test Result .....	29
4.4 Conducted Output Power Measurement .....	30
4.4.1 Limits of Conducted Output Power Measurement.....	30
4.4.2 Test Setup.....	30
4.4.3 Test Instruments .....	30
4.4.4 Test Procedures.....	30
4.4.5 Deviation from Test Standard .....	30
4.4.6 EUT Operating Conditions.....	30
4.4.7 Test Results .....	30
4.5 Power Spectral Density Measurement .....	31
4.5.1 Limits of Power Spectral Density Measurement.....	31
4.5.2 Test Setup.....	31
4.5.3 Test Instruments .....	31
4.5.4 Test Procedure .....	31
4.5.5 Deviation from Test Standard .....	31
4.5.6 EUT Operating Condition .....	31
4.5.7 Test Results .....	32

4.6	Conducted Out of Band Emission Measurement .....	33
4.6.1	Limits of Conducted Out of Band Emission Measurement.....	33
4.6.2	Test Setup.....	33
4.6.3	Test Instruments .....	33
4.6.4	Test Procedure .....	33
4.6.5	Deviation from Test Standard .....	33
4.6.6	EUT Operating Condition .....	33
4.6.7	TEST RESULTS .....	34
<b>5</b>	<b>Pictures of Test Arrangements.....</b>	<b>36</b>
	<b>Appendix – Information on the Testing Laboratories .....</b>	<b>37</b>

### Release Control Record

Issue No.	Description	Date Issued
RF161228C16-6	Original Release	Mar. 07, 2017

## 1 Certificate of Conformity

**Product:** ASUS Phone

**Brand:** ASUS

**Test Model:** ASUS\_A002A

**Sample Status:** Identical Prototype

**Applicant:** ASUSTek COMPUTER INC.

**Test Date:** Jan. 08, 2017 ~ Feb. 15, 2017

**Standards:** 47 CFR FCC Part 15, Subpart C (Section 15.247)  
ANSI C63.10:2013

The above equipment has been tested by **Bureau Veritas Consumer Products Services (H.K.) Ltd., Taoyuan Branch**, and found compliance with the requirement of the above standards. The test record, data evaluation & Equipment Under Test (EUT) configurations represented herein are true and accurate accounts of the measurements of the sample's EMC characteristics under the conditions specified in this report.

**Prepared by :**  , **Date:** Mar. 07, 2017  
Ivonne Wu / Supervisor

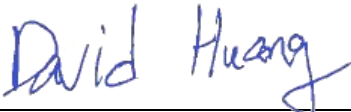
**Approved by :**  , **Date:** Mar. 07, 2017  
David Huang / Project Engineer

## 2 Summary of Test Results

47 CFR FCC Part 15, Subpart C (Section 15.247)			
FCC Clause	Test Item	Result	Remarks
15.207	AC Power Conducted Emission	Pass	Meet the requirement of limit. Minimum passing margin is -10.55 dB at 0.15000 MHz.
15.205 & 209	Radiated Emissions	Pass	Meet the requirement of limit. Minimum passing margin is -7.84 dB at 30.81 MHz.
15.247(d)	Band Edge Measurement	Pass	Meet the requirement of limit.
15.247(d)	Antenna Port Emission	Pass	Meet the requirement of limit.
15.247(a)(2)	6 dB Bandwidth	Pass	Meet the requirement of limit.
15.247(b)	Conducted power	Pass	Meet the requirement of limit.
15.247(e)	Power Spectral Density	Pass	Meet the requirement of limit.
15.203	Antenna Requirement	Pass	No antenna connector is used.

### 2.1 Measurement Uncertainty

Where relevant, the following measurement uncertainty levels have been estimated for tests performed on the EUT:

The listed uncertainties are the worst case uncertainty for the entire range of measurement. Please note that the uncertainty values are provided for informational purposes only and are not used in determining the PASS/FAIL results.

Measurement	Frequency	Expanded Uncertainty (k=2) ( $\pm$ )
Conducted Emissions at mains ports	150 kHz ~ 30 MHz	2.44 dB
Radiated Emissions up to 1 GHz	30 MHz ~ 200 MHz	2.0153 dB
	200 MHz ~ 1000 MHz	2.0224 dB
Radiated Emissions above 1 GHz	1 GHz ~ 18 GHz	1.0121 dB
	18 GHz ~ 40 GHz	1.1508 dB

### 2.2 Modification Record

There were no modifications required for compliance.

### 3 General Information

#### 3.1 General Description of EUT

<b>Product</b>	ASUS Phone
<b>Brand</b>	ASUS
<b>Test Model</b>	ASUS_A002A
<b>Status of EUT</b>	Identical Prototype
<b>Power Supply Rating</b>	3.85 Vdc (Li-ion battery) 5.0 Vdc or 9.0 Vdc (Adapter) 5.0 Vdc (Host equipment)
<b>Modulation Type</b>	GFSK
<b>Transfer Rate</b>	1 Mbps
<b>Operating Frequency</b>	2402 ~ 2480 MHz
<b>Number of Channel</b>	40
<b>Output Power</b>	0.6546 mW
<b>Antenna Type</b>	PCB antenna with -0.67 dBi gain
<b>Antenna Connector</b>	N/A
<b>Accessory Device</b>	Refer to Note as below
<b>Data Cable Supplied</b>	Refer to Note as below

Note:

1. There're 2 configurations for the EUT listed as below.

Sample	Description
A	EUT + Rear Camera 1 + TOF Camera 2 + UFS 3 + DDR 1 + Finger Print 2
B	EUT + Rear Camera 2 + TOF Camera 1 + UFS 5 + DDR 3 + Finger Print 1

\* Only the worst test data was presented in the report.

2. The EUT's accessories list refers to Ext. Pho.
3. The above EUT information is declared by manufacturer and for more detailed features description, please refer to the manufacturer's specifications or User's Manual.

### 3.2 Description of Test Modes

40 channels are provided to this EUT:

Channel	Freq. (MHz)	Channel	Freq. (MHz)	Channel	Freq. (MHz)	Channel	Freq. (MHz)
0	2402	10	2422	20	2442	30	2462
1	2404	11	2424	21	2444	31	2464
2	2406	12	2426	22	2446	32	2466
3	2408	13	2428	23	2448	33	2468
4	2410	14	2430	24	2450	34	2470
5	2412	15	2432	25	2452	35	2472
6	2414	16	2434	26	2454	36	2474
7	2416	17	2436	27	2456	37	2476
8	2418	18	2438	28	2458	38	2478
9	2420	19	2440	29	2460	39	2480



### 3.2.1 Test Mode Applicability and Tested Channel Detail

EUT Configure Mode	Applicable To				Description
	RE $\geq$ 1G	RE<1G	PLC	APCM	
A	√	√	√	√	Sample A
B	√	√	√	-	Sample B

Where **RE $\geq$ 1G**: Radiated Emission above 1 GHz      **RE<1G**: Radiated Emission below 1 GHz  
**PLC**: Power Line Conducted Emission      **APCM**: Antenna Port Conducted Measurement

**Note:** The EUT had been pre-tested on the positioned of each 3 axis. The worst case was found when positioned on **Z-plane** for mode A and **X-plane** for mode B.

**Note:** “-” means no effect.

#### **Radiated Emission Test (Above 1 GHz):**

- Pre-Scan has been conducted to determine the worst-case mode from all possible combinations between available modulations, data rates and antenna ports (if EUT with antenna diversity architecture).
- Following channel(s) was (were) selected for the final test as listed below.

EUT Configure Mode	Available Channel	Tested Channel	Modulation Type	Data Rate (Mbps)
A	0 to 39	0, 19, 39	GFSK	1
B	0 to 39	19	GFSK	1

#### **Radiated Emission Test (Below 1 GHz):**

- Pre-Scan has been conducted to determine the worst-case mode from all possible combinations between available modulations, data rates and antenna ports (if EUT with antenna diversity architecture).
- Following channel(s) was (were) selected for the final test as listed below.

EUT Configure Mode	Available Channel	Tested Channel	Modulation Type	Data Rate (Mbps)
A, B	0 to 39	19	GFSK	1

#### **Power Line Conducted Emission Test:**

- Pre-Scan has been conducted to determine the worst-case mode from all possible combinations between available modulations, data rates and antenna ports (if EUT with antenna diversity architecture).
- Following channel(s) was (were) selected for the final test as listed below.

EUT Configure Mode	Available Channel	Tested Channel	Modulation Type	Data Rate (Mbps)
A, B	0 to 39	19	GFSK	1

**Antenna Port Conducted Measurement:**

- This item includes all test value of each mode, but only includes spectrum plot of worst value of each mode.
- Pre-Scan has been conducted to determine the worst-case mode from all possible combinations between available modulations, data rates and antenna ports (if EUT with antenna diversity architecture).
- Following channel(s) was (were) selected for the final test as listed below.

EUT Configure Mode	Available Channel	Tested Channel	Modulation Type	Data Rate (Mbps)
A	0 to 39	0, 19, 39	GFSK	1

**Test Condition:**

Applicable To	Environmental Conditions	Input Power	Tested by
RE $\geq$ 1G	25 deg. C, 65 % RH	120 Vac, 60 Hz	Charles Hsiao
RE $<$ 1G	25 deg. C, 65 % RH	120 Vac, 60 Hz	Charles Hsiao
PLC	25 deg. C, 65 % RH	120 Vac, 60 Hz	Toby Tian
APCM	25 deg. C, 65 % RH	3.85 Vdc	Wayne Lin

### 3.3 Description of Support Units

The EUT has been tested as an independent unit together with other necessary accessories or support units.

#### 3.3.1 Configuration of System under Test

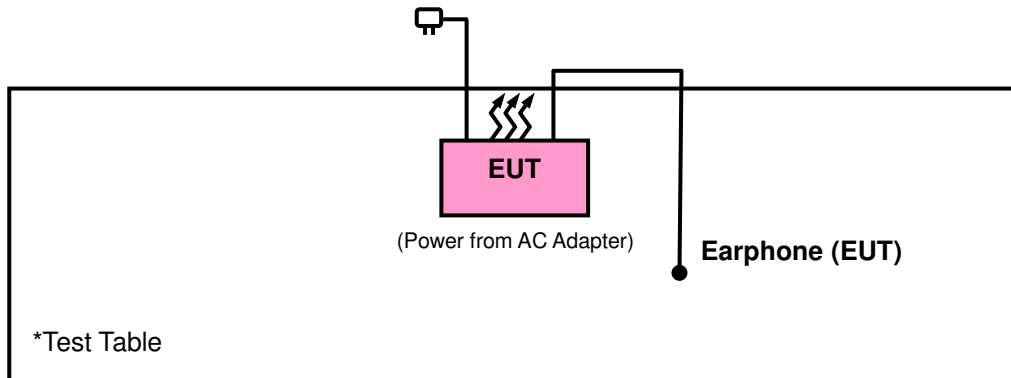

### 3.4 General Description of Applied Standards

The EUT is a RF Product. According to the specifications of the manufacturer, it must comply with the requirements of the following standards:

**FCC Part 15, Subpart C (15.247)**

**558074 D01 DTS Meas Guidance v03r05**

ANSI C63.10-2013

All test items have been performed and recorded as per the above standards.

**Note:** The EUT has been verified to comply with the requirements of FCC Part 15, Subpart B, Class B (DoC).  
The test report has been issued separately.

## 4 Test Types and Results

### 4.1 Radiated Emission and Bandedge Measurement

#### 4.1.1 Limits of Radiated Emission and Bandedge Measurement

Radiated emissions which fall in the restricted bands must comply with the radiated emission limits specified as below table. Other emissions shall be at least 20 dB below the highest level of the desired power:

Frequencies (MHz)	Field Strength (microvolts/meter)	Measurement Distance (meters)
0.009 ~ 0.490	2400/F (kHz)	300
0.490 ~ 1.705	24000/F (kHz)	30
1.705 ~ 30.0	30	30
30 ~ 88	100	3
88 ~ 216	150	3
216 ~ 960	200	3
Above 960	500	3

**Note:**

1. The lower limit shall apply at the transition frequencies.
2. Emission level (dBuV/m) = 20 log Emission level (uV/m).
3. For frequencies above 1000 MHz, the field strength limits are based on average detector, however, the peak field strength of any emission shall not exceed the maximum permitted average limits, specified above by more than 20 dB under any condition of modulation.

## 4.1.2 Test Instruments

Description & Manufacturer	Model No.	Serial No.	Date of Calibration	Due Date of Calibration
Test Receiver Agilent Technologies	N9038A	MY52260177	Jun. 21, 2016	Jun. 20, 2017
Spectrum Analyzer ROHDE & SCHWARZ	F5U43	101261	Dec. 13, 2016	Dec. 12, 2017
BILOG Antenna SCHWARZBECK	VULB9168	9168-472	Dec. 16, 2016	Dec. 15, 2017
HORN Antenna ETS-Lindgren	3117	00143293	Dec. 29, 2016	Dec. 28, 2017
HORN Antenna SCHWARZBECK	BBHA 9170	9170-480	Dec. 14, 2016	Dec. 13, 2017
Fixed Attenuator Mini-Circuits	BW-N10W5+	NA	Jul. 08, 2016	Jul. 07, 2017
Bluetooth Tester	CBT	100980	Apr. 27, 2015	Apr. 26, 2017
Loop Antenna	EM-6879	269	Aug. 11, 2016	Aug. 10, 2017
Preamplifier Agilent	310N	187226	Jun. 24, 2016	Jun. 23, 2017
Preamplifier Agilent	83017A	MY39501357	Jun. 24, 2016	Jun. 23, 2017
Power Meter Anritsu	ML2495A	1232002	Sep. 08, 2016	Sep. 07, 2017
Power Sensor Anritsu	MA2411B	1207325	Sep. 08, 2016	Sep. 07, 2017
RF signal cable ETS-LINDGREN	5D-FB	Cable-CH1-01(R FC-SMS-100-SM S-120+RFC-SMS -100-SMS-400)	Jun. 24, 2016	Jun. 23, 2017
RF signal cable ETS-LINDGREN	8D-FB	Cable-CH1-02(R FC-SMS-100-SM S-24)	Jun. 24, 2016	Jun. 23, 2017
Software BV ADT	E3 8.130425b	NA	NA	NA
Antenna Tower MF	NA	NA	NA	NA
Turn Table MF	NA	NA	NA	NA
Antenna Tower & Turn Table Controller MF	MF-7802	NA	NA	NA

- Note: 1. The calibration interval of the above test instruments is 12 months and the calibrations are traceable to NML/ROC and NIST/USA.
2. The test was performed in HsinTien Chamber 1.
3. The horn antenna and preamplifier (model: 83017A) are used only for the measurement of emission frequency above 1GHz if tested.
4. The FCC Site Registration No. is 149147.
5. The IC Site Registration No. is IC7450I-1.

#### 4.1.3 Test Procedures

- a. The EUT was placed on the top of a rotating table 0.8 meters (for below 1 GHz) / 1.5 meters (for above 1 GHz) above the ground at 3 meter chamber room for test. The table was rotated 360 degrees to determine the position of the highest radiation.
- b. The EUT was set 3 meters away from the interference-receiving antenna, which was mounted on the top of a variable-height antenna tower.
- c. The height of antenna is varied from one meter to four meters above the ground to determine the maximum value of the field strength. Both horizontal and vertical polarizations of the antenna are set to make the measurement.
- d. For each suspected emission, the EUT was arranged to its worst case and then the antenna was tuned to heights from 1 meter to 4 meters and the rotatable table was turned from 0 degrees to 360 degrees to find the maximum reading.
- e. The test-receiver system was set to quasi-peak detect function and specified bandwidth with maximum hold mode when the test frequency is below 1 GHz.
- f. The test-receiver system was set to peak and average detected function and specified bandwidth with maximum hold mode when the test frequency is above 1 GHz. If the peak reading value also meets average limit, measurement with the average detector is unnecessary.

**Note:**

1. The resolution bandwidth and video bandwidth of test receiver/spectrum analyzer is 120 kHz & 360 kHz for Quasi-peak detection (QP) at frequency below 1 GHz.
2. The resolution bandwidth of test receiver/spectrum analyzer is 1 MHz and the video bandwidth is 3 MHz for Peak detection (PK) at frequency above 1 GHz.
3. The resolution bandwidth of test receiver/spectrum analyzer is 1 MHz and the video bandwidth is 1/T for RMS Average (Duty cycle < 98 %) for Peak detection at frequency above 1 GHz.
4. The resolution bandwidth of test receiver/spectrum analyzer is 1 MHz and the video bandwidth is 10 Hz (Duty cycle ≥ 98 %) for Average detection (AV) at frequency above 1 GHz.
5. All modes of operation were investigated and the worst-case emissions are reported.

#### 4.1.4 Deviation from Test Standard

No deviation.

#### 4.1.5 Test Set Up

##### <Frequency Range below 1 GHz>

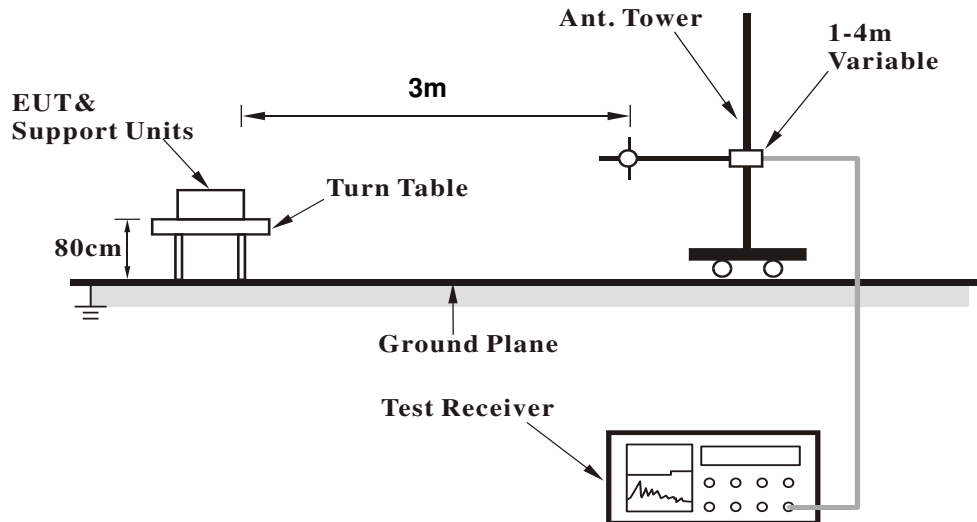

##### <Frequency Range above 1 GHz>

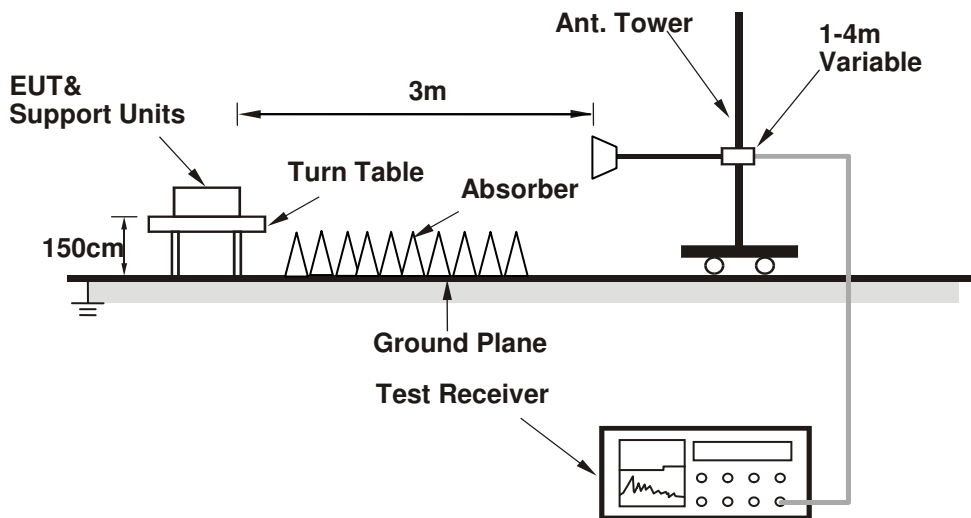

For the actual test configuration, please refer to the attached file (Test Setup Photo).

#### 4.1.6 EUT Operating Conditions

- a. Placed the EUT on the testing table.
- b. Set the EUT under transmission condition continuously at specific channel frequency.

4.1.7 Test Results

**ABOVE 1 GHz DATA :**

**Mode A**

EUT Test Condition		Measurement Detail	
Channel	Channel 0	Frequency Range	1 GHz ~ 25 GHz
Input Power	120 Vac, 60 Hz	Detector Function	Peak (PK) Average (AV)
Environmental Conditions	25 deg. C, 65 % RH	Tested By	Charles Hsiao

Antennal Polarity & Test Distance: Horizontal at 3 m										
Frequency (MHz)	Emission Level (dBuV/m)	Read Level (dBuV)	Limit (dBuV/m)	Margin (dB)	Antenna Factor (dB/m)	Cable Loss (dB)	Preamp Factor (dB)	Antenna Height (cm)	Table Angle (Degree)	Remark
2369.04	41.35	39.69	54	-12.65	31.78	5.37	35.49	102	11	Average
2370.03	51.54	49.88	74	-22.46	31.78	5.37	35.49	102	11	Peak
2402	90	88.27			31.8	5.4	35.47	102	11	Average
2402	90.95	89.22			31.8	5.4	35.47	102	11	Peak
4804	39.38	31.29	54	-14.62	33.96	8.25	34.12	155	107	Average
4804	48.44	40.35	74	-25.56	33.96	8.25	34.12	155	107	Peak

Antennal Polarity & Test Distance: Vertical at 3 m										
Frequency (MHz)	Emission Level (dBuV/m)	Read Level (dBuV)	Limit (dBuV/m)	Margin (dB)	Antenna Factor (dB/m)	Cable Loss (dB)	Preamp Factor (dB)	Antenna Height (cm)	Table Angle (Degree)	Remark
2328.72	51.47	49.93	74	-22.53	31.73	5.33	35.52	154	96	Peak
2363.37	41.36	39.73	54	-12.64	31.76	5.37	35.5	154	96	Average
2402	86.63	84.9			31.8	5.4	35.47	154	96	Average
2402	87.73	86			31.8	5.4	35.47	154	96	Peak
4804	39.24	31.15	54	-14.76	33.96	8.25	34.12	129	174	Average
4804	48.35	40.26	74	-25.65	33.96	8.25	34.12	129	174	Peak

Remarks:

- Emission Level = Read Level + Antenna Factor + Cable Loss - Preamp Factor  
Margin value = Emission level – Limit value
- 2402 MHz: Fundamental frequency.



EUT Test Condition		Measurement Detail	
Channel	Channel 19	Frequency Range	1 GHz ~ 25 GHz
Input Power	120 Vac, 60 Hz	Detector Function	Peak (PK) Average (AV)
Environmental Conditions	25 deg. C, 65 % RH	Tested By	Charles Hsiao

Antennal Polarity & Test Distance: Horizontal at 3 m										
Frequency (MHz)	Emission Level (dBuV/m)	Read Level (dBuV)	Limit (dBuV/m)	Margin (dB)	Antenna Factor (dB/m)	Cable Loss (dB)	Preamp Factor (dB)	Antenna Height (cm)	Table Angle (Degree)	Remark
2368.77	52.26	50.6	74	-21.74	31.78	5.37	35.49	102	11	Peak
2385.87	41.25	39.54	54	-12.75	31.8	5.4	35.49	102	11	Average
2440	91.24	89.39			31.85	5.46	35.46	102	11	Average
2440	92.14	90.29			31.85	5.46	35.46	102	11	Peak
2492.76	52.32	50.3	74	-21.68	31.9	5.53	35.41	102	11	Peak
2494.08	41.66	39.64	54	-12.34	31.9	5.53	35.41	102	11	Average
Antennal Polarity & Test Distance: Vertical at 3 m										
Frequency (MHz)	Emission Level (dBuV/m)	Read Level (dBuV)	Limit (dBuV/m)	Margin (dB)	Antenna Factor (dB/m)	Cable Loss (dB)	Preamp Factor (dB)	Antenna Height (cm)	Table Angle (Degree)	Remark
2310.18	51.65	50.17	74	-22.35	31.71	5.3	35.53	154	96	Peak
2378.22	41.17	39.51	54	-12.83	31.78	5.37	35.49	154	96	Average
2440	87.44	85.59			31.85	5.46	35.46	154	96	Average
2440	88.46	86.61			31.85	5.46	35.46	154	96	Peak
2484.76	41.99	40	54	-12.01	31.88	5.53	35.42	154	96	Average
2485.12	52.13	50.14	74	-21.87	31.88	5.53	35.42	154	96	Peak

Remarks:

- Emission Level = Read Level + Antenna Factor + Cable Loss - Preamp Factor  
Margin value = Emission level – Limit value
- 2440 MHz: Fundamental frequency.

EUT Test Condition		Measurement Detail	
Channel	Channel 39	Frequency Range	1 GHz ~ 25 GHz
Input Power	120 Vac, 60 Hz	Detector Function	Peak (PK) Average (AV)
Environmental Conditions	25 deg. C, 65 % RH	Tested By	Charles Hsiao

Antennal Polarity & Test Distance: Horizontal at 3 m										
Frequency (MHz)	Emission Level (dBuV/m)	Read Level (dBuV)	Limit (dBuV/m)	Margin (dB)	Antenna Factor (dB/m)	Cable Loss (dB)	Preamp Factor (dB)	Antenna Height (cm)	Table Angle (Degree)	Remark
2480	89.84	87.88			31.88	5.5	35.42	102	11	Average
2480	90.8	88.84			31.88	5.5	35.42	102	11	Peak
2494.96	52.34	50.32	74	-21.66	31.9	5.53	35.41	102	11	Peak
2499.8	41.64	39.62	54	-12.36	31.9	5.53	35.41	102	11	Average
4960	39.19	30.92	74	-34.81	33.99	8.29	34.01	155	64	Average
4960	48.16	39.89	74	-25.84	33.99	8.29	34.01	155	64	Peak
Antennal Polarity & Test Distance: Vertical at 3 m										
Frequency (MHz)	Emission Level (dBuV/m)	Read Level (dBuV)	Limit (dBuV/m)	Margin (dB)	Antenna Factor (dB/m)	Cable Loss (dB)	Preamp Factor (dB)	Antenna Height (cm)	Table Angle (Degree)	Remark
2480	86.65	84.69			31.88	5.5	35.42	154	96	Average
2480	87.7	85.74			31.88	5.5	35.42	154	96	Peak
2492.04	51.99	49.97	74	-22.01	31.9	5.53	35.41	154	96	Peak
2498.12	41.83	39.81	54	-12.17	31.9	5.53	35.41	154	96	Average
4960	39.36	31.09	74	-34.64	33.99	8.29	34.01	148	161	Average
4960	48.68	40.41	74	-25.32	33.99	8.29	34.01	148	161	Peak

Remarks:

- Emission Level = Read Level + Antenna Factor + Cable Loss - Preamp Factor  
Margin value = Emission level – Limit value
- 2480 MHz: Fundamental frequency.

**Mode B**

EUT Test Condition		Measurement Detail	
Channel	Channel 19	Frequency Range	1 GHz ~ 25 GHz
Input Power	120 Vac, 60 Hz	Detector Function	Peak (PK) Average (AV)
Environmental Conditions	25 deg. C, 65 % RH	Tested By	Charles Hsiao

Antennal Polarity & Test Distance: Horizontal at 3 m										
Frequency (MHz)	Emission Level (dBuV/m)	Read Level (dBuV)	Limit (dBuV/m)	Margin (dB)	Antenna Factor (dB/m)	Cable Loss (dB)	Preamp Factor (dB)	Antenna Height (cm)	Table Angle (Degree)	Remark
2381.55	51.62	49.93	74	-22.38	31.78	5.4	35.49	104	157	Peak
2384.16	40.92	39.23	54	-13.08	31.78	5.4	35.49	104	157	Average
2440	91.48	89.63			31.85	5.46	35.46	104	157	Average
2440	92.22	90.37			31.85	5.46	35.46	104	157	Peak
2491.12	51.76	49.75	74	-22.24	31.9	5.53	35.42	104	157	Peak
2497.68	41.47	39.45	54	-12.53	31.9	5.53	35.41	104	157	Average

Antennal Polarity & Test Distance: Vertical at 3 m										
Frequency (MHz)	Emission Level (dBuV/m)	Read Level (dBuV)	Limit (dBuV/m)	Margin (dB)	Antenna Factor (dB/m)	Cable Loss (dB)	Preamp Factor (dB)	Antenna Height (cm)	Table Angle (Degree)	Remark
2370.3	51.68	50.02	74	-22.32	31.78	5.37	35.49	100	37	Peak
2388.39	41.19	39.48	54	-12.81	31.8	5.4	35.49	100	37	Average
2440	87.52	85.67			31.85	5.46	35.46	100	37	Average
2440	88.16	86.31			31.85	5.46	35.46	100	37	Peak
2493.8	52.22	50.2	74	-21.78	31.9	5.53	35.41	100	37	Peak
2493.92	41.49	39.47	54	-12.51	31.9	5.53	35.41	100	37	Average

Remarks:

- Emission Level = Read Level + Antenna Factor + Cable Loss - Preamp Factor  
Margin value = Emission level – Limit value
- 2440 MHz: Fundamental frequency.

**9 kHz ~ 30 MHz DATA:**

The amplitude of spurious emissions attenuated more than 20 dB below the permissible value is not required to be report.

**30 MHz ~ 1 GHz WORST-CASE DATA:**

**Mode A**

EUT Test Condition		Measurement Detail	
Channel	Channel 19	Frequency Range	30 MHz ~ 1 GHz
Input Power	120 Vac, 60 Hz	Detector Function	Peak (PK) Quasi-peak (QP)
Environmental Conditions	25 deg. C, 65 % RH	Tested By	Charles Hsiao

Antennal Polarity & Test Distance: Horizontal at 3 m										
Frequency (MHz)	Emission Level (dBuV/m)	Read Level (dBuV)	Limit (dBuV/m)	Margin (dB)	Antenna Factor (dB/m)	Cable Loss (dB)	Preamp Factor (dB)	Antenna Height (cm)	Table Angle (Degree)	Remark
85.89	28.96	51.05	40	-11.04	8.71	1.11	31.91	111	128	Peak
138	29.19	50.79	43.5	-14.31	9.28	1.38	32.26	192	349	Peak
200.1	26.19	45.94	43.5	-17.31	10.9	1.65	32.3	180	187	Peak
479.9	20.38	31.02	46	-25.62	18.92	2.56	32.12	179	99	Peak
588.4	21.38	30.1	46	-24.62	20.6	2.87	32.19	150	213	Peak
801.2	25.76	29.89	46	-20.24	24.6	3.32	32.05	145	77	Peak
Antennal Polarity & Test Distance: Vertical at 3 m										
Frequency (MHz)	Emission Level (dBuV/m)	Read Level (dBuV)	Limit (dBuV/m)	Margin (dB)	Antenna Factor (dB/m)	Cable Loss (dB)	Preamp Factor (dB)	Antenna Height (cm)	Table Angle (Degree)	Remark
30.81	32.16	46.49	40	-7.84	17.19	0.74	32.26	170	76	Peak
86.43	31.32	53.39	40	-8.68	8.73	1.11	31.91	145	223	Peak
136.92	20.77	42.38	43.5	-22.73	9.27	1.38	32.26	190	88	Peak
524.7	22.45	31.2	46	-23.55	20.7	2.7	32.15	187	144	Peak
672.4	24.99	30.66	46	-21.01	23.4	3.05	32.12	134	234	Peak
863.5	26.22	30.09	46	-19.78	24.4	3.44	31.71	153	154	Peak

Remarks:

- Emission Level = Read Level + Antenna Factor + Cable Loss - Preamp Factor  
Margin value = Emission level – Limit value

**Mode B**

EUT Test Condition		Measurement Detail	
Channel	Channel 19	Frequency Range	30 MHz ~ 1 GHz
Input Power	120 Vac, 60 Hz	Detector Function	Peak (PK) Quasi-peak (QP)
Environmental Conditions	25 deg. C, 65 % RH	Tested By	Charles Hsiao

Antennal Polarity & Test Distance: Horizontal at 3 m										
Frequency (MHz)	Emission Level (dBuV/m)	Read Level (dBuV)	Limit (dBuV/m)	Margin (dB)	Antenna Factor (dB/m)	Cable Loss (dB)	Preamp Factor (dB)	Antenna Height (cm)	Table Angle (Degree)	Remark
88.86	27.51	49.31	43.5	-15.99	8.85	1.11	31.76	166	125	Peak
139.62	27.56	49.15	43.5	-15.94	9.3	1.38	32.27	111	214	Peak
201.72	24.07	43.72	43.5	-19.43	10.99	1.65	32.29	159	148	Peak
484.8	18.39	28.93	46	-27.61	18.94	2.63	32.11	136	155	Peak
594.7	19.38	27.85	46	-26.62	20.85	2.87	32.19	158	195	Peak
804.7	24.13	28.46	46	-21.87	24.38	3.32	32.03	115	195	Peak
Antennal Polarity & Test Distance: Vertical at 3 m										
Frequency (MHz)	Emission Level (dBuV/m)	Read Level (dBuV)	Limit (dBuV/m)	Margin (dB)	Antenna Factor (dB/m)	Cable Loss (dB)	Preamp Factor (dB)	Antenna Height (cm)	Table Angle (Degree)	Remark
32.43	23.82	39.37	40	-16.18	15.96	0.74	32.25	159	165	Peak
89.13	29.16	50.96	43.5	-14.34	8.85	1.11	31.76	105	188	Peak
140.97	17.84	39.31	43.5	-25.66	9.42	1.38	32.27	125	135	Peak
531.7	21.17	30.06	46	-24.83	20.57	2.7	32.16	118	115	Peak
680.8	23.03	28.78	46	-22.97	23.31	3.05	32.11	196	172	Peak
867	24.4	28.25	46	-21.6	24.4	3.44	31.69	103	219	Peak

Remarks:

- Emission Level = Read Level + Antenna Factor + Cable Loss - Preamp Factor  
Margin value = Emission level – Limit value

## 4.2 Conducted Emission Measurement

### 4.2.1 Limits of Conducted Emission Measurement

Frequency (MHz)	Conducted Limit (dBuV)	
	Quasi-peak	Average
0.15 - 0.5	66 - 56	56 - 46
0.50 - 5.0	56	46
5.0 - 30.0	60	50

### 4.2.2 Test Instruments

Description & Manufacturer	Model No.	Serial No.	Date Of Calibration	Due Date Of Calibration
Test Receiver ROHDE & SCHWARZ	ESCI	100613	Nov. 21, 2016	Nov. 20, 2017
RF signal cable (with 10dB PAD) Woken	5D-FB	Cable-cond1-01	Dec. 22, 2016	Dec. 21, 2017
LISN ROHDE & SCHWARZ (EUT)	ESH3-Z5	835239/001	Feb. 26, 2016	Feb. 25, 2017
LISN ROHDE & SCHWARZ (Peripheral)	ESH3-Z5	100311	Jul. 28, 2016	Jul. 27, 2017
Software ADT	BV ADT_Cond_ V7.3.7.3	NA	NA	NA

- Note: 1. The calibration interval of the above test instruments is 12 months and the calibrations are traceable to NML/ROC and NIST/USA.  
 2. The test was performed in HwaYa Shielded Room 1.  
 3. The VCCI Site Registration No. is C-2040.

### 4.2.3 Test Procedures

- The EUT was placed 0.4 meters from the conducting wall of the shielded room with EUT being connected to the power mains through a line impedance stabilization network (LISN). Other support units were connected to the power mains through another LISN. The two LISNs provide 50 ohm/50 uH of coupling impedance for the measuring instrument.
- Both lines of the power mains connected to the EUT were checked for maximum conducted interference.
- The frequency range from 150 kHz to 30 MHz was searched. Emission levels under (Limit – 20 dB) was not recorded.

**Note:** All modes of operation were investigated and the worst-case emissions are reported.

### 4.2.4 Deviation from Test Standard

No deviation.

#### 4.2.5 TEST SETUP

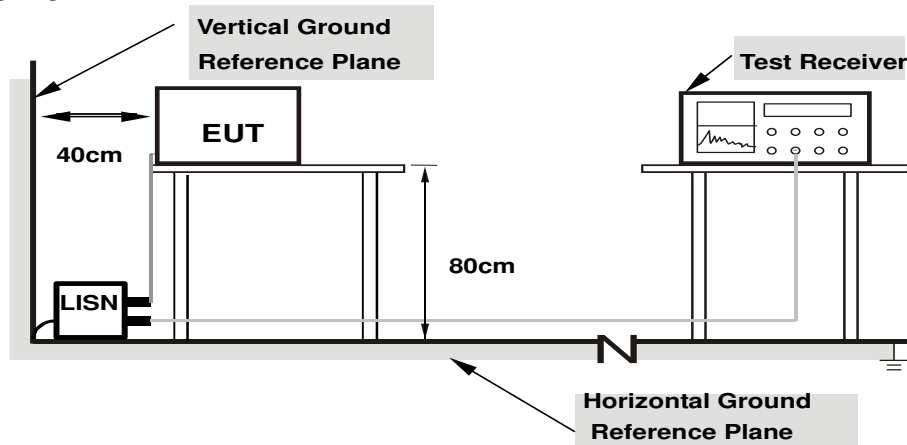

**Note: 1.Support units were connected to second LISN.**

**2.Both of LISNs (AMN) are 80 cm from EUT and at least 80 from other units and other metal planes**

#### 4.2.6 EUT Operating Conditions

- a. Placed the EUT on the testing table.
- b. Set the EUT under transmission condition continuously at specific channel frequency.

#### 4.2.7 Test Results

##### Mode A

Frequency Range	150kHz ~ 30MHz	Detector Function & Resolution Bandwidth	Quasi-Peak (QP) / Average (AV), 9kHz
Input Power	120Vac, 60Hz	Environmental Conditions	25°C, 65%RH
Tested by	Toby Tian	Test Date	2017/1/8

Phase Of Power : Line (L)										
No	Frequency (MHz)	Correction Factor (dB)	Reading Value (dBuV)		Emission Level (dBuV)		Limit (dBuV)		Margin (dB)	
			Q.P.	AV.	Q.P.	AV.	Q.P.	AV.	Q.P.	AV.
1	0.15391	10.12	41.33	28.24	51.45	38.36	65.79	55.79	-14.34	-17.43
2	0.16569	10.12	37.01	24.24	47.13	34.36	65.17	55.17	-18.04	-20.81
3	0.19510	10.14	34.77	23.44	44.91	33.58	63.82	53.82	-18.91	-20.24
4	0.23602	10.15	28.18	17.72	38.33	27.87	62.24	52.24	-23.91	-24.37
5	0.54518	10.17	20.11	16.27	30.28	26.44	56.00	46.00	-25.72	-19.56
6	4.59176	10.40	17.60	11.89	28.00	22.29	56.00	46.00	-28.00	-23.71

##### Remarks:

1. Q.P. and AV. are abbreviations of quasi-peak and average individually.
2. The emission levels of other frequencies were very low against the limit.
3. Margin value = Emission level – Limit value
4. Correction factor = Insertion loss + Cable loss
5. Emission Level = Correction Factor + Reading Value

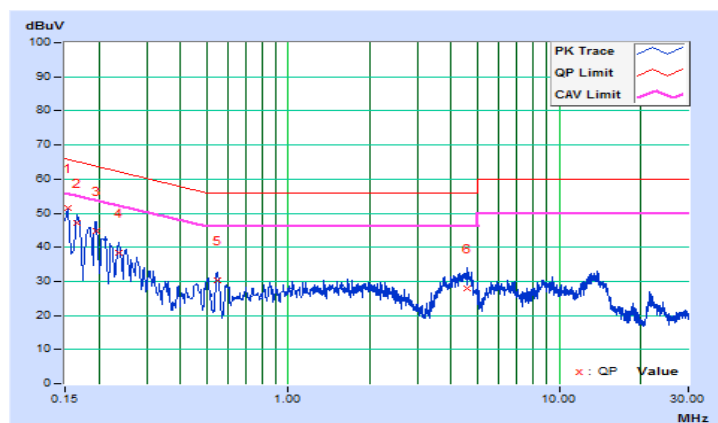



Frequency Range	150kHz ~ 30MHz	Detector Function & Resolution Bandwidth	Quasi-Peak (QP) / Average (AV), 9kHz
Input Power	120Vac, 60Hz	Environmental Conditions	25°C, 65%RH
Tested by	Toby Tian	Test Date	2017/1/8

Phase Of Power : Neutral (N)										
No	Frequency (MHz)	Correction Factor (dB)	Reading Value (dBuV)		Emission Level (dBuV)		Limit (dBuV)		Margin (dB)	
			Q.P.	AV.	Q.P.	AV.	Q.P.	AV.	Q.P.	AV.
1	0.15719	10.13	44.24	30.54	54.37	40.67	65.61	55.61	-11.24	-14.94
2	0.20893	10.15	36.35	24.67	46.50	34.82	63.25	53.25	-16.75	-18.43
3	0.28214	10.16	25.56	16.13	35.72	26.29	60.75	50.75	-25.03	-24.46
4	0.53663	10.18	20.08	14.74	30.26	24.92	56.00	46.00	-25.74	-21.08
5	4.47055	10.42	23.07	17.76	33.49	28.18	56.00	46.00	-22.51	-17.82
6	14.25337	11.10	21.08	15.91	32.18	27.01	60.00	50.00	-27.82	-22.99

Remarks:

1. Q.P. and AV. are abbreviations of quasi-peak and average individually.
2. The emission levels of other frequencies were very low against the limit.
3. Margin value = Emission level – Limit value
4. Correction factor = Insertion loss + Cable loss
5. Emission Level = Correction Factor + Reading Value

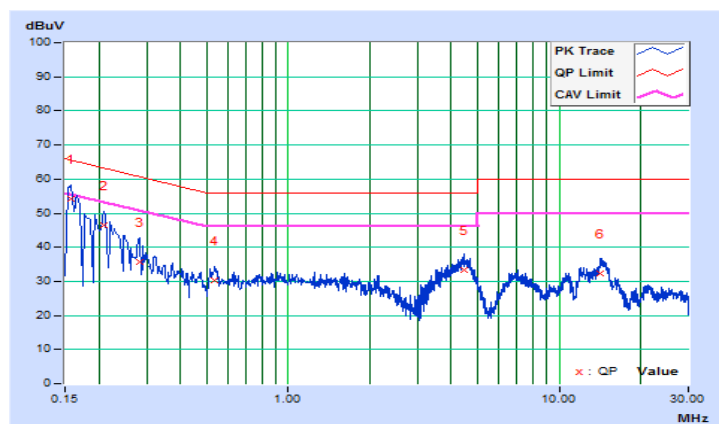

**Mode B**

Frequency Range	150kHz ~ 30MHz	Detector Function & Resolution Bandwidth	Quasi-Peak (QP) / Average (AV), 9kHz
Input Power	120Vac, 60Hz	Environmental Conditions	25°C, 65%RH
Tested by	Toby Tian	Test Date	2017/2/10

Phase Of Power : Line (L)										
No	Frequency (MHz)	Correction Factor (dB)	Reading Value (dBuV)		Emission Level (dBuV)		Limit (dBuV)		Margin (dB)	
			Q.P.	AV.	Q.P.	AV.	Q.P.	AV.	Q.P.	AV.
1	0.15000	10.11	45.34	34.01	55.45	44.12	66.00	56.00	-10.55	-11.88
2	0.18519	10.13	37.96	25.28	48.09	35.41	64.25	54.25	-16.16	-18.84
3	0.22791	10.14	34.46	23.01	44.60	33.15	62.53	52.53	-17.93	-19.38
4	0.25526	10.15	29.14	19.35	39.29	29.50	61.58	51.58	-22.29	-22.08
5	4.19294	10.38	22.66	17.42	33.04	27.80	56.00	46.00	-22.96	-18.20
6	14.86333	11.06	21.85	16.59	32.91	27.65	60.00	50.00	-27.09	-22.35

Remarks:

1. Q.P. and AV. are abbreviations of quasi-peak and average individually.
2. The emission levels of other frequencies were very low against the limit.
3. Margin value = Emission level – Limit value
4. Correction factor = Insertion loss + Cable loss
5. Emission Level = Correction Factor + Reading Value

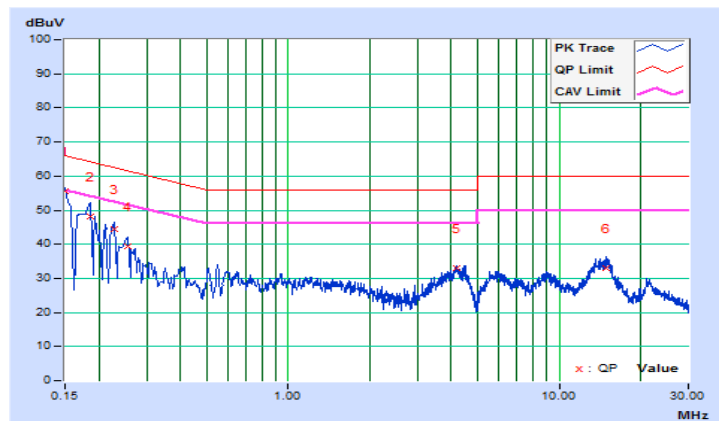

Frequency Range	150kHz ~ 30MHz	Detector Function & Resolution Bandwidth	Quasi-Peak (QP) / Average (AV), 9kHz
Input Power	120Vac, 60Hz	Environmental Conditions	25°C, 65%RH
Tested by	Toby Tian	Test Date	2017/2/10

Phase Of Power : Neutral (N)										
No	Frequency (MHz)	Correction Factor (dB)	Reading Value (dBuV)		Emission Level (dBuV)		Limit (dBuV)		Margin (dB)	
			Q.P.	AV.	Q.P.	AV.	Q.P.	AV.	Q.P.	AV.
1	0.15782	10.13	44.65	32.15	54.78	42.28	65.58	55.58	-10.80	-13.30
2	0.18910	10.14	38.94	26.82	49.08	36.96	64.08	54.08	-15.00	-17.12
3	0.21679	10.15	34.29	20.74	44.44	30.89	62.94	52.94	-18.50	-22.05
4	0.26346	10.16	27.38	15.11	37.54	25.27	61.32	51.32	-23.78	-26.05
5	4.73252	10.44	17.31	11.99	27.75	22.43	56.00	46.00	-28.25	-23.57
6	14.15953	11.09	13.85	7.44	24.94	18.53	60.00	50.00	-35.06	-31.47

Remarks:

1. Q.P. and AV. are abbreviations of quasi-peak and average individually.
2. The emission levels of other frequencies were very low against the limit.
3. Margin value = Emission level – Limit value
4. Correction factor = Insertion loss + Cable loss
5. Emission Level = Correction Factor + Reading Value

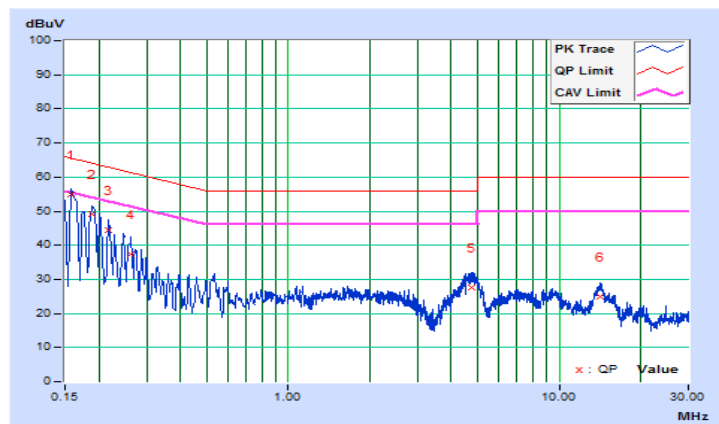

### 4.3 6 dB Bandwidth Measurement

#### 4.3.1 Limits of 6 dB Bandwidth Measurement

The minimum of 6 dB Bandwidth Measurement is 0.5 MHz.

#### 4.3.2 Test Setup

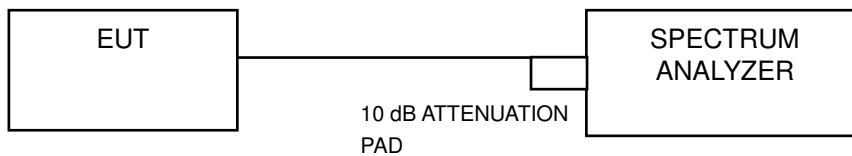

#### 4.3.3 Test Instruments

Refer to section 4.1.2 to get information of above instrument.

#### 4.3.4 Test Procedure

- Set resolution bandwidth (RBW) = 100 kHz
- Set the video bandwidth (VBW)  $\geq 3 \times$  RBW, Detector = Peak.
- Trace mode = max hold.
- Sweep = auto couple.
- Measure the maximum width of the emission that is constrained by the frequencies associated with the two amplitude points (upper and lower) that are attenuated by 6 dB relative to the maximum level measured in the fundamental emission

#### 4.3.5 Deviation from Test Standard

No deviation.

#### 4.3.6 EUT Operating Conditions

The software provided by client to enable the EUT under transmission condition continuously at lowest, middle and highest channel frequencies individually.



#### 4.4 Conducted Output Power Measurement

##### 4.4.1 Limits of Conducted Output Power Measurement

For systems using digital modulation in the 2400–2483.5 MHz bands: 1 Watt (30 dBm)

##### 4.4.2 Test Setup

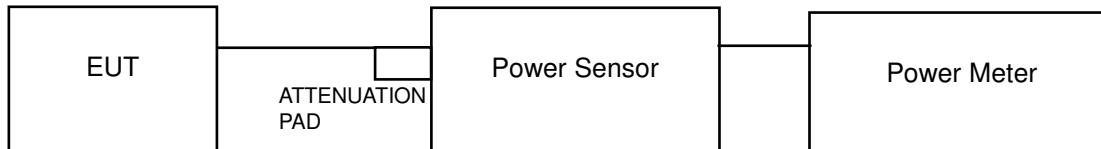

##### 4.4.3 Test Instruments

Refer to section 4.1.2 to get information of above instrument.

##### 4.4.4 Test Procedures

A peak / average power sensor was used on the output port of the EUT. A power meter was used to read the response of the peak / average power sensor. Record the power level.

##### 4.4.5 Deviation from Test Standard

No deviation.

##### 4.4.6 EUT Operating Conditions

The software provided by client to enable the EUT under transmission condition continuously at lowest, middle and highest channel frequencies individually.

##### 4.4.7 Test Results

Channel	Frequency (MHz)	Peak Power (mW)	Peak Power (dBm)	Limit (dBm)	Pass / Fail
0	2402	0.5808	-2.36	30	Pass
19	2440	0.6546	-1.84	30	Pass
39	2480	0.5675	-2.46	30	Pass

## 4.5 Power Spectral Density Measurement

### 4.5.1 Limits of Power Spectral Density Measurement

The Maximum of Power Spectral Density Measurement is 8 dBm.

### 4.5.2 Test Setup

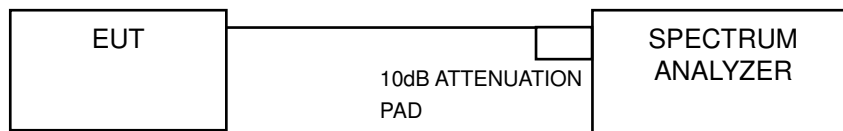

### 4.5.3 Test Instruments

Refer to section 4.1.2 to get information of above instrument.

### 4.5.4 Test Procedure

- Set the RBW = 3 kHz, VBW = 10 kHz, Detector = peak.
- Sweep time = auto couple, Trace mode = max hold, allow trace to fully stabilize.
- Use the peak marker function to determine the maximum power level in any 100 kHz band segment within the fundamental EBW.

### 4.5.5 Deviation from Test Standard

No deviation.

### 4.5.6 EUT Operating Condition

The software provided by client to enable the EUT under transmission condition continuously at lowest, middle and highest channel frequencies individually.

4.5.7 Test Results

Channel	Frequency (MHz)	PSD (dBm/3 kHz)	Limit (dBm/3 kHz)	Pass / Fail
0	2402	-17.42	8	Pass
19	2440	-16.97	8	Pass
39	2480	-17.76	8	Pass

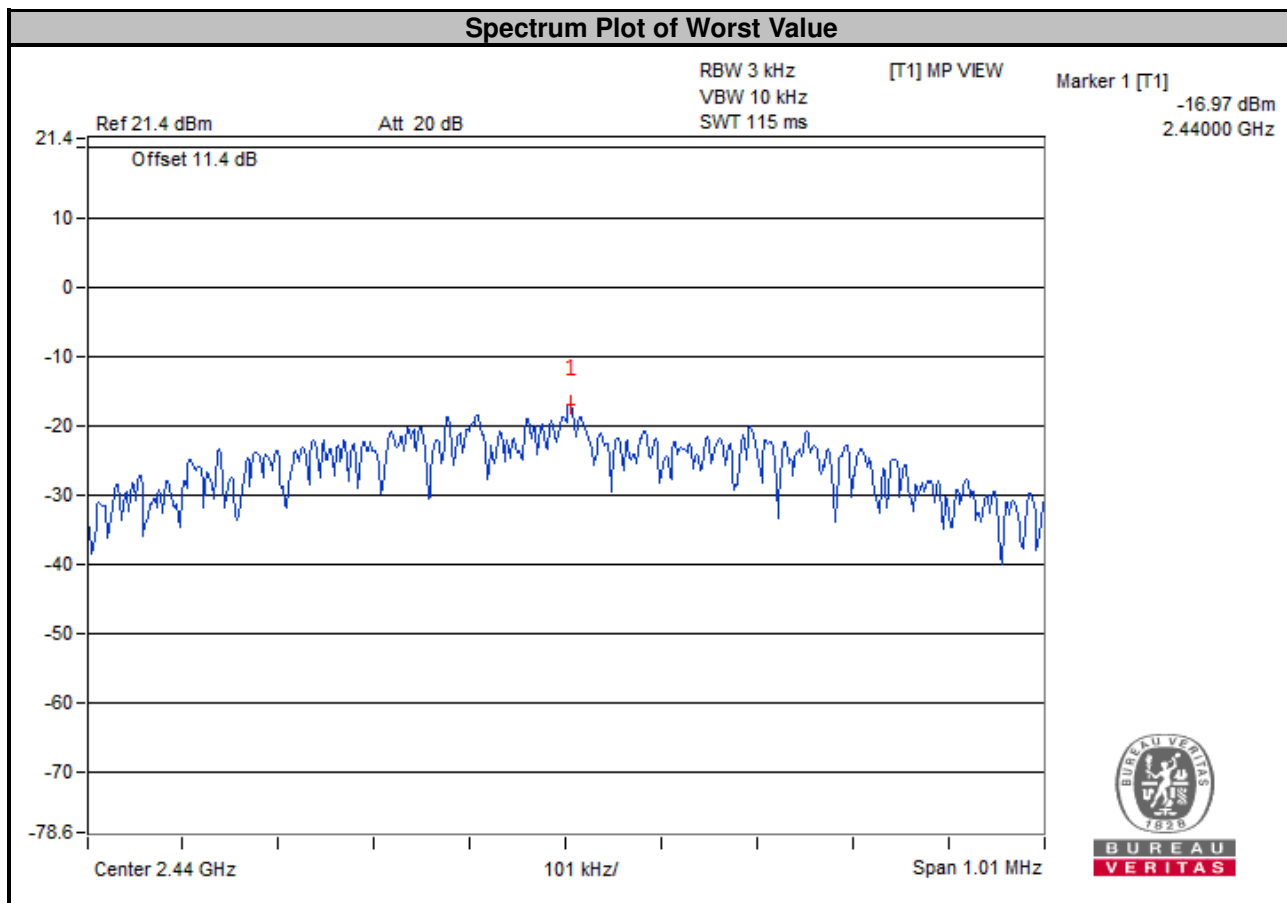



## 4.6 Conducted Out of Band Emission Measurement

### 4.6.1 Limits of Conducted Out of Band Emission Measurement

Below  $-20$  dB of the highest emission level of operating band (in 100 kHz Resolution Bandwidth).

### 4.6.2 Test Setup

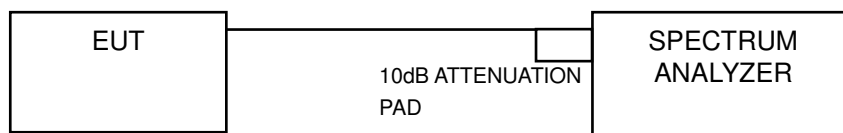

### 4.6.3 Test Instruments

Refer to section 4.1.2 to get information of above instrument.

### 4.6.4 Test Procedure

#### MEASUREMENT PROCEDURE REF

1. Set the RBW = 100 kHz.
2. Set the VBW  $\geq$  300 kHz.
3. Detector = peak.
4. Sweep time = auto couple.
5. Trace mode = max hold.
6. Allow trace to fully stabilize.
7. Use the peak marker function to determine the maximum power level in any 100 kHz band segment within the fundamental EBW.

#### MEASUREMENT PROCEDURE OOB

1. Set RBW = 100 kHz.
2. Set VBW  $\geq$  300 kHz.
3. Detector = peak.
4. Sweep = auto couple.
5. Trace Mode = max hold.
6. Allow trace to fully stabilize.
7. Use the peak marker function to determine the maximum amplitude level.

### 4.6.5 Deviation from Test Standard

No deviation.

### 4.6.6 EUT Operating Condition

The software provided by client to enable the EUT under transmission condition continuously at lowest, middle and highest channel frequencies individually.

### 4.6.7 TEST RESULTS

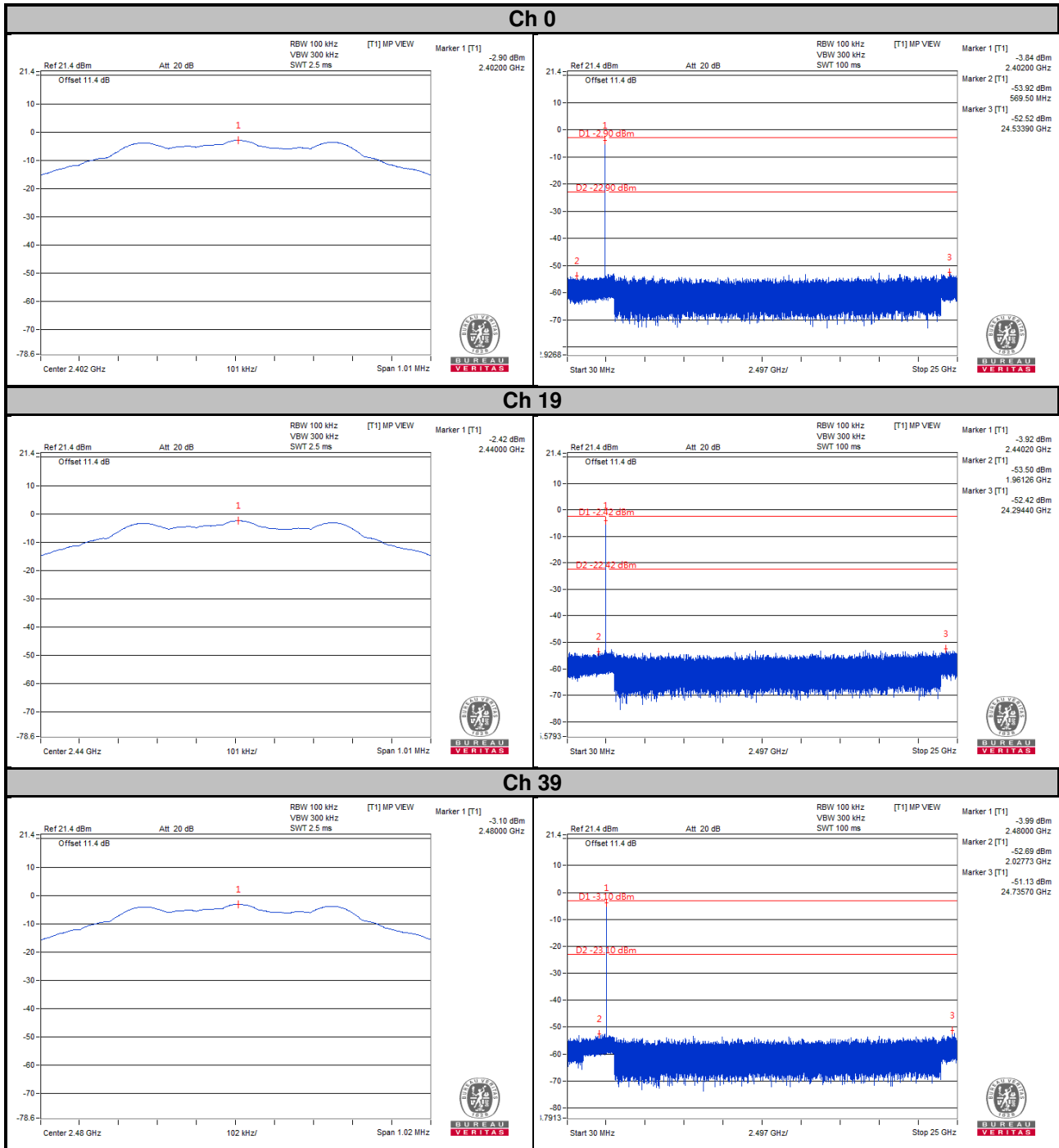

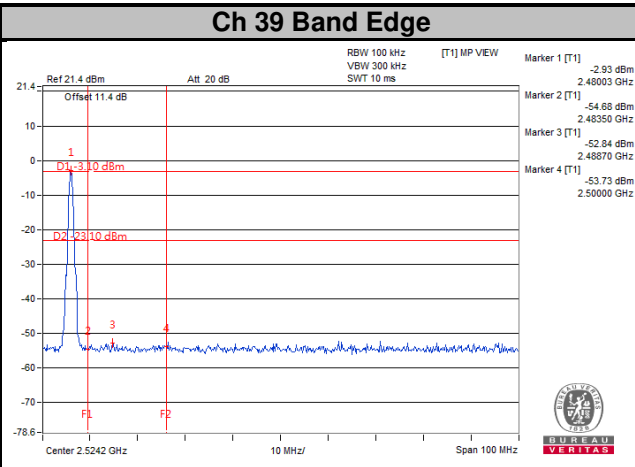
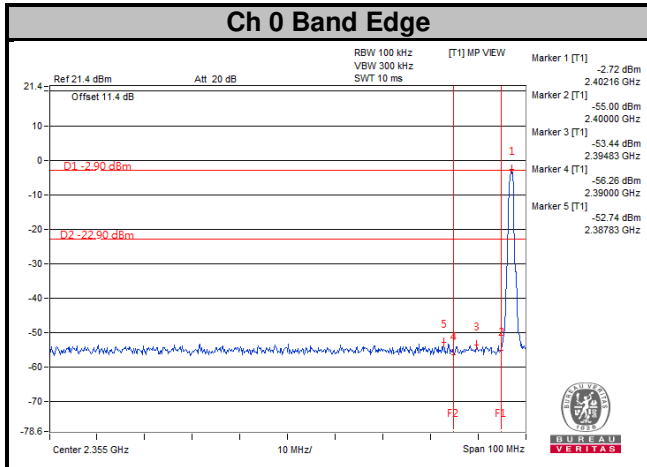

## 5 Pictures of Test Arrangements

Please refer to the attached file (Test Setup Photo).

## Appendix – Information on the Testing Laboratories

We, Bureau Veritas Consumer Products Services (H.K.) Ltd., Taoyuan Branch, were founded in 1988 to provide our best service in EMC, Radio, Telecom and Safety consultation. Our laboratories are accredited and approved according to ISO/IEC 17025.

If you have any comments, please feel free to contact us at the following:

**Linko EMC/RF Lab**

Tel: 886-2-26052180

Fax: 886-2-26051924

**Hsin Chu EMC/RF/Telecom Lab**

Tel: 886-3-6668565

Fax: 886-3-6668323

**Hwa Ya EMC/RF/Safety**

Tel: 886-3-3183232

Fax: 886-3-3270892

**Email:** [service.adt@tw.bureauveritas.com](mailto:service.adt@tw.bureauveritas.com)

**Web Site:** [www.bureauveritas-adt.com](http://www.bureauveritas-adt.com)

The address and road map of all our labs can be found in our web site also.

--- END ---