

FCC Test Report

Report No.: RF161228C15-8

FCC ID: MSQA002

Test Model: ASUS_A002

Received Date: Dec. 28, 2016

Test Date: Jan. 08, 2017 ~ Feb. 23, 2017

Issued Date: Mar. 07, 2017

Applicant: ASUSTek COMPUTER INC.

Address: 4F, No. 150, LI-TE Rd., PEITOU, TAIPEI 112, TAIWAN

Issued By: Bureau Veritas Consumer Products Services (H.K.) Ltd., Taoyuan Branch

Lab Address: No. 47-2, 14th Ling, Chia Pau Vil., Lin Kou Dist., New Taipei City, Taiwan
(R.O.C)

Test Location (1): No. 19, Hwa Ya 2nd Rd, Wen Hwa Tsuen, Kwei Shan Hsiang, Taoyuan
Hsien 333, Taiwan, R.O.C.

Test Location (2): No.215, Sec. 3, Beixin Rd., Xindian Dist., New Taipei City 231, Taiwan,
R.O.C



This report is for your exclusive use. Any copying or replication of this report to or for any other person or entity, or use of our name or trademark, is permitted only with our prior written permission. This report sets forth our findings solely with respect to the test samples identified herein. The results set forth in this report are not indicative or representative of the quality or characteristics of the lot from which a test sample was taken or any similar or identical product unless specifically and expressly noted. Our report includes all of the tests requested by you and the results thereof based upon the information that you provided to us. You have 60 days from date of issuance of this report to notify us of any material error or omission caused by our negligence, provided, however, that such notice shall be in writing and shall specifically address the issue you wish to raise. A failure to raise such issue within the prescribed time shall constitute your unqualified acceptance of the completeness of this report, the tests conducted and the correctness of the report contents. Unless specific mention, the uncertainty of measurement has been explicitly taken into account to declare the compliance or non-compliance to the specification. The report must not be used by the client to claim product certification, approval, or endorsement by TAF or any government agencies.

Table of Contents

Release Control Record	4
1 Certificate of Conformity	5
2 Summary of Test Results	6
2.1 Measurement Uncertainty	6
2.2 Modification Record	6
3 General Information	7
3.1 General Description of EUT	7
3.2 Description of Test Modes.....	9
3.2.1 Test Mode Applicability and Tested Channel Detail	11
3.3 Duty Cycle of Test Signal	13
3.4 Description of Support Units	14
3.4.1 Configuration of System under Test	14
3.5 General Description of Applied Standards.....	14
4 Test Types and Results	15
4.1 Radiated Emission and Bandedge Measurement	15
4.1.1 Limits of Radiated Emission and Bandedge Measurement	15
4.1.2 Limits of Unwanted Emission Out of the Restricted Bands	16
4.1.3 Test Instruments	17
4.1.4 Test Procedures.....	18
4.1.5 Deviation from Test Standard	18
4.1.6 Test Set Up	19
4.1.7 EUT Operating Conditions.....	20
4.1.8 Test Results	21
4.2 Conducted Emission Measurement.....	71
4.2.1 Limits of Conducted Emission Measurement	71
4.2.2 Test Instruments	71
4.2.3 Test Procedures.....	72
4.2.4 Deviation from Test Standard	72
4.2.5 Test Setup.....	72
4.2.6 EUT Operating Conditions.....	72
4.2.7 Test Results	73
4.3 Transmit Power Measurement.....	77
4.3.1 Limits of Transmit Power Measurement	77
4.3.2 Test Setup.....	77
4.3.3 Test Instruments	78
4.3.4 Test Procedure	78
4.3.5 Deviation from Test Standard	78
4.3.6 EUT Operating Conditions.....	78
4.3.7 Test Result	79
4.4 Peak Power Spectral Density Measurement	84
4.4.1 Limits of Peak Power Spectral Density Measurement	84
4.4.2 Test Setup.....	84
4.4.3 Test Instruments	84
4.4.4 Test Procedures.....	84
4.4.5 Deviation from Test Standard	85
4.4.6 EUT Operating Conditions.....	85
4.4.7 Test Results	86
4.5 Frequency Stability	91
4.5.1 Limit of Frequency Stability Measurement	91
4.5.2 Test Setup.....	91
4.5.3 Test Instruments	91
4.5.4 Test Procedure	91
4.5.5 Deviation from Test Standard	91

4.5.6 EUT Operating Condition	91
4.5.7 Test Results	92
4.6 6 dB Bandwidth Measurement.....	93
4.6.1 Limits of 6 dB Bandwidth Measurement.....	93
4.6.2 Test Setup.....	93
4.6.3 Test Instruments	93
4.6.4 Test Procedure	93
4.6.5 Deviation from Test Standard	93
4.6.6 EUT Operating Condition	93
4.6.7 Test Results	94
5 Pictures of Test Arrangements.....	96
Annex A- Radiated Out of Band Emisison (OOBE) Measurement (For U-NII-3 band)	97
Appendix – Information on the Testing Laboratories	101

Release Control Record

Issue No.	Description	Date Issued
RF161228C15-8	Original Release	Mar. 07, 2017

1 Certificate of Conformity

Product: ASUS Phone

Brand: ASUS

Test Model: ASUS_A002

Sample Status: Identical Prototype

Applicant: ASUSTek COMPUTER INC.

Test Date: Jan. 08, 2017 ~ Feb. 23, 2017

Standards: 47 CFR FCC Part 15, Subpart E (Section 15.407)
ANSI C63.10:2013

The above equipment has been tested by **Bureau Veritas Consumer Products Services (H.K.) Ltd., Taoyuan Branch**, and found compliance with the requirement of the above standards. The test record, data evaluation & Equipment Under Test (EUT) configurations represented herein are true and accurate accounts of the measurements of the sample's EMC characteristics under the conditions specified in this report.

Prepared by :  , **Date:** Mar. 07, 2017
Ivonne Wu / Supervisor

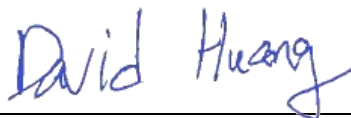
Approved by :  , **Date:** Mar. 07, 2017
David Huang / Project Engineer

2 Summary of Test Results

47 CFR FCC Part 15, Subpart E (Section 15.407)			
FCC Clause	Test Item	Result	Remarks
15.407(b)(6)	AC Power Conducted Emissions	Pass	Meet the requirement of limit. Minimum passing margin is -5.22 dB at 0.15000 MHz.
15.407(b) (1/2/3/4(i/ii)/6)	Radiated Emissions & Band Edge Measurement	Pass	Meet the requirement of limit. Minimum passing margin is -2.02 dB at 5150 MHz.
15.407(a)(1/2/3)	Max Average Transmit Power	Pass	Meet the requirement of limit.
15.407(a)(1/2/3)	Peak Power Spectral Density	Pass	Meet the requirement of limit.
15.407(e)	6 dB Bandwidth	Pass	Meet the requirement of limit. (U-NII-3 Band only)
15.407(g)	Frequency Stability	Pass	Meet the requirement of limit.
15.203	Antenna Requirement	Pass	No antenna connector is used.

*For U-NII-3 band compliance with rule part 15.407(b)(4)(i), the OOB test plots were recorded in Annex A.

2.1 Measurement Uncertainty

Where relevant, the following measurement uncertainty levels have been estimated for tests performed on the EUT as specified in CISPR 16-4-2:

Measurement	Frequency	Expanded Uncertainty (k=2) (±)
Conducted Emissions at mains ports	150 kHz ~ 30 MHz	2.44 dB
Radiated Emissions up to 1 GHz	30 MHz ~ 200 MHz	2.0153 dB
	200 MHz ~ 1000 MHz	2.0224 dB
Radiated Emissions above 1 GHz	1 GHz ~ 18 GHz	1.0121 dB
	18 GHz ~ 40 GHz	1.1508 dB

2.2 Modification Record

There were no modifications required for compliance.

3 General Information

3.1 General Description of EUT

Product	ASUS Phone
Brand	ASUS
Test Model	ASUS_A002
Status of EUT	Identical Prototype
Power Supply Rating	3.85 Vdc (Li-ion battery) 5.0 Vdc or 9.0 Vdc (Adapter) 5.0 Vdc (Host equipment)
Modulation Type	256QAM, 64QAM, 16QAM, QPSK, BPSK
Modulation Technology	OFDM
Transfer Rate	802.11a: 54.0/ 48.0/ 36.0/ 24.0/ 18.0/ 12.0/ 9.0/ 6.0 Mbps 802.11n: up to MCS7 802.11ac: up to V9
Operating Frequency	5180 ~ 5240 MHz, 5260 ~ 5320 MHz, 5500 ~ 5700 MHz, 5745 ~ 5825 MHz
Number of Channel	5180 ~ 5240 MHz: 4 for 802.11a, 802.11n (HT20) 2 for 802.11n (HT40) 1 for 802.11ac (VHT80) 5260 ~ 5320 MHz: 4 for 802.11a, 802.11n (HT20) 2 for 802.11n (HT40) 1 for 802.11ac (VHT80) 5500 ~ 5700 MHz: 11 for 802.11a, 802.11n (HT20) 5 for 802.11n (HT40) 2 for 802.11ac (VHT80) 5745 ~ 5825 MHz: 5 for 802.11a, 802.11n (HT20) 2 for 802.11n (HT40) 1 for 802.11ac (VHT80)
Output Power	11.015 mW for 5180 ~ 5240 MHz 11.246 mW for 5260 ~ 5320 MHz 11.722 mW for 5500 ~ 5700 MHz 11.092 mW for 5745 ~ 5825 MHz
Antenna Type	PCB antenna with 2.87 dBi gain (5180 ~ 5240 MHz) PCB antenna with 2.79 dBi gain (5260 ~ 5320 MHz) PCB antenna with 2.65 dBi gain (5500 ~ 5700 MHz) PCB antenna with 1.64 dBi gain (5745 ~ 5825 MHz)
Antenna Connector	N/A
Accessory Device	Refer to Note as below
Data Cable Supplied	Refer to Note as below

Note:

1. There're 2 configurations for the EUT listed as below.

Sample	Description
A	EUT + Rear Camera 1 + TOF Camera 2 + UFS 3 + DDR 1 + Finger Print 2
B	EUT + Rear Camera 2 + TOF Camera 1 + UFS 5 + DDR 3 + Finger Print 1

* Only the worst test data was presented in the report.

2. The EUT incorporates a MIMO function. Physically, the EUT provides two completed transmitters and two receivers.

Modulation Mode	Tx Function
802.11b	1TX
802.11g	1TX
802.11a	1TX
802.11n (HT20)	1TX
802.11n (HT40)	1TX
802.11ac (HT20)	1TX
802.11ac (HT40)	1TX
802.11ac (VHT80)	1TX

* The modulation and bandwidth are similar for 802.11n mode for HT20 / HT40 and 802.11ac mode for HT20 / HT40, therefore investigated worst case to representative mode in test report. (Final test mode refer section 3.2.1)

3. The EUT's accessories list refers to Ext. Pho.
4. The above EUT information is declared by manufacturer and for more detailed features description, please refer to the manufacturer's specifications or user's manual.

3.2 Description of Test Modes

For 5180 ~ 5240 MHz

4 channels are provided for 802.11a, 802.11n (HT20):

Channel	Frequency (MHz)	Channel	Frequency (MHz)
36	5180	44	5220
40	5200	48	5240

2 channels are provided for 802.11n (HT40):

Channel	Frequency (MHz)	Channel	Frequency (MHz)
38	5190	46	5230

1 channel is provided for 802.11ac (VHT80):

Channel	Frequency (MHz)
42	5210

For 5260 ~ 5320 MHz

4 channels are provided for 802.11a, 802.11n (HT20):

Channel	Frequency (MHz)	Channel	Frequency (MHz)
52	5260	60	5300
56	5280	64	5320

2 channels are provided for 802.11n (HT40):

Channel	Frequency (MHz)	Channel	Frequency (MHz)
54	5270	62	5310

1 channel is provided for 802.11ac (VHT80):

Channel	Frequency (MHz)
58	5290

For 5500 ~ 5700 MHz

11 channels are provided for 802.11a, 802.11n (HT20):

Channel	Frequency (MHz)	Channel	Frequency (MHz)
100	5500	124	5620
104	5520	128	5640
108	5540	132	5660
112	5560	136	5680
116	5580	140	5700
120	5600		

5 channels are provided for 802.11n (HT40):

Channel	Frequency (MHz)	Channel	Frequency (MHz)
102	5510	126	5630
110	5550	134	5670
118	5590		

2 channels are provided for 802.11ac (VHT80):

Channel	Frequency (MHz)	Channel	Frequency (MHz)
106	5530	122	5610

For 5745 ~ 5825 MHz:

5 channels are provided for 802.11a, 802.11n (HT20):

Channel	Frequency (MHz)	Channel	Frequency (MHz)
149	5745	161	5805
153	5765	165	5825
157	5785		

2 channels are provided for 802.11n (HT40):

Channel	Frequency (MHz)	Channel	Frequency (MHz)
151	5755	159	5795

1 channel is provided for 802.11ac (VHT80):

Channel	Frequency (MHz)
155	5775

3.2.1 Test Mode Applicability and Tested Channel Detail

EUT Configure Mode	Applicable To				Description
	RE \geq 1G	RE $<$ 1G	PLC	APCM	
A	√	√	√	√	Sample A
B	√	√	√	-	Sample B

Where **RE \geq 1G**: Radiated Emission above 1 GHz **RE $<$ 1G**: Radiated Emission below 1 GHz
PLC: Power Line Conducted Emission **APCM**: Antenna Port Conducted Measurement

Note:

- The EUT had been pre-tested on the positioned of each 3 axis. The worst case was found when positioned on **Z-plane** for mode A 5180-5240MHz, **Y-plane** for mode A 5260-5320MHz & 5500-5700MHz & 5745-5825MHz and mode B 5180-5240MHz & 5260-5320MHz, and **X-plane** for mode B 5500-5700MHz & 5745-5825MHz.
- "-" means no effect.

Radiated Emission Test (Above 1 GHz):

- Pre-Scan has been conducted to determine the worst-case mode from all possible combinations between available modulations, data rates and antenna ports (if EUT with antenna diversity architecture).
- Following channel(s) was (were) selected for the final test as listed below.

EUT Configure Mode	Frequency Band (MHz)	Mode	Available Channel	Tested Channel	Modulation Technology	Modulation Type	Data Rate (Mbps)
A	5180-5240	802.11a	36 to 48	36, 44, 48	OFDM	BPSK	6.0
		802.11n (HT20)	36 to 48	36, 44, 48	OFDM	BPSK	MCS0
		802.11n (HT40)	38 to 46	38, 46	OFDM	BPSK	MCS0
		802.11ac (VHT80)	42	42	OFDM	BPSK	MCS0
	5260-5320	802.11a	52 to 64	52, 60, 64	OFDM	BPSK	6.0
		802.11n (HT20)	52 to 64	52, 60, 64	OFDM	BPSK	MCS0
		802.11n (HT40)	54 to 62	54, 62	OFDM	BPSK	MCS0
		802.11ac (VHT80)	58	58	OFDM	BPSK	MCS0
	5500-5700	802.11a	100 to 140	100, 116, 140	OFDM	BPSK	6.0
		802.11n (HT20)	100 to 140	100, 116, 140	OFDM	BPSK	MCS0
		802.11n (HT40)	102 to 134	102, 110, 134	OFDM	BPSK	MCS0
		802.11ac (VHT80)	106 to 122	106, 122	OFDM	BPSK	MCS0
	5745-5825	802.11a	149 to 165	149, 157, 165	OFDM	BPSK	6.0
		802.11n (HT20)	149 to 165	149, 157, 165	OFDM	BPSK	MCS0
		802.11n (HT40)	151 to 159	151, 159	OFDM	BPSK	MCS0
		802.11ac (VHT80)	155	155	OFDM	BPSK	MCS0
B	5180-5240	802.11n (HT40)	38 to 46	38	OFDM	BPSK	MCS0
	5260-5320	802.11ac (VHT80)	58	58	OFDM	BPSK	MCS0
	5500-5700	802.11n (HT40)	102 to 134	102	OFDM	BPSK	MCS0
	5745-5825	802.11ac (VHT80)	155	155	OFDM	BPSK	MCS0

Radiated Emission Test (Below 1 GHz):

- Pre-Scan has been conducted to determine the worst-case mode from all possible combinations between available modulations, data rates and antenna ports (if EUT with antenna diversity architecture).
- Following channel(s) was (were) selected for the final test as listed below.

EUT Configure Mode	Frequency Band (MHz)	Mode	Available Channel	Tested Channel	Modulation Technology	Modulation Type	Data Rate (Mbps)
A, B	5180-5240	802.11n (HT40)	38 to 46	38	OFDM	BPSK	MCS0
	5260-5320	802.11ac (VHT80)	58	58	OFDM	BPSK	MCS0
	5500-5700	802.11n (HT40)	102 to 134	102	OFDM	BPSK	MCS0
	5745-5825	802.11ac (VHT80)	155	155	OFDM	BPSK	MCS0

Power Line Conducted Emission Test:

- Pre-Scan has been conducted to determine the worst-case mode from all possible combinations between available modulations, data rates and antenna ports (if EUT with antenna diversity architecture).
- Following channel(s) was (were) selected for the final test as listed below.

EUT Configure Mode	Frequency Band (MHz)	Mode	Available Channel	Tested Channel	Modulation Technology	Modulation Type	Data Rate (Mbps)
A, B	5180-5320	802.11n (HT40)	38 to 46	38	OFDM	BPSK	MCS0

Antenna Port Conducted Measurement:

- This item includes all test value of each mode, but only includes spectrum plot of worst value of each mode.
- Pre-Scan has been conducted to determine the worst-case mode from all possible combinations between available modulations, data rates and antenna ports (if EUT with antenna diversity architecture).
- Following channel(s) was (were) selected for the final test as listed below.

EUT Configure Mode	Frequency Band (MHz)	Mode	Available Channel	Tested Channel	Modulation Technology	Modulation Type	Data Rate (Mbps)
A	5180-5240	802.11a	36 to 48	36, 44, 48	OFDM	BPSK	6.0
		802.11n (HT20)	36 to 48	36, 44, 48	OFDM	BPSK	MCS0
		802.11n (HT40)	38 to 46	38, 46	OFDM	BPSK	MCS0
		802.11ac (VHT80)	42	42	OFDM	BPSK	MCS0
	5260-5320	802.11a	52 to 64	52, 60, 64	OFDM	BPSK	6.0
		802.11n (HT20)	52 to 64	52, 60, 64	OFDM	BPSK	MCS0
		802.11n (HT40)	54 to 62	54, 62	OFDM	BPSK	MCS0
		802.11ac (VHT80)	58	58	OFDM	BPSK	MCS0
	5500-5700	802.11a	100 to 140	100, 116, 140	OFDM	BPSK	6.0
		802.11n (HT20)	100 to 140	100, 116, 140	OFDM	BPSK	MCS0
		802.11n (HT40)	102 to 134	102, 110, 134	OFDM	BPSK	MCS0
		802.11ac (VHT80)	106 to 122	106, 122	OFDM	BPSK	MCS0
	5745-5825	802.11a	149 to 165	149, 157, 165	OFDM	BPSK	6.0
		802.11n (HT20)	149 to 165	149, 157, 165	OFDM	BPSK	MCS0
		802.11n (HT40)	151 to 159	151, 159	OFDM	BPSK	MCS0
		802.11ac (VHT80)	155	155	OFDM	BPSK	MCS0

Test Condition:

Applicable To	Environmental Conditions	Input Power	Tested by
RE \geq 1G	25 deg. C, 65 % RH	120 Vac, 60 Hz	Charles Hsiao
RE $<$ 1G	25 deg. C, 65 % RH	120 Vac, 60 Hz	Charles Hsiao
PLC	25 deg. C, 65 % RH	120 Vac, 60 Hz	Toby Tian
APCM	25 deg. C, 65 % RH	3.85 Vdc	Wayne Lin

3.3 Duty Cycle of Test Signal

MODULATION TYPE: BPSK

802.11a: Duty cycle = $2.063/2.171 = 0.950$, Duty factor = $10 * \log(1/0.950) = 0.22$

802.11n (HT20): Duty cycle = $1.923/2.030 = 0.947$, Duty factor = $10 * \log(1/0.947) = 0.24$

802.11n (HT40): Duty cycle = $0.951/1.051 = 0.905$, Duty factor = $10 * \log(1/0.905) = 0.43$

802.11ac (VHT80): Duty cycle = $463/563 = 0.822$, Duty factor = $10 * \log(1/0.822) = 0.85$

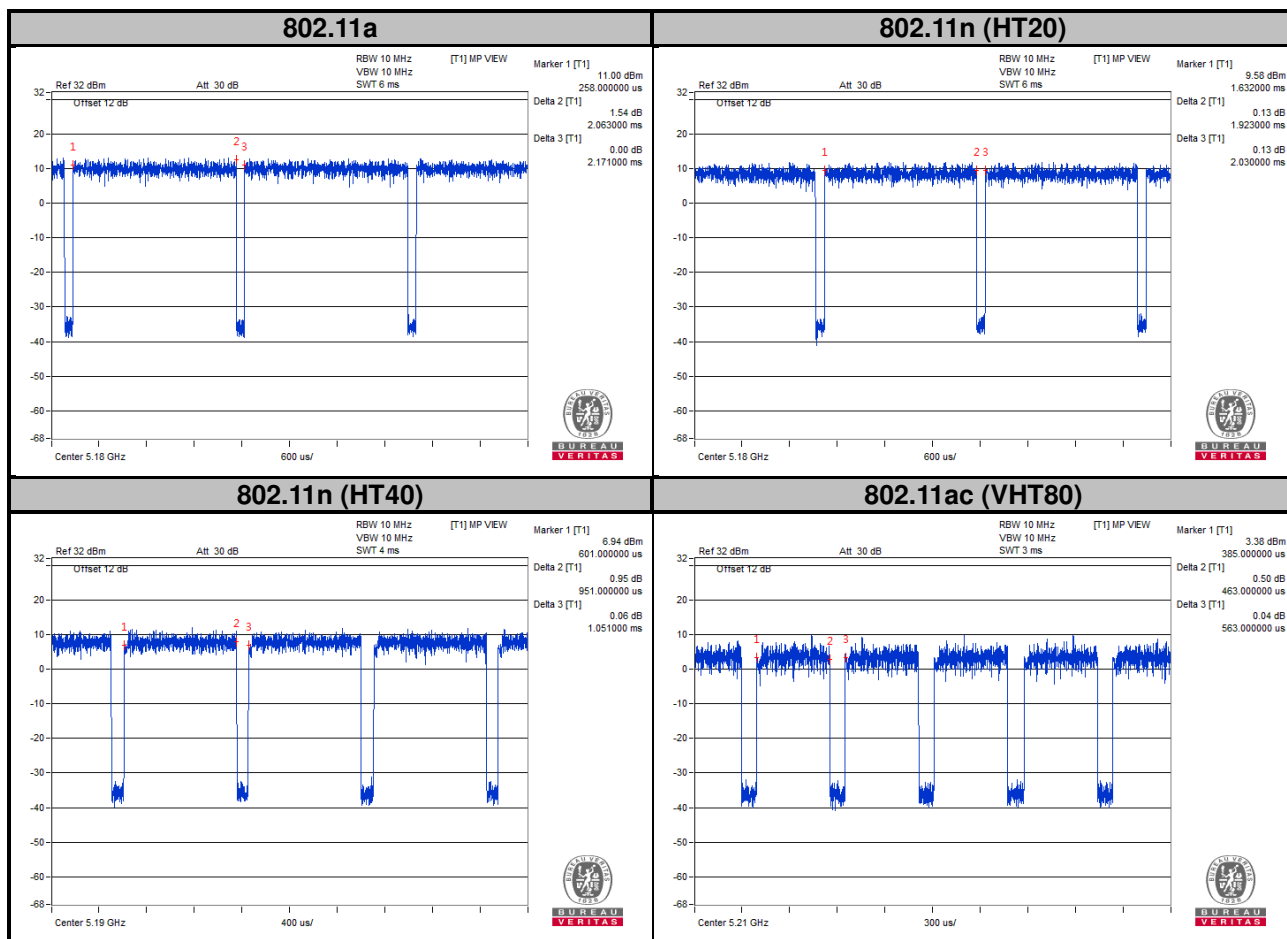

3.4 Description of Support Units

The EUT has been tested as an independent unit together with other necessary accessories or support units.

3.4.1 Configuration of System under Test

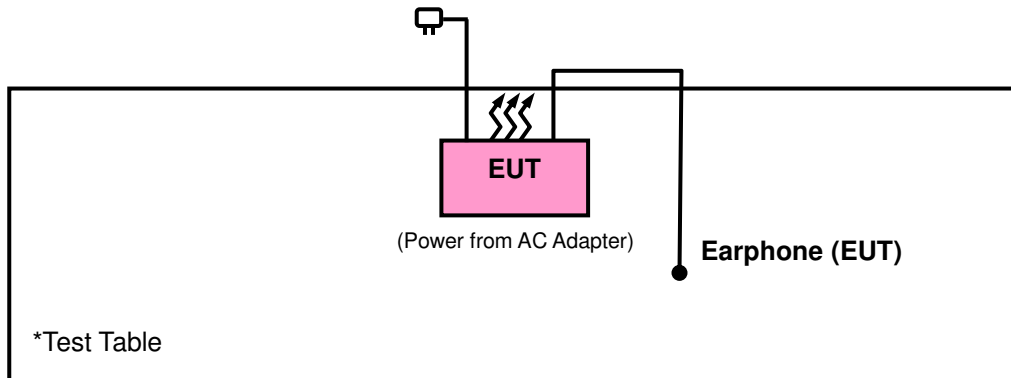

3.5 General Description of Applied Standards

The EUT is a RF Product. According to the specifications of the manufacturer, it must comply with the requirements of the following standards:

FCC Part 15, Subpart E (15.407)

789033 D02 General UNII Test Procedures New Rules v01r03

662911 D01 Multiple Transmitter Output v02r01

ANSI C63.10-2013

All test items have been performed and recorded as per the above standards.

Note: The EUT has been verified to comply with the requirements of FCC Part 15, Subpart B, Class B (DoC). The test report has been issued separately.

4 Test Types and Results

4.1 Radiated Emission and Bandedge Measurement

4.1.1 Limits of Radiated Emission and Bandedge Measurement

Radiated emissions which fall in the restricted bands must comply with the radiated emission limits specified as below table. Other emissions shall be at least 20 dB below the highest level of the desired power:

Frequencies (MHz)	Field Strength (microvolts/meter)	Measurement Distance (meters)
0.009 ~ 0.490	2400/F (kHz)	300
0.490 ~ 1.705	24000/F (kHz)	30
1.705 ~ 30.0	30	30
30 ~ 88	100	3
88 ~ 216	150	3
216 ~ 960	200	3
Above 960	500	3

Note:

1. The lower limit shall apply at the transition frequencies.
2. Emission level (dBuV/m) = 20 log Emission level (uV/m).
3. For frequencies above 1000 MHz, the field strength limits are based on average detector, however, the peak field strength of any emission shall not exceed the maximum permitted average limits, specified above by more than 20 dB under any condition of modulation.

4.1.2 Limits of Unwanted Emission Out of the Restricted Bands

Applicable To		Limit	
789033 D02 General UNII Test Procedures New Rules v01r03		Field Strength at 3 m	
		PK: 74 (dBμV/m)	AV: 54 (dBμV/m)
Frequency Band	Applicable To	EIRP Limit	Equivalent Field Strength at 3 m
5150~5250 MHz	15.407(b)(1)	PK: -27 (dBm/MHz)	PK: 68.2 (dBμV/m)
5250~5350 MHz	15.407(b)(2)		
5470~5725 MHz	15.407(b)(3)		
5725~5850 MHz	15.407(b)(4)(i)	PK:-27 (dBm/MHz) ^{*1} PK:10 (dBm/MHz) ^{*2} PK:15.6 (dBm/MHz) ^{*3} PK:27 (dBm/MHz) ^{*4}	PK: 68.2 (dBμV/m) ^{*1} PK:105.2 (dBμV/m) ^{*2} PK: 110.8 (dBμV/m) ^{*3} PK:122.2 (dBμV/m) ^{*4}
	15.407(b)(4)(ii)	Emission limits in section 15.247(d)	
^{*1} beyond 75 MHz or more above of the band edge. ^{*2} below the band edge increasing linearly to 10 dBm/MHz at 25 MHz above. ^{*3} below the band edge increasing linearly to a level of 15.6 dBm/MHz at 5 MHz above. ^{*4} from 5 MHz above or below the band edge increasing linearly to a level of 27 dBm/MHz at the band edge.			

Note:

The following formula is used to convert the equipment isotropic radiated power (eirp) to field strength:

$$E = \frac{1000000\sqrt{30P}}{3} \mu\text{V/m, where } P \text{ is the eirp (Watts).}$$

4.1.3 Test Instruments

Description & Manufacturer	Model No.	Serial No.	Date of Calibration	Due Date of Calibration
Test Receiver Agilent Technologies	N9038A	MY52260177	Jun. 21, 2016	Jun. 20, 2017
Spectrum Analyzer ROHDE & SCHWARZ	FSU43	101261	Dec. 13, 2016	Dec. 12, 2017
BILOG Antenna SCHWARZBECK	VULB9168	9168-472	Dec. 16, 2016	Dec. 15, 2017
HORN Antenna ETS-Lindgren	3117	00143293	Dec. 29, 2016	Dec. 28, 2017
HORN Antenna SCHWARZBECK	BBHA 9170	9170-480	Dec. 14, 2016	Dec. 13, 2017
Fixed Attenuator Mini-Circuits	BW-N10W5+	NA	Jul. 08, 2016	Jul. 07, 2017
Bluetooth Tester	CBT	100980	Apr. 27, 2015	Apr. 26, 2017
Loop Antenna	EM-6879	269	Aug. 11, 2016	Aug. 10, 2017
Preamplifier Agilent	310N	187226	Jun. 24, 2016	Jun. 23, 2017
Preamplifier Agilent	83017A	MY39501357	Jun. 24, 2016	Jun. 23, 2017
Power Meter Anritsu	ML2495A	1232002	Sep. 08, 2016	Sep. 07, 2017
Power Sensor Anritsu	MA2411B	1207325	Sep. 08, 2016	Sep. 07, 2017
RF signal cable ETS-LINDGREN	5D-FB	Cable-CH1-01(R FC-SMS-100-SM S-120+RFC-SMS -100-SMS-400)	Jun. 24, 2016	Jun. 23, 2017
RF signal cable ETS-LINDGREN	8D-FB	Cable-CH1-02(R FC-SMS-100-SM S-24)	Jun. 24, 2016	Jun. 23, 2017
Software BV ADT	E3 8.130425b	NA	NA	NA
Antenna Tower MF	NA	NA	NA	NA
Turn Table MF	NA	NA	NA	NA
Antenna Tower & Turn Table Controller MF	MF-7802	NA	NA	NA

- Note: 1. The calibration interval of the above test instruments is 12 / 24 months and the calibrations are traceable to NML/ROC and NIST/USA.
2. The test was performed in HsinTien Chamber 1.
3. The horn antenna and preamplifier (model: 83017A) are used only for the measurement of emission frequency above 1 GHz if tested.
4. The FCC Site Registration No. is 149147.
5. The IC Site Registration No. is IC7450I-1.

4.1.4 Test Procedures

- a. The EUT was placed on the top of a rotating table 0.8 meters (for below 1 GHz) / 1.5 meters (for above 1 GHz) above the ground at 3 meter chamber room for test. The table was rotated 360 degrees to determine the position of the highest radiation.
- b. The EUT was set 3 meters away from the interference-receiving antenna, which was mounted on the top of a variable-height antenna tower.
- c. The height of antenna is varied from one meter to four meters above the ground to determine the maximum value of the field strength. Both horizontal and vertical polarizations of the antenna are set to make the measurement.
- d. For each suspected emission, the EUT was arranged to its worst case and then the antenna was tuned to heights from 1 meter to 4 meters and the rotatable table was turned from 0 degrees to 360 degrees to find the maximum reading.
- e. The test-receiver system was set to quasi-peak detect function and specified bandwidth with maximum hold mode when the test frequency is below 1 GHz.
- f. The test-receiver system was set to peak and average detected function and specified bandwidth with maximum hold mode when the test frequency is above 1 GHz. If the peak reading value also meets average limit, measurement with the average detector is unnecessary.

Note:

1. The resolution bandwidth and video bandwidth of test receiver/spectrum analyzer is 120 kHz & 360 kHz for Quasi-peak detection (QP) at frequency below 1 GHz.
2. The resolution bandwidth of test receiver/spectrum analyzer is 1 MHz and the video bandwidth is 3 MHz for Peak detection (PK) at frequency above 1 GHz.
3. The resolution bandwidth of test receiver/spectrum analyzer is 1 MHz and the video bandwidth is 1/T for RMS Average (Duty cycle < 98 %) for Peak detection at frequency above 1 GHz.
4. The resolution bandwidth of test receiver/spectrum analyzer is 1 MHz and the video bandwidth is 10 Hz (Duty cycle ≥ 98 %) for Average detection (AV) at frequency above 1 GHz.
5. All modes of operation were investigated and the worst-case emissions are reported.

4.1.5 Deviation from Test Standard

No deviation.

4.1.6 Test Set Up

<Radiated emission below 30MHz>

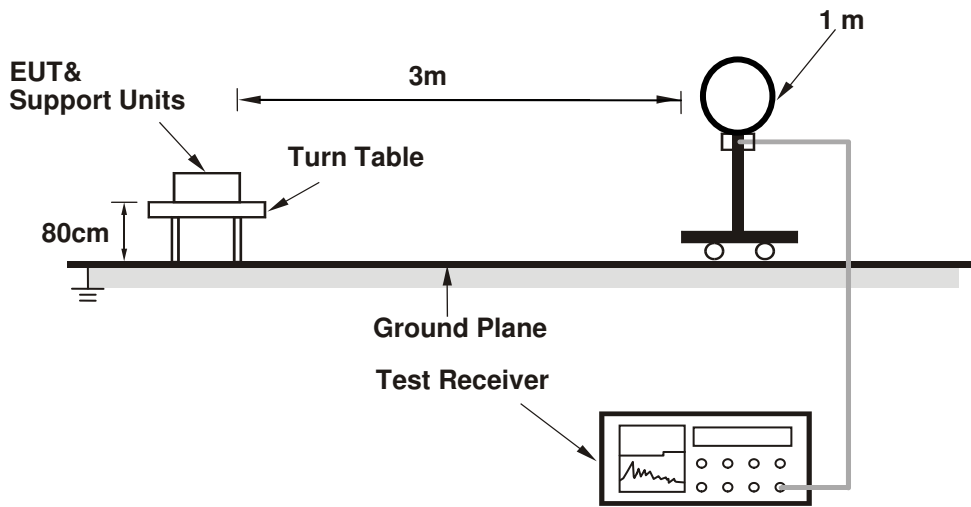

<Frequency Range below 1 GHz>

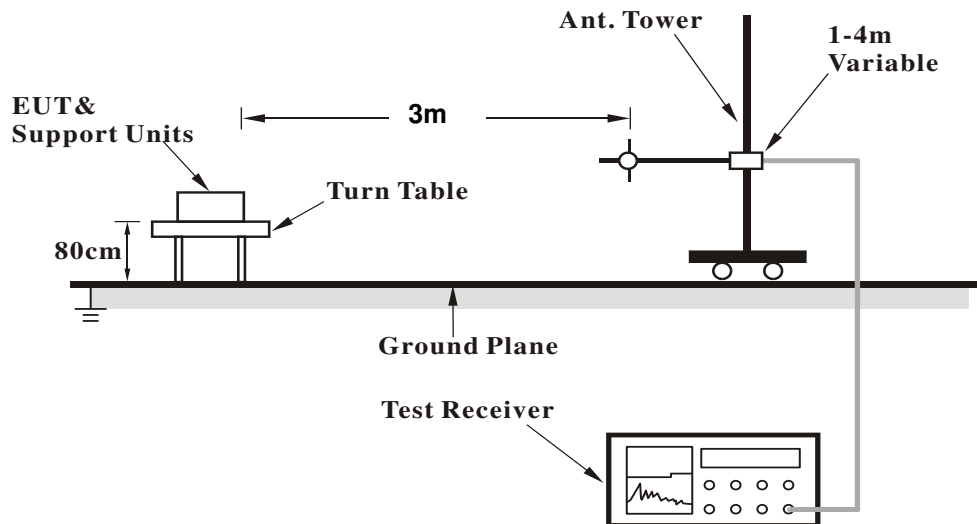

<Frequency Range above 1 GHz>

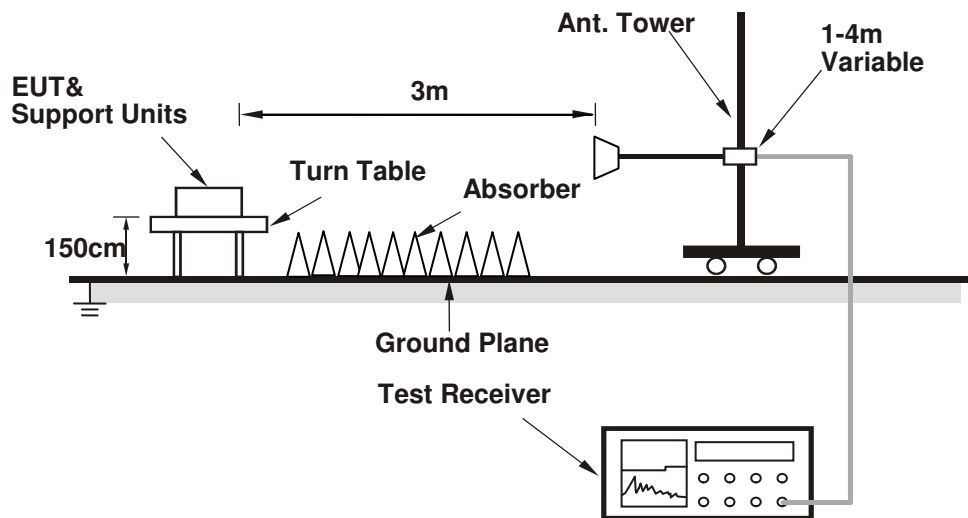

For the actual test configuration, please refer to the attached file (Test Setup Photo).

4.1.7 EUT Operating Conditions

- Placed the EUT on a testing table.
- Use the software to control the EUT under transmission condition continuously at specific channel frequency.

4.1.8 Test Results
Above 1 GHz Data :
Mode A
802.11a

EUT Test Condition		Measurement Detail	
Channel	Channel 36	Frequency Range	1 GHz ~ 40 GHz
Input Power	120 Vac, 60 Hz	Detector Function	Peak (PK) Average (AV)
Environmental Conditions	25 deg. C, 65 % RH	Tested By	Charles Hsiao

Antenna Polarity & Test Distance: Horizontal at 3 m										
Frequency (MHz)	Emission Level (dBuV/m)	Read Level (dBuV)	Limit (dBuV/m)	Margin (dB)	Antenna Factor (dB/m)	Cable Loss (dB)	Preamp Factor (dB)	Antenna Height (cm)	Table Angle (Degree)	Remark
5110.7	53.41	45.21	74	-20.59	34.09	8.1	33.99	124	242	Peak
5147.3	42.93	34.68	54	-11.07	34.12	8.13	34	124	242	Average
5180	92.71	84.4			34.15	8.16	34	124	242	Average
5180	100.23	91.92			34.15	8.16	34	124	242	Peak
10360	46.5	32.2	54	-7.5	37.12	12.3	35.12	158	205	Average
10360	56.21	41.91	74	-17.79	37.12	12.3	35.12	158	205	Peak

Antenna Polarity & Test Distance: Vertical at 3 m										
Frequency (MHz)	Emission Level (dBuV/m)	Read Level (dBuV)	Limit (dBuV/m)	Margin (dB)	Antenna Factor (dB/m)	Cable Loss (dB)	Preamp Factor (dB)	Antenna Height (cm)	Table Angle (Degree)	Remark
5148.8	44.94	36.69	54	-9.06	34.12	8.13	34	100	2	Peak
5149.7	54.43	46.18	74	-19.57	34.12	8.13	34	100	2	Peak
5180	99.51	57.2			34.15	8.16	0	100	2	Average
5180	106.92	64.61			34.15	8.16	0	100	2	Peak
10360	46.53	32.23	54	-7.47	37.12	12.3	35.12	135	179	Average
10360	56.37	42.07	74	-17.63	37.12	12.3	35.12	135	179	Peak

Remarks:

- Emission Level = Read Level + Antenna Factor + Cable Loss - Preamp Factor
 Margin value = Emission level – Limit value
- 5180 MHz: Fundamental Frequency

EUT Test Condition		Measurement Detail	
Channel	Channel 44	Frequency Range	1 GHz ~ 40 GHz
Input Power	120 Vac, 60 Hz	Detector Function	Peak (PK) Average (AV)
Environmental Conditions	25 deg. C, 65 % RH	Tested By	Charles Hsiao

Antenna Polarity & Test Distance: Horizontal at 3 m										
Frequency (MHz)	Emission Level (dBuV/m)	Read Level (dBuV)	Limit (dBuV/m)	Margin (dB)	Antenna Factor (dB/m)	Cable Loss (dB)	Preamp Factor (dB)	Antenna Height (cm)	Table Angle (Degree)	Remark
5123.3	42.84	34.62	54	-11.16	34.11	8.1	33.99	124	242	Average
5127.8	53.83	45.61	74	-20.17	34.11	8.1	33.99	124	242	Peak
5220	92.36	83.97			34.17	8.22	34	124	242	Average
5220	100.81	92.42			34.17	8.22	34	124	242	Peak
5435.47	53.69	44.9	74	-20.31	34.35	8.48	34.04	124	242	Peak
5436.79	42.79	34	54	-11.21	34.35	8.48	34.04	124	242	Average

Antenna Polarity & Test Distance: Vertical at 3 m										
Frequency (MHz)	Emission Level (dBuV/m)	Read Level (dBuV)	Limit (dBuV/m)	Margin (dB)	Antenna Factor (dB/m)	Cable Loss (dB)	Preamp Factor (dB)	Antenna Height (cm)	Table Angle (Degree)	Remark
5115.05	53.85	45.65	74	-20.15	34.09	8.1	33.99	100	2	Peak
5148.05	43.2	34.95	54	-10.8	34.12	8.13	34	100	2	Average
5220	98.49	90.1			34.17	8.22	34	100	2	Average
5220	106.31	97.92			34.17	8.22	34	100	2	Peak
5440.2	53.4	44.61	74	-20.6	34.35	8.48	34.04	100	2	Peak
5446.03	42.9	34.07	54	-11.1	34.36	8.51	34.04	100	2	Average

Remarks:

- Emission Level = Read Level + Antenna Factor + Cable Loss - Preamp Factor
Margin value = Emission level – Limit value
- 5220 MHz: Fundamental Frequency

EUT Test Condition		Measurement Detail	
Channel	Channel 48	Frequency Range	1 GHz ~ 40 GHz
Input Power	120 Vac, 60 Hz	Detector Function	Peak (PK) Average (AV)
Environmental Conditions	25 deg. C, 65 % RH	Tested By	Charles Hsiao

Antenna Polarity & Test Distance: Horizontal at 3 m										
Frequency (MHz)	Emission Level (dBuV/m)	Read Level (dBuV)	Limit (dBuV/m)	Margin (dB)	Antenna Factor (dB/m)	Cable Loss (dB)	Preamp Factor (dB)	Antenna Height (cm)	Table Angle (Degree)	Remark
5240	92.48	84.04			34.19	8.26	34.01	124	242	Average
5240	100.57	92.13			34.19	8.26	34.01	124	242	Peak
5385.97	53.06	44.38	74	-20.94	34.31	8.41	34.04	124	242	Peak
5447.68	42.75	33.92	54	-11.25	34.36	8.51	34.04	124	242	Average
10480	47.09	32.58	54	-6.91	37.19	12.53	35.21	132	332	Average
10480	56.05	41.54	74	-17.95	37.19	12.53	35.21	132	332	Peak

Antenna Polarity & Test Distance: Vertical at 3 m										
Frequency (MHz)	Emission Level (dBuV/m)	Read Level (dBuV)	Limit (dBuV/m)	Margin (dB)	Antenna Factor (dB/m)	Cable Loss (dB)	Preamp Factor (dB)	Antenna Height (cm)	Table Angle (Degree)	Remark
5240	98.89	90.45			34.19	8.26	34.01	100	2	Average
5240	106.33	97.89			34.19	8.26	34.01	100	2	Peak
5413.25	53.3	44.57	74	-20.7	34.33	8.44	34.04	100	2	Peak
5450.43	42.82	34	54	-11.18	34.36	8.51	34.05	100	2	Average
10480	46.56	32.05	54	-7.44	37.19	12.53	35.21	178	5	Average
10480	56.06	41.55	74	-17.94	37.19	12.53	35.21	178	5	Peak

Remarks:

- Emission Level = Read Level + Antenna Factor + Cable Loss - Preamp Factor
Margin value = Emission level – Limit value
- 5240 MHz: Fundamental Frequency

EUT Test Condition		Measurement Detail	
Channel	Channel 52	Frequency Range	1 GHz ~ 40 GHz
Input Power	120 Vac, 60 Hz	Detector Function	Peak (PK) Average (AV)
Environmental Conditions	25 deg. C, 65 % RH	Tested By	Charles Hsiao

Antenna Polarity & Test Distance: Horizontal at 3 m										
Frequency (MHz)	Emission Level (dBuV/m)	Read Level (dBuV)	Limit (dBuV/m)	Margin (dB)	Antenna Factor (dB/m)	Cable Loss (dB)	Preamp Factor (dB)	Antenna Height (cm)	Table Angle (Degree)	Remark
5132.6	43.24	35.02	54	-10.76	34.11	8.1	33.99	204	297	Average
5140.25	54.25	45.99	74	-19.75	34.12	8.13	33.99	204	297	Peak
5260	102.95	94.49			34.21	8.26	34.01	204	297	Average
5260	109.66	101.2			34.21	8.26	34.01	204	297	Peak
10520	47.6	33.01	54	-6.4	37.21	12.61	35.23	147	45	Average
10520	56.37	41.78	74	-17.63	37.21	12.61	35.23	147	45	Peak

Antenna Polarity & Test Distance: Vertical at 3 m										
Frequency (MHz)	Emission Level (dBuV/m)	Read Level (dBuV)	Limit (dBuV/m)	Margin (dB)	Antenna Factor (dB/m)	Cable Loss (dB)	Preamp Factor (dB)	Antenna Height (cm)	Table Angle (Degree)	Remark
5000.9	53.27	45.3	74	-20.73	34	7.94	33.97	210	281	Peak
5111.15	43.01	34.81	54	-10.99	34.09	8.1	33.99	210	281	Average
5260	100.71	92.25			34.21	8.26	34.01	210	281	Average
5260	107.02	98.56			34.21	8.26	34.01	210	281	Peak
10520	47.18	32.59	54	-6.82	37.21	12.61	35.23	183	359	Average
10520	58.18	43.59	74	-15.82	37.21	12.61	35.23	183	359	Peak

Remarks:

- Emission Level = Read Level + Antenna Factor + Cable Loss - Preamp Factor
Margin value = Emission level – Limit value
- 5260 MHz: Fundamental Frequency

EUT Test Condition		Measurement Detail	
Channel	Channel 60	Frequency Range	1 GHz ~ 40 GHz
Input Power	120 Vac, 60 Hz	Detector Function	Peak (PK) Average (AV)
Environmental Conditions	25 deg. C, 65 % RH	Tested By	Charles Hsiao

Antenna Polarity & Test Distance: Horizontal at 3 m										
Frequency (MHz)	Emission Level (dBuV/m)	Read Level (dBuV)	Limit (dBuV/m)	Margin (dB)	Antenna Factor (dB/m)	Cable Loss (dB)	Preamp Factor (dB)	Antenna Height (cm)	Table Angle (Degree)	Remark
5116.25	43.08	34.88	54	-10.92	34.09	8.1	33.99	204	297	Average
5118.35	53.92	45.72	74	-20.08	34.09	8.1	33.99	204	297	Peak
5300	102.77	94.23			34.24	8.32	34.02	204	297	Average
5300	109.25	100.71			34.24	8.32	34.02	204	297	Peak
5351.54	55.55	46.92	74	-18.45	34.28	8.38	34.03	204	297	Peak
5351.87	45.67	37.04	54	-8.33	34.28	8.38	34.03	204	297	Average

Antenna Polarity & Test Distance: Vertical at 3 m										
Frequency (MHz)	Emission Level (dBuV/m)	Read Level (dBuV)	Limit (dBuV/m)	Margin (dB)	Antenna Factor (dB/m)	Cable Loss (dB)	Preamp Factor (dB)	Antenna Height (cm)	Table Angle (Degree)	Remark
5038.4	54.08	46.01	74	-19.92	34.04	8	33.97	210	281	Peak
5115.5	42.89	34.69	54	-11.11	34.09	8.1	33.99	210	281	Average
5300	100.47	91.93			34.24	8.32	34.02	210	281	Average
5300	107.37	98.83			34.24	8.32	34.02	210	281	Peak
5351.98	43.96	35.33	54	-10.04	34.28	8.38	34.03	210	281	Average
5406.65	54.61	45.89	74	-19.39	34.32	8.44	34.04	210	281	Peak

Remarks:

- Emission Level = Read Level + Antenna Factor + Cable Loss - Preamp Factor
Margin value = Emission level – Limit value
- 5300 MHz: Fundamental Frequency

EUT Test Condition		Measurement Detail	
Channel	Channel 64	Frequency Range	1 GHz ~ 40 GHz
Input Power	120 Vac, 60 Hz	Detector Function	Peak (PK) Average (AV)
Environmental Conditions	25 deg. C, 65 % RH	Tested By	Charles Hsiao

Antenna Polarity & Test Distance: Horizontal at 3 m										
Frequency (MHz)	Emission Level (dBuV/m)	Read Level (dBuV)	Limit (dBuV/m)	Margin (dB)	Antenna Factor (dB/m)	Cable Loss (dB)	Preamp Factor (dB)	Antenna Height (cm)	Table Angle (Degree)	Remark
5320	102.1	93.52			34.25	8.35	34.02	204	297	Average
5320	109.22	100.64			34.25	8.35	34.02	204	297	Peak
5352.31	56.66	48.03	74	-17.34	34.28	8.38	34.03	204	297	Peak
5352.42	47.88	39.25	54	-6.12	34.28	8.38	34.03	204	297	Average
10640	47.38	32.65	54	-6.62	37.31	12.71	35.29	150	105	Average
10640	58.86	44.13	74	-15.14	37.31	12.71	35.29	150	105	Peak

Antenna Polarity & Test Distance: Vertical at 3 m										
Frequency (MHz)	Emission Level (dBuV/m)	Read Level (dBuV)	Limit (dBuV/m)	Margin (dB)	Antenna Factor (dB/m)	Cable Loss (dB)	Preamp Factor (dB)	Antenna Height (cm)	Table Angle (Degree)	Remark
5320	100.46	91.88			34.25	8.35	34.02	210	281	Average
5320	107.51	98.93			34.25	8.35	34.02	210	281	Peak
5350.66	44.88	36.25	54	-9.12	34.28	8.38	34.03	210	281	Average
5359.02	55.59	46.96	74	-18.41	34.28	8.38	34.03	210	281	Peak
10640	47.3	32.57	54	-6.7	37.31	12.71	35.29	178	255	Average
10640	56.48	41.75	74	-17.52	37.31	12.71	35.29	178	255	Peak

Remarks:

- Emission Level = Read Level + Antenna Factor + Cable Loss - Preamp Factor
Margin value = Emission level – Limit value
- 5320 MHz: Fundamental Frequency

EUT Test Condition		Measurement Detail	
Channel	Channel 100	Frequency Range	1 GHz ~ 40 GHz
Input Power	120 Vac, 60 Hz	Detector Function	Peak (PK) Average (AV)
Environmental Conditions	25 deg. C, 65 % RH	Tested By	Charles Hsiao

Antenna Polarity & Test Distance: Horizontal at 3 m										
Frequency (MHz)	Emission Level (dBuV/m)	Read Level (dBuV)	Limit (dBuV/m)	Margin (dB)	Antenna Factor (dB/m)	Cable Loss (dB)	Preamp Factor (dB)	Antenna Height (cm)	Table Angle (Degree)	Remark
5457.2	55.73	46.91	74	-18.27	34.36	8.51	34.05	115	349	Peak
5458	44.73	35.91	54	-9.27	34.36	8.51	34.05	115	349	Average
*5468.72	55.54	46.71	74	-18.46	34.37	8.51	34.05	115	349	Peak
*5469.84	44.64	35.81	54	-9.36	34.37	8.51	34.05	115	349	Average
5500	96.22	87.3			34.4	8.57	34.05	115	349	Average
5500	103.17	94.25			34.4	8.57	34.05	115	349	Peak
11000	48.63	33.55	54	-5.37	37.6	12.96	35.48	137	115	Average
11000	57.76	42.68	74	-16.24	37.6	12.96	35.48	137	115	Peak

Antenna Polarity & Test Distance: Vertical at 3 m										
Frequency (MHz)	Emission Level (dBuV/m)	Read Level (dBuV)	Limit (dBuV/m)	Margin (dB)	Antenna Factor (dB/m)	Cable Loss (dB)	Preamp Factor (dB)	Antenna Height (cm)	Table Angle (Degree)	Remark
5455.44	53.74	44.92	74	-20.26	34.36	8.51	34.05	182	263	Peak
5455.92	44.19	35.37	54	-9.81	34.36	8.51	34.05	182	263	Average
*5469.52	44.19	35.36	54	-9.81	34.37	8.51	34.05	182	263	Average
*5470.96	53.9	45.04	74	-20.1	34.37	8.54	34.05	182	263	Peak
5500	95.24	86.32			34.4	8.57	34.05	182	263	Average
5500	102.12	93.2			34.4	8.57	34.05	182	263	Peak
11000	48.72	33.64	54	-5.28	37.6	12.96	35.48	162	254	Average
11000	57.94	42.86	74	-16.06	37.6	12.96	35.48	162	254	Peak

Remarks:

- Emission Level = Read Level + Antenna Factor + Cable Loss - Preamp Factor
Margin value = Emission level – Limit value
- 5500 MHz: Fundamental Frequency
- *: Out of Restricted Band

EUT Test Condition		Measurement Detail	
Channel	Channel 116	Frequency Range	1 GHz ~ 40 GHz
Input Power	120 Vac, 60 Hz	Detector Function	Peak (PK) Average (AV)
Environmental Conditions	25 deg. C, 65 % RH	Tested By	Charles Hsiao

Antenna Polarity & Test Distance: Horizontal at 3 m										
Frequency (MHz)	Emission Level (dBuV/m)	Read Level (dBuV)	Limit (dBuV/m)	Margin (dB)	Antenna Factor (dB/m)	Cable Loss (dB)	Preamp Factor (dB)	Antenna Height (cm)	Table Angle (Degree)	Remark
5399.76	53.39	44.67	74	-20.61	34.32	8.44	34.04	113	350	Peak
5453.36	43.18	34.36	54	-10.82	34.36	8.51	34.05	113	350	Average
*5469.36	43.13	34.3	54	-10.87	34.37	8.51	34.05	113	350	Average
*5470.48	51.49	42.66	74	-22.51	34.37	8.51	34.05	113	350	Peak
5580	96.62	87.63			34.47	8.6	34.08	113	350	Average
5580	104	95.01			34.47	8.6	34.08	113	350	Peak
*5724.52	43.36	34.2	54	-10.64	34.62	8.65	34.11	113	350	Average
*5725.24	54.16	45	74	-19.84	34.62	8.65	34.11	113	350	Peak

Antenna Polarity & Test Distance: Vertical at 3 m										
Frequency (MHz)	Emission Level (dBuV/m)	Read Level (dBuV)	Limit (dBuV/m)	Margin (dB)	Antenna Factor (dB/m)	Cable Loss (dB)	Preamp Factor (dB)	Antenna Height (cm)	Table Angle (Degree)	Remark
5382.96	53.31	44.63	74	-20.69	34.31	8.41	34.04	188	274	Peak
5454.32	43.05	34.23	54	-10.95	34.36	8.51	34.05	188	274	Average
*5468.88	53.2	44.37	74	-20.8	34.37	8.51	34.05	188	274	Peak
*5470.48	43.51	34.68	54	-10.49	34.37	8.51	34.05	188	274	Average
5580	95.9	86.91			34.47	8.6	34.08	188	274	Average
5580	103.68	94.69			34.47	8.6	34.08	188	274	Peak
*5724.04	43.33	34.17	54	-10.67	34.62	8.65	34.11	188	274	Average
*5724.2	53.52	44.36	74	-20.48	34.62	8.65	34.11	188	274	Peak

Remarks:

- Emission Level = Read Level + Antenna Factor + Cable Loss - Preamp Factor
Margin value = Emission level – Limit value
- 5580 MHz: Fundamental Frequency
- *: Out of Restricted Band

EUT Test Condition		Measurement Detail	
Channel	Channel 140	Frequency Range	1 GHz ~ 40 GHz
Input Power	120 Vac, 60 Hz	Detector Function	Peak (PK) Average (AV)
Environmental Conditions	25 deg. C, 65 % RH	Tested By	Charles Hsiao

Antenna Polarity & Test Distance: Horizontal at 3 m										
Frequency (MHz)	Emission Level (dBuV/m)	Read Level (dBuV)	Limit (dBuV/m)	Margin (dB)	Antenna Factor (dB/m)	Cable Loss (dB)	Preamp Factor (dB)	Antenna Height (cm)	Table Angle (Degree)	Remark
5700	96.68	87.55			34.59	8.64	34.1	100	350	Average
5700	103.83	94.7			34.59	8.64	34.1	100	350	Peak
*5724.68	44.43	35.27	54	-9.57	34.62	8.65	34.11	100	350	Average
*5725.96	56.15	46.99	74	-17.85	34.62	8.65	34.11	100	350	Peak
11400	48.54	33.44	54	-5.46	37.84	12.67	35.41	134	172	Average
11400	57.04	41.94	74	-16.96	37.84	12.67	35.41	134	172	Peak

Antenna Polarity & Test Distance: Vertical at 3 m										
Frequency (MHz)	Emission Level (dBuV/m)	Read Level (dBuV)	Limit (dBuV/m)	Margin (dB)	Antenna Factor (dB/m)	Cable Loss (dB)	Preamp Factor (dB)	Antenna Height (cm)	Table Angle (Degree)	Remark
5700	96.04	86.91			34.59	8.64	34.1	216	267	Average
5700	103.13	94			34.59	8.64	34.1	216	267	Peak
*5725.08	44.54	35.38	54	-9.46	34.62	8.65	34.11	216	267	Average
*5726.04	54.47	45.31	74	-19.53	34.62	8.65	34.11	216	267	Peak
11400	47.85	32.75	54	-6.15	37.84	12.67	35.41	196	145	Average
11400	56.78	41.68	74	-17.22	37.84	12.67	35.41	196	145	Peak

Remarks:

- Emission Level = Read Level + Antenna Factor + Cable Loss - Preamp Factor
Margin value = Emission level – Limit value
- 5700 MHz: Fundamental Frequency
- *: Out of Restricted Band

EUT Test Condition		Measurement Detail	
Channel	Channel 149	Frequency Range	1 GHz ~ 40 GHz
Input Power	120 Vac, 60 Hz	Detector Function	Peak (PK) Average (AV)
Environmental Conditions	25 deg. C, 65 % RH	Tested By	Charles Hsiao

<Spurious Emission>

Antenna Polarity & Test Distance: Horizontal at 3 m										
Frequency (MHz)	Emission Level (dBuV/m)	Read Level (dBuV)	Limit (dBuV/m)	Margin (dB)	Antenna Factor (dB/m)	Cable Loss (dB)	Preamp Factor (dB)	Antenna Height (cm)	Table Angle (Degree)	Remark
5745	100	90.81			34.64	8.66	34.11	200	299	Average
5745	107.51	98.32			34.64	8.66	34.11	200	299	Peak
11490	47.92	32.8	54	-6.08	37.89	12.62	35.39	129	118	Average
11490	57.51	42.39	74	-16.49	37.89	12.62	35.39	129	118	Peak
Antenna Polarity & Test Distance: Vertical at 3 m										
Frequency (MHz)	Emission Level (dBuV/m)	Read Level (dBuV)	Limit (dBuV/m)	Margin (dB)	Antenna Factor (dB/m)	Cable Loss (dB)	Preamp Factor (dB)	Antenna Height (cm)	Table Angle (Degree)	Remark
5745	94.18	84.99			34.64	8.66	34.11	145	287	Average
5745	101.76	92.57			34.64	8.66	34.11	145	287	Peak
11490	47.6	32.48	54	-6.4	37.89	12.62	35.39	141	339	Average
11490	56.45	41.33	74	-17.55	37.89	12.62	35.39	141	339	Peak

<Out of Band Emission (OOBE)>

Antenna Polarity & Test Distance: Horizontal at 3 m										
Frequency (MHz)	Emission Level (dBuV/m)	Read Level (dBuV)	Limit (dBuV/m)	Margin (dB)	Antenna Factor (dB/m)	Cable Loss (dB)	Preamp Factor (dB)	Antenna Height (cm)	Table Angle (Degree)	Remark
*5612.35	43.11	34.08	54	-10.89	34.5	8.61	34.08	200	299	Average
*5612.35	54.3	45.27	74	-19.7	34.5	8.61	34.08	200	299	Peak
5654.35	53.51	44.42	76.71	-23.2	34.56	8.63	34.1	200	299	Peak
5923.15	53.26	43.86	75.15	-21.89	34.83	8.73	34.16	200	299	Peak
*6004.525	43.49	34	54	-10.51	34.9	8.76	34.17	200	299	Average
*6004.525	54.3	44.81	74	-19.7	34.9	8.76	34.17	200	299	Peak
Antenna Polarity & Test Distance: Vertical at 3 m										
Frequency (MHz)	Emission Level (dBuV/m)	Read Level (dBuV)	Limit (dBuV/m)	Margin (dB)	Antenna Factor (dB/m)	Cable Loss (dB)	Preamp Factor (dB)	Antenna Height (cm)	Table Angle (Degree)	Remark
*5599.75	42.92	33.9	54	-11.08	34.5	8.6	34.08	145	287	Average
*5599.75	53.36	44.34	74	-20.64	34.5	8.6	34.08	145	287	Peak
5653.3	51.98	42.88	76.06	-24.08	34.56	8.63	34.09	145	287	Peak
5922.1	52.64	43.24	75.81	-23.17	34.83	8.73	34.16	145	287	Peak
*5953.6	43.61	34.18	54	-10.39	34.85	8.74	34.16	145	287	Average
*5953.6	54.47	45.04	74	-19.53	34.85	8.74	34.16	145	287	Peak

Remarks:

- Emission Level = Read Level + Antenna Factor + Cable Loss - Preamp Factor
Margin value = Emission level – Limit value
- 5745 MHz: Fundamental Frequency
- *: Out of Restricted Band

EUT Test Condition		Measurement Detail	
Channel	Channel 157	Frequency Range	1 GHz ~ 40 GHz
Input Power	120 Vac, 60 Hz	Detector Function	Peak (PK) Average (AV)
Environmental Conditions	25 deg. C, 65 % RH	Tested By	Charles Hsiao

<Spurious Emission>

Antenna Polarity & Test Distance: Horizontal at 3 m										
Frequency (MHz)	Emission Level (dBuV/m)	Read Level (dBuV)	Limit (dBuV/m)	Margin (dB)	Antenna Factor (dB/m)	Cable Loss (dB)	Preamp Factor (dB)	Antenna Height (cm)	Table Angle (Degree)	Remark
5785	100.47	91.24			34.68	8.68	34.13	200	299	Average
5785	107.42	98.19			34.68	8.68	34.13	200	299	Peak
11570	47.96	32.65	54	-6.04	38	12.68	35.37	187	259	Average
11570	58.34	43.03	74	-15.66	38	12.68	35.37	187	259	Peak
Antenna Polarity & Test Distance: Vertical at 3 m										
Frequency (MHz)	Emission Level (dBuV/m)	Read Level (dBuV)	Limit (dBuV/m)	Margin (dB)	Antenna Factor (dB/m)	Cable Loss (dB)	Preamp Factor (dB)	Antenna Height (cm)	Table Angle (Degree)	Remark
5785	93.59	84.36			34.68	8.68	34.13	145	287	Average
5785	101.33	92.1			34.68	8.68	34.13	145	287	Peak
11570	47.88	32.57	54	-6.12	38	12.68	35.37	118	242	Average
11570	56.68	41.37	74	-17.32	38	12.68	35.37	118	242	Peak

<Out of Band Emission (OOBE)>

Antenna Polarity & Test Distance: Horizontal at 3 m										
Frequency (MHz)	Emission Level (dBuV/m)	Read Level (dBuV)	Limit (dBuV/m)	Margin (dB)	Antenna Factor (dB/m)	Cable Loss (dB)	Preamp Factor (dB)	Antenna Height (cm)	Table Angle (Degree)	Remark
*5633.875	43.75	34.68	54	-10.25	34.54	8.62	34.09	200	299	Average
*5633.875	53.13	44.06	74	-20.87	34.54	8.62	34.09	200	299	Peak
5652.25	52.55	43.46	75.4	-22.85	34.56	8.62	34.09	200	299	Peak
5921.575	52.02	42.62	76.14	-24.12	34.83	8.73	34.16	200	299	Peak
*6006.625	44.18	34.67	54	-9.82	34.92	8.76	34.17	200	299	Average
*6006.625	54.72	45.21	74	-19.28	34.92	8.76	34.17	200	299	Peak
Antenna Polarity & Test Distance: Vertical at 3 m										
Frequency (MHz)	Emission Level (dBuV/m)	Read Level (dBuV)	Limit (dBuV/m)	Margin (dB)	Antenna Factor (dB/m)	Cable Loss (dB)	Preamp Factor (dB)	Antenna Height (cm)	Table Angle (Degree)	Remark
*5637.025	43.71	34.64	54	-10.29	34.54	8.62	34.09	145	287	Average
*5637.025	53.39	44.32	74	-20.61	34.54	8.62	34.09	145	287	Peak
5660.125	54.51	45.42	80.32	-25.81	34.56	8.63	34.1	145	287	Peak
5924.2	52.88	43.48	74.5	-21.62	34.83	8.73	34.16	145	287	Peak
*5962.525	44.03	34.59	54	-9.97	34.87	8.74	34.17	145	287	Average
*5962.525	55.02	45.58	74	-18.98	34.87	8.74	34.17	145	287	Peak

Remarks:

- Emission Level = Read Level + Antenna Factor + Cable Loss - Preamp Factor
Margin value = Emission level – Limit value
- 5785 MHz: Fundamental Frequency
- *: Out of Restricted Band

EUT Test Condition		Measurement Detail	
Channel	Channel 165	Frequency Range	1 GHz ~ 40 GHz
Input Power	120 Vac, 60 Hz	Detector Function	Peak (PK) Average (AV)
Environmental Conditions	25 deg. C, 65 % RH	Tested By	Charles Hsiao

<Spurious Emission>

Antenna Polarity & Test Distance: Horizontal at 3 m										
Frequency (MHz)	Emission Level (dBuV/m)	Read Level (dBuV)	Limit (dBuV/m)	Margin (dB)	Antenna Factor (dB/m)	Cable Loss (dB)	Preamp Factor (dB)	Antenna Height (cm)	Table Angle (Degree)	Remark
5825	100.36	91.07			34.73	8.69	34.13	200	299	Average
5825	107.47	98.18			34.73	8.69	34.13	200	299	Peak
11650	48.19	32.66	54	-5.81	38.09	12.8	35.36	180	178	Average
11650	56.66	41.13	74	-17.34	38.09	12.8	35.36	180	178	Peak
Antenna Polarity & Test Distance: Vertical at 3 m										
Frequency (MHz)	Emission Level (dBuV/m)	Read Level (dBuV)	Limit (dBuV/m)	Margin (dB)	Antenna Factor (dB/m)	Cable Loss (dB)	Preamp Factor (dB)	Antenna Height (cm)	Table Angle (Degree)	Remark
5825	94.85	85.56			34.73	8.69	34.13	145	287	Average
5825	101.03	91.74			34.73	8.69	34.13	145	287	Peak
11650	48.13	32.6	54	-5.87	38.09	12.8	35.36	157	329	Average
11650	57.39	41.86	74	-16.61	38.09	12.8	35.36	157	329	Peak

<Out of Band Emission (OOBE)>

Antenna Polarity & Test Distance: Horizontal at 3 m										
Frequency (MHz)	Emission Level (dBuV/m)	Read Level (dBuV)	Limit (dBuV/m)	Margin (dB)	Antenna Factor (dB/m)	Cable Loss (dB)	Preamp Factor (dB)	Antenna Height (cm)	Table Angle (Degree)	Remark
*5520.475	43.48	34.55	54	-10.52	34.42	8.57	34.06	200	299	Average
*5520.475	54.21	45.28	74	-19.79	34.42	8.57	34.06	200	299	Peak
5651.725	52.58	43.49	75.08	-22.5	34.56	8.62	34.09	200	299	Peak
5923.15	53.15	43.75	75.15	-22	34.83	8.73	34.16	200	299	Peak
*5973.025	44.03	34.57	54	-9.97	34.88	8.75	34.17	200	299	Average
*5973.025	53.76	44.3	74	-20.24	34.88	8.75	34.17	200	299	Peak
Antenna Polarity & Test Distance: Vertical at 3 m										
Frequency (MHz)	Emission Level (dBuV/m)	Read Level (dBuV)	Limit (dBuV/m)	Margin (dB)	Antenna Factor (dB/m)	Cable Loss (dB)	Preamp Factor (dB)	Antenna Height (cm)	Table Angle (Degree)	Remark
*5642.275	43.49	34.42	54	-10.51	34.54	8.62	34.09	145	287	Average
*5642.275	53.91	44.84	74	-20.09	34.54	8.62	34.09	145	287	Peak
5653.825	52.55	43.46	76.39	-23.84	34.56	8.63	34.1	145	287	Peak
5920.525	50.63	41.25	76.79	-26.16	34.81	8.73	34.16	145	287	Peak
*6000.85	44.06	34.57	54	-9.94	34.9	8.76	34.17	145	287	Average
*6000.85	54.11	44.62	74	-19.89	34.9	8.76	34.17	145	287	Peak

Remarks:

- Emission Level = Read Level + Antenna Factor + Cable Loss - Preamp Factor
Margin value = Emission level – Limit value
- 5825 MHz: Fundamental Frequency
- *: Out of Restricted Band

802.11n (HT20)

EUT Test Condition		Measurement Detail	
Channel	Channel 36	Frequency Range	1 GHz ~ 40 GHz
Input Power	120 Vac, 60 Hz	Detector Function	Peak (PK) Average (AV)
Environmental Conditions	25 deg. C, 65 % RH	Tested By	Charles Hsiao

Antenna Polarity & Test Distance: Horizontal at 3 m

Frequency (MHz)	Emission Level (dBuV/m)	Read Level (dBuV)	Limit (dBuV/m)	Margin (dB)	Antenna Factor (dB/m)	Cable Loss (dB)	Preamp Factor (dB)	Antenna Height (cm)	Table Angle (Degree)	Remark
5138.15	54.22	45.97	74	-19.78	34.11	8.13	33.99	124	242	Peak
5149.1	43.2	34.95	54	-10.8	34.12	8.13	34	124	242	Average
5180	92.88	84.57			34.15	8.16	34	124	242	Average
5180	100.01	91.7			34.15	8.16	34	124	242	Peak
10360	46.41	32.11	54	-7.59	37.12	12.3	35.12	158	222	Average
10360	55.58	41.28	74	-18.42	37.12	12.3	35.12	158	222	Peak

Antenna Polarity & Test Distance: Vertical at 3 m

Frequency (MHz)	Emission Level (dBuV/m)	Read Level (dBuV)	Limit (dBuV/m)	Margin (dB)	Antenna Factor (dB/m)	Cable Loss (dB)	Preamp Factor (dB)	Antenna Height (cm)	Table Angle (Degree)	Remark
5145.5	56.16	47.91	74	-17.84	34.12	8.13	34	100	2	Peak
5149.85	45.84	37.59	54	-8.16	34.12	8.13	34	100	2	Average
5180	99.53	91.22			34.15	8.16	34	100	2	Average
5180	107.32	99.01			34.15	8.16	34	100	2	Peak
10360	46.25	31.95	54	-7.75	37.12	12.3	35.12	111	137	Average
10360	56.17	41.87	74	-17.83	37.12	12.3	35.12	111	137	Peak

Remarks:

- Emission Level = Read Level + Antenna Factor + Cable Loss - Preamp Factor
Margin value = Emission level – Limit value
- 5180 MHz: Fundamental Frequency

EUT Test Condition		Measurement Detail	
Channel	Channel 44	Frequency Range	1 GHz ~ 40 GHz
Input Power	120 Vac, 60 Hz	Detector Function	Peak (PK) Average (AV)
Environmental Conditions	25 deg. C, 65 % RH	Tested By	Charles Hsiao

Antenna Polarity & Test Distance: Horizontal at 3 m										
Frequency (MHz)	Emission Level (dBuV/m)	Read Level (dBuV)	Limit (dBuV/m)	Margin (dB)	Antenna Factor (dB/m)	Cable Loss (dB)	Preamp Factor (dB)	Antenna Height (cm)	Table Angle (Degree)	Remark
5129	42.8	34.58	54	-11.2	34.11	8.1	33.99	124	242	Average
5148.5	53.17	44.92	74	-20.83	34.12	8.13	34	124	242	Peak
5220	93.36	84.97			34.17	8.22	34	124	242	Average
5220	101.35	92.96			34.17	8.22	34	124	242	Peak
5391.58	53.28	44.6	74	-20.72	34.31	8.41	34.04	124	242	Peak
5449.22	42.83	34	54	-11.17	34.36	8.51	34.04	124	242	Average

Antenna Polarity & Test Distance: Vertical at 3 m										
Frequency (MHz)	Emission Level (dBuV/m)	Read Level (dBuV)	Limit (dBuV/m)	Margin (dB)	Antenna Factor (dB/m)	Cable Loss (dB)	Preamp Factor (dB)	Antenna Height (cm)	Table Angle (Degree)	Remark
5147.75	43.36	35.11	54	-10.64	34.12	8.13	34	100	2	Average
5148.35	54.13	45.88	74	-19.87	34.12	8.13	34	100	2	Peak
5220	99.75	91.36			34.17	8.22	34	100	2	Average
5220	107.57	99.18			34.17	8.22	34	100	2	Peak
5405.88	54.61	45.89	74	-19.39	34.32	8.44	34.04	100	2	Peak
5448.89	42.84	34.01	54	-11.16	34.36	8.51	34.04	100	2	Average

Remarks:

- Emission Level = Read Level + Antenna Factor + Cable Loss - Preamp Factor
Margin value = Emission level – Limit value
- 5220 MHz: Fundamental Frequency

EUT Test Condition		Measurement Detail	
Channel	Channel 48	Frequency Range	1 GHz ~ 40 GHz
Input Power	120 Vac, 60 Hz	Detector Function	Peak (PK) Average (AV)
Environmental Conditions	25 deg. C, 65 % RH	Tested By	Charles Hsiao

Antenna Polarity & Test Distance: Horizontal at 3 m										
Frequency (MHz)	Emission Level (dBuV/m)	Read Level (dBuV)	Limit (dBuV/m)	Margin (dB)	Antenna Factor (dB/m)	Cable Loss (dB)	Preamp Factor (dB)	Antenna Height (cm)	Table Angle (Degree)	Remark
5240	93.58	85.14			34.19	8.26	34.01	124	242	Average
5240	101.4	92.96			34.19	8.26	34.01	124	242	Peak
5446.47	53.43	44.6	74	-20.57	34.36	8.51	34.04	124	242	Peak
5447.13	42.84	34.01	54	-11.16	34.36	8.51	34.04	124	242	Average
10480	46.51	32	54	-7.49	37.19	12.53	35.21	156	308	Average
10480	56.31	41.8	74	-17.69	37.19	12.53	35.21	156	308	Peak

Antenna Polarity & Test Distance: Vertical at 3 m										
Frequency (MHz)	Emission Level (dBuV/m)	Read Level (dBuV)	Limit (dBuV/m)	Margin (dB)	Antenna Factor (dB/m)	Cable Loss (dB)	Preamp Factor (dB)	Antenna Height (cm)	Table Angle (Degree)	Remark
5240	99.48	91.04			34.19	8.26	34.01	100	2	Average
5240	107.54	99.1			34.19	8.26	34.01	100	2	Peak
5393.56	53.36	44.65	74	-20.64	34.31	8.44	34.04	100	2	Peak
5448.34	42.92	34.09	54	-11.08	34.36	8.51	34.04	100	2	Average
10480	46.66	32.15	54	-7.34	37.19	12.53	35.21	104	248	Average
10480	56.22	41.71	74	-17.78	37.19	12.53	35.21	104	248	Peak

Remarks:

- Emission Level = Read Level + Antenna Factor + Cable Loss - Preamp Factor
Margin value = Emission level – Limit value
- 5240 MHz: Fundamental Frequency

EUT Test Condition		Measurement Detail	
Channel	Channel 52	Frequency Range	1 GHz ~ 40 GHz
Input Power	120 Vac, 60 Hz	Detector Function	Peak (PK) Average (AV)
Environmental Conditions	25 deg. C, 65 % RH	Tested By	Charles Hsiao

Antenna Polarity & Test Distance: Horizontal at 3 m										
Frequency (MHz)	Emission Level (dBuV/m)	Read Level (dBuV)	Limit (dBuV/m)	Margin (dB)	Antenna Factor (dB/m)	Cable Loss (dB)	Preamp Factor (dB)	Antenna Height (cm)	Table Angle (Degree)	Remark
5121.2	53.83	45.63	74	-20.17	34.09	8.1	33.99	204	297	Peak
5121.95	43.27	35.07	54	-10.73	34.09	8.1	33.99	204	297	Average
5260	102.49	94.03			34.21	8.26	34.01	204	297	Average
5260	109.08	100.62			34.21	8.26	34.01	204	297	Peak
10520	46.94	32.35	54	-7.06	37.21	12.61	35.23	160	260	Average
10520	57.6	43.01	74	-16.4	37.21	12.61	35.23	160	260	Peak

Antenna Polarity & Test Distance: Vertical at 3 m										
Frequency (MHz)	Emission Level (dBuV/m)	Read Level (dBuV)	Limit (dBuV/m)	Margin (dB)	Antenna Factor (dB/m)	Cable Loss (dB)	Preamp Factor (dB)	Antenna Height (cm)	Table Angle (Degree)	Remark
5087.9	53.69	45.53	74	-20.31	34.07	8.07	33.98	210	281	Peak
5102.3	42.91	34.75	54	-11.09	34.08	8.07	33.99	210	281	Average
5260	100.55	92.09			34.21	8.26	34.01	210	281	Average
5260	107.45	98.99			34.21	8.26	34.01	210	281	Peak
10520	46.65	32.06	54	-7.35	37.21	12.61	35.23	174	114	Average
10520	56.7	42.11	74	-17.3	37.21	12.61	35.23	174	114	Peak

Remarks:

- Emission Level = Read Level + Antenna Factor + Cable Loss - Preamp Factor
Margin value = Emission level – Limit value
- 5260 MHz: Fundamental Frequency

EUT Test Condition		Measurement Detail	
Channel	Channel 60	Frequency Range	1 GHz ~ 40 GHz
Input Power	120 Vac, 60 Hz	Detector Function	Peak (PK) Average (AV)
Environmental Conditions	25 deg. C, 65 % RH	Tested By	Charles Hsiao

Antenna Polarity & Test Distance: Horizontal at 3 m										
Frequency (MHz)	Emission Level (dBuV/m)	Read Level (dBuV)	Limit (dBuV/m)	Margin (dB)	Antenna Factor (dB/m)	Cable Loss (dB)	Preamp Factor (dB)	Antenna Height (cm)	Table Angle (Degree)	Remark
5028.65	53.79	45.76	74	-20.21	34.03	7.97	33.97	204	297	Peak
5127.5	43.23	35.01	54	-10.77	34.11	8.1	33.99	204	297	Average
5300	102.7	94.16			34.24	8.32	34.02	204	297	Average
5300	109.67	101.13			34.24	8.32	34.02	204	297	Peak
5350.11	45.41	36.78	54	-8.59	34.28	8.38	34.03	204	297	Average
5351.43	56.07	47.44	74	-17.93	34.28	8.38	34.03	204	297	Peak
Antenna Polarity & Test Distance: Vertical at 3 m										
Frequency (MHz)	Emission Level (dBuV/m)	Read Level (dBuV)	Limit (dBuV/m)	Margin (dB)	Antenna Factor (dB/m)	Cable Loss (dB)	Preamp Factor (dB)	Antenna Height (cm)	Table Angle (Degree)	Remark
5128.4	54.28	46.06	74	-19.72	34.11	8.1	33.99	210	281	Peak
5138	42.97	34.72	54	-11.03	34.11	8.13	33.99	210	281	Average
5300	100.56	92.02			34.24	8.32	34.02	210	281	Average
5300	107.78	99.24			34.24	8.32	34.02	210	281	Peak
5353.08	43.89	35.26	54	-10.11	34.28	8.38	34.03	210	281	Average
5407.64	54.18	45.46	74	-19.82	34.32	8.44	34.04	210	281	Peak

Remarks:

- Emission Level = Read Level + Antenna Factor + Cable Loss - Preamp Factor
Margin value = Emission level – Limit value
- 5300 MHz: Fundamental Frequency

EUT Test Condition		Measurement Detail	
Channel	Channel 64	Frequency Range	1 GHz ~ 40 GHz
Input Power	120 Vac, 60 Hz	Detector Function	Peak (PK) Average (AV)
Environmental Conditions	25 deg. C, 65 % RH	Tested By	Charles Hsiao

Antenna Polarity & Test Distance: Horizontal at 3 m										
Frequency (MHz)	Emission Level (dBuV/m)	Read Level (dBuV)	Limit (dBuV/m)	Margin (dB)	Antenna Factor (dB/m)	Cable Loss (dB)	Preamp Factor (dB)	Antenna Height (cm)	Table Angle (Degree)	Remark
5320	102.69	94.11			34.25	8.35	34.02	204	297	Average
5320	109.48	100.9			34.25	8.35	34.02	204	297	Peak
5350.33	47.85	39.22	54	-6.15	34.28	8.38	34.03	204	297	Average
5373.32	56.53	47.87	74	-17.47	34.29	8.41	34.04	204	297	Peak
10640	47.02	32.29	54	-6.98	37.31	12.71	35.29	159	285	Average
10640	56.6	41.87	74	-17.4	37.31	12.71	35.29	159	285	Peak

Antenna Polarity & Test Distance: Vertical at 3 m										
Frequency (MHz)	Emission Level (dBuV/m)	Read Level (dBuV)	Limit (dBuV/m)	Margin (dB)	Antenna Factor (dB/m)	Cable Loss (dB)	Preamp Factor (dB)	Antenna Height (cm)	Table Angle (Degree)	Remark
5320	100.36	91.78			34.25	8.35	34.02	210	281	Average
5320	107.19	98.61			34.25	8.35	34.02	210	281	Peak
5351.54	44.93	36.3	54	-9.07	34.28	8.38	34.03	210	281	Average
5354.84	56.06	47.43	74	-17.94	34.28	8.38	34.03	210	281	Peak
10640	46.77	32.04	54	-7.23	37.31	12.71	35.29	133	218	Average
10640	57.33	42.6	74	-16.67	37.31	12.71	35.29	133	218	Peak

Remarks:

- Emission Level = Read Level + Antenna Factor + Cable Loss - Preamp Factor
Margin value = Emission level – Limit value
- 5320 MHz: Fundamental Frequency

EUT Test Condition		Measurement Detail	
Channel	Channel 100	Frequency Range	1 GHz ~ 40 GHz
Input Power	120 Vac, 60 Hz	Detector Function	Peak (PK) Average (AV)
Environmental Conditions	25 deg. C, 65 % RH	Tested By	Charles Hsiao

Antenna Polarity & Test Distance: Horizontal at 3 m										
Frequency (MHz)	Emission Level (dBuV/m)	Read Level (dBuV)	Limit (dBuV/m)	Margin (dB)	Antenna Factor (dB/m)	Cable Loss (dB)	Preamp Factor (dB)	Antenna Height (cm)	Table Angle (Degree)	Remark
5448.88	54.53	45.7	74	-19.47	34.36	8.51	34.04	115	349	Peak
5459.28	44.87	36.05	54	-9.13	34.36	8.51	34.05	115	349	Average
*5469.2	44.68	35.85	54	-9.32	34.37	8.51	34.05	115	349	Average
*5470	54.16	45.33	74	-19.84	34.37	8.51	34.05	115	349	Peak
5500	96.36	87.44			34.4	8.57	34.05	115	349	Average
5500	103.78	94.86			34.4	8.57	34.05	115	349	Peak
11000	47.75	32.67	54	-6.25	37.6	12.96	35.48	162	94	Average
11000	56.71	41.63	74	-17.29	37.6	12.96	35.48	162	94	Peak
Antenna Polarity & Test Distance: Vertical at 3 m										
Frequency (MHz)	Emission Level (dBuV/m)	Read Level (dBuV)	Limit (dBuV/m)	Margin (dB)	Antenna Factor (dB/m)	Cable Loss (dB)	Preamp Factor (dB)	Antenna Height (cm)	Table Angle (Degree)	Remark
5414.32	55.04	46.31	74	-18.96	34.33	8.44	34.04	182	263	Peak
5459.28	44.35	35.53	54	-9.65	34.36	8.51	34.05	182	263	Average
*5470.16	53.62	44.79	74	-20.38	34.37	8.51	34.05	182	263	Peak
*5470.32	44.32	35.49	54	-9.68	34.37	8.51	34.05	182	263	Average
5500	95.39	86.47			34.4	8.57	34.05	182	263	Average
5500	102.58	93.66			34.4	8.57	34.05	182	263	Peak
11000	47.86	32.78	54	-6.14	37.6	12.96	35.48	187	114	Average
11000	56.94	41.86	74	-17.06	37.6	12.96	35.48	187	114	Peak

Remarks:

- Emission Level = Read Level + Antenna Factor + Cable Loss - Preamp Factor
Margin value = Emission level – Limit value
- 5500 MHz: Fundamental Frequency
- *: Out of Restricted Band

EUT Test Condition		Measurement Detail	
Channel	Channel 116	Frequency Range	1 GHz ~ 40 GHz
Input Power	120 Vac, 60 Hz	Detector Function	Peak (PK) Average (AV)
Environmental Conditions	25 deg. C, 65 % RH	Tested By	Charles Hsiao

Antenna Polarity & Test Distance: Horizontal at 3 m										
Frequency (MHz)	Emission Level (dBuV/m)	Read Level (dBuV)	Limit (dBuV/m)	Margin (dB)	Antenna Factor (dB/m)	Cable Loss (dB)	Preamp Factor (dB)	Antenna Height (cm)	Table Angle (Degree)	Remark
5350.64	54.03	45.4	74	-19.97	34.28	8.38	34.03	113	350	Peak
5445.52	43.06	34.23	54	-10.94	34.36	8.51	34.04	113	350	Average
*5470.32	51.88	43.05	74	-22.12	34.37	8.51	34.05	113	350	Peak
*5470.8	42.96	34.1	54	-11.04	34.37	8.54	34.05	113	350	Average
5580	96.81	87.82			34.47	8.6	34.08	113	350	Average
5580	104.28	95.29			34.47	8.6	34.08	113	350	Peak
*5724.04	53.33	44.17	74	-20.67	34.62	8.65	34.11	113	350	Peak
*5726.04	43.22	34.06	54	-10.78	34.62	8.65	34.11	113	350	Average

Antenna Polarity & Test Distance: Vertical at 3 m										
Frequency (MHz)	Emission Level (dBuV/m)	Read Level (dBuV)	Limit (dBuV/m)	Margin (dB)	Antenna Factor (dB/m)	Cable Loss (dB)	Preamp Factor (dB)	Antenna Height (cm)	Table Angle (Degree)	Remark
5365.2	54.12	45.48	74	-19.88	34.29	8.38	34.03	188	276	Peak
5458.8	43.06	34.24	54	-10.94	34.36	8.51	34.05	188	276	Average
*5469.36	52.48	43.65	74	-21.52	34.37	8.51	34.05	188	276	Peak
*5469.84	42.95	34.12	54	-11.05	34.37	8.51	34.05	188	276	Average
5580	96.08	87.09			34.47	8.6	34.08	188	276	Average
5580	103.82	94.83			34.47	8.6	34.08	188	276	Peak
*5724.2	53.13	43.97	74	-20.87	34.62	8.65	34.11	188	276	Peak
*5725.88	43.24	34.08	54	-10.76	34.62	8.65	34.11	188	276	Average

Remarks:

- Emission Level = Read Level + Antenna Factor + Cable Loss - Preamp Factor
Margin value = Emission level – Limit value
- 5580 MHz: Fundamental Frequency
- *: Out of Restricted Band

EUT Test Condition		Measurement Detail	
Channel	Channel 140	Frequency Range	1 GHz ~ 40 GHz
Input Power	120 Vac, 60 Hz	Detector Function	Peak (PK) Average (AV)
Environmental Conditions	25 deg. C, 65 % RH	Tested By	Charles Hsiao

Antenna Polarity & Test Distance: Horizontal at 3 m										
Frequency (MHz)	Emission Level (dBuV/m)	Read Level (dBuV)	Limit (dBuV/m)	Margin (dB)	Antenna Factor (dB/m)	Cable Loss (dB)	Preamp Factor (dB)	Antenna Height (cm)	Table Angle (Degree)	Remark
5700	96.74	87.61			34.59	8.64	34.1	100	350	Average
5700	104.53	95.4			34.59	8.64	34.1	100	350	Peak
*5725.24	53.93	44.77	74	-20.07	34.62	8.65	34.11	100	350	Peak
*5725.56	44.63	35.47	54	-9.37	34.62	8.65	34.11	100	350	Average
11400	47.95	32.85	54	-6.05	37.84	12.67	35.41	164	127	Average
11400	56.8	41.7	74	-17.2	37.84	12.67	35.41	164	127	Peak

Antenna Polarity & Test Distance: Vertical at 3 m										
Frequency (MHz)	Emission Level (dBuV/m)	Read Level (dBuV)	Limit (dBuV/m)	Margin (dB)	Antenna Factor (dB/m)	Cable Loss (dB)	Preamp Factor (dB)	Antenna Height (cm)	Table Angle (Degree)	Remark
5700	96.18	87.05			34.59	8.64	34.1	216	267	Average
5700	103.59	94.46			34.59	8.64	34.1	216	267	Peak
*5724.2	44.43	35.27	54	-9.57	34.62	8.65	34.11	216	267	Average
*5725.08	54.41	45.25	74	-19.59	34.62	8.65	34.11	216	267	Peak
11400	47.26	32.16	54	-6.74	37.84	12.67	35.41	192	238	Average
11400	56.12	41.02	74	-17.88	37.84	12.67	35.41	192	238	Peak

Remarks:

- Emission Level = Read Level + Antenna Factor + Cable Loss - Preamp Factor
Margin value = Emission level – Limit value
- 5700 MHz: Fundamental Frequency
- *: Out of Restricted Band

EUT Test Condition		Measurement Detail	
Channel	Channel 149	Frequency Range	1 GHz ~ 40 GHz
Input Power	120 Vac, 60 Hz	Detector Function	Peak (PK) Average (AV)
Environmental Conditions	25 deg. C, 65 % RH	Tested By	Charles Hsiao

<Spurious Emission>

Antenna Polarity & Test Distance: Horizontal at 3 m										
Frequency (MHz)	Emission Level (dBuV/m)	Read Level (dBuV)	Limit (dBuV/m)	Margin (dB)	Antenna Factor (dB/m)	Cable Loss (dB)	Preamp Factor (dB)	Antenna Height (cm)	Table Angle (Degree)	Remark
5745	100.77	91.58			34.64	8.66	34.11	200	299	Average
5745	107.85	98.66			34.64	8.66	34.11	200	299	Peak
11490	47.68	32.56	54	-6.32	37.89	12.62	35.39	191	109	Average
11490	58.19	43.07	74	-15.81	37.89	12.62	35.39	191	109	Peak
Antenna Polarity & Test Distance: Vertical at 3 m										
Frequency (MHz)	Emission Level (dBuV/m)	Read Level (dBuV)	Limit (dBuV/m)	Margin (dB)	Antenna Factor (dB/m)	Cable Loss (dB)	Preamp Factor (dB)	Antenna Height (cm)	Table Angle (Degree)	Remark
5745	94.86	85.67			34.64	8.66	34.11	145	287	Average
5745	101.59	92.4			34.64	8.66	34.11	145	287	Peak
11490	47.61	32.49	54	-6.39	37.89	12.62	35.39	117	157	Average
11490	57.61	42.49	74	-16.39	37.89	12.62	35.39	117	157	Peak

<Out of Band Emission (OOBE)>

Antenna Polarity & Test Distance: Horizontal at 3 m										
Frequency (MHz)	Emission Level (dBuV/m)	Read Level (dBuV)	Limit (dBuV/m)	Margin (dB)	Antenna Factor (dB/m)	Cable Loss (dB)	Preamp Factor (dB)	Antenna Height (cm)	Table Angle (Degree)	Remark
*5566.15	43.58	34.59	54	-10.42	34.47	8.59	34.07	200	299	Average
*5566.15	53.51	44.52	74	-20.49	34.47	8.59	34.07	200	299	Peak
5653.3	52.69	43.59	76.06	-23.37	34.56	8.63	34.09	200	299	Peak
5921.05	52.68	43.3	76.46	-23.78	34.81	8.73	34.16	200	299	Peak
*5936.275	44.06	34.66	54	-9.94	34.83	8.73	34.16	200	299	Average
*5936.275	54.82	45.42	74	-19.18	34.83	8.73	34.16	200	299	Peak
Antenna Polarity & Test Distance: Vertical at 3 m										
Frequency (MHz)	Emission Level (dBuV/m)	Read Level (dBuV)	Limit (dBuV/m)	Margin (dB)	Antenna Factor (dB/m)	Cable Loss (dB)	Preamp Factor (dB)	Antenna Height (cm)	Table Angle (Degree)	Remark
*5571.925	44.04	35.05	54	-9.96	34.47	8.59	34.07	145	287	Average
*5571.925	54.26	45.27	74	-19.74	34.47	8.59	34.07	145	287	Peak
5651.2	53.1	44.01	74.75	-21.65	34.56	8.62	34.09	145	287	Peak
5921.05	53.04	43.66	76.46	-23.42	34.81	8.73	34.16	145	287	Peak
*5953.6	44.48	35.05	54	-9.52	34.85	8.74	34.16	145	287	Average
*5953.6	54.6	45.17	74	-19.4	34.85	8.74	34.16	145	287	Peak

Remarks:

- Emission Level = Read Level + Antenna Factor + Cable Loss - Preamp Factor
Margin value = Emission level – Limit value
- 5745 MHz: Fundamental Frequency
- *: Out of Restricted Band

EUT Test Condition		Measurement Detail	
Channel	Channel 157	Frequency Range	1 GHz ~ 40 GHz
Input Power	120 Vac, 60 Hz	Detector Function	Peak (PK) Average (AV)
Environmental Conditions	25 deg. C, 65 % RH	Tested By	Charles Hsiao

<Spurious Emission>

Antenna Polarity & Test Distance: Horizontal at 3 m										
Frequency (MHz)	Emission Level (dBuV/m)	Read Level (dBuV)	Limit (dBuV/m)	Margin (dB)	Antenna Factor (dB/m)	Cable Loss (dB)	Preamp Factor (dB)	Antenna Height (cm)	Table Angle (Degree)	Remark
5785	100.44	91.21			34.68	8.68	34.13	200	299	Average
5785	107.72	98.49			34.68	8.68	34.13	200	299	Peak
11570	47.94	32.63	54	-6.06	38	12.68	35.37	102	104	Average
11570	58.57	43.26	74	-15.43	38	12.68	35.37	102	104	Peak
Antenna Polarity & Test Distance: Vertical at 3 m										
Frequency (MHz)	Emission Level (dBuV/m)	Read Level (dBuV)	Limit (dBuV/m)	Margin (dB)	Antenna Factor (dB/m)	Cable Loss (dB)	Preamp Factor (dB)	Antenna Height (cm)	Table Angle (Degree)	Remark
5785	94.53	85.3			34.68	8.68	34.13	145	287	Average
5785	101.02	91.79			34.68	8.68	34.13	145	287	Peak
11570	47.89	32.58	54	-6.11	38	12.68	35.37	137	255	Average
11570	56.26	40.95	74	-17.74	38	12.68	35.37	137	255	Peak

<Out of Band Emission (OOBE)>

Antenna Polarity & Test Distance: Horizontal at 3 m										
Frequency (MHz)	Emission Level (dBuV/m)	Read Level (dBuV)	Limit (dBuV/m)	Margin (dB)	Antenna Factor (dB/m)	Cable Loss (dB)	Preamp Factor (dB)	Antenna Height (cm)	Table Angle (Degree)	Remark
*5631.775	43.68	34.63	54	-10.32	34.52	8.62	34.09	200	299	Average
*5631.775	53.75	44.7	74	-20.25	34.52	8.62	34.09	200	299	Peak
5652.775	51.43	42.33	75.73	-24.3	34.56	8.63	34.09	200	299	Peak
5921.575	52.47	43.07	76.14	-23.67	34.83	8.73	34.16	200	299	Peak
*5925.775	43.86	34.46	54	-10.14	34.83	8.73	34.16	200	299	Average
*5925.775	54.4	45	74	-19.6	34.83	8.73	34.16	200	299	Peak
Antenna Polarity & Test Distance: Vertical at 3 m										
Frequency (MHz)	Emission Level (dBuV/m)	Read Level (dBuV)	Limit (dBuV/m)	Margin (dB)	Antenna Factor (dB/m)	Cable Loss (dB)	Preamp Factor (dB)	Antenna Height (cm)	Table Angle (Degree)	Remark
*5647.525	43.58	34.51	54	-10.42	34.54	8.62	34.09	145	287	Average
*5647.525	53.59	44.52	74	-20.41	34.54	8.62	34.09	145	287	Peak
5653.825	52	42.91	76.39	-24.39	34.56	8.63	34.1	145	287	Peak
5920	53.03	43.65	77.12	-24.09	34.81	8.73	34.16	145	287	Peak
*5954.65	43.97	34.54	54	-10.03	34.85	8.74	34.16	145	287	Average
*5954.65	54.63	45.2	74	-19.37	34.85	8.74	34.16	145	287	Peak

Remarks:

- Emission Level = Read Level + Antenna Factor + Cable Loss - Preamp Factor
Margin value = Emission level – Limit value
- 5785 MHz: Fundamental Frequency
- *: Out of Restricted Band

EUT Test Condition		Measurement Detail	
Channel	Channel 165	Frequency Range	1 GHz ~ 40 GHz
Input Power	120 Vac, 60 Hz	Detector Function	Peak (PK) Average (AV)
Environmental Conditions	25 deg. C, 65 % RH	Tested By	Charles Hsiao

<Spurious Emission>

Antenna Polarity & Test Distance: Horizontal at 3 m										
Frequency (MHz)	Emission Level (dBuV/m)	Read Level (dBuV)	Limit (dBuV/m)	Margin (dB)	Antenna Factor (dB/m)	Cable Loss (dB)	Preamp Factor (dB)	Antenna Height (cm)	Table Angle (Degree)	Remark
5825	100.88	91.59			34.73	8.69	34.13	200	299	Average
5825	107.56	98.27			34.73	8.69	34.13	200	299	Peak
11650	48.3	32.77	54	-5.7	38.09	12.8	35.36	141	13	Average
11650	56.6	41.07	74	-17.4	38.09	12.8	35.36	141	13	Peak
Antenna Polarity & Test Distance: Vertical at 3 m										
Frequency (MHz)	Emission Level (dBuV/m)	Read Level (dBuV)	Limit (dBuV/m)	Margin (dB)	Antenna Factor (dB/m)	Cable Loss (dB)	Preamp Factor (dB)	Antenna Height (cm)	Table Angle (Degree)	Remark
5825	94.58	85.29			34.73	8.69	34.13	145	287	Average
5825	101.09	91.8			34.73	8.69	34.13	145	287	Peak
11650	48.28	32.75	54	-5.72	38.09	12.8	35.36	101	152	Average
11650	57.63	42.1	74	-16.37	38.09	12.8	35.36	101	152	Peak

<Out of Band Emission (OOBE)>

Antenna Polarity & Test Distance: Horizontal at 3 m										
Frequency (MHz)	Emission Level (dBuV/m)	Read Level (dBuV)	Limit (dBuV/m)	Margin (dB)	Antenna Factor (dB/m)	Cable Loss (dB)	Preamp Factor (dB)	Antenna Height (cm)	Table Angle (Degree)	Remark
*5632.3	43.57	34.52	54	-10.43	34.52	8.62	34.09	200	299	Average
*5632.3	53.54	44.49	74	-20.46	34.52	8.62	34.09	200	299	Peak
5650.675	52.8	43.71	74.42	-21.62	34.56	8.62	34.09	200	299	Peak
5920.525	52.75	43.37	76.79	-24.04	34.81	8.73	34.16	200	299	Peak
*5998.75	44.15	34.66	54	-9.85	34.9	8.76	34.17	200	299	Average
*5998.75	54.5	45.01	74	-19.5	34.9	8.76	34.17	200	299	Peak
Antenna Polarity & Test Distance: Vertical at 3 m										
Frequency (MHz)	Emission Level (dBuV/m)	Read Level (dBuV)	Limit (dBuV/m)	Margin (dB)	Antenna Factor (dB/m)	Cable Loss (dB)	Preamp Factor (dB)	Antenna Height (cm)	Table Angle (Degree)	Remark
*5586.625	43.54	34.53	54	-10.46	34.49	8.6	34.08	145	287	Average
*5586.625	53.74	44.73	74	-20.26	34.49	8.6	34.08	145	287	Peak
5651.2	52.62	43.53	74.75	-22.13	34.56	8.62	34.09	145	287	Peak
5913.7	54.33	44.95	81.05	-26.72	34.81	8.73	34.16	145	287	Peak
*5975.125	43.99	34.53	54	-10.01	34.88	8.75	34.17	145	287	Average
*5975.125	54.32	44.86	74	-19.68	34.88	8.75	34.17	145	287	Peak

Remarks:

- Emission Level = Read Level + Antenna Factor + Cable Loss - Preamp Factor
Margin value = Emission level – Limit value
- 5825 MHz: Fundamental Frequency
- *: Out of Restricted Band

802.11n (HT40)

EUT Test Condition		Measurement Detail	
Channel	Channel 38	Frequency Range	1 GHz ~ 40 GHz
Input Power	120 Vac, 60 Hz	Detector Function	Peak (PK) Average (AV)
Environmental Conditions	25 deg. C, 65 % RH	Tested By	Charles Hsiao

Antenna Polarity & Test Distance: Horizontal at 3 m

Frequency (MHz)	Emission Level (dBuV/m)	Read Level (dBuV)	Limit (dBuV/m)	Margin (dB)	Antenna Factor (dB/m)	Cable Loss (dB)	Preamp Factor (dB)	Antenna Height (cm)	Table Angle (Degree)	Remark
5145.5	54.82	46.57	74	-19.18	34.12	8.13	34	124	242	Peak
5149.55	45.13	36.88	54	-8.87	34.12	8.13	34	124	242	Average
5190	91.48	83.14			34.15	8.19	34	124	242	Average
5190	98.41	90.07			34.15	8.19	34	124	242	Peak
5434.37	42.89	34.1	54	-11.11	34.35	8.48	34.04	124	242	Average
5440.09	53.05	44.26	74	-20.95	34.35	8.48	34.04	124	242	Peak

Antenna Polarity & Test Distance: Vertical at 3 m

Frequency (MHz)	Emission Level (dBuV/m)	Read Level (dBuV)	Limit (dBuV/m)	Margin (dB)	Antenna Factor (dB/m)	Cable Loss (dB)	Preamp Factor (dB)	Antenna Height (cm)	Table Angle (Degree)	Remark
5150	51.98	43.73	54	-2.02	34.12	8.13	34	100	2	Average
5150	61.81	53.56	74	-12.19	34.12	8.13	34	100	2	Peak
5190	97.36	89.02			34.15	8.19	34	100	2	Average
5190	104.18	95.84			34.15	8.19	34	100	2	Peak
5371.34	54.15	45.48	74	-19.85	34.29	8.41	34.03	100	2	Peak
5456.59	42.87	34.05	54	-11.13	34.36	8.51	34.05	100	2	Average

Remarks:

- Emission Level = Read Level + Antenna Factor + Cable Loss - Preamp Factor
Margin value = Emission level – Limit value
- 5190 MHz: Fundamental Frequency

EUT Test Condition		Measurement Detail	
Channel	Channel 46	Frequency Range	1 GHz ~ 40 GHz
Input Power	120 Vac, 60 Hz	Detector Function	Peak (PK) Average (AV)
Environmental Conditions	25 deg. C, 65 % RH	Tested By	Charles Hsiao

Antenna Polarity & Test Distance: Horizontal at 3 m										
Frequency (MHz)	Emission Level (dBuV/m)	Read Level (dBuV)	Limit (dBuV/m)	Margin (dB)	Antenna Factor (dB/m)	Cable Loss (dB)	Preamp Factor (dB)	Antenna Height (cm)	Table Angle (Degree)	Remark
5026.1	54.15	46.12	74	-19.85	34.03	7.97	33.97	124	242	Peak
5133.2	42.73	34.48	54	-11.27	34.11	8.13	33.99	124	242	Average
5230	91.77	83.37			34.19	8.22	34.01	124	242	Average
5230	98.54	90.14			34.19	8.22	34.01	124	242	Peak
5429.42	42.8	34.01	54	-11.2	34.35	8.48	34.04	124	242	Average
5444.82	54.11	45.29	74	-19.89	34.35	8.51	34.04	124	242	Peak

Antenna Polarity & Test Distance: Vertical at 3 m										
Frequency (MHz)	Emission Level (dBuV/m)	Read Level (dBuV)	Limit (dBuV/m)	Margin (dB)	Antenna Factor (dB/m)	Cable Loss (dB)	Preamp Factor (dB)	Antenna Height (cm)	Table Angle (Degree)	Remark
5136.95	57.1	48.85	74	-16.9	34.11	8.13	33.99	100	2	Peak
5148.2	43.57	35.32	54	-10.43	34.12	8.13	34	100	2	Average
5230	97.48	89.08			34.19	8.22	34.01	100	2	Average
5230	104	95.6			34.19	8.22	34.01	100	2	Peak
5405.66	54.57	45.85	74	-19.43	34.32	8.44	34.04	100	2	Peak
5452.08	42.95	34.13	54	-11.05	34.36	8.51	34.05	100	2	Average

Remarks:

- Emission Level = Read Level + Antenna Factor + Cable Loss - Preamp Factor
Margin value = Emission level – Limit value
- 5230 MHz: Fundamental Frequency

EUT Test Condition		Measurement Detail	
Channel	Channel 54	Frequency Range	1 GHz ~ 40 GHz
Input Power	120 Vac, 60 Hz	Detector Function	Peak (PK) Average (AV)
Environmental Conditions	25 deg. C, 65 % RH	Tested By	Charles Hsiao

Antenna Polarity & Test Distance: Horizontal at 3 m										
Frequency (MHz)	Emission Level (dBuV/m)	Read Level (dBuV)	Limit (dBuV/m)	Margin (dB)	Antenna Factor (dB/m)	Cable Loss (dB)	Preamp Factor (dB)	Antenna Height (cm)	Table Angle (Degree)	Remark
5138.75	57.36	49.11	74	-16.64	34.11	8.13	33.99	204	297	Peak
5148.35	43.43	35.18	54	-10.57	34.12	8.13	34	204	297	Average
5270	99.66	91.17			34.21	8.29	34.01	204	297	Average
5270	106.43	97.94			34.21	8.29	34.01	204	297	Peak
5350.33	62.09	53.46	74	-11.91	34.28	8.38	34.03	204	297	Peak
5353.41	44.12	35.49	54	-9.88	34.28	8.38	34.03	204	297	Average

Antenna Polarity & Test Distance: Vertical at 3 m										
Frequency (MHz)	Emission Level (dBuV/m)	Read Level (dBuV)	Limit (dBuV/m)	Margin (dB)	Antenna Factor (dB/m)	Cable Loss (dB)	Preamp Factor (dB)	Antenna Height (cm)	Table Angle (Degree)	Remark
5133.2	42.89	34.64	54	-11.11	34.11	8.13	33.99	210	281	Average
5139.05	55.9	47.65	74	-18.1	34.11	8.13	33.99	210	281	Peak
5270	97.8	89.31			34.21	8.29	34.01	210	281	Average
5270	104.87	96.38			34.21	8.29	34.01	210	281	Peak
5354.29	43.29	34.66	54	-10.71	34.28	8.38	34.03	210	281	Average
5355.17	56.28	47.65	74	-17.72	34.28	8.38	34.03	210	281	Peak

Remarks:

- Emission Level = Read Level + Antenna Factor + Cable Loss - Preamp Factor
Margin value = Emission level – Limit value
- 5270 MHz: Fundamental Frequency

EUT Test Condition		Measurement Detail	
Channel	Channel 62	Frequency Range	1 GHz ~ 40 GHz
Input Power	120 Vac, 60 Hz	Detector Function	Peak (PK) Average (AV)
Environmental Conditions	25 deg. C, 65 % RH	Tested By	Charles Hsiao

Antenna Polarity & Test Distance: Horizontal at 3 m										
Frequency (MHz)	Emission Level (dBuV/m)	Read Level (dBuV)	Limit (dBuV/m)	Margin (dB)	Antenna Factor (dB/m)	Cable Loss (dB)	Preamp Factor (dB)	Antenna Height (cm)	Table Angle (Degree)	Remark
5124.35	43.18	34.96	54	-10.82	34.11	8.1	33.99	204	297	Average
5145.8	55.46	47.21	74	-18.54	34.12	8.13	34	204	297	Peak
5310	99.55	91			34.25	8.32	34.02	204	297	Average
5310	106.32	97.77			34.25	8.32	34.02	204	297	Peak
5350.66	51.68	43.05	54	-2.32	34.28	8.38	34.03	204	297	Average
5351.1	67.56	58.93	74	-6.44	34.28	8.38	34.03	204	297	Peak

Antenna Polarity & Test Distance: Vertical at 3 m										
Frequency (MHz)	Emission Level (dBuV/m)	Read Level (dBuV)	Limit (dBuV/m)	Margin (dB)	Antenna Factor (dB/m)	Cable Loss (dB)	Preamp Factor (dB)	Antenna Height (cm)	Table Angle (Degree)	Remark
5118.35	43	34.8	54	-11	34.09	8.1	33.99	210	281	Average
5121.5	53.72	45.52	74	-20.28	34.09	8.1	33.99	210	281	Peak
5310	97.85	89.3			34.25	8.32	34.02	210	281	Average
5310	104.74	96.19			34.25	8.32	34.02	210	281	Peak
5350.55	47.08	38.45	54	-6.92	34.28	8.38	34.03	210	281	Average
5356.6	64.61	55.98	74	-9.39	34.28	8.38	34.03	210	281	Peak

Remarks:

- Emission Level = Read Level + Antenna Factor + Cable Loss - Preamp Factor
Margin value = Emission level – Limit value
- 5310 MHz: Fundamental Frequency

EUT Test Condition		Measurement Detail	
Channel	Channel 102	Frequency Range	1 GHz ~ 40 GHz
Input Power	120 Vac, 60 Hz	Detector Function	Peak (PK) Average (AV)
Environmental Conditions	25 deg. C, 65 % RH	Tested By	Charles Hsiao

Antenna Polarity & Test Distance: Horizontal at 3 m										
Frequency (MHz)	Emission Level (dBuV/m)	Read Level (dBuV)	Limit (dBuV/m)	Margin (dB)	Antenna Factor (dB/m)	Cable Loss (dB)	Preamp Factor (dB)	Antenna Height (cm)	Table Angle (Degree)	Remark
5443.12	58.37	49.58	74	-15.63	34.35	8.48	34.04	115	350	Peak
5460	45.48	36.66	54	-8.52	34.36	8.51	34.05	115	350	Average
*5468.88	58.85	50.02	74	-15.15	34.37	8.51	34.05	115	350	Peak
*5470.96	48.96	40.1	54	-5.04	34.37	8.54	34.05	115	350	Average
5510	94.5	85.59			34.4	8.57	34.06	115	350	Average
5510	101.31	92.4			34.4	8.57	34.06	115	350	Peak
*5724.6	52.86	43.7	74	-21.14	34.62	8.65	34.11	115	350	Peak
*5725.24	43.69	34.53	54	-10.31	34.62	8.65	34.11	115	350	Average

Antenna Polarity & Test Distance: Vertical at 3 m										
Frequency (MHz)	Emission Level (dBuV/m)	Read Level (dBuV)	Limit (dBuV/m)	Margin (dB)	Antenna Factor (dB/m)	Cable Loss (dB)	Preamp Factor (dB)	Antenna Height (cm)	Table Angle (Degree)	Remark
5457.36	56.85	48.03	74	-17.15	34.36	8.51	34.05	182	274	Peak
5459.44	44.53	35.71	54	-9.47	34.36	8.51	34.05	182	274	Average
*5470.64	58.17	49.34	74	-15.83	34.37	8.51	34.05	182	274	Peak
*5470.8	47.89	39.03	54	-6.11	34.37	8.54	34.05	182	274	Average
5510	93.27	84.36			34.4	8.57	34.06	182	274	Average
5510	100.4	91.49			34.4	8.57	34.06	182	274	Peak
*5723.96	43.56	34.4	54	-10.44	34.62	8.65	34.11	182	274	Average
*5724.76	52.08	42.92	74	-21.92	34.62	8.65	34.11	182	274	Peak

Remarks:

- Emission Level = Read Level + Antenna Factor + Cable Loss - Preamp Factor
Margin value = Emission level – Limit value
- 5510 MHz: Fundamental Frequency
- *: Out of Restricted Band

EUT Test Condition		Measurement Detail	
Channel	Channel 110	Frequency Range	1 GHz ~ 40 GHz
Input Power	120 Vac, 60 Hz	Detector Function	Peak (PK) Average (AV)
Environmental Conditions	25 deg. C, 65 % RH	Tested By	Charles Hsiao

Antenna Polarity & Test Distance: Horizontal at 3 m										
Frequency (MHz)	Emission Level (dBuV/m)	Read Level (dBuV)	Limit (dBuV/m)	Margin (dB)	Antenna Factor (dB/m)	Cable Loss (dB)	Preamp Factor (dB)	Antenna Height (cm)	Table Angle (Degree)	Remark
5437.36	54.14	45.35	74	-19.86	34.35	8.48	34.04	108	348	Peak
5450.16	43.21	34.39	54	-10.79	34.36	8.51	34.05	108	348	Average
*5470.32	43.4	34.57	54	-10.6	34.37	8.51	34.05	108	348	Average
*5470.96	52.74	43.88	74	-21.26	34.37	8.54	34.05	108	348	Peak
5550	94.39	85.42			34.45	8.59	34.07	108	348	Average
5550	101.07	92.1			34.45	8.59	34.07	108	348	Peak
*5725.08	53.32	44.16	74	-20.68	34.62	8.65	34.11	108	348	Peak
*5725.64	43.31	34.15	54	-10.69	34.62	8.65	34.11	108	348	Average

Antenna Polarity & Test Distance: Vertical at 3 m										
Frequency (MHz)	Emission Level (dBuV/m)	Read Level (dBuV)	Limit (dBuV/m)	Margin (dB)	Antenna Factor (dB/m)	Cable Loss (dB)	Preamp Factor (dB)	Antenna Height (cm)	Table Angle (Degree)	Remark
5440.4	56.18	47.39	74	-17.82	34.35	8.48	34.04	181	276	Peak
5451.28	43.37	34.55	54	-10.63	34.36	8.51	34.05	181	276	Average
*5470.48	43.29	34.46	54	-10.71	34.37	8.51	34.05	181	276	Average
*5470.64	52.47	43.64	74	-21.53	34.37	8.51	34.05	181	276	Peak
5550	93.25	84.28			34.45	8.59	34.07	181	276	Average
5550	99.8	90.83			34.45	8.59	34.07	181	276	Peak
*5724.2	43.54	34.38	54	-10.46	34.62	8.65	34.11	181	276	Average
*5725.4	52.88	43.72	74	-21.12	34.62	8.65	34.11	181	276	Peak

Remarks:

- Emission Level = Read Level + Antenna Factor + Cable Loss - Preamp Factor
Margin value = Emission level – Limit value
- 5550 MHz: Fundamental Frequency
- *: Out of Restricted Band

EUT Test Condition		Measurement Detail	
Channel	Channel 134	Frequency Range	1 GHz ~ 40 GHz
Input Power	120 Vac, 60 Hz	Detector Function	Peak (PK) Average (AV)
Environmental Conditions	25 deg. C, 65 % RH	Tested By	Charles Hsiao

Antenna Polarity & Test Distance: Horizontal at 3 m										
Frequency (MHz)	Emission Level (dBuV/m)	Read Level (dBuV)	Limit (dBuV/m)	Margin (dB)	Antenna Factor (dB/m)	Cable Loss (dB)	Preamp Factor (dB)	Antenna Height (cm)	Table Angle (Degree)	Remark
5419.28	53.66	44.89	74	-20.34	34.33	8.48	34.04	100	350	Peak
5450.96	43.47	34.65	54	-10.53	34.36	8.51	34.05	100	350	Average
*5468.88	53.91	45.08	74	-20.09	34.37	8.51	34.05	100	350	Peak
*5470.16	43.26	34.43	54	-10.74	34.37	8.51	34.05	100	350	Average
5670	95.13	86.03			34.57	8.63	34.1	100	350	Average
5670	102.71	93.61			34.57	8.63	34.1	100	350	Peak
*5724.28	44.48	35.32	54	-9.52	34.62	8.65	34.11	100	350	Average
*5724.6	57.01	47.85	74	-16.99	34.62	8.65	34.11	100	350	Peak
Antenna Polarity & Test Distance: Vertical at 3 m										
Frequency (MHz)	Emission Level (dBuV/m)	Read Level (dBuV)	Limit (dBuV/m)	Margin (dB)	Antenna Factor (dB/m)	Cable Loss (dB)	Preamp Factor (dB)	Antenna Height (cm)	Table Angle (Degree)	Remark
5440.72	53.81	45.02	74	-20.19	34.35	8.48	34.04	209	267	Peak
5451.6	43.61	34.79	54	-10.39	34.36	8.51	34.05	209	267	Average
*5470.32	43.33	34.5	54	-10.67	34.37	8.51	34.05	209	267	Average
*5470.48	53.54	44.71	74	-20.46	34.37	8.51	34.05	209	267	Peak
5670	94.09	84.99			34.57	8.63	34.1	209	267	Average
5670	101.17	92.07			34.57	8.63	34.1	209	267	Peak
*5725.32	54.59	45.43	74	-19.41	34.62	8.65	34.11	209	267	Peak
*5725.64	44.28	35.12	54	-9.72	34.62	8.65	34.11	209	267	Average

Remarks:

- Emission Level = Read Level + Antenna Factor + Cable Loss - Preamp Factor
Margin value = Emission level – Limit value
- 5670 MHz: Fundamental Frequency
- *: Out of Restricted Band

EUT Test Condition		Measurement Detail	
Channel	Channel 151	Frequency Range	1 GHz ~ 40 GHz
Input Power	120 Vac, 60 Hz	Detector Function	Peak (PK) Average (AV)
Environmental Conditions	25 deg. C, 65 % RH	Tested By	Charles Hsiao

<Spurious Emission>

Antenna Polarity & Test Distance: Horizontal at 3 m										
Frequency (MHz)	Emission Level (dBuV/m)	Read Level (dBuV)	Limit (dBuV/m)	Margin (dB)	Antenna Factor (dB/m)	Cable Loss (dB)	Preamp Factor (dB)	Antenna Height (cm)	Table Angle (Degree)	Remark
5755	96.66	87.45			34.66	8.66	34.11	200	299	Average
5755	103.31	94.1			34.66	8.66	34.11	200	299	Peak
11510	48.01	32.9	54	-5.99	37.9	12.6	35.39	182	159	Average
11510	56.57	41.46	74	-17.43	37.9	12.6	35.39	182	159	Peak
Antenna Polarity & Test Distance: Vertical at 3 m										
Frequency (MHz)	Emission Level (dBuV/m)	Read Level (dBuV)	Limit (dBuV/m)	Margin (dB)	Antenna Factor (dB/m)	Cable Loss (dB)	Preamp Factor (dB)	Antenna Height (cm)	Table Angle (Degree)	Remark
5755	90.5	81.29			34.66	8.66	34.11	145	287	Average
5755	97.27	88.06			34.66	8.66	34.11	145	287	Peak
11510	47.87	32.76	54	-6.13	37.9	12.6	35.39	141	246	Average
11510	56.61	41.5	74	-17.39	37.9	12.6	35.39	141	246	Peak

<Out of Band Emission (OOBE)>

Antenna Polarity & Test Distance: Horizontal at 3 m										
Frequency (MHz)	Emission Level (dBuV/m)	Read Level (dBuV)	Limit (dBuV/m)	Margin (dB)	Antenna Factor (dB/m)	Cable Loss (dB)	Preamp Factor (dB)	Antenna Height (cm)	Table Angle (Degree)	Remark
*5619.175	45.13	36.08	54	-8.87	34.52	8.61	34.08	200	299	Average
*5619.175	54.34	45.29	74	-19.66	34.52	8.61	34.08	200	299	Peak
5651.725	53.61	44.52	75.08	-21.47	34.56	8.62	34.09	200	299	Peak
5918.425	54.54	45.16	78.1	-23.56	34.81	8.73	34.16	200	299	Peak
*5976.175	45.74	36.28	54	-8.26	34.88	8.75	34.17	200	299	Average
*5976.175	54.81	45.35	74	-19.19	34.88	8.75	34.17	200	299	Peak
Antenna Polarity & Test Distance: Vertical at 3 m										
Frequency (MHz)	Emission Level (dBuV/m)	Read Level (dBuV)	Limit (dBuV/m)	Margin (dB)	Antenna Factor (dB/m)	Cable Loss (dB)	Preamp Factor (dB)	Antenna Height (cm)	Table Angle (Degree)	Remark
*5578.225	45.02	36.03	54	-8.98	34.47	8.6	34.08	145	287	Average
*5578.225	53.44	44.45	74	-20.56	34.47	8.6	34.08	145	287	Peak
5651.2	52.31	43.22	74.75	-22.44	34.56	8.62	34.09	145	287	Peak
5924.2	52.27	42.87	74.5	-22.23	34.83	8.73	34.16	145	287	Peak
*5958.325	45.43	35.98	54	-8.57	34.87	8.74	34.16	145	287	Average
*5958.325	54.44	44.99	74	-19.56	34.87	8.74	34.16	145	287	Peak

Remarks:

- Emission Level = Read Level + Antenna Factor + Cable Loss - Preamp Factor
Margin value = Emission level – Limit value
- 5755 MHz: Fundamental Frequency
- *: Out of Restricted Band

EUT Test Condition		Measurement Detail	
Channel	Channel 159	Frequency Range	1 GHz ~ 40 GHz
Input Power	120 Vac, 60 Hz	Detector Function	Peak (PK) Average (AV)
Environmental Conditions	25 deg. C, 65 % RH	Tested By	Charles Hsiao

<Spurious Emission>

Antenna Polarity & Test Distance: Horizontal at 3 m										
Frequency (MHz)	Emission Level (dBuV/m)	Read Level (dBuV)	Limit (dBuV/m)	Margin (dB)	Antenna Factor (dB/m)	Cable Loss (dB)	Preamp Factor (dB)	Antenna Height (cm)	Table Angle (Degree)	Remark
5795	96.33	87.09			34.69	8.68	34.13	200	299	Average
5795	103.88	94.64			34.69	8.68	34.13	200	299	Peak
11590	48.22	32.85	54	-5.78	38.02	12.72	35.37	148	308	Average
11590	56.23	40.86	74	-17.77	38.02	12.72	35.37	148	308	Peak
Antenna Polarity & Test Distance: Vertical at 3 m										
Frequency (MHz)	Emission Level (dBuV/m)	Read Level (dBuV)	Limit (dBuV/m)	Margin (dB)	Antenna Factor (dB/m)	Cable Loss (dB)	Preamp Factor (dB)	Antenna Height (cm)	Table Angle (Degree)	Remark
5795	90.74	81.5			34.69	8.68	34.13	145	287	Average
5795	97.74	88.5			34.69	8.68	34.13	145	287	Peak
11590	48.48	33.11	54	-5.52	38.02	12.72	35.37	168	265	Average
11590	56.92	41.55	74	-17.08	38.02	12.72	35.37	168	265	Peak

<Out of Band Emission (OOBE)>

Antenna Polarity & Test Distance: Horizontal at 3 m										
Frequency (MHz)	Emission Level (dBuV/m)	Read Level (dBuV)	Limit (dBuV/m)	Margin (dB)	Antenna Factor (dB/m)	Cable Loss (dB)	Preamp Factor (dB)	Antenna Height (cm)	Table Angle (Degree)	Remark
*5615.5	45.21	36.16	54	-8.79	34.52	8.61	34.08	200	299	Average
*5615.5	53.61	44.56	74	-20.39	34.52	8.61	34.08	200	299	Peak
5652.775	52.99	43.89	75.73	-22.74	34.56	8.63	34.09	200	299	Peak
5922.1	52.9	43.5	75.81	-22.91	34.83	8.73	34.16	200	299	Peak
*5936.275	45.56	36.16	54	-8.44	34.83	8.73	34.16	200	299	Average
*5936.275	54.16	44.76	74	-19.84	34.83	8.73	34.16	200	299	Peak
Antenna Polarity & Test Distance: Vertical at 3 m										
Frequency (MHz)	Emission Level (dBuV/m)	Read Level (dBuV)	Limit (dBuV/m)	Margin (dB)	Antenna Factor (dB/m)	Cable Loss (dB)	Preamp Factor (dB)	Antenna Height (cm)	Table Angle (Degree)	Remark
*5609.725	45.1	36.07	54	-8.9	34.5	8.61	34.08	145	287	Average
*5609.725	53.64	44.61	74	-20.36	34.5	8.61	34.08	145	287	Peak
5651.725	51.82	42.73	75.08	-23.26	34.56	8.62	34.09	145	287	Peak
5923.15	52.4	43	75.15	-22.75	34.83	8.73	34.16	145	287	Peak
*5964.1	45.39	35.95	54	-8.61	34.87	8.74	34.17	145	287	Average
*5964.1	54.19	44.75	74	-19.81	34.87	8.74	34.17	145	287	Peak

Remarks:

- Emission Level = Read Level + Antenna Factor + Cable Loss - Preamp Factor
Margin value = Emission level – Limit value
- 5795 MHz: Fundamental Frequency
- *: Out of Restricted Band

802.11ac (VHT80)

EUT Test Condition		Measurement Detail	
Channel	Channel 42	Frequency Range	1 GHz ~ 40 GHz
Input Power	120 Vac, 60 Hz	Detector Function	Peak (PK) Average (AV)
Environmental Conditions	25 deg. C, 65 % RH	Tested By	Charles Hsiao

Antenna Polarity & Test Distance: Horizontal at 3 m

Frequency (MHz)	Emission Level (dBuV/m)	Read Level (dBuV)	Limit (dBuV/m)	Margin (dB)	Antenna Factor (dB/m)	Cable Loss (dB)	Preamp Factor (dB)	Antenna Height (cm)	Table Angle (Degree)	Remark
5120	53.78	45.58	74	-20.22	34.09	8.1	33.99	124	242	Peak
5149.4	43.85	35.6	54	-10.15	34.12	8.13	34	124	242	Average
5210	88.69	80.33			34.17	8.19	34	124	242	Average
5210	95.21	86.85			34.17	8.19	34	124	242	Peak
5381.13	43.08	34.4	54	-10.92	34.31	8.41	34.04	124	242	Average
5391.91	53.41	44.73	74	-20.59	34.31	8.41	34.04	124	242	Peak

Antenna Polarity & Test Distance: Vertical at 3 m

Frequency (MHz)	Emission Level (dBuV/m)	Read Level (dBuV)	Limit (dBuV/m)	Margin (dB)	Antenna Factor (dB/m)	Cable Loss (dB)	Preamp Factor (dB)	Antenna Height (cm)	Table Angle (Degree)	Remark
5146.7	58.03	49.78	74	-15.97	34.12	8.13	34	100	6	Peak
5149.55	49.09	40.84	54	-4.91	34.12	8.13	34	100	6	Average
5210	94.27	85.91			34.17	8.19	34	100	6	Average
5210	101.66	93.3			34.17	8.19	34	100	6	Peak
5444.82	53.28	44.46	74	-20.72	34.35	8.51	34.04	100	6	Peak
5456.37	43.35	34.53	54	-10.65	34.36	8.51	34.05	100	6	Average

Remarks:

- Emission Level = Read Level + Antenna Factor + Cable Loss - Preamp Factor
Margin value = Emission level – Limit value
- 5210 MHz: Fundamental Frequency

EUT Test Condition		Measurement Detail	
Channel	Channel 58	Frequency Range	1 GHz ~ 40 GHz
Input Power	120 Vac, 60 Hz	Detector Function	Peak (PK) Average (AV)
Environmental Conditions	25 deg. C, 65 % RH	Tested By	Charles Hsiao

Antenna Polarity & Test Distance: Horizontal at 3 m										
Frequency (MHz)	Emission Level (dBuV/m)	Read Level (dBuV)	Limit (dBuV/m)	Margin (dB)	Antenna Factor (dB/m)	Cable Loss (dB)	Preamp Factor (dB)	Antenna Height (cm)	Table Angle (Degree)	Remark
5147.45	56.25	48	74	-17.75	34.12	8.13	34	204	297	Peak
5150	46.88	38.63	54	-7.12	34.12	8.13	34	204	297	Average
5290	95.54	87.01			34.23	8.32	34.02	204	297	Average
5290	103.04	94.51			34.23	8.32	34.02	204	297	Peak
5353.19	51.89	43.26	54	-2.11	34.28	8.38	34.03	204	297	Average
5355.72	60.49	51.86	74	-13.51	34.28	8.38	34.03	204	297	Peak

Antenna Polarity & Test Distance: Vertical at 3 m										
Frequency (MHz)	Emission Level (dBuV/m)	Read Level (dBuV)	Limit (dBuV/m)	Margin (dB)	Antenna Factor (dB/m)	Cable Loss (dB)	Preamp Factor (dB)	Antenna Height (cm)	Table Angle (Degree)	Remark
5123.75	54.09	45.87	74	-19.91	34.11	8.1	33.99	210	281	Peak
5143.7	45.1	36.84	54	-8.9	34.12	8.13	33.99	210	281	Average
5290	93.44	84.91			34.23	8.32	34.02	210	281	Average
5290	101.57	93.04			34.23	8.32	34.02	210	281	Peak
5355.83	48.23	39.6	54	-5.77	34.28	8.38	34.03	210	281	Average
5359.13	58.2	49.57	74	-15.8	34.28	8.38	34.03	210	281	Peak

Remarks:

- Emission Level = Read Level + Antenna Factor + Cable Loss - Preamp Factor
Margin value = Emission level – Limit value
- 5290 MHz: Fundamental Frequency

EUT Test Condition		Measurement Detail	
Channel	Channel 106	Frequency Range	1 GHz ~ 40 GHz
Input Power	120 Vac, 60 Hz	Detector Function	Peak (PK) Average (AV)
Environmental Conditions	25 deg. C, 65 % RH	Tested By	Charles Hsiao

Antenna Polarity & Test Distance: Horizontal at 3 m										
Frequency (MHz)	Emission Level (dBuV/m)	Read Level (dBuV)	Limit (dBuV/m)	Margin (dB)	Antenna Factor (dB/m)	Cable Loss (dB)	Preamp Factor (dB)	Antenna Height (cm)	Table Angle (Degree)	Remark
5437.68	57.06	48.27	74	-16.94	34.35	8.48	34.04	115	350	Peak
5440.56	47.64	38.85	54	-6.36	34.35	8.48	34.04	115	350	Average
*5468.4	47.48	38.65	54	-6.52	34.37	8.51	34.05	115	350	Average
*5468.72	56.16	47.33	74	-17.84	34.37	8.51	34.05	115	350	Peak
5530	88.45	79.52			34.42	8.58	34.07	115	350	Average
5530	95.17	86.24			34.42	8.58	34.07	115	350	Peak
*5725.32	53.66	44.5	74	-20.34	34.62	8.65	34.11	115	350	Peak
*5725.48	44.09	34.93	54	-9.91	34.62	8.65	34.11	115	350	Average

Antenna Polarity & Test Distance: Vertical at 3 m										
Frequency (MHz)	Emission Level (dBuV/m)	Read Level (dBuV)	Limit (dBuV/m)	Margin (dB)	Antenna Factor (dB/m)	Cable Loss (dB)	Preamp Factor (dB)	Antenna Height (cm)	Table Angle (Degree)	Remark
5427.44	56.78	48.01	74	-17.22	34.33	8.48	34.04	191	276	Peak
5454.64	46.29	37.47	54	-7.71	34.36	8.51	34.05	191	276	Average
*5469.84	46.73	37.9	54	-7.27	34.37	8.51	34.05	191	276	Average
*5470.64	54.58	45.75	74	-19.42	34.37	8.51	34.05	191	276	Peak
5530	87.5	78.57			34.42	8.58	34.07	191	276	Average
5530	95.39	86.46			34.42	8.58	34.07	191	276	Peak
*5725.16	53.66	44.5	74	-20.34	34.62	8.65	34.11	191	276	Peak
*5725.64	44.18	35.02	54	-9.82	34.62	8.65	34.11	191	276	Average

Remarks:

- Emission Level = Read Level + Antenna Factor + Cable Loss - Preamp Factor
Margin value = Emission level – Limit value
- 5530 MHz: Fundamental Frequency
- *: Out of Restricted Band

EUT Test Condition		Measurement Detail	
Channel	Channel 122	Frequency Range	1 GHz ~ 40 GHz
Input Power	120 Vac, 60 Hz	Detector Function	Peak (PK) Average (AV)
Environmental Conditions	25 deg. C, 65 % RH	Tested By	Charles Hsiao

Antenna Polarity & Test Distance: Horizontal at 3 m										
Frequency (MHz)	Emission Level (dBuV/m)	Read Level (dBuV)	Limit (dBuV/m)	Margin (dB)	Antenna Factor (dB/m)	Cable Loss (dB)	Preamp Factor (dB)	Antenna Height (cm)	Table Angle (Degree)	Remark
5451.76	54.91	46.09	74	-19.09	34.36	8.51	34.05	101	350	Peak
5460	44.47	35.65	54	-9.53	34.36	8.51	34.05	101	350	Average
*5469.84	44.57	35.74	54	-9.43	34.37	8.51	34.05	101	350	Average
*5470.64	53.39	44.56	74	-20.61	34.37	8.51	34.05	101	350	Peak
5610	89.31	80.28			34.5	8.61	34.08	101	350	Average
5610	97.35	88.32			34.5	8.61	34.08	101	350	Peak
*5724.76	44.88	35.72	54	-9.12	34.62	8.65	34.11	101	350	Average
*5725.88	53.43	44.27	74	-20.57	34.62	8.65	34.11	101	350	Peak

Antenna Polarity & Test Distance: Vertical at 3 m										
Frequency (MHz)	Emission Level (dBuV/m)	Read Level (dBuV)	Limit (dBuV/m)	Margin (dB)	Antenna Factor (dB/m)	Cable Loss (dB)	Preamp Factor (dB)	Antenna Height (cm)	Table Angle (Degree)	Remark
5393.36	53.73	45.02	74	-20.27	34.31	8.44	34.04	196	279	Peak
5459.92	44.42	35.6	54	-9.58	34.36	8.51	34.05	196	279	Average
*5469.84	53.46	44.63	74	-20.54	34.37	8.51	34.05	196	279	Peak
*5470.64	44.61	35.78	54	-9.39	34.37	8.51	34.05	196	279	Average
5610	88.55	79.52			34.5	8.61	34.08	196	279	Average
5610	96.94	87.91			34.5	8.61	34.08	196	279	Peak
*5724.68	53.92	44.76	74	-20.08	34.62	8.65	34.11	196	279	Peak
*5725.24	44.78	35.62	54	-9.22	34.62	8.65	34.11	196	279	Average

Remarks:

- Emission Level = Read Level + Antenna Factor + Cable Loss - Preamp Factor
Margin value = Emission level – Limit value
- 5610 MHz: Fundamental Frequency
- *: Out of Restricted Band

EUT Test Condition		Measurement Detail	
Channel	Channel 155	Frequency Range	1 GHz ~ 40 GHz
Input Power	120 Vac, 60 Hz	Detector Function	Peak (PK) Average (AV)
Environmental Conditions	25 deg. C, 65 % RH	Tested By	Charles Hsiao

<Spurious Emission>

Antenna Polarity & Test Distance: Horizontal at 3 m										
Frequency (MHz)	Emission Level (dBuV/m)	Read Level (dBuV)	Limit (dBuV/m)	Margin (dB)	Antenna Factor (dB/m)	Cable Loss (dB)	Preamp Factor (dB)	Antenna Height (cm)	Table Angle (Degree)	Remark
5775	93.36	84.13			34.68	8.67	34.12	200	299	Average
5775	100.35	91.12			34.68	8.67	34.12	200	299	Peak
11550	48.93	33.66	54	-5.07	37.97	12.68	35.38	187	55	Average
11550	56.07	40.8	74	-17.93	37.97	12.68	35.38	187	55	Peak
Antenna Polarity & Test Distance: Vertical at 3 m										
Frequency (MHz)	Emission Level (dBuV/m)	Read Level (dBuV)	Limit (dBuV/m)	Margin (dB)	Antenna Factor (dB/m)	Cable Loss (dB)	Preamp Factor (dB)	Antenna Height (cm)	Table Angle (Degree)	Remark
5775	87.79	78.56			34.68	8.67	34.12	145	287	Average
5775	94.89	85.66			34.68	8.67	34.12	145	287	Peak
11550	48.83	33.56	54	-5.17	37.97	12.68	35.38	137	294	Average
11550	56.51	41.24	74	-17.49	37.97	12.68	35.38	137	294	Peak

<Out of Band Emission (OOBE)>

Antenna Polarity & Test Distance: Horizontal at 3 m										
Frequency (MHz)	Emission Level (dBuV/m)	Read Level (dBuV)	Limit (dBuV/m)	Margin (dB)	Antenna Factor (dB/m)	Cable Loss (dB)	Preamp Factor (dB)	Antenna Height (cm)	Table Angle (Degree)	Remark
*5585.05	45.31	36.3	54	-8.69	34.49	8.6	34.08	200	299	Average
*5585.05	54.69	45.68	74	-19.31	34.49	8.6	34.08	200	299	Peak
5651.2	53.7	44.61	74.75	-21.05	34.56	8.62	34.09	200	299	Peak
5921.575	53.66	44.26	76.14	-22.48	34.83	8.73	34.16	200	299	Peak
*5925.775	46.06	36.66	54	-7.94	34.83	8.73	34.16	200	299	Average
*5925.775	54.67	45.27	74	-19.33	34.83	8.73	34.16	200	299	Peak
Antenna Polarity & Test Distance: Vertical at 3 m										
Frequency (MHz)	Emission Level (dBuV/m)	Read Level (dBuV)	Limit (dBuV/m)	Margin (dB)	Antenna Factor (dB/m)	Cable Loss (dB)	Preamp Factor (dB)	Antenna Height (cm)	Table Angle (Degree)	Remark
*5645.425	45.59	36.52	54	-8.41	34.54	8.62	34.09	145	287	Average
*5645.425	54.18	45.11	74	-19.82	34.54	8.62	34.09	145	287	Peak
5655.925	53.42	44.33	77.7	-24.28	34.56	8.63	34.1	145	287	Peak
5922.625	52.37	42.97	75.48	-23.11	34.83	8.73	34.16	145	287	Peak
*6005.05	46.05	36.56	54	-7.95	34.9	8.76	34.17	145	287	Average
*6005.05	54.06	44.57	74	-19.94	34.9	8.76	34.17	145	287	Peak

Remarks:

- Emission Level = Read Level + Antenna Factor + Cable Loss - Preamp Factor
Margin value = Emission level – Limit value
- 5775 MHz: Fundamental Frequency
- *: Out of Restricted Band

Mode B
802.11n (HT40)

EUT Test Condition		Measurement Detail	
Channel	Channel 38	Frequency Range	1 GHz ~ 40 GHz
Input Power	120 Vac, 60 Hz	Detector Function	Peak (PK) Average (AV)
Environmental Conditions	25 deg. C, 65 % RH	Tested By	Charles Hsiao

Antenna Polarity & Test Distance: Horizontal at 3 m										
Frequency (MHz)	Emission Level (dBuV/m)	Read Level (dBuV)	Limit (dBuV/m)	Margin (dB)	Antenna Factor (dB/m)	Cable Loss (dB)	Preamp Factor (dB)	Antenna Height (cm)	Table Angle (Degree)	Remark
5144.3	61.25	53	74	-12.75	34.12	8.13	34	100	118	Peak
5150	45.36	37.11	54	-8.64	34.12	8.13	34	100	118	Average
5190	94.64	86.3			34.15	8.19	34	100	118	Average
5190	101.79	93.45			34.15	8.19	34	100	118	Peak
5413.14	54.3	45.57	74	-19.7	34.33	8.44	34.04	100	118	Peak
5438.88	43.44	34.65	54	-10.56	34.35	8.48	34.04	100	118	Average
Antenna Polarity & Test Distance: Vertical at 3 m										
Frequency (MHz)	Emission Level (dBuV/m)	Read Level (dBuV)	Limit (dBuV/m)	Margin (dB)	Antenna Factor (dB/m)	Cable Loss (dB)	Preamp Factor (dB)	Antenna Height (cm)	Table Angle (Degree)	Remark
5148.65	59.78	51.53	74	-14.22	34.12	8.13	34	109	80	Peak
5150	44.5	36.25	54	-9.5	34.12	8.13	34	109	80	Average
5190	93.46	85.12			34.15	8.19	34	109	80	Average
5190	100.38	92.04			34.15	8.19	34	109	80	Peak
5443.94	53.95	45.16	74	-20.05	34.35	8.48	34.04	109	80	Peak
5449.22	43.46	34.63	54	-10.54	34.36	8.51	34.04	109	80	Average

Remarks:

- Emission Level = Read Level + Antenna Factor + Cable Loss - Preamp Factor
Margin value = Emission level – Limit value
- 5190 MHz: Fundamental Frequency

802.11ac (VHT80)

EUT Test Condition		Measurement Detail	
Channel	Channel 58	Frequency Range	1 GHz ~ 40 GHz
Input Power	120 Vac, 60 Hz	Detector Function	Peak (PK) Average (AV)
Environmental Conditions	25 deg. C, 65 % RH	Tested By	Charles Hsiao

Antenna Polarity & Test Distance: Horizontal at 3 m

Frequency (MHz)	Emission Level (dBuV/m)	Read Level (dBuV)	Limit (dBuV/m)	Margin (dB)	Antenna Factor (dB/m)	Cable Loss (dB)	Preamp Factor (dB)	Antenna Height (cm)	Table Angle (Degree)	Remark
5132.15	44.37	36.15	54	-9.63	34.11	8.1	33.99	105	119	Average
5133.35	53.97	45.72	74	-20.03	34.11	8.13	33.99	105	119	Peak
5290	93.54	85.01			34.23	8.32	34.02	105	119	Average
5290	100.11	91.58			34.23	8.32	34.02	105	119	Peak
5352.31	45.9	37.27	54	-8.1	34.28	8.38	34.03	105	119	Average
5369.25	55.67	47	74	-18.33	34.29	8.41	34.03	105	119	Peak

Antenna Polarity & Test Distance: Vertical at 3 m

Frequency (MHz)	Emission Level (dBuV/m)	Read Level (dBuV)	Limit (dBuV/m)	Margin (dB)	Antenna Factor (dB/m)	Cable Loss (dB)	Preamp Factor (dB)	Antenna Height (cm)	Table Angle (Degree)	Remark
5139.95	54.14	45.88	74	-19.86	34.12	8.13	33.99	102	92	Peak
5142.65	43.9	35.64	54	-10.1	34.12	8.13	33.99	102	92	Average
5290	92.36	83.83			34.23	8.32	34.02	102	92	Average
5290	99.95	91.42			34.23	8.32	34.02	102	92	Peak
5357.81	45.27	36.64	54	-8.73	34.28	8.38	34.03	102	92	Average
5361.44	55.05	46.41	74	-18.95	34.29	8.38	34.03	102	92	Peak

Remarks:

- Emission Level = Read Level + Antenna Factor + Cable Loss - Preamp Factor
Margin value = Emission level – Limit value
- 5290 MHz: Fundamental Frequency

802.11n (HT40)

EUT Test Condition		Measurement Detail	
Channel	Channel 102	Frequency Range	1 GHz ~ 40 GHz
Input Power	120 Vac, 60 Hz	Detector Function	Peak (PK) Average (AV)
Environmental Conditions	25 deg. C, 65 % RH	Tested By	Charles Hsiao

Antenna Polarity & Test Distance: Horizontal at 3 m										
Frequency (MHz)	Emission Level (dBuV/m)	Read Level (dBuV)	Limit (dBuV/m)	Margin (dB)	Antenna Factor (dB/m)	Cable Loss (dB)	Preamp Factor (dB)	Antenna Height (cm)	Table Angle (Degree)	Remark
5445.84	57.95	49.12	74	-16.05	34.36	8.51	34.04	200	331	Peak
5460.08	44.57	35.75	54	-9.43	34.36	8.51	34.05	200	331	Average
*5469.2	58.48	49.65	74	-15.52	34.37	8.51	34.05	200	331	Peak
*5470.96	48.46	39.6	54	-5.54	34.37	8.54	34.05	200	331	Average
5510	96.14	87.23			34.4	8.57	34.06	200	331	Average
5510	103.25	94.34			34.4	8.57	34.06	200	331	Peak
*5724.28	53.36	44.2	74	-20.64	34.62	8.65	34.11	200	331	Peak
*5726.04	43.61	34.45	54	-10.39	34.62	8.65	34.11	200	331	Average

Antenna Polarity & Test Distance: Vertical at 3 m										
Frequency (MHz)	Emission Level (dBuV/m)	Read Level (dBuV)	Limit (dBuV/m)	Margin (dB)	Antenna Factor (dB/m)	Cable Loss (dB)	Preamp Factor (dB)	Antenna Height (cm)	Table Angle (Degree)	Remark
5457.84	58.68	49.86	74	-15.32	34.36	8.51	34.05	100	5	Peak
5459.28	44.3	35.48	54	-9.7	34.36	8.51	34.05	100	5	Average
*5470.8	59.39	50.53	74	-14.61	34.37	8.54	34.05	100	5	Peak
*5470.96	48.79	39.93	54	-5.21	34.37	8.54	34.05	100	5	Average
5510	96.55	87.64			34.4	8.57	34.06	100	5	Average
5510	103.83	94.92			34.4	8.57	34.06	100	5	Peak
*5725.72	43.53	34.37	54	-10.47	34.62	8.65	34.11	100	5	Average
*5726.04	52.79	43.63	74	-21.21	34.62	8.65	34.11	100	5	Peak

Remarks:

- Emission Level = Read Level + Antenna Factor + Cable Loss - Preamp Factor
Margin value = Emission level – Limit value
- 5510 MHz: Fundamental Frequency
- *: Out of Restricted Band

802.11ac (VHT80)

EUT Test Condition		Measurement Detail	
Channel	Channel 155	Frequency Range	1 GHz ~ 40 GHz
Input Power	120 Vac, 60 Hz	Detector Function	Peak (PK) Average (AV)
Environmental Conditions	25 deg. C, 65 % RH	Tested By	Charles Hsiao

<Spurious Emission>

Antenna Polarity & Test Distance: Horizontal at 3 m										
Frequency (MHz)	Emission Level (dBuV/m)	Read Level (dBuV)	Limit (dBuV/m)	Margin (dB)	Antenna Factor (dB/m)	Cable Loss (dB)	Preamp Factor (dB)	Antenna Height (cm)	Table Angle (Degree)	Remark
5775	91.88	82.65			34.68	8.67	34.12	101	50	Average
5775	98.16	88.93			34.68	8.67	34.12	101	50	Peak
11550	48.12	32.85	54	-5.88	37.97	12.68	35.38	147	258	Average
11550	58.07	42.8	74	-15.93	37.97	12.68	35.38	147	258	Peak

Antenna Polarity & Test Distance: Vertical at 3 m										
Frequency (MHz)	Emission Level (dBuV/m)	Read Level (dBuV)	Limit (dBuV/m)	Margin (dB)	Antenna Factor (dB/m)	Cable Loss (dB)	Preamp Factor (dB)	Antenna Height (cm)	Table Angle (Degree)	Remark
5775	94.47	85.24			34.68	8.67	34.12	100	118	Average
5775	101.45	92.22			34.68	8.67	34.12	100	118	Peak
11550	48.85	33.58	54	-5.15	37.97	12.68	35.38	103	214	Average
11550	57.59	42.32	74	-16.41	37.97	12.68	35.38	103	214	Peak

<Out of Band Emission (OOBE)>

Antenna Polarity & Test Distance: Horizontal at 3 m										
Frequency (MHz)	Emission Level (dBuV/m)	Read Level (dBuV)	Limit (dBuV/m)	Margin (dB)	Antenna Factor (dB/m)	Cable Loss (dB)	Preamp Factor (dB)	Antenna Height (cm)	Table Angle (Degree)	Remark
*5647.525	45.21	36.14	54	-8.79	34.54	8.62	34.09	101	50	Average
*5647.525	54.31	45.24	74	-19.69	34.54	8.62	34.09	101	50	Peak
5659.075	54.66	45.57	79.66	-25	34.56	8.63	34.1	101	50	Peak
5923.675	53.81	44.41	74.83	-21.02	34.83	8.73	34.16	101	50	Peak
*5929.975	45.67	36.27	54	-8.33	34.83	8.73	34.16	101	50	Average
*5929.975	54.14	44.74	74	-19.86	34.83	8.73	34.16	101	50	Peak

Antenna Polarity & Test Distance: Vertical at 3 m										
Frequency (MHz)	Emission Level (dBuV/m)	Read Level (dBuV)	Limit (dBuV/m)	Margin (dB)	Antenna Factor (dB/m)	Cable Loss (dB)	Preamp Factor (dB)	Antenna Height (cm)	Table Angle (Degree)	Remark
*5580.85	45.22	36.23	54	-8.78	34.47	8.6	34.08	100	118	Average
*5580.85	53.51	44.52	74	-20.49	34.47	8.6	34.08	100	118	Peak
5654.875	53.86	44.77	77.04	-23.18	34.56	8.63	34.1	100	118	Peak
5924.2	52.6	43.2	74.5	-21.9	34.83	8.73	34.16	100	118	Peak
*6007.15	45.81	36.3	54	-8.19	34.92	8.76	34.17	100	118	Average
*6007.15	53.94	44.43	74	-20.06	34.92	8.76	34.17	100	118	Peak

Remarks:

- Emission Level = Read Level + Antenna Factor + Cable Loss - Preamp Factor
Margin value = Emission level – Limit value
- 5775 MHz: Fundamental Frequency
- *: Out of Restricted Band

9 kHz ~ 30 MHz DATA:

The amplitude of spurious emissions attenuated more than 20 dB below the permissible value is not required to be report.

30 MHz ~ 1 GHz WORST-CASE DATA:

Mode A

802.11n (HT40)

EUT Test Condition		Measurement Detail	
Channel	Channel 38	Frequency Range	30 MHz ~ 1 GHz
Input Power	120 Vac, 60 Hz	Detector Function	Peak (PK) Quasi-peak (QP)
Environmental Conditions	25 deg. C, 65 % RH	Tested By	Charles Hsiao

Antenna Polarity & Test Distance: Horizontal at 3 m										
Frequency (MHz)	Emission Level (dBuV/m)	Read Level (dBuV)	Limit (dBuV/m)	Margin (dB)	Antenna Factor (dB/m)	Cable Loss (dB)	Preamp Factor (dB)	Antenna Height (cm)	Table Angle (Degree)	Remark
87.78	29.02	50.92	40	-10.98	8.8	1.11	31.81	155	89	Peak
138.27	28.7	50.31	43.5	-14.8	9.28	1.38	32.27	154	345	Peak
199.56	25.93	45.68	43.5	-17.57	10.9	1.65	32.3	198	299	Peak
307	25.2	40.89	46	-20.8	14.33	2.11	32.13	119	205	Peak
686.4	25.26	31.08	46	-20.74	23.23	3.05	32.1	165	29	Peak
865.6	25.66	29.52	46	-20.34	24.4	3.44	31.7	188	344	Peak

Antenna Polarity & Test Distance: Vertical at 3 m										
Frequency (MHz)	Emission Level (dBuV/m)	Read Level (dBuV)	Limit (dBuV/m)	Margin (dB)	Antenna Factor (dB/m)	Cable Loss (dB)	Preamp Factor (dB)	Antenna Height (cm)	Table Angle (Degree)	Remark
30.54	31.23	45.44	40	-8.77	17.31	0.74	32.26	147	77	Peak
87.51	32	53.97	40	-8	8.78	1.11	31.86	130	255	Peak
139.62	18.15	39.74	43.5	-25.35	9.3	1.38	32.27	139	297	Peak
379.8	21.66	34.81	46	-24.34	16.75	2.26	32.16	155	116	Peak
674.5	25.12	30.79	46	-20.88	23.4	3.05	32.12	119	19	Peak
780.9	25.88	31.02	46	-20.12	23.68	3.27	32.09	136	162	Peak

Remarks:

- Emission Level = Read Level + Antenna Factor + Cable Loss - Preamp Factor
Margin value = Emission level – Limit value

802.11ac (VHT80)

EUT Test Condition		Measurement Detail	
Channel	Channel 58	Frequency Range	30 MHz ~ 1 GHz
Input Power	120 Vac, 60 Hz	Detector Function	Peak (PK) Quasi-peak (QP)
Environmental Conditions	25 deg. C, 65 % RH	Tested By	Charles Hsiao

Antenna Polarity & Test Distance: Horizontal at 3 m

Frequency (MHz)	Emission Level (dBuV/m)	Read Level (dBuV)	Limit (dBuV/m)	Margin (dB)	Antenna Factor (dB/m)	Cable Loss (dB)	Preamp Factor (dB)	Antenna Height (cm)	Table Angle (Degree)	Remark
87.78	27.8	49.7	40	-12.2	8.8	1.11	31.81	127	288	Peak
137.46	28.98	50.58	43.5	-14.52	9.28	1.38	32.26	150	153	Peak
198.48	25.97	45.81	43.5	-17.53	10.84	1.61	32.29	198	348	Peak
305.6	25.33	41.1	46	-20.67	14.25	2.11	32.13	154	33	Peak
619.2	22.52	29.81	46	-23.48	21.96	2.93	32.18	120	210	Peak
798.4	26.16	30.48	46	-19.84	24.42	3.32	32.06	163	263	Peak

Antenna Polarity & Test Distance: Vertical at 3 m

Frequency (MHz)	Emission Level (dBuV/m)	Read Level (dBuV)	Limit (dBuV/m)	Margin (dB)	Antenna Factor (dB/m)	Cable Loss (dB)	Preamp Factor (dB)	Antenna Height (cm)	Table Angle (Degree)	Remark
30.81	30.97	45.3	40	-9.03	17.19	0.74	32.26	120	133	Peak
87.24	31.69	53.68	40	-8.31	8.76	1.11	31.86	157	240	Peak
135.84	21.64	43.25	43.5	-21.86	9.26	1.38	32.25	138	158	Peak
524	22.13	30.87	46	-23.87	20.7	2.7	32.14	126	252	Peak
687.1	25.33	31.15	46	-20.67	23.23	3.05	32.1	178	78	Peak
859.3	25.85	29.95	46	-20.15	24.2	3.44	31.74	150	129	Peak

Remarks:

- Emission Level = Read Level + Antenna Factor + Cable Loss - Preamp Factor
Margin value = Emission level – Limit value

802.11n (HT40)

EUT Test Condition		Measurement Detail	
Channel	Channel 102	Frequency Range	30 MHz ~ 1 GHz
Input Power	120 Vac, 60 Hz	Detector Function	Peak (PK) Quasi-peak (QP)
Environmental Conditions	25 deg. C, 65 % RH	Tested By	Charles Hsiao

Antenna Polarity & Test Distance: Horizontal at 3 m

Frequency (MHz)	Emission Level (dBuV/m)	Read Level (dBuV)	Limit (dBuV/m)	Margin (dB)	Antenna Factor (dB/m)	Cable Loss (dB)	Preamp Factor (dB)	Antenna Height (cm)	Table Angle (Degree)	Remark
86.7	29.41	51.48	40	-10.59	8.73	1.11	31.91	154	148	Peak
135.84	29.12	50.73	43.5	-14.38	9.26	1.38	32.25	193	150	Peak
200.1	26.11	45.86	43.5	-17.39	10.9	1.65	32.3	109	177	Peak
313.3	24.78	40.2	46	-21.22	14.59	2.11	32.12	121	211	Peak
607.3	21.76	29.69	46	-24.24	21.39	2.87	32.19	130	336	Peak
771.8	24.93	30.32	46	-21.07	23.45	3.27	32.11	169	77	Peak

Antenna Polarity & Test Distance: Vertical at 3 m

Frequency (MHz)	Emission Level (dBuV/m)	Read Level (dBuV)	Limit (dBuV/m)	Margin (dB)	Antenna Factor (dB/m)	Cable Loss (dB)	Preamp Factor (dB)	Antenna Height (cm)	Table Angle (Degree)	Remark
30.27	32.1	46.08	40	-7.9	17.55	0.74	32.27	102	256	Peak
87.78	31.85	53.75	40	-8.15	8.8	1.11	31.81	118	148	Peak
135.57	20.87	42.49	43.5	-22.63	9.25	1.38	32.25	169	154	Peak
481.3	20.66	31.29	46	-25.34	18.92	2.56	32.11	181	359	Peak
590.5	21.26	29.85	46	-24.74	20.73	2.87	32.19	125	119	Peak
815.9	25.43	30.14	46	-20.57	23.94	3.32	31.97	128	134	Peak

Remarks:

- Emission Level = Read Level + Antenna Factor + Cable Loss - Preamp Factor
Margin value = Emission level – Limit value

802.11ac (VHT80)

EUT Test Condition		Measurement Detail	
Channel	Channel 155	Frequency Range	30 MHz ~ 1 GHz
Input Power	120 Vac, 60 Hz	Detector Function	Peak (PK) Quasi-peak (QP)
Environmental Conditions	25 deg. C, 65 % RH	Tested By	Charles Hsiao

Antenna Polarity & Test Distance: Horizontal at 3 m

Frequency (MHz)	Emission Level (dBuV/m)	Read Level (dBuV)	Limit (dBuV/m)	Margin (dB)	Antenna Factor (dB/m)	Cable Loss (dB)	Preamp Factor (dB)	Antenna Height (cm)	Table Angle (Degree)	Remark
86.7	29.93	52	40	-10.07	8.73	1.11	31.91	187	277	Peak
137.46	29.21	50.81	43.5	-14.29	9.28	1.38	32.26	157	262	Peak
198.75	25.82	45.66	43.5	-17.68	10.84	1.61	32.29	187	144	Peak
532.4	22.41	31.3	46	-23.59	20.57	2.7	32.16	154	113	Peak
672.4	24.68	30.35	46	-21.32	23.4	3.05	32.12	134	159	Peak
786.5	26.03	30.79	46	-19.97	24.05	3.27	32.08	126	260	Peak

Antenna Polarity & Test Distance: Vertical at 3 m

Frequency (MHz)	Emission Level (dBuV/m)	Read Level (dBuV)	Limit (dBuV/m)	Margin (dB)	Antenna Factor (dB/m)	Cable Loss (dB)	Preamp Factor (dB)	Antenna Height (cm)	Table Angle (Degree)	Remark
30.54	31.04	45.25	40	-8.96	17.31	0.74	32.26	144	310	Peak
88.05	31.71	53.61	43.5	-11.79	8.8	1.11	31.81	188	5	Peak
136.11	21.06	42.67	43.5	-22.44	9.26	1.38	32.25	199	155	Peak
438.6	20.59	32.4	46	-25.41	17.86	2.49	32.16	150	205	Peak
673.8	24.38	30.05	46	-21.62	23.4	3.05	32.12	180	149	Peak
880.3	27.03	30.3	46	-18.97	24.84	3.49	31.6	160	314	Peak

Remarks:

- Emission Level = Read Level + Antenna Factor + Cable Loss - Preamp Factor
Margin value = Emission level – Limit value

Mode B

802.11n (HT40)

EUT Test Condition		Measurement Detail	
Channel	Channel 38	Frequency Range	30 MHz ~ 1 GHz
Input Power	120 Vac, 60 Hz	Detector Function	Peak (PK) Quasi-peak (QP)
Environmental Conditions	25 deg. C, 65 % RH	Tested By	Charles Hsiao

Antenna Polarity & Test Distance: Horizontal at 3 m										
Frequency (MHz)	Emission Level (dBuV/m)	Read Level (dBuV)	Limit (dBuV/m)	Margin (dB)	Antenna Factor (dB/m)	Cable Loss (dB)	Preamp Factor (dB)	Antenna Height (cm)	Table Angle (Degree)	Remark
84.81	25.54	47.75	40	-14.46	8.64	1.11	31.96	163	145	Peak
135.03	27.19	48.81	43.5	-16.31	9.25	1.38	32.25	196	110	Peak
265.71	23.57	40.29	46	-22.43	13.45	1.94	32.11	175	206	Peak
432.3	18.3	30.25	46	-27.7	17.81	2.41	32.17	134	216	Peak
621.3	21.05	28.33	46	-24.95	21.96	2.93	32.17	188	146	Peak
805.4	24.26	28.59	46	-21.74	24.38	3.32	32.03	134	25	Peak

Antenna Polarity & Test Distance: Vertical at 3 m										
Frequency (MHz)	Emission Level (dBuV/m)	Read Level (dBuV)	Limit (dBuV/m)	Margin (dB)	Antenna Factor (dB/m)	Cable Loss (dB)	Preamp Factor (dB)	Antenna Height (cm)	Table Angle (Degree)	Remark
82.38	27.55	50.03	40	-12.45	8.52	1.11	32.11	193	223	Peak
162.3	15.85	36.01	43.5	-27.65	10.58	1.52	32.26	154	182	Peak
261.66	19.54	36.38	46	-26.46	13.33	1.94	32.11	134	176	Peak
446.3	18.37	30.08	46	-27.63	17.95	2.49	32.15	182	114	Peak
618.5	22.35	29.79	46	-23.65	21.81	2.93	32.18	193	160	Peak
868.4	25.24	28.88	46	-20.76	24.6	3.44	31.68	124	342	Peak

Remarks:

- Emission Level = Read Level + Antenna Factor + Cable Loss - Preamp Factor
Margin value = Emission level – Limit value

802.11ac (VHT80)

EUT Test Condition		Measurement Detail	
Channel	Channel 58	Frequency Range	30 MHz ~ 1 GHz
Input Power	120 Vac, 60 Hz	Detector Function	Peak (PK) Quasi-peak (QP)
Environmental Conditions	25 deg. C, 65 % RH	Tested By	Charles Hsiao

Antenna Polarity & Test Distance: Horizontal at 3 m

Frequency (MHz)	Emission Level (dBuV/m)	Read Level (dBuV)	Limit (dBuV/m)	Margin (dB)	Antenna Factor (dB/m)	Cable Loss (dB)	Preamp Factor (dB)	Antenna Height (cm)	Table Angle (Degree)	Remark
92.91	22.42	44.05	43.5	-21.08	9.14	1.11	31.88	107	146	Peak
170.67	19.37	40.05	43.5	-24.13	10.04	1.52	32.24	176	120	Peak
246.27	22.22	39.65	46	-23.78	12.83	1.85	32.11	199	243	Peak
451.9	18.26	29.82	46	-27.74	18.09	2.49	32.14	106	118	Peak
748	24.01	29.7	46	-21.99	23.23	3.22	32.14	186	138	Peak
942.6	27.13	28.47	46	-18.87	26.2	3.62	31.16	134	120	Peak

Antenna Polarity & Test Distance: Vertical at 3 m

Frequency (MHz)	Emission Level (dBuV/m)	Read Level (dBuV)	Limit (dBuV/m)	Margin (dB)	Antenna Factor (dB/m)	Cable Loss (dB)	Preamp Factor (dB)	Antenna Height (cm)	Table Angle (Degree)	Remark
48.63	21.82	44.91	40	-18.18	8.23	0.9	32.22	137	128	Peak
176.61	16.75	37.13	43.5	-26.75	10.25	1.61	32.24	134	187	Peak
256.8	20.16	37.11	46	-25.84	13.21	1.94	32.1	196	106	Peak
414.1	17.16	29.1	46	-28.84	17.85	2.41	32.2	158	134	Peak
649.3	25.15	32.21	46	-20.85	22.1	2.99	32.15	145	114	Peak
903.4	25.64	28.33	46	-20.36	25.24	3.53	31.46	169	187	Peak

Remarks:

- Emission Level = Read Level + Antenna Factor + Cable Loss - Preamp Factor
Margin value = Emission level – Limit value

802.11n (HT40)

EUT Test Condition		Measurement Detail	
Channel	Channel 102	Frequency Range	30 MHz ~ 1 GHz
Input Power	120 Vac, 60 Hz	Detector Function	Peak (PK) Quasi-peak (QP)
Environmental Conditions	25 deg. C, 65 % RH	Tested By	Charles Hsiao

Antenna Polarity & Test Distance: Horizontal at 3 m

Frequency (MHz)	Emission Level (dBuV/m)	Read Level (dBuV)	Limit (dBuV/m)	Margin (dB)	Antenna Factor (dB/m)	Cable Loss (dB)	Preamp Factor (dB)	Antenna Height (cm)	Table Angle (Degree)	Remark
90.75	25.83	47.51	43.5	-17.67	8.98	1.11	31.77	107	164	Peak
147.99	23.36	44.13	43.5	-20.14	9.98	1.52	32.27	198	343	Peak
231.42	19.33	37.46	46	-26.67	12.19	1.85	32.17	157	164	Peak
443.5	18.72	30.47	46	-27.28	17.92	2.49	32.16	154	113	Peak
726.3	24.35	29.91	46	-21.65	23.4	3.16	32.12	184	137	Peak
927.2	26.85	28.31	46	-19.15	26.2	3.62	31.28	134	132	Peak

Antenna Polarity & Test Distance: Vertical at 3 m

Frequency (MHz)	Emission Level (dBuV/m)	Read Level (dBuV)	Limit (dBuV/m)	Margin (dB)	Antenna Factor (dB/m)	Cable Loss (dB)	Preamp Factor (dB)	Antenna Height (cm)	Table Angle (Degree)	Remark
48.36	19.91	42.92	40	-20.09	8.31	0.9	32.22	109	314	Peak
84.81	30.88	53.09	40	-9.12	8.64	1.11	31.96	145	118	Peak
226.02	16.57	35.01	46	-29.43	11.9	1.85	32.19	163	287	Peak
440.7	18.77	30.55	46	-27.23	17.89	2.49	32.16	105	134	Peak
632.5	22.01	29.14	46	-23.99	22.1	2.93	32.16	198	246	Peak
854.4	24.26	28.58	46	-21.74	24	3.44	31.76	157	124	Peak

Remarks:

- Emission Level = Read Level + Antenna Factor + Cable Loss - Preamp Factor
Margin value = Emission level – Limit value

802.11ac (VHT80)

EUT Test Condition		Measurement Detail	
Channel	Channel 155	Frequency Range	30 MHz ~ 1 GHz
Input Power	120 Vac, 60 Hz	Detector Function	Peak (PK) Quasi-peak (QP)
Environmental Conditions	25 deg. C, 65 % RH	Tested By	Charles Hsiao

Antenna Polarity & Test Distance: Horizontal at 3 m

Frequency (MHz)	Emission Level (dBuV/m)	Read Level (dBuV)	Limit (dBuV/m)	Margin (dB)	Antenna Factor (dB/m)	Cable Loss (dB)	Preamp Factor (dB)	Antenna Height (cm)	Table Angle (Degree)	Remark
91.02	25.35	47.03	43.5	-18.15	8.98	1.11	31.77	168	134	Peak
161.49	23.77	43.86	43.5	-19.73	10.65	1.52	32.26	196	121	Peak
240.87	20.76	38.45	46	-25.24	12.59	1.85	32.13	174	132	Peak
387.5	17.83	30.48	46	-28.17	17.2	2.34	32.19	107	139	Peak
582.1	20.11	29.14	46	-25.89	20.35	2.82	32.2	153	108	Peak
799.1	24.93	29.07	46	-21.07	24.6	3.32	32.06	199	162	Peak

Antenna Polarity & Test Distance: Vertical at 3 m

Frequency (MHz)	Emission Level (dBuV/m)	Read Level (dBuV)	Limit (dBuV/m)	Margin (dB)	Antenna Factor (dB/m)	Cable Loss (dB)	Preamp Factor (dB)	Antenna Height (cm)	Table Angle (Degree)	Remark
53.22	16.52	40.4	40	-23.48	7.45	0.9	32.23	103	123	Peak
82.38	27.68	50.16	40	-12.32	8.52	1.11	32.11	198	342	Peak
216.57	17.89	36.89	46	-28.11	11.58	1.65	32.23	168	109	Peak
492.5	18.57	29.06	46	-27.43	18.98	2.63	32.1	152	113	Peak
718.6	23.97	29.61	46	-22.03	23.31	3.16	32.11	168	207	Peak
841.8	24.83	29.59	46	-21.17	23.7	3.38	31.84	136	198	Peak

Remarks:

- Emission Level = Read Level + Antenna Factor + Cable Loss - Preamp Factor
Margin value = Emission level – Limit value

4.2 Conducted Emission Measurement

4.2.1 Limits of Conducted Emission Measurement

Frequency (MHz)	Conducted Limit (dBuV)	
	Quasi-peak	Average
0.15 - 0.5	66 - 56	56 - 46
0.50 - 5.0	56	46
5.0 - 30.0	60	50

Note: 1. The lower limit shall apply at the transition frequencies.

2. The limit decreases in line with the logarithm of the frequency in the range of 0.15 to 0.50 MHz.

4.2.2 Test Instruments

Description & Manufacturer	Model No.	Serial No.	Date Of Calibration	Due Date Of Calibration
Test Receiver ROHDE & SCHWARZ	ESCI	100613	Nov. 21, 2016	Nov. 20, 2017
RF signal cable (with 10dB PAD) Woken	5D-FB	Cable-cond1-01	Dec. 22, 2016	Dec. 21, 2017
LISN ROHDE & SCHWARZ (EUT)	ESH3-Z5	835239/001	Feb. 26, 2016	Feb. 25, 2017
LISN ROHDE & SCHWARZ (Peripheral)	ESH3-Z5	100311	Jul. 28, 2016	Jul. 27, 2017
Software ADT	BV ADT_Cond_ V7.3.7.3	NA	NA	NA

Note: 1. The calibration interval of the above test instruments is 12 months and the calibrations are traceable to NML/ROC and NIST/USA.

2. The test was performed in HwaYa Shielded Room 1.

3. The VCCI Site Registration No. is C-2040.

4.2.3 Test Procedures

- a. The EUT was placed 0.4 meters from the conducting wall of the shielded room with EUT being connected to the power mains through a line impedance stabilization network (LISN). Other support units were connected to the power mains through another LISN. The two LISNs provide 50 ohm/ 50uH of coupling impedance for the measuring instrument.
- b. Both lines of the power mains connected to the EUT were checked for maximum conducted interference.
- c. The frequency range from 150 kHz to 30 MHz was searched. Emission levels under (Limit -20 dB) was not recorded.

Note: All modes of operation were investigated and the worst-case emissions are reported.

4.2.4 Deviation from Test Standard

No deviation.

4.2.5 Test Setup

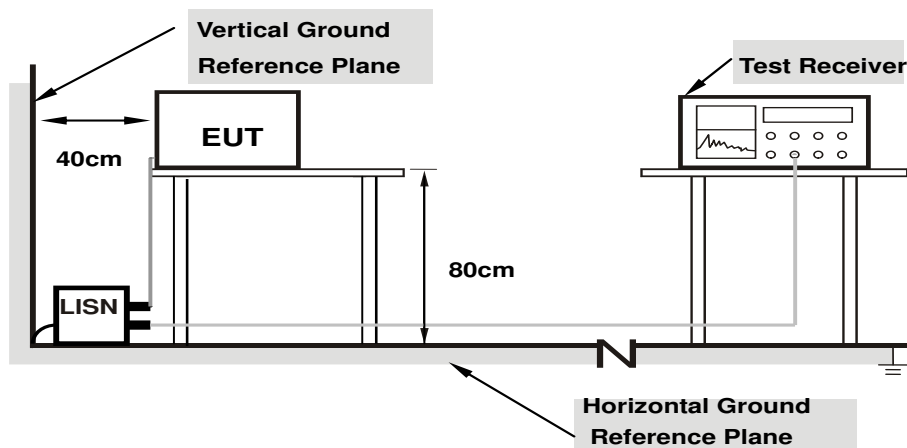

- Note:**
1. Support units were connected to second LISN.
 2. Both of LISNs (AMN) are 80 cm from EUT and at least 80 from other units and other metal planes

For the actual test configuration, please refer to the attached file (Test Setup Photo).

4.2.6 EUT Operating Conditions

- a. Placed the EUT on a testing table.
- b. Use the software to control the EUT under transmission condition continuously at specific channel frequency.

4.2.7 Test Results

Mode A

Frequency Range	150kHz ~ 30MHz	Detector Function & Resolution Bandwidth	Quasi-Peak (QP) / Average (AV), 9kHz
Input Power	120Vac, 60Hz	Environmental Conditions	25°C, 65%RH
Tested by	Toby Tian	Test Date	2017/1/8

Phase Of Power : Line (L)										
No	Frequency (MHz)	Correction Factor (dB)	Reading Value (dBuV)		Emission Level (dBuV)		Limit (dBuV)		Margin (dB)	
			Q.P.	AV.	Q.P.	AV.	Q.P.	AV.	Q.P.	AV.
1	0.15719	10.12	43.73	30.70	53.85	40.82	65.61	55.61	-11.76	-14.79
2	0.17744	10.13	36.50	24.67	46.63	34.80	64.60	54.60	-17.97	-19.80
3	0.20865	10.14	36.06	25.26	46.20	35.40	63.26	53.26	-17.06	-17.86
4	0.29819	10.15	23.71	15.24	33.86	25.39	60.29	50.29	-26.43	-24.90
5	2.19493	10.26	20.16	14.89	30.42	25.15	56.00	46.00	-25.58	-20.85
6	4.63477	10.40	24.43	17.01	34.83	27.41	56.00	46.00	-21.17	-18.59

Remarks:

1. Q.P. and AV. are abbreviations of quasi-peak and average individually.
2. The emission levels of other frequencies were very low against the limit.
3. Margin value = Emission level – Limit value
4. Correction factor = Insertion loss + Cable loss
5. Emission Level = Correction Factor + Reading Value

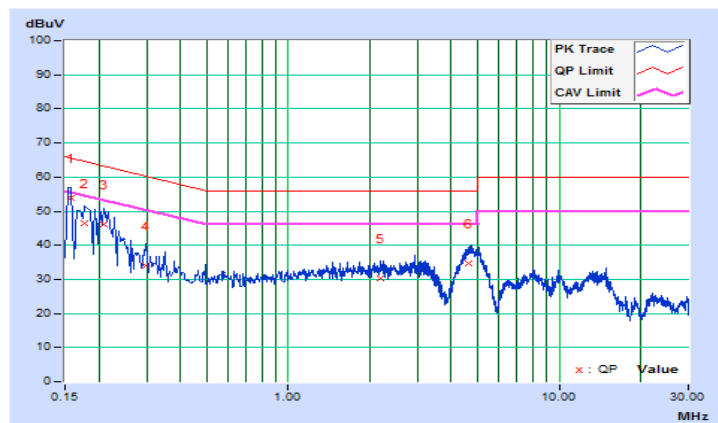

Frequency Range	150kHz ~ 30MHz	Detector Function & Resolution Bandwidth	Quasi-Peak (QP) / Average (AV), 9kHz
Input Power	120Vac, 60Hz	Environmental Conditions	25°C, 65%RH
Tested by	Toby Tian	Test Date	2017/1/8

Phase Of Power : Neutral (N)										
No	Frequency (MHz)	Correction Factor (dB)	Reading Value (dBuV)		Emission Level (dBuV)		Limit (dBuV)		Margin (dB)	
			Q.P.	AV.	Q.P.	AV.	Q.P.	AV.	Q.P.	AV.
1	0.15000	10.12	50.66	37.68	60.78	47.80	66.00	56.00	-5.22	-8.20
2	0.16173	10.13	44.09	30.30	54.22	40.43	65.37	55.37	-11.15	-14.94
3	0.21621	10.15	38.12	26.06	48.27	36.21	62.96	52.96	-14.69	-16.75
4	0.32959	10.17	25.48	17.68	35.65	27.85	59.46	49.46	-23.81	-21.61
5	0.99847	10.19	18.19	12.79	28.38	22.98	56.00	46.00	-27.62	-23.02
6	4.59958	10.43	23.37	18.09	33.80	28.52	56.00	46.00	-22.20	-17.48

Remarks:

1. Q.P. and AV. are abbreviations of quasi-peak and average individually.
2. The emission levels of other frequencies were very low against the limit.
3. Margin value = Emission level – Limit value
4. Correction factor = Insertion loss + Cable loss
5. Emission Level = Correction Factor + Reading Value

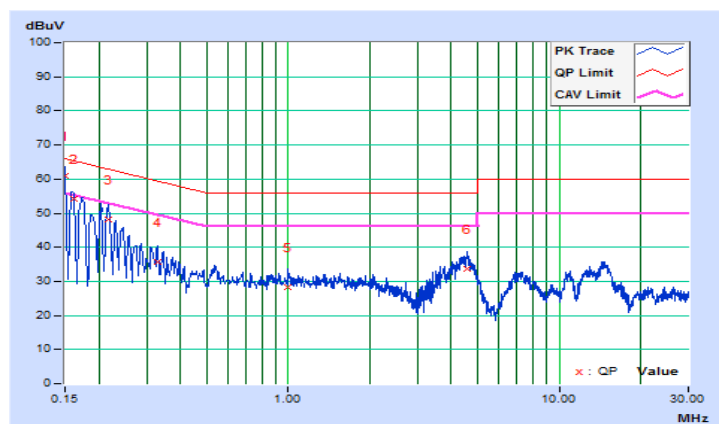

Mode B

Frequency Range	150kHz ~ 30MHz	Detector Function & Resolution Bandwidth	Quasi-Peak (QP) / Average (AV), 9kHz
Input Power	120Vac, 60Hz	Environmental Conditions	25°C, 65%RH
Tested by	Toby Tian	Test Date	2017/2/10

Phase Of Power : Line (L)										
No	Frequency (MHz)	Correction Factor (dB)	Reading Value (dBuV)		Emission Level (dBuV)		Limit (dBuV)		Margin (dB)	
			Q.P.	AV.	Q.P.	AV.	Q.P.	AV.	Q.P.	AV.
1	0.15000	10.11	44.72	30.63	54.83	40.74	66.00	56.00	-11.17	-15.26
2	0.17374	10.13	39.94	27.11	50.07	37.24	64.78	54.78	-14.71	-17.54
3	0.20404	10.14	39.30	27.36	49.44	37.50	63.44	53.44	-14.00	-15.94
4	0.25948	10.15	30.14	19.99	40.29	30.14	61.45	51.45	-21.16	-21.31
5	4.48228	10.40	19.46	13.34	29.86	23.74	56.00	46.00	-26.14	-22.26
6	13.92493	10.99	18.18	12.31	29.17	23.30	60.00	50.00	-30.83	-26.70

Remarks:

1. Q.P. and AV. are abbreviations of quasi-peak and average individually.
2. The emission levels of other frequencies were very low against the limit.
3. Margin value = Emission level – Limit value
4. Correction factor = Insertion loss + Cable loss
5. Emission Level = Correction Factor + Reading Value

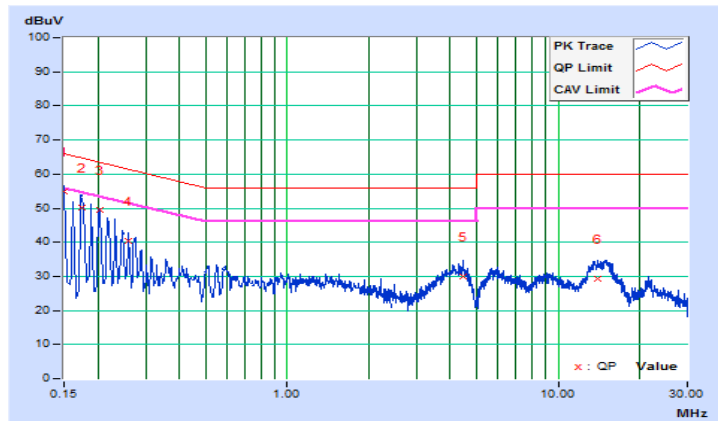

Frequency Range	150kHz ~ 30MHz	Detector Function & Resolution Bandwidth	Quasi-Peak (QP) / Average (AV), 9kHz
Input Power	120Vac, 60Hz	Environmental Conditions	25°C, 65%RH
Tested by	Toby Tian	Test Date	2017/2/10

Phase Of Power : Neutral (N)										
No	Frequency (MHz)	Correction Factor (dB)	Reading Value (dBuV)		Emission Level (dBuV)		Limit (dBuV)		Margin (dB)	
			Q.P.	AV.	Q.P.	AV.	Q.P.	AV.	Q.P.	AV.
1	0.16569	10.13	41.30	26.56	51.43	36.69	65.17	55.17	-13.74	-18.48
2	0.19717	10.15	36.14	22.94	46.29	33.09	63.73	53.73	-17.44	-20.64
3	0.25166	10.16	27.12	16.67	37.28	26.83	61.70	51.70	-24.42	-24.87
4	0.30640	10.17	21.92	12.65	32.09	22.82	60.07	50.07	-27.98	-27.25
5	4.69733	10.43	17.62	11.92	28.05	22.35	56.00	46.00	-27.95	-23.65
6	13.85846	11.07	14.66	8.48	25.73	19.55	60.00	50.00	-34.27	-30.45

Remarks:

1. Q.P. and AV. are abbreviations of quasi-peak and average individually.
2. The emission levels of other frequencies were very low against the limit.
3. Margin value = Emission level – Limit value
4. Correction factor = Insertion loss + Cable loss
5. Emission Level = Correction Factor + Reading Value

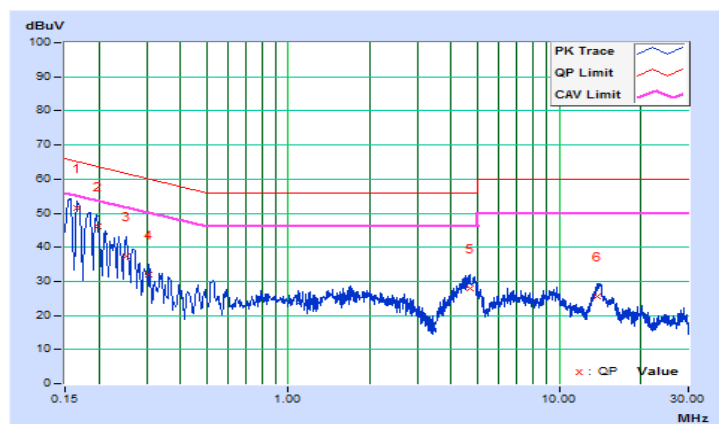

4.3 Transmit Power Measurement

4.3.1 Limits of Transmit Power Measurement

Operation Band	EUT Category	Limit
U-NII-1	Outdoor Access Point	1 Watt (30 dBm) (Max. e.i.r.p \leq 125 mW (21 dBm) at any elevation angle above 30 degrees as measured from the horizon)
	Fixed point-to-point Access Point	1 Watt (30 dBm)
	Indoor Access Point	1 Watt (30 dBm)
	√ Mobile and Portable client device	250 mW (24 dBm)
U-NII-2A	√	250 mW (24 dBm) or 11 dBm+10 log B*
U-NII-2C	√	250 mW (24 dBm) or 11 dBm+10 log B*
U-NII-3	√	1 Watt (30 dBm)

*B is the 26 dB emission bandwidth in megahertz

4.3.2 Test Setup

<Power Output Measurement>

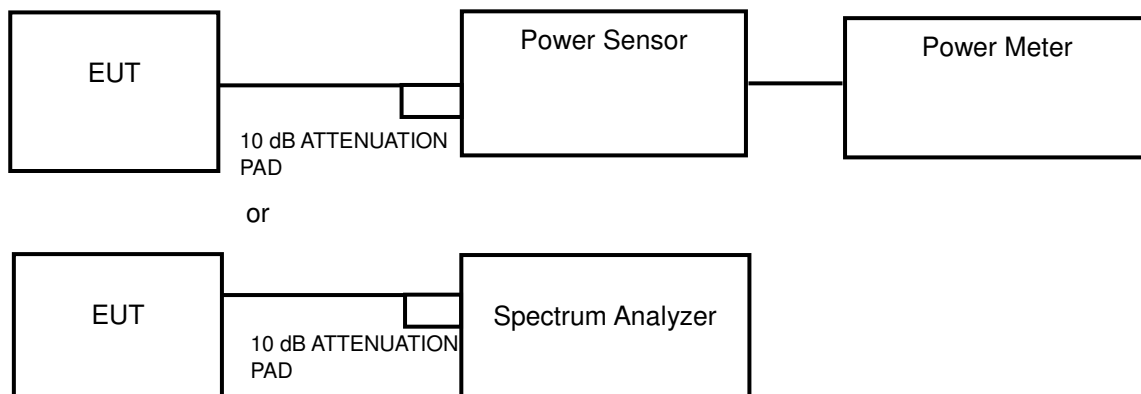

<26 dB Bandwidth>

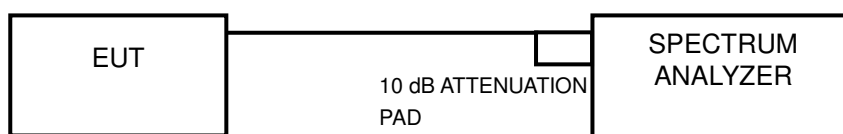

4.3.3 Test Instruments

Refer to section 4.1.2 to get information of above instrument.

4.3.4 Test Procedure

Average Power Measurement

<802.11a, 802.11n (HT20), 802.11n (HT40)>

Method PM is used to perform output power measurement, trigger and gating function of wide band power meter is enabled to measure max output power of TX on burst. Duty factor is not added to measured value.

<802.11ac (VHT80)>

Method SA-1 is used to perform output power measurement, trigger and gating function of spectrum analyzer is enabled to measure max output power of TX on burst. Duty factor is not added to measured value.

26 dB Bandwidth

- 1) Set RBW = approximately 1 % of the emission bandwidth.
- 2) Set the VBW > RBW.
- 3) Detector = Peak.
- 4) Trace mode = max hold.
- 5) Measure the maximum width of the emission that is 26 dB down from the peak of the emission. Compare this with the RBW setting of the analyzer. Readjust RBW and repeat measurement as needed until the RBW/EBW ratio is approximately 1 %.

4.3.5 Deviation from Test Standard

No deviation.

4.3.6 EUT Operating Conditions

The software provided by client to enable the EUT under transmission condition continuously at lowest, middle and highest channel frequencies individually.

4.3.7 Test Result

Power Output:

802.11a

Channel	Frequency (MHz)	Maximum Conducted Power (mW)	Maximum Conducted Power (dBm)	Power Limit (dBm)	Pass / Fail
36	5180	7.063	8.49	24	Pass
44	5220	6.982	8.44	24	Pass
48	5240	6.776	8.31	24	Pass
52	5260	7.145	8.54	23.85	Pass
60	5300	7.295	8.63	23.86	Pass
64	5320	6.902	8.39	23.83	Pass
100	5500	7.261	8.61	23.84	Pass
116	5580	7.047	8.48	23.85	Pass
140	5700	7.194	8.57	23.84	Pass
149	5745	7.638	8.83	30	Pass
157	5785	7.834	8.94	30	Pass
165	5825	8.299	9.19	30	Pass

Note:

For U-NII-2A, U-NII-2C Band:

1. $11 \text{ dBm} + 10\log(19.26) = 23.85 \text{ dBm} < 24 \text{ dBm}$.
2. $11 \text{ dBm} + 10\log(19.31) = 23.86 \text{ dBm} < 24 \text{ dBm}$.
3. $11 \text{ dBm} + 10\log(19.20) = 23.83 \text{ dBm} < 24 \text{ dBm}$.
4. $11 \text{ dBm} + 10\log(19.23) = 23.84 \text{ dBm} < 24 \text{ dBm}$.
5. $11 \text{ dBm} + 10\log(19.26) = 23.85 \text{ dBm} < 24 \text{ dBm}$.
6. $11 \text{ dBm} + 10\log(19.23) = 23.84 \text{ dBm} < 24 \text{ dBm}$.

802.11n (HT20)

Channel	Frequency (MHz)	Maximum Conducted Power (mW)	Maximum Conducted Power (dBm)	Power Limit (dBm)	Pass / Fail
36	5180	7.145	8.54	24	Pass
44	5220	6.792	8.32	24	Pass
48	5240	6.668	8.24	24	Pass
52	5260	7.047	8.48	24	Pass
60	5300	7.178	8.56	24	Pass
64	5320	6.683	8.25	24	Pass
100	5500	7.047	8.48	24	Pass
116	5580	6.982	8.44	24	Pass
140	5700	7.015	8.46	24	Pass
149	5745	8.166	9.12	30	Pass
157	5785	7.534	8.77	30	Pass
165	5825	8.318	9.20	30	Pass

Note:

For U-NII-2A, U-NII-2C Band:

1. $11 \text{ dBm} + 10\log(20.53) = 24.12 \text{ dBm} > 24 \text{ dBm}$.
2. $11 \text{ dBm} + 10\log(20.50) = 24.12 \text{ dBm} > 24 \text{ dBm}$.
3. $11 \text{ dBm} + 10\log(20.37) = 24.09 \text{ dBm} > 24 \text{ dBm}$.
4. $11 \text{ dBm} + 10\log(20.27) = 24.07 \text{ dBm} > 24 \text{ dBm}$.
5. $11 \text{ dBm} + 10\log(20.38) = 24.09 \text{ dBm} > 24 \text{ dBm}$.
6. $11 \text{ dBm} + 10\log(20.33) = 24.08 \text{ dBm} > 24 \text{ dBm}$.

802.11n (HT40)

Channel	Frequency (MHz)	Maximum Conducted Power (mW)	Maximum Conducted Power (dBm)	Power Limit (dBm)	Pass / Fail
38	5190	11.015	10.42	24	Pass
46	5230	10.069	10.03	24	Pass
54	5270	10.093	10.04	24	Pass
62	5310	11.246	10.51	24	Pass
102	5510	11.722	10.69	24	Pass
110	5550	10.520	10.22	24	Pass
134	5670	10.328	10.14	24	Pass
151	5755	11.092	10.45	30	Pass
159	5795	11.015	10.42	30	Pass

Note:

For U-NII-2A, U-NII-2C Band:

- $11 \text{ dBm} + 10\log(45.86) = 27.61 \text{ dBm} > 24 \text{ dBm}$.
- $11 \text{ dBm} + 10\log(42.61) = 27.30 \text{ dBm} > 24 \text{ dBm}$.
- $11 \text{ dBm} + 10\log(43.52) = 27.39 \text{ dBm} > 24 \text{ dBm}$.
- $11 \text{ dBm} + 10\log(44.46) = 27.48 \text{ dBm} > 24 \text{ dBm}$.
- $11 \text{ dBm} + 10\log(44.47) = 27.48 \text{ dBm} > 24 \text{ dBm}$.

802.11ac (VHT80)

Channel	Frequency (MHz)	Maximum Conducted Power (mW)	Maximum Conducted Power (dBm)	Power Limit (dBm)	Pass / Fail
42	5210	6.699	8.26	24	Pass
58	5290	7.328	8.65	24	Pass
106	5530	10.093	10.04	24	Pass
122	5610	8.241	9.16	24	Pass
155	5775	6.934	8.41	30	Pass

Note:

For U-NII-2A, U-NII-2C Band:

- $11 \text{ dBm} + 10\log(83.76) = 30.23 \text{ dBm} > 24 \text{ dBm}$.
- $11 \text{ dBm} + 10\log(83.50) = 30.22 \text{ dBm} > 24 \text{ dBm}$.
- $11 \text{ dBm} + 10\log(83.95) = 30.24 \text{ dBm} > 24 \text{ dBm}$.

26 dB Bandwidth:
802.11a

Channel	Frequency (MHz)	26 dBc Bandwidth (MHz)
36	5180	19.22
44	5220	19.24
48	5240	19.25
52	5260	19.26
60	5300	19.31
64	5320	19.20
100	5500	19.23
116	5580	19.26
140	5700	19.23

802.11n (HT20)

Channel	Frequency (MHz)	26 dBc Bandwidth (MHz)
36	5180	20.61
44	5220	20.39
48	5240	20.38
52	5260	20.53
60	5300	20.50
64	5320	20.37
100	5500	20.27
116	5580	20.38
140	5700	20.33

802.11n (HT40)

Channel	Frequency (MHz)	26 dBc Bandwidth (MHz)
38	5190	46.10
46	5230	42.07
54	5270	45.86
62	5310	42.61
102	5510	43.52
110	5550	44.46
134	5670	44.47

802.11ac (VHT80)

Channel	Frequency (MHz)	26 dBc Bandwidth (MHz)
42	5210	83.66
58	5290	83.76
106	5530	83.50
122	5610	83.95

Spectrum Plot of Worst Value

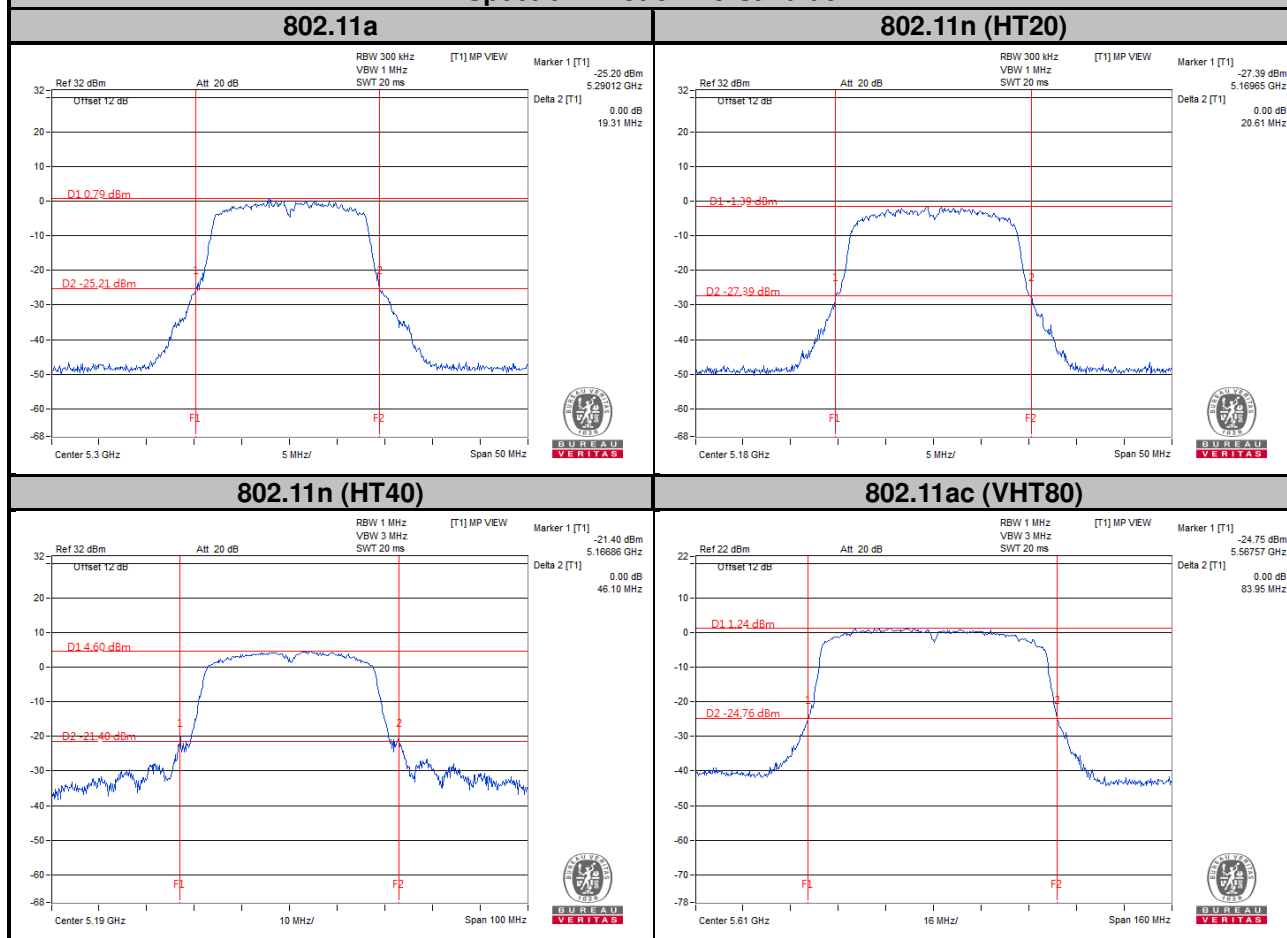

4.4 Peak Power Spectral Density Measurement

4.4.1 Limits of Peak Power Spectral Density Measurement

Operation Band	EUT Category		Limit
U-NII-1		Outdoor Access Point	17 dBm/MHz
		Fixed point-to-point Access Point	
		Indoor Access Point	
	√	Mobile and Portable client device	11 dBm/MHz
U-NII-2A		√	11 dBm/MHz
U-NII-2C		√	11 dBm/MHz
U-NII-3		√	30 dBm/500 kHz

4.4.2 Test Setup

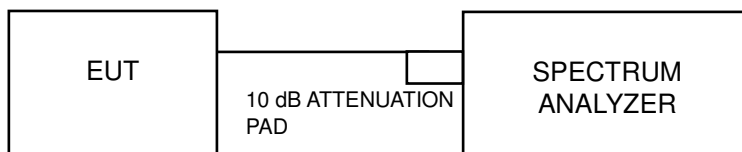

4.4.3 Test Instruments

Refer to section 4.1.3 to get information of above instrument.

4.4.4 Test Procedures

For U-NII-1, U-NII-2A, U-NII-2C band:

Using method SA-2

1. Set span to encompass the entire emission bandwidth (EBW) of the signal.
2. Set RBW = 1 MHz, Set VBW ≥ 3 RBW, Detector = RMS
3. Sweep time = auto, trigger set to “free run”.
4. Trace average at least 100 traces in power averaging mode.
5. Record the max value and add 10 log (1/duty cycle)

※For U-NII-3:

1. Set span to encompass the entire emission bandwidth (EBW) of the signal.
2. Set RBW = 500 kHz, Set VBW ≥ 3 RBW, Detector = RMS
3. Use the peak marker function to determine the maximum power level in any 500 kHz band segment within the fundamental EBW.
4. Sweep time = auto, trigger set to “free run”.
5. Trace average at least 100 traces in power averaging mode.
6. Record the max value and add 10 log (1/duty cycle)

4.4.5 Deviation from Test Standard

No deviation.

4.4.6 EUT Operating Conditions

The software provided by client to enable the EUT under transmission condition continuously at lowest, middle and highest channel frequencies individually.

4.4.7 Test Results

802.11a

Channel	Frequency (MHz)	PSD w/o Duty Factor (dBm/MHz)	Duty Factor (dB)	PSD with Duty Factor (dBm/MHz)	Maximum Limit (dBm/MHz)	Pass / Fail
36	5180	-3.94	0.22	-3.72	11	Pass
44	5220	-4.07	0.22	-3.85	11	Pass
48	5240	-4.10	0.22	-3.88	11	Pass
52	5260	-3.53	0.22	-3.31	11	Pass
60	5300	-3.28	0.22	-3.06	11	Pass
64	5320	-4.02	0.22	-3.80	11	Pass
100	5500	-3.54	0.22	-3.32	11	Pass
116	5580	-3.72	0.22	-3.50	11	Pass
140	5700	-3.57	0.22	-3.35	11	Pass

Note: Refer to section 3.3 for duty cycle spectrum plot.

802.11n (HT20)

Channel	Frequency (MHz)	PSD w/o Duty Factor (dBm/MHz)	Duty Factor (dB)	PSD with Duty Factor (dBm/MHz)	Maximum Limit (dBm/MHz)	Pass / Fail
36	5180	-3.75	0.24	-3.51	11	Pass
44	5220	-4.05	0.24	-3.81	11	Pass
48	5240	-4.11	0.24	-3.87	11	Pass
52	5260	-4.00	0.24	-3.76	11	Pass
60	5300	-3.61	0.24	-3.37	11	Pass
64	5320	-4.09	0.24	-3.85	11	Pass
100	5500	-3.67	0.24	-3.43	11	Pass
116	5580	-3.96	0.24	-3.72	11	Pass
140	5700	-3.86	0.24	-3.62	11	Pass

Note: Refer to section 3.3 for duty cycle spectrum plot.

802.11n (HT40)

Channel	Frequency (MHz)	PSD w/o Duty Factor (dBm/MHz)	Duty Factor (dB)	PSD with Duty Factor (dBm/MHz)	Maximum Limit (dBm/MHz)	Pass / Fail
38	5190	-4.63	0.43	-4.20	11	Pass
46	5230	-4.95	0.43	-4.52	11	Pass
54	5270	-4.93	0.43	-4.50	11	Pass
62	5310	-4.27	0.43	-3.84	11	Pass
102	5510	-4.25	0.43	-3.82	11	Pass
110	5550	-4.61	0.43	-4.18	11	Pass
134	5670	-4.91	0.43	-4.48	11	Pass

Note: Refer to section 3.3 for duty cycle spectrum plot.

802.11ac (VHT80)

Channel	Frequency (MHz)	PSD w/o Duty Factor (dBm/MHz)	Duty Factor (dB)	PSD with Duty Factor (dBm/MHz)	Maximum Limit (dBm/MHz)	Pass / Fail
42	5210	-10.45	0.85	-9.60	11	Pass
58	5290	-9.95	0.85	-9.10	11	Pass
106	5530	-8.54	0.85	-7.69	11	Pass
122	5610	-9.45	0.85	-8.60	11	Pass

Note: Refer to section 3.3 for duty cycle spectrum plot.

Spectrum Plot of Worst Value

802.11a

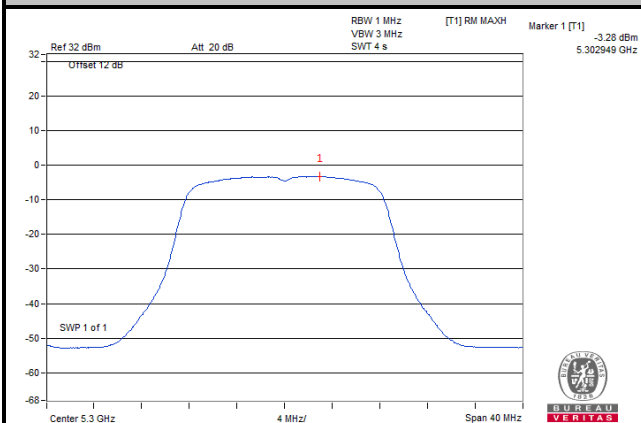

802.11n (HT20)

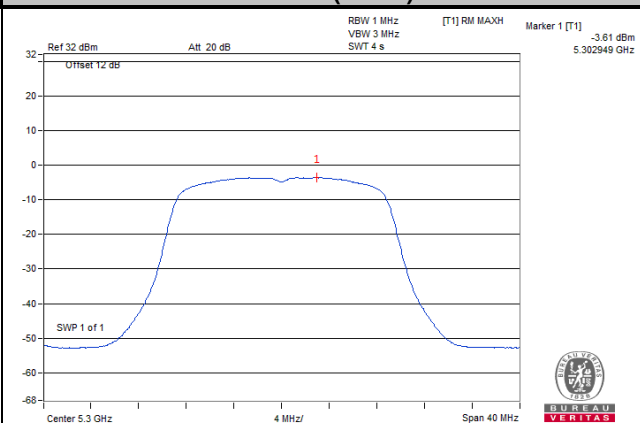

802.11n (HT40)

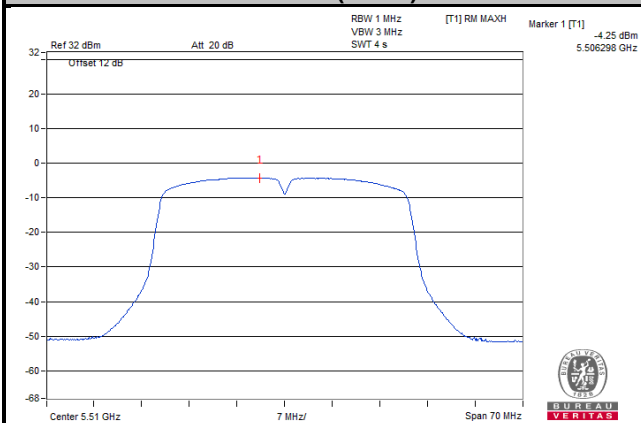

802.11ac (VHT80)

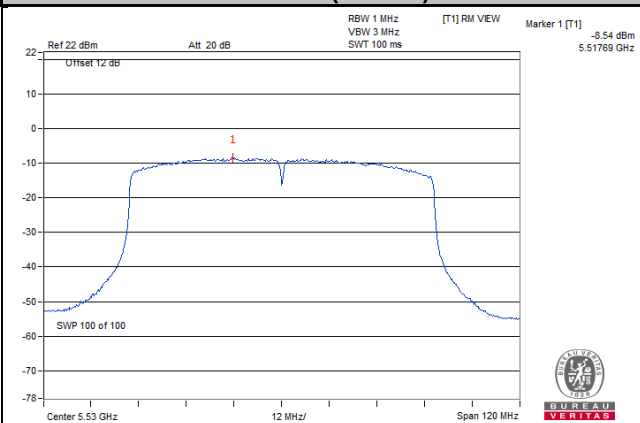

For U-NII-3 Band

802.11a

Channel	Frequency (MHz)	PSD w/o Duty Factor (dBm/500 kHz)	Duty Factor (dB)	PSD with Duty Factor (dBm/500 kHz)	Limit (dBm/500 kHz)	Pass / Fail
149	5745	-7.22	0.22	-7.00	30	Pass
157	5785	-7.73	0.22	-7.51	30	Pass
165	5825	-7.55	0.22	-7.33	30	Pass

Note: Refer to section 3.3 for duty cycle spectrum plot.

802.11n (HT20)

Channel	Frequency (MHz)	PSD w/o Duty Factor (dBm/500 kHz)	Duty Factor (dB)	PSD with Duty Factor (dBm/500 kHz)	Limit (dBm/500 kHz)	Pass / Fail
149	5745	-6.55	0.24	-6.31	30	Pass
157	5785	-7.01	0.24	-6.77	30	Pass
165	5825	-6.47	0.24	-6.23	30	Pass

Note: Refer to section 3.3 for duty cycle spectrum plot.

802.11n (HT40)

Channel	Frequency (MHz)	PSD w/o Duty Factor (dBm/500 kHz)	Duty Factor (dB)	PSD with Duty Factor (dBm/500 kHz)	Limit (dBm/500 kHz)	Pass / Fail
151	5755	-8.09	0.43	-7.66	30	Pass
159	5795	-8.32	0.43	-7.89	30	Pass

Note: Refer to section 3.3 for duty cycle spectrum plot.

802.11ac (VHT80)

Channel	Frequency (MHz)	PSD w/o Duty Factor (dBm/500 kHz)	Duty Factor (dB)	PSD with Duty Factor (dBm/500 kHz)	Limit (dBm/500 kHz)	Pass / Fail
155	5775	-12.82	0.85	-11.97	30	Pass

Note: Refer to section 3.3 for duty cycle spectrum plot.

Spectrum Plot of Worst Value

802.11a

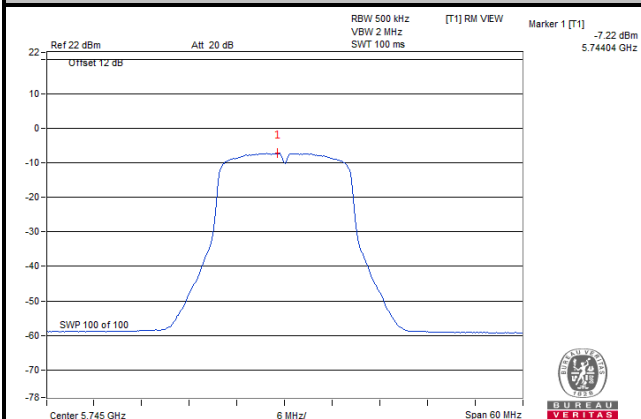

802.11n (HT20)

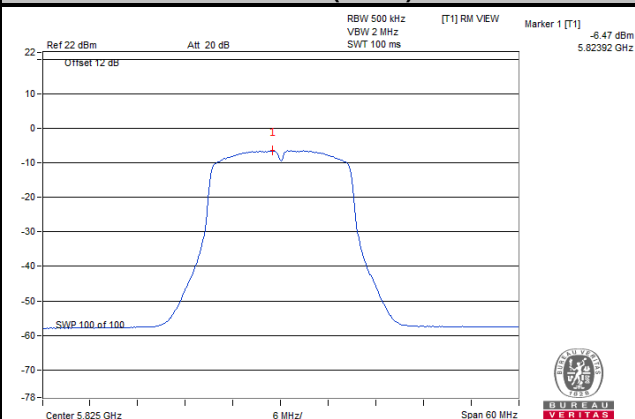

802.11n (HT40)

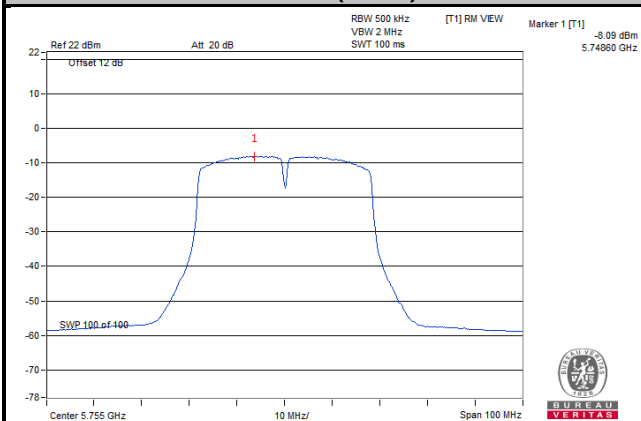

802.11ac (VHT80)

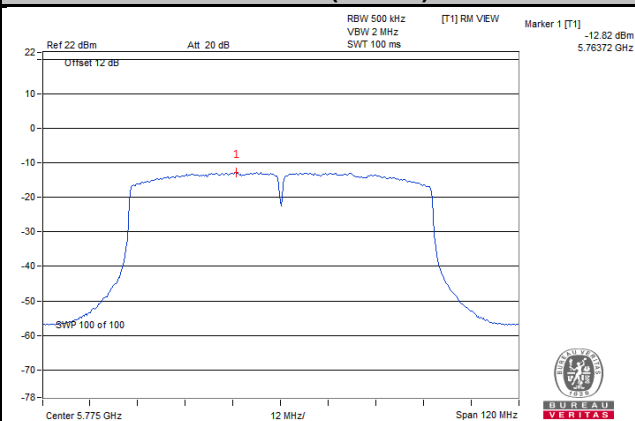

4.5 Frequency Stability

4.5.1 Limit of Frequency Stability Measurement

The frequency of the carrier signal shall be maintained within band of operation.

4.5.2 Test Setup

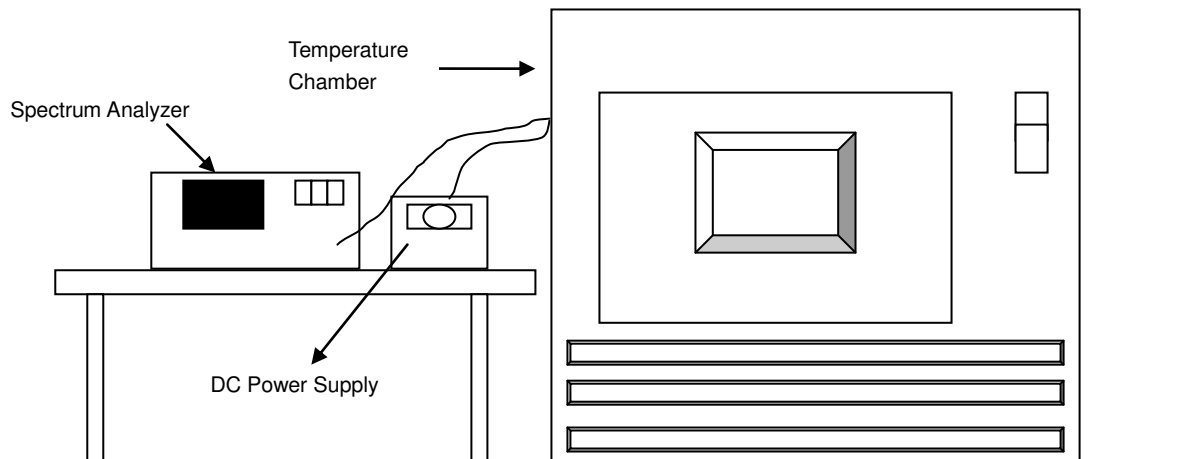

4.5.3 Test Instruments

Refer to section 4.1.3 to get information of above instrument.

4.5.4 Test Procedure

- To ensure emission at the band edge is maintained within the authorized band, those values shall be measured by radiation emissions at upper and lower frequency points, and finally compensated by frequency deviation as procedures below.
- The EUT was operated at the maximum output power, and connected to the spectrum analyzer, which is set to maximum hold function and peak detector. The peak value of the power envelope was measured and noted. The upper and lower frequency points were respectively measured relatively 10 dB lower than the measured peak value.
- The frequency deviation was calculated by adding the upper frequency point and the lower frequency point divided by two. Those detailed values of frequency deviation are provided in table below.

4.5.5 Deviation from Test Standard

No deviation.

4.5.6 EUT Operating Condition

Set the EUT transmit at un-modulation mode to test frequency stability.

4.5.7 Test Results

Frequency Stability Versus Temp.									
Operating Frequency: 5320 MHz									
Temp. (°C)	Power Supply (Vdc)	0 Minute		2 Minute		5 Minute		10 Minute	
		Measured Frequency (MHz)	Frequency Drift (ppm)	Measured Frequency (MHz)	Frequency Drift (ppm)	Measured Frequency (MHz)	Frequency Drift (ppm)	Measured Frequency (MHz)	Frequency Drift (ppm)
50	4	5320.01	0.00019	5320.0132	0.00025	5320.0143	0.00027	5320.014	0.00026
40	4	5319.9827	-0.00033	5319.9819	-0.00034	5319.9846	-0.00029	5319.9812	-0.00035
30	4	5320.0083	0.00016	5320.0094	0.00018	5320.0113	0.00021	5320.0126	0.00024
20	4	5320.0074	0.00014	5320.0088	0.00017	5320.0077	0.00014	5320.0041	0.00008
10	4	5320	0.00000	5320.0029	0.00005	5320.0008	0.00002	5320.0013	0.00002
0	4	5320.0012	0.00002	5320.0004	0.00001	5320.0035	0.00007	5320.0022	0.00004
-10	4	5320.0203	0.00038	5320.0168	0.00032	5320.0214	0.00040	5320.0206	0.00039
-20	4	5319.9983	-0.00003	5319.9957	-0.00008	5319.9946	-0.00010	5319.9947	-0.00010
-30	4	5320.0001	0.00000	5319.9988	-0.00002	5320.0008	0.00002	5319.9987	-0.00002

Frequency Stability Versus Temp.									
Operating Frequency: 5320 MHz									
Temp. (°C)	Power Supply (Vdc)	0 Minute		2 Minute		5 Minute		10 Minute	
		Measured Frequency (MHz)	Frequency Drift (ppm)	Measured Frequency (MHz)	Frequency Drift (ppm)	Measured Frequency (MHz)	Frequency Drift (ppm)	Measured Frequency (MHz)	Frequency Drift (ppm)
20	4.4	5320.0064	0.00012	5320.0088	0.00017	5320.0068	0.00013	5320.0036	0.00007
	4	5320.0074	0.00014	5320.0088	0.00017	5320.0077	0.00014	5320.0041	0.00008
	3.6	5320.0066	0.00012	5320.0097	0.00018	5320.008	0.00015	5320.0033	0.00006

4.6 6 dB Bandwidth Measurement

4.6.1 Limits of 6 dB Bandwidth Measurement

The minimum of 6 dB Bandwidth Measurement is 0.5 MHz.

4.6.2 Test Setup

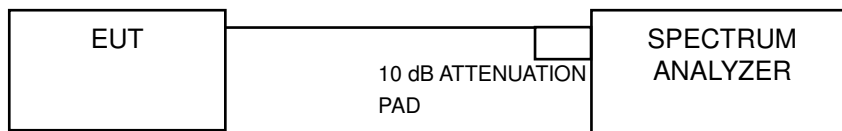

4.6.3 Test Instruments

Refer to section 4.1.3 to get information of above instrument.

4.6.4 Test Procedure

MEASUREMENT PROCEDURE REF

- Set resolution bandwidth (RBW) = 100 kHz
- Set the video bandwidth (VBW) $\geq 3 \times$ RBW, Detector = Peak.
- Trace mode = max hold.
- Sweep = auto couple.
- Measure the maximum width of the emission that is constrained by the frequencies associated with the two amplitude points (upper and lower) that are attenuated by 6 dB relative to the maximum level measured in the fundamental emission

4.6.5 Deviation from Test Standard

No deviation.

4.6.6 EUT Operating Condition

The software provided by client to enable the EUT under transmission condition continuously at lowest, middle and highest channel frequencies individually.

4.6.7 Test Results

802.11a

Channel	Frequency (MHz)	6 dB Bandwidth (MHz)	Minimum Limit (MHz)	Pass / Fail
149	5745	15.19	0.5	Pass
157	5785	15.19	0.5	Pass
165	5825	15.20	0.5	Pass

802.11n (HT20)

Channel	Frequency (MHz)	6 dB Bandwidth (MHz)	Minimum Limit (MHz)	Pass / Fail
149	5745	15.18	0.5	Pass
157	5785	15.17	0.5	Pass
165	5825	15.18	0.5	Pass

802.11n (HT40)

Channel	Frequency (MHz)	6 dB Bandwidth (MHz)	Minimum Limit (MHz)	Pass / Fail
151	5755	35.16	0.5	Pass
159	5795	35.21	0.5	Pass

802.11ac (VHT80)

Channel	Frequency (MHz)	6 dB Bandwidth (MHz)	Minimum Limit (MHz)	Pass / Fail
155	5775	75.43	0.5	Pass

Spectrum Plot of Worst Value

802.11a

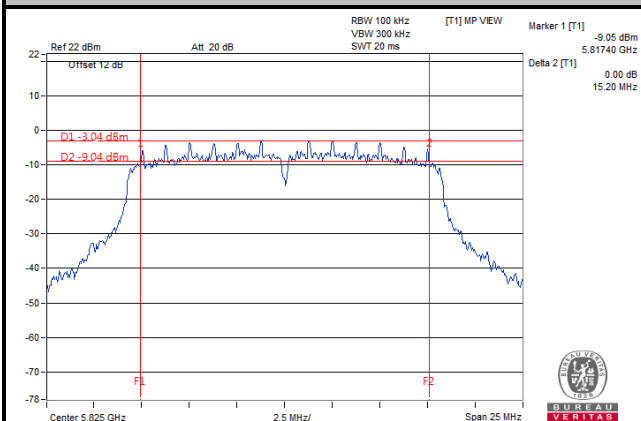

802.11n (HT20)

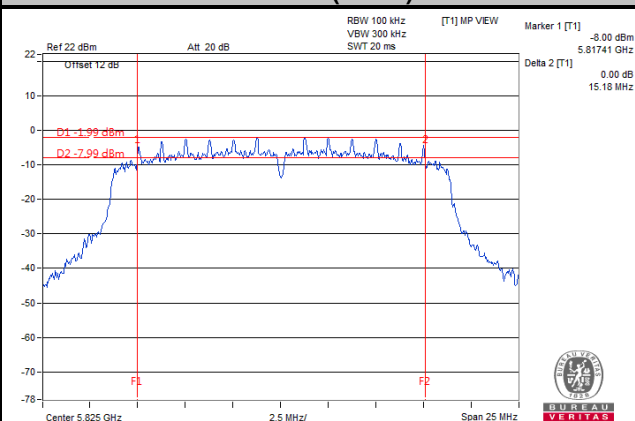

802.11n (HT40)

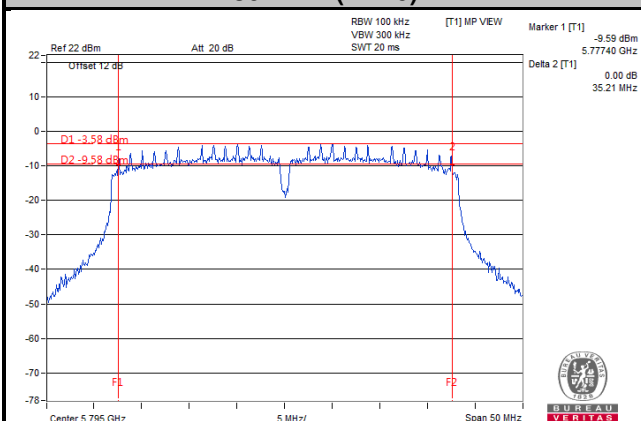

802.11ac (VHT80)

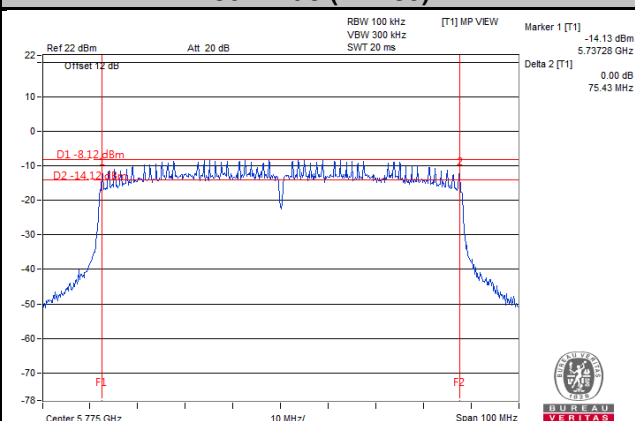

5 Pictures of Test Arrangements

Please refer to the attached file (Test Setup Photo).

Annex A- Radiated Out of Band Emisison (OOBE) Measurement (For U-NII-3 band)

Mode A

802.11a

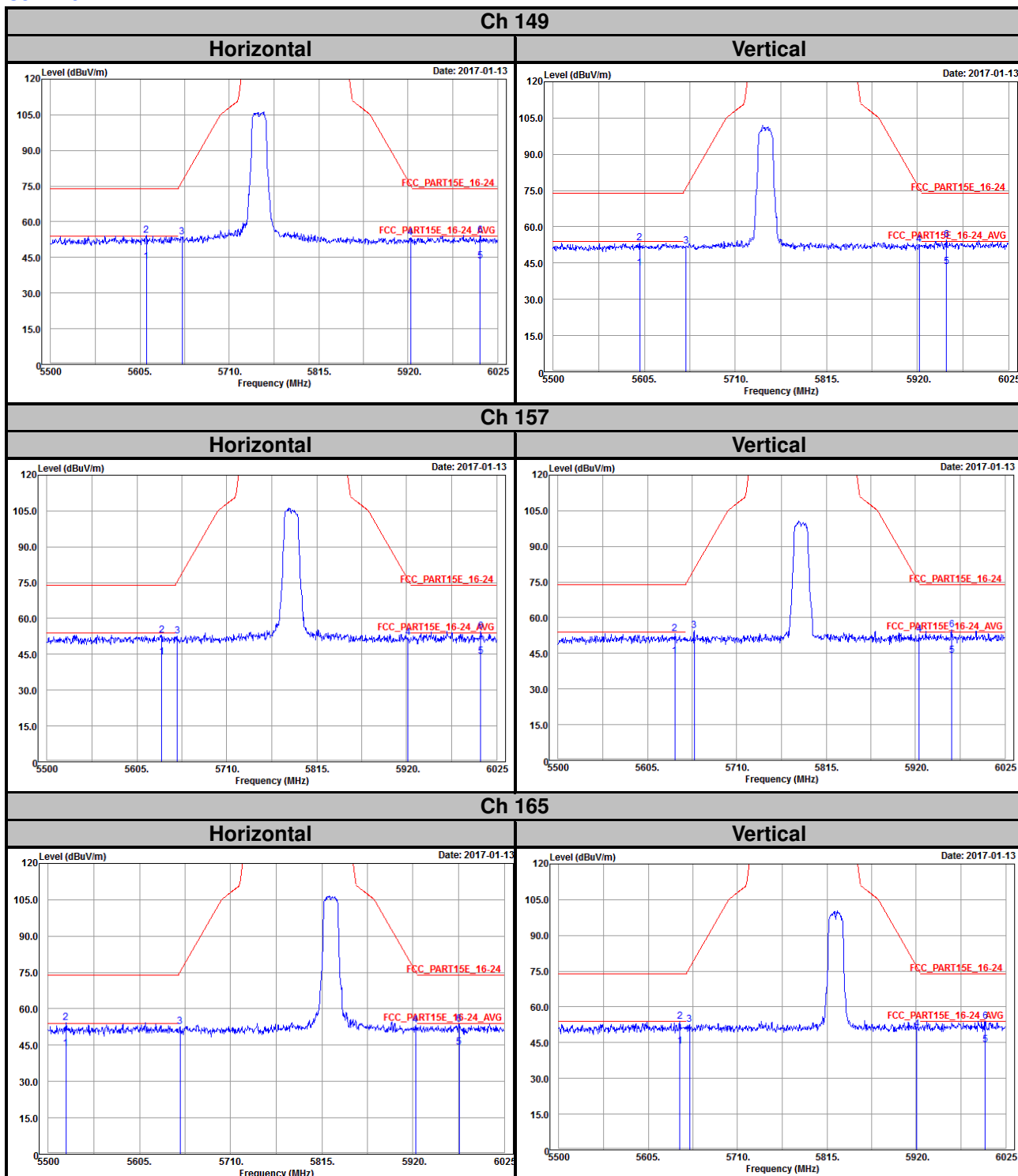

802.11n (HT20)

Ch 149

Horizontal

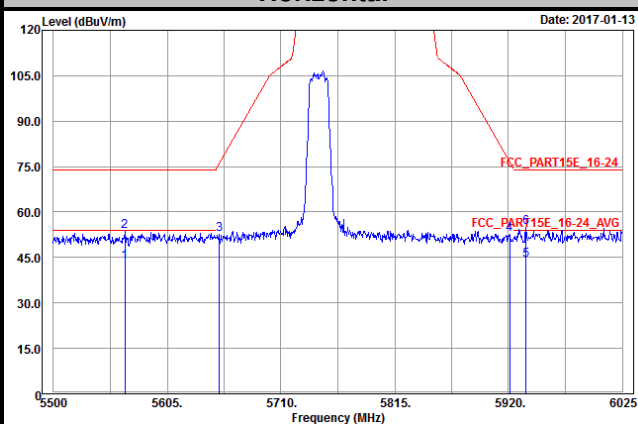

Vertical

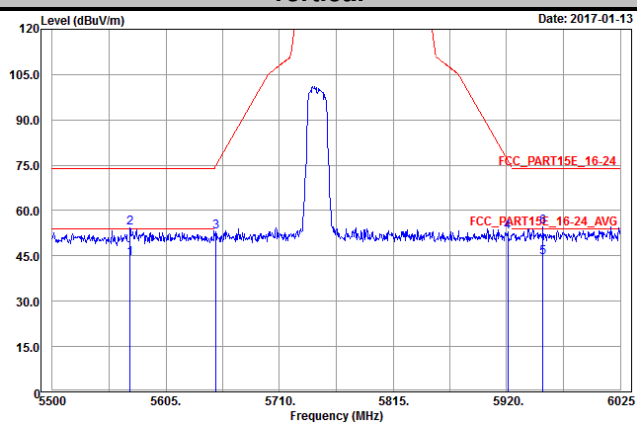

Ch 157

Horizontal

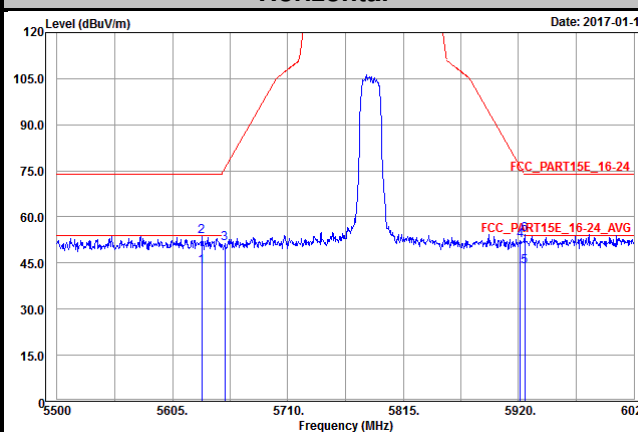

Vertical

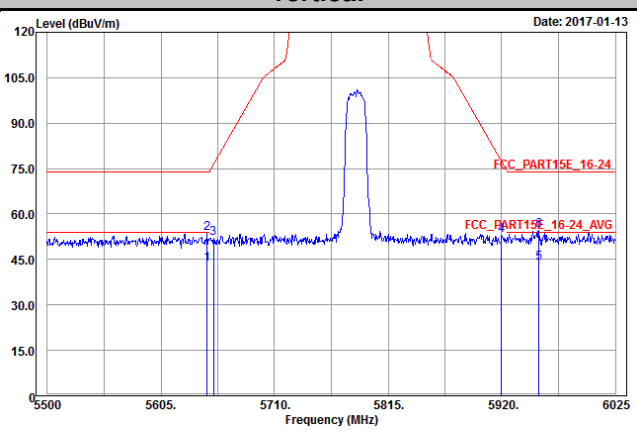

Ch 165

Horizontal

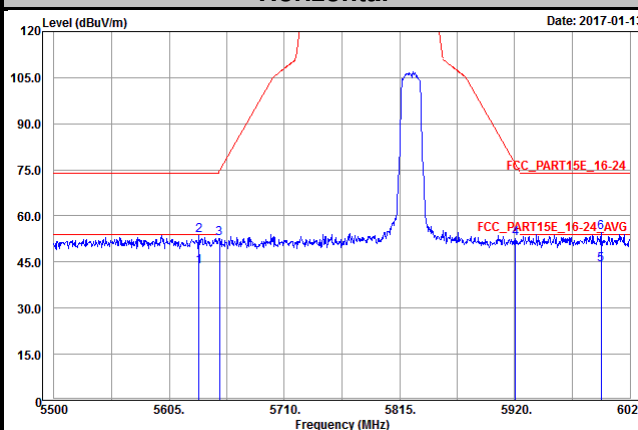

Vertical

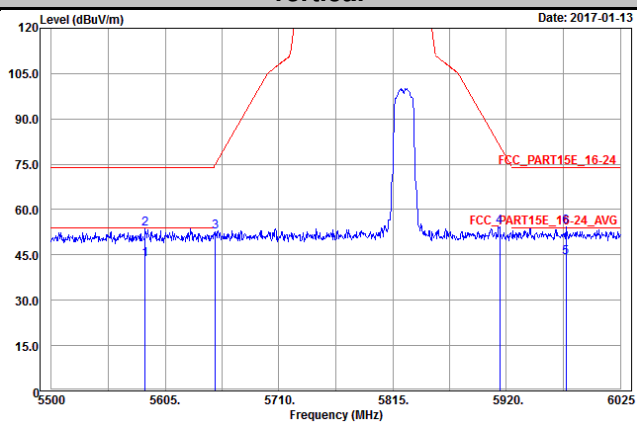

802.11n (HT40)

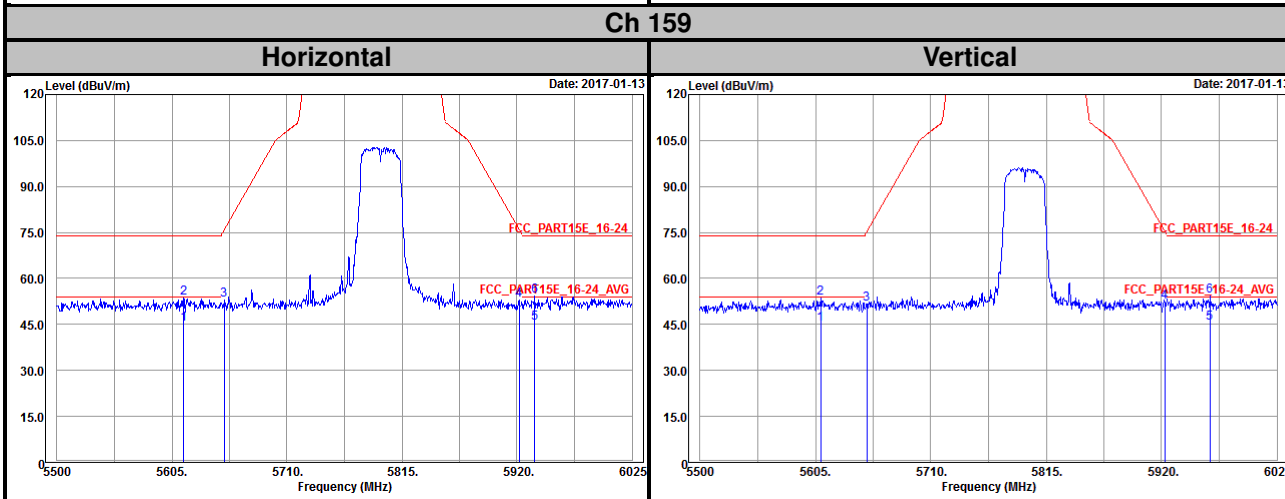
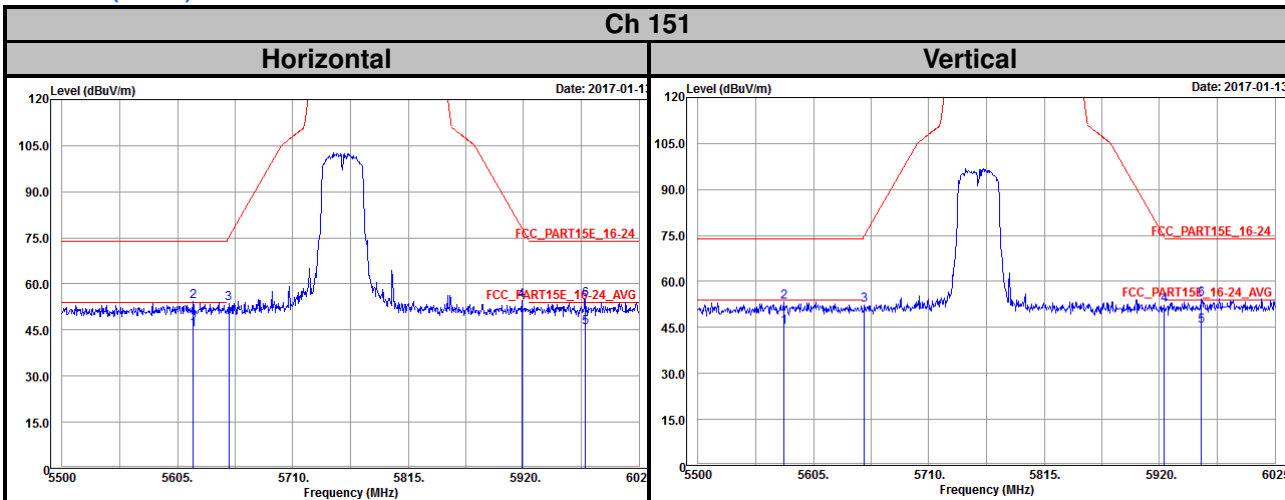

802.11ac (VHT80)

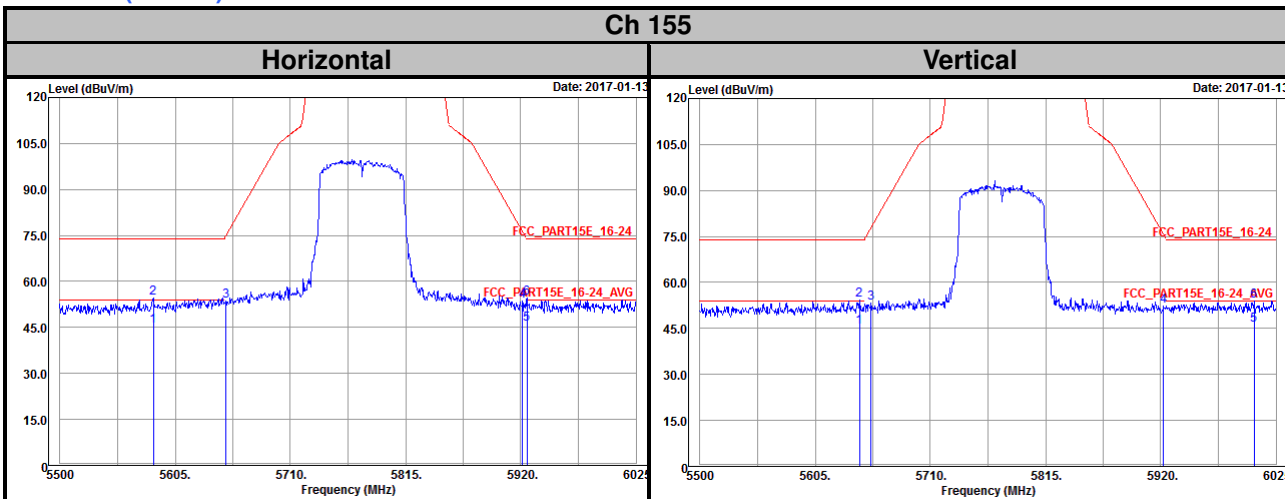

Mode B
802.11ac (VHT80)

Ch 155

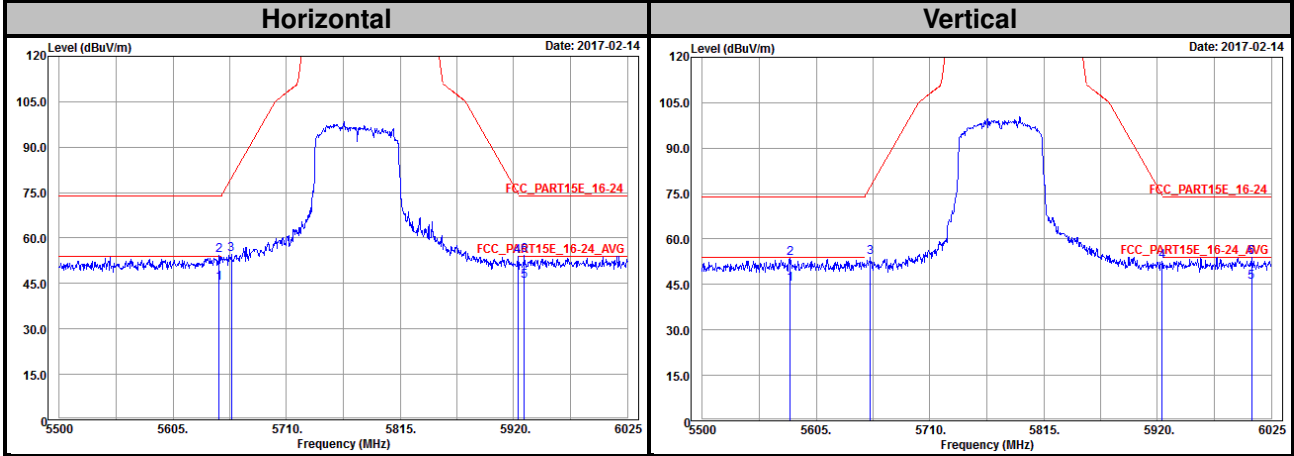

Appendix – Information on the Testing Laboratories

We, Bureau Veritas Consumer Products Services (H.K.) Ltd., Taoyuan Branch, were founded in 1988 to provide our best service in EMC, Radio, Telecom and Safety consultation. Our laboratories are accredited and approved according to ISO/IEC 17025.

If you have any comments, please feel free to contact us at the following:

Linko EMC/RF Lab

Tel: 886-2-26052180

Fax: 886-2-26051924

Hsin Chu EMC/RF/Telecom Lab

Tel: 886-3-6668565

Fax: 886-3-6668323

Hwa Ya EMC/RF/Safety

Tel: 886-3-3183232

Fax: 886-3-3270892

Email: service.adt@tw.bureauveritas.com

Web Site: www.bureauveritas-adt.com

The address and road map of all our labs can be found in our web site also.

--- END ---