

RF Test Report

Applicant : ASUSTeK COMPUTER INC.
Applicant Address : 4F, No. 150, Li-Te Rd., Peitou, Taipei, Taiwan
Product Type : Intel Wireless-AC 9560
Trade Name : Intel
Model Number : 9560NGW
Applicable Standard : FCC 47 CFR PART 15 SUBPART C
ANSI C63.10:2013
Receive Date : Mar. 18, 2019
Test Period : Apr. 15 ~ Apr. 20, 2019
Issue Date : May 08, 2019

Issue by

A Test Lab Techno Corp.
No. 140-1, Changan Street, Bade District,
Taoyuan City 33465, Taiwan (R.O.C.)
Tel : +886-3-2710188 / Fax : +886-3-2710190



Taiwan Accreditation Foundation accreditation number: 1330

Test Firm MRA designation number: TW0010

Note: This report shall not be reproduced except in full, without the written approval of A Test Lab Techno Corp. This document may be altered or revised by A Test Lab Techno Corp. personnel only, and shall be noted in the revision section of the document. The client should not use it to claim product endorsement by TAF, or any government agencies. The test results in the report only apply to the tested sample.



Revision History

Rev.	Issue Date	Revisions	Revised By
00	Apr. 29, 2019	Initial Issue	Tobey Cheng
01	May 08, 2019	Page 27 Revised Maximum Conducted Output Power Measurement.	Tobey Cheng

Verification of Compliance

Issued Date: May 08, 2019

Applicant : ASUSTeK COMPUTER INC.
Applicant Address : 4F, No. 150, Li-Te Rd., Peitou, Taipei, Taiwan
Product Type : Intel Wireless-AC 9560
Trade Name : Intel
Model Number : 9560NGW
FCC ID : MSQ9560NG
EUT Rated Voltage : DC 3.3 V
Test Voltage : DC 3.3 V
Applicable Standard : FCC 47 CFR PART 15 SUBPART C
ANSI C63.10:2013
Test Result : Complied
Performing Lab. : A Test Lab Techno Corp.

No. 140-1, Changan Street, Bade District,
Taoyuan City 33465, Taiwan (R.O.C.)
Tel : +886-3-2710188 / Fax : +886-3-2710190



Taiwan Accreditation Foundation accreditation number: 1330
<http://www.atl-lab.com.tw/e-index.htm>

A Test Lab Techno Corp. tested the above equipment in accordance with the requirements set forth in the above standards. All indications of Pass/Fail in this report are opinions expressed by A Test Lab Techno Corp. based on interpretations and/or observations of test results. The test results show that the equipment tested is capable of demonstrating compliance with the requirements as documented in this report.

Approved By : Fly Lu Reviewed By : Eric Ou Yang
(Manager) (Fly Lu) (Testing Engineer) (Eric Ou Yang)



TABLE OF CONTENTS

1	General Information	5
1.1.	Summary of Test Result.....	5
1.2.	Measurement Uncertainty.....	6
2	Description of Equipment Under Test	7
3	Test Methodology	8
3.1.	Mode of Operation.....	8
3.2.	EUT Test Step.....	16
3.3.	Configuration of Test System Details	16
3.4.	Test Instruments	17
3.5.	Test Site Environment.....	17
4	Measurement Procedure	18
4.1.	AC Power Line Conducted Emission Measurement.....	18
4.2.	Radiated Emission Measurement	19
4.3.	Maximum Conducted Output Power Measurement.....	22
4.4.	6 dB RF Bandwidth Measurement	23
4.5.	Maximum Power Spectral Density Measurement.....	24
4.6.	Out of Band Conducted Emissions Measurement	25
4.7.	Antenna Measurement	26
5	Test Results.....	27
	Annex A. Conducted Emission	27
	Annex B. Conducted Test Results	27
	Annex C. Radiated Emission Test Results.....	30



1 General Information

1.1. Summary of Test Result

Standard	Item	Result	Remark
FCC			
15.207	AC Power Conducted Emission	N/A	C2PC No need for verification.
15.247(d)	Transmitter Radiated Emissions	PASS	-----
15.247(b)(3)	Max. Output Power	PASS	-----
15.247(a)(2)	6 dB RF Bandwidth	N/A	C2PC No need for verification.
15.247(e)	Maximum Power Spectral Density	N/A	C2PC No need for verification.
15.247(d)	Out of Band Conducted Spurious Emission	N/A	C2PC No need for verification.
15.203	Antenna Requirement	PASS	-----

The test results of this report relate only to the tested sample(s) identified in this report.

Standard	Description
CFR47, Part 15, Subpart C	Intentional Radiators
ANSI C63. 10: 2013	American National Standard of Procedures for Compliance Testing of Unlicensed Wireless Devices
KDB 558074 D01 15.247 Meas Guidance v05r02	GUIDANCE FOR COMPLIANCE MEASUREMENTS ON DIGITAL TRANSMISSION SYSTEM, FREQUENCY HOPPING SPREAD SPECTRUM SYSTEM, AND HYBRID SYSTEM DEVICES OPERATING UNDER SECTION 15.247 OF THE FCC RULES



1.2. Measurement Uncertainty

Test Item	Frequency Range	Uncertainty (dB)
Conducted Emission	9 kHz ~ 150 kHz	2.7
	150 kHz ~ 30 MHz	2.7
Radiated Emission	9 kHz ~ 30 MHz	1.7
	30 MHz ~ 1000 MHz	5.7
	1000 MHz ~ 18000 MHz	5.5
	18000 MHz ~ 26500 MHz	4.8
	26500 MHz ~ 40000 MHz	4.8
Conducted Output Power	+0.27 dB / -0.28 dB	
RF Bandwidth	4.96 %	
Power Spectral Density	+0.71 dB / -0.77 dB	

2 Description of Equipment Under Test

Applicant	ASUSTeK COMPUTER INC. 4F, No. 150, Li-Te Rd., Peitou, Taipei, Taiwan			
Manufacturer	ASUSTeK COMPUTER INC. 4F, No. 150, Li-Te Rd., Peitou, Taipei, Taiwan			
Product Type	Intel Wireless-AC 9560			
Trade Name	Intel			
Model Number	9560NGW			
FCC ID	MSQ9560NG			
Class II Permissive Change	<p>(1) This is to request a Class II permissive change for FCC ID: MSQ9560NG, originally granted on 11/20/2017</p> <p>The major change filed under this application is:</p> <p>Change #1: Additional Chassis added, ASUSTeK, model number: S432F, V432F, K432F.</p> <p>Models difference: All models are electrically identical, different model names are for marketing purpose.</p> <p>#2: Reduce the Output Power through firmware and SAR measurement were evaluated.</p> <p>(Only reduce Wi-Fi Output Power, Bluetooth Output Power haven't changes).</p> <p>#3: Addition one antenna, the antenna type is same, the antenna gain is lower than the original application.</p>			
Host Information	<p>Product Type: Notebook PC</p> <p>Trade Name: ASUS</p> <p>Model Name: S432F, V432F, K432F</p> <p>(All models are electrically identical, different model names are for marketing purpose.)</p>			
Operate Freq. Band	Frequency Range (MHz)	Modulation	Channel Bandwidth	Data Rate 400 / 800 GI (ns)
IEEE 802.11b	2412 ~ 2472	DSSS	20 MHz	Up to 11 Mbps
IEEE 802.11g	2412 ~ 2472	OFDM	20 MHz	Up to 54 Mbps
IEEE 802.11n 2.4 GHz 20 MHz	2412 ~ 2472	OFDM	20 MHz	Up to 72.2 Mbps
IEEE 802.11n 2.4 GHz 40 MHz	2422 ~ 2462	OFDM	40 MHz	Up to 150 Mbps
Antenna Delivery	See section 3.1			
Operate Temp. Range	0 ~ +80 °C			

Antenna list:

Antenna Source	ANT	Manufacturer	Part No. (Vendor)	ASUS Part No.	Type	Max. Gain (dBi)
1	Chain A	luxshare-ict	NA02-034011-012HS	04072-03360000	PIFA Antenna	-4.15
	Chain B	luxshare-ict	NA02-034011-012HS	04072-03360000	PIFA Antenna	-2.45
Note: The Chain A is connected to AUX port / Chain B is connected to MAIN port of module.						

3 Test Methodology

3.1. Mode of Operation

Decision of Test ATL has verified the construction and function in typical operation. All the test modes were carried out with the EUT in normal operation, which was shown in this test report and defined as:

Test Mode
Mode 1: Transmit mode
Mode 2: IEEE 802.11b Continuous TX mode
Mode 3: IEEE 802.11g Continuous TX mode
Mode 4: IEEE 802.11n 2.4 GHz 20 MHz Continuous TX mode
Mode 5: IEEE 802.11n 2.4 GHz 40 MHz Continuous TX mode

Software used to control the EUT for staying in continuous transmitting mode was programmed.

After verification, all tests were carried out with the worst case test modes.

The device used six models of adapter, and adapter number: W16-045N3A is worst case thus was used to perform testing.

SISO			
Test Mode	Chain A	Chain B	
Mode 2	V	V	
Mode 3	V	V	
Mode 4	V	V	
Mode 5	V	V	
Test Mode	Antenna Delivery	Data Rate (Mbps)	Test Channel
Mode 2	1TX(Diversity)	1	1, 6, 11
Mode 3	1TX(Diversity)	6	1, 6, 11
Mode 4	1TX(Diversity)	6.5	1, 6, 11
Mode 5	1TX(Diversity)	13.5	3, 6, 9

MIMO			
Test Mode	Chain A	Chain B	Chain A + Chain B
Mode 4	V	V	V
Mode 5	V	V	V
Test Mode	Antenna Delivery	Data Rate (Mbps)	Test Channel
Mode 4	2TX(MIMO)	6.5	1, 6, 11
Mode 5	2TX(MIMO)	13.5	3, 6, 9



Duty cycle

SISO						
Test Mode	Frequency (MHz)	on time (ms)	on+off time (ms)	Duty cycle	Duty Factor (dB)	1/T Minimum VBW (kHz)
Mode 2	2412.0	12.350	12.710	0.972	0.125	0.081
Mode 3	2412.0	2.070	2.420	0.855	0.678	0.483
Mode 4	2412.0	1.930	2.250	0.858	0.666	0.518
Mode 5	2422.0	0.950	1.110	0.856	0.676	1.053

MIMO						
Test Mode	Frequency (MHz)	on time (ms)	on+off time (ms)	Duty cycle	Duty Factor (dB)	1/T Minimum VBW (kHz)
Mode 4	2412.0	0.985	1.155	0.853	0.691	1.015
Mode 5	2422.0	0.500	0.585	0.855	0.682	2.000

SISO

Mode 2: IEEE 802.11b Continuous TX mode

On time



On+off time





Mode 3: IEEE 802.11g Continuous TX mode

On time

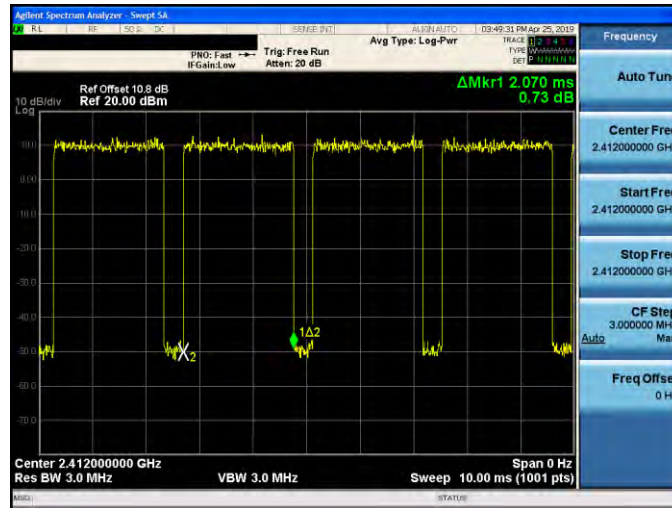

On+off time

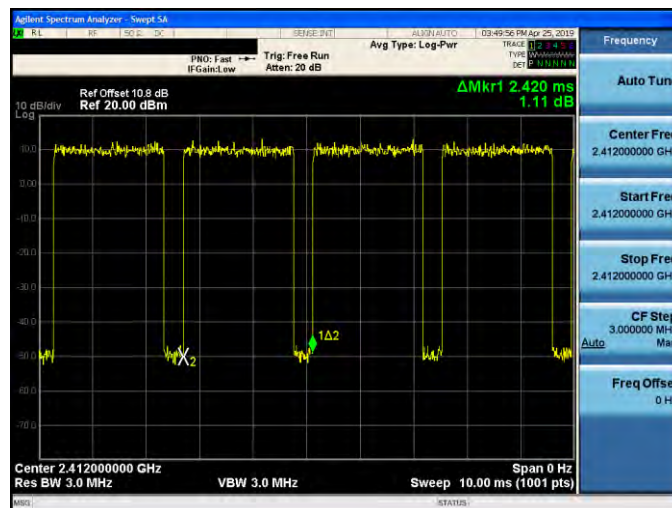

Mode 4: IEEE 802.11n 2.4 GHz 20 MHz Continuous TX mode

On time

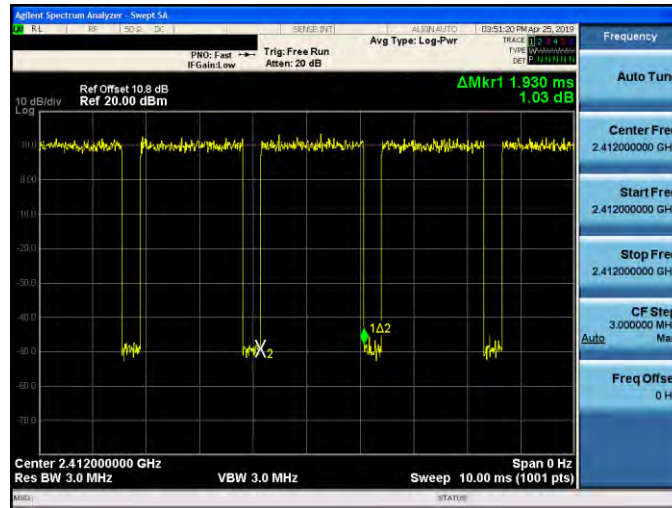

On+off time

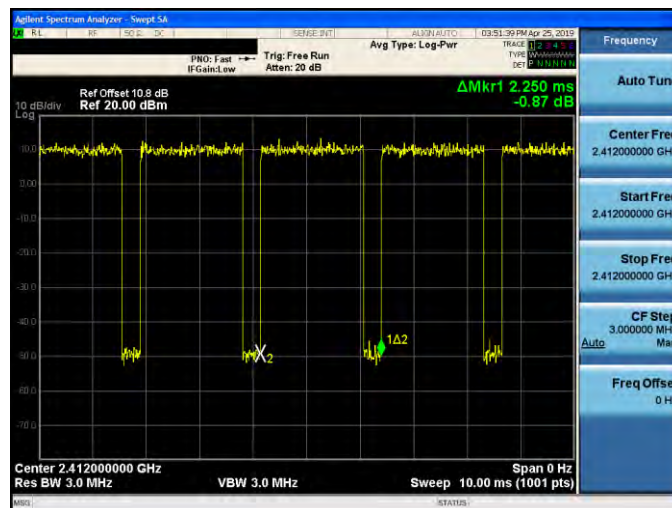

Mode 5: IEEE 802.11n 2.4 GHz 40 MHz Continuous TX mode

On time

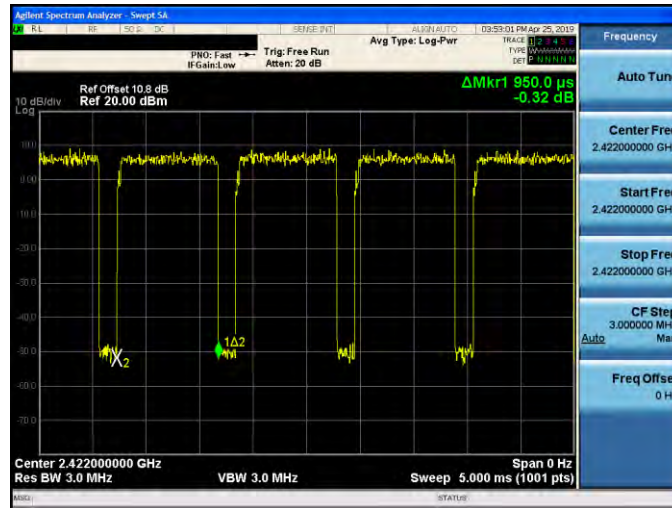

On+off time

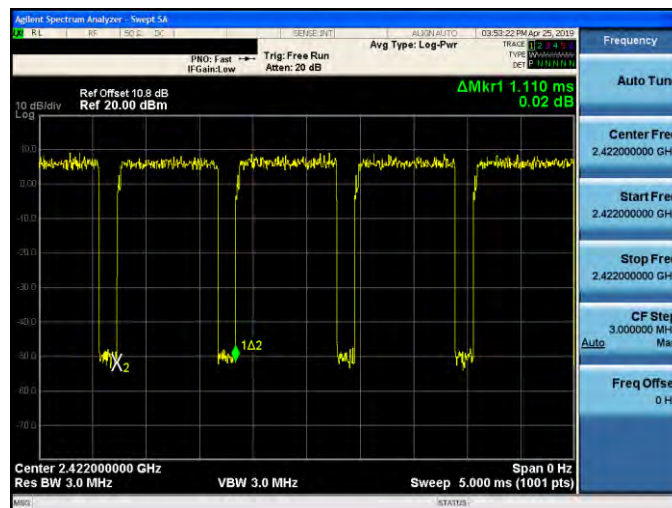

MIMO

Mode 4: IEEE 802.11n 2.4 GHz 20 MHz Continuous TX mode

On time

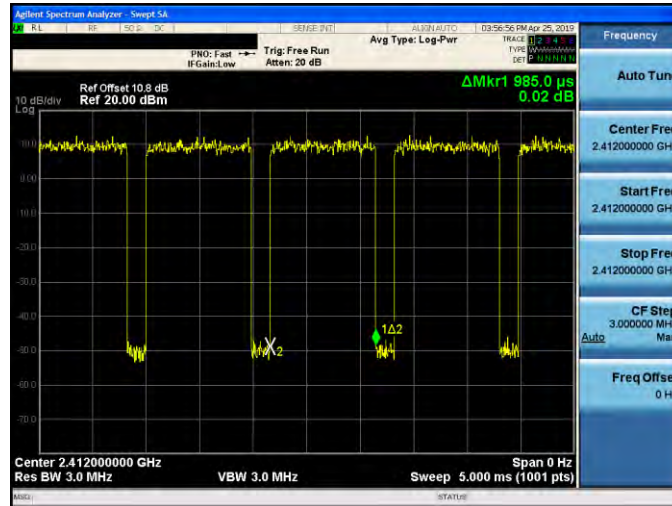

On+off time

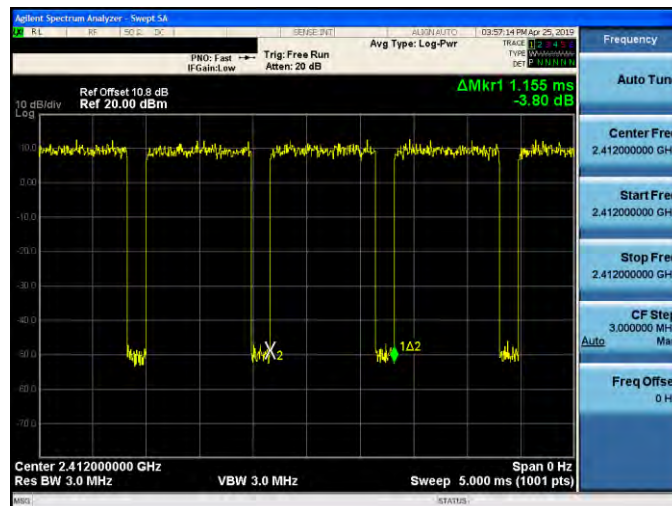

Mode 5: IEEE 802.11n 2.4 GHz 40 MHz Continuous TX mode

On time

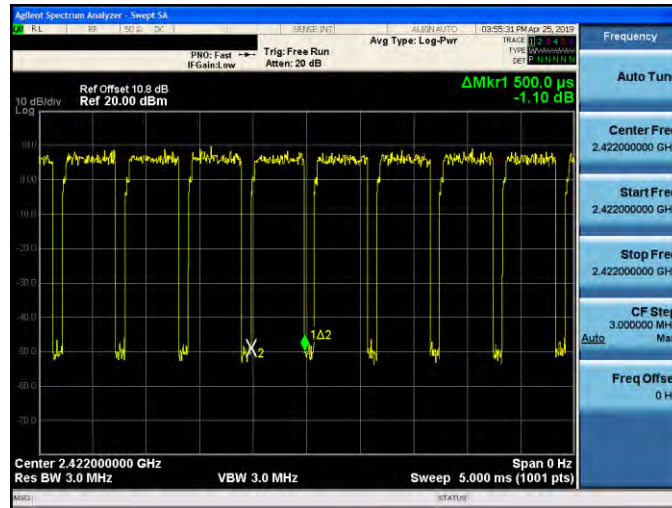

On+off time

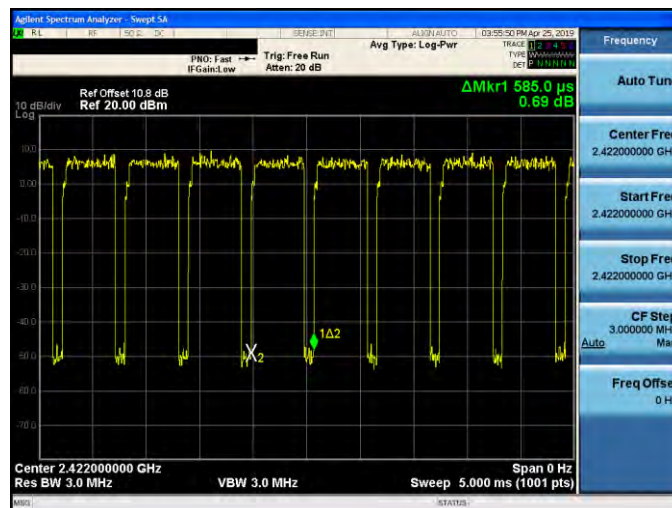

3.2. EUT Test Step

1.	Setup the EUT by "Configuration of Test System Details" shown below.
2.	Turn on the power of all equipment.
3.	Turn on TX function
4.	EUT run test program.

Measurement Software			
No.	Description	Software	Version
1	Radiated Emission	EZ EMC	1.1.4.4

3.3. Configuration of Test System Details

Radiated Emission

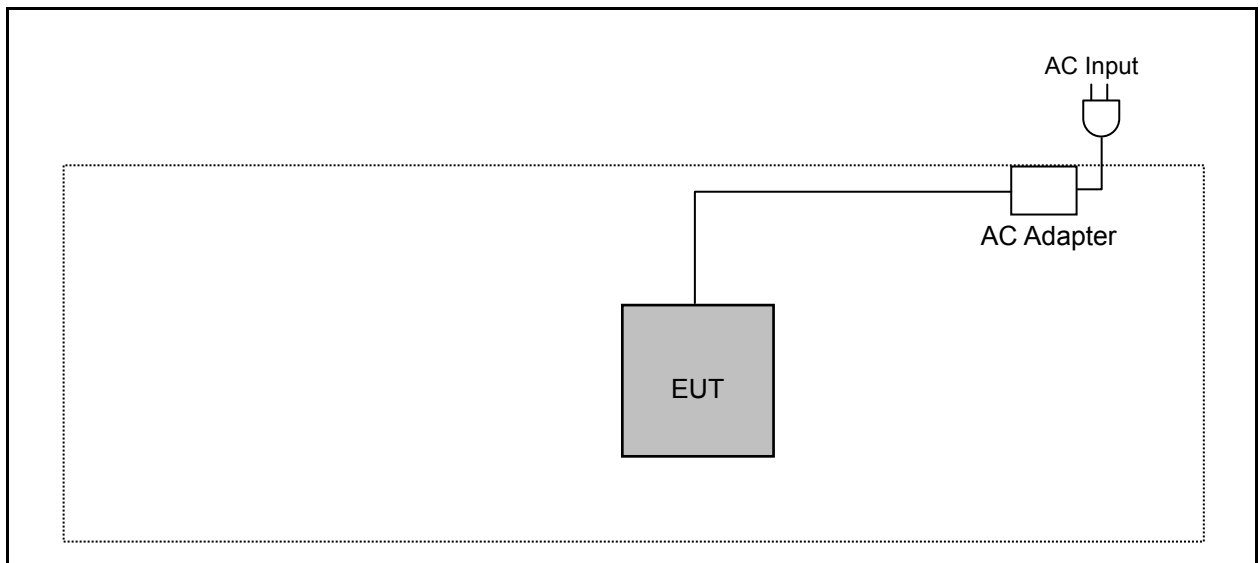



3.4. Test Instruments

For Radiated Emissions

Test Period: Apr. 15 ~ Apr. 20, 2019

Equipment	Manufacturer	Model Number	Serial Number	Cal. Date	Cal. Period
Spectrum Analyzer (10 Hz~44 GHz)	Keysight	N9010A	MY52221312	01/14/2019	1 year
Pre Amplifier (1~26.5 GHz)	Agilent	8449B	3008A02237	10/16/2018	1 year
Pre Amplifier (100 kHz~1.3 GHz)	Agilent	8447D	2944A11119	01/14/2019	1 year
Pre Amplifier (26.5~40 GHz)	EMCI	EMC2654045	980028	08/23/2018	1 year
Broadband Antenna	Schwarzbeck	VULB9168	416	10/19/2018	1 year
Horn Antenna (1~18 GHz)	SCHWARZBECK MESS-ELEKTRONIK	BBHA9120D	9120D-550	08/23/2018	1 year
Horn Antenna (18~40 GHz)	SCHWARZBECK MESS-ELEKTRONIK	BBHA9170	9170-320	08/07/2018	1 year
Loop Antenna	COM-POWER CORPORATION	AL-130	121014	03/29/2019	1 year
RF Cable	EMCI	EMC104-N-N-6000	TE01-1	02/20/2019	1 year
Microwave Cable	EMCI	EMC104-SM-SM-1 3000	170814	10/30/2018	1 year
Microwave Cable	EMCI	EMC102-KM-KM-1 4000	151001	02/20/2019	1 year

For Conducted

Test Period: Apr. 18 ~ Apr. 19, 2019

Equipment	Manufacturer	Model Number	Serial Number	Cal. Date	Cal. Period
Power Sensor	Anritsu	MA2411B	1126022	08/29/2018	1 year
Power Meter	Anritsu	ML2495A	1135009	08/29/2018	1 year

Note: N.C.R. = No Calibration Request.

3.5. Test Site Environment

Items	Required (IEC 60068-1)	Actual
Temperature (°C)	15-35	26
Humidity (%RH)	25-75	60
Barometric pressure (mbar)	860-1060	990

4 Measurement Procedure

4.1. AC Power Line Conducted Emission Measurement

■ Limit

Frequency (MHz)	Quasi-peak	Average
0.15 - 0.5	66 to 56	56 to 46
0.50 - 5.0	56	46
5.0 - 30.0	60	50

■ Test Setup

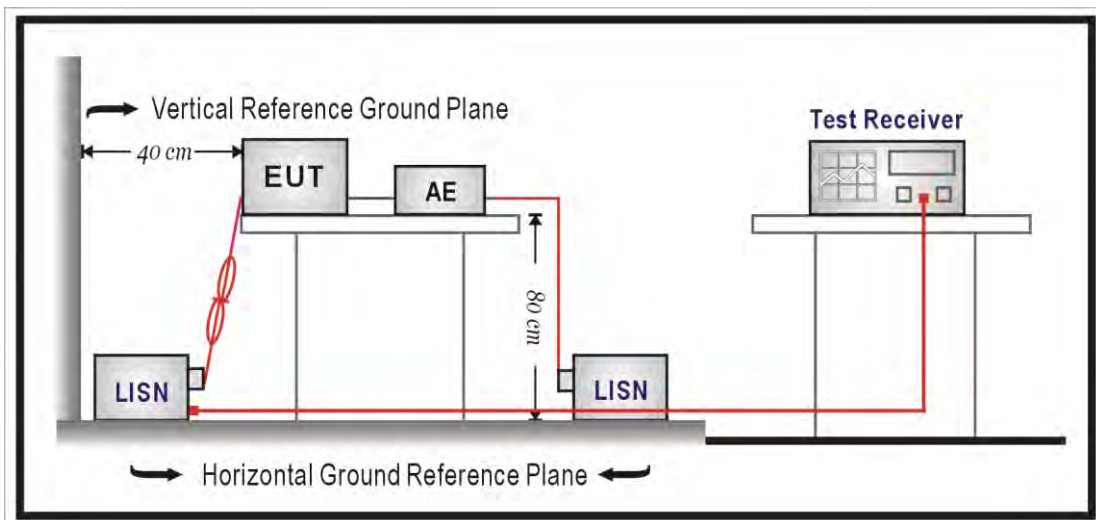

■ Test Procedure

Please refer to ANSI C63.10-2013 clause 6.2 for the test method.



4.2. Radiated Emission Measurement

■ Limit

According to §15.209(a), except as provided elsewhere in this subpart, the emissions from an intentional radiator shall not exceed the field strength levels specified in the following table:

Frequency (MHz)	Field Strength ($\mu\text{V}/\text{m}$ at meter)	Measurement Distance (meters)
0.009 – 0.490	2400 / F (kHz)	300
0.490 – 1.705	24000 / F (kHz)	30
1.705 – 30.0	30	30
30 - 88	100**	3
88-216	150**	3
216-960	200**	3
Above 960	500	3

** Except as provided in paragraph (g), fundamental emissions from intentional radiators operating under this Section shall not be located in the frequency bands 54-72 MHz, 76-88 MHz, 174-216 MHz or 470-806 MHz. However, operation within these frequency bands is permitted under other sections of this Part, e.g., Sections 15.231 and 15.241.

■ Setup

9 kHz ~ 30 MHz

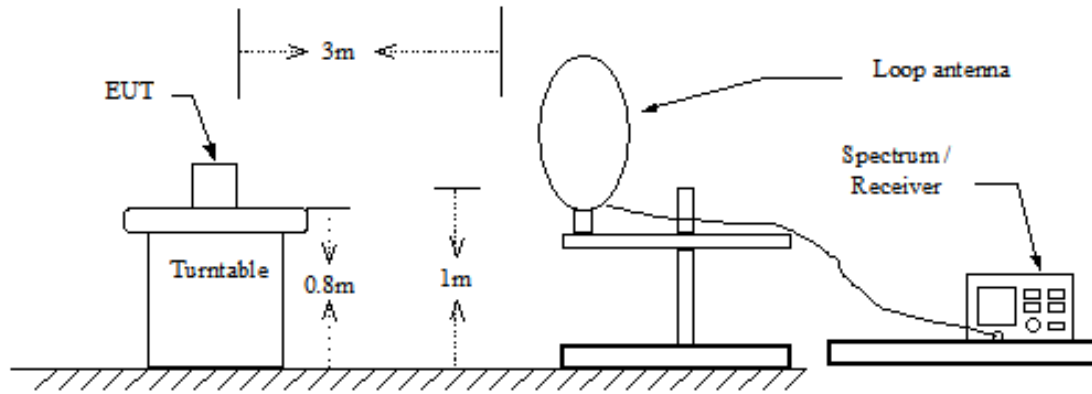

Below 1 GHz

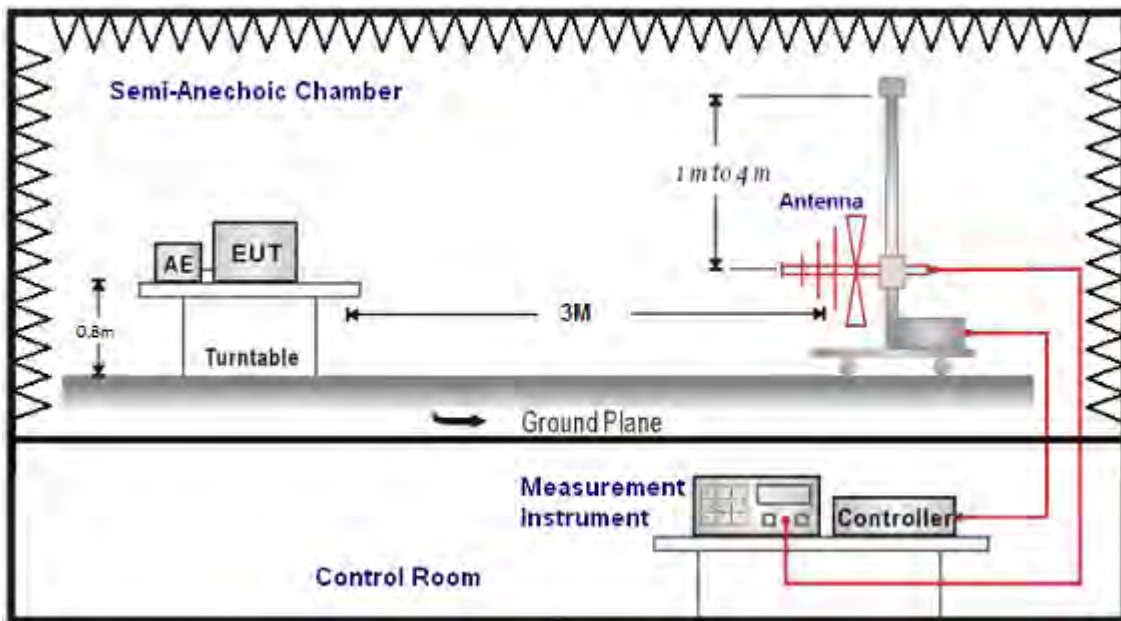

Above 1 GHz

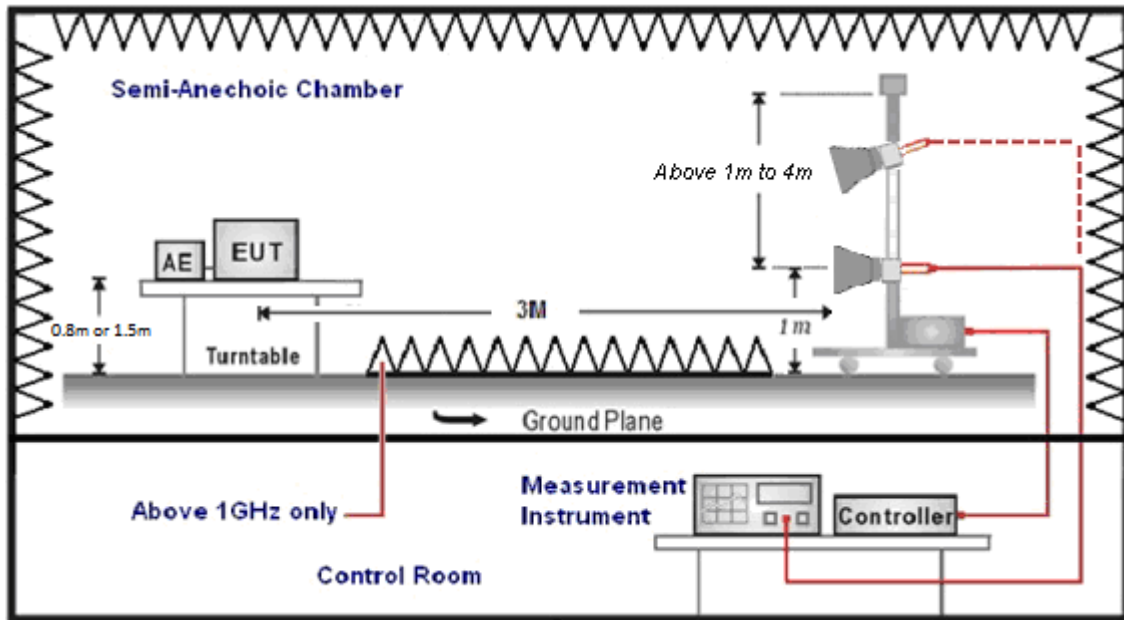

■ **Test Procedure**

Please refer to ANSI C63.10-2013 clause 6.5 / 6.6 / 6.10.5 for the test method.

Please refer to ANSI C63.10-2013 clause 11.12.1 / 11.12.2.7 for the test method.

4.3. Maximum Conducted Output Power Measurement

■ Limit

For systems using digital modulation in the 2400-2483.5 MHz, the limit for maximum output power is 30 dBm.

And According to 15.247 (b), if transmitting antennas of directional gain greater than 6 dBi are used, the power shall be reduced by the amount in dB that the directional gain of the antenna exceeds 6 dBi.

SISO

IEEE 802.11b / IEEE 802.11g / IEEE 802.11n 2.4 GHz 20 MHz / 40 MHz

Diversity mode :

* Directional Gain = Max. Gain = -2.45 < 6 dBi

MIMO

IEEE 802.11n 2.4 GHz 20 MHz / 40 MHz

MIMO mode :

* Directional Gain = $10 \cdot \log\{[10^{(G1/20)} + 10^{(G2/20)} + \dots + 10^{(Gn/20)}]^2 / NANT\}$ = -0.25 dBi < 6 dBi

■ Test Setup

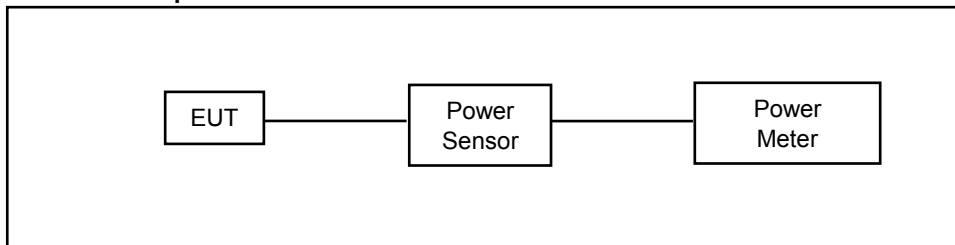

■ Test Procedure

Please refer to ANSI C63.10-2013 clause 11.9.2.3 for the test method.

4.4. 6 dB RF Bandwidth Measurement

■ **Limit**

6 dB RF Bandwidth: Systems using digital modulation techniques may operate in the 2400–2483.5 MHz bands. The minimum 6 dB band-width shall be at least 500 kHz.

■ **Test Setup**

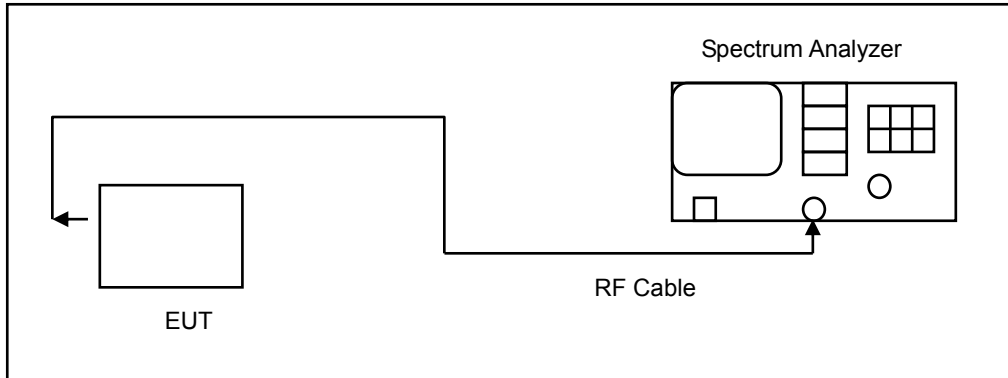

■ **Test Procedure**

Please refer to ANSI C63.10-2013 clause 11.8.2 for the test method.

4.5. Maximum Power Spectral Density Measurement

■ Limit

For digitally modulated systems, the power spectral density conducted from the intentional radiator to the antenna shall not be greater than 8 dBm in any 3 kHz band during any time interval of continuous transmission.

■ Test Setup

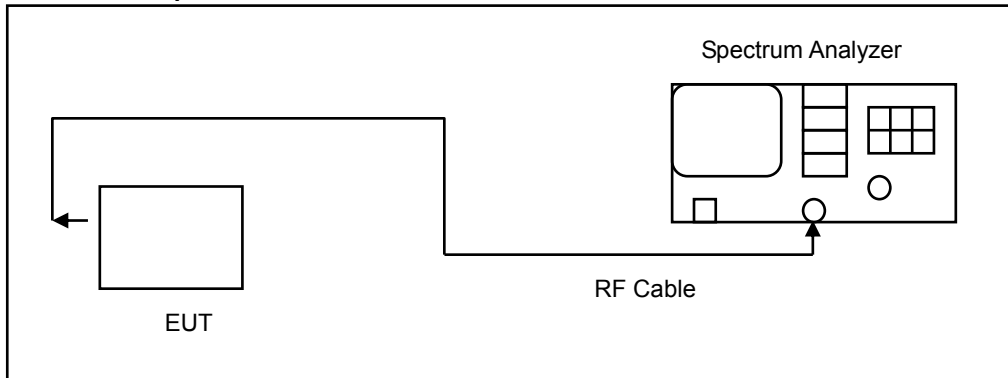

■ Test Procedure

Please refer to ANSI C63.10-2013 clause 11.10.2 for the test method.

4.6. Out of Band Conducted Emissions Measurement

■ Limit

In any 100 kHz bandwidth outside the frequency band in which the spread spectrum or digitally modulated intentional radiator is operating, the radio frequency power that is produced by the intentional radiator shall be at least 30 dB below that in the 100 kHz bandwidth within the band that contains the highest level of the desired power

■ Test Setup

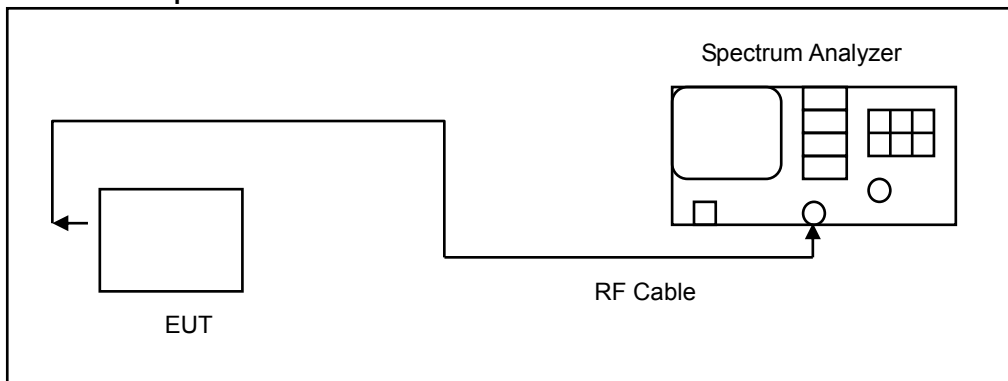

■ Test Procedure

Please refer to ANSI C63.10-2013 clause 11.11.1 for the test method.



4.7. Antenna Measurement

■ Limit

For intentional device, according to 15.203, an intentional radiator shall be designed to ensure that no antenna other than that furnished by the responsible party shall be used with the device.

And According to 15.247 (b), if transmitting antennas of directional gain greater than 6 dBi are used, the power shall be reduced by the amount in dB that the directional gain of the antenna exceeds 6 dBi.

■ Antenna Description

See section 2 – antenna information.

■ Directional Gain Calculated

Operate Freq. Band	Directional Gain (dBi)		
	SISO A	SISO B	MIMO A+B
IEEE 802.11b	-4.15	-2.45	---
IEEE 802.11g	-4.15	-2.45	---
IEEE 802.11n 2.4 GHz 20 MHz	-4.15	-2.45	-0.25
IEEE 802.11n 2.4 GHz 40 MHz	-4.15	-2.45	-0.25

5 Test Results

Annex A. Conducted Emission

C2PC, no need for verification.

Annex B. Conducted Test Results

Maximum Conducted Output Power Measurement

Test Mode	Data Rate (Mbps)	Frequency (MHz)	Average Output Power				
			Measurement Results				Limit
			SISO A		SISO B		dBm
			(dBm)	(W)	(dBm)	(W)	
Mode 2	1	2412.0	12.41	0.017	12.45	0.018	≤ 30
		2437.0	12.61	0.018	12.65	0.018	≤ 30
		2462.0	12.64	0.018	12.73	0.019	≤ 30
		2467.0	12.41	0.017	12.68	0.019	≤ 30
		2472.0	12.61	0.018	12.71	0.019	≤ 30
Mode 3	6	2412.0	12.33	0.017	12.69	0.019	≤ 30
		2437.0	12.47	0.018	12.69	0.019	≤ 30
		2462.0	12.46	0.018	12.61	0.018	≤ 30
		2467.0	12.68	0.019	12.39	0.017	≤ 30
		2472.0	-6.70	0.0002	-7.54	0.0002	≤ 30
Mode 4	6.5	2412.0	12.37	0.017	12.65	0.018	≤ 30
		2437.0	12.47	0.018	12.62	0.018	≤ 30
		2462.0	12.49	0.018	12.61	0.018	≤ 30
		2467.0	12.63	0.018	12.38	0.017	≤ 30
		2472.0	-6.70	0.0002	-7.61	0.0002	≤ 30
Mode 5	13.5	2422.0	11.97	0.016	12.28	0.017	≤ 30
		2437.0	12.47	0.018	12.71	0.019	≤ 30
		2452.0	12.02	0.016	12.31	0.017	≤ 30
		2457.0	10.32	0.011	9.41	0.009	≤ 30
		2462.0	2.34	0.002	2.61	0.002	≤ 30

Note: The relevant measured result has the offset with cable loss already.



Test Mode	Data Rate (Mbps)	Frequency (MHz)	Average Output Power						
			Measurement Results						Limit
			MIMO A		MIMO B		MIMO A+B		dBm
			(dBm)	(W)	(dBm)	(W)	(dBm)	(W)	
Mode 4	13	2412.0	12.48	0.018	12.62	0.018	15.56	0.036	≤ 30
		2437.0	12.57	0.018	12.52	0.018	15.56	0.036	≤ 30
		2462.0	12.70	0.019	12.49	0.018	15.61	0.036	≤ 30
		2467.0	10.11	0.010	10.17	0.010	13.15	0.021	≤ 30
		2472.0	-8.58	0.000	-8.70	0.000	-5.63	0.000	≤ 30
Mode 5	27	2422.0	12.27	0.017	12.19	0.017	15.24	0.033	≤ 30
		2437.0	12.71	0.019	12.62	0.018	15.68	0.037	≤ 30
		2452.0	12.41	0.017	12.22	0.017	15.33	0.034	≤ 30
		2457.0	9.48	0.009	9.71	0.009	12.61	0.018	≤ 30
		2462.0	1.67	0.001	1.38	0.001	4.54	0.003	≤ 30

Note: The relevant measured result has the offset with cable loss already.



6 dB RF Bandwidth Measurement

C2PC, no need for verification.

Maximum Power Spectral Density Measurement

C2PC, no need for verification.

Out of Band Conducted Emissions Measurement

C2PC, no need for verification.

Out of Band Conducted Emissions

C2PC, no need for verification.

Conducted Band Edge

C2PC, no need for verification.

Annex C. Radiated Emission Test Results

Below 1 GHz

Standard:		FCC Part 15.247		Test Distance:		3 m	
Test item:		Radiated Emission		Power:		DC 3.3 V	
Test Mode:		Mode 1		Temp.(°C)/Hum.(%RH):		26(°C)/60 %RH	
Frequency (MHz)	Reading (dBuV)	Correct Factor (dB/m)	Result (dBuV/m)	Limit (dBuV/m)	Margin (dB)	Remark	Ant.Polar. H / V
93.0500	35.82	-11.84	23.98	43.50	-19.52	QP	H
182.2900	32.76	-6.87	25.89	43.50	-17.61	QP	H
237.5800	36.96	-6.26	30.70	46.00	-15.30	QP	H
250.1900	42.67	-5.73	36.94	46.00	-9.06	QP	H
301.6000	35.62	-3.71	31.91	46.00	-14.09	QP	H
518.8800	31.91	0.52	32.43	46.00	-13.57	QP	H
44.5500	37.08	-6.53	30.55	40.00	-9.45	QP	V
93.0500	43.09	-11.84	31.25	43.50	-12.25	QP	V
112.4500	37.48	-8.90	28.58	43.50	-14.92	QP	V
422.8500	37.76	-1.10	36.66	46.00	-9.34	QP	V
543.1300	35.63	0.97	36.60	46.00	-9.40	QP	V
935.0100	31.83	8.42	40.25	46.00	-5.75	QP	V

Note:1.Result (dBuV/m) = Correct Factor (dB/m) + Reading(dBuV).

Example: 23.98 = -11.84 + 35.82

2.Correction factor (dB/m) = Antenna Factor (dB/m) + Cable loss (dB) – Pre-Amplifier gain (dB).

3.When the peak results are less than average limit, there is no need to evaluate the average.

Above 1 GHz

SISO A

Standard:	FCC Part 15.247	Test Distance:	3 m
Test item:	Harmonic	Power:	DC 3.3 V
Frequency:	2412 MHz	Temp.(°C)/Hum.(%RH):	26(°C)/60 %RH
Mode:	Mode 2		
Ant.Polar.:	Horizontal		

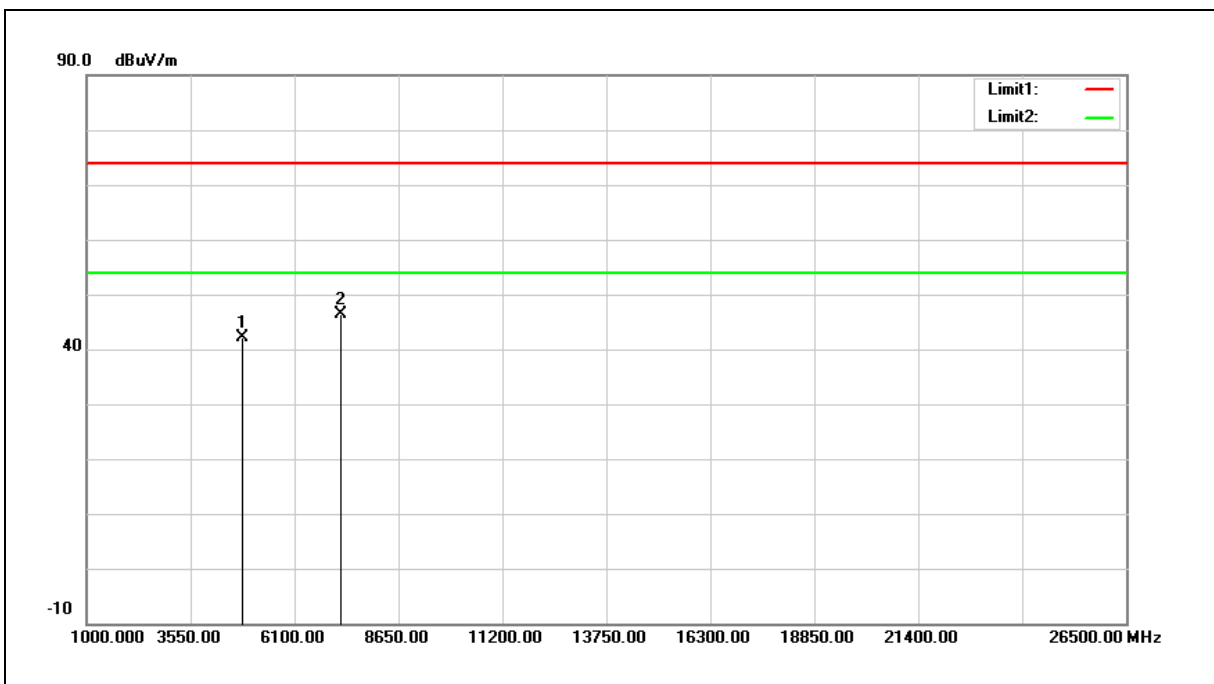

No.	Frequency (MHz)	Reading (dBuV)	Correct Factor (dB/m)	Result (dBuV/m)	Limit (dBuV/m)	Margin (dB)	Remark
1	4824.000	36.84	5.37	42.21	74.00	-31.79	peak
2	7236.000	34.54	11.90	46.44	74.00	-27.56	peak

Note: 1. Result (dBuV/m) = Correct Factor (dB/m) + Reading(dBuV).

Example: $42.21 = 5.37 + 36.84$

2. Correction factor (dB/m) = Antenna Factor (dB/m) + Cable loss (dB) – Pre-Amplifier gain (dB).

3. When the peak results are less than average limit, so not need to evaluate the average.

Standard:	FCC Part 15.247	Test Distance:	3 m
Test item:	Harmonic	Power:	DC 3.3 V
Frequency:	2412 MHz	Temp.(°C)/Hum.(%RH):	26(°C)/60 %RH
Mode:	Mode 2		
Ant.Polar.:	Vertical		

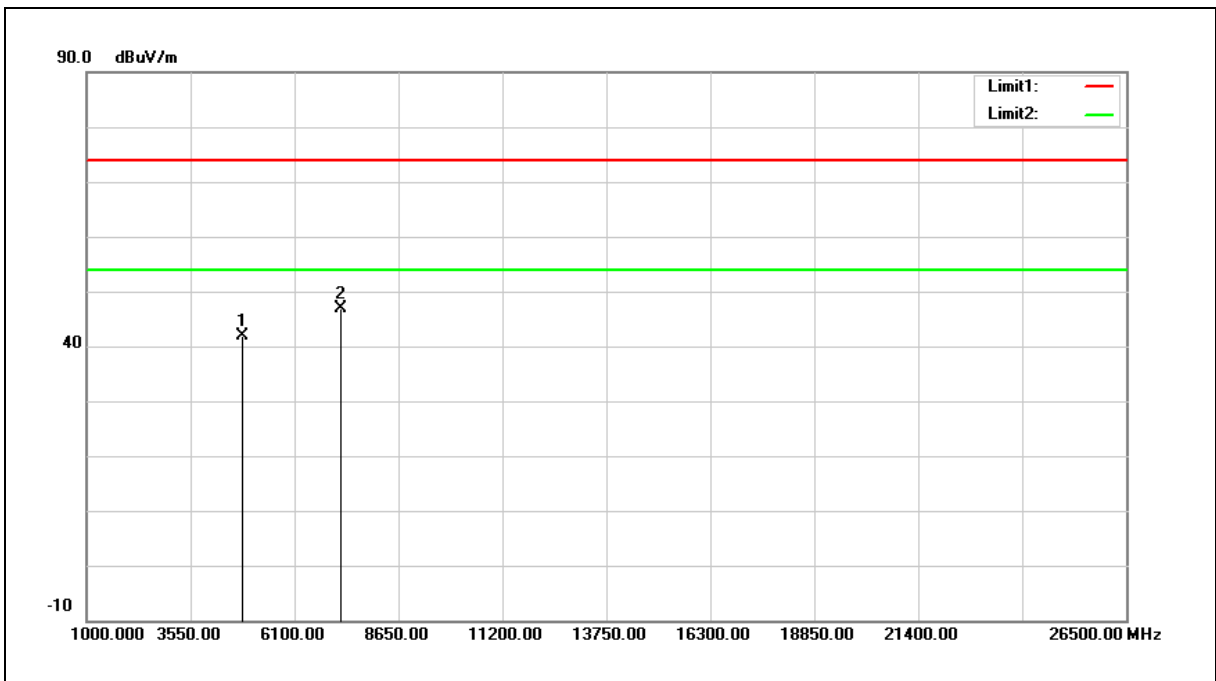

No.	Frequency (MHz)	Reading (dBuV)	Correct Factor (dB/m)	Result (dBuV/m)	Limit (dBuV/m)	Margin (dB)	Remark
1	4824.000	36.58	5.37	41.95	74.00	-32.05	peak
2	7236.000	34.98	11.90	46.88	74.00	-27.12	peak

Note:1.Result (dBuV/m) = Correct Factor (dB/m) + Reading(dBuV).

Example: 41.95 = 5.37 + 36.58

2.Correction factor (dB/m) = Antenna Factor (dB/m) + Cable loss (dB) – Pre-Amplifier gain (dB).

3. When the peak results are less than average limit, so not need to evaluate the average.



Standard:	FCC Part 15.247	Test Distance:	3 m
Test item:	Harmonic	Power:	DC 3.3 V
Frequency:	2437 MHz	Temp.(°C)/Hum.(%RH):	26(°C)/60 %RH
Mode:	Mode 2		
Ant.Polar.:	Horizontal		

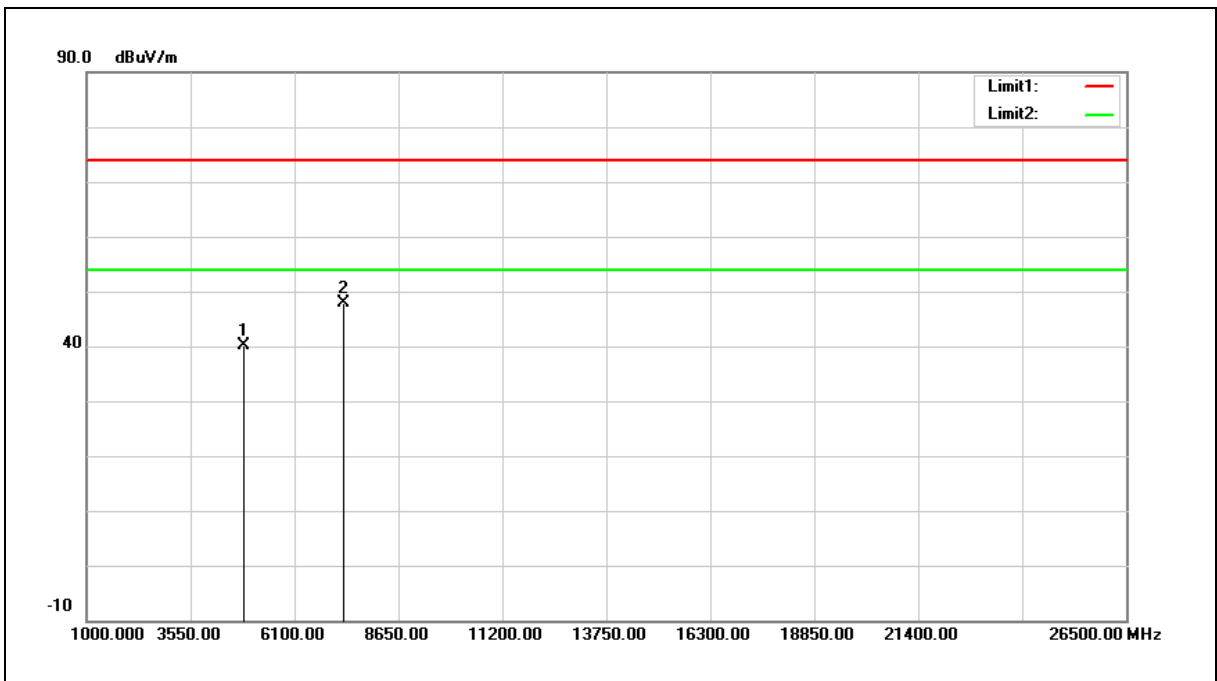

No.	Frequency (MHz)	Reading (dBuV)	Correct Factor (dB/m)	Result (dBuV/m)	Limit (dBuV/m)	Margin (dB)	Remark
1	4874.000	34.68	5.47	40.15	74.00	-33.85	peak
2	7311.000	35.69	12.13	47.82	74.00	-26.18	peak

Note:1.Result (dBuV/m) = Correct Factor (dB/m) + Reading(dBuV).

2.Correction factor (dB/m) = Antenna Factor (dB/m) + Cable loss (dB) – Pre-Amplifier gain (dB).

3. When the peak results are less than average limit, so not need to evaluate the average.



Standard:	FCC Part 15.247	Test Distance:	3 m
Test item:	Harmonic	Power:	DC 3.3 V
Frequency:	2437 MHz	Temp.(°C)/Hum.(%RH):	26(°C)/60 %RH
Mode:	Mode 2		
Ant.Polar.:	Vertical		

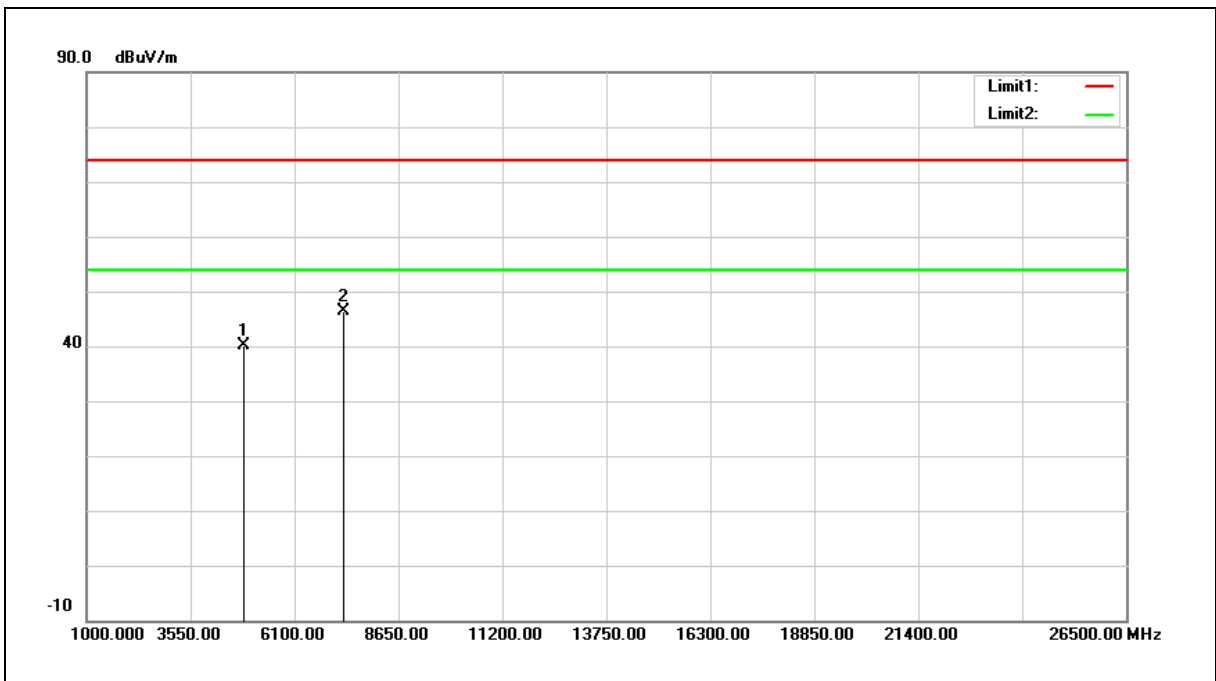

No.	Frequency (MHz)	Reading (dBuV)	Correct Factor (dB/m)	Result (dBuV/m)	Limit (dBuV/m)	Margin (dB)	Remark
1	4874.000	34.55	5.47	40.02	74.00	-33.98	peak
2	7311.000	34.15	12.13	46.28	74.00	-27.72	peak

Note:1.Result (dBuV/m) = Correct Factor (dB/m) + Reading(dBuV).

2.Correction factor (dB/m) = Antenna Factor (dB/m) + Cable loss (dB) – Pre-Amplifier gain (dB).

3. When the peak results are less than average limit, so not need to evaluate the average.



Standard:	FCC Part 15.247	Test Distance:	3 m
Test item:	Harmonic	Power:	DC 3.3 V
Frequency:	2462 MHz	Temp.(°C)/Hum.(%RH):	26(°C)/60 %RH
Mode:	Mode 2		
Ant.Polar.:	Horizontal		

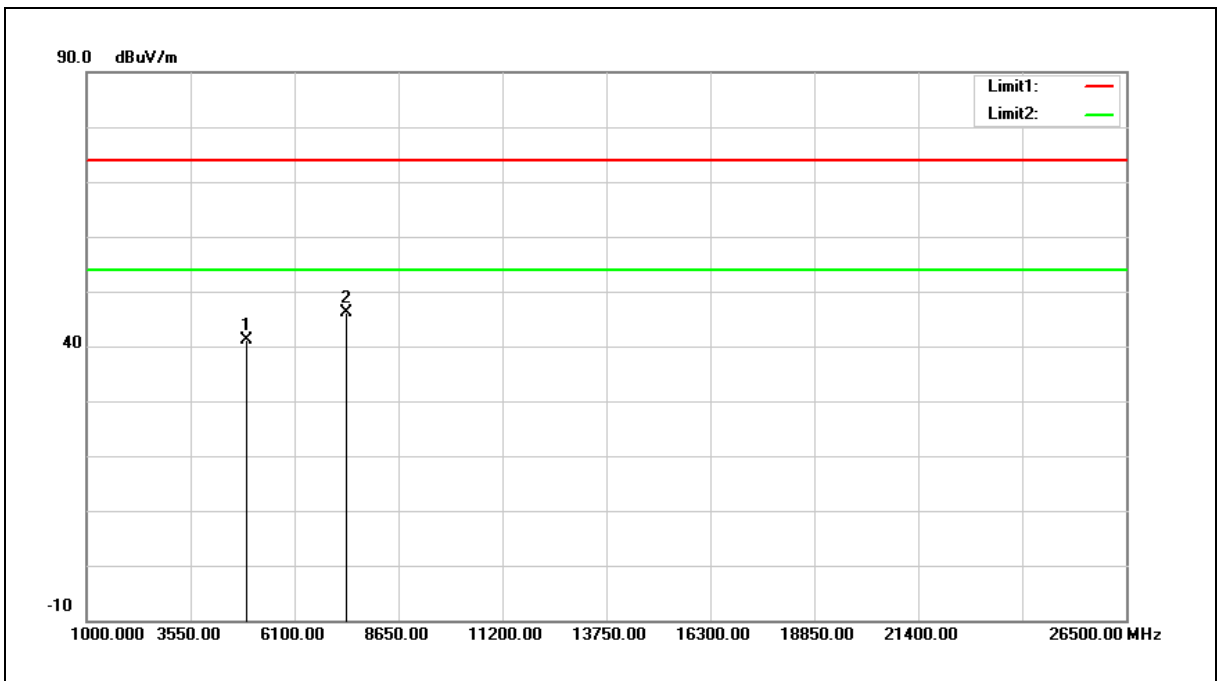

No.	Frequency (MHz)	Reading (dBuV)	Correct Factor (dB/m)	Result (dBuV/m)	Limit (dBuV/m)	Margin (dB)	Remark
1	4924.000	35.67	5.58	41.25	74.00	-32.75	peak
2	7386.000	33.72	12.36	46.08	74.00	-27.92	peak

- Note:1.Result (dBuV/m) = Correct Factor (dB/m) + Reading(dBuV).
 2.Correction factor (dB/m) = Antenna Factor (dB/m) + Cable loss (dB) – Pre-Amplifier gain (dB).
 3. When the peak results are less than average limit, so not need to evaluate the average.



Standard:	FCC Part 15.247	Test Distance:	3 m
Test item:	Harmonic	Power:	DC 3.3 V
Frequency:	2462 MHz	Temp.(°C)/Hum.(%RH):	26(°C)/60 %RH
Mode:	Mode 2		
Ant.Polar.:	Vertical		

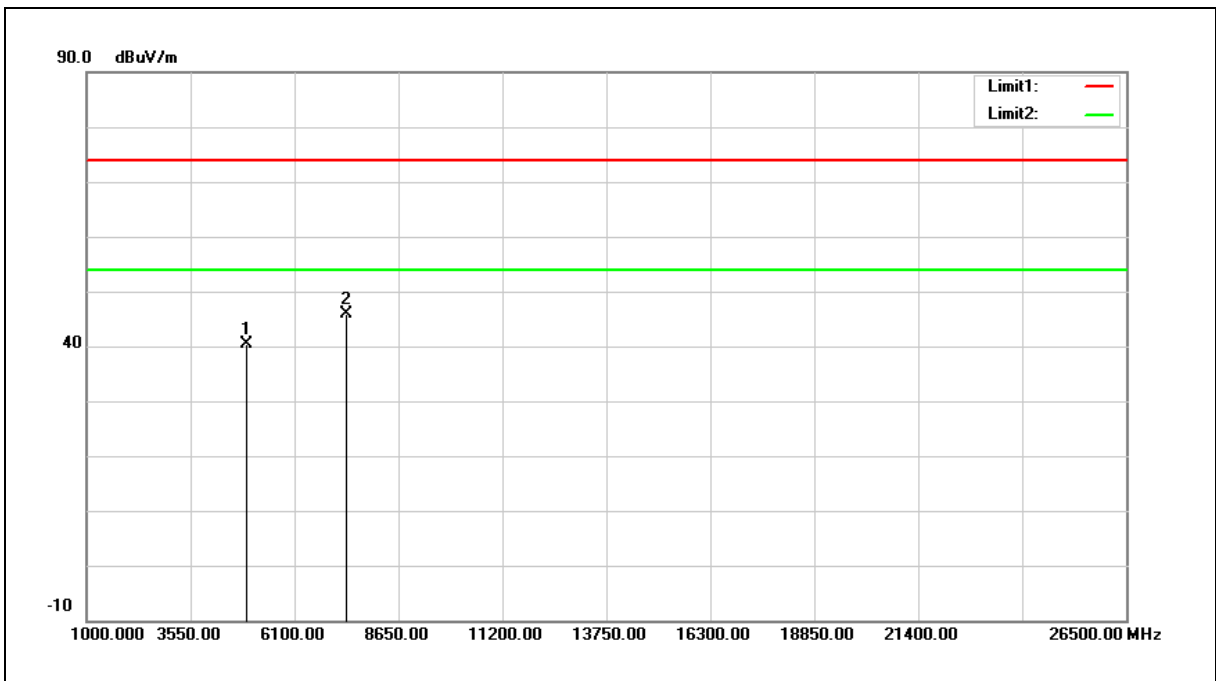

No.	Frequency (MHz)	Reading (dBuV)	Correct Factor (dB/m)	Result (dBuV/m)	Limit (dBuV/m)	Margin (dB)	Remark
1	4924.000	34.92	5.58	40.50	74.00	-33.50	peak
2	7386.000	33.40	12.36	45.76	74.00	-28.24	peak

Note:1.Result (dBuV/m) = Correct Factor (dB/m) + Reading(dBuV).

2.Correction factor (dB/m) = Antenna Factor (dB/m) + Cable loss (dB) – Pre-Amplifier gain (dB).

3. When the peak results are less than average limit, so not need to evaluate the average.



Standard:	FCC Part 15.247	Test Distance:	3 m
Test item:	Harmonic	Power:	DC 3.3 V
Frequency:	2467 MHz	Temp.(°C)/Hum.(%RH):	26(°C)/60 %RH
Mode:	Mode 2		
Ant.Polar.:	Horizontal		

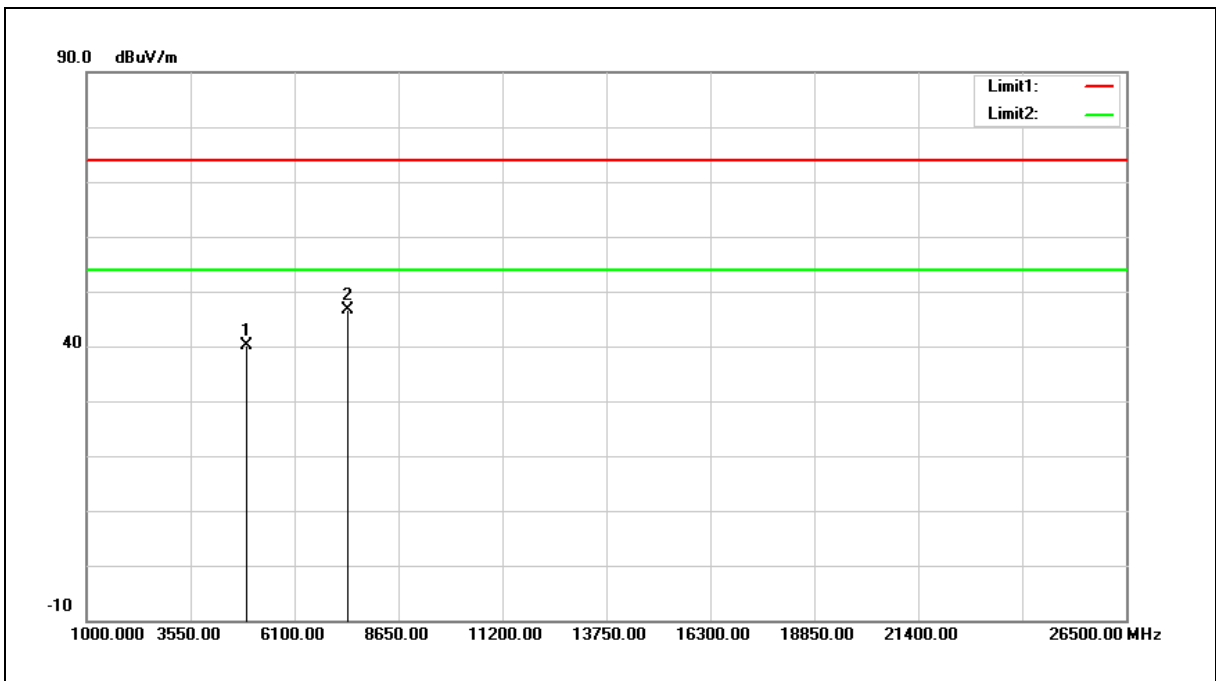

No.	Frequency (MHz)	Reading (dBuV)	Correct Factor (dB/m)	Result (dBuV/m)	Limit (dBuV/m)	Margin (dB)	Remark
1	4934.000	34.60	5.60	40.20	74.00	-33.80	peak
2	7401.000	34.32	12.40	46.72	74.00	-27.28	peak

- Note:1.Result (dBuV/m) = Correct Factor (dB/m) + Reading(dBuV).
 2.Correction factor (dB/m) = Antenna Factor (dB/m) + Cable loss (dB) – Pre-Amplifier gain (dB).
 3. When the peak results are less than average limit, so not need to evaluate the average.



Standard:	FCC Part 15.247	Test Distance:	3 m
Test item:	Harmonic	Power:	DC 3.3 V
Frequency:	2467 MHz	Temp.(°C)/Hum.(%RH):	26(°C)/60 %RH
Mode:	Mode 2		
Ant.Polar.:	Vertical		

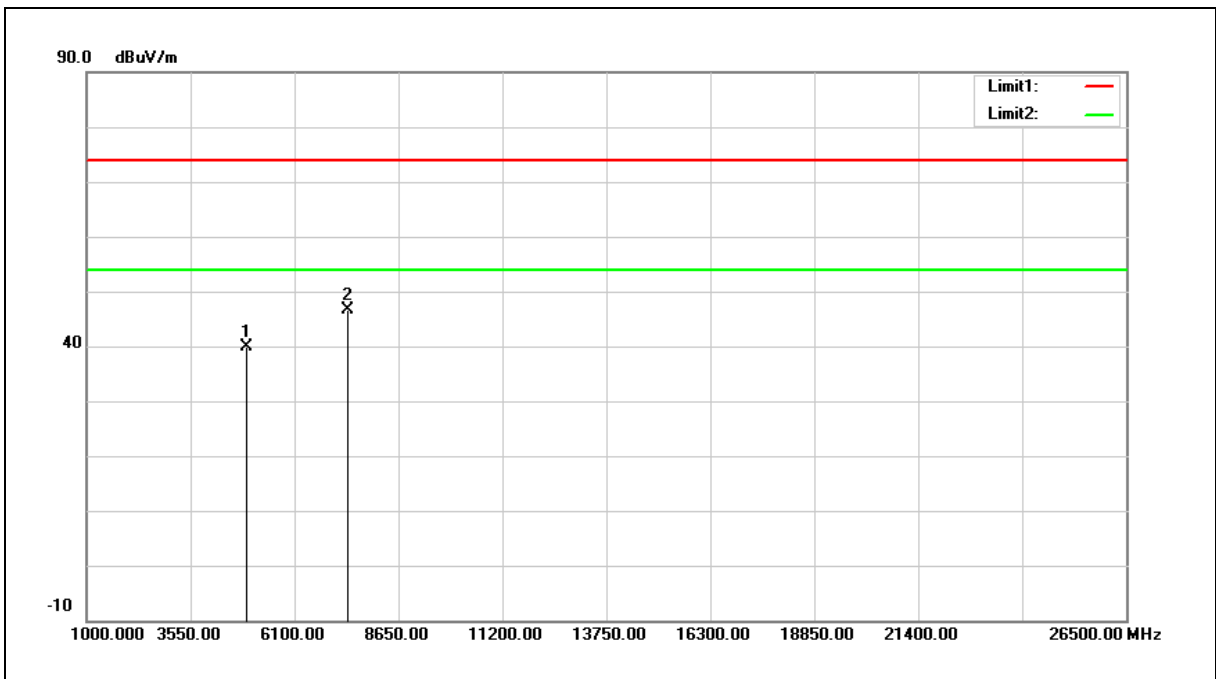

No.	Frequency (MHz)	Reading (dBuV)	Correct Factor (dB/m)	Result (dBuV/m)	Limit (dBuV/m)	Margin (dB)	Remark
1	4934.000	34.16	5.60	39.76	74.00	-34.24	peak
2	7401.000	34.16	12.40	46.56	74.00	-27.44	peak

- Note:1.Result (dBuV/m) = Correct Factor (dB/m) + Reading(dBuV).
 2.Correction factor (dB/m) = Antenna Factor (dB/m) + Cable loss (dB) – Pre-Amplifier gain (dB).
 3. When the peak results are less than average limit, so not need to evaluate the average.



Standard:	FCC Part 15.247	Test Distance:	3 m
Test item:	Harmonic	Power:	DC 3.3 V
Frequency:	2472 MHz	Temp.(°C)/Hum.(%RH):	26(°C)/60 %RH
Mode:	Mode 2		
Ant.Polar.:	Horizontal		

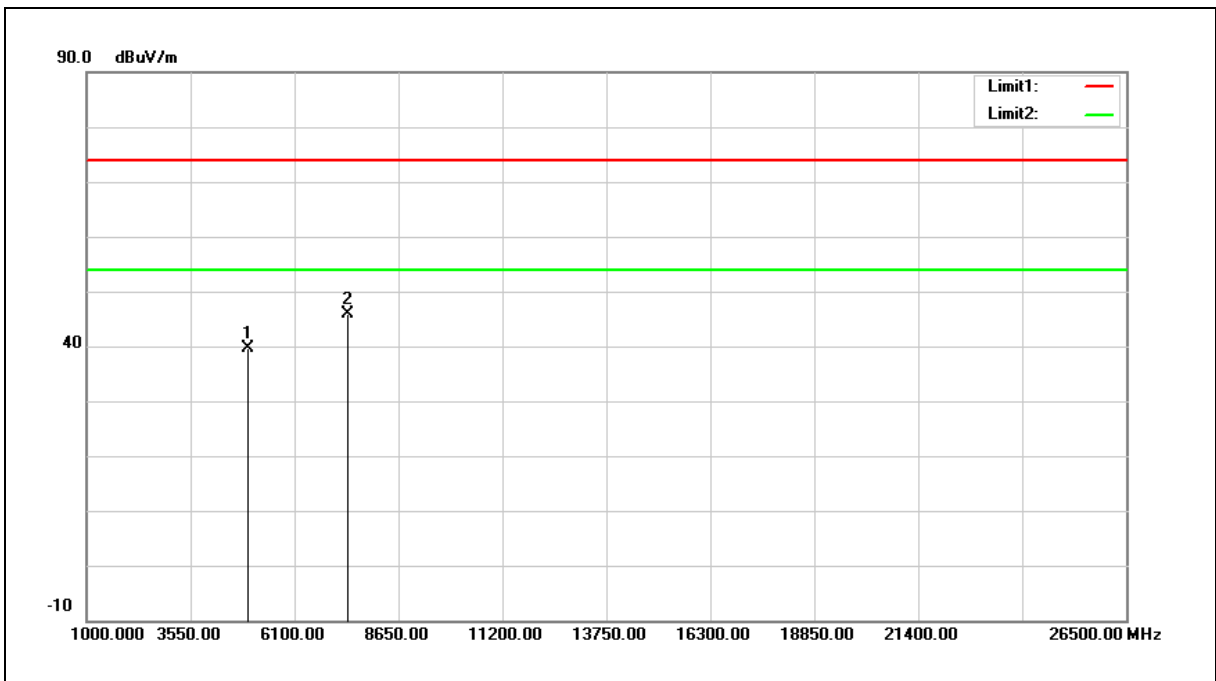

No.	Frequency (MHz)	Reading (dBuV)	Correct Factor (dB/m)	Result (dBuV/m)	Limit (dBuV/m)	Margin (dB)	Remark
1	4944.000	33.95	5.62	39.57	74.00	-34.43	peak
2	7416.000	33.54	12.45	45.99	74.00	-28.01	peak

- Note:1.Result (dBuV/m) = Correct Factor (dB/m) + Reading(dBuV).
 2.Correction factor (dB/m) = Antenna Factor (dB/m) + Cable loss (dB) – Pre-Amplifier gain (dB).
 3. When the peak results are less than average limit, so not need to evaluate the average.



Standard:	FCC Part 15.247	Test Distance:	3 m
Test item:	Harmonic	Power:	DC 3.3 V
Frequency:	2472 MHz	Temp.(°C)/Hum.(%RH):	26(°C)/60 %RH
Mode:	Mode 2		
Ant.Polar.:	Vertical		

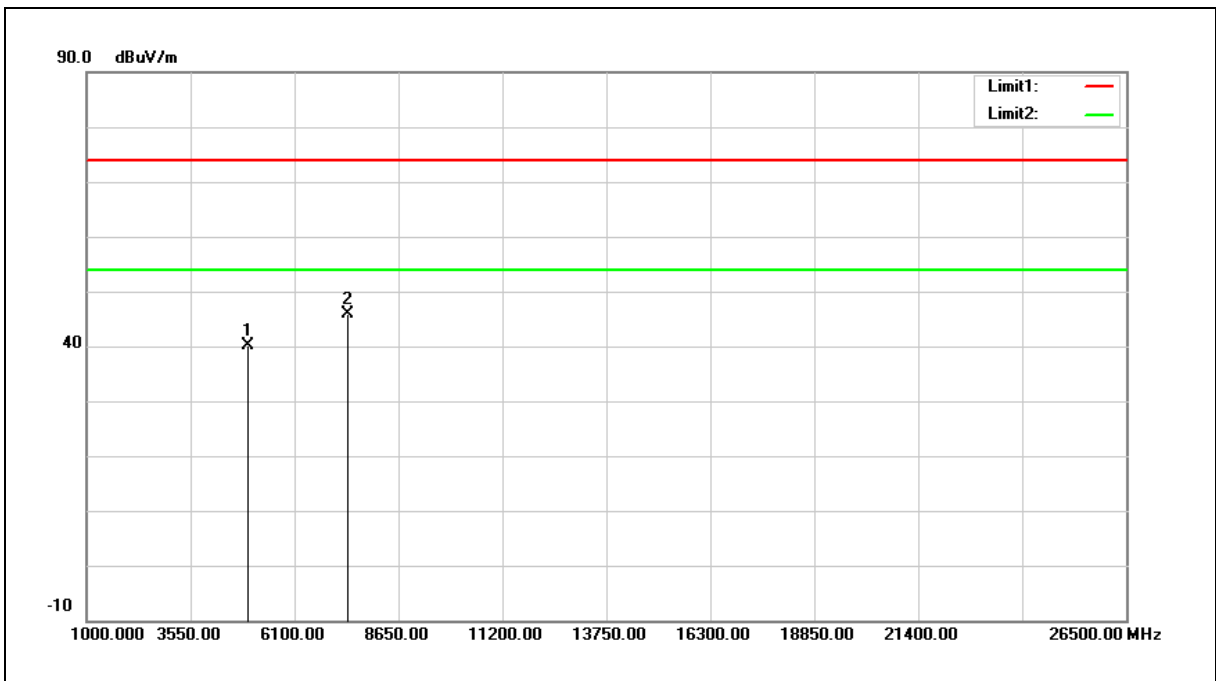

No.	Frequency (MHz)	Reading (dBuV)	Correct Factor (dB/m)	Result (dBuV/m)	Limit (dBuV/m)	Margin (dB)	Remark
1	4944.000	34.48	5.62	40.10	74.00	-33.90	peak
2	7416.000	33.47	12.45	45.92	74.00	-28.08	peak

Note:1.Result (dBuV/m) = Correct Factor (dB/m) + Reading(dBuV).

2.Correction factor (dB/m) = Antenna Factor (dB/m) + Cable loss (dB) – Pre-Amplifier gain (dB).

3. When the peak results are less than average limit, so not need to evaluate the average.



Standard:	FCC Part 15.247	Test Distance:	3 m
Test item:	Harmonic	Power:	DC 3.3 V
Frequency:	2412 MHz	Temp.(°C)/Hum.(%RH):	26(°C)/60 %RH
Mode:	Mode 3		
Ant.Polar.:	Horizontal		

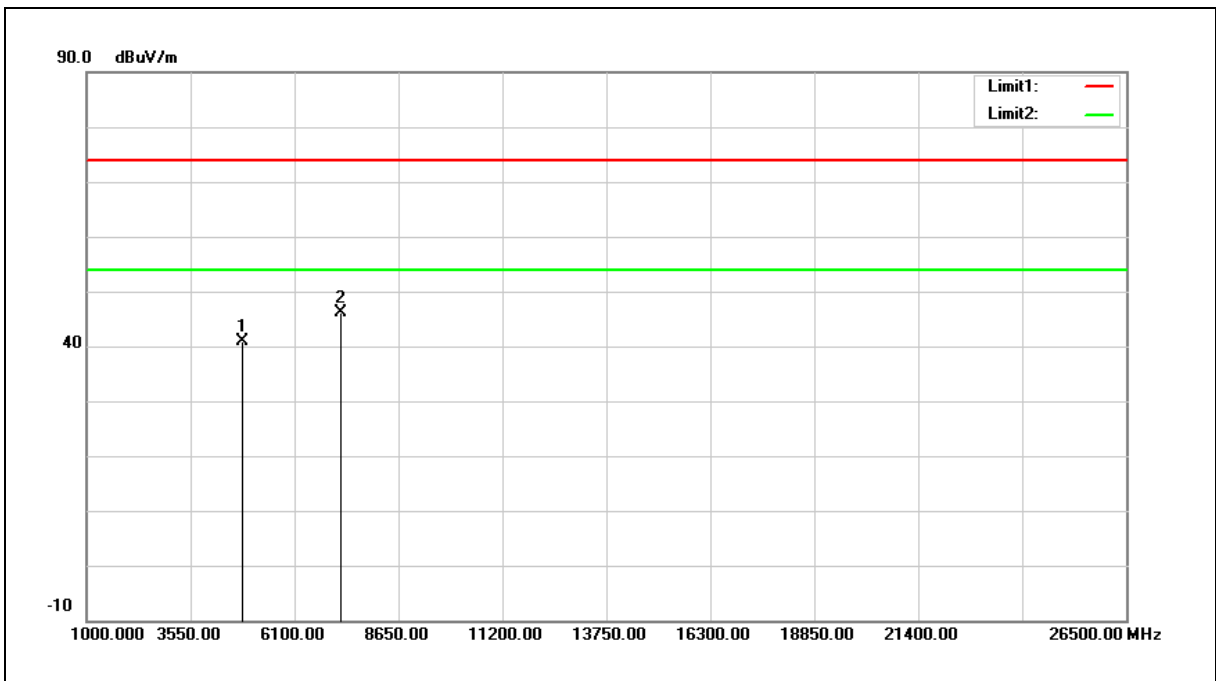

No.	Frequency (MHz)	Reading (dBuV)	Correct Factor (dB/m)	Result (dBuV/m)	Limit (dBuV/m)	Margin (dB)	Remark
1	4824.000	35.51	5.37	40.88	74.00	-33.12	peak
2	7236.000	34.30	11.90	46.20	74.00	-27.80	peak

- Note:1.Result (dBuV/m) = Correct Factor (dB/m) + Reading(dBuV).
 2.Correction factor (dB/m) = Antenna Factor (dB/m) + Cable loss (dB) – Pre-Amplifier gain (dB).
 3. When the peak results are less than average limit, so not need to evaluate the average.



Standard:	FCC Part 15.247	Test Distance:	3 m
Test item:	Harmonic	Power:	DC 3.3 V
Frequency:	2412 MHz	Temp.(°C)/Hum.(%RH):	26(°C)/60 %RH
Mode:	Mode 3		
Ant.Polar.:	Vertical		

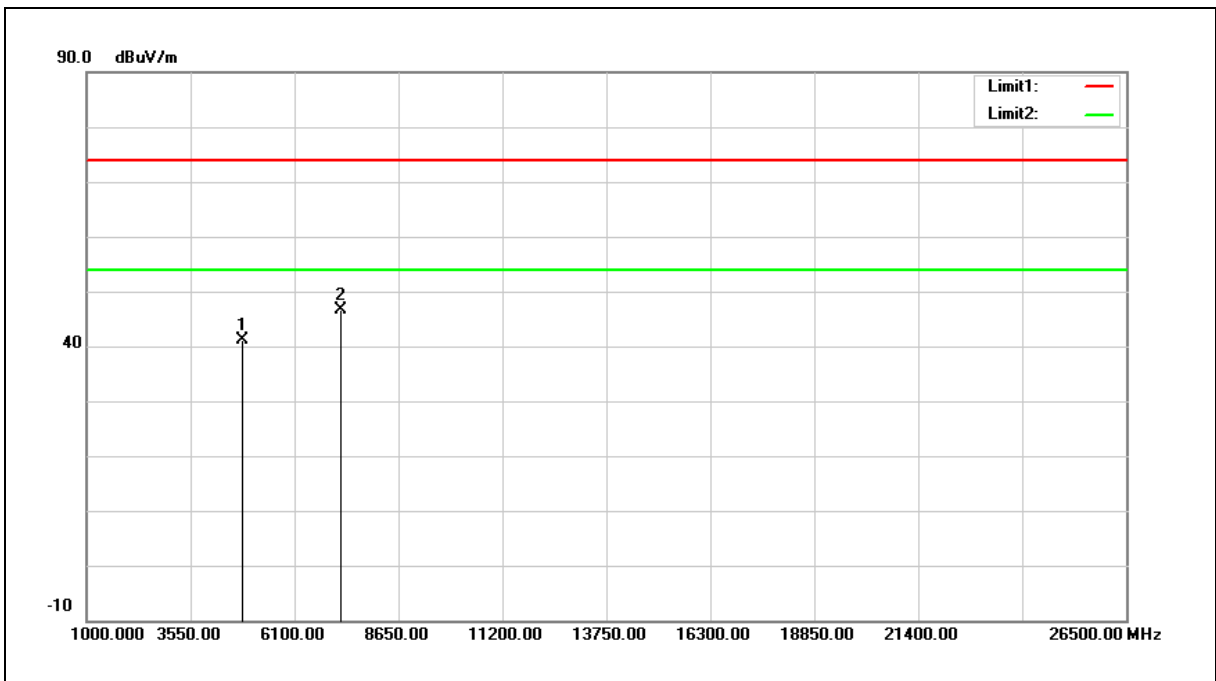

No.	Frequency (MHz)	Reading (dBuV)	Correct Factor (dB/m)	Result (dBuV/m)	Limit (dBuV/m)	Margin (dB)	Remark
1	4824.000	35.75	5.37	41.12	74.00	-32.88	peak
2	7236.000	34.83	11.90	46.73	74.00	-27.27	peak

Note:1.Result (dBuV/m) = Correct Factor (dB/m) + Reading(dBuV).

2.Correction factor (dB/m) = Antenna Factor (dB/m) + Cable loss (dB) – Pre-Amplifier gain (dB).

3. When the peak results are less than average limit, so not need to evaluate the average.



Standard:	FCC Part 15.247	Test Distance:	3 m
Test item:	Harmonic	Power:	DC 3.3 V
Frequency:	2437 MHz	Temp.(°C)/Hum.(%RH):	26(°C)/60 %RH
Mode:	Mode 3		
Ant.Polar.:	Horizontal		

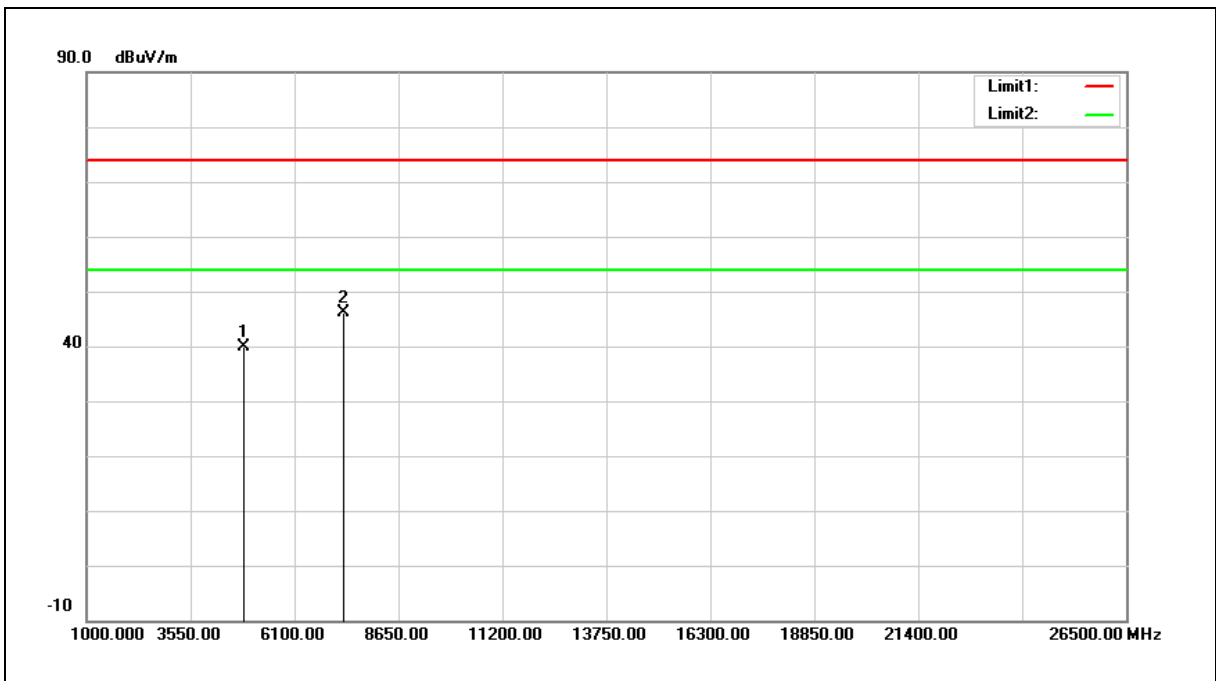

No.	Frequency (MHz)	Reading (dBuV)	Correct Factor (dB/m)	Result (dBuV/m)	Limit (dBuV/m)	Margin (dB)	Remark
1	4874.000	34.32	5.47	39.79	74.00	-34.21	peak
2	7311.000	33.88	12.13	46.01	74.00	-27.99	peak

- Note:1.Result (dBuV/m) = Correct Factor (dB/m) + Reading(dBuV).
 2.Correction factor (dB/m) = Antenna Factor (dB/m) + Cable loss (dB) – Pre-Amplifier gain (dB).
 3. When the peak results are less than average limit, so not need to evaluate the average.



Standard:	FCC Part 15.247	Test Distance:	3 m
Test item:	Harmonic	Power:	DC 3.3 V
Frequency:	2437 MHz	Temp.(°C)/Hum.(%RH):	26(°C)/60 %RH
Mode:	Mode 3		
Ant.Polar.:	Vertical		

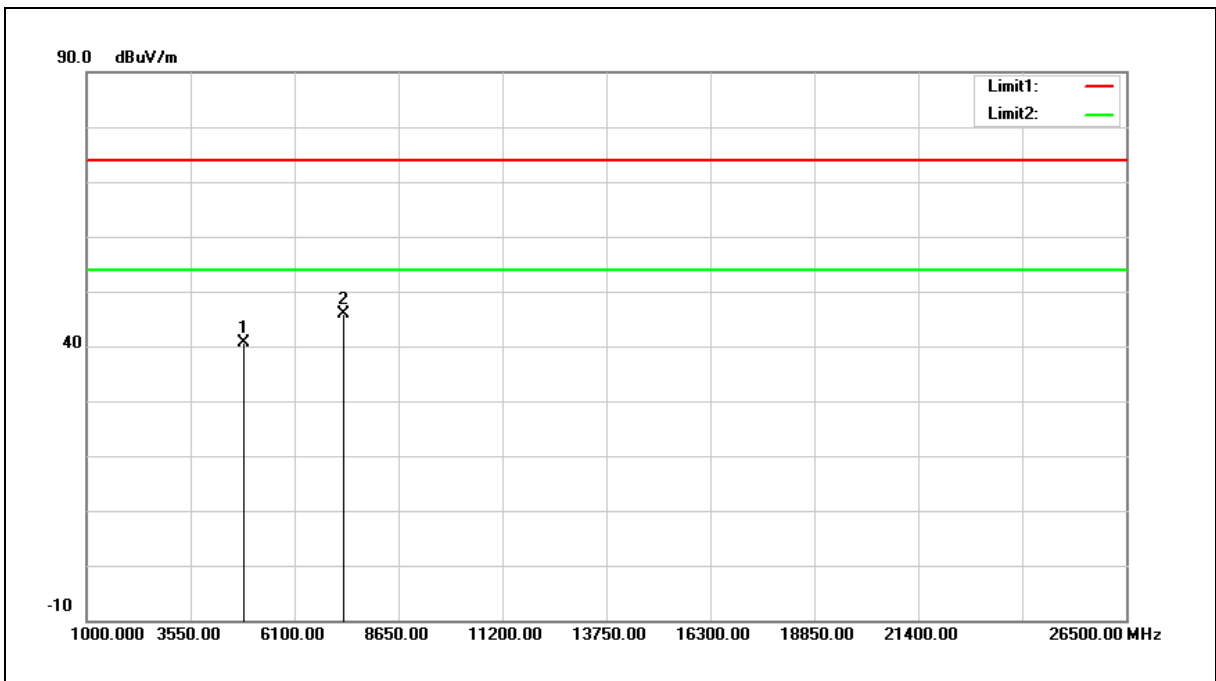

No.	Frequency (MHz)	Reading (dBuV)	Correct Factor (dB/m)	Result (dBuV/m)	Limit (dBuV/m)	Margin (dB)	Remark
1	4874.000	35.19	5.47	40.66	74.00	-33.34	peak
2	7311.000	33.75	12.13	45.88	74.00	-28.12	peak

- Note:1.Result (dBuV/m) = Correct Factor (dB/m) + Reading(dBuV).
 2.Correction factor (dB/m) = Antenna Factor (dB/m) + Cable loss (dB) – Pre-Amplifier gain (dB).
 3. When the peak results are less than average limit, so not need to evaluate the average.



Standard:	FCC Part 15.247	Test Distance:	3 m
Test item:	Harmonic	Power:	DC 3.3 V
Frequency:	2462 MHz	Temp.(°C)/Hum.(%RH):	26(°C)/60 %RH
Mode:	Mode 3		
Ant.Polar.:	Horizontal		

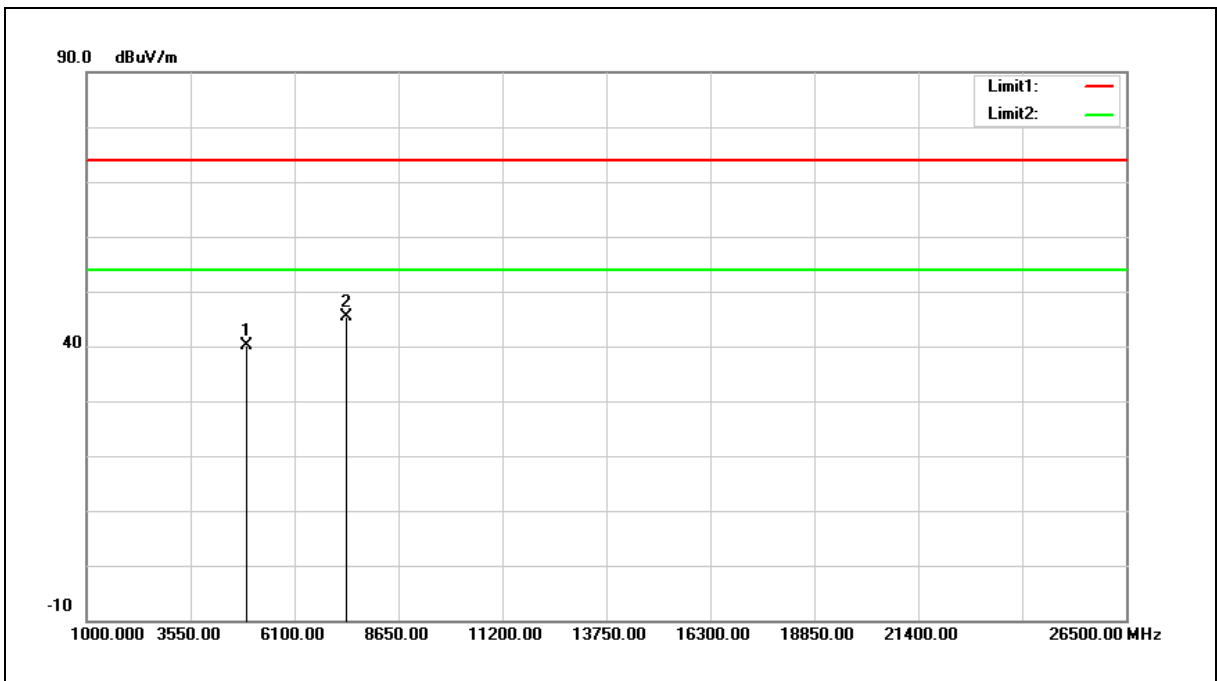

No.	Frequency (MHz)	Reading (dBuV)	Correct Factor (dB/m)	Result (dBuV/m)	Limit (dBuV/m)	Margin (dB)	Remark
1	4924.000	34.52	5.58	40.10	74.00	-33.90	peak
2	7386.000	33.10	12.36	45.46	74.00	-28.54	peak

Note:1.Result (dBuV/m) = Correct Factor (dB/m) + Reading(dBuV).

2.Correction factor (dB/m) = Antenna Factor (dB/m) + Cable loss (dB) – Pre-Amplifier gain (dB).

3. When the peak results are less than average limit, so not need to evaluate the average.



Standard:	FCC Part 15.247	Test Distance:	3 m
Test item:	Harmonic	Power:	DC 3.3 V
Frequency:	2462 MHz	Temp.(°C)/Hum.(%RH):	26(°C)/60 %RH
Mode:	Mode 3		
Ant.Polar.:	Vertical		

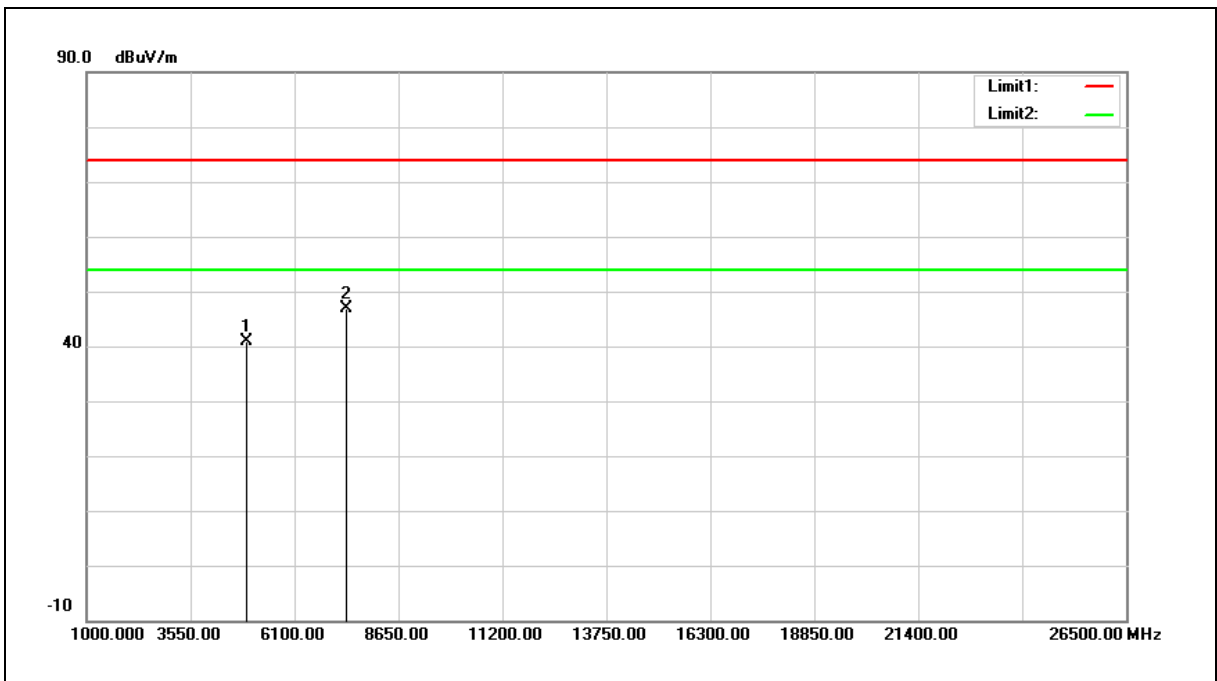

No.	Frequency (MHz)	Reading (dBuV)	Correct Factor (dB/m)	Result (dBuV/m)	Limit (dBuV/m)	Margin (dB)	Remark
1	4924.000	35.19	5.58	40.77	74.00	-33.23	peak
2	7386.000	34.57	12.36	46.93	74.00	-27.07	peak

Note:1.Result (dBuV/m) = Correct Factor (dB/m) + Reading(dBuV).

2.Correction factor (dB/m) = Antenna Factor (dB/m) + Cable loss (dB) – Pre-Amplifier gain (dB).

3. When the peak results are less than average limit, so not need to evaluate the average.



Standard:	FCC Part 15.247	Test Distance:	3 m
Test item:	Harmonic	Power:	DC 3.3 V
Frequency:	2467 MHz	Temp.(°C)/Hum.(%RH):	26(°C)/60 %RH
Mode:	Mode 3		
Ant.Polar.:	Horizontal		

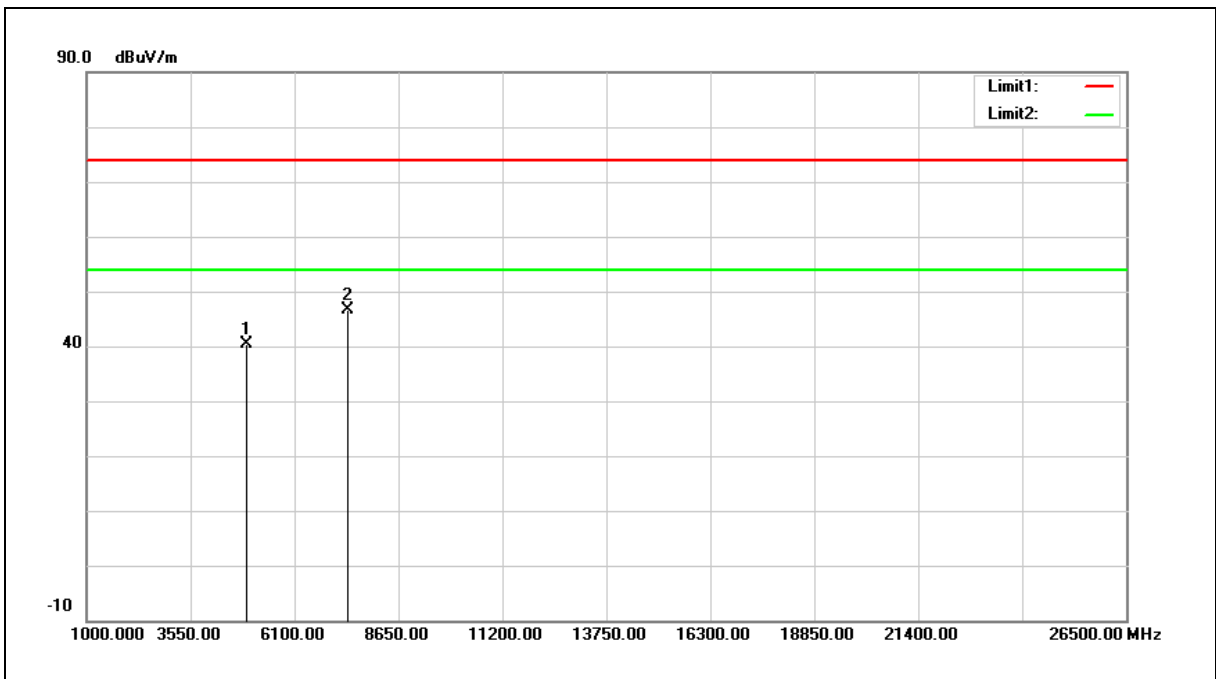

No.	Frequency (MHz)	Reading (dBuV)	Correct Factor (dB/m)	Result (dBuV/m)	Limit (dBuV/m)	Margin (dB)	Remark
1	4934.000	34.88	5.60	40.48	74.00	-33.52	peak
2	7401.000	34.35	12.40	46.75	74.00	-27.25	peak

- Note:1.Result (dBuV/m) = Correct Factor (dB/m) + Reading(dBuV).
 2.Correction factor (dB/m) = Antenna Factor (dB/m) + Cable loss (dB) – Pre-Amplifier gain (dB).
 3. When the peak results are less than average limit, so not need to evaluate the average.



Standard:	FCC Part 15.247	Test Distance:	3 m
Test item:	Harmonic	Power:	DC 3.3 V
Frequency:	2467 MHz	Temp.(°C)/Hum.(%RH):	26(°C)/60 %RH
Mode:	Mode 3		
Ant.Polar.:	Vertical		

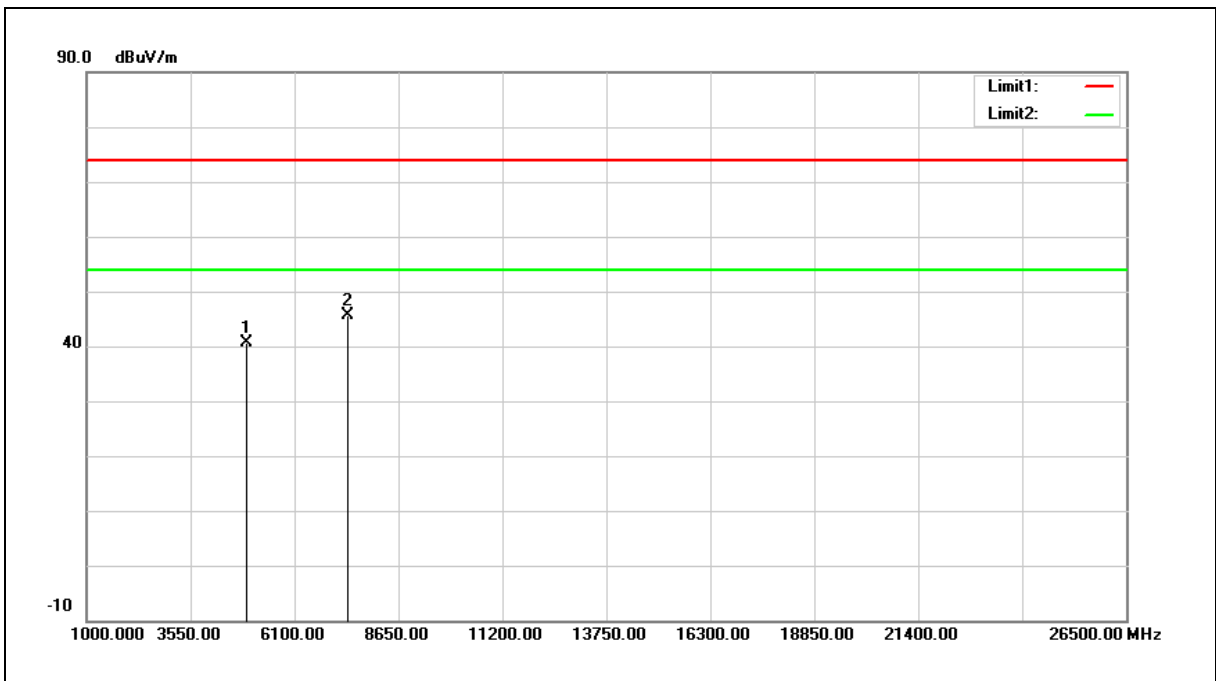

No.	Frequency (MHz)	Reading (dBuV)	Correct Factor (dB/m)	Result (dBuV/m)	Limit (dBuV/m)	Margin (dB)	Remark
1	4934.000	34.95	5.60	40.55	74.00	-33.45	peak
2	7401.000	33.31	12.40	45.71	74.00	-28.29	peak

Note:1.Result (dBuV/m) = Correct Factor (dB/m) + Reading(dBuV).

2.Correction factor (dB/m) = Antenna Factor (dB/m) + Cable loss (dB) – Pre-Amplifier gain (dB).

3. When the peak results are less than average limit, so not need to evaluate the average.



Standard:	FCC Part 15.247	Test Distance:	3 m
Test item:	Harmonic	Power:	DC 3.3 V
Frequency:	2472 MHz	Temp.(°C)/Hum.(%RH):	26(°C)/60 %RH
Mode:	Mode 3		
Ant.Polar.:	Horizontal		

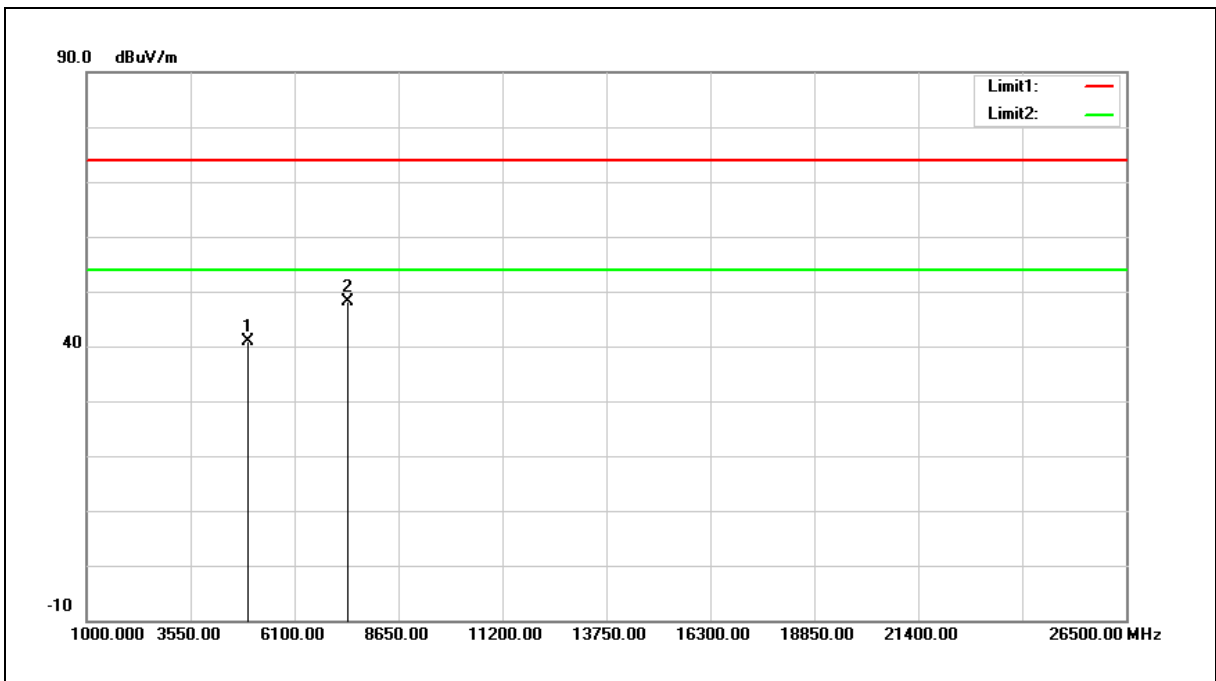

No.	Frequency (MHz)	Reading (dBuV)	Correct Factor (dB/m)	Result (dBuV/m)	Limit (dBuV/m)	Margin (dB)	Remark
1	4944.000	35.34	5.62	40.96	74.00	-33.04	peak
2	7416.000	35.67	12.45	48.12	74.00	-25.88	peak

- Note:1.Result (dBuV/m) = Correct Factor (dB/m) + Reading(dBuV).
 2.Correction factor (dB/m) = Antenna Factor (dB/m) + Cable loss (dB) – Pre-Amplifier gain (dB).
 3. When the peak results are less than average limit, so not need to evaluate the average.



Standard:	FCC Part 15.247	Test Distance:	3 m
Test item:	Harmonic	Power:	DC 3.3 V
Frequency:	2472 MHz	Temp.(°C)/Hum.(%RH):	26(°C)/60 %RH
Mode:	Mode 3		
Ant.Polar.:	Vertical		

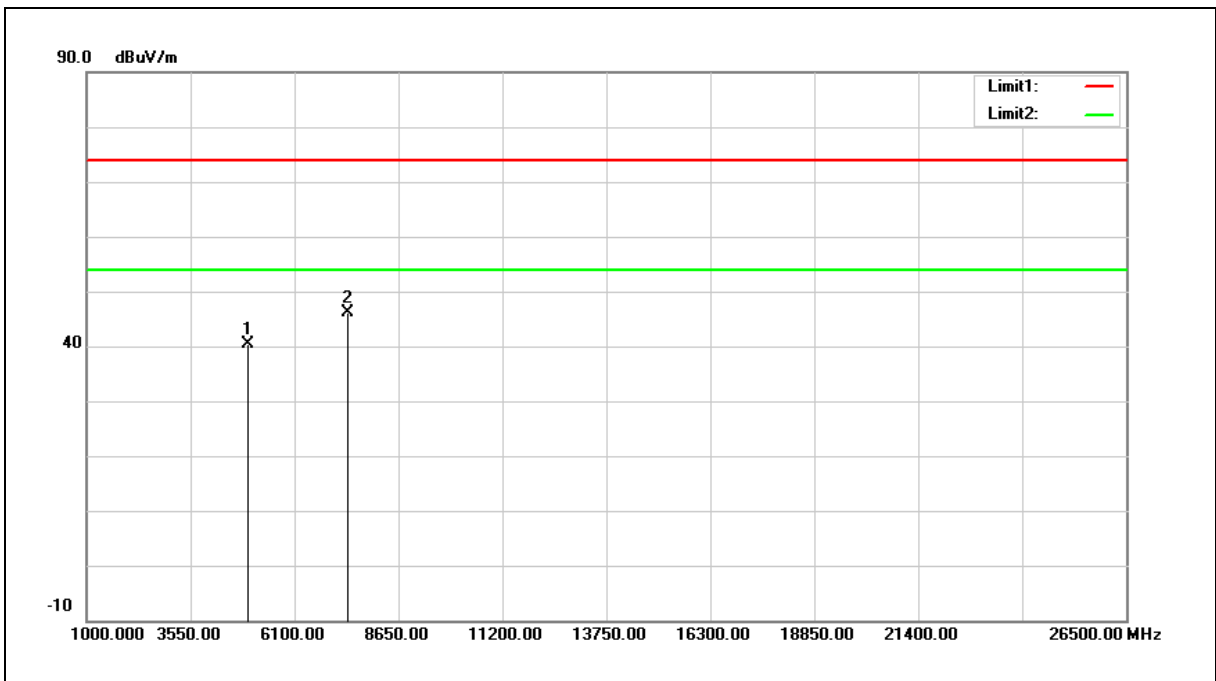

No.	Frequency (MHz)	Reading (dBuV)	Correct Factor (dB/m)	Result (dBuV/m)	Limit (dBuV/m)	Margin (dB)	Remark
1	4944.000	34.69	5.62	40.31	74.00	-33.69	peak
2	7416.000	33.75	12.45	46.20	74.00	-27.80	peak

- Note:1.Result (dBuV/m) = Correct Factor (dB/m) + Reading(dBuV).
 2.Correction factor (dB/m) = Antenna Factor (dB/m) + Cable loss (dB) – Pre-Amplifier gain (dB).
 3. When the peak results are less than average limit, so not need to evaluate the average.

SISO B

Standard:	FCC Part 15.247	Test Distance:	3 m
Test item:	Harmonic	Power:	DC 3.3 V
Frequency:	2412 MHz	Temp.(°C)/Hum.(%RH):	26(°C)/60 %RH
Mode:	Mode 2		
Ant.Polar.:	Horizontal		

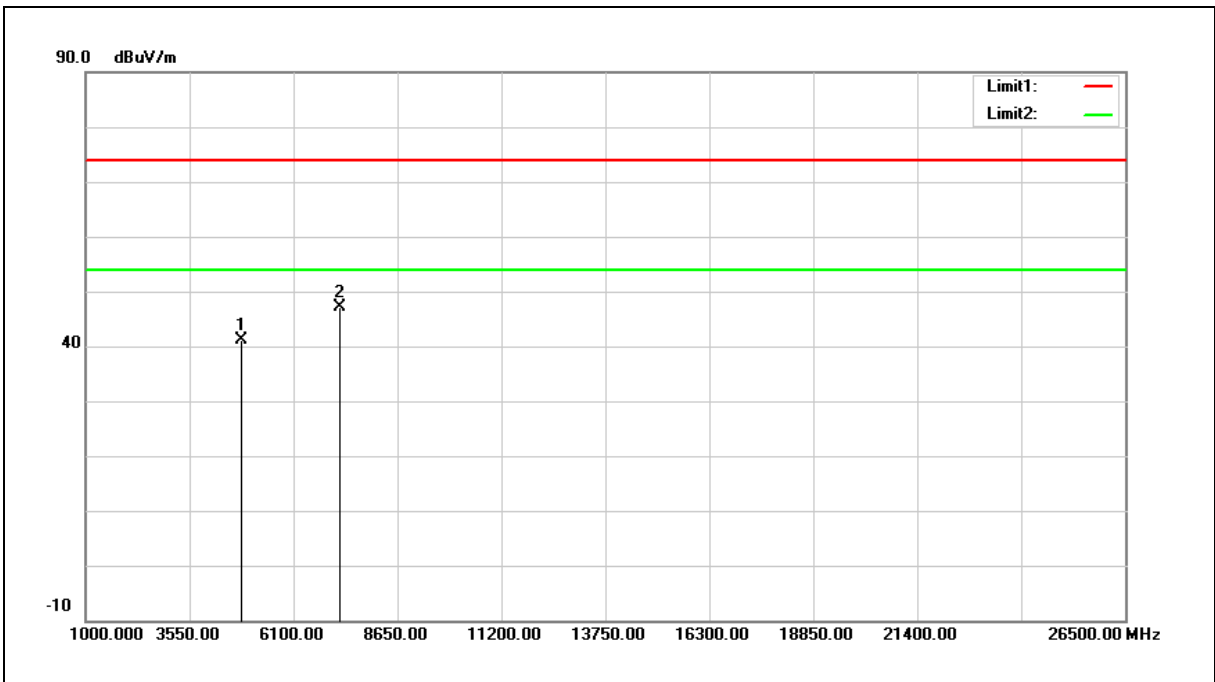

No.	Frequency (MHz)	Reading (dBuV)	Correct Factor (dB/m)	Result (dBuV/m)	Limit (dBuV/m)	Margin (dB)	Remark
1	4824.000	35.68	5.37	41.05	74.00	-32.95	peak
2	7236.000	35.17	11.90	47.07	74.00	-26.93	peak

Note:1.Result (dBuV/m) = Correct Factor (dB/m) + Reading(dBuV).

2.Correction factor (dB/m) = Antenna Factor (dB/m) + Cable loss (dB) – Pre-Amplifier gain (dB).

3. When the peak results are less than average limit, so not need to evaluate the average.



Standard:	FCC Part 15.247	Test Distance:	3 m
Test item:	Harmonic	Power:	DC 3.3 V
Frequency:	2412 MHz	Temp.(°C)/Hum.(%RH):	26(°C)/60 %RH
Mode:	Mode 2		
Ant.Polar.:	Vertical		

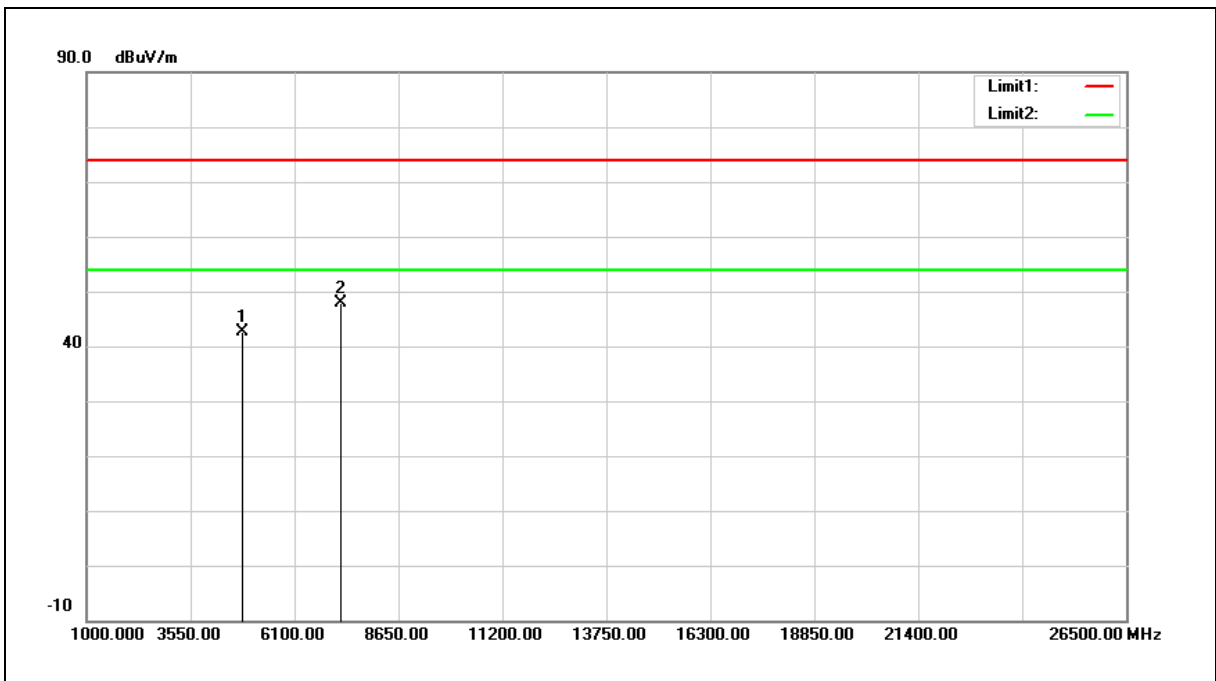

No.	Frequency (MHz)	Reading (dBuV)	Correct Factor (dB/m)	Result (dBuV/m)	Limit (dBuV/m)	Margin (dB)	Remark
1	4824.000	37.36	5.37	42.73	74.00	-31.27	peak
2	7236.000	35.86	11.90	47.76	74.00	-26.24	peak

Note:1.Result (dBuV/m) = Correct Factor (dB/m) + Reading(dBuV).

2.Correction factor (dB/m) = Antenna Factor (dB/m) + Cable loss (dB) – Pre-Amplifier gain (dB).

3. When the peak results are less than average limit, so not need to evaluate the average.



Standard:	FCC Part 15.247	Test Distance:	3 m
Test item:	Harmonic	Power:	DC 3.3 V
Frequency:	2437 MHz	Temp.(°C)/Hum.(%RH):	26(°C)/60 %RH
Mode:	Mode 2		
Ant.Polar.:	Horizontal		

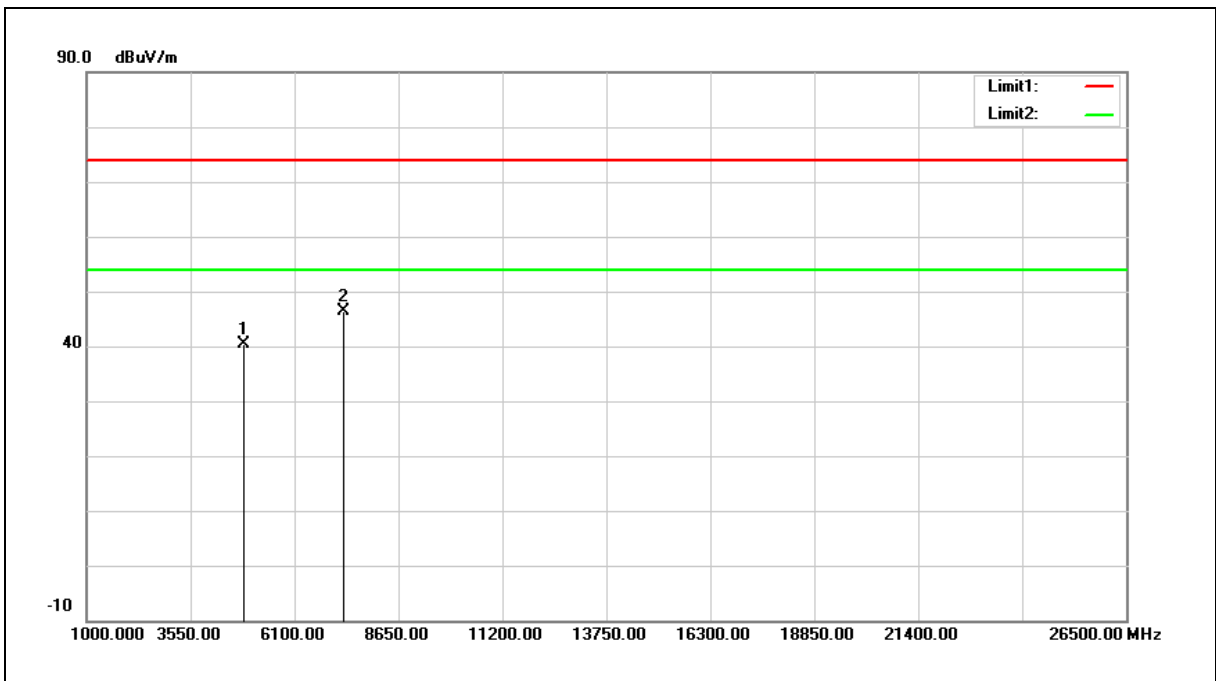

No.	Frequency (MHz)	Reading (dBuV)	Correct Factor (dB/m)	Result (dBuV/m)	Limit (dBuV/m)	Margin (dB)	Remark
1	4874.000	35.02	5.47	40.49	74.00	-33.51	peak
2	7311.000	34.29	12.13	46.42	74.00	-27.58	peak

- Note:1.Result (dBuV/m) = Correct Factor (dB/m) + Reading(dBuV).
 2.Correction factor (dB/m) = Antenna Factor (dB/m) + Cable loss (dB) – Pre-Amplifier gain (dB).
 3. When the peak results are less than average limit, so not need to evaluate the average.



Standard:	FCC Part 15.247	Test Distance:	3 m
Test item:	Harmonic	Power:	DC 3.3 V
Frequency:	2437 MHz	Temp.(°C)/Hum.(%RH):	26(°C)/60 %RH
Mode:	Mode 2		
Ant.Polar.:	Vertical		

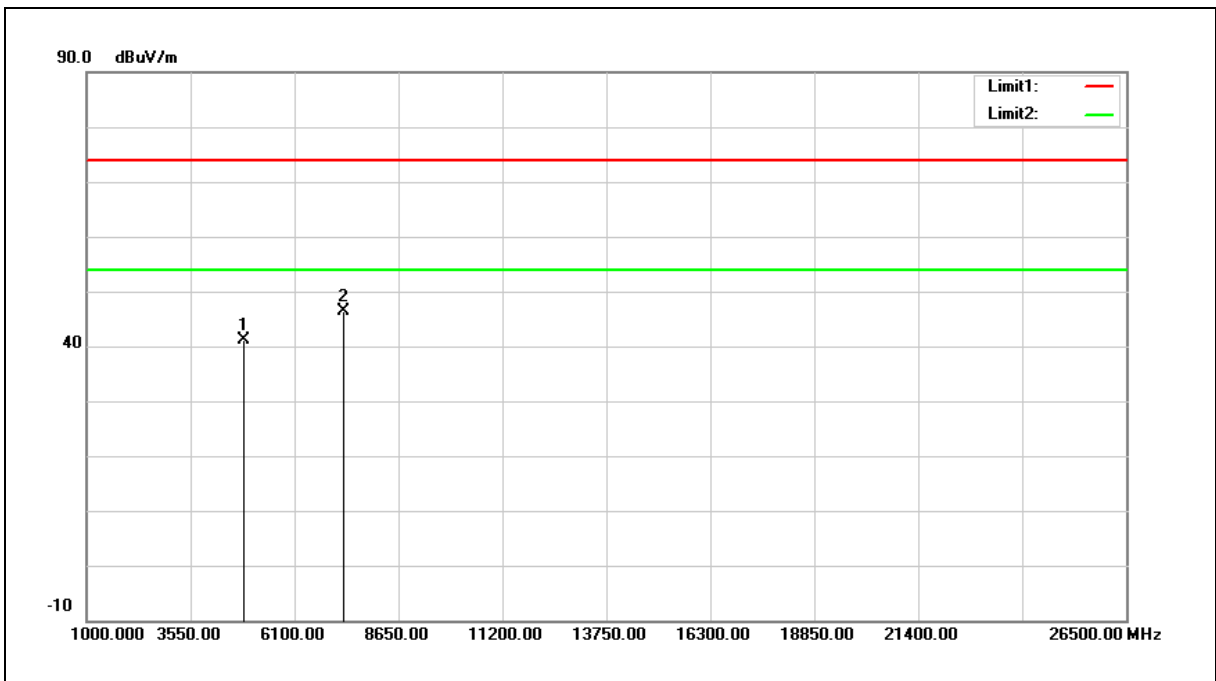

No.	Frequency (MHz)	Reading (dBuV)	Correct Factor (dB/m)	Result (dBuV/m)	Limit (dBuV/m)	Margin (dB)	Remark
1	4874.000	35.67	5.47	41.14	74.00	-32.86	peak
2	7311.000	34.18	12.13	46.31	74.00	-27.69	peak

- Note:1.Result (dBuV/m) = Correct Factor (dB/m) + Reading(dBuV).
 2.Correction factor (dB/m) = Antenna Factor (dB/m) + Cable loss (dB) – Pre-Amplifier gain (dB).
 3. When the peak results are less than average limit, so not need to evaluate the average.



Standard:	FCC Part 15.247	Test Distance:	3 m
Test item:	Harmonic	Power:	DC 3.3 V
Frequency:	2462 MHz	Temp.(°C)/Hum.(%RH):	26(°C)/60 %RH
Mode:	Mode 2		
Ant.Polar.:	Horizontal		

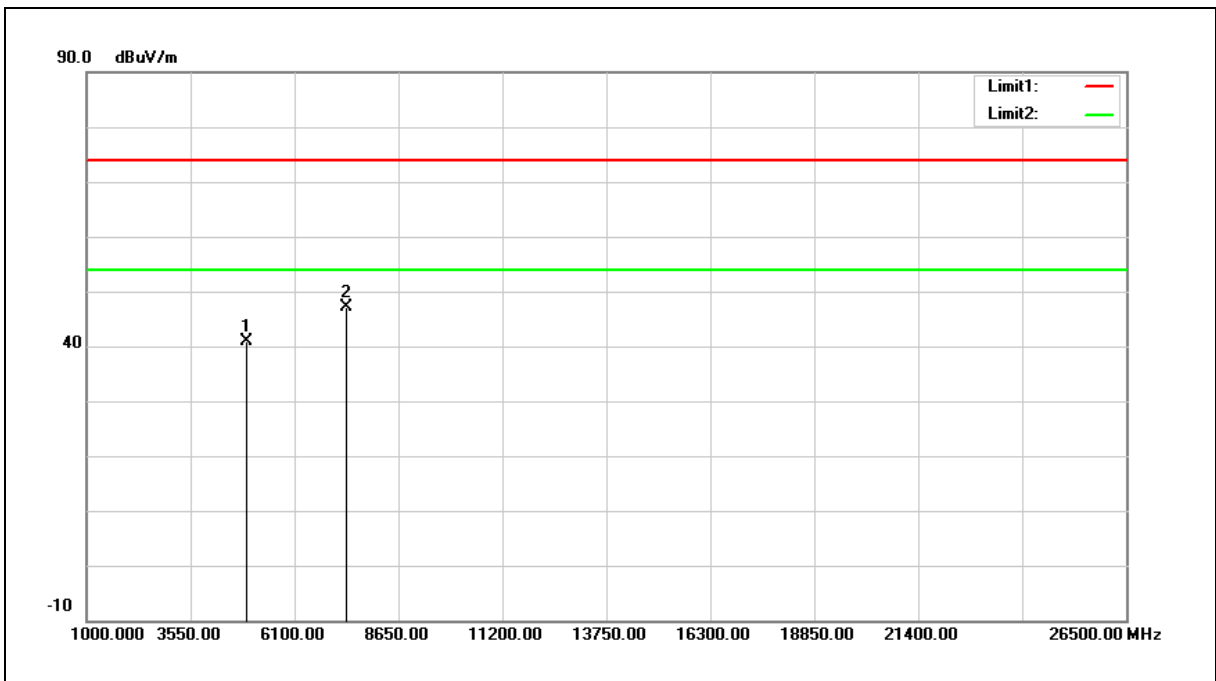

No.	Frequency (MHz)	Reading (dBuV)	Correct Factor (dB/m)	Result (dBuV/m)	Limit (dBuV/m)	Margin (dB)	Remark
1	4924.000	35.19	5.58	40.77	74.00	-33.23	peak
2	7386.000	34.89	12.36	47.25	74.00	-26.75	peak

- Note:1.Result (dBuV/m) = Correct Factor (dB/m) + Reading(dBuV).
 2.Correction factor (dB/m) = Antenna Factor (dB/m) + Cable loss (dB) – Pre-Amplifier gain (dB).
 3. When the peak results are less than average limit, so not need to evaluate the average.



Standard:	FCC Part 15.247	Test Distance:	3 m
Test item:	Harmonic	Power:	DC 3.3 V
Frequency:	2462 MHz	Temp.(°C)/Hum.(%RH):	26(°C)/60 %RH
Mode:	Mode 2		
Ant.Polar.:	Vertical		

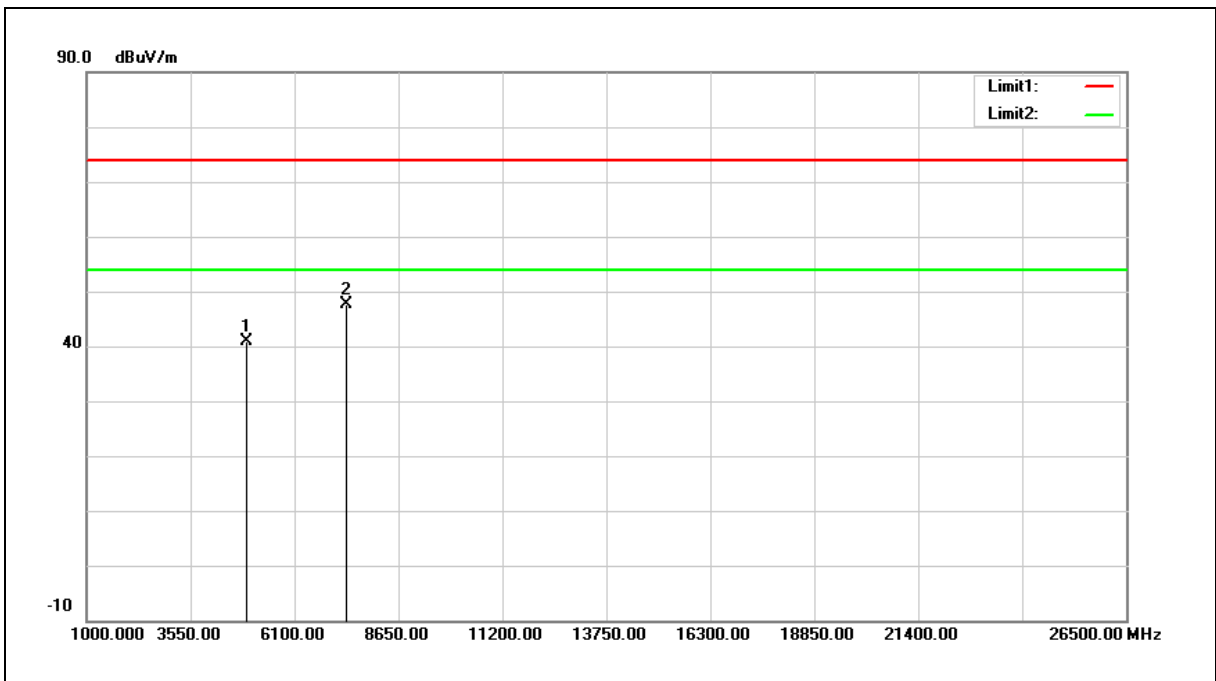

No.	Frequency (MHz)	Reading (dBuV)	Correct Factor (dB/m)	Result (dBuV/m)	Limit (dBuV/m)	Margin (dB)	Remark
1	4924.000	35.37	5.58	40.95	74.00	-33.05	peak
2	7386.000	35.25	12.36	47.61	74.00	-26.39	peak

- Note:1.Result (dBuV/m) = Correct Factor (dB/m) + Reading(dBuV).
 2.Correction factor (dB/m) = Antenna Factor (dB/m) + Cable loss (dB) – Pre-Amplifier gain (dB).
 3. When the peak results are less than average limit, so not need to evaluate the average.



Standard:	FCC Part 15.247	Test Distance:	3 m
Test item:	Harmonic	Power:	DC 3.3 V
Frequency:	2467 MHz	Temp.(°C)/Hum.(%RH):	26(°C)/60 %RH
Mode:	Mode 2		
Ant.Polar.:	Horizontal		

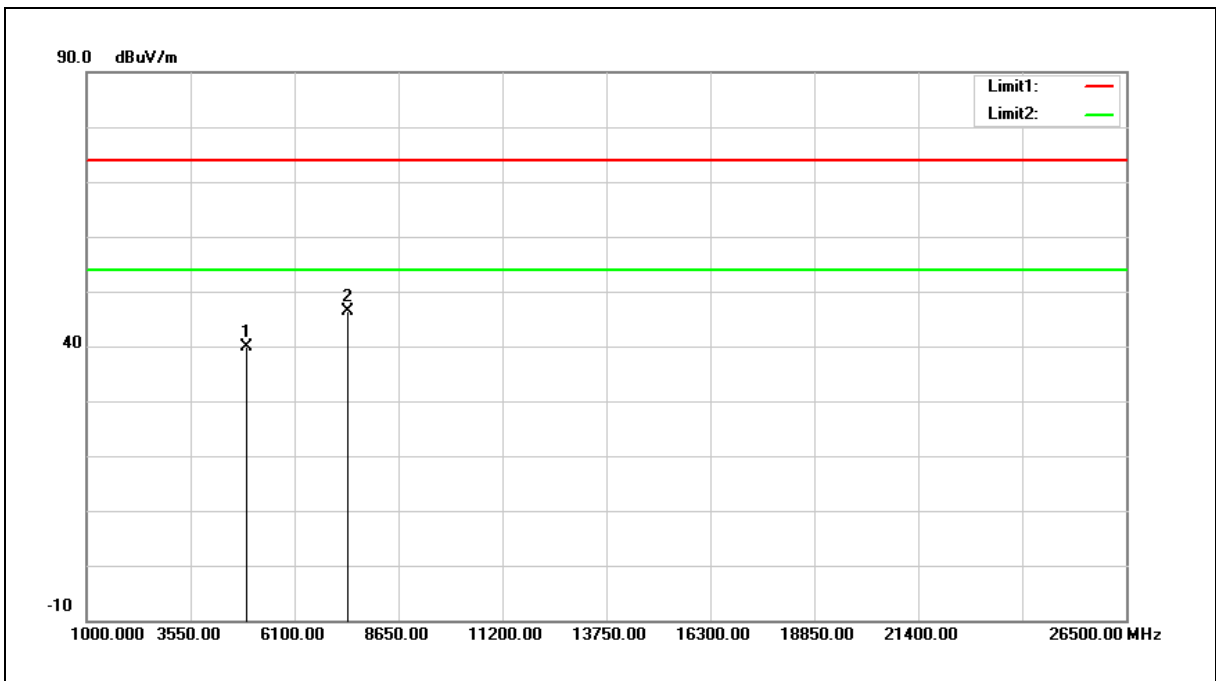

No.	Frequency (MHz)	Reading (dBuV)	Correct Factor (dB/m)	Result (dBuV/m)	Limit (dBuV/m)	Margin (dB)	Remark
1	4934.000	34.38	5.60	39.98	74.00	-34.02	peak
2	7401.000	34.02	12.40	46.42	74.00	-27.58	peak

Note:1.Result (dBuV/m) = Correct Factor (dB/m) + Reading(dBuV).

2.Correction factor (dB/m) = Antenna Factor (dB/m) + Cable loss (dB) – Pre-Amplifier gain (dB).

3. When the peak results are less than average limit, so not need to evaluate the average.



Standard:	FCC Part 15.247	Test Distance:	3 m
Test item:	Harmonic	Power:	DC 3.3 V
Frequency:	2467 MHz	Temp.(°C)/Hum.(%RH):	26(°C)/60 %RH
Mode:	Mode 2		
Ant.Polar.:	Vertical		

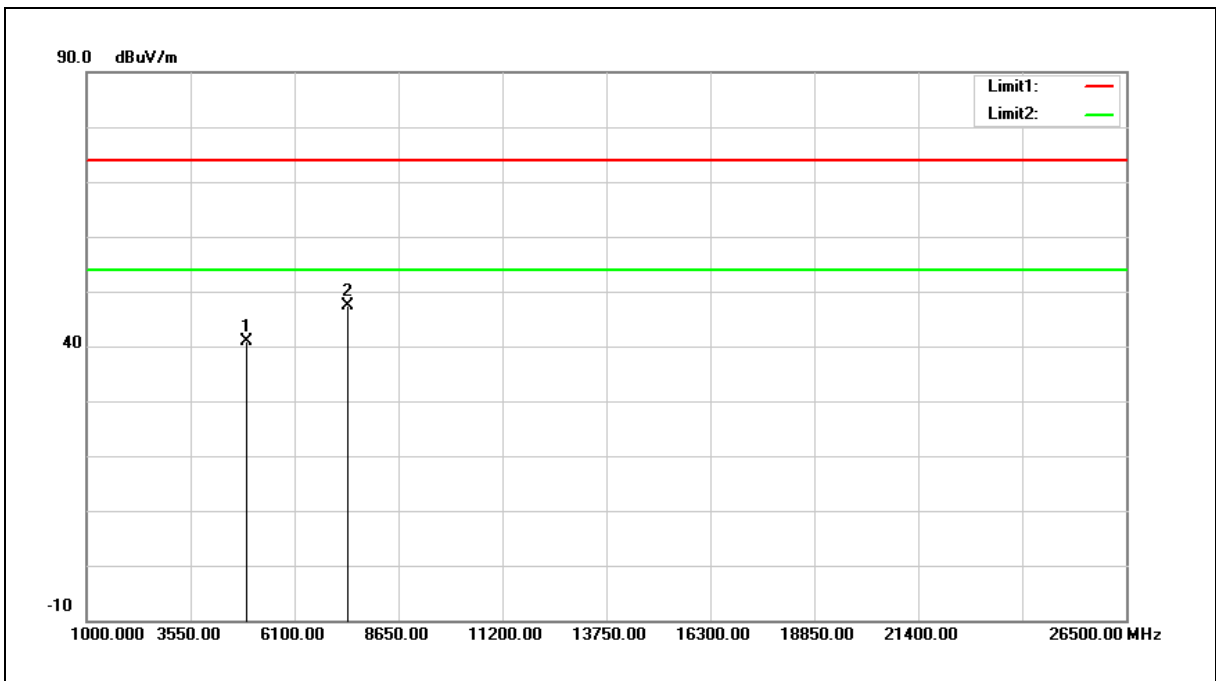

No.	Frequency (MHz)	Reading (dBuV)	Correct Factor (dB/m)	Result (dBuV/m)	Limit (dBuV/m)	Margin (dB)	Remark
1	4934.000	35.20	5.60	40.80	74.00	-33.20	peak
2	7401.000	34.89	12.40	47.29	74.00	-26.71	peak

- Note:1.Result (dBuV/m) = Correct Factor (dB/m) + Reading(dBuV).
 2.Correction factor (dB/m) = Antenna Factor (dB/m) + Cable loss (dB) – Pre-Amplifier gain (dB).
 3. When the peak results are less than average limit, so not need to evaluate the average.



Standard:	FCC Part 15.247	Test Distance:	3 m
Test item:	Harmonic	Power:	DC 3.3 V
Frequency:	2472 MHz	Temp.(°C)/Hum.(%RH):	26(°C)/60 %RH
Mode:	Mode 2		
Ant.Polar.:	Horizontal		

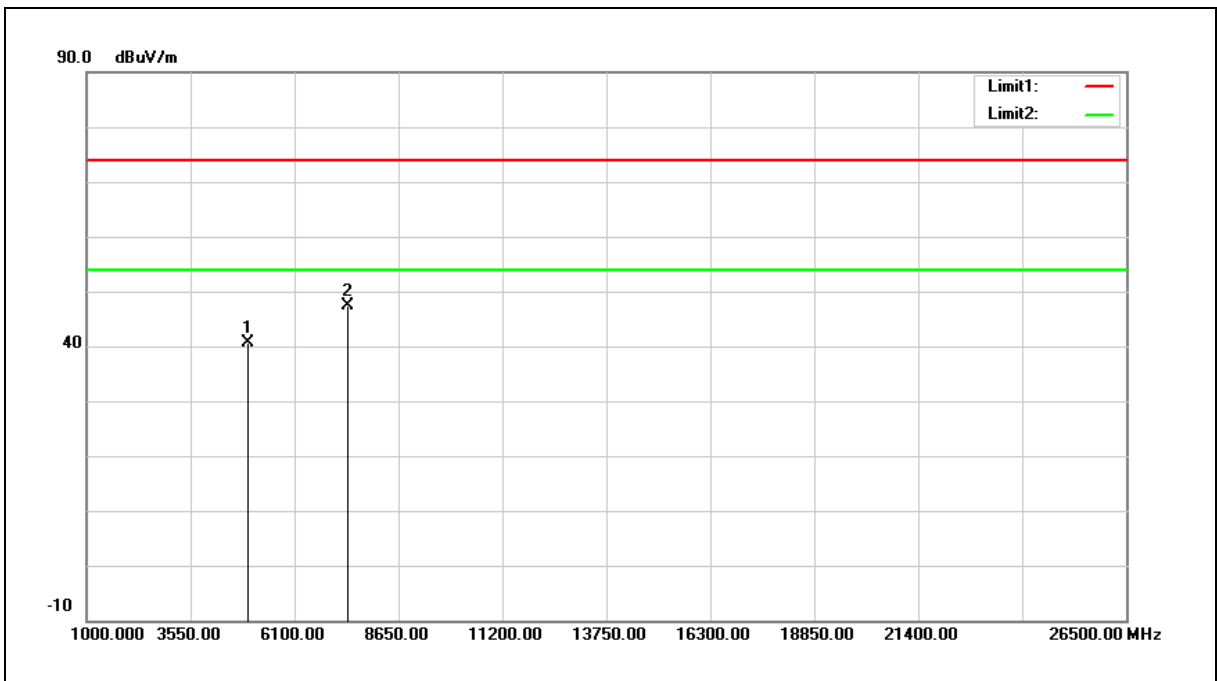

No.	Frequency (MHz)	Reading (dBuV)	Correct Factor (dB/m)	Result (dBuV/m)	Limit (dBuV/m)	Margin (dB)	Remark
1	4944.000	34.99	5.62	40.61	74.00	-33.39	peak
2	7416.000	34.85	12.45	47.30	74.00	-26.70	peak

- Note:1.Result (dBuV/m) = Correct Factor (dB/m) + Reading(dBuV).
 2.Correction factor (dB/m) = Antenna Factor (dB/m) + Cable loss (dB) – Pre-Amplifier gain (dB).
 3. When the peak results are less than average limit, so not need to evaluate the average.



Standard:	FCC Part 15.247	Test Distance:	3 m
Test item:	Harmonic	Power:	DC 3.3 V
Frequency:	2472 MHz	Temp.(°C)/Hum.(%RH):	26(°C)/60 %RH
Mode:	Mode 2		
Ant.Polar.:	Vertical		

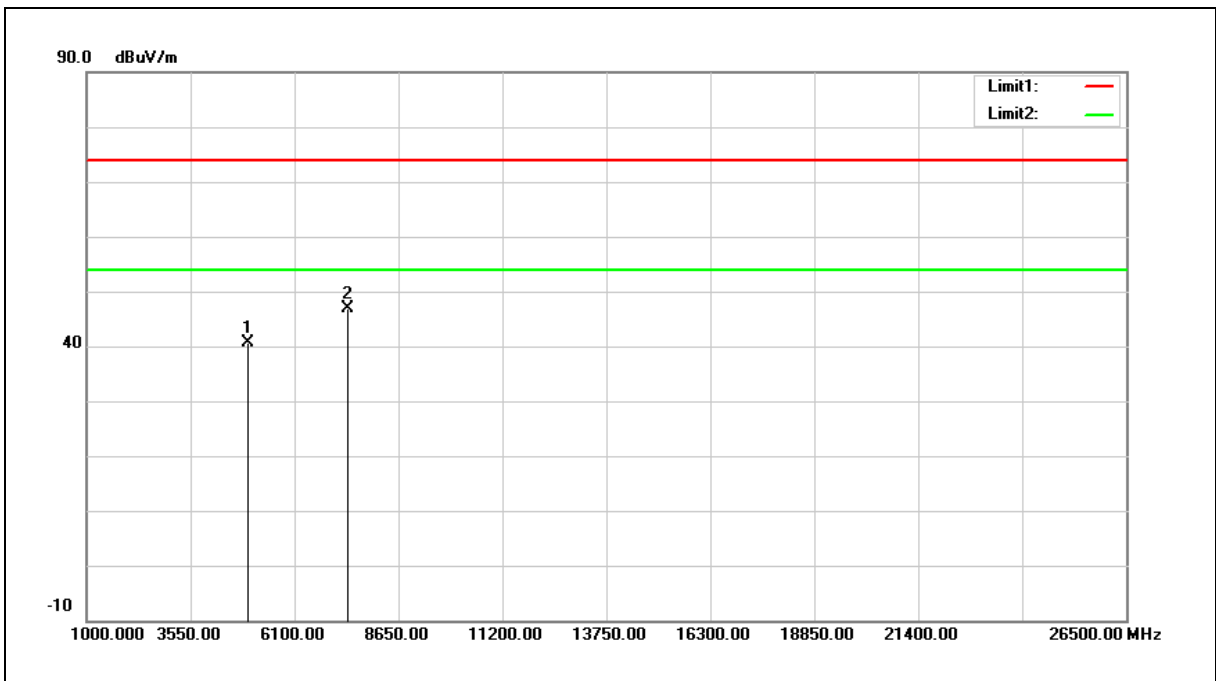

No.	Frequency (MHz)	Reading (dBuV)	Correct Factor (dB/m)	Result (dBuV/m)	Limit (dBuV/m)	Margin (dB)	Remark
1	4944.000	34.95	5.62	40.57	74.00	-33.43	peak
2	7416.000	34.38	12.45	46.83	74.00	-27.17	peak

- Note:1.Result (dBuV/m) = Correct Factor (dB/m) + Reading(dBuV).
 2.Correction factor (dB/m) = Antenna Factor (dB/m) + Cable loss (dB) – Pre-Amplifier gain (dB).
 3. When the peak results are less than average limit, so not need to evaluate the average.



Standard:	FCC Part 15.247	Test Distance:	3 m
Test item:	Harmonic	Power:	DC 3.3 V
Frequency:	2412 MHz	Temp.(°C)/Hum.(%RH):	26(°C)/60 %RH
Mode:	Mode 3		
Ant.Polar.:	Horizontal		

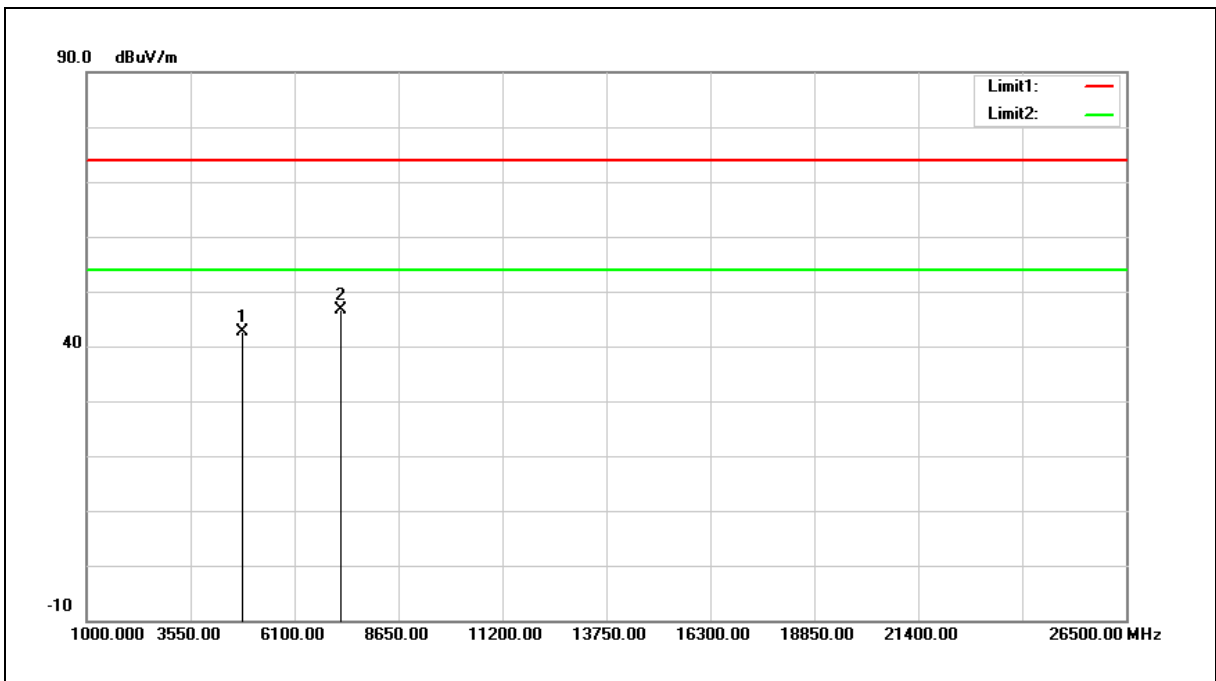

No.	Frequency (MHz)	Reading (dBuV)	Correct Factor (dB/m)	Result (dBuV/m)	Limit (dBuV/m)	Margin (dB)	Remark
1	4824.000	37.26	5.37	42.63	74.00	-31.37	peak
2	7236.000	34.71	11.90	46.61	74.00	-27.39	peak

- Note:1.Result (dBuV/m) = Correct Factor (dB/m) + Reading(dBuV).
 2.Correction factor (dB/m) = Antenna Factor (dB/m) + Cable loss (dB) – Pre-Amplifier gain (dB).
 3. When the peak results are less than average limit, so not need to evaluate the average.



Standard:	FCC Part 15.247	Test Distance:	3 m
Test item:	Harmonic	Power:	DC 3.3 V
Frequency:	2412 MHz	Temp.(°C)/Hum.(%RH):	26(°C)/60 %RH
Mode:	Mode 3		
Ant.Polar.:	Vertical		

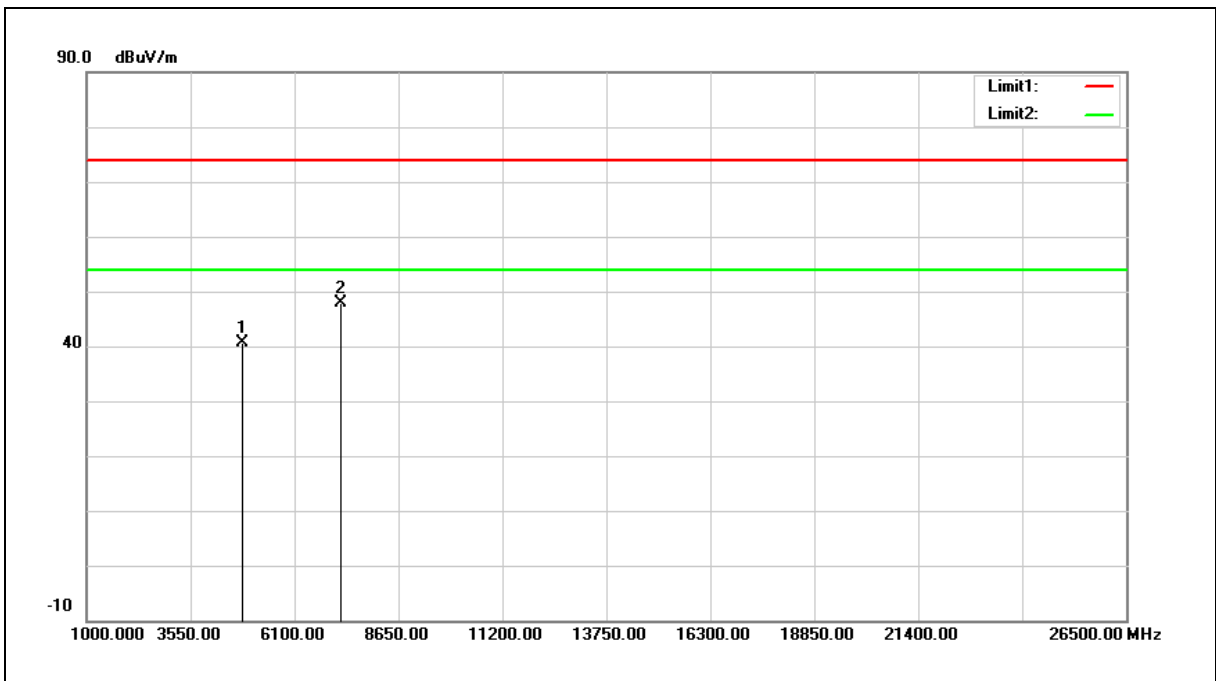

No.	Frequency (MHz)	Reading (dBuV)	Correct Factor (dB/m)	Result (dBuV/m)	Limit (dBuV/m)	Margin (dB)	Remark
1	4824.000	35.16	5.37	40.53	74.00	-33.47	peak
2	7236.000	35.96	11.90	47.86	74.00	-26.14	peak

- Note:1.Result (dBuV/m) = Correct Factor (dB/m) + Reading(dBuV).
 2.Correction factor (dB/m) = Antenna Factor (dB/m) + Cable loss (dB) – Pre-Amplifier gain (dB).
 3. When the peak results are less than average limit, so not need to evaluate the average.



Standard:	FCC Part 15.247	Test Distance:	3 m
Test item:	Harmonic	Power:	DC 3.3 V
Frequency:	2437 MHz	Temp.(°C)/Hum.(%RH):	26(°C)/60 %RH
Mode:	Mode 3		
Ant.Polar.:	Horizontal		

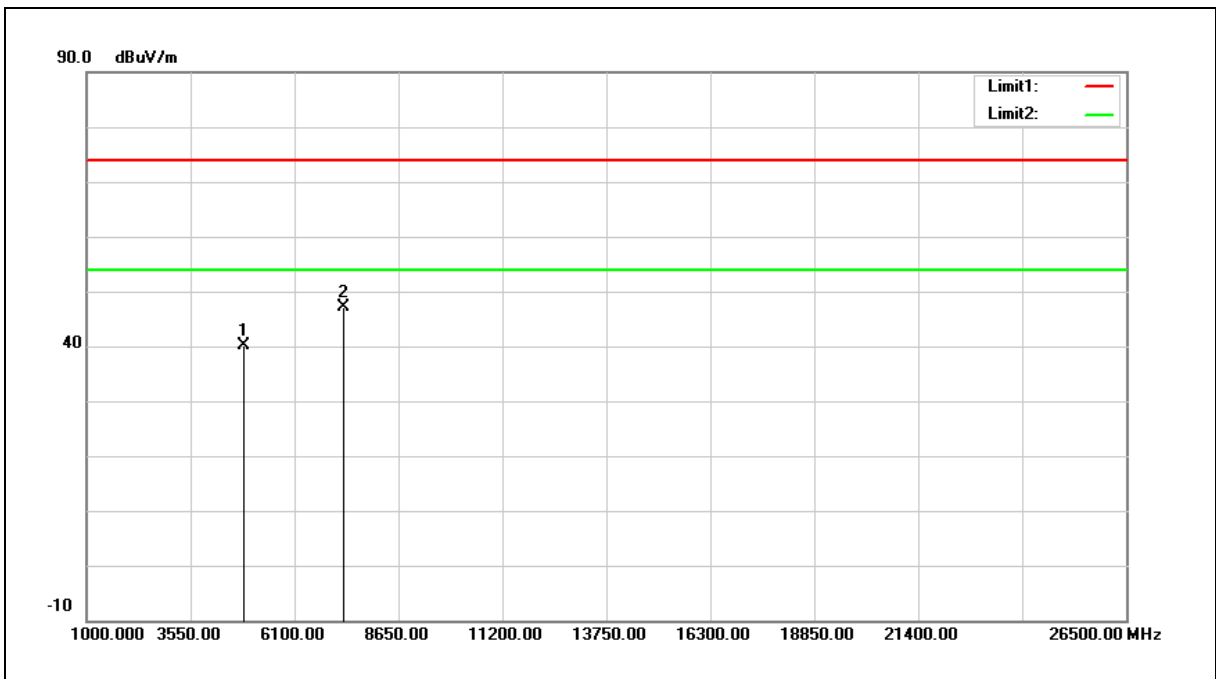

No.	Frequency (MHz)	Reading (dBuV)	Correct Factor (dB/m)	Result (dBuV/m)	Limit (dBuV/m)	Margin (dB)	Remark
1	4874.000	34.54	5.47	40.01	74.00	-33.99	peak
2	7311.000	34.95	12.13	47.08	74.00	-26.92	peak

- Note:1.Result (dBuV/m) = Correct Factor (dB/m) + Reading(dBuV).
 2.Correction factor (dB/m) = Antenna Factor (dB/m) + Cable loss (dB) – Pre-Amplifier gain (dB).
 3. When the peak results are less than average limit, so not need to evaluate the average.



Standard:	FCC Part 15.247	Test Distance:	3 m
Test item:	Harmonic	Power:	DC 3.3 V
Frequency:	2437 MHz	Temp.(°C)/Hum.(%RH):	26(°C)/60 %RH
Mode:	Mode 3		
Ant.Polar.:	Vertical		

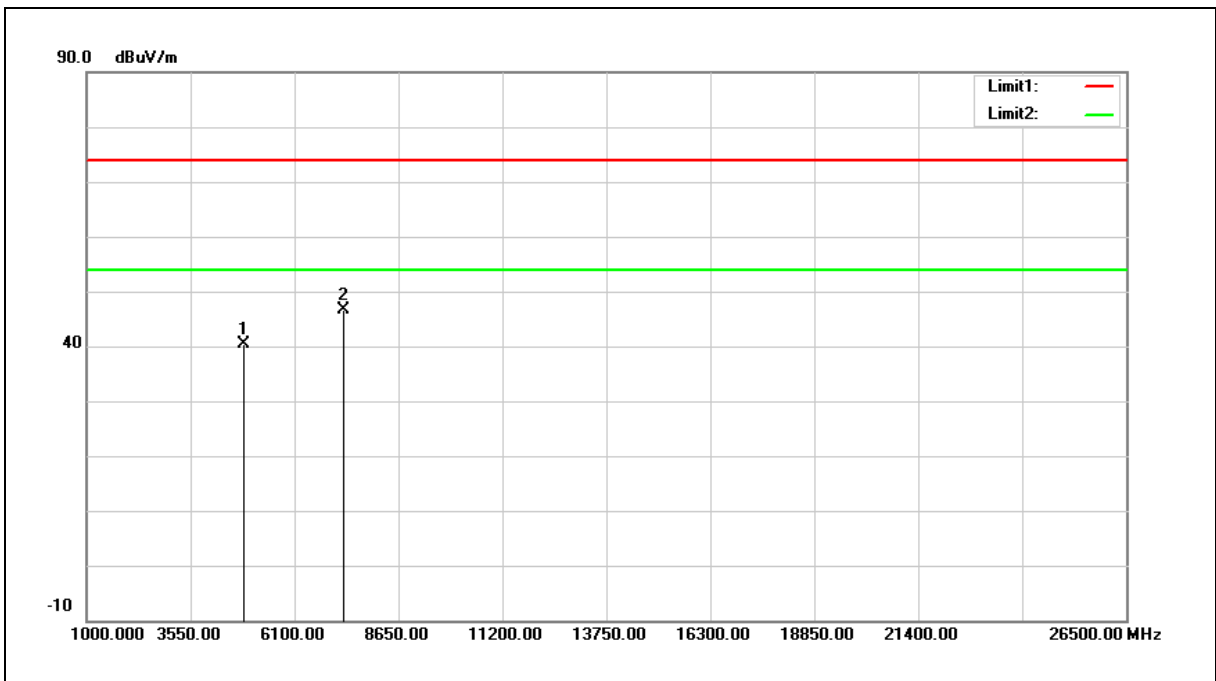

No.	Frequency (MHz)	Reading (dBuV)	Correct Factor (dB/m)	Result (dBuV/m)	Limit (dBuV/m)	Margin (dB)	Remark
1	4874.000	34.97	5.47	40.44	74.00	-33.56	peak
2	7311.000	34.57	12.13	46.70	74.00	-27.30	peak

- Note:1.Result (dBuV/m) = Correct Factor (dB/m) + Reading(dBuV).
 2.Correction factor (dB/m) = Antenna Factor (dB/m) + Cable loss (dB) – Pre-Amplifier gain (dB).
 3. When the peak results are less than average limit, so not need to evaluate the average.



Standard:	FCC Part 15.247	Test Distance:	3 m
Test item:	Harmonic	Power:	DC 3.3 V
Frequency:	2462 MHz	Temp.(°C)/Hum.(%RH):	26(°C)/60 %RH
Mode:	Mode 3		
Ant.Polar.:	Horizontal		

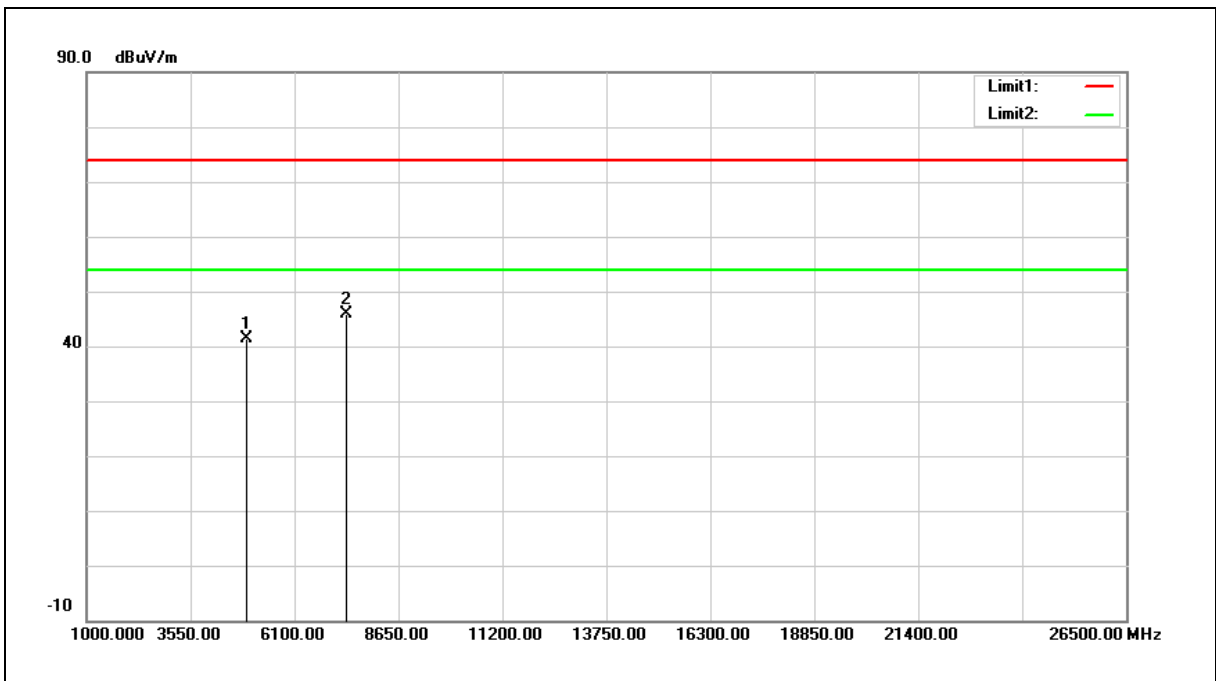

No.	Frequency (MHz)	Reading (dBuV)	Correct Factor (dB/m)	Result (dBuV/m)	Limit (dBuV/m)	Margin (dB)	Remark
1	4924.000	35.69	5.58	41.27	74.00	-32.73	peak
2	7386.000	33.48	12.36	45.84	74.00	-28.16	peak

- Note:1.Result (dBuV/m) = Correct Factor (dB/m) + Reading(dBuV).
 2.Correction factor (dB/m) = Antenna Factor (dB/m) + Cable loss (dB) – Pre-Amplifier gain (dB).
 3. When the peak results are less than average limit, so not need to evaluate the average.

Standard:	FCC Part 15.247	Test Distance:	3 m
Test item:	Harmonic	Power:	DC 3.3 V
Frequency:	2462 MHz	Temp.(°C)/Hum.(%RH):	26(°C)/60 %RH
Mode:	Mode 3		
Ant.Polar.:	Vertical		

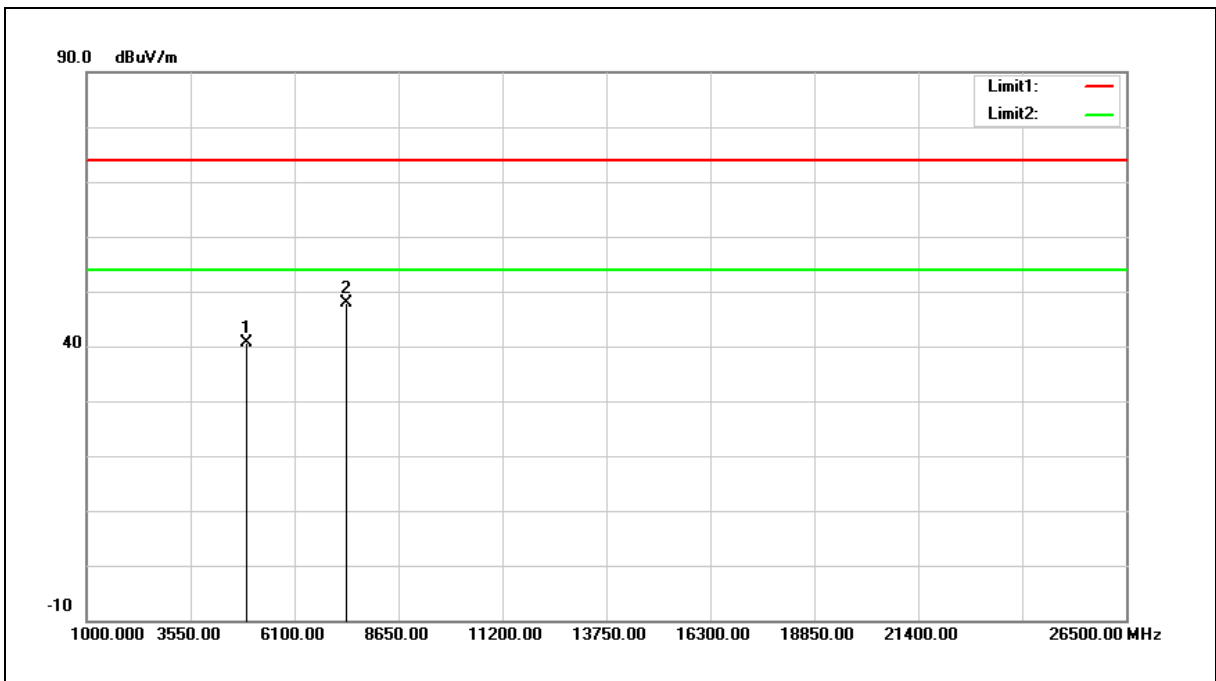

No.	Frequency (MHz)	Reading (dBuV)	Correct Factor (dB/m)	Result (dBuV/m)	Limit (dBuV/m)	Margin (dB)	Remark
1	4924.000	35.02	5.58	40.60	74.00	-33.40	peak
2	7386.000	35.46	12.36	47.82	74.00	-26.18	peak

Note:1.Result (dBuV/m) = Correct Factor (dB/m) + Reading(dBuV).

2.Correction factor (dB/m) = Antenna Factor (dB/m) + Cable loss (dB) – Pre-Amplifier gain (dB).

3. When the peak results are less than average limit, so not need to evaluate the average.



Standard:	FCC Part 15.247	Test Distance:	3 m
Test item:	Harmonic	Power:	DC 3.3 V
Frequency:	2467 MHz	Temp.(°C)/Hum.(%RH):	26(°C)/60 %RH
Mode:	Mode 3		
Ant.Polar.:	Horizontal		

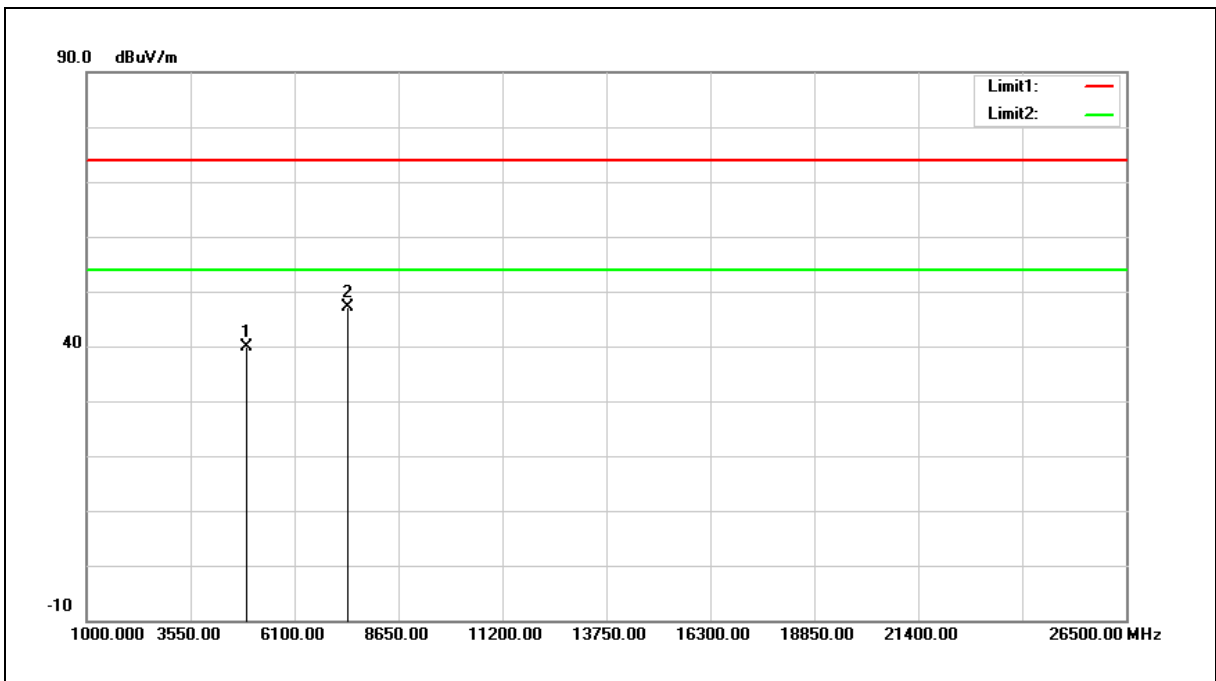

No.	Frequency (MHz)	Reading (dBuV)	Correct Factor (dB/m)	Result (dBuV/m)	Limit (dBuV/m)	Margin (dB)	Remark
1	4934.000	34.33	5.60	39.93	74.00	-34.07	peak
2	7401.000	34.66	12.40	47.06	74.00	-26.94	peak

- Note:1.Result (dBuV/m) = Correct Factor (dB/m) + Reading(dBuV).
 2.Correction factor (dB/m) = Antenna Factor (dB/m) + Cable loss (dB) – Pre-Amplifier gain (dB).
 3. When the peak results are less than average limit, so not need to evaluate the average.



Standard:	FCC Part 15.247	Test Distance:	3 m
Test item:	Harmonic	Power:	DC 3.3 V
Frequency:	2467 MHz	Temp.(°C)/Hum.(%RH):	26(°C)/60 %RH
Mode:	Mode 3		
Ant.Polar.:	Vertical		

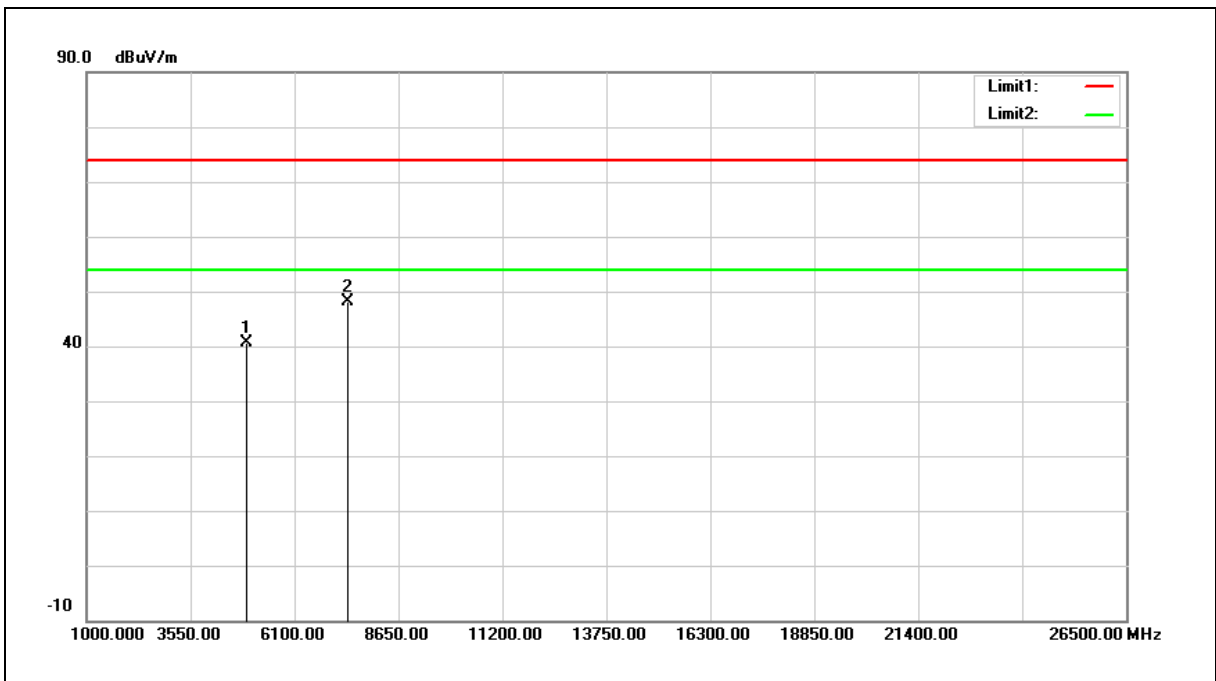

No.	Frequency (MHz)	Reading (dBuV)	Correct Factor (dB/m)	Result (dBuV/m)	Limit (dBuV/m)	Margin (dB)	Remark
1	4934.000	35.10	5.60	40.70	74.00	-33.30	peak
2	7401.000	35.69	12.40	48.09	74.00	-25.91	peak

- Note:1.Result (dBuV/m) = Correct Factor (dB/m) + Reading(dBuV).
 2.Correction factor (dB/m) = Antenna Factor (dB/m) + Cable loss (dB) – Pre-Amplifier gain (dB).
 3. When the peak results are less than average limit, so not need to evaluate the average.



Standard:	FCC Part 15.247	Test Distance:	3 m
Test item:	Harmonic	Power:	DC 3.3 V
Frequency:	2472 MHz	Temp.(°C)/Hum.(%RH):	26(°C)/60 %RH
Mode:	Mode 3		
Ant.Polar.:	Horizontal		

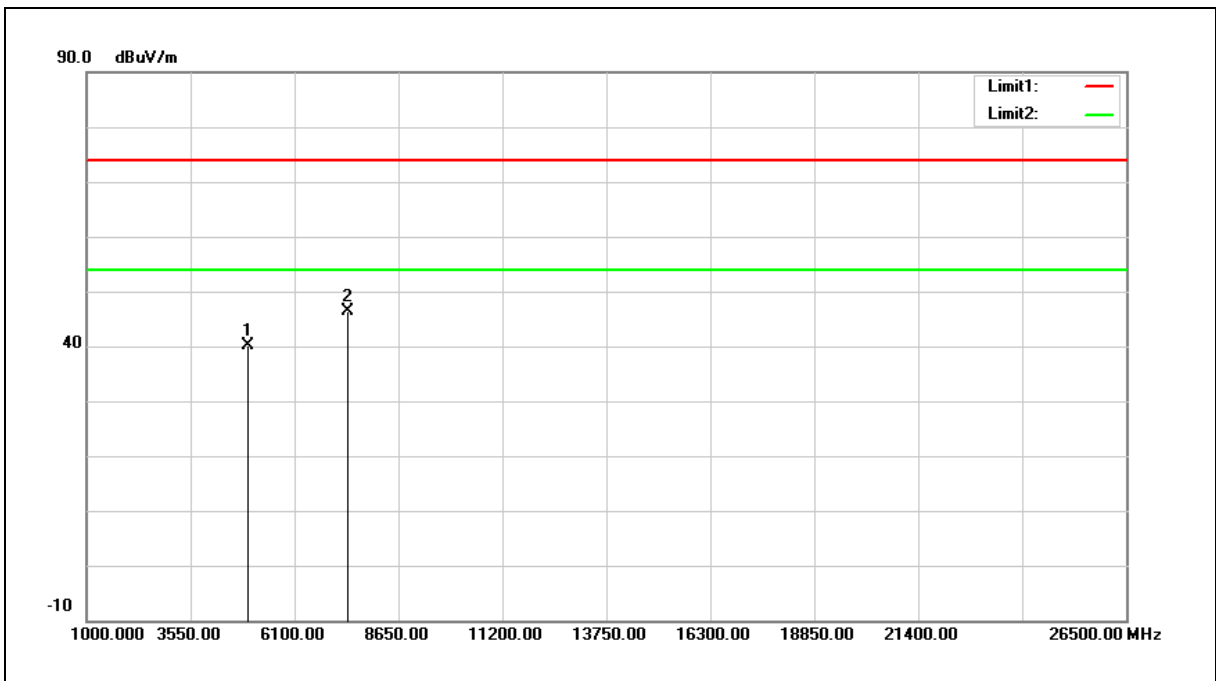

No.	Frequency (MHz)	Reading (dBuV)	Correct Factor (dB/m)	Result (dBuV/m)	Limit (dBuV/m)	Margin (dB)	Remark
1	4944.000	34.63	5.62	40.25	74.00	-33.75	peak
2	7416.000	34.05	12.45	46.50	74.00	-27.50	peak

- Note:1.Result (dBuV/m) = Correct Factor (dB/m) + Reading(dBuV).
 2.Correction factor (dB/m) = Antenna Factor (dB/m) + Cable loss (dB) – Pre-Amplifier gain (dB).
 3. When the peak results are less than average limit, so not need to evaluate the average.



Standard:	FCC Part 15.247	Test Distance:	3 m
Test item:	Harmonic	Power:	DC 3.3 V
Frequency:	2472 MHz	Temp.(°C)/Hum.(%RH):	26(°C)/60 %RH
Mode:	Mode 3		
Ant.Polar.:	Vertical		

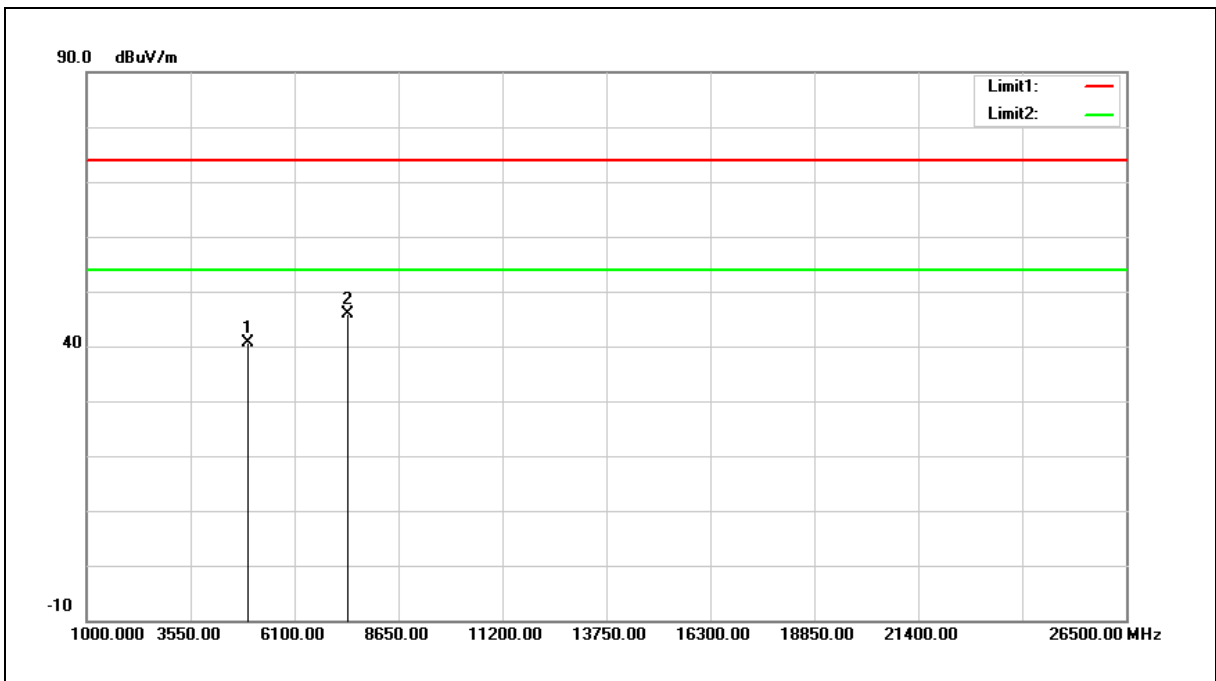

No.	Frequency (MHz)	Reading (dBuV)	Correct Factor (dB/m)	Result (dBuV/m)	Limit (dBuV/m)	Margin (dB)	Remark
1	4944.000	34.97	5.62	40.59	74.00	-33.41	peak
2	7416.000	33.54	12.45	45.99	74.00	-28.01	peak

- Note:1.Result (dBuV/m) = Correct Factor (dB/m) + Reading(dBuV).
 2.Correction factor (dB/m) = Antenna Factor (dB/m) + Cable loss (dB) – Pre-Amplifier gain (dB).
 3. When the peak results are less than average limit, so not need to evaluate the average.

MIMO A+B

Standard:	FCC Part 15.247	Test Distance:	3 m
Test item:	Harmonic	Power:	DC 3.3 V
Frequency:	2412 MHz	Temp.(°C)/Hum.(%RH):	26(°C)/60 %RH
Mode:	Mode 4		
Ant.Polar.:	Horizontal		

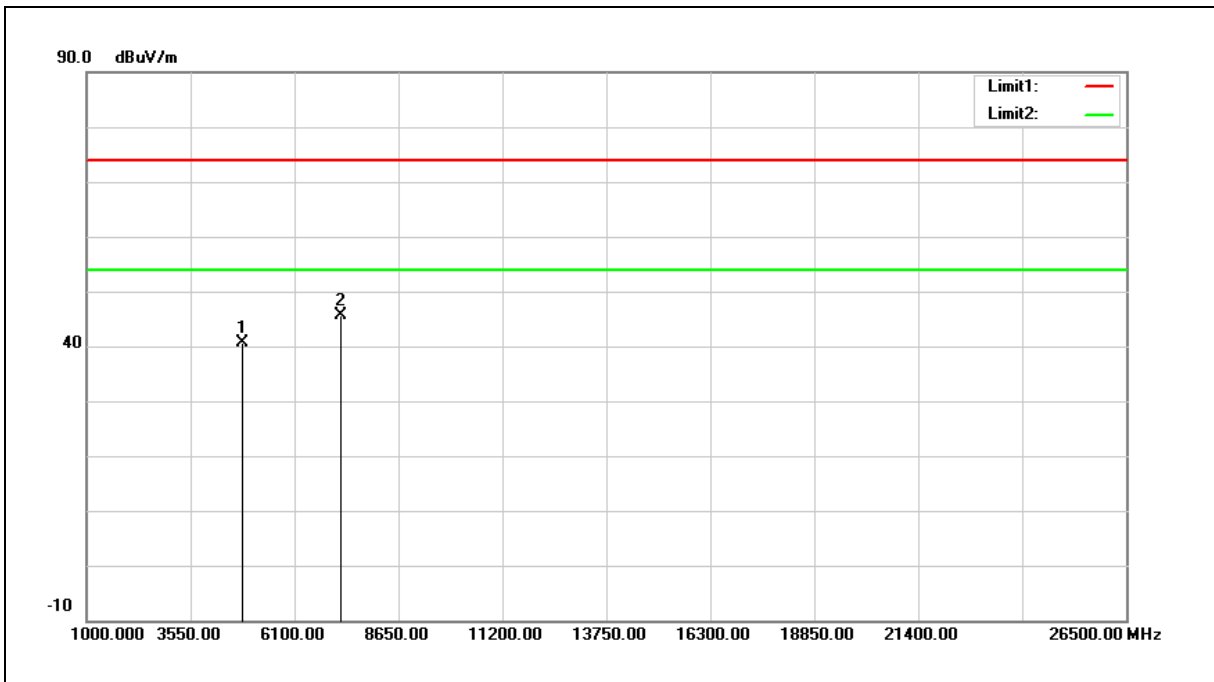

No.	Frequency (MHz)	Reading (dBuV)	Correct Factor (dB/m)	Result (dBuV/m)	Limit (dBuV/m)	Margin (dB)	Remark
1	4824.000	35.20	5.37	40.57	74.00	-33.43	peak
2	7236.000	33.72	11.90	45.62	74.00	-28.38	peak

Note:1.Result (dBuV/m) = Correct Factor (dB/m) + Reading(dBuV).

2.Correction factor (dB/m) = Antenna Factor (dB/m) + Cable loss (dB) – Pre-Amplifier gain (dB).

3. When the peak results are less than average limit, so not need to evaluate the average.



Standard:	FCC Part 15.247	Test Distance:	3 m
Test item:	Harmonic	Power:	DC 3.3 V
Frequency:	2412 MHz	Temp.(°C)/Hum.(%RH):	26(°C)/60 %RH
Mode:	Mode 4		
Ant.Polar.:	Vertical		

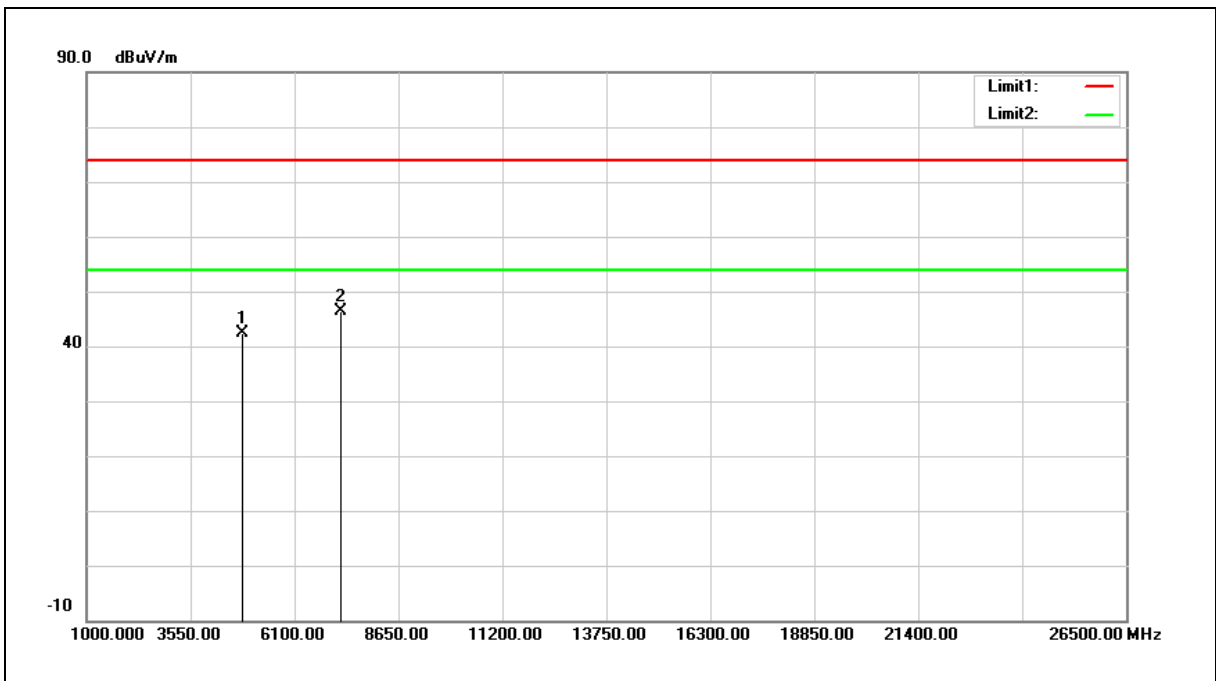

No.	Frequency (MHz)	Reading (dBuV)	Correct Factor (dB/m)	Result (dBuV/m)	Limit (dBuV/m)	Margin (dB)	Remark
1	4824.000	37.06	5.37	42.43	74.00	-31.57	peak
2	7236.000	34.52	11.90	46.42	74.00	-27.58	peak

Note:1.Result (dBuV/m) = Correct Factor (dB/m) + Reading(dBuV).

2.Correction factor (dB/m) = Antenna Factor (dB/m) + Cable loss (dB) – Pre-Amplifier gain (dB).

3. When the peak results are less than average limit, so not need to evaluate the average.



Standard:	FCC Part 15.247	Test Distance:	3 m
Test item:	Harmonic	Power:	DC 3.3 V
Frequency:	2437 MHz	Temp.(°C)/Hum.(%RH):	26(°C)/60 %RH
Mode:	Mode 4		
Ant.Polar.:	Horizontal		

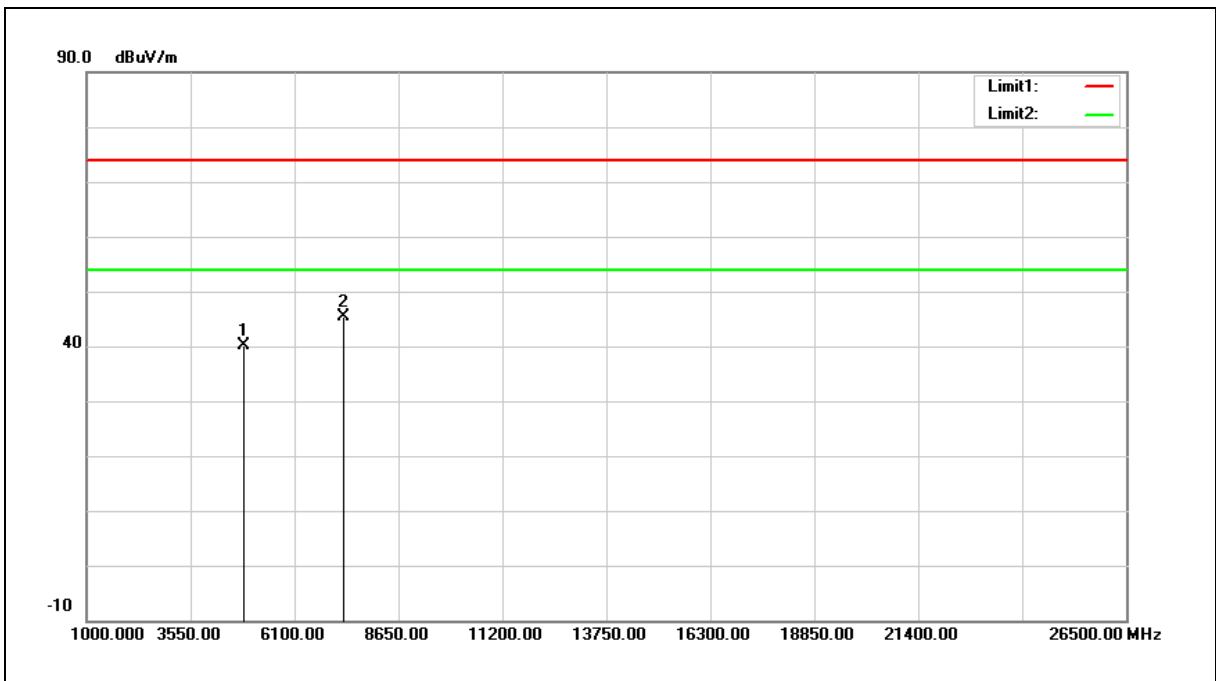

No.	Frequency (MHz)	Reading (dBuV)	Correct Factor (dB/m)	Result (dBuV/m)	Limit (dBuV/m)	Margin (dB)	Remark
1	4874.000	34.57	5.47	40.04	74.00	-33.96	peak
2	7311.000	33.29	12.13	45.42	74.00	-28.58	peak

- Note:1.Result (dBuV/m) = Correct Factor (dB/m) + Reading(dBuV).
 2.Correction factor (dB/m) = Antenna Factor (dB/m) + Cable loss (dB) – Pre-Amplifier gain (dB).
 3. When the peak results are less than average limit, so not need to evaluate the average.



Standard:	FCC Part 15.247	Test Distance:	3 m
Test item:	Harmonic	Power:	DC 3.3 V
Frequency:	2437 MHz	Temp.(°C)/Hum.(%RH):	26(°C)/60 %RH
Mode:	Mode 4		
Ant.Polar.:	Vertical		

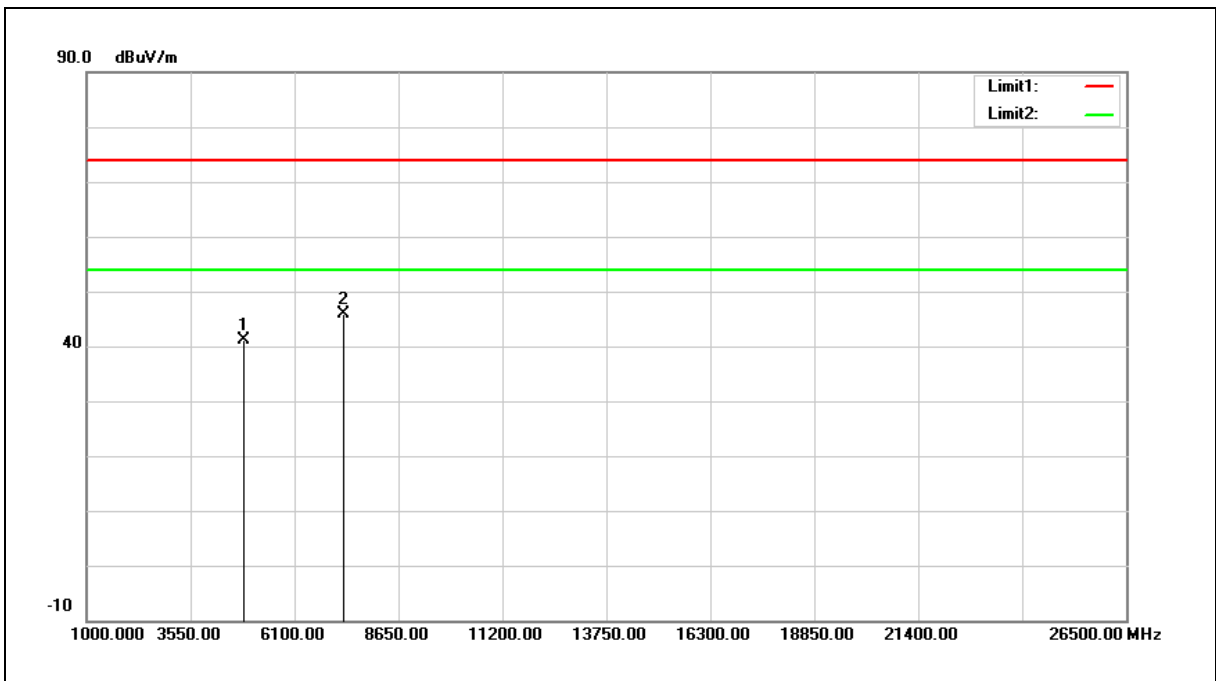

No.	Frequency (MHz)	Reading (dBuV)	Correct Factor (dB/m)	Result (dBuV/m)	Limit (dBuV/m)	Margin (dB)	Remark
1	4874.000	35.71	5.47	41.18	74.00	-32.82	peak
2	7311.000	33.82	12.13	45.95	74.00	-28.05	peak

- Note:1.Result (dBuV/m) = Correct Factor (dB/m) + Reading(dBuV).
 2.Correction factor (dB/m) = Antenna Factor (dB/m) + Cable loss (dB) – Pre-Amplifier gain (dB).
 3. When the peak results are less than average limit, so not need to evaluate the average.



Standard:	FCC Part 15.247	Test Distance:	3 m
Test item:	Harmonic	Power:	DC 3.3 V
Frequency:	2462 MHz	Temp.(°C)/Hum.(%RH):	26(°C)/60 %RH
Mode:	Mode 4		
Ant.Polar.:	Horizontal		

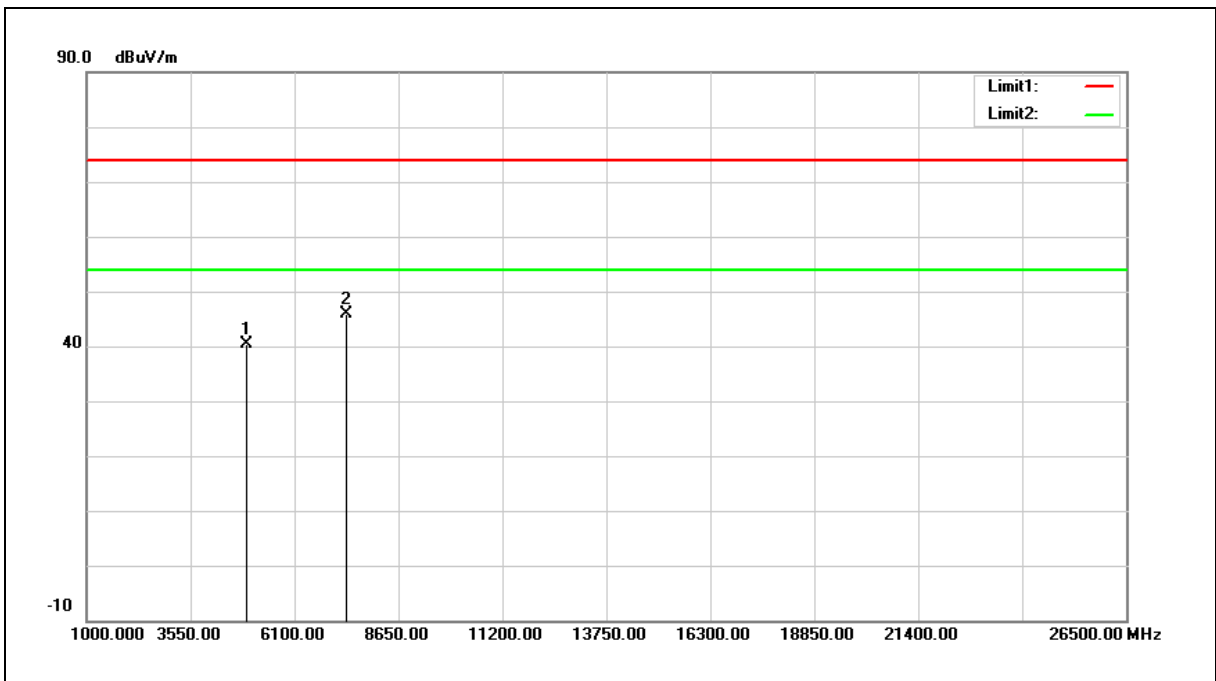

No.	Frequency (MHz)	Reading (dBuV)	Correct Factor (dB/m)	Result (dBuV/m)	Limit (dBuV/m)	Margin (dB)	Remark
1	4924.000	34.89	5.58	40.47	74.00	-33.53	peak
2	7386.000	33.50	12.36	45.86	74.00	-28.14	peak

Note:1.Result (dBuV/m) = Correct Factor (dB/m) + Reading(dBuV).

2.Correction factor (dB/m) = Antenna Factor (dB/m) + Cable loss (dB) – Pre-Amplifier gain (dB).

3. When the peak results are less than average limit, so not need to evaluate the average.



Standard:	FCC Part 15.247	Test Distance:	3 m
Test item:	Harmonic	Power:	DC 3.3 V
Frequency:	2462 MHz	Temp.(°C)/Hum.(%RH):	26(°C)/60 %RH
Mode:	Mode 4		
Ant.Polar.:	Vertical		

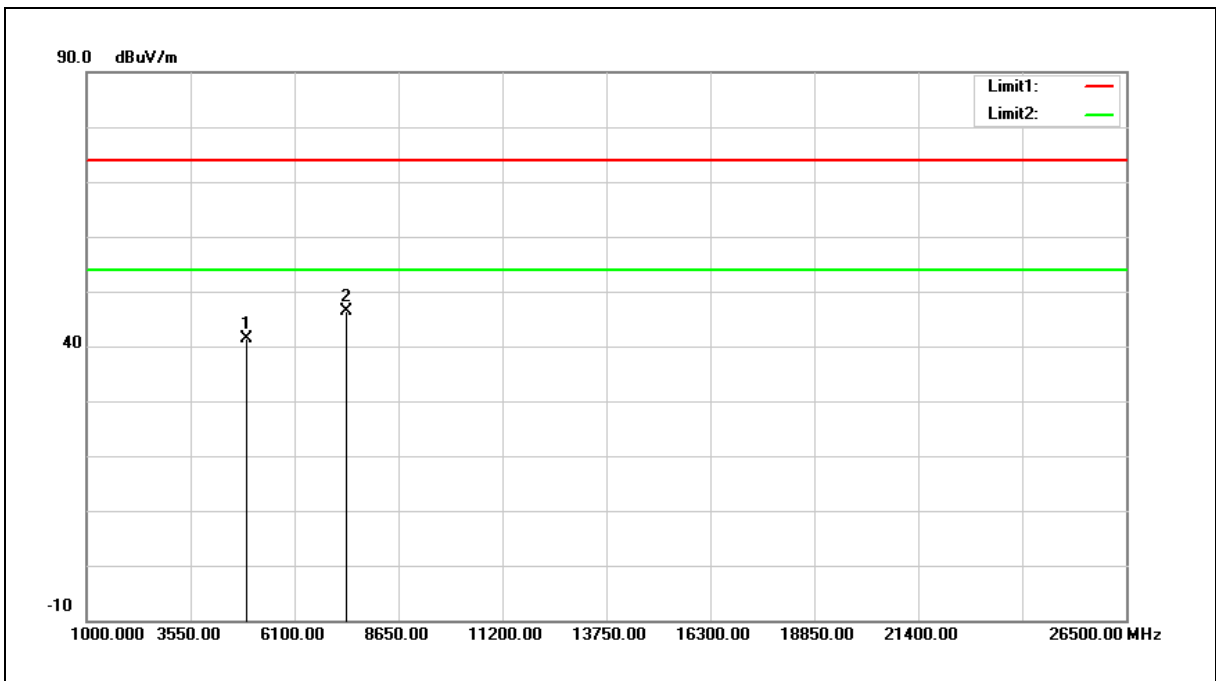

No.	Frequency (MHz)	Reading (dBuV)	Correct Factor (dB/m)	Result (dBuV/m)	Limit (dBuV/m)	Margin (dB)	Remark
1	4924.000	35.89	5.58	41.47	74.00	-32.53	peak
2	7386.000	34.02	12.36	46.38	74.00	-27.62	peak

- Note:1.Result (dBuV/m) = Correct Factor (dB/m) + Reading(dBuV).
 2.Correction factor (dB/m) = Antenna Factor (dB/m) + Cable loss (dB) – Pre-Amplifier gain (dB).
 3. When the peak results are less than average limit, so not need to evaluate the average.



Standard:	FCC Part 15.247	Test Distance:	3 m
Test item:	Harmonic	Power:	DC 3.3 V
Frequency:	2467 MHz	Temp.(°C)/Hum.(%RH):	26(°C)/60 %RH
Mode:	Mode 4		
Ant.Polar.:	Horizontal		

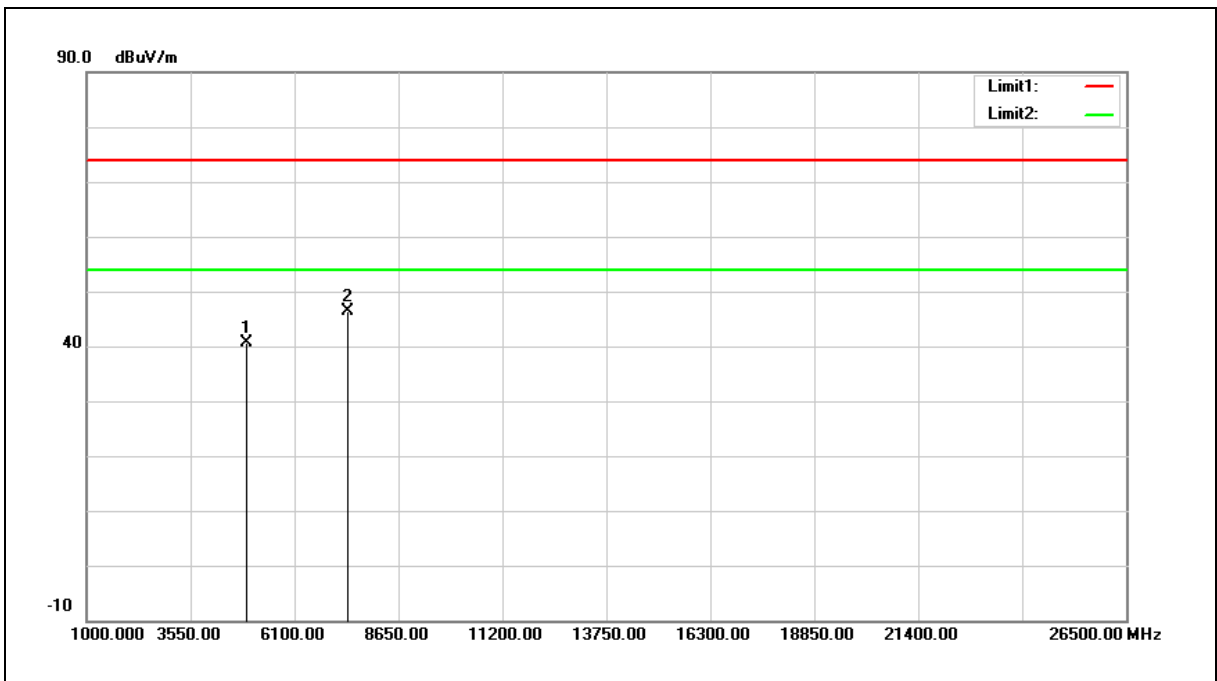

No.	Frequency (MHz)	Reading (dBuV)	Correct Factor (dB/m)	Result (dBuV/m)	Limit (dBuV/m)	Margin (dB)	Remark
1	4934.000	34.94	5.60	40.54	74.00	-33.46	peak
2	7401.000	33.88	12.40	46.28	74.00	-27.72	peak

- Note:1.Result (dBuV/m) = Correct Factor (dB/m) + Reading(dBuV).
 2.Correction factor (dB/m) = Antenna Factor (dB/m) + Cable loss (dB) – Pre-Amplifier gain (dB).
 3. When the peak results are less than average limit, so not need to evaluate the average.



Standard:	FCC Part 15.247	Test Distance:	3 m
Test item:	Harmonic	Power:	DC 3.3 V
Frequency:	2467 MHz	Temp.(°C)/Hum.(%RH):	26(°C)/60 %RH
Mode:	Mode 4		
Ant.Polar.:	Vertical		

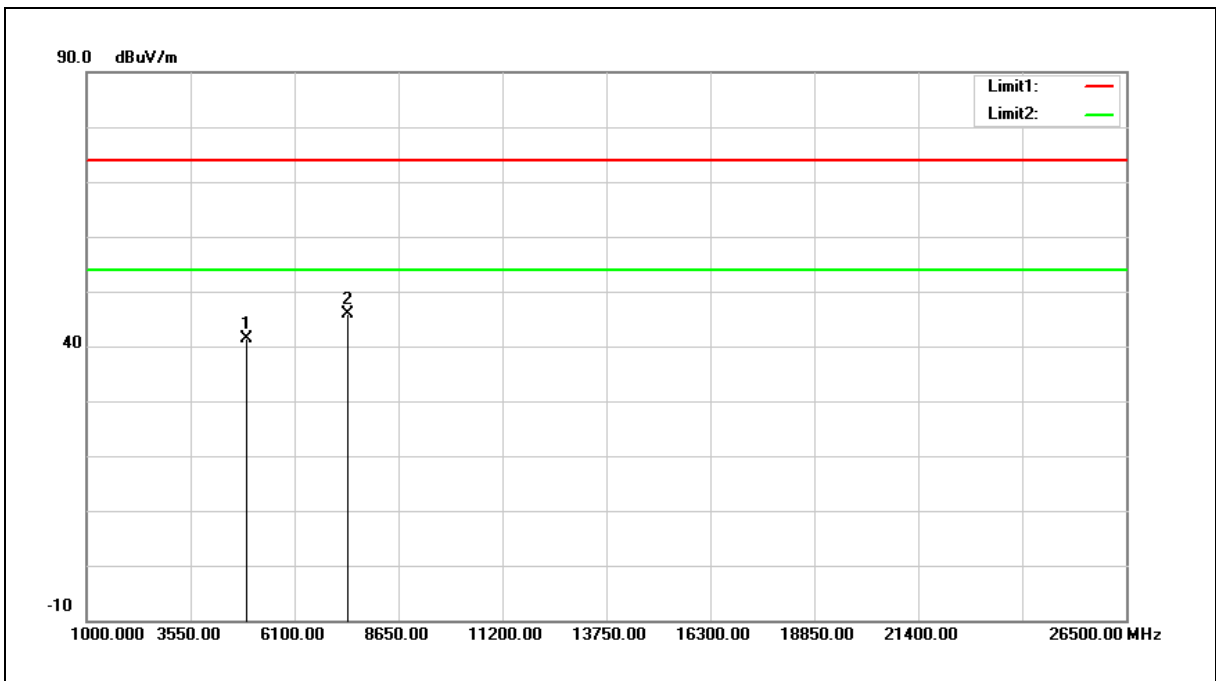

No.	Frequency (MHz)	Reading (dBuV)	Correct Factor (dB/m)	Result (dBuV/m)	Limit (dBuV/m)	Margin (dB)	Remark
1	4934.000	35.71	5.60	41.31	74.00	-32.69	peak
2	7401.000	33.59	12.40	45.99	74.00	-28.01	peak

- Note:1.Result (dBuV/m) = Correct Factor (dB/m) + Reading(dBuV).
 2.Correction factor (dB/m) = Antenna Factor (dB/m) + Cable loss (dB) – Pre-Amplifier gain (dB).
 3. When the peak results are less than average limit, so not need to evaluate the average.



Standard:	FCC Part 15.247	Test Distance:	3 m
Test item:	Harmonic	Power:	DC 3.3 V
Frequency:	2472 MHz	Temp.(°C)/Hum.(%RH):	26(°C)/60 %RH
Mode:	Mode 4		
Ant.Polar.:	Horizontal		

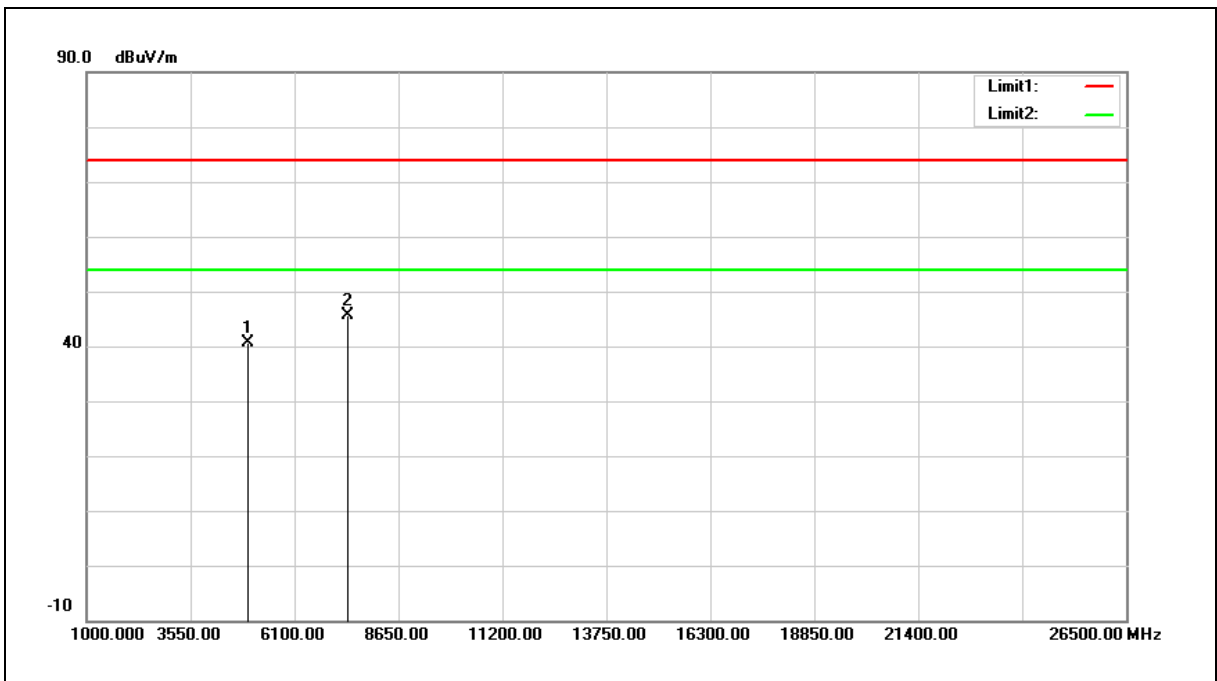

No.	Frequency (MHz)	Reading (dBuV)	Correct Factor (dB/m)	Result (dBuV/m)	Limit (dBuV/m)	Margin (dB)	Remark
1	4944.000	34.94	5.62	40.56	74.00	-33.44	peak
2	7416.000	33.08	12.45	45.53	74.00	-28.47	peak

- Note:1.Result (dBuV/m) = Correct Factor (dB/m) + Reading(dBuV).
 2.Correction factor (dB/m) = Antenna Factor (dB/m) + Cable loss (dB) – Pre-Amplifier gain (dB).
 3. When the peak results are less than average limit, so not need to evaluate the average.

Standard:	FCC Part 15.247	Test Distance:	3 m
Test item:	Harmonic	Power:	DC 3.3 V
Frequency:	2472 MHz	Temp.(°C)/Hum.(%RH):	26(°C)/60 %RH
Mode:	Mode 4		
Ant.Polar.:	Vertical		

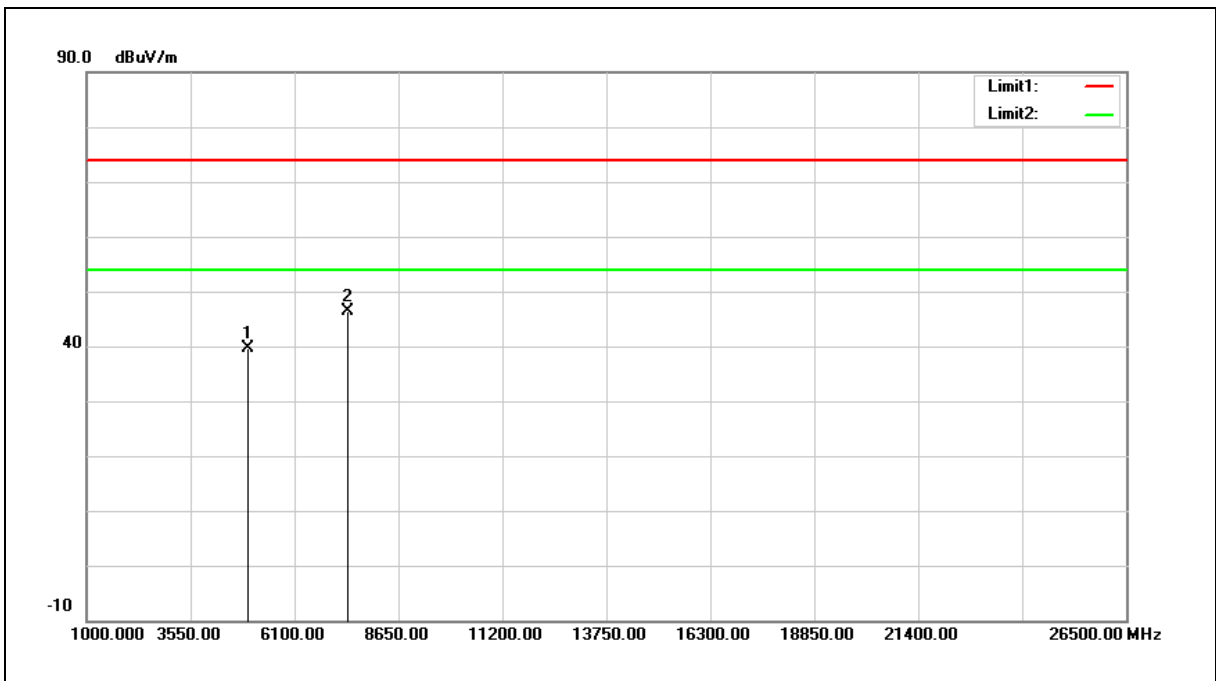

No.	Frequency (MHz)	Reading (dBuV)	Correct Factor (dB/m)	Result (dBuV/m)	Limit (dBuV/m)	Margin (dB)	Remark
1	4944.000	33.90	5.62	39.52	74.00	-34.48	peak
2	7416.000	33.98	12.45	46.43	74.00	-27.57	peak

Note:1.Result (dBuV/m) = Correct Factor (dB/m) + Reading(dBuV).

2.Correction factor (dB/m) = Antenna Factor (dB/m) + Cable loss (dB) – Pre-Amplifier gain (dB).

3. When the peak results are less than average limit, so not need to evaluate the average.



Standard:	FCC Part 15.247	Test Distance:	3 m
Test item:	Harmonic	Power:	DC 3.3 V
Frequency:	2422 MHz	Temp.(°C)/Hum.(%RH):	26(°C)/60 %RH
Mode:	Mode 5		
Ant.Polar.:	Horizontal		

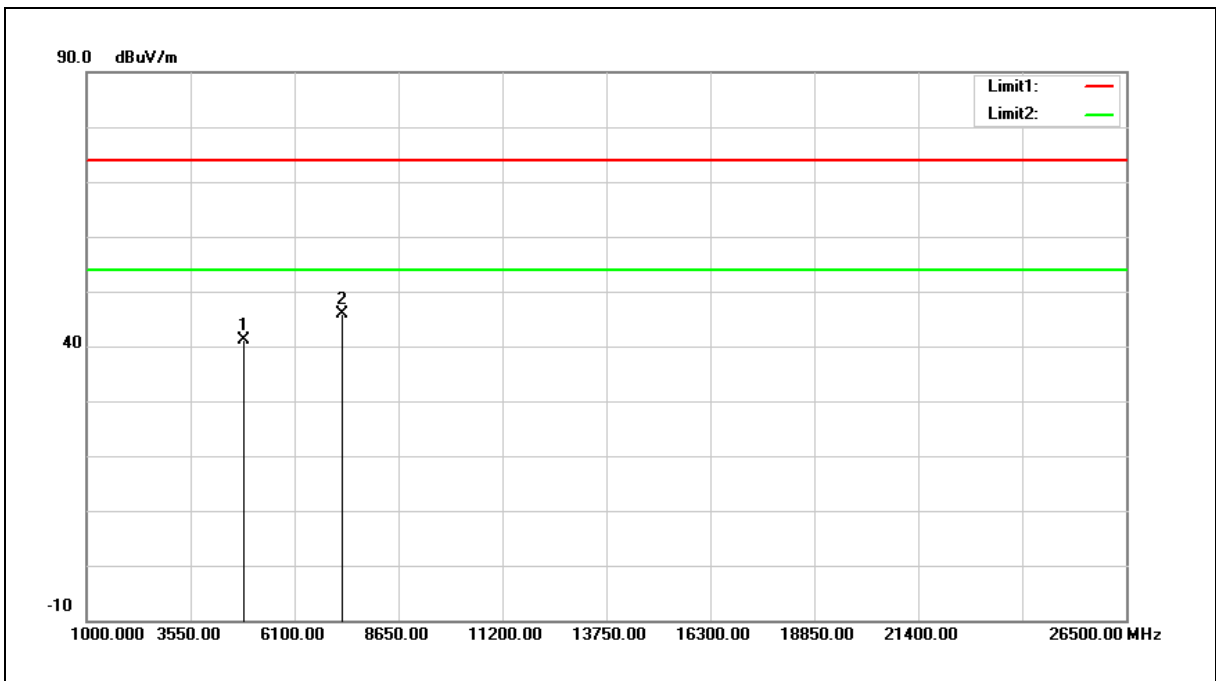

No.	Frequency (MHz)	Reading (dBuV)	Correct Factor (dB/m)	Result (dBuV/m)	Limit (dBuV/m)	Margin (dB)	Remark
1	4844.000	35.70	5.42	41.12	74.00	-32.88	peak
2	7266.000	33.99	11.98	45.97	74.00	-28.03	peak

- Note:1.Result (dBuV/m) = Correct Factor (dB/m) + Reading(dBuV).
 2.Correction factor (dB/m) = Antenna Factor (dB/m) + Cable loss (dB) – Pre-Amplifier gain (dB).
 3. When the peak results are less than average limit, so not need to evaluate the average.



Standard:	FCC Part 15.247	Test Distance:	3 m
Test item:	Harmonic	Power:	DC 3.3 V
Frequency:	2422 MHz	Temp.(°C)/Hum.(%RH):	26(°C)/60 %RH
Mode:	Mode 5		
Ant.Polar.:	Vertical		

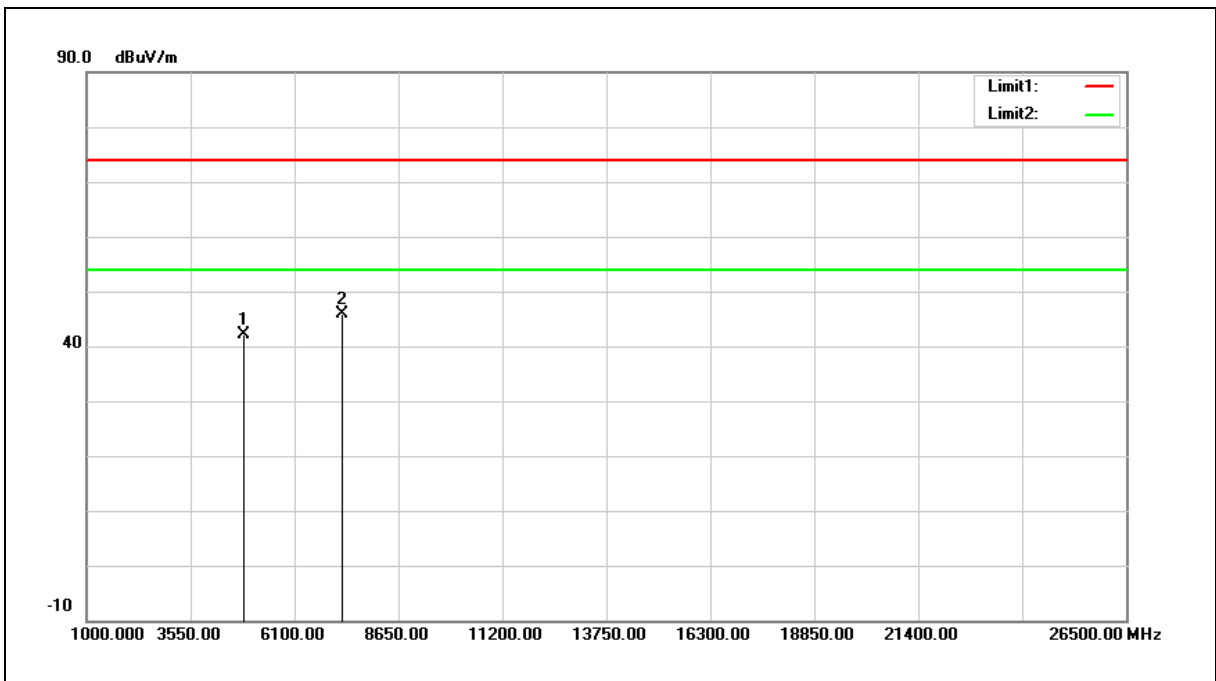

No.	Frequency (MHz)	Reading (dBuV)	Correct Factor (dB/m)	Result (dBuV/m)	Limit (dBuV/m)	Margin (dB)	Remark
1	4844.000	36.60	5.42	42.02	74.00	-31.98	peak
2	7266.000	33.81	11.98	45.79	74.00	-28.21	peak

Note:1.Result (dBuV/m) = Correct Factor (dB/m) + Reading(dBuV).

2.Correction factor (dB/m) = Antenna Factor (dB/m) + Cable loss (dB) – Pre-Amplifier gain (dB).

3. When the peak results are less than average limit, so not need to evaluate the average.



Standard:	FCC Part 15.247	Test Distance:	3 m
Test item:	Harmonic	Power:	DC 3.3 V
Frequency:	2437 MHz	Temp.(°C)/Hum.(%RH):	26(°C)/60 %RH
Mode:	Mode 5		
Ant.Polar.:	Horizontal		

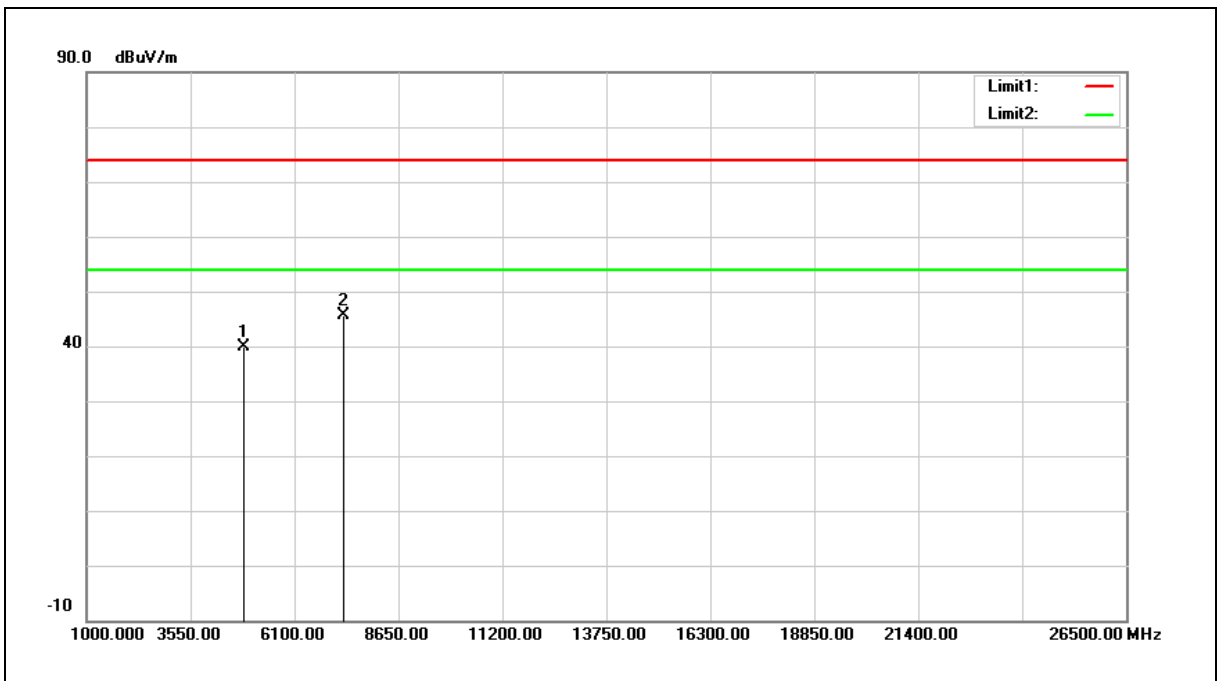

No.	Frequency (MHz)	Reading (dBuV)	Correct Factor (dB/m)	Result (dBuV/m)	Limit (dBuV/m)	Margin (dB)	Remark
1	4874.000	34.33	5.47	39.80	74.00	-34.20	peak
2	7311.000	33.39	12.13	45.52	74.00	-28.48	peak

Note:1.Result (dBuV/m) = Correct Factor (dB/m) + Reading(dBuV).

2.Correction factor (dB/m) = Antenna Factor (dB/m) + Cable loss (dB) – Pre-Amplifier gain (dB).

3. When the peak results are less than average limit, so not need to evaluate the average.



Standard:	FCC Part 15.247	Test Distance:	3 m
Test item:	Harmonic	Power:	DC 3.3 V
Frequency:	2437 MHz	Temp.(°C)/Hum.(%RH):	26(°C)/60 %RH
Mode:	Mode 5		
Ant.Polar.:	Vertical		

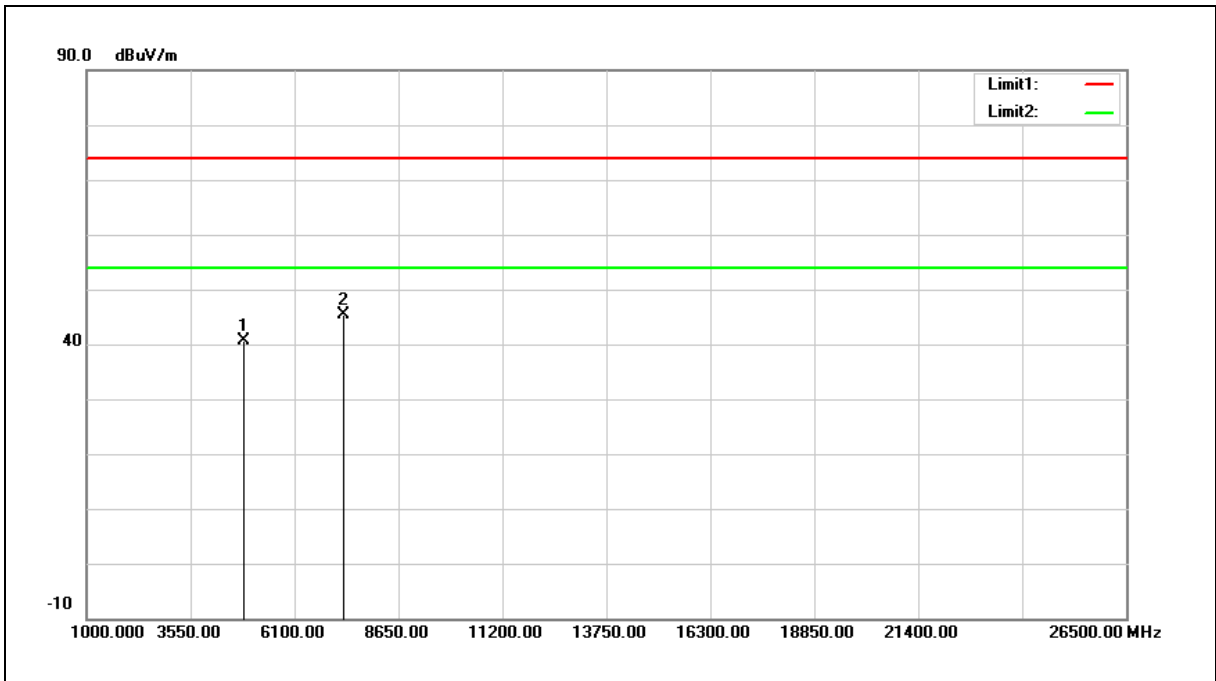

No.	Frequency (MHz)	Reading (dBuV)	Correct Factor (dB/m)	Result (dBuV/m)	Limit (dBuV/m)	Margin (dB)	Remark
1	4874.000	35.19	5.47	40.66	74.00	-33.34	peak
2	7311.000	33.31	12.13	45.44	74.00	-28.56	peak

- Note:1.Result (dBuV/m) = Correct Factor (dB/m) + Reading(dBuV).
 2.Correction factor (dB/m) = Antenna Factor (dB/m) + Cable loss (dB) – Pre-Amplifier gain (dB).
 3. When the peak results are less than average limit, so not need to evaluate the average.



Standard:	FCC Part 15.247	Test Distance:	3 m
Test item:	Harmonic	Power:	DC 3.3 V
Frequency:	2452 MHz	Temp.(°C)/Hum.(%RH):	26(°C)/60 %RH
Mode:	Mode 5		
Ant.Polar.:	Horizontal		

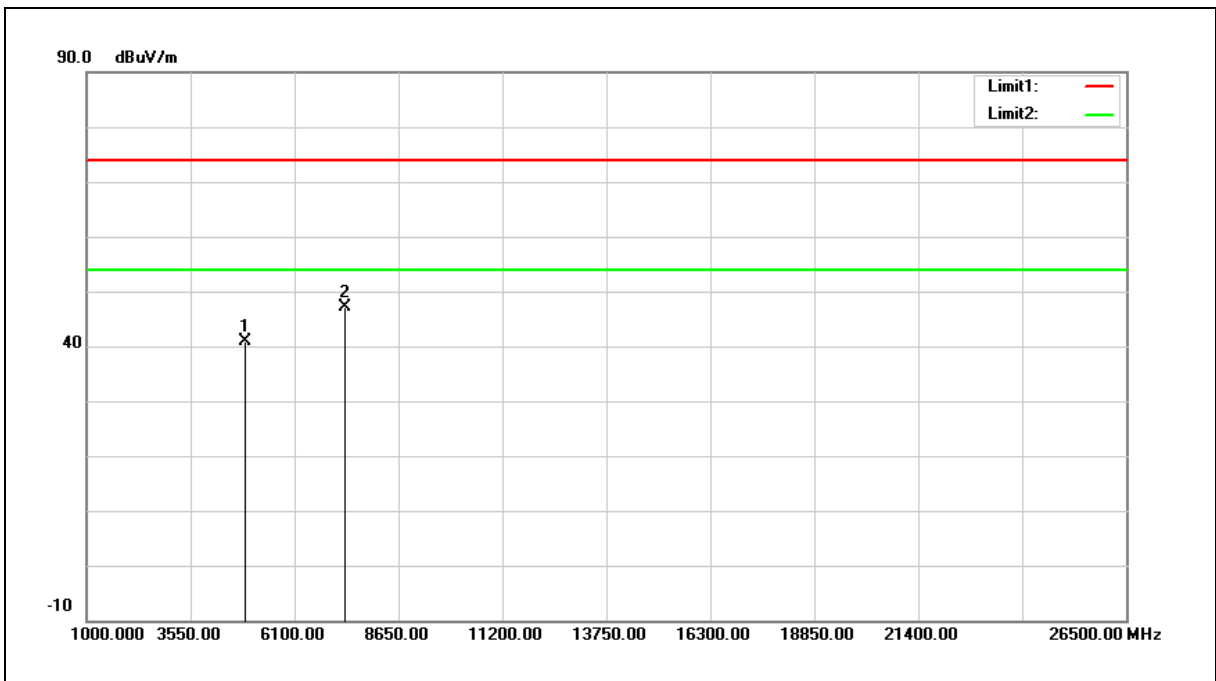

No.	Frequency (MHz)	Reading (dBuV)	Correct Factor (dB/m)	Result (dBuV/m)	Limit (dBuV/m)	Margin (dB)	Remark
1	4904.000	35.37	5.54	40.91	74.00	-33.09	peak
2	7356.000	34.90	12.25	47.15	74.00	-26.85	peak

- Note:1.Result (dBuV/m) = Correct Factor (dB/m) + Reading(dBuV).
 2.Correction factor (dB/m) = Antenna Factor (dB/m) + Cable loss (dB) – Pre-Amplifier gain (dB).
 3. When the peak results are less than average limit, so not need to evaluate the average.



Standard:	FCC Part 15.247	Test Distance:	3 m
Test item:	Harmonic	Power:	DC 3.3 V
Frequency:	2452 MHz	Temp.(°C)/Hum.(%RH):	26(°C)/60 %RH
Mode:	Mode 5		
Ant.Polar.:	Vertical		

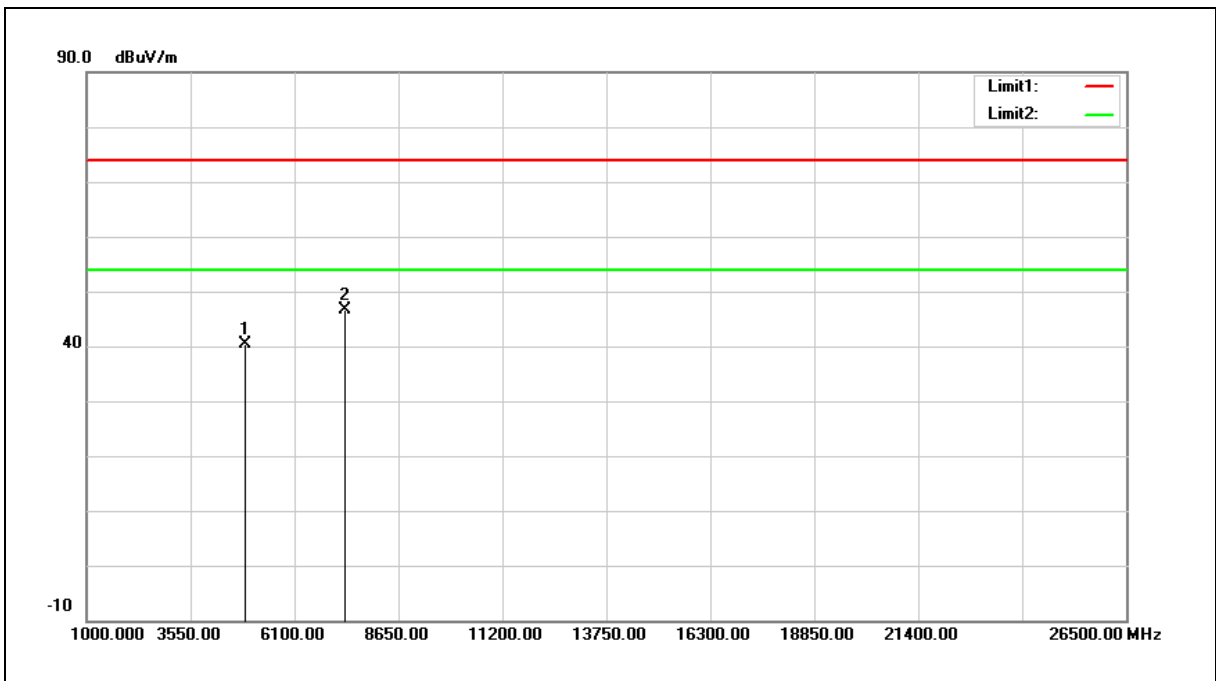

No.	Frequency (MHz)	Reading (dBuV)	Correct Factor (dB/m)	Result (dBuV/m)	Limit (dBuV/m)	Margin (dB)	Remark
1	4904.000	34.95	5.54	40.49	74.00	-33.51	peak
2	7356.000	34.45	12.25	46.70	74.00	-27.30	peak

Note:1.Result (dBuV/m) = Correct Factor (dB/m) + Reading(dBuV).

2.Correction factor (dB/m) = Antenna Factor (dB/m) + Cable loss (dB) – Pre-Amplifier gain (dB).

3. When the peak results are less than average limit, so not need to evaluate the average.



Standard:	FCC Part 15.247	Test Distance:	3 m
Test item:	Harmonic	Power:	DC 3.3 V
Frequency:	2457 MHz	Temp.(°C)/Hum.(%RH):	26(°C)/60 %RH
Mode:	Mode 5		
Ant.Polar.:	Horizontal		

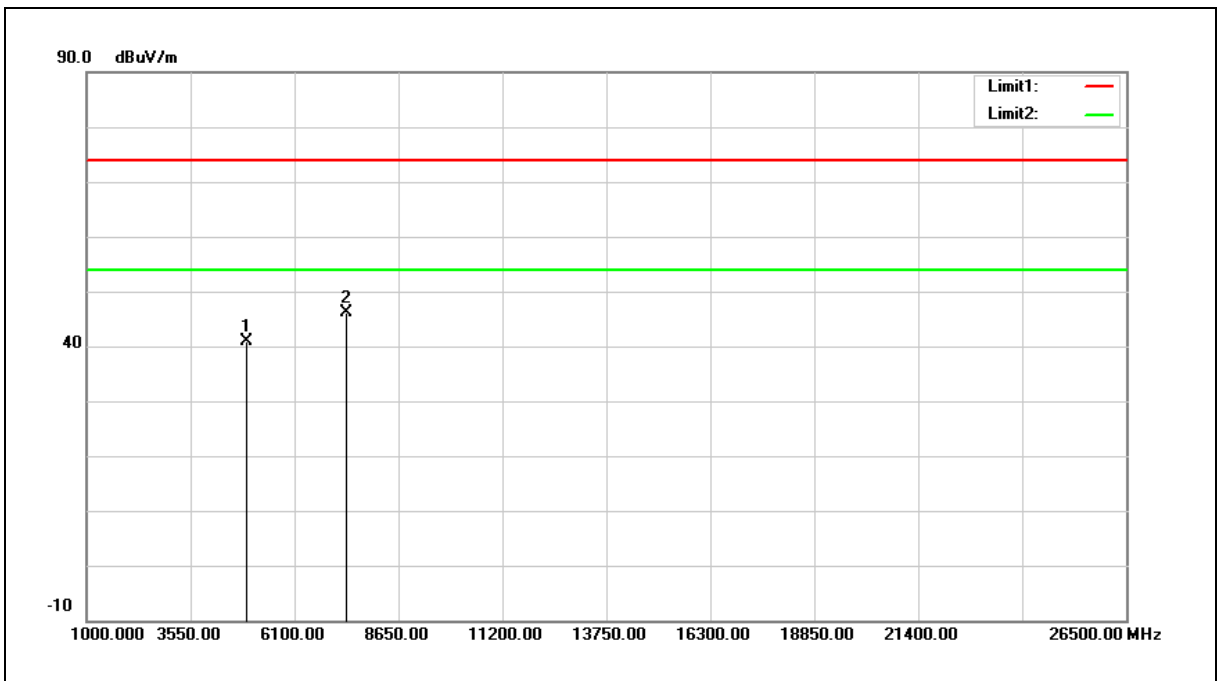

No.	Frequency (MHz)	Reading (dBuV)	Correct Factor (dB/m)	Result (dBuV/m)	Limit (dBuV/m)	Margin (dB)	Remark
1	4914.000	35.29	5.56	40.85	74.00	-33.15	peak
2	7371.000	33.76	12.31	46.07	74.00	-27.93	peak

Note:1.Result (dBuV/m) = Correct Factor (dB/m) + Reading(dBuV).

2.Correction factor (dB/m) = Antenna Factor (dB/m) + Cable loss (dB) – Pre-Amplifier gain (dB).

3. When the peak results are less than average limit, so not need to evaluate the average.



Standard:	FCC Part 15.247	Test Distance:	3 m
Test item:	Harmonic	Power:	DC 3.3 V
Frequency:	2457 MHz	Temp.(°C)/Hum.(%RH):	26(°C)/60 %RH
Mode:	Mode 5		
Ant.Polar.:	Vertical		

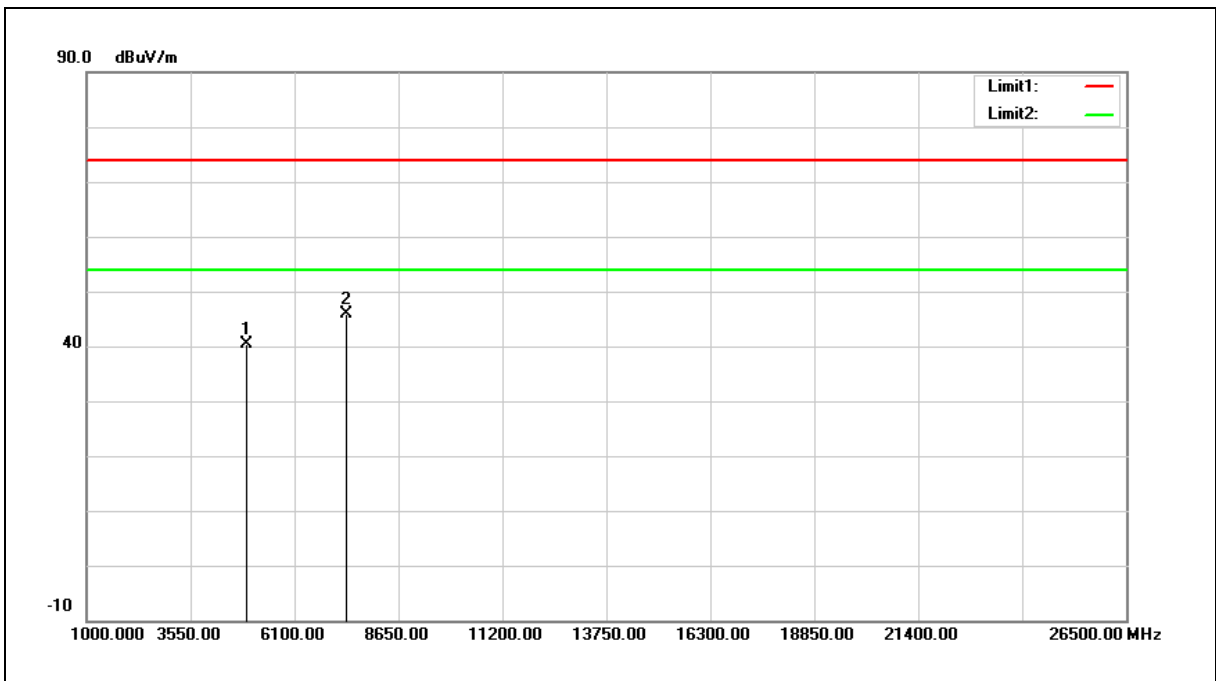

No.	Frequency (MHz)	Reading (dBuV)	Correct Factor (dB/m)	Result (dBuV/m)	Limit (dBuV/m)	Margin (dB)	Remark
1	4914.000	34.92	5.56	40.48	74.00	-33.52	peak
2	7371.000	33.48	12.31	45.79	74.00	-28.21	peak

- Note:1.Result (dBuV/m) = Correct Factor (dB/m) + Reading(dBuV).
 2.Correction factor (dB/m) = Antenna Factor (dB/m) + Cable loss (dB) – Pre-Amplifier gain (dB).
 3. When the peak results are less than average limit, so not need to evaluate the average.



Standard:	FCC Part 15.247	Test Distance:	3 m
Test item:	Harmonic	Power:	DC 3.3 V
Frequency:	2462 MHz	Temp.(°C)/Hum.(%RH):	26(°C)/60 %RH
Mode:	Mode 5		
Ant.Polar.:	Horizontal		

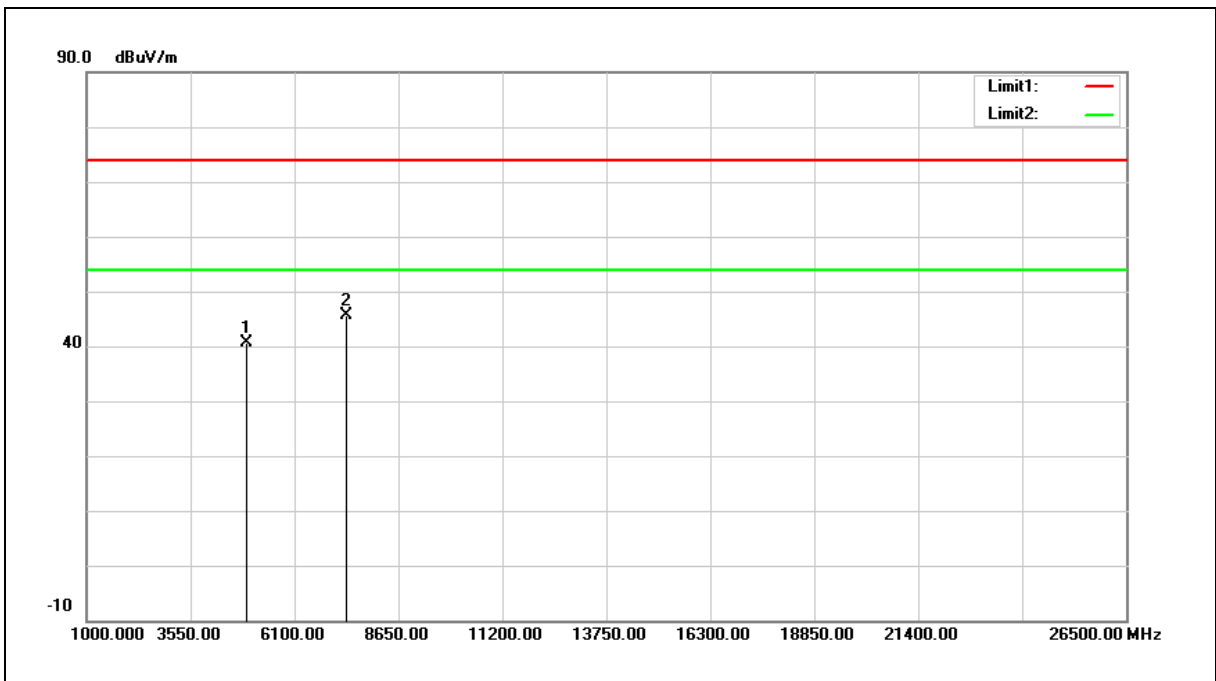

No.	Frequency (MHz)	Reading (dBuV)	Correct Factor (dB/m)	Result (dBuV/m)	Limit (dBuV/m)	Margin (dB)	Remark
1	4924.000	35.08	5.58	40.66	74.00	-33.34	peak
2	7386.000	33.26	12.36	45.62	74.00	-28.38	peak

- Note:1.Result (dBuV/m) = Correct Factor (dB/m) + Reading(dBuV).
 2.Correction factor (dB/m) = Antenna Factor (dB/m) + Cable loss (dB) – Pre-Amplifier gain (dB).
 3. When the peak results are less than average limit, so not need to evaluate the average.



Standard:	FCC Part 15.247	Test Distance:	3 m
Test item:	Harmonic	Power:	DC 3.3 V
Frequency:	2462 MHz	Temp.(°C)/Hum.(%RH):	26(°C)/60 %RH
Mode:	Mode 5		
Ant.Polar.:	Vertical		

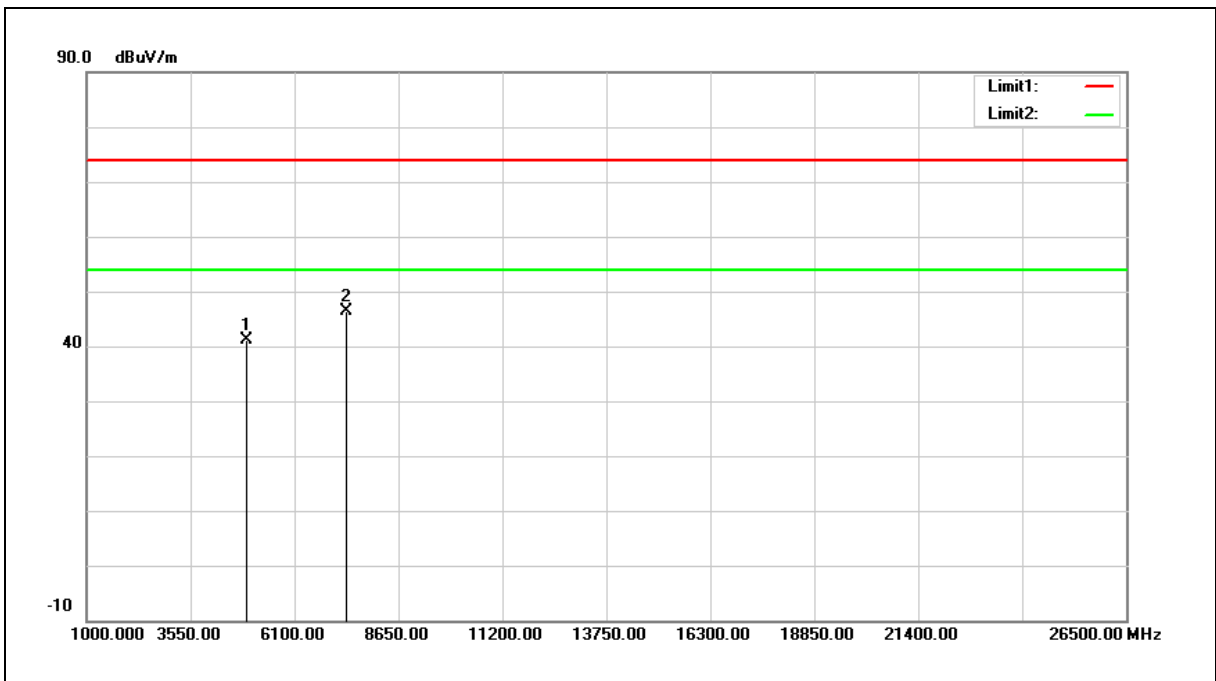

No.	Frequency (MHz)	Reading (dBuV)	Correct Factor (dB/m)	Result (dBuV/m)	Limit (dBuV/m)	Margin (dB)	Remark
1	4924.000	35.65	5.58	41.23	74.00	-32.77	peak
2	7386.000	33.90	12.36	46.26	74.00	-27.74	peak

- Note:1.Result (dBuV/m) = Correct Factor (dB/m) + Reading(dBuV).
 2.Correction factor (dB/m) = Antenna Factor (dB/m) + Cable loss (dB) – Pre-Amplifier gain (dB).
 3. When the peak results are less than average limit, so not need to evaluate the average.

Band Edge

SISO A

Standard:	FCC Part 15.247	Test Distance:	3 m
Test item:	Band edge	Power:	DC 3.3 V
Frequency:	2412 MHz	Temp.(°C)/Hum.(%RH):	26(°C)/60 %RH
Mode:	Mode 2		
Ant.Polar.:	Horizontal		

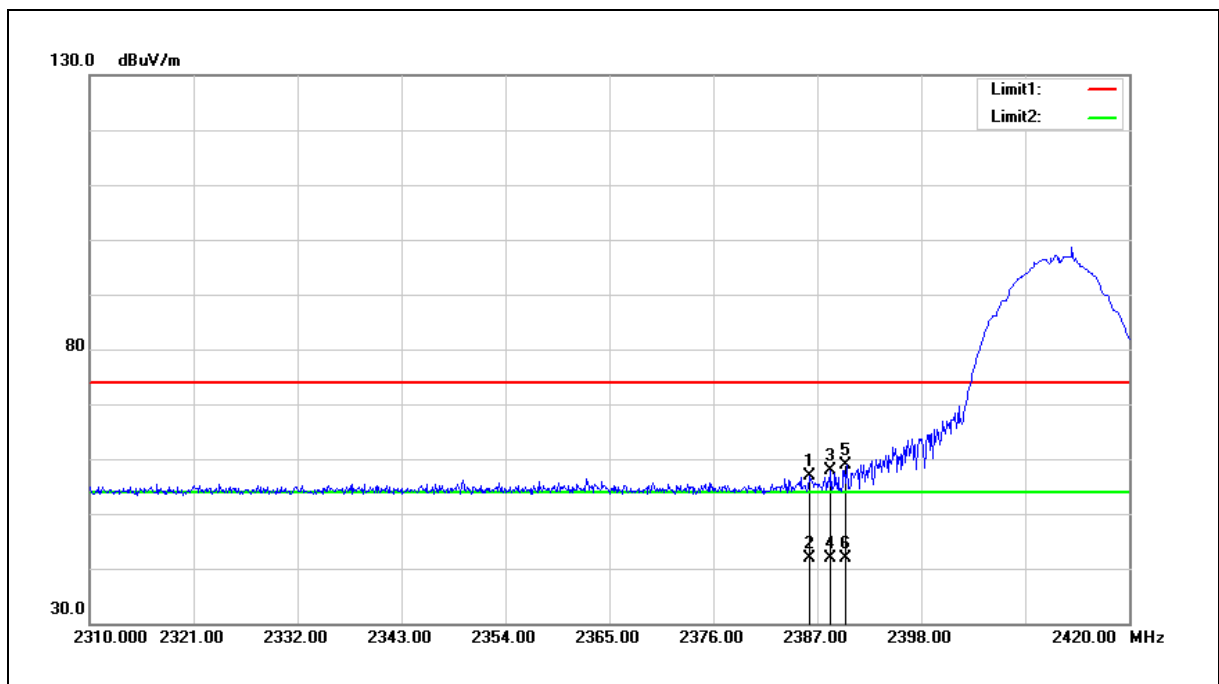

No.	Frequency (MHz)	Reading (dBuV)	Correct Factor (dB/m)	Result (dBuV/m)	Limit (dBuV/m)	Margin (dB)	Remark
1	2386.230	57.97	-1.18	56.79	74.00	-17.21	peak
2	2386.230	42.95	-1.18	41.77	54.00	-12.23	AVG
3	2388.430	58.99	-1.17	57.82	74.00	-16.18	peak
4	2388.430	43.02	-1.17	41.85	54.00	-12.15	AVG
5	2390.000	60.11	-1.17	58.94	74.00	-15.06	peak
6	2390.000	43.17	-1.17	42.00	54.00	-12.00	AVG

Note:1.Result (dBuV/m) = Correct Factor (dB/m) + Reading(dBuV).

2.Correction factor (dB/m) = Antenna Factor (dB/m) + Cable loss (dB) – Pre-Amplifier gain (dB).

3. When the peak results are less than average limit, so not need to evaluate the average.



Standard:	FCC Part 15.247	Test Distance:	3 m
Test item:	Band edge	Power:	DC 3.3 V
Frequency:	2412 MHz	Temp.(°C)/Hum.(%RH):	26(°C)/60 %RH
Mode:	Mode 2		
Ant.Polar.:	Vertical		

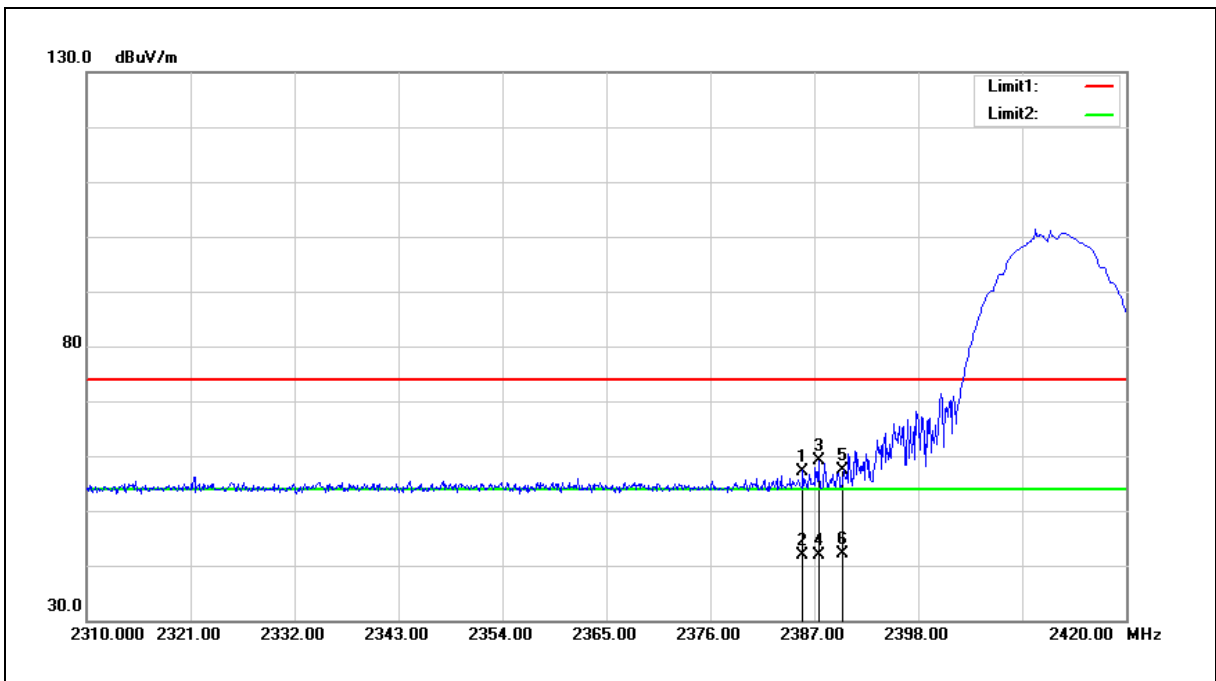

No.	Frequency (MHz)	Reading (dBuV)	Correct Factor (dB/m)	Result (dBuV/m)	Limit (dBuV/m)	Margin (dB)	Remark
1	2385.790	58.43	-1.18	57.25	74.00	-16.75	peak
2	2385.790	43.04	-1.18	41.86	54.00	-12.14	AVG
3	2387.440	60.21	-1.17	59.04	74.00	-14.96	peak
4	2387.440	43.12	-1.17	41.95	54.00	-12.05	AVG
5	2390.000	58.59	-1.17	57.42	74.00	-16.58	peak
6	2390.000	43.22	-1.17	42.05	54.00	-11.95	AVG

- Note:1.Result (dBuV/m) = Correct Factor (dB/m) + Reading(dBuV).
- 2.Correction factor (dB/m) = Antenna Factor (dB/m) + Cable loss (dB) – Pre-Amplifier gain (dB).
3. When the peak results are less than average limit, so not need to evaluate the average.



Standard:	FCC Part 15.247	Test Distance:	3 m
Test item:	Band edge	Power:	DC 3.3 V
Frequency:	2462 MHz	Temp.(°C)/Hum.(%RH):	26(°C)/60 %RH
Mode:	Mode 2		
Ant.Polar.:	Horizontal		

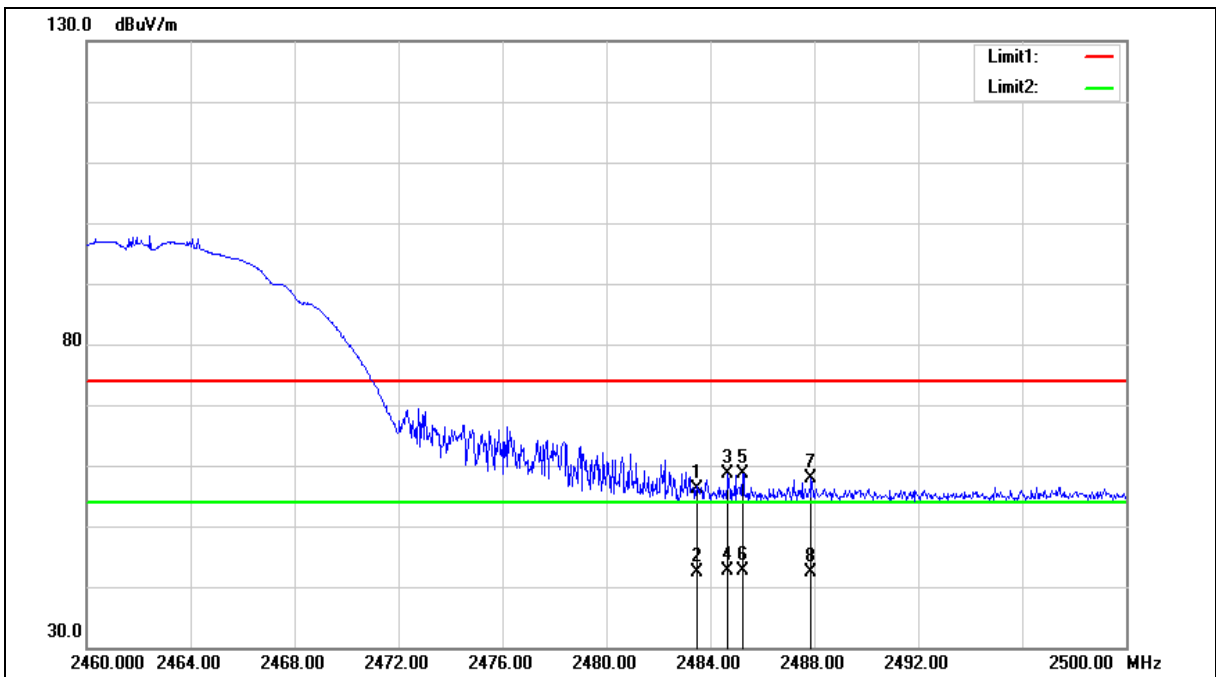



Standard:	FCC Part 15.247	Test Distance:	3 m
Test item:	Band edge	Power:	DC 3.3 V
Frequency:	2462 MHz	Temp.(°C)/Hum.(%RH):	26(°C)/60 %RH
Mode:	Mode 2		
Ant.Polar.:	Horizontal		

No.	Frequency (MHz)	Reading (dBuV)	Correct Factor (dB/m)	Result (dBuV/m)	Limit (dBuV/m)	Margin (dB)	Remark
1	2483.500	56.96	-0.82	56.14	74.00	-17.86	peak
2	2483.500	43.13	-0.82	42.31	54.00	-11.69	AVG
3	2484.680	59.39	-0.82	58.57	74.00	-15.43	peak
4	2484.680	43.43	-0.82	42.61	54.00	-11.39	AVG
5	2485.240	59.56	-0.82	58.74	74.00	-15.26	peak
6	2485.240	43.35	-0.82	42.53	54.00	-11.47	AVG
7	2487.880	58.60	-0.80	57.80	74.00	-16.20	peak
8	2487.880	43.27	-0.80	42.47	54.00	-11.53	AVG

Note:1.Result (dBuV/m) = Correct Factor (dB/m) + Reading(dBuV).

2.Correction factor (dB/m) = Antenna Factor (dB/m) + Cable loss (dB) – Pre-Amplifier gain (dB).

3. When the peak results are less than average limit, so not need to evaluate the average.



Standard:	FCC Part 15.247	Test Distance:	3 m
Test item:	Band edge	Power:	DC 3.3 V
Frequency:	2462 MHz	Temp.(°C)/Hum.(%RH):	26(°C)/60 %RH
Mode:	Mode 2		
Ant.Polar.:	Vertical		

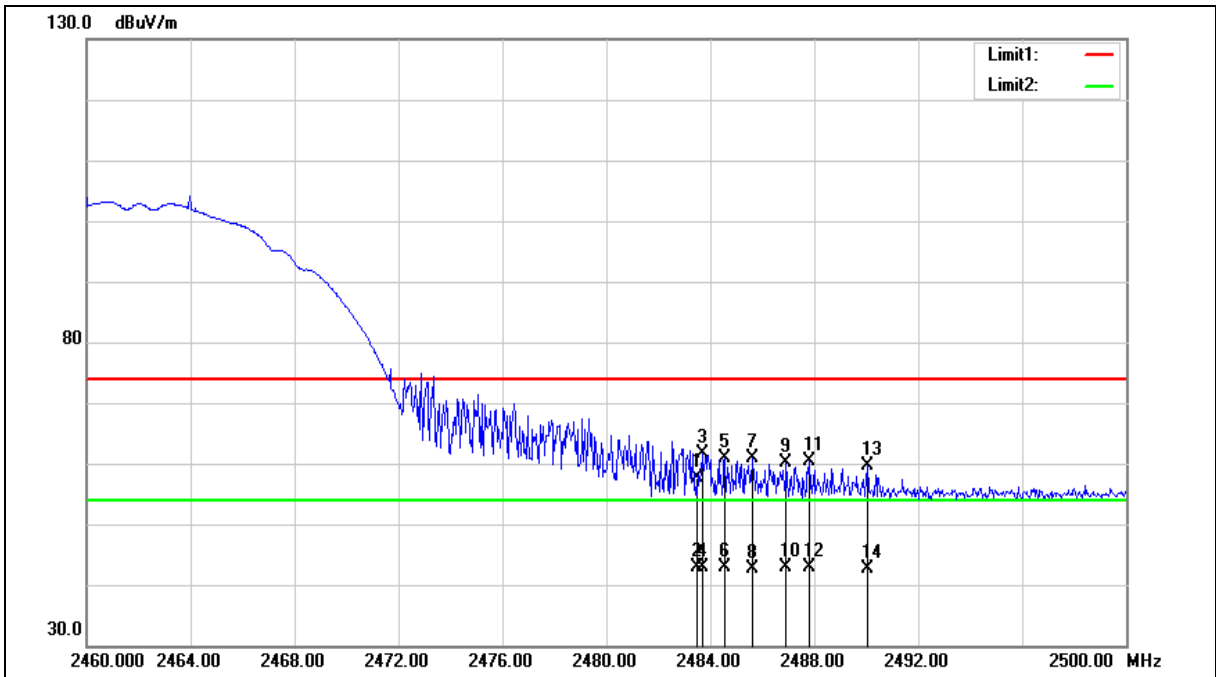



Standard:	FCC Part 15.247	Test Distance:	3 m
Test item:	Band edge	Power:	DC 3.3 V
Frequency:	2462 MHz	Temp.(°C)/Hum.(%RH):	26(°C)/60 %RH
Mode:	Mode 2		
Ant.Polar.:	Vertical		

No.	Frequency (MHz)	Reading (dBUV)	Correct Factor (dB/m)	Result (dBUV/m)	Limit (dBUV/m)	Margin (dB)	Remark
1	2483.500	58.52	-0.82	57.70	74.00	-16.30	peak
2	2483.500	43.58	-0.82	42.76	54.00	-11.24	AVG
3	2483.680	62.44	-0.82	61.62	74.00	-12.38	peak
4	2483.680	43.79	-0.82	42.97	54.00	-11.03	AVG
5	2484.560	61.76	-0.82	60.94	74.00	-13.06	peak
6	2484.560	43.70	-0.82	42.88	54.00	-11.12	AVG
7	2485.600	61.81	-0.82	60.99	74.00	-13.01	peak
8	2485.600	43.57	-0.82	42.75	54.00	-11.25	AVG
9	2486.920	60.92	-0.81	60.11	74.00	-13.89	peak
10	2486.920	43.67	-0.81	42.86	54.00	-11.14	AVG
11	2487.800	61.25	-0.80	60.45	74.00	-13.55	peak
12	2487.800	43.68	-0.80	42.88	54.00	-11.12	AVG
13	2490.040	60.42	-0.80	59.62	74.00	-14.38	peak
14	2490.040	43.45	-0.80	42.65	54.00	-11.35	AVG

Note:1.Result (dBUV/m) = Correct Factor (dB/m) + Reading(dBUV).

2.Correction factor (dB/m) = Antenna Factor (dB/m) + Cable loss (dB) – Pre-Amplifier gain (dB).

3. When the peak results are less than average limit, so not need to evaluate the average.



Standard:	FCC Part 15.247	Test Distance:	3 m
Test item:	Band edge	Power:	DC 3.3 V
Frequency:	2467 MHz	Temp.(°C)/Hum.(%RH):	26(°C)/60 %RH
Mode:	Mode 2		
Ant.Polar.:	Horizontal		

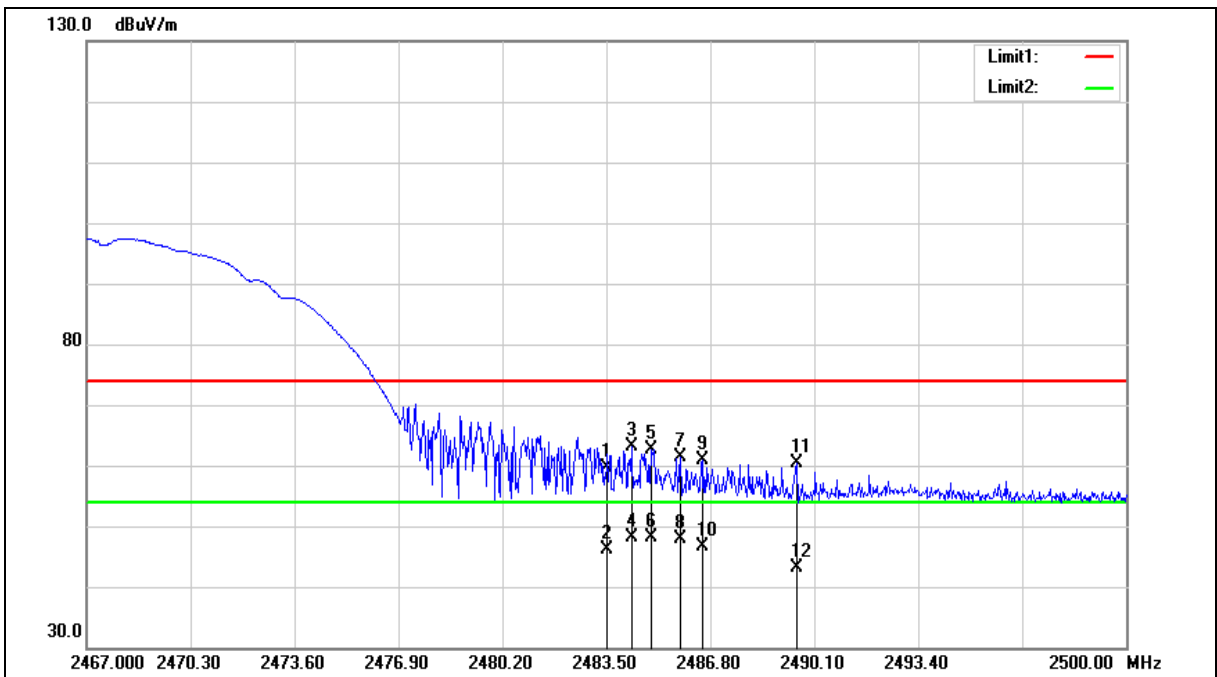



Standard:	FCC Part 15.247	Test Distance:	3 m
Test item:	Band edge	Power:	DC 3.3 V
Frequency:	2467 MHz	Temp.(°C)/Hum.(%RH):	26(°C)/60 %RH
Mode:	Mode 2		
Ant.Polar.:	Horizontal		

No.	Frequency (MHz)	Reading (dBUV)	Correct Factor (dB/m)	Result (dBUV/m)	Limit (dBUV/m)	Margin (dB)	Remark
1	2483.500	60.42	-0.82	59.60	74.00	-14.40	peak
2	2483.500	46.87	-0.82	46.05	54.00	-7.95	AVG
3	2484.292	64.02	-0.82	63.20	74.00	-10.80	peak
4	2484.292	48.85	-0.82	48.03	54.00	-5.97	AVG
5	2484.919	63.37	-0.82	62.55	74.00	-11.45	peak
6	2484.919	48.87	-0.82	48.05	54.00	-5.95	AVG
7	2485.843	62.20	-0.82	61.38	74.00	-12.62	peak
8	2485.843	48.76	-0.82	47.94	54.00	-6.06	AVG
9	2486.569	61.77	-0.81	60.96	74.00	-13.04	peak
10	2486.569	47.42	-0.81	46.61	54.00	-7.39	AVG
11	2489.539	61.20	-0.80	60.40	74.00	-13.60	peak
12	2489.539	43.89	-0.80	43.09	54.00	-10.91	AVG

Note:1.Result (dBUV/m) = Correct Factor (dB/m) + Reading(dBUV).

2.Correction factor (dB/m) = Antenna Factor (dB/m) + Cable loss (dB) – Pre-Amplifier gain (dB).

3. When the peak results are less than average limit, so not need to evaluate the average.



Standard:	FCC Part 15.247	Test Distance:	3 m
Test item:	Band edge	Power:	DC 3.3 V
Frequency:	2467 MHz	Temp.(°C)/Hum.(%RH):	26(°C)/60 %RH
Mode:	Mode 2		
Ant.Polar.:	Vertical		

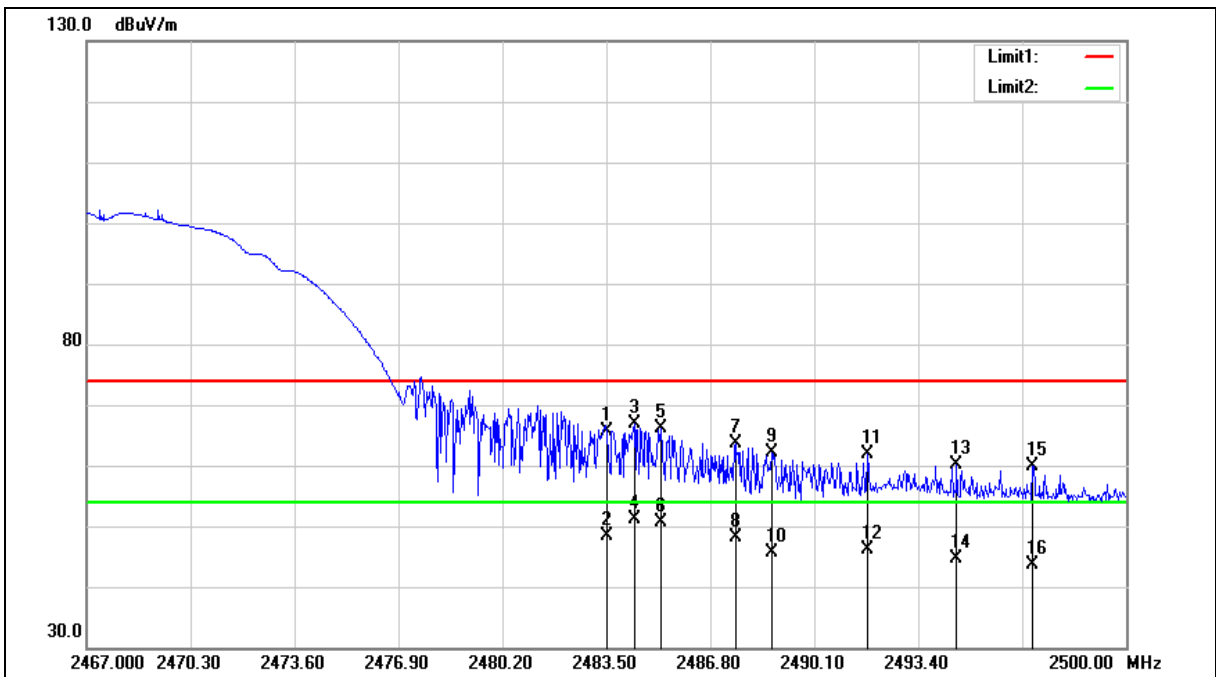



Standard:	FCC Part 15.247	Test Distance:	3 m
Test item:	Band edge	Power:	DC 3.3 V
Frequency:	2467 MHz	Temp.(°C)/Hum.(%RH):	26(°C)/60 %RH
Mode:	Mode 2		
Ant.Polar.:	Vertical		

No.	Frequency (MHz)	Reading (dBuV)	Correct Factor (dB/m)	Result (dBuV/m)	Limit (dBuV/m)	Margin (dB)	Remark
1	2483.500	66.38	-0.82	65.56	74.00	-8.44	peak
2	2483.500	49.20	-0.82	48.38	54.00	-5.62	AVG
3	2484.391	67.59	-0.82	66.77	74.00	-7.23	peak
4	2484.391	51.95	-0.82	51.13	54.00	-2.87	AVG
5	2485.249	66.90	-0.82	66.08	74.00	-7.92	peak
6	2485.249	51.45	-0.82	50.63	54.00	-3.37	AVG
7	2487.592	64.32	-0.80	63.52	74.00	-10.48	peak
8	2487.592	48.86	-0.80	48.06	54.00	-5.94	AVG
9	2488.747	62.98	-0.80	62.18	74.00	-11.82	peak
10	2488.747	46.39	-0.80	45.59	54.00	-8.41	AVG
11	2491.783	62.67	-0.79	61.88	74.00	-12.12	peak
12	2491.783	46.86	-0.79	46.07	54.00	-7.93	AVG
13	2494.621	60.99	-0.78	60.21	74.00	-13.79	peak
14	2494.621	45.32	-0.78	44.54	54.00	-9.46	AVG
15	2497.030	60.60	-0.77	59.83	74.00	-14.17	peak
16	2497.030	44.28	-0.77	43.51	54.00	-10.49	AVG

Note:1.Result (dBuV/m) = Correct Factor (dB/m) + Reading(dBuV).

2.Correction factor (dB/m) = Antenna Factor (dB/m) + Cable loss (dB) – Pre-Amplifier gain (dB).

3. When the peak results are less than average limit, so not need to evaluate the average.



Standard:	FCC Part 15.247	Test Distance:	3 m
Test item:	Band edge	Power:	DC 3.3 V
Frequency:	2472 MHz	Temp.(°C)/Hum.(%RH):	26(°C)/60 %RH
Mode:	Mode 2		
Ant.Polar.:	Horizontal		

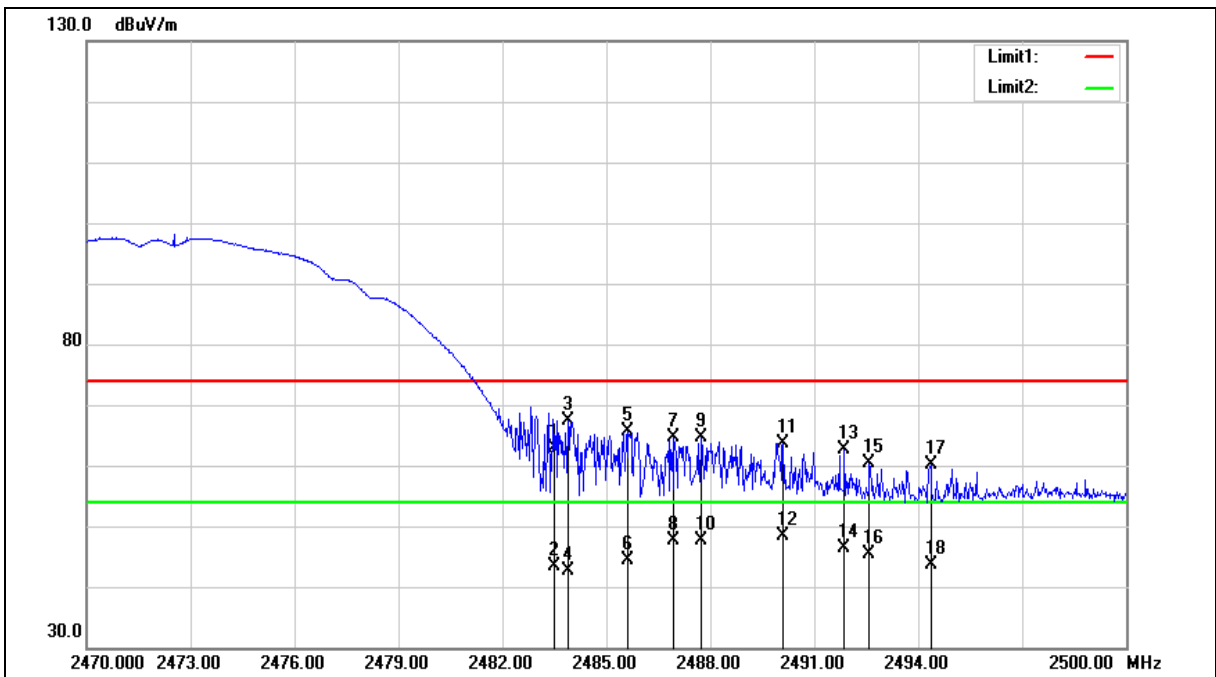



Standard:	FCC Part 15.247	Test Distance:	3 m
Test item:	Band edge	Power:	DC 3.3 V
Frequency:	2472 MHz	Temp.(°C)/Hum.(%RH):	26(°C)/60 %RH
Mode:	Mode 2		
Ant.Polar.:	Horizontal		

No.	Frequency (MHz)	Reading (dBuV)	Correct Factor (dB/m)	Result (dBuV/m)	Limit (dBuV/m)	Margin (dB)	Remark
1	2483.500	63.72	-0.82	62.90	74.00	-11.10	peak
2	2483.500	44.30	-0.82	43.48	54.00	-10.52	AVG
3	2483.890	68.15	-0.82	67.33	74.00	-6.67	peak
4	2483.890	43.50	-0.82	42.68	54.00	-11.32	AVG
5	2485.630	66.49	-0.82	65.67	74.00	-8.33	peak
6	2485.630	45.30	-0.82	44.48	54.00	-9.52	AVG
7	2486.950	65.37	-0.81	64.56	74.00	-9.44	peak
8	2486.950	48.43	-0.81	47.62	54.00	-6.38	AVG
9	2487.730	65.37	-0.80	64.57	74.00	-9.43	peak
10	2487.730	48.45	-0.80	47.65	54.00	-6.35	AVG
11	2490.100	64.50	-0.80	63.70	74.00	-10.30	peak
12	2490.100	49.22	-0.80	48.42	54.00	-5.58	AVG
13	2491.870	63.42	-0.79	62.63	74.00	-11.37	peak
14	2491.870	47.17	-0.79	46.38	54.00	-7.62	AVG
15	2492.590	61.13	-0.79	60.34	74.00	-13.66	peak
16	2492.590	46.12	-0.79	45.33	54.00	-8.67	AVG
17	2494.360	60.95	-0.78	60.17	74.00	-13.83	peak
18	2494.360	44.45	-0.78	43.67	54.00	-10.33	AVG

Note:1.Result (dBuV/m) = Correct Factor (dB/m) + Reading(dBuV).

2.Correction factor (dB/m) = Antenna Factor (dB/m) + Cable loss (dB) – Pre-Amplifier gain (dB).

3. When the peak results are less than average limit, so not need to evaluate the average.



Standard:	FCC Part 15.247	Test Distance:	3 m
Test item:	Band edge	Power:	DC 3.3 V
Frequency:	2472 MHz	Temp.(°C)/Hum.(%RH):	26(°C)/60 %RH
Mode:	Mode 2		
Ant.Polar.:	Vertical		

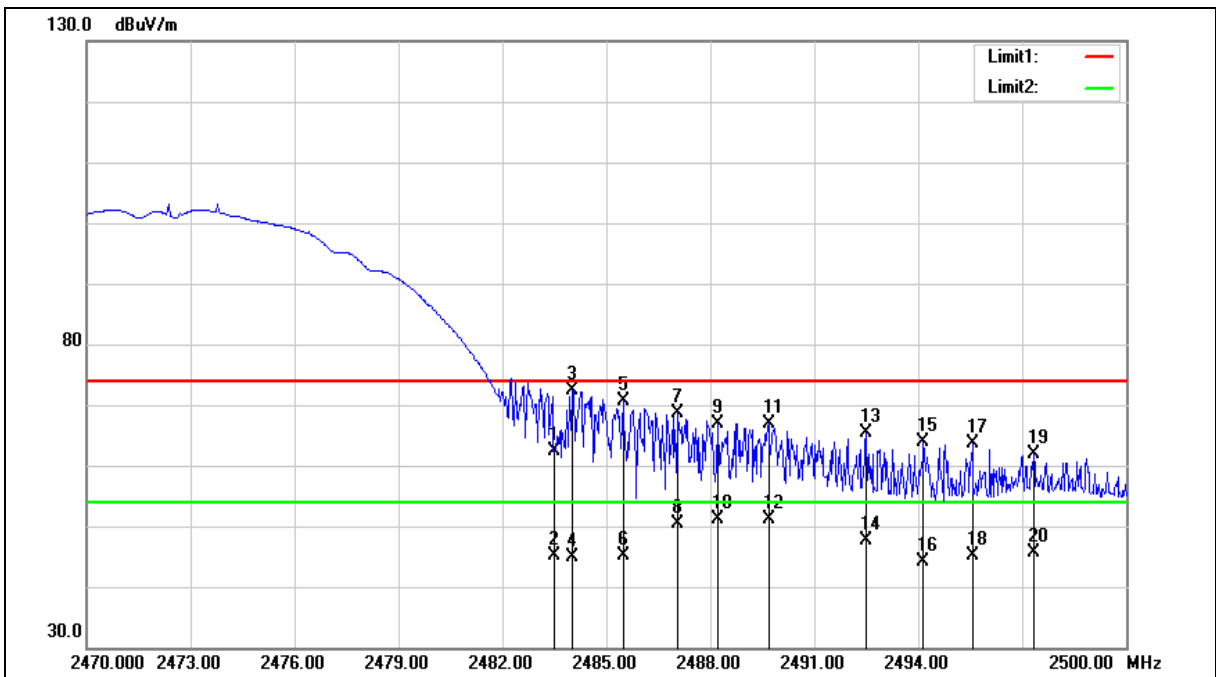



Standard:	FCC Part 15.247	Test Distance:	3 m
Test item:	Band edge	Power:	DC 3.3 V
Frequency:	2472 MHz	Temp.(°C)/Hum.(%RH):	26(°C)/60 %RH
Mode:	Mode 2		
Ant.Polar.:	Vertical		

No.	Frequency (MHz)	Reading (dBuV)	Correct Factor (dB/m)	Result (dBuV/m)	Limit (dBuV/m)	Margin (dB)	Remark
1	2483.500	63.08	-0.82	62.26	74.00	-11.74	peak
2	2483.500	45.83	-0.82	45.01	54.00	-8.99	AVG
3	2484.010	73.19	-0.82	72.37	74.00	-1.63	peak
4	2484.010	45.70	-0.82	44.88	54.00	-9.12	AVG
5	2485.480	71.42	-0.82	70.60	74.00	-3.40	peak
6	2485.480	45.92	-0.82	45.10	54.00	-8.90	AVG
7	2487.070	69.53	-0.81	68.72	74.00	-5.28	peak
8	2487.070	51.21	-0.81	50.40	54.00	-3.60	AVG
9	2488.210	67.76	-0.80	66.96	74.00	-7.04	peak
10	2488.210	51.99	-0.80	51.19	54.00	-2.81	AVG
11	2489.680	67.70	-0.80	66.90	74.00	-7.10	peak
12	2489.680	52.01	-0.80	51.21	54.00	-2.79	AVG
13	2492.500	66.05	-0.79	65.26	74.00	-8.74	peak
14	2492.500	48.52	-0.79	47.73	54.00	-6.27	AVG
15	2494.150	64.67	-0.79	63.88	74.00	-10.12	peak
16	2494.150	45.01	-0.79	44.22	54.00	-9.78	AVG
17	2495.560	64.37	-0.78	63.59	74.00	-10.41	peak
18	2495.560	46.02	-0.78	45.24	54.00	-8.76	AVG
19	2497.330	62.74	-0.77	61.97	74.00	-12.03	peak
20	2497.330	46.34	-0.77	45.57	54.00	-8.43	AVG

Note:1.Result (dBuV/m) = Correct Factor (dB/m) + Reading(dBuV).

2.Correction factor (dB/m) = Antenna Factor (dB/m) + Cable loss (dB) – Pre-Amplifier gain (dB).

3. When the peak results are less than average limit, so not need to evaluate the average.



Standard:	FCC Part 15.247	Test Distance:	3 m
Test item:	Band edge	Power:	DC 3.3 V
Frequency:	2412 MHz	Temp.(°C)/Hum.(%RH):	26(°C)/60 %RH
Mode:	Mode 3		
Ant.Polar.:	Horizontal		

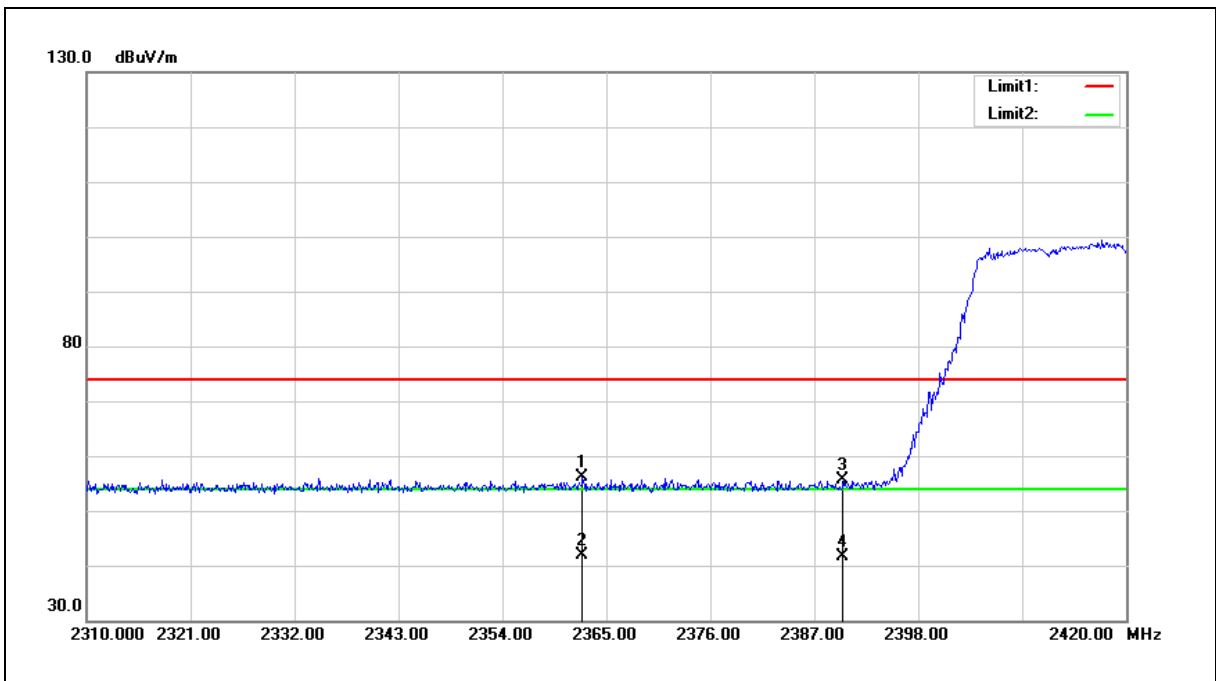

No.	Frequency (MHz)	Reading (dBuV)	Correct Factor (dB/m)	Result (dBuV/m)	Limit (dBuV/m)	Margin (dB)	Remark
1	2362.470	57.47	-1.26	56.21	74.00	-17.79	peak
2	2362.470	43.10	-1.26	41.84	54.00	-12.16	AVG
3	2390.000	56.69	-1.17	55.52	74.00	-18.48	peak
4	2390.000	42.83	-1.17	41.66	54.00	-12.34	AVG

Note:1.Result (dBuV/m) = Correct Factor (dB/m) + Reading(dBuV).

2.Correction factor (dB/m) = Antenna Factor (dB/m) + Cable loss (dB) – Pre-Amplifier gain (dB).

3. When the peak results are less than average limit, so not need to evaluate the average.



Standard:	FCC Part 15.247	Test Distance:	3 m
Test item:	Band edge	Power:	DC 3.3 V
Frequency:	2412 MHz	Temp.(°C)/Hum.(%RH):	26(°C)/60 %RH
Mode:	Mode 3		
Ant.Polar.:	Vertical		

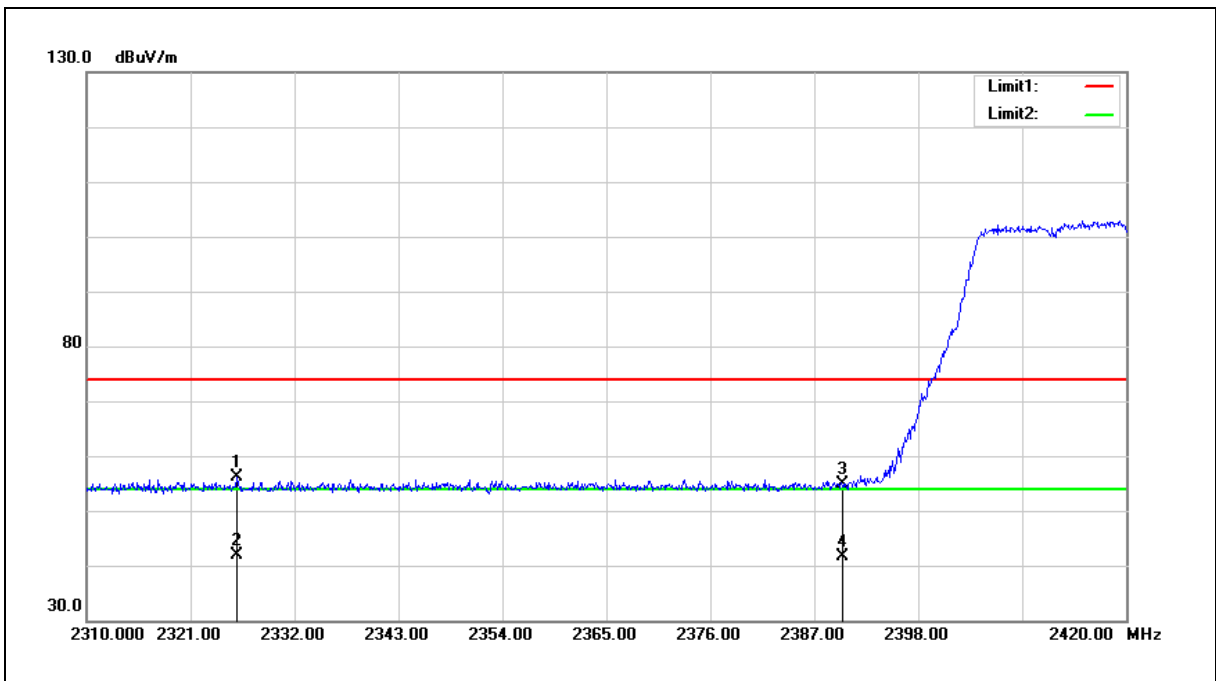

No.	Frequency (MHz)	Reading (dBuV)	Correct Factor (dB/m)	Result (dBuV/m)	Limit (dBuV/m)	Margin (dB)	Remark
1	2325.950	57.50	-1.40	56.10	74.00	-17.90	peak
2	2325.950	43.35	-1.40	41.95	54.00	-12.05	AVG
3	2390.000	56.06	-1.17	54.89	74.00	-19.11	peak
4	2390.000	42.88	-1.17	41.71	54.00	-12.29	AVG

Note:1.Result (dBuV/m) = Correct Factor (dB/m) + Reading(dBuV).

2.Correction factor (dB/m) = Antenna Factor (dB/m) + Cable loss (dB) – Pre-Amplifier gain (dB).

3. When the peak results are less than average limit, so not need to evaluate the average.

Standard:	FCC Part 15.247	Test Distance:	3 m
Test item:	Band edge	Power:	DC 3.3 V
Frequency:	2462 MHz	Temp.(°C)/Hum.(%RH):	26(°C)/60 %RH
Mode:	Mode 3		
Ant.Polar.:	Horizontal		

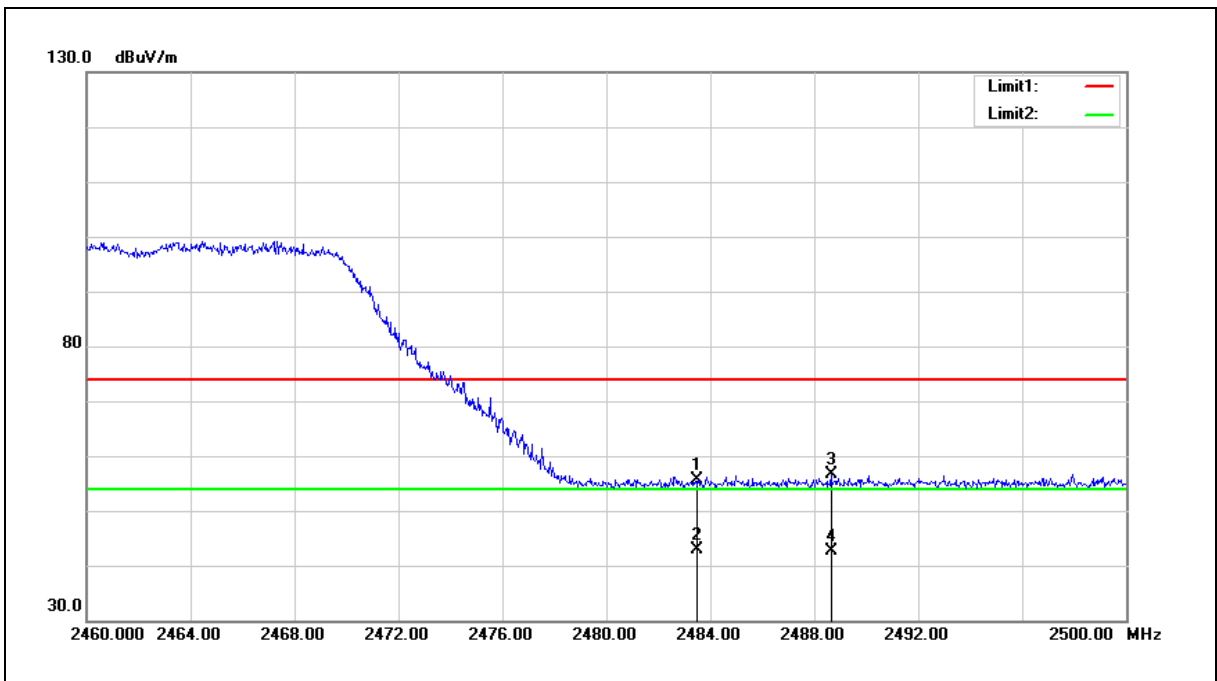

No.	Frequency (MHz)	Reading (dBuV)	Correct Factor (dB/m)	Result (dBuV/m)	Limit (dBuV/m)	Margin (dB)	Remark
1	2483.500	56.35	-0.82	55.53	74.00	-18.47	peak
2	2483.500	43.61	-0.82	42.79	54.00	-11.21	AVG
3	2488.640	57.42	-0.80	56.62	74.00	-17.38	peak
4	2488.640	43.45	-0.80	42.65	54.00	-11.35	AVG

Note:1.Result (dBuV/m) = Correct Factor (dB/m) + Reading(dBuV).

2.Correction factor (dB/m) = Antenna Factor (dB/m) + Cable loss (dB) – Pre-Amplifier gain (dB).

3. When the peak results are less than average limit, so not need to evaluate the average.



Standard:	FCC Part 15.247	Test Distance:	3 m
Test item:	Band edge	Power:	DC 3.3 V
Frequency:	2462 MHz	Temp.(°C)/Hum.(%RH):	26(°C)/60 %RH
Mode:	Mode 3		
Ant.Polar.:	Vertical		

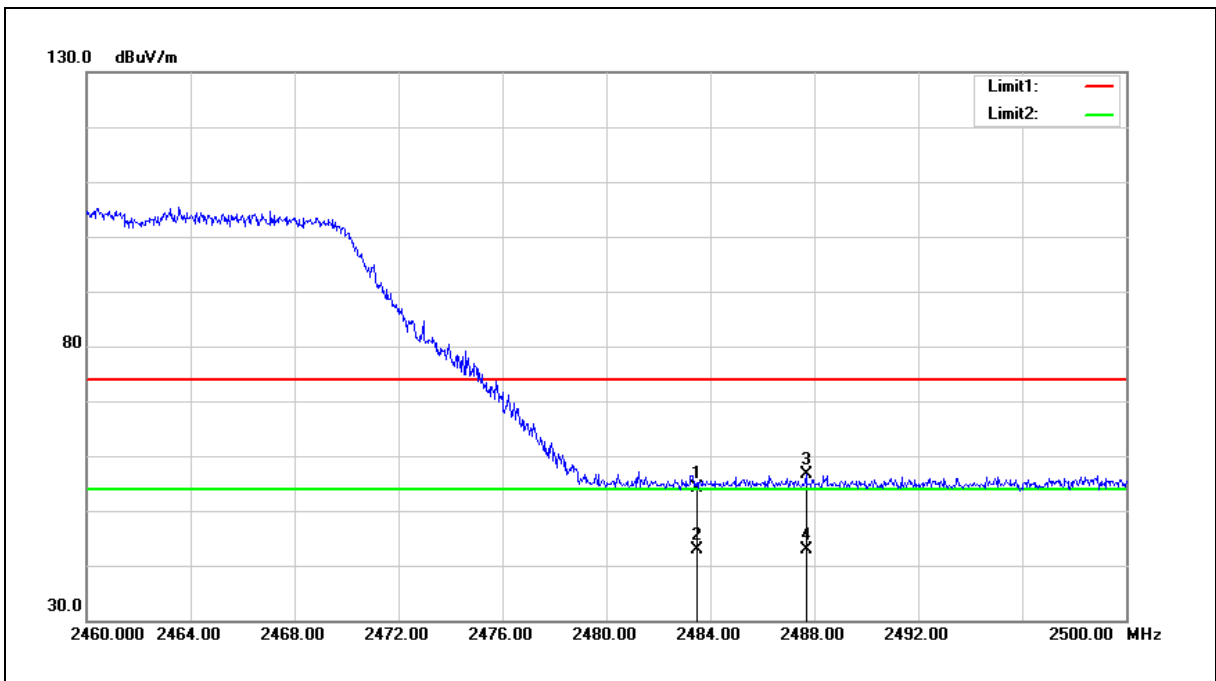

No.	Frequency (MHz)	Reading (dBuV)	Correct Factor (dB/m)	Result (dBuV/m)	Limit (dBuV/m)	Margin (dB)	Remark
1	2483.500	55.06	-0.82	54.24	74.00	-19.76	peak
2	2483.500	43.72	-0.82	42.90	54.00	-11.10	AVG
3	2487.680	57.31	-0.80	56.51	74.00	-17.49	peak
4	2487.680	43.68	-0.80	42.88	54.00	-11.12	AVG

Note:1.Result (dBuV/m) = Correct Factor (dB/m) + Reading(dBuV).

2.Correction factor (dB/m) = Antenna Factor (dB/m) + Cable loss (dB) – Pre-Amplifier gain (dB).

3. When the peak results are less than average limit, so not need to evaluate the average.



Standard:	FCC Part 15.247	Test Distance:	3 m
Test item:	Band edge	Power:	DC 3.3 V
Frequency:	2467 MHz	Temp.(°C)/Hum.(%RH):	26(°C)/60 %RH
Mode:	Mode 3		
Ant.Polar.:	Horizontal		

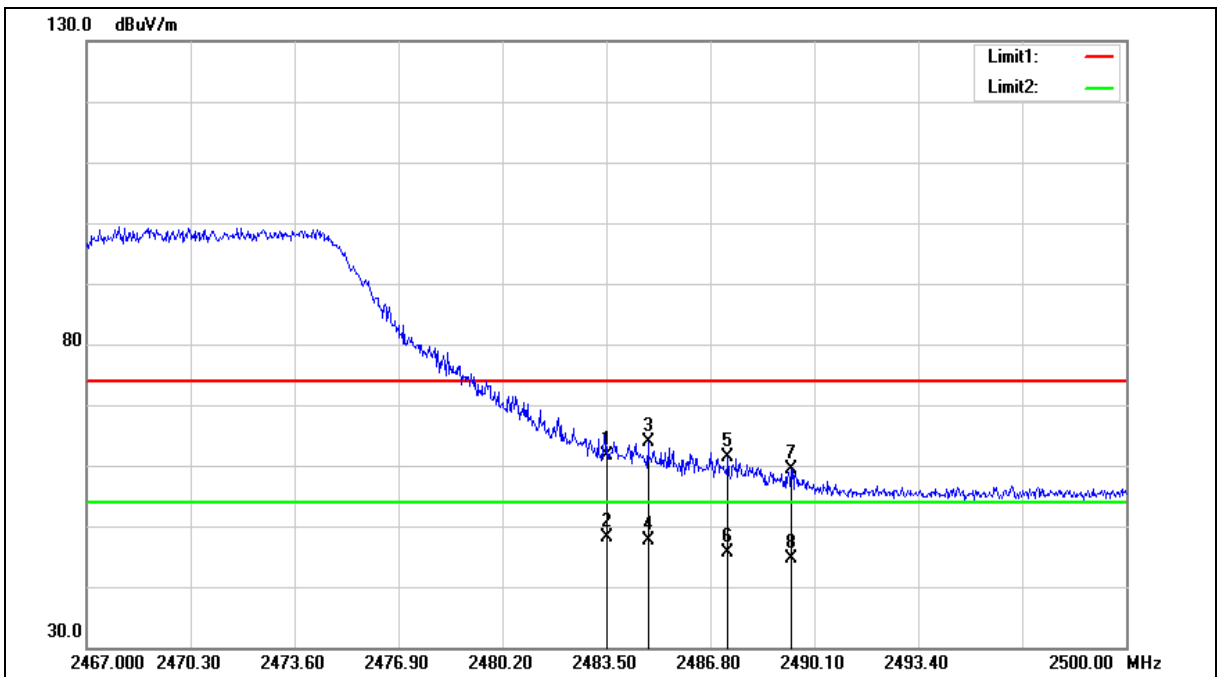



Standard:	FCC Part 15.247	Test Distance:	3 m
Test item:	Band edge	Power:	DC 3.3 V
Frequency:	2467 MHz	Temp.(°C)/Hum.(%RH):	26(°C)/60 %RH
Mode:	Mode 3		
Ant.Polar.:	Horizontal		

No.	Frequency (MHz)	Reading (dBuV)	Correct Factor (dB/m)	Result (dBuV/m)	Limit (dBuV/m)	Margin (dB)	Remark
1	2483.500	62.33	-0.82	61.51	74.00	-12.49	peak
2	2483.500	48.96	-0.82	48.14	54.00	-5.86	AVG
3	2484.820	64.68	-0.82	63.86	74.00	-10.14	peak
4	2484.820	48.42	-0.82	47.60	54.00	-6.40	AVG
5	2487.361	62.07	-0.80	61.27	74.00	-12.73	peak
6	2487.361	46.53	-0.80	45.73	54.00	-8.27	AVG
7	2489.374	60.09	-0.80	59.29	74.00	-14.71	peak
8	2489.374	45.47	-0.80	44.67	54.00	-9.33	AVG

Note:1.Result (dBuV/m) = Correct Factor (dB/m) + Reading(dBuV).

2.Correction factor (dB/m) = Antenna Factor (dB/m) + Cable loss (dB) – Pre-Amplifier gain (dB).

3. When the peak results are less than average limit, so not need to evaluate the average.



Standard:	FCC Part 15.247	Test Distance:	3 m
Test item:	Band edge	Power:	DC 3.3 V
Frequency:	2467 MHz	Temp.(°C)/Hum.(%RH):	26(°C)/60 %RH
Mode:	Mode 3		
Ant.Polar.:	Vertical		

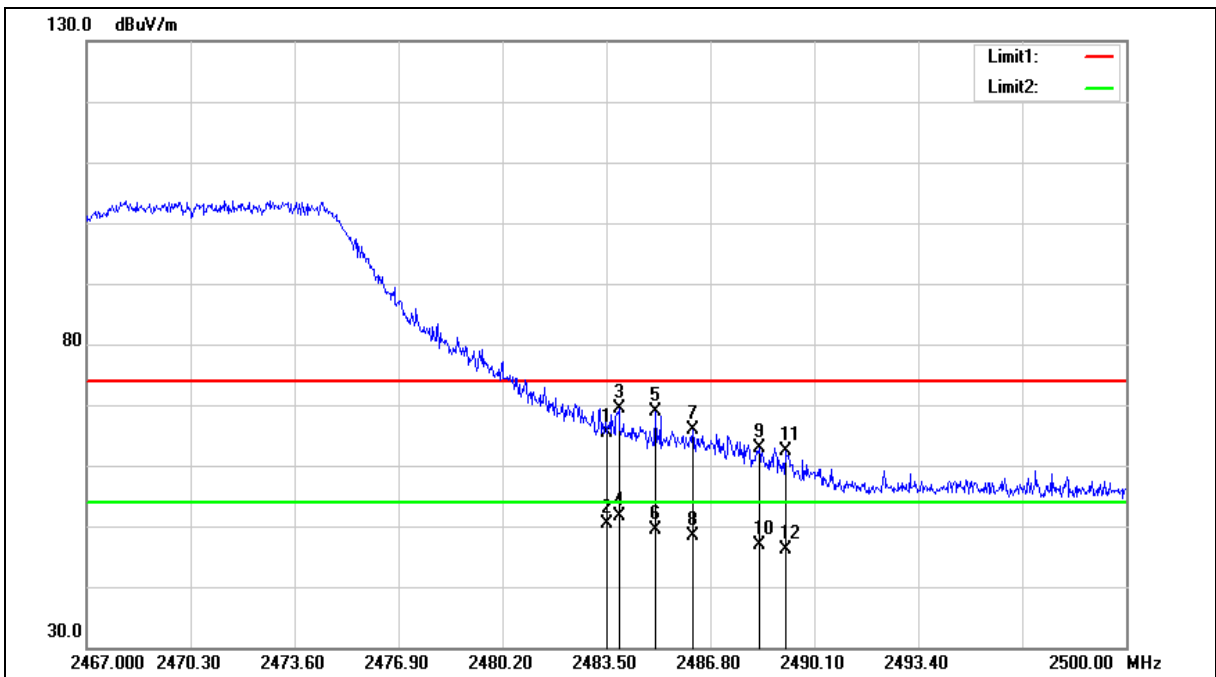



Standard:	FCC Part 15.247	Test Distance:	3 m
Test item:	Band edge	Power:	DC 3.3 V
Frequency:	2467 MHz	Temp.(°C)/Hum.(%RH):	26(°C)/60 %RH
Mode:	Mode 3		
Ant.Polar.:	Vertical		

No.	Frequency (MHz)	Reading (dBuV)	Correct Factor (dB/m)	Result (dBuV/m)	Limit (dBuV/m)	Margin (dB)	Remark
1	2483.500	66.28	-0.82	65.46	74.00	-8.54	peak
2	2483.500	51.08	-0.82	50.26	54.00	-3.74	AVG
3	2483.896	70.11	-0.82	69.29	74.00	-4.71	peak
4	2483.896	52.47	-0.82	51.65	54.00	-2.35	AVG
5	2485.051	69.70	-0.82	68.88	74.00	-5.12	peak
6	2485.051	50.26	-0.82	49.44	54.00	-4.56	AVG
7	2486.239	66.69	-0.82	65.87	74.00	-8.13	peak
8	2486.239	49.14	-0.82	48.32	54.00	-5.68	AVG
9	2488.351	63.58	-0.80	62.78	74.00	-11.22	peak
10	2488.351	47.57	-0.80	46.77	54.00	-7.23	AVG
11	2489.176	63.29	-0.80	62.49	74.00	-11.51	peak
12	2489.176	46.99	-0.80	46.19	54.00	-7.81	AVG

Note:1.Result (dBuV/m) = Correct Factor (dB/m) + Reading(dBuV).

2.Correction factor (dB/m) = Antenna Factor (dB/m) + Cable loss (dB) – Pre-Amplifier gain (dB).

3. When the peak results are less than average limit, so not need to evaluate the average.



Standard:	FCC Part 15.247	Test Distance:	3 m
Test item:	Band edge	Power:	DC 3.3 V
Frequency:	2472 MHz	Temp.(°C)/Hum.(%RH):	26(°C)/60 %RH
Mode:	Mode 3		
Ant.Polar.:	Horizontal		

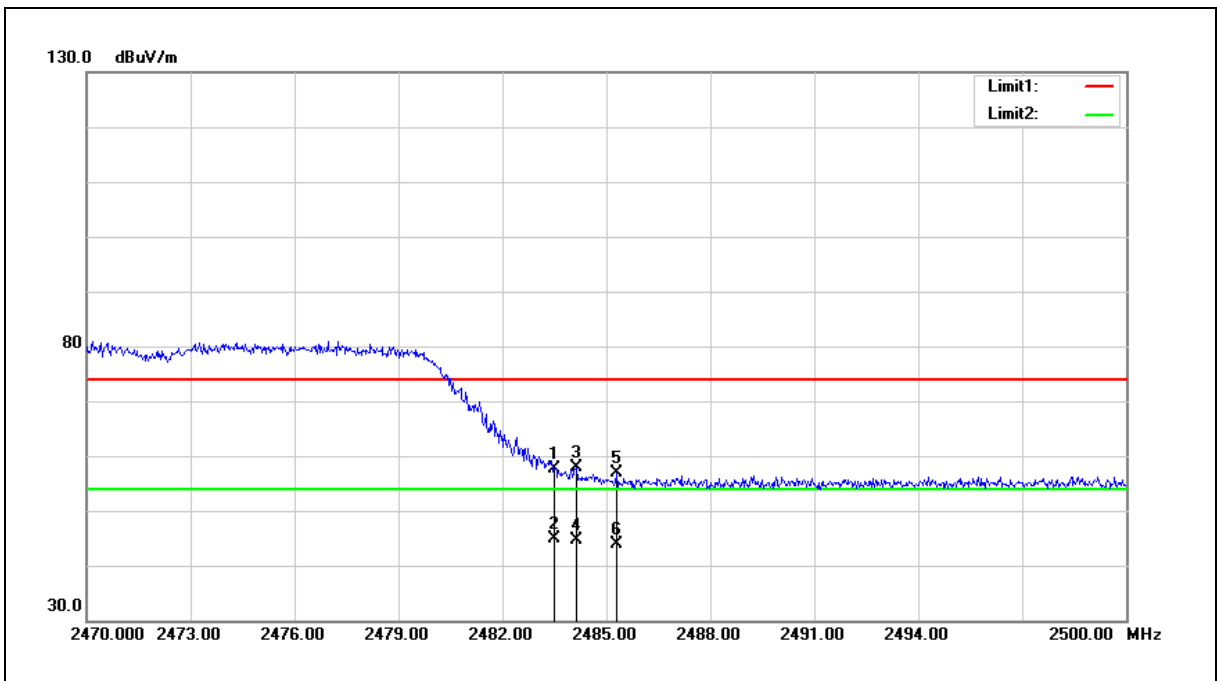

No.	Frequency (MHz)	Reading (dBuV)	Correct Factor (dB/m)	Result (dBuV/m)	Limit (dBuV/m)	Margin (dB)	Remark
1	2483.500	58.40	-0.82	57.58	74.00	-16.42	peak
2	2483.500	45.68	-0.82	44.86	54.00	-9.14	AVG
3	2484.130	58.65	-0.82	57.83	74.00	-16.17	peak
4	2484.130	45.52	-0.82	44.70	54.00	-9.30	AVG
5	2485.300	57.67	-0.82	56.85	74.00	-17.15	peak
6	2485.300	44.60	-0.82	43.78	54.00	-10.22	AVG

- Note:1.Result (dBuV/m) = Correct Factor (dB/m) + Reading(dBuV).
- 2.Correction factor (dB/m) = Antenna Factor (dB/m) + Cable loss (dB) – Pre-Amplifier gain (dB).
3. When the peak results are less than average limit, so not need to evaluate the average.

Standard:	FCC Part 15.247	Test Distance:	3 m
Test item:	Band edge	Power:	DC 3.3 V
Frequency:	2472 MHz	Temp.(°C)/Hum.(%RH):	26(°C)/60 %RH
Mode:	Mode 3		
Ant.Polar.:	Vertical		

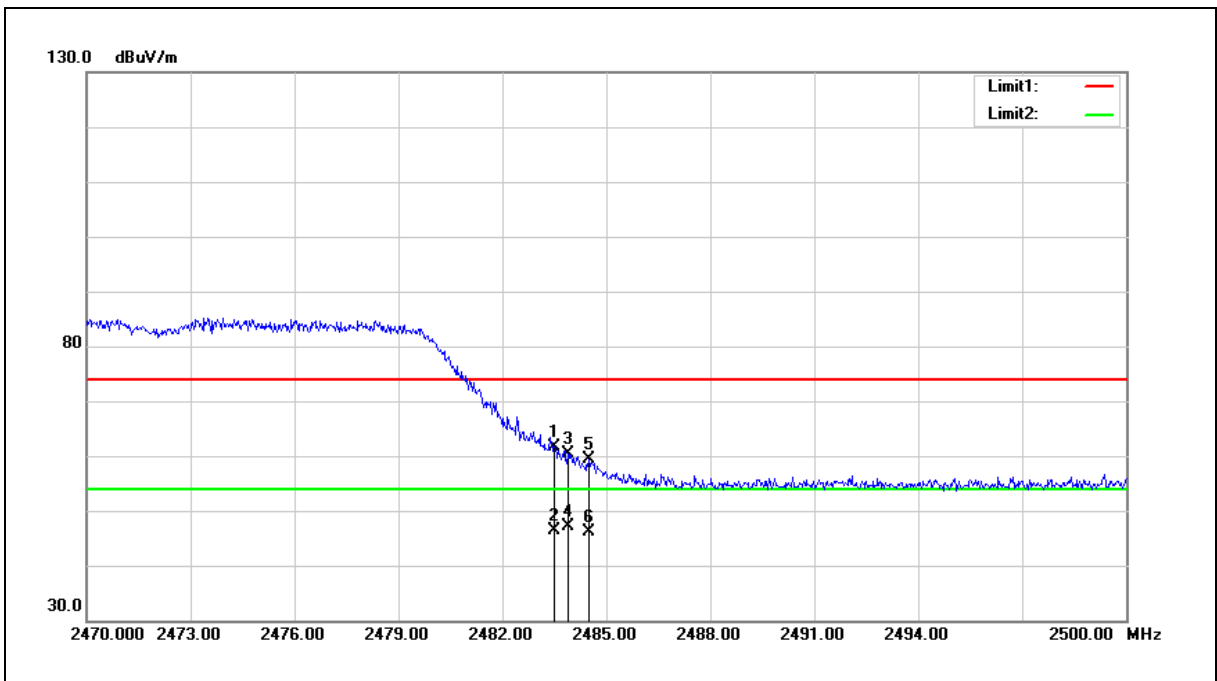

No.	Frequency (MHz)	Reading (dBuV)	Correct Factor (dB/m)	Result (dBuV/m)	Limit (dBuV/m)	Margin (dB)	Remark
1	2483.500	62.48	-0.82	61.66	74.00	-12.34	peak
2	2483.500	47.19	-0.82	46.37	54.00	-7.63	AVG
3	2483.890	61.21	-0.82	60.39	74.00	-13.61	peak
4	2483.890	47.98	-0.82	47.16	54.00	-6.84	AVG
5	2484.490	60.19	-0.82	59.37	74.00	-14.63	peak
6	2484.490	46.96	-0.82	46.14	54.00	-7.86	AVG

Note:1.Result (dBuV/m) = Correct Factor (dB/m) + Reading(dBuV).

2.Correction factor (dB/m) = Antenna Factor (dB/m) + Cable loss (dB) – Pre-Amplifier gain (dB).

3. When the peak results are less than average limit, so not need to evaluate the average.



SISO B

Standard:	FCC Part 15.247	Test Distance:	3 m
Test item:	Band edge	Power:	DC 3.3 V
Frequency:	2412 MHz	Temp.(°C)/Hum.(%RH):	26(°C)/60 %RH
Mode:	Mode 2		
Ant.Polar.:	Horizontal		

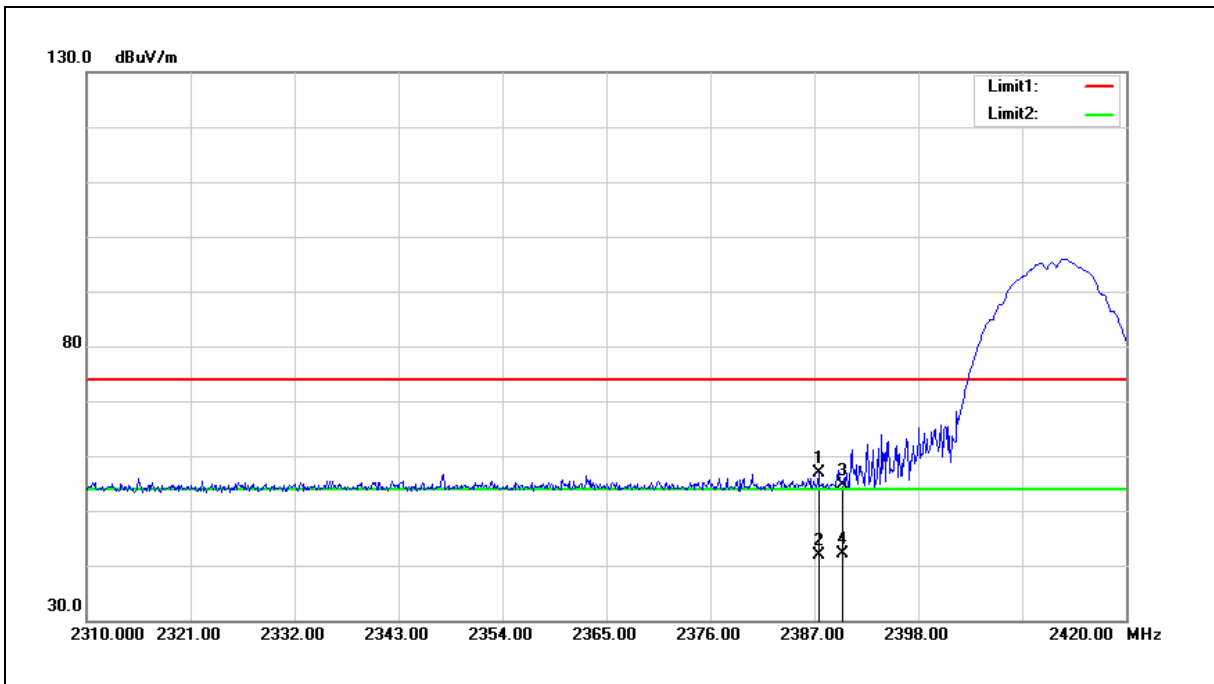

No.	Frequency (MHz)	Reading (dBuV)	Correct Factor (dB/m)	Result (dBuV/m)	Limit (dBuV/m)	Margin (dB)	Remark
1	2387.440	57.94	-1.17	56.77	74.00	-17.23	peak
2	2387.440	43.07	-1.17	41.90	54.00	-12.10	AVG
3	2390.000	55.91	-1.17	54.74	74.00	-19.26	peak
4	2390.000	43.30	-1.17	42.13	54.00	-11.87	AVG

Note:1.Result (dBuV/m) = Correct Factor (dB/m) + Reading(dBuV).

2.Correction factor (dB/m) = Antenna Factor (dB/m) + Cable loss (dB) – Pre-Amplifier gain (dB).

3. When the peak results are less than average limit, so not need to evaluate the average.



Standard:	FCC Part 15.247	Test Distance:	3 m
Test item:	Band edge	Power:	DC 3.3 V
Frequency:	2412 MHz	Temp.(°C)/Hum.(%RH):	26(°C)/60 %RH
Mode:	Mode 2		
Ant.Polar.:	Vertical		

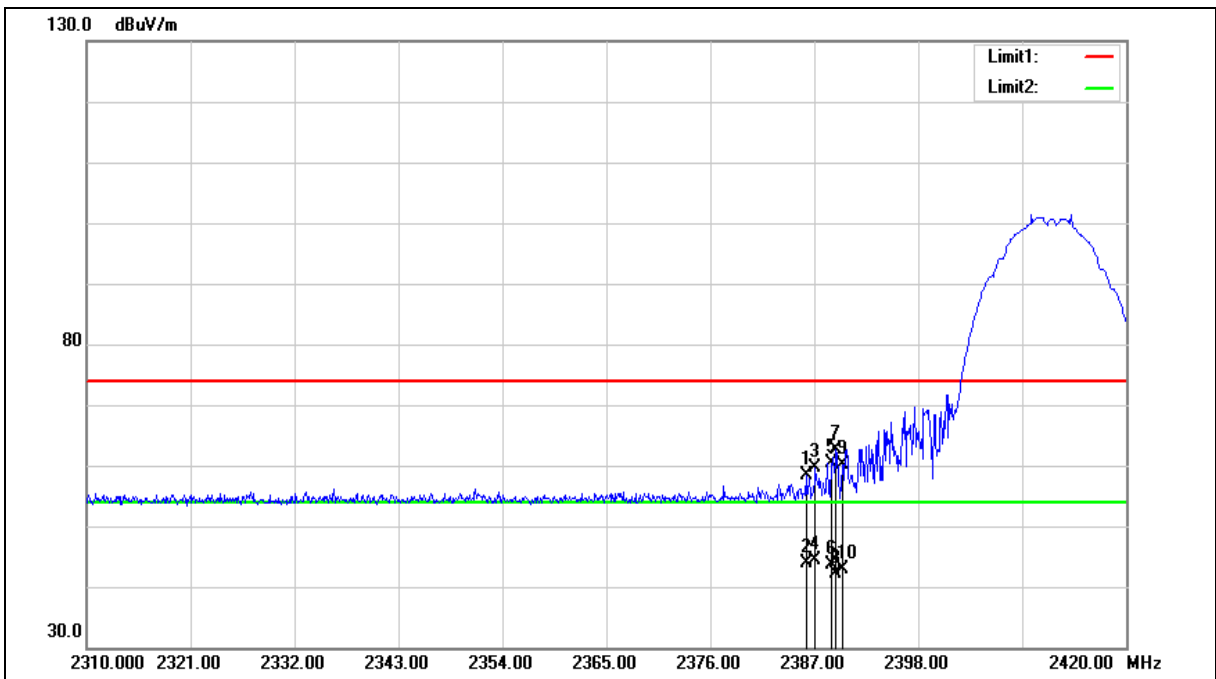



Standard:	FCC Part 15.247	Test Distance:	3 m
Test item:	Band edge	Power:	DC 3.3 V
Frequency:	2412 MHz	Temp.(°C)/Hum.(%RH):	26(°C)/60 %RH
Mode:	Mode 2		
Ant.Polar.:	Vertical		

No.	Frequency (MHz)	Reading (dBuV)	Correct Factor (dB/m)	Result (dBuV/m)	Limit (dBuV/m)	Margin (dB)	Remark
1	2386.120	59.47	-1.18	58.29	74.00	-15.71	peak
2	2386.120	45.01	-1.18	43.83	54.00	-10.17	AVG
3	2387.110	60.69	-1.17	59.52	74.00	-14.48	peak
4	2387.110	45.67	-1.17	44.50	54.00	-9.50	AVG
5	2388.760	61.55	-1.17	60.38	74.00	-13.62	peak
6	2388.760	44.71	-1.17	43.54	54.00	-10.46	AVG
7	2389.310	63.88	-1.17	62.71	74.00	-11.29	peak
8	2389.310	43.27	-1.17	42.10	54.00	-11.90	AVG
9	2390.000	61.19	-1.17	60.02	74.00	-13.98	peak
10	2390.000	44.12	-1.17	42.95	54.00	-11.05	AVG

Note:1.Result (dBuV/m) = Correct Factor (dB/m) + Reading(dBuV).

2.Correction factor (dB/m) = Antenna Factor (dB/m) + Cable loss (dB) – Pre-Amplifier gain (dB).

3. When the peak results are less than average limit, so not need to evaluate the average.



Standard:	FCC Part 15.247	Test Distance:	3 m
Test item:	Band edge	Power:	DC 3.3 V
Frequency:	2462 MHz	Temp.(°C)/Hum.(%RH):	26(°C)/60 %RH
Mode:	Mode 2		
Ant.Polar.:	Horizontal		

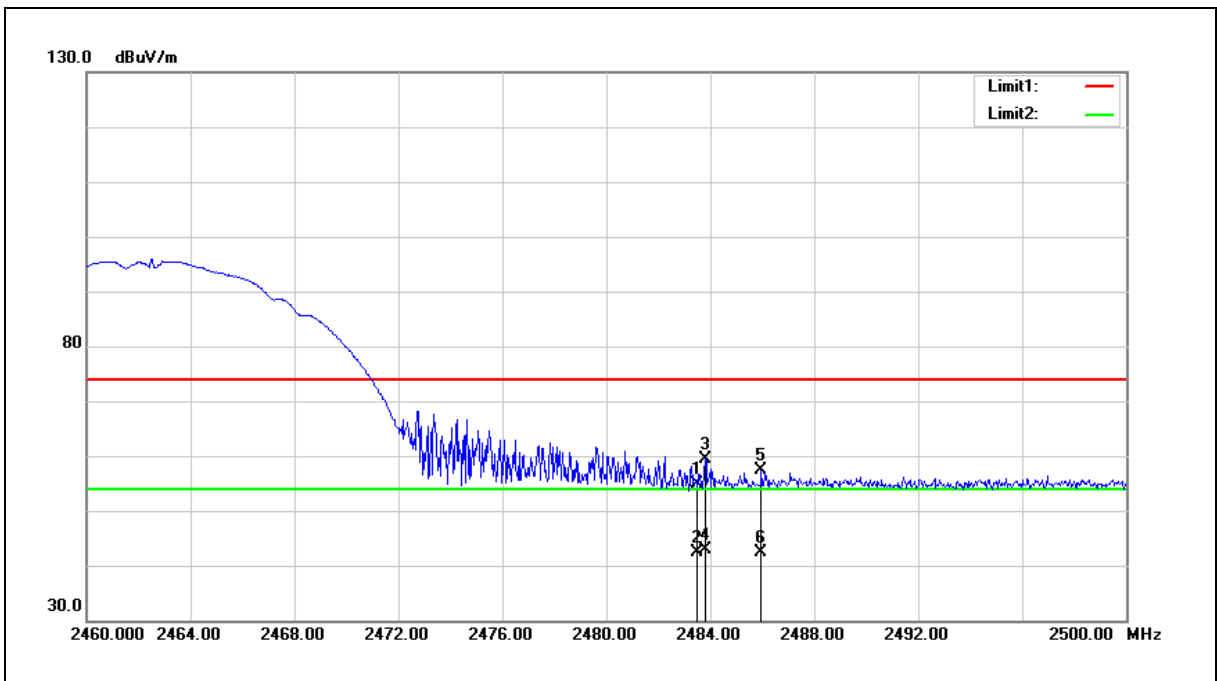

No.	Frequency (MHz)	Reading (dBuV)	Correct Factor (dB/m)	Result (dBuV/m)	Limit (dBuV/m)	Margin (dB)	Remark
1	2483.500	55.74	-0.82	54.92	74.00	-19.08	peak
2	2483.500	43.20	-0.82	42.38	54.00	-11.62	AVG
3	2483.800	60.32	-0.82	59.50	74.00	-14.50	peak
4	2483.800	43.77	-0.82	42.95	54.00	-11.05	AVG
5	2485.960	58.11	-0.82	57.29	74.00	-16.71	peak
6	2485.960	43.23	-0.82	42.41	54.00	-11.59	AVG

Note:1.Result (dBuV/m) = Correct Factor (dB/m) + Reading(dBuV).

2.Correction factor (dB/m) = Antenna Factor (dB/m) + Cable loss (dB) – Pre-Amplifier gain (dB).

3. When the peak results are less than average limit, so not need to evaluate the average.



Standard:	FCC Part 15.247	Test Distance:	3 m
Test item:	Band edge	Power:	DC 3.3 V
Frequency:	2462 MHz	Temp.(°C)/Hum.(%RH):	26(°C)/60 %RH
Mode:	Mode 2		
Ant.Polar.:	Vertical		

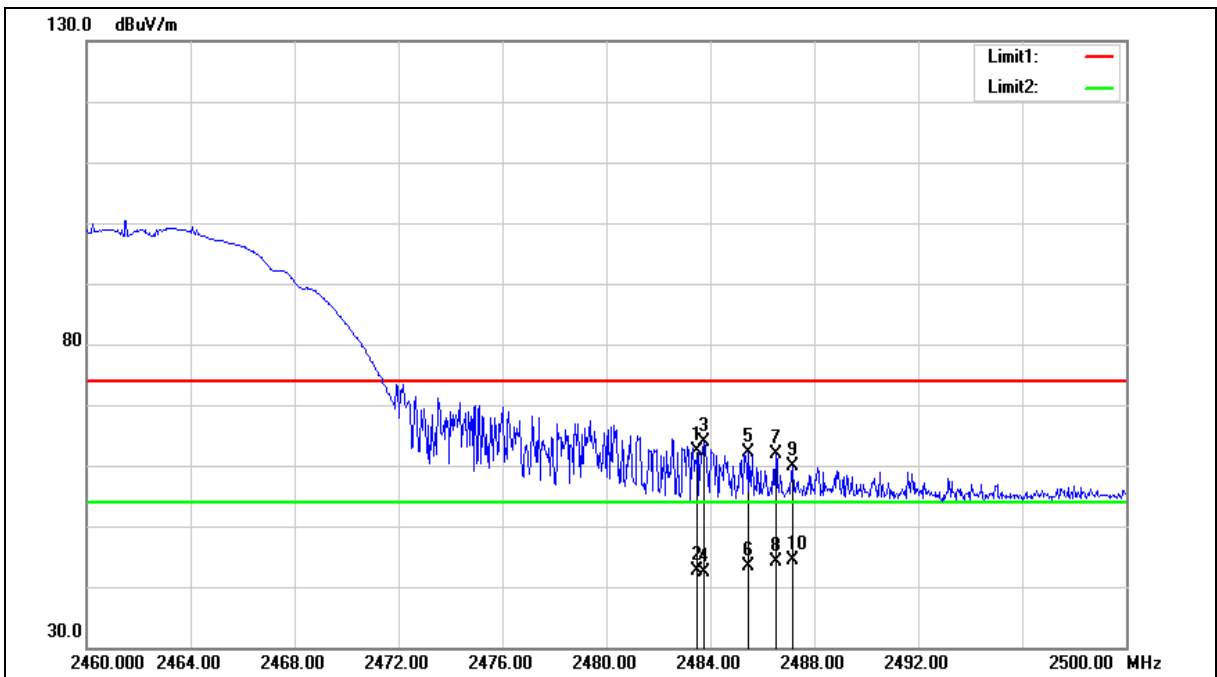



Standard:	FCC Part 15.247	Test Distance:	3 m
Test item:	Band edge	Power:	DC 3.3 V
Frequency:	2462 MHz	Temp.(°C)/Hum.(%RH):	26(°C)/60 %RH
Mode:	Mode 2		
Ant.Polar.:	Vertical		

No.	Frequency (MHz)	Reading (dBuV)	Correct Factor (dB/m)	Result (dBuV/m)	Limit (dBuV/m)	Margin (dB)	Remark
1	2483.500	63.08	-0.82	62.26	74.00	-11.74	peak
2	2483.500	43.44	-0.82	42.62	54.00	-11.38	AVG
3	2483.760	64.58	-0.82	63.76	74.00	-10.24	peak
4	2483.760	43.15	-0.82	42.33	54.00	-11.67	AVG
5	2485.480	62.88	-0.82	62.06	74.00	-11.94	peak
6	2485.480	44.29	-0.82	43.47	54.00	-10.53	AVG
7	2486.520	62.76	-0.82	61.94	74.00	-12.06	peak
8	2486.520	44.98	-0.82	44.16	54.00	-9.84	AVG
9	2487.160	60.68	-0.81	59.87	74.00	-14.13	peak
10	2487.160	45.15	-0.81	44.34	54.00	-9.66	AVG

Note:1.Result (dBuV/m) = Correct Factor (dB/m) + Reading(dBuV).

2.Correction factor (dB/m) = Antenna Factor (dB/m) + Cable loss (dB) – Pre-Amplifier gain (dB).

3. When the peak results are less than average limit, so not need to evaluate the average.



Standard:	FCC Part 15.247	Test Distance:	3 m
Test item:	Band edge	Power:	DC 3.3 V
Frequency:	2467 MHz	Temp.(°C)/Hum.(%RH):	26(°C)/60 %RH
Mode:	Mode 2		
Ant.Polar.:	Horizontal		

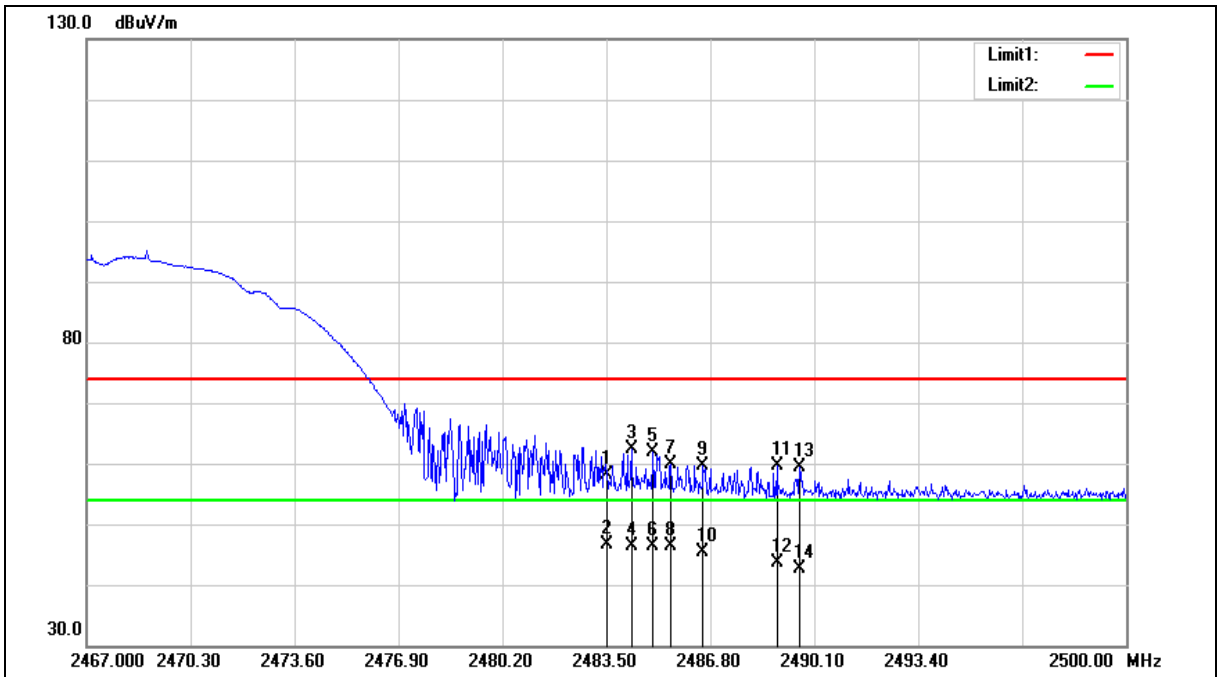



Standard:	FCC Part 15.247	Test Distance:	3 m
Test item:	Band edge	Power:	DC 3.3 V
Frequency:	2467 MHz	Temp.(°C)/Hum.(%RH):	26(°C)/60 %RH
Mode:	Mode 2		
Ant.Polar.:	Horizontal		

No.	Frequency (MHz)	Reading (dBuV)	Correct Factor (dB/m)	Result (dBuV/m)	Limit (dBuV/m)	Margin (dB)	Remark
1	2483.500	59.01	-0.82	58.19	74.00	-15.81	peak
2	2483.500	47.37	-0.82	46.55	54.00	-7.45	AVG
3	2484.292	63.25	-0.82	62.43	74.00	-11.57	peak
4	2484.292	47.21	-0.82	46.39	54.00	-7.61	AVG
5	2484.985	62.78	-0.82	61.96	74.00	-12.04	peak
6	2484.985	47.23	-0.82	46.41	54.00	-7.59	AVG
7	2485.546	60.77	-0.82	59.95	74.00	-14.05	peak
8	2485.546	47.20	-0.82	46.38	54.00	-7.62	AVG
9	2486.569	60.50	-0.81	59.69	74.00	-14.31	peak
10	2486.569	46.19	-0.81	45.38	54.00	-8.62	AVG
11	2488.912	60.32	-0.80	59.52	74.00	-14.48	peak
12	2488.912	44.39	-0.80	43.59	54.00	-10.41	AVG
13	2489.638	60.17	-0.80	59.37	74.00	-14.63	peak
14	2489.638	43.45	-0.80	42.65	54.00	-11.35	AVG

Note:1.Result (dBuV/m) = Correct Factor (dB/m) + Reading(dBuV).

2.Correction factor (dB/m) = Antenna Factor (dB/m) + Cable loss (dB) – Pre-Amplifier gain (dB).

3. When the peak results are less than average limit, so not need to evaluate the average.



Standard:	FCC Part 15.247	Test Distance:	3 m
Test item:	Band edge	Power:	DC 3.3 V
Frequency:	2467 MHz	Temp.(°C)/Hum.(%RH):	26(°C)/60 %RH
Mode:	Mode 2		
Ant.Polar.:	Vertical		

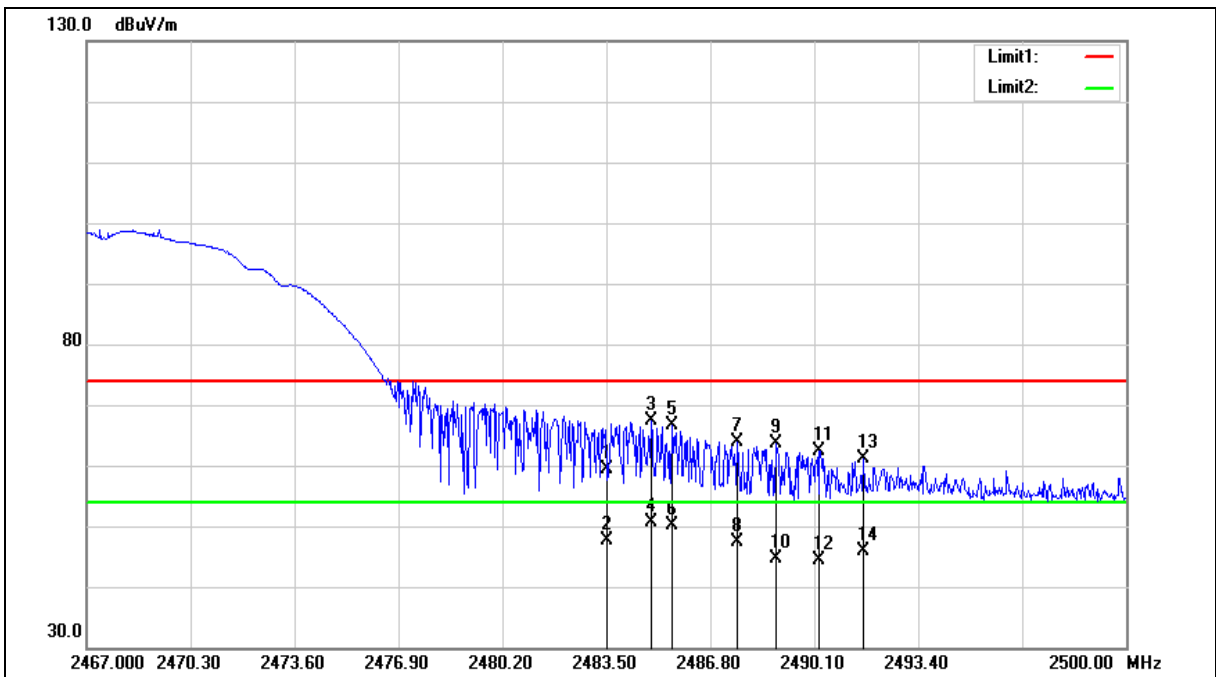



Standard:	FCC Part 15.247	Test Distance:	3 m
Test item:	Band edge	Power:	DC 3.3 V
Frequency:	2467 MHz	Temp.(°C)/Hum.(%RH):	26(°C)/60 %RH
Mode:	Mode 2		
Ant.Polar.:	Vertical		

No.	Frequency (MHz)	Reading (dBUV)	Correct Factor (dB/m)	Result (dBUV/m)	Limit (dBUV/m)	Margin (dB)	Remark
1	2483.500	60.08	-0.82	59.26	74.00	-14.74	peak
2	2483.500	48.47	-0.82	47.65	54.00	-6.35	AVG
3	2484.919	68.29	-0.82	67.47	74.00	-6.53	peak
4	2484.919	51.37	-0.82	50.55	54.00	-3.45	AVG
5	2485.579	67.48	-0.82	66.66	74.00	-7.34	peak
6	2485.579	50.88	-0.82	50.06	54.00	-3.94	AVG
7	2487.658	64.60	-0.80	63.80	74.00	-10.20	peak
8	2487.658	48.27	-0.80	47.47	54.00	-6.53	AVG
9	2488.879	64.53	-0.80	63.73	74.00	-10.27	peak
10	2488.879	45.51	-0.80	44.71	54.00	-9.29	AVG
11	2490.265	63.14	-0.80	62.34	74.00	-11.66	peak
12	2490.265	45.26	-0.80	44.46	54.00	-9.54	AVG
13	2491.651	61.90	-0.79	61.11	74.00	-12.89	peak
14	2491.651	46.66	-0.79	45.87	54.00	-8.13	AVG

Note:1.Result (dBUV/m) = Correct Factor (dB/m) + Reading(dBUV).

2.Correction factor (dB/m) = Antenna Factor (dB/m) + Cable loss (dB) – Pre-Amplifier gain (dB).

3. When the peak results are less than average limit, so not need to evaluate the average.



Standard:	FCC Part 15.247	Test Distance:	3 m
Test item:	Band edge	Power:	DC 3.3 V
Frequency:	2472 MHz	Temp.(°C)/Hum.(%RH):	26(°C)/60 %RH
Mode:	Mode 2		
Ant.Polar.:	Horizontal		

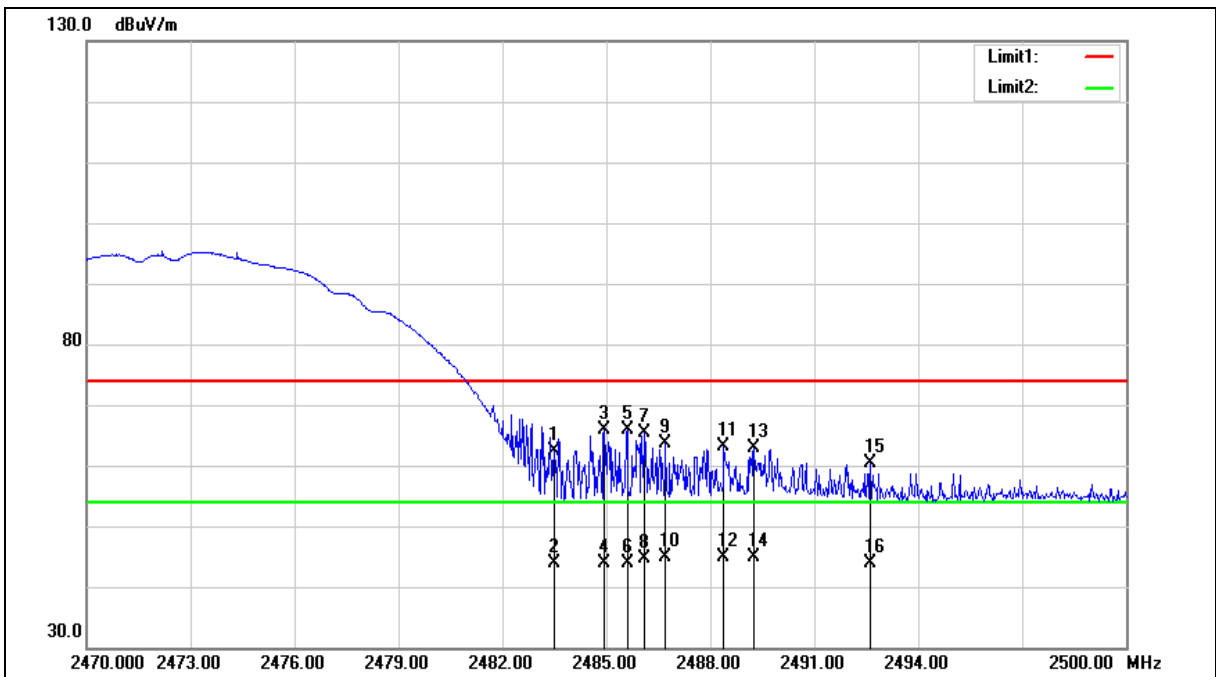



Standard:	FCC Part 15.247	Test Distance:	3 m
Test item:	Band edge	Power:	DC 3.3 V
Frequency:	2472 MHz	Temp.(°C)/Hum.(%RH):	26(°C)/60 %RH
Mode:	Mode 2		
Ant.Polar.:	Horizontal		

No.	Frequency (MHz)	Reading (dBuV)	Correct Factor (dB/m)	Result (dBuV/m)	Limit (dBuV/m)	Margin (dB)	Remark
1	2483.500	63.08	-0.82	62.26	74.00	-11.74	peak
2	2483.500	44.78	-0.82	43.96	54.00	-10.04	AVG
3	2484.940	66.80	-0.82	65.98	74.00	-8.02	peak
4	2484.940	44.74	-0.82	43.92	54.00	-10.08	AVG
5	2485.600	66.68	-0.82	65.86	74.00	-8.14	peak
6	2485.600	44.63	-0.82	43.81	54.00	-10.19	AVG
7	2486.080	66.23	-0.82	65.41	74.00	-8.59	peak
8	2486.080	45.49	-0.82	44.67	54.00	-9.33	AVG
9	2486.710	64.44	-0.81	63.63	74.00	-10.37	peak
10	2486.710	45.77	-0.81	44.96	54.00	-9.04	AVG
11	2488.390	63.82	-0.80	63.02	74.00	-10.98	peak
12	2488.390	45.72	-0.80	44.92	54.00	-9.08	AVG
13	2489.260	63.70	-0.80	62.90	74.00	-11.10	peak
14	2489.260	45.72	-0.80	44.92	54.00	-9.08	AVG
15	2492.620	61.19	-0.79	60.40	74.00	-13.60	peak
16	2492.620	44.74	-0.79	43.95	54.00	-10.05	AVG

Note:1.Result (dBuV/m) = Correct Factor (dB/m) + Reading(dBuV).

2.Correction factor (dB/m) = Antenna Factor (dB/m) + Cable loss (dB) – Pre-Amplifier gain (dB).

3. When the peak results are less than average limit, so not need to evaluate the average.



Standard:	FCC Part 15.247	Test Distance:	3 m
Test item:	Band edge	Power:	DC 3.3 V
Frequency:	2472 MHz	Temp.(°C)/Hum.(%RH):	26(°C)/60 %RH
Mode:	Mode 2		
Ant.Polar.:	Vertical		

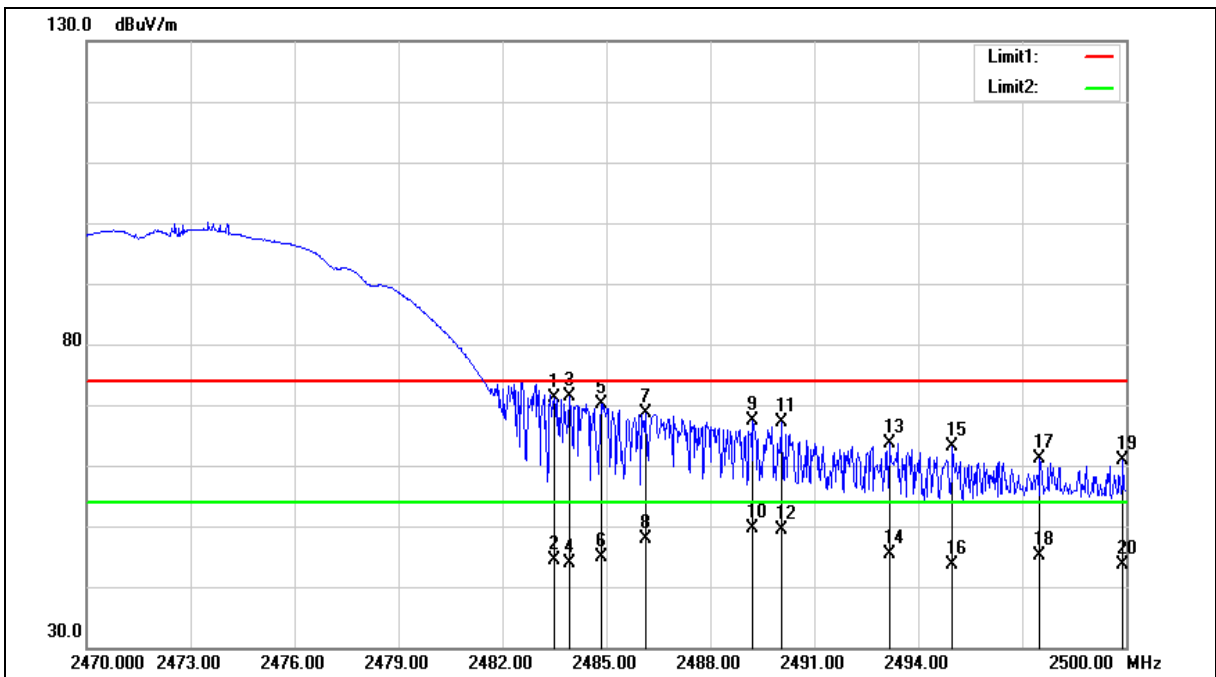



Standard:	FCC Part 15.247	Test Distance:	3 m
Test item:	Band edge	Power:	DC 3.3 V
Frequency:	2472 MHz	Temp.(°C)/Hum.(%RH):	26(°C)/60 %RH
Mode:	Mode 2		
Ant.Polar.:	Vertical		

No.	Frequency (MHz)	Reading (dBuV)	Correct Factor (dB/m)	Result (dBuV/m)	Limit (dBuV/m)	Margin (dB)	Remark
1	2483.500	71.96	-0.82	71.14	74.00	-2.86	peak
2	2483.500	45.26	-0.82	44.44	54.00	-9.56	AVG
3	2483.920	72.15	-0.82	71.33	74.00	-2.67	peak
4	2483.920	44.67	-0.82	43.85	54.00	-10.15	AVG
5	2484.850	70.97	-0.82	70.15	74.00	-3.85	peak
6	2484.850	45.80	-0.82	44.98	54.00	-9.02	AVG
7	2486.140	69.50	-0.82	68.68	74.00	-5.32	peak
8	2486.140	48.58	-0.82	47.76	54.00	-6.24	AVG
9	2489.230	68.11	-0.80	67.31	74.00	-6.69	peak
10	2489.230	50.32	-0.80	49.52	54.00	-4.48	AVG
11	2490.040	67.92	-0.80	67.12	74.00	-6.88	peak
12	2490.040	50.07	-0.80	49.27	54.00	-4.73	AVG
13	2493.160	64.46	-0.79	63.67	74.00	-10.33	peak
14	2493.160	46.19	-0.79	45.40	54.00	-8.60	AVG
15	2494.990	63.97	-0.78	63.19	74.00	-10.81	peak
16	2494.990	44.33	-0.78	43.55	54.00	-10.45	AVG
17	2497.510	62.01	-0.77	61.24	74.00	-12.76	peak
18	2497.510	45.98	-0.77	45.21	54.00	-8.79	AVG
19	2499.910	61.61	-0.76	60.85	74.00	-13.15	peak
20	2499.910	44.37	-0.76	43.61	54.00	-10.39	AVG

Note:1.Result (dBuV/m) = Correct Factor (dB/m) + Reading(dBuV).

2.Correction factor (dB/m) = Antenna Factor (dB/m) + Cable loss (dB) – Pre-Amplifier gain (dB).

3. When the peak results are less than average limit, so not need to evaluate the average.



Standard:	FCC Part 15.247	Test Distance:	3 m
Test item:	Band edge	Power:	DC 3.3 V
Frequency:	2412 MHz	Temp.(°C)/Hum.(%RH):	26(°C)/60 %RH
Mode:	Mode 3		
Ant.Polar.:	Horizontal		

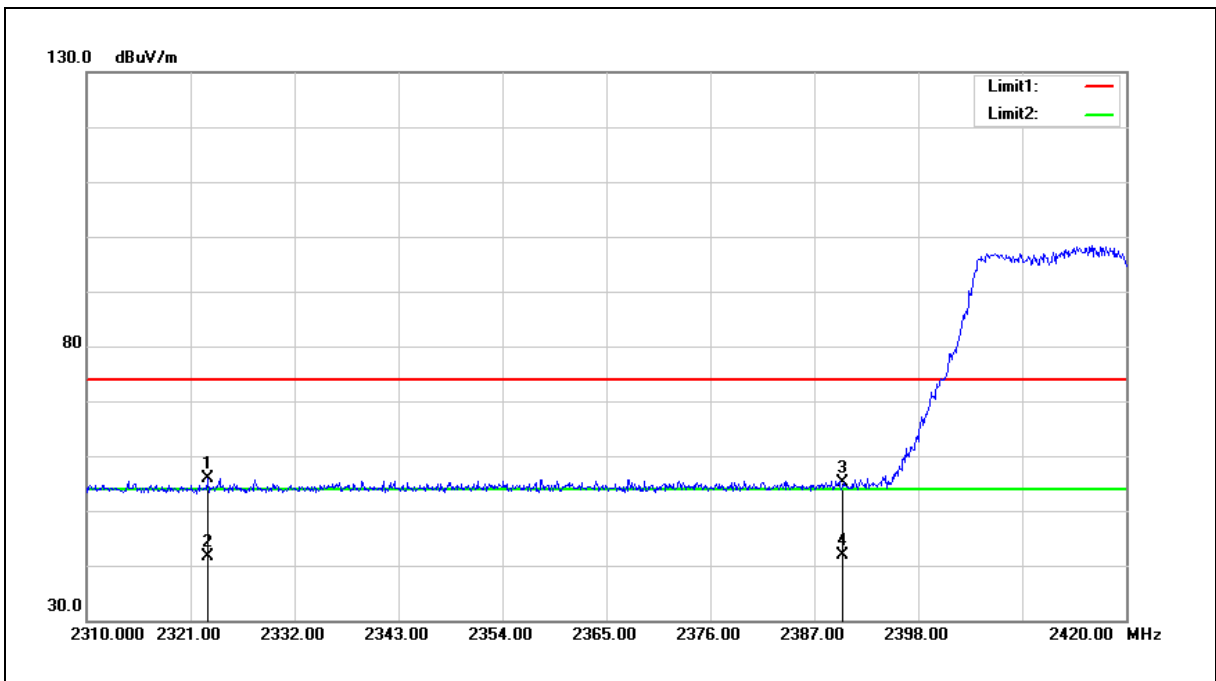

No.	Frequency (MHz)	Reading (dBuV)	Correct Factor (dB/m)	Result (dBuV/m)	Limit (dBuV/m)	Margin (dB)	Remark
1	2322.870	57.23	-1.41	55.82	74.00	-18.18	peak
2	2322.870	42.95	-1.41	41.54	54.00	-12.46	AVG
3	2390.000	56.25	-1.17	55.08	74.00	-18.92	peak
4	2390.000	42.95	-1.17	41.78	54.00	-12.22	AVG

Note:1.Result (dBuV/m) = Correct Factor (dB/m) + Reading(dBuV).

2.Correction factor (dB/m) = Antenna Factor (dB/m) + Cable loss (dB) – Pre-Amplifier gain (dB).

3. When the peak results are less than average limit, so not need to evaluate the average.



Standard:	FCC Part 15.247	Test Distance:	3 m
Test item:	Band edge	Power:	DC 3.3 V
Frequency:	2412 MHz	Temp.(°C)/Hum.(%RH):	26(°C)/60 %RH
Mode:	Mode 3		
Ant.Polar.:	Vertical		

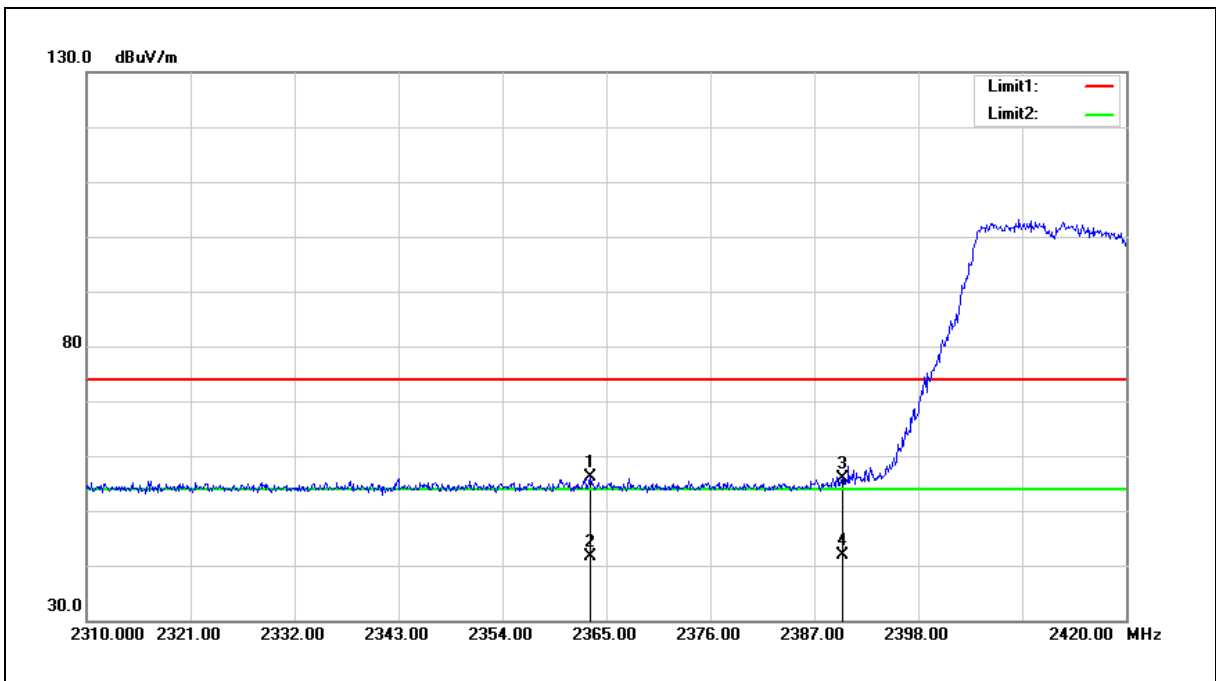

No.	Frequency (MHz)	Reading (dBuV)	Correct Factor (dB/m)	Result (dBuV/m)	Limit (dBuV/m)	Margin (dB)	Remark
1	2363.240	57.32	-1.26	56.06	74.00	-17.94	peak
2	2363.240	42.91	-1.26	41.65	54.00	-12.35	AVG
3	2390.000	56.97	-1.17	55.80	74.00	-18.20	peak
4	2390.000	43.02	-1.17	41.85	54.00	-12.15	AVG

Note:1.Result (dBuV/m) = Correct Factor (dB/m) + Reading(dBuV).

2.Correction factor (dB/m) = Antenna Factor (dB/m) + Cable loss (dB) – Pre-Amplifier gain (dB).

3. When the peak results are less than average limit, so not need to evaluate the average.



Standard:	FCC Part 15.247	Test Distance:	3 m
Test item:	Band edge	Power:	DC 3.3 V
Frequency:	2462 MHz	Temp.(°C)/Hum.(%RH):	26(°C)/60 %RH
Mode:	Mode 3		
Ant.Polar.:	Horizontal		

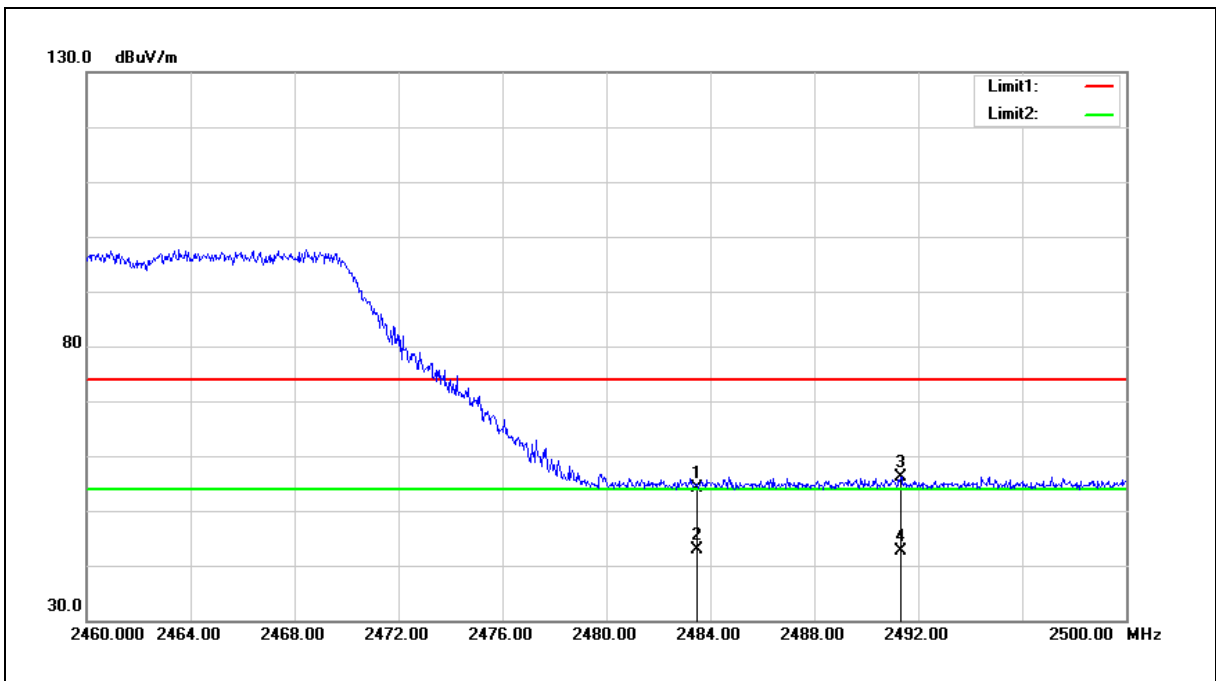

No.	Frequency (MHz)	Reading (dBuV)	Correct Factor (dB/m)	Result (dBuV/m)	Limit (dBuV/m)	Margin (dB)	Remark
1	2483.500	55.00	-0.82	54.18	74.00	-19.82	peak
2	2483.500	43.59	-0.82	42.77	54.00	-11.23	AVG
3	2491.320	56.93	-0.79	56.14	74.00	-17.86	peak
4	2491.320	43.33	-0.79	42.54	54.00	-11.46	AVG

Note:1.Result (dBuV/m) = Correct Factor (dB/m) + Reading(dBuV).

2.Correction factor (dB/m) = Antenna Factor (dB/m) + Cable loss (dB) – Pre-Amplifier gain (dB).

3. When the peak results are less than average limit, so not need to evaluate the average.



Standard:	FCC Part 15.247	Test Distance:	3 m
Test item:	Band edge	Power:	DC 3.3 V
Frequency:	2462 MHz	Temp.(°C)/Hum.(%RH):	26(°C)/60 %RH
Mode:	Mode 3		
Ant.Polar.:	Vertical		

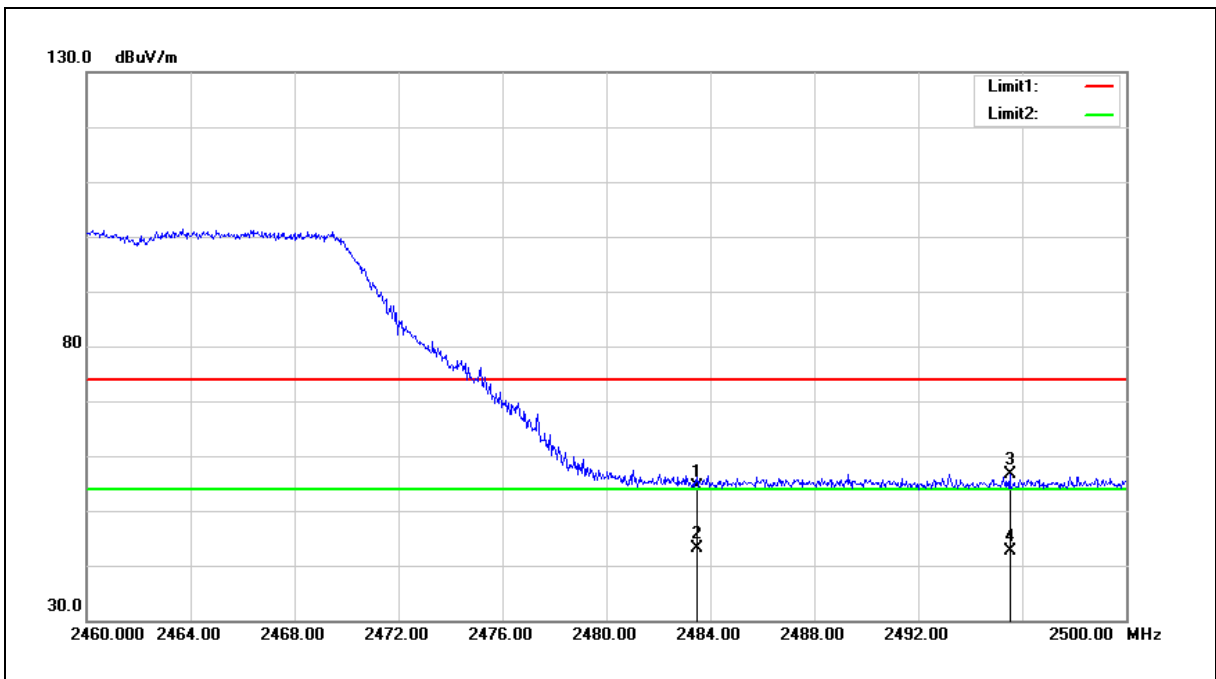

No.	Frequency (MHz)	Reading (dBuV)	Correct Factor (dB/m)	Result (dBuV/m)	Limit (dBuV/m)	Margin (dB)	Remark
1	2483.500	55.26	-0.82	54.44	74.00	-19.56	peak
2	2483.500	43.92	-0.82	43.10	54.00	-10.90	AVG
3	2495.520	57.39	-0.78	56.61	74.00	-17.39	peak
4	2495.520	43.29	-0.78	42.51	54.00	-11.49	AVG

Note:1.Result (dBuV/m) = Correct Factor (dB/m) + Reading(dBuV).

2.Correction factor (dB/m) = Antenna Factor (dB/m) + Cable loss (dB) – Pre-Amplifier gain (dB).

3. When the peak results are less than average limit, so not need to evaluate the average.



Standard:	FCC Part 15.247	Test Distance:	3 m
Test item:	Band edge	Power:	DC 3.3 V
Frequency:	2467 MHz	Temp.(°C)/Hum.(%RH):	26(°C)/60 %RH
Mode:	Mode 3		
Ant.Polar.:	Horizontal		

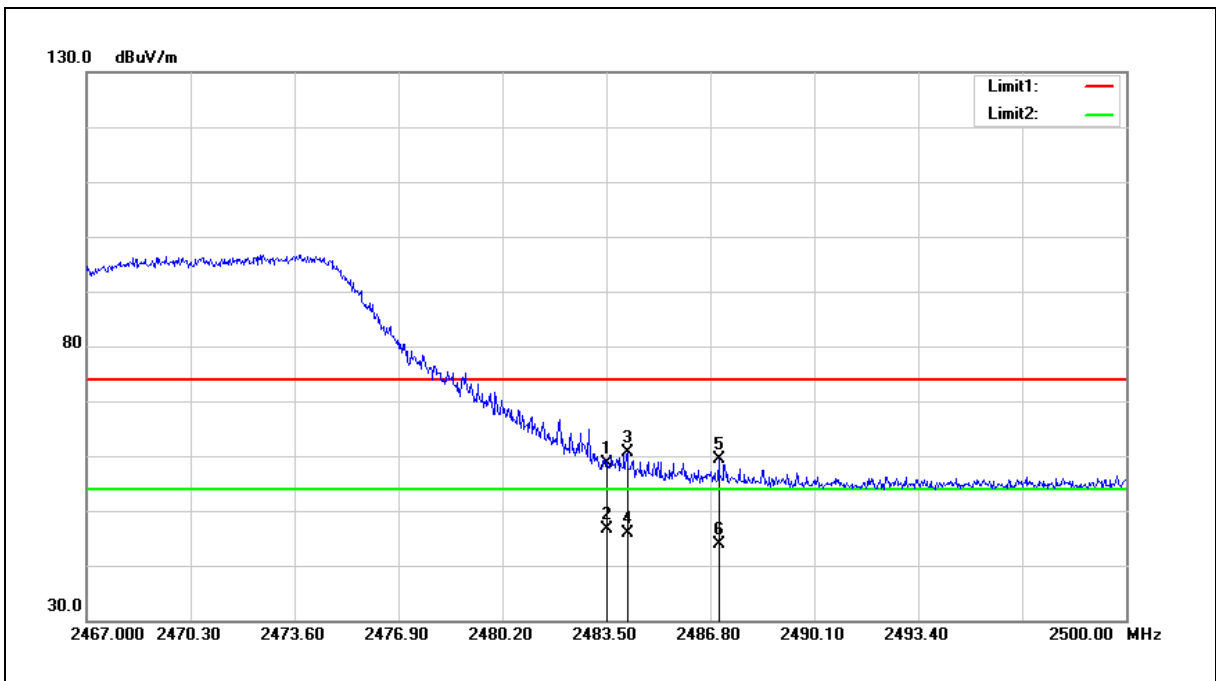

No.	Frequency (MHz)	Reading (dBuV)	Correct Factor (dB/m)	Result (dBuV/m)	Limit (dBuV/m)	Margin (dB)	Remark
1	2483.500	59.53	-0.82	58.71	74.00	-15.29	peak
2	2483.500	47.55	-0.82	46.73	54.00	-7.27	AVG
3	2484.160	61.54	-0.82	60.72	74.00	-13.28	peak
4	2484.160	46.67	-0.82	45.85	54.00	-8.15	AVG
5	2487.064	60.23	-0.81	59.42	74.00	-14.58	peak
6	2487.064	44.77	-0.81	43.96	54.00	-10.04	AVG

Note:1.Result (dBuV/m) = Correct Factor (dB/m) + Reading(dBuV).

2.Correction factor (dB/m) = Antenna Factor (dB/m) + Cable loss (dB) – Pre-Amplifier gain (dB).

3. When the peak results are less than average limit, so not need to evaluate the average.



Standard:	FCC Part 15.247	Test Distance:	3 m
Test item:	Band edge	Power:	DC 3.3 V
Frequency:	2467 MHz	Temp.(°C)/Hum.(%RH):	26(°C)/60 %RH
Mode:	Mode 3		
Ant.Polar.:	Vertical		

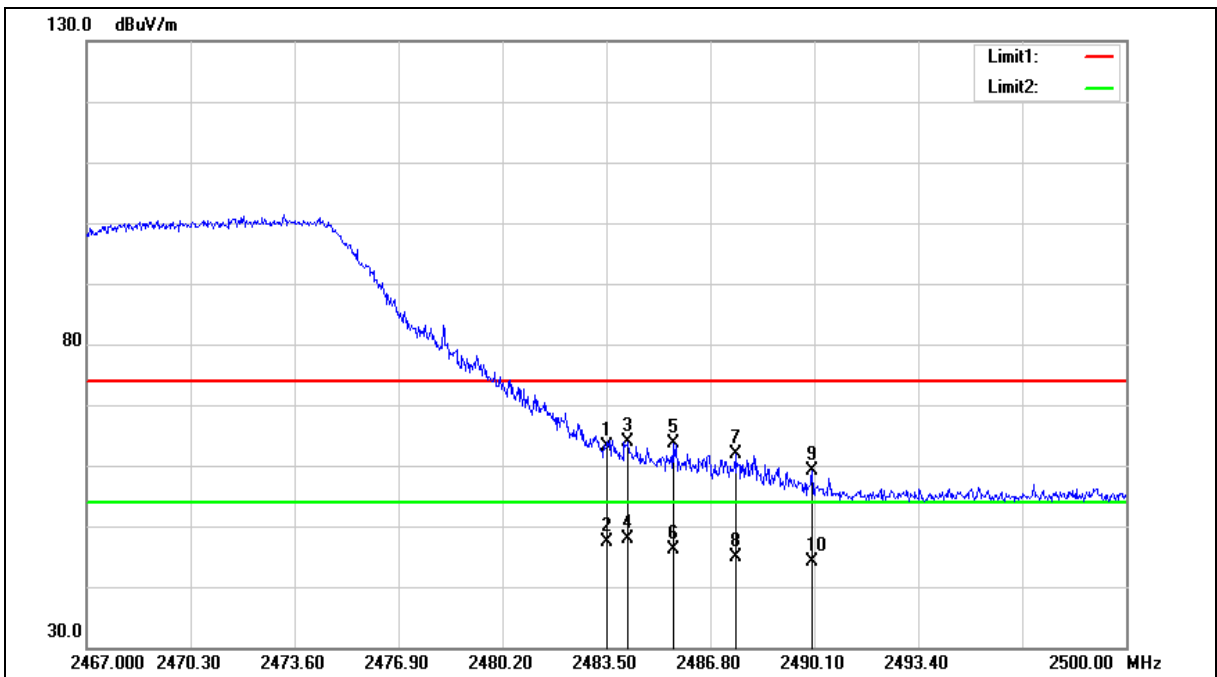



Standard:	FCC Part 15.247	Test Distance:	3 m
Test item:	Band edge	Power:	DC 3.3 V
Frequency:	2467 MHz	Temp.(°C)/Hum.(%RH):	26(°C)/60 %RH
Mode:	Mode 3		
Ant.Polar.:	Vertical		

No.	Frequency (MHz)	Reading (dBuV)	Correct Factor (dB/m)	Result (dBuV/m)	Limit (dBuV/m)	Margin (dB)	Remark
1	2483.500	63.95	-0.82	63.13	74.00	-10.87	peak
2	2483.500	48.25	-0.82	47.43	54.00	-6.57	AVG
3	2484.193	64.79	-0.82	63.97	74.00	-10.03	peak
4	2484.193	48.74	-0.82	47.92	54.00	-6.08	AVG
5	2485.612	64.55	-0.82	63.73	74.00	-10.27	peak
6	2485.612	46.89	-0.82	46.07	54.00	-7.93	AVG
7	2487.592	62.60	-0.80	61.80	74.00	-12.20	peak
8	2487.592	45.66	-0.80	44.86	54.00	-9.14	AVG
9	2490.034	59.88	-0.80	59.08	74.00	-14.92	peak
10	2490.034	44.81	-0.80	44.01	54.00	-9.99	AVG

Note:1.Result (dBuV/m) = Correct Factor (dB/m) + Reading(dBuV).

2.Correction factor (dB/m) = Antenna Factor (dB/m) + Cable loss (dB) – Pre-Amplifier gain (dB).

3. When the peak results are less than average limit, so not need to evaluate the average.



Standard:	FCC Part 15.247	Test Distance:	3 m
Test item:	Band edge	Power:	DC 3.3 V
Frequency:	2472 MHz	Temp.(°C)/Hum.(%RH):	26(°C)/60 %RH
Mode:	Mode 3		
Ant.Polar.:	Horizontal		

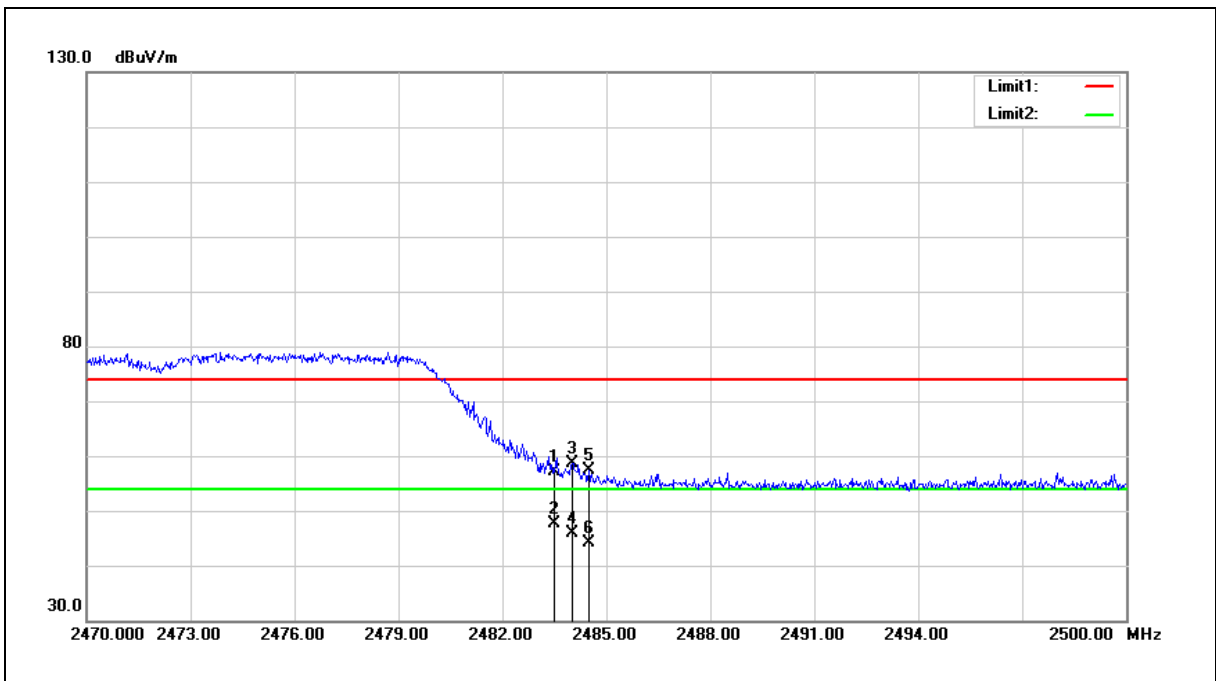

No.	Frequency (MHz)	Reading (dBuV)	Correct Factor (dB/m)	Result (dBuV/m)	Limit (dBuV/m)	Margin (dB)	Remark
1	2483.500	57.96	-0.82	57.14	74.00	-16.86	peak
2	2483.500	48.35	-0.82	47.53	54.00	-6.47	AVG
3	2484.010	59.45	-0.82	58.63	74.00	-15.37	peak
4	2484.010	46.80	-0.82	45.98	54.00	-8.02	AVG
5	2484.490	58.10	-0.82	57.28	74.00	-16.72	peak
6	2484.490	44.98	-0.82	44.16	54.00	-9.84	AVG

Note:1.Result (dBuV/m) = Correct Factor (dB/m) + Reading(dBuV).

2.Correction factor (dB/m) = Antenna Factor (dB/m) + Cable loss (dB) – Pre-Amplifier gain (dB).

3. When the peak results are less than average limit, so not need to evaluate the average.



Standard:	FCC Part 15.247	Test Distance:	3 m
Test item:	Band edge	Power:	DC 3.3 V
Frequency:	2472 MHz	Temp.(°C)/Hum.(%RH):	26(°C)/60 %RH
Mode:	Mode 3		
Ant.Polar.:	Vertical		

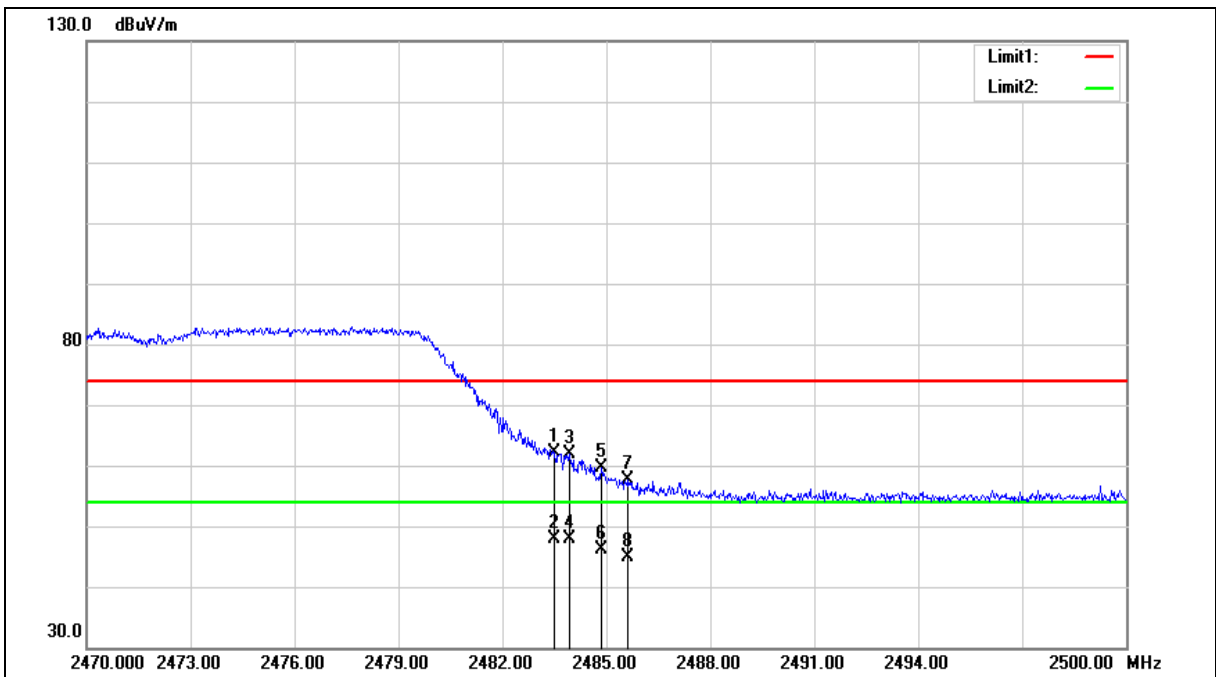



Standard:	FCC Part 15.247	Test Distance:	3 m
Test item:	Band edge	Power:	DC 3.3 V
Frequency:	2472 MHz	Temp.(°C)/Hum.(%RH):	26(°C)/60 %RH
Mode:	Mode 3		
Ant.Polar.:	Vertical		

No.	Frequency (MHz)	Reading (dBuV)	Correct Factor (dB/m)	Result (dBuV/m)	Limit (dBuV/m)	Margin (dB)	Remark
1	2483.500	62.89	-0.82	62.07	74.00	-11.93	peak
2	2483.500	48.79	-0.82	47.97	54.00	-6.03	AVG
3	2483.920	62.63	-0.82	61.81	74.00	-12.19	peak
4	2483.920	48.59	-0.82	47.77	54.00	-6.23	AVG
5	2484.850	60.46	-0.82	59.64	74.00	-14.36	peak
6	2484.850	46.83	-0.82	46.01	54.00	-7.99	AVG
7	2485.630	58.51	-0.82	57.69	74.00	-16.31	peak
8	2485.630	45.58	-0.82	44.76	54.00	-9.24	AVG

Note:1.Result (dBuV/m) = Correct Factor (dB/m) + Reading(dBuV).

2.Correction factor (dB/m) = Antenna Factor (dB/m) + Cable loss (dB) – Pre-Amplifier gain (dB).

3. When the peak results are less than average limit, so not need to evaluate the average.

MIMO A+B

Standard:	FCC Part 15.247	Test Distance:	3 m
Test item:	Band edge	Power:	DC 3.3 V
Frequency:	2412 MHz	Temp.(°C)/Hum.(%RH):	26(°C)/60 %RH
Mode:	Mode 4		
Ant.Polar.:	Horizontal		

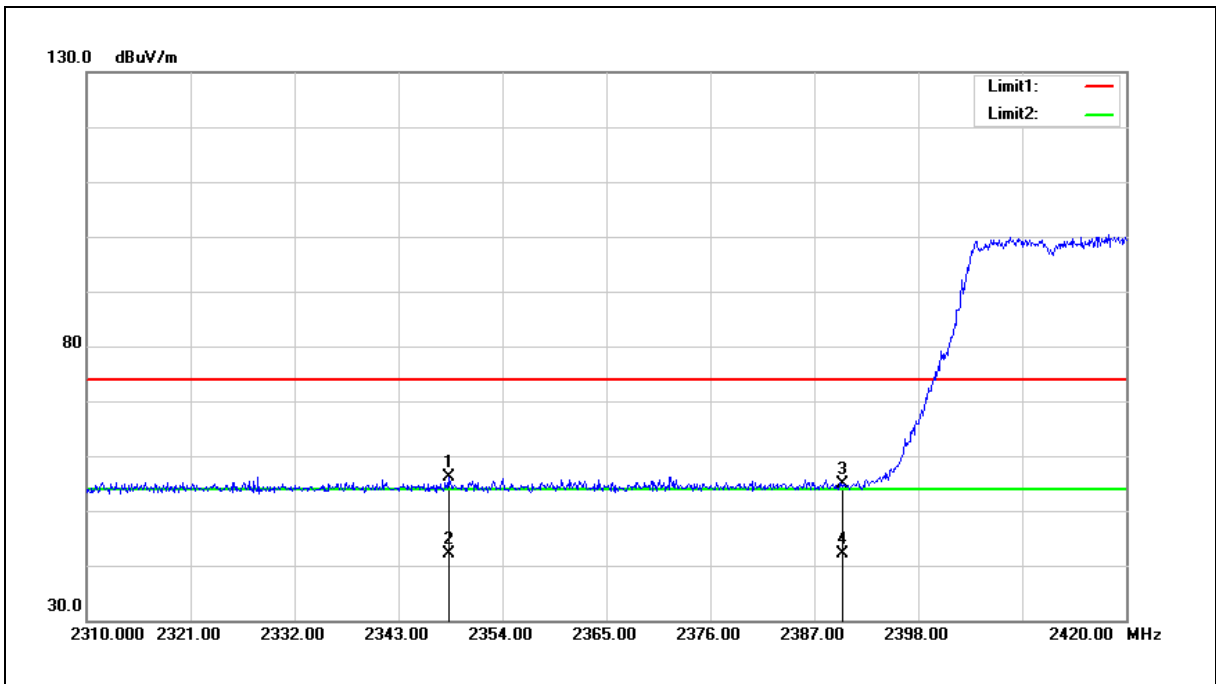

No.	Frequency (MHz)	Reading (dBuV)	Correct Factor (dB/m)	Result (dBuV/m)	Limit (dBuV/m)	Margin (dB)	Remark
1	2348.280	57.53	-1.31	56.22	74.00	-17.78	peak
2	2348.280	43.48	-1.31	42.17	54.00	-11.83	AVG
3	2390.000	56.05	-1.17	54.88	74.00	-19.12	peak
4	2390.000	43.23	-1.17	42.06	54.00	-11.94	AVG

Note:1.Result (dBuV/m) = Correct Factor (dB/m) + Reading(dBuV).

2.Correction factor (dB/m) = Antenna Factor (dB/m) + Cable loss (dB) – Pre-Amplifier gain (dB).

3. When the peak results are less than average limit, so not need to evaluate the average.



Standard:	FCC Part 15.247	Test Distance:	3 m
Test item:	Band edge	Power:	DC 3.3 V
Frequency:	2412 MHz	Temp.(°C)/Hum.(%RH):	26(°C)/60 %RH
Mode:	Mode 4		
Ant.Polar.:	Vertical		

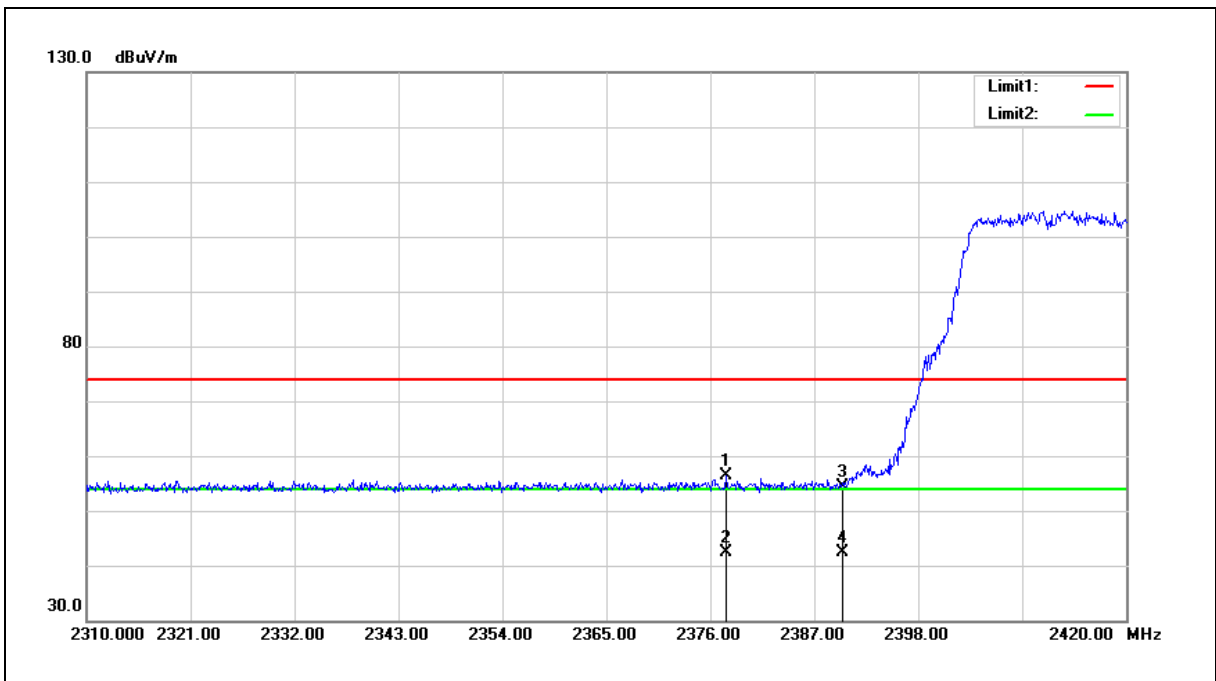

No.	Frequency (MHz)	Reading (dBuV)	Correct Factor (dB/m)	Result (dBuV/m)	Limit (dBuV/m)	Margin (dB)	Remark
1	2377.650	57.49	-1.21	56.28	74.00	-17.72	peak
2	2377.650	43.56	-1.21	42.35	54.00	-11.65	AVG
3	2390.000	55.57	-1.17	54.40	74.00	-19.60	peak
4	2390.000	43.44	-1.17	42.27	54.00	-11.73	AVG

Note:1.Result (dBuV/m) = Correct Factor (dB/m) + Reading(dBuV).

2.Correction factor (dB/m) = Antenna Factor (dB/m) + Cable loss (dB) – Pre-Amplifier gain (dB).

3. When the peak results are less than average limit, so not need to evaluate the average.



Standard:	FCC Part 15.247	Test Distance:	3 m
Test item:	Band edge	Power:	DC 3.3 V
Frequency:	2462 MHz	Temp.(°C)/Hum.(%RH):	26(°C)/60 %RH
Mode:	Mode 4		
Ant.Polar.:	Horizontal		

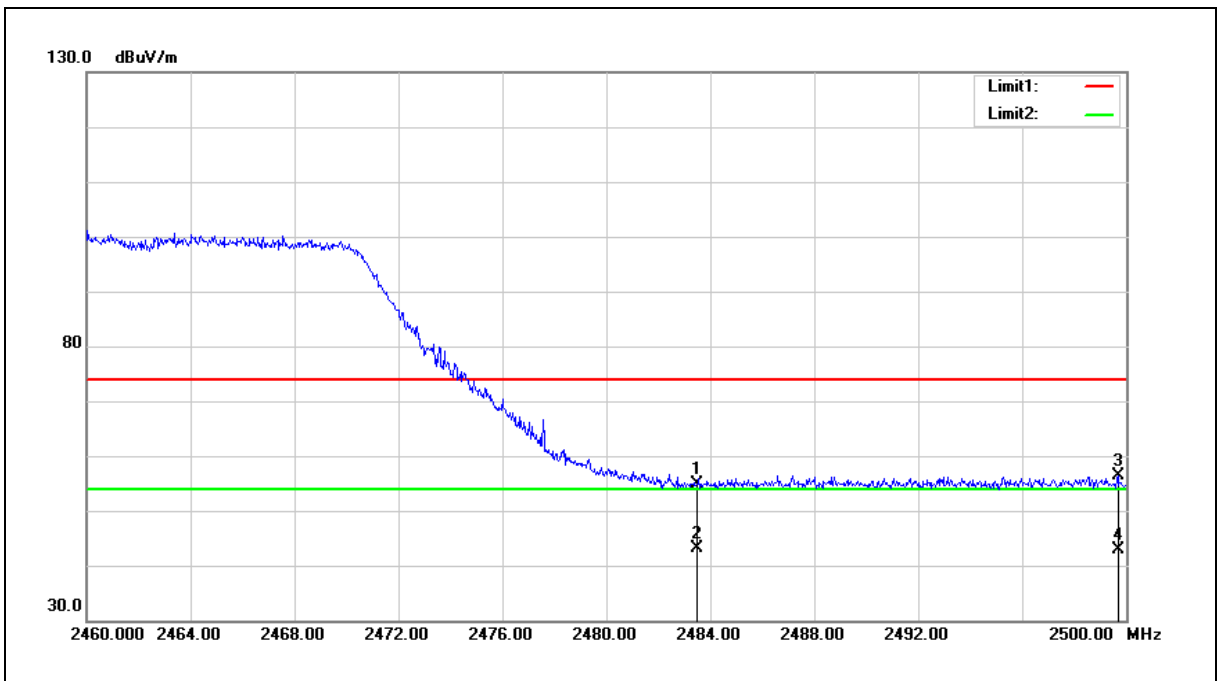

No.	Frequency (MHz)	Reading (dBuV)	Correct Factor (dB/m)	Result (dBuV/m)	Limit (dBuV/m)	Margin (dB)	Remark
1	2483.500	55.70	-0.82	54.88	74.00	-19.12	peak
2	2483.500	43.95	-0.82	43.13	54.00	-10.87	AVG
3	2499.680	57.13	-0.76	56.37	74.00	-17.63	peak
4	2499.680	43.70	-0.76	42.94	54.00	-11.06	AVG

Note:1.Result (dBuV/m) = Correct Factor (dB/m) + Reading(dBuV).

2.Correction factor (dB/m) = Antenna Factor (dB/m) + Cable loss (dB) – Pre-Amplifier gain (dB).

3. When the peak results are less than average limit, so not need to evaluate the average.



Standard:	FCC Part 15.247	Test Distance:	3 m
Test item:	Band edge	Power:	DC 3.3 V
Frequency:	2462 MHz	Temp.(°C)/Hum.(%RH):	26(°C)/60 %RH
Mode:	Mode 4		
Ant.Polar.:	Vertical		

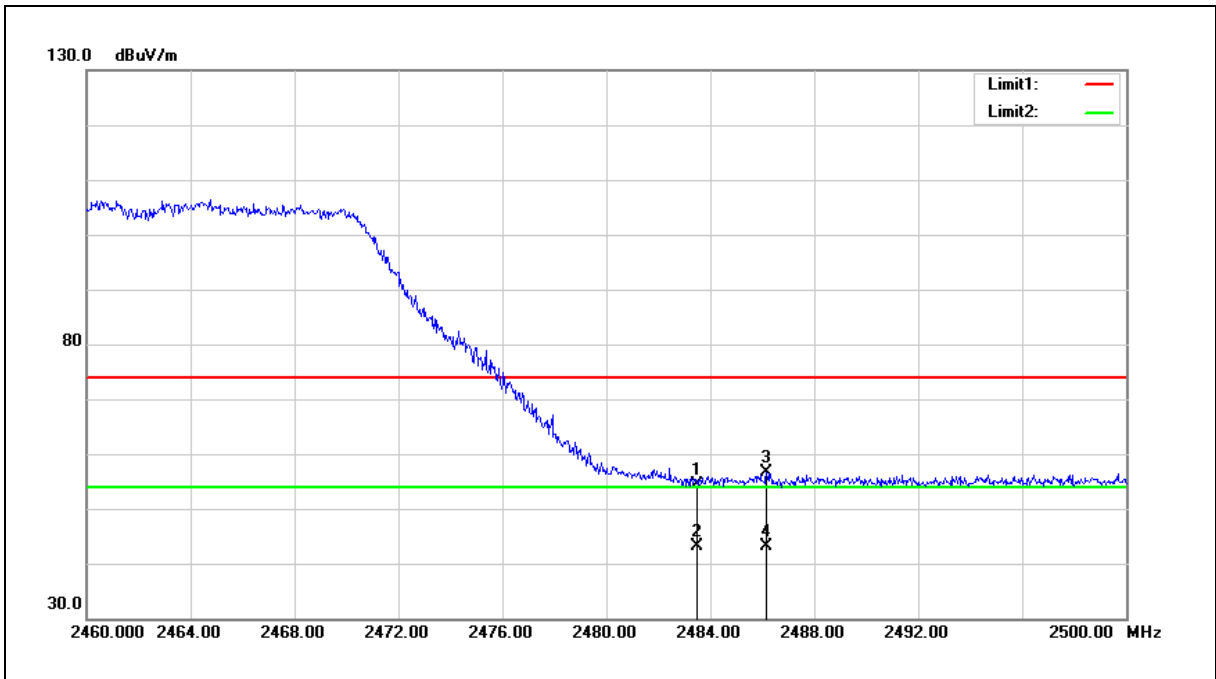

No.	Frequency (MHz)	Reading (dBuV)	Correct Factor (dB/m)	Result (dBuV/m)	Limit (dBuV/m)	Margin (dB)	Remark
1	2483.500	55.19	-0.82	54.37	74.00	-19.63	peak
2	2483.500	44.07	-0.82	43.25	54.00	-10.75	AVG
3	2486.160	57.48	-0.82	56.66	74.00	-17.34	peak
4	2486.160	43.94	-0.82	43.12	54.00	-10.88	AVG

Note:1.Result (dBuV/m) = Correct Factor (dB/m) + Reading(dBuV).

2.Correction factor (dB/m) = Antenna Factor (dB/m) + Cable loss (dB) – Pre-Amplifier gain (dB).

3. When the peak results are less than average limit, so not need to evaluate the average.



Standard:	FCC Part 15.247	Test Distance:	3 m
Test item:	Band edge	Power:	DC 3.3 V
Frequency:	2467 MHz	Temp.(°C)/Hum.(%RH):	26(°C)/60 %RH
Mode:	Mode 4		
Ant.Polar.:	Horizontal		

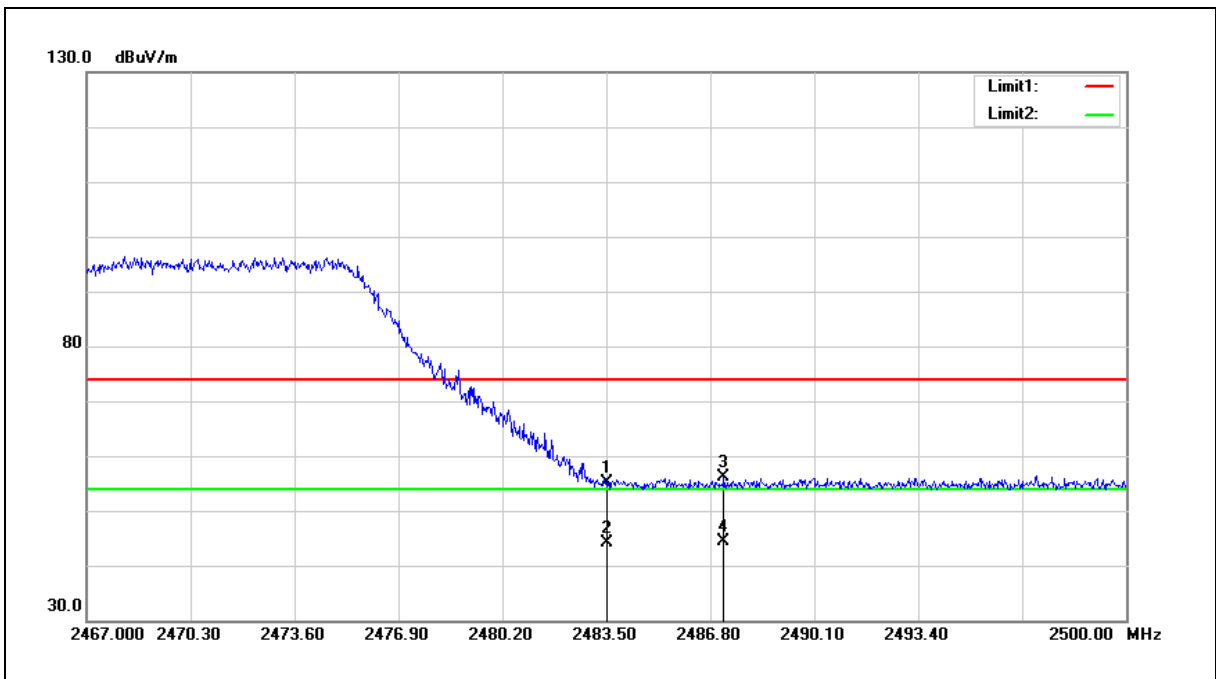

No.	Frequency (MHz)	Reading (dBuV)	Correct Factor (dB/m)	Result (dBuV/m)	Limit (dBuV/m)	Margin (dB)	Remark
1	2483.500	56.00	-0.82	55.18	74.00	-18.82	peak
2	2483.500	45.05	-0.82	44.23	54.00	-9.77	AVG
3	2487.229	57.05	-0.81	56.24	74.00	-17.76	peak
4	2487.229	45.12	-0.81	44.31	54.00	-9.69	AVG

Note:1.Result (dBuV/m) = Correct Factor (dB/m) + Reading(dBuV).

2.Correction factor (dB/m) = Antenna Factor (dB/m) + Cable loss (dB) – Pre-Amplifier gain (dB).

3. When the peak results are less than average limit, so not need to evaluate the average.



Standard:	FCC Part 15.247	Test Distance:	3 m
Test item:	Band edge	Power:	DC 3.3 V
Frequency:	2467 MHz	Temp.(°C)/Hum.(%RH):	26(°C)/60 %RH
Mode:	Mode 4		
Ant.Polar.:	Vertical		

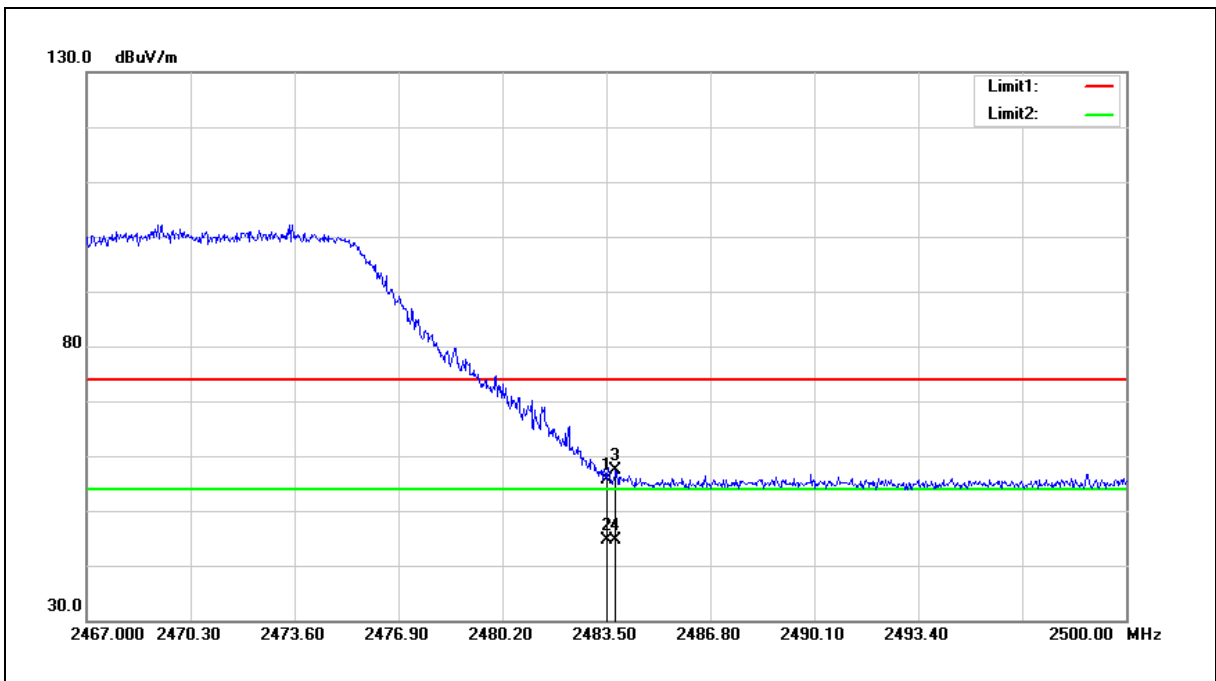

No.	Frequency (MHz)	Reading (dBuV)	Correct Factor (dB/m)	Result (dBuV/m)	Limit (dBuV/m)	Margin (dB)	Remark
1	2483.500	56.56	-0.82	55.74	74.00	-18.26	peak
2	2483.500	45.38	-0.82	44.56	54.00	-9.44	AVG
3	2483.797	58.10	-0.82	57.28	74.00	-16.72	peak
4	2483.797	45.57	-0.82	44.75	54.00	-9.25	AVG

Note:1.Result (dBuV/m) = Correct Factor (dB/m) + Reading(dBuV).

2.Correction factor (dB/m) = Antenna Factor (dB/m) + Cable loss (dB) – Pre-Amplifier gain (dB).

3. When the peak results are less than average limit, so not need to evaluate the average.



Standard:	FCC Part 15.247	Test Distance:	3 m
Test item:	Band edge	Power:	DC 3.3 V
Frequency:	2472 MHz	Temp.(°C)/Hum.(%RH):	26(°C)/60 %RH
Mode:	Mode 4		
Ant.Polar.:	Horizontal		

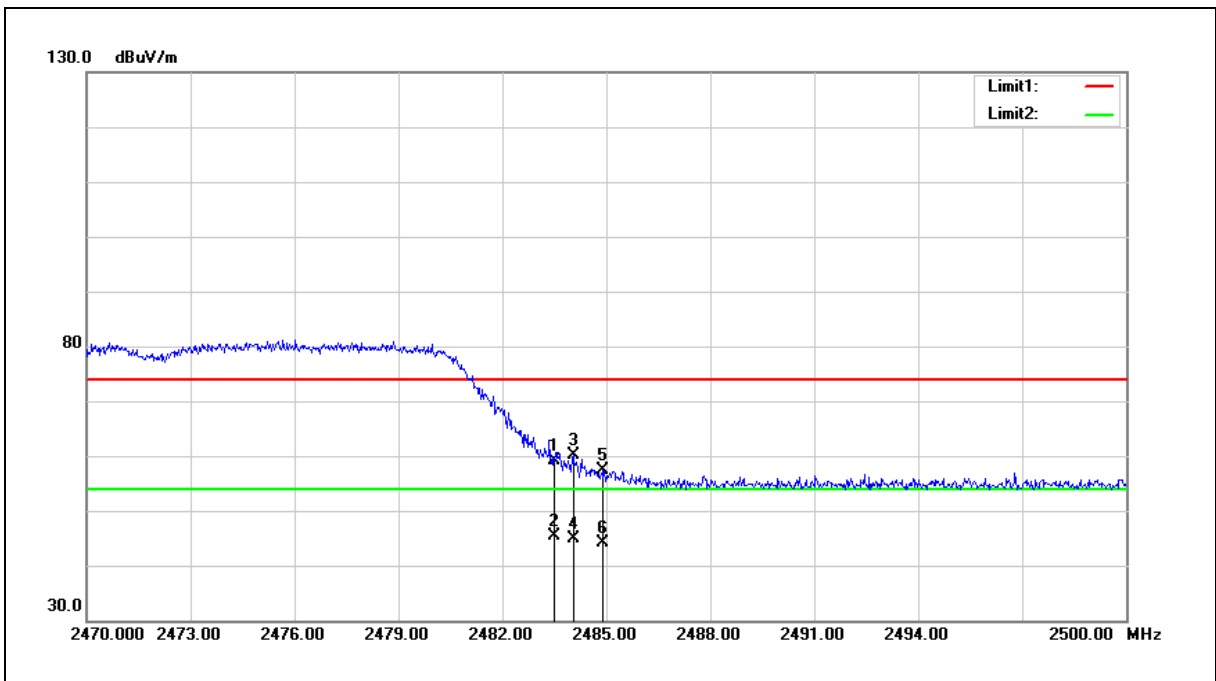

No.	Frequency (MHz)	Reading (dBuV)	Correct Factor (dB/m)	Result (dBuV/m)	Limit (dBuV/m)	Margin (dB)	Remark
1	2483.500	59.87	-0.82	59.05	74.00	-14.95	peak
2	2483.500	46.09	-0.82	45.27	54.00	-8.73	AVG
3	2484.040	60.95	-0.82	60.13	74.00	-13.87	peak
4	2484.040	45.80	-0.82	44.98	54.00	-9.02	AVG
5	2484.910	58.22	-0.82	57.40	74.00	-16.60	peak
6	2484.910	44.97	-0.82	44.15	54.00	-9.85	AVG

- Note:1.Result (dBuV/m) = Correct Factor (dB/m) + Reading(dBuV).
- 2.Correction factor (dB/m) = Antenna Factor (dB/m) + Cable loss (dB) – Pre-Amplifier gain (dB).
3. When the peak results are less than average limit, so not need to evaluate the average.



Standard:	FCC Part 15.247	Test Distance:	3 m
Test item:	Band edge	Power:	DC 3.3 V
Frequency:	2472 MHz	Temp.(°C)/Hum.(%RH):	26(°C)/60 %RH
Mode:	Mode 4		
Ant.Polar.:	Vertical		

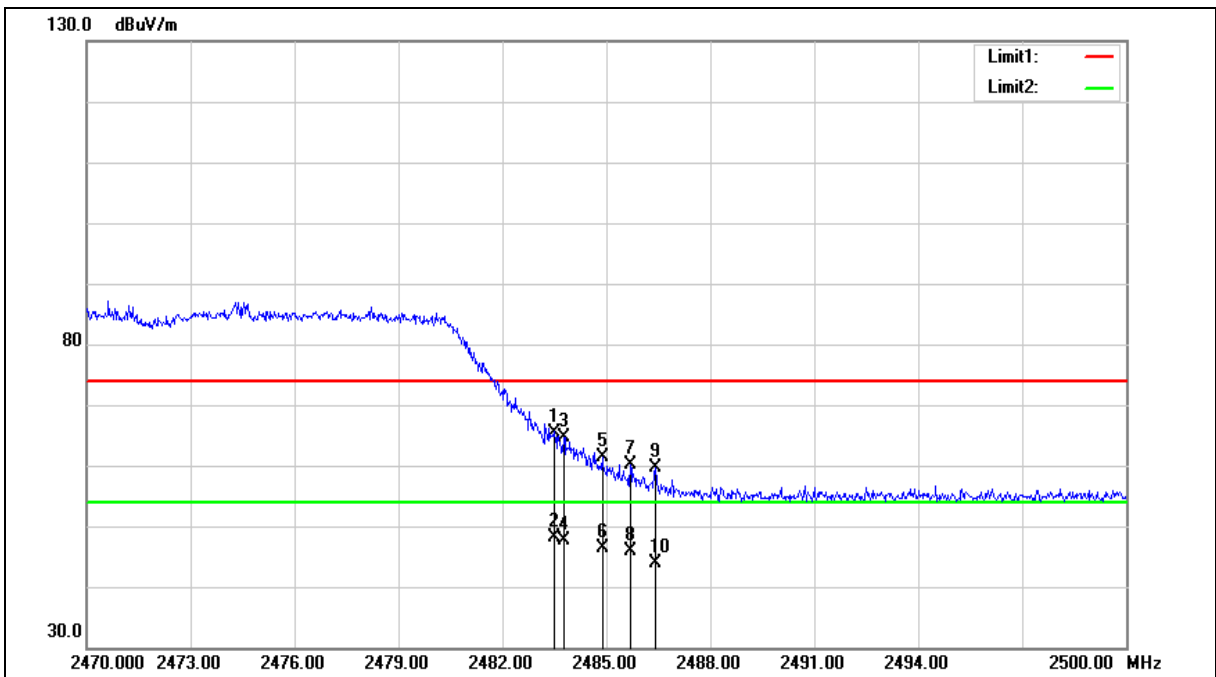



Standard:	FCC Part 15.247	Test Distance:	3 m
Test item:	Band edge	Power:	DC 3.3 V
Frequency:	2472 MHz	Temp.(°C)/Hum.(%RH):	26(°C)/60 %RH
Mode:	Mode 4		
Ant.Polar.:	Vertical		

No.	Frequency (MHz)	Reading (dBuV)	Correct Factor (dB/m)	Result (dBuV/m)	Limit (dBuV/m)	Margin (dB)	Remark
1	2483.500	66.32	-0.82	65.50	74.00	-8.50	peak
2	2483.500	48.83	-0.82	48.01	54.00	-5.99	AVG
3	2483.770	65.52	-0.82	64.70	74.00	-9.30	peak
4	2483.770	48.47	-0.82	47.65	54.00	-6.35	AVG
5	2484.880	62.17	-0.82	61.35	74.00	-12.65	peak
6	2484.880	47.17	-0.82	46.35	54.00	-7.65	AVG
7	2485.690	60.83	-0.82	60.01	74.00	-13.99	peak
8	2485.690	46.62	-0.82	45.80	54.00	-8.20	AVG
9	2486.410	60.51	-0.82	59.69	74.00	-14.31	peak
10	2486.410	44.76	-0.82	43.94	54.00	-10.06	AVG

Note:1.Result (dBuV/m) = Correct Factor (dB/m) + Reading(dBuV).

2.Correction factor (dB/m) = Antenna Factor (dB/m) + Cable loss (dB) – Pre-Amplifier gain (dB).

3. When the peak results are less than average limit, so not need to evaluate the average.



Standard:	FCC Part 15.247	Test Distance:	3 m
Test item:	Band edge	Power:	DC 3.3 V
Frequency:	2422 MHz	Temp.(°C)/Hum.(%RH):	26(°C)/60 %RH
Mode:	Mode 5		
Ant.Polar.:	Horizontal		

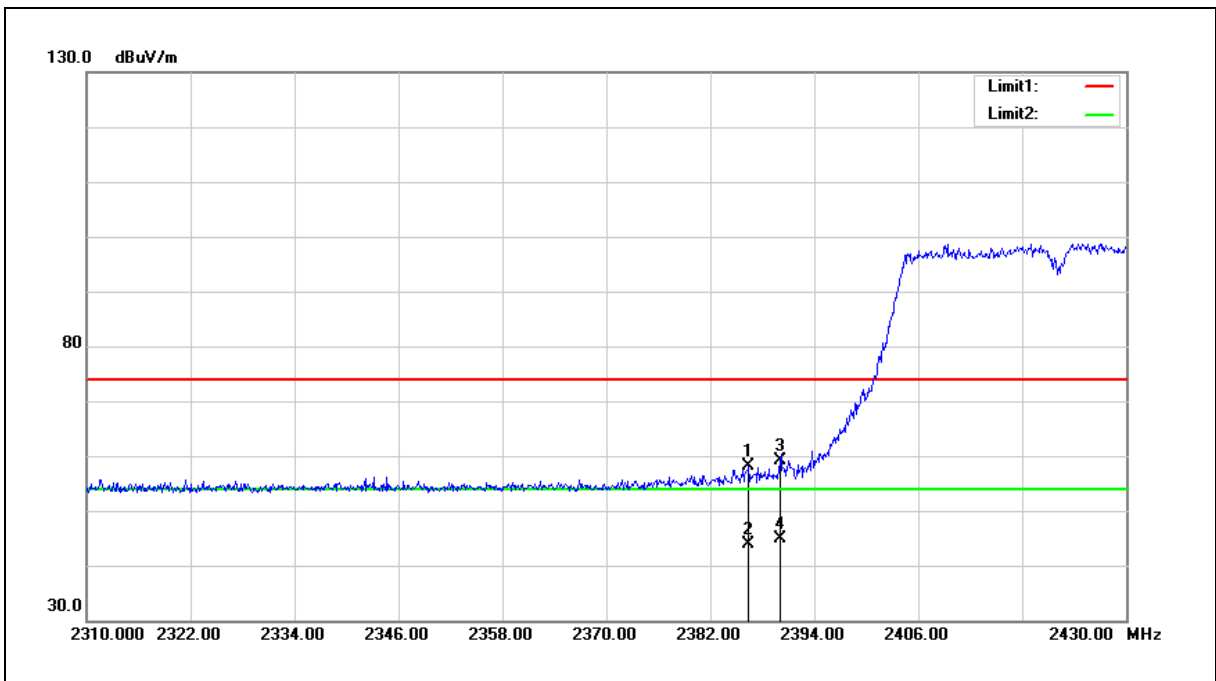

No.	Frequency (MHz)	Reading (dBuV)	Correct Factor (dB/m)	Result (dBuV/m)	Limit (dBuV/m)	Margin (dB)	Remark
1	2386.440	59.27	-1.18	58.09	74.00	-15.91	peak
2	2386.440	44.99	-1.18	43.81	54.00	-10.19	AVG
3	2390.000	60.27	-1.17	59.10	74.00	-14.90	peak
4	2390.000	46.08	-1.17	44.91	54.00	-9.09	AVG

Note:1.Result (dBuV/m) = Correct Factor (dB/m) + Reading(dBuV).

2.Correction factor (dB/m) = Antenna Factor (dB/m) + Cable loss (dB) – Pre-Amplifier gain (dB).

3. When the peak results are less than average limit, so not need to evaluate the average.



Standard:	FCC Part 15.247	Test Distance:	3 m
Test item:	Band edge	Power:	DC 3.3 V
Frequency:	2422 MHz	Temp.(°C)/Hum.(%RH):	26(°C)/60 %RH
Mode:	Mode 5		
Ant.Polar.:	Vertical		

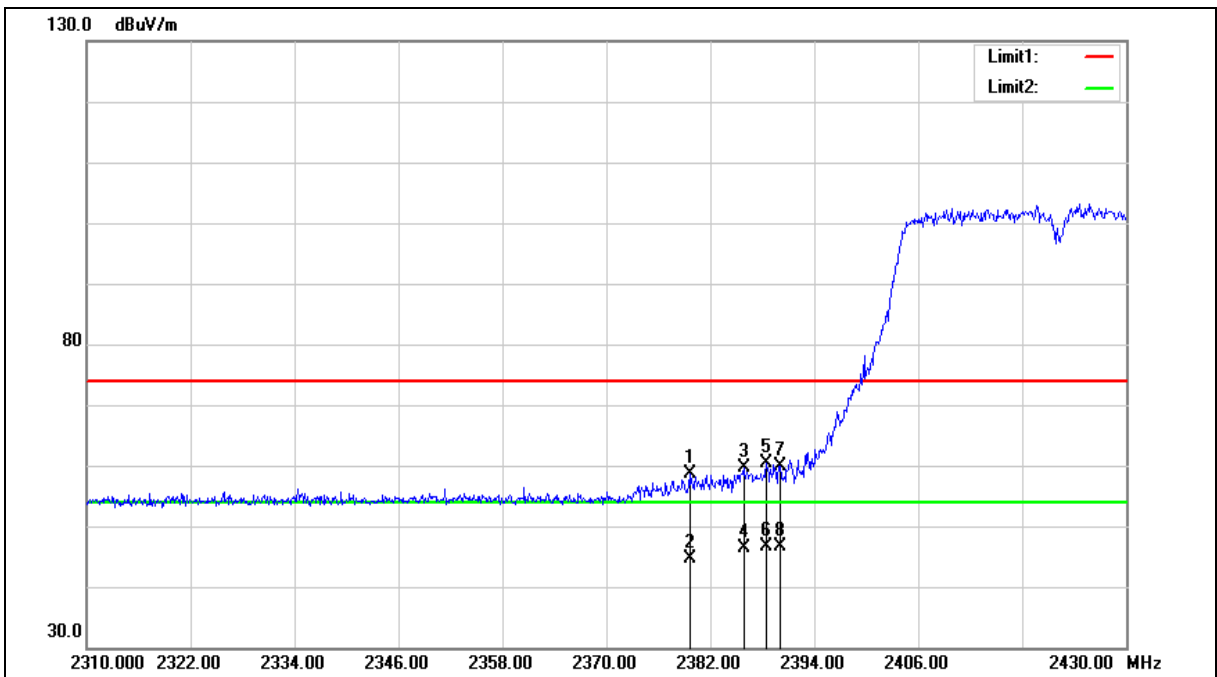



Standard:	FCC Part 15.247	Test Distance:	3 m
Test item:	Band edge	Power:	DC 3.3 V
Frequency:	2422 MHz	Temp.(°C)/Hum.(%RH):	26(°C)/60 %RH
Mode:	Mode 5		
Ant.Polar.:	Vertical		

No.	Frequency (MHz)	Reading (dBuV)	Correct Factor (dB/m)	Result (dBuV/m)	Limit (dBuV/m)	Margin (dB)	Remark
1	2379.600	59.95	-1.20	58.75	74.00	-15.25	peak
2	2379.600	45.92	-1.20	44.72	54.00	-9.28	AVG
3	2385.840	60.70	-1.18	59.52	74.00	-14.48	peak
4	2385.840	47.45	-1.18	46.27	54.00	-7.73	AVG
5	2388.480	61.44	-1.17	60.27	74.00	-13.73	peak
6	2388.480	47.82	-1.17	46.65	54.00	-7.35	AVG
7	2390.000	61.08	-1.17	59.91	74.00	-14.09	peak
8	2390.000	47.74	-1.17	46.57	54.00	-7.43	AVG

Note:1.Result (dBuV/m) = Correct Factor (dB/m) + Reading(dBuV).

2.Correction factor (dB/m) = Antenna Factor (dB/m) + Cable loss (dB) – Pre-Amplifier gain (dB).

3. When the peak results are less than average limit, so not need to evaluate the average.



Standard:	FCC Part 15.247	Test Distance:	3 m
Test item:	Band edge	Power:	DC 3.3 V
Frequency:	2452 MHz	Temp.(°C)/Hum.(%RH):	26(°C)/60 %RH
Mode:	Mode 5		
Ant.Polar.:	Horizontal		

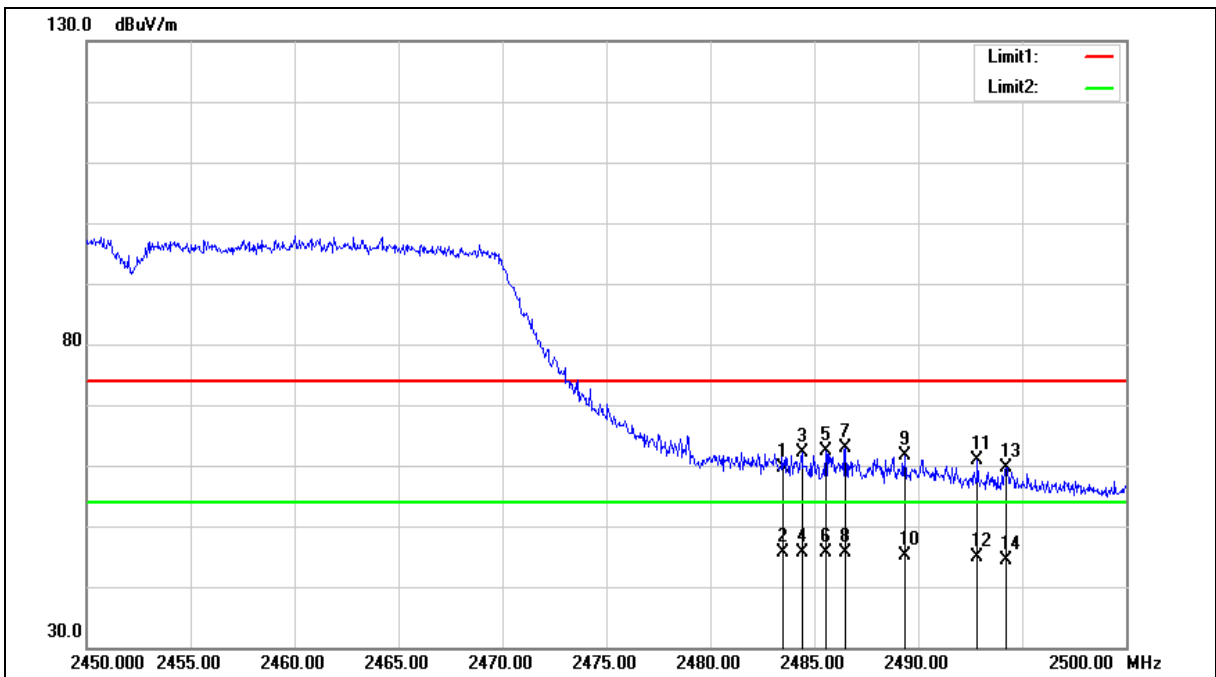



Standard:	FCC Part 15.247	Test Distance:	3 m
Test item:	Band edge	Power:	DC 3.3 V
Frequency:	2452 MHz	Temp.(°C)/Hum.(%RH):	26(°C)/60 %RH
Mode:	Mode 5		
Ant.Polar.:	Horizontal		

No.	Frequency (MHz)	Reading (dBuV)	Correct Factor (dB/m)	Result (dBuV/m)	Limit (dBuV/m)	Margin (dB)	Remark
1	2483.500	60.52	-0.82	59.70	74.00	-14.30	peak
2	2483.500	46.55	-0.82	45.73	54.00	-8.27	AVG
3	2484.400	62.84	-0.82	62.02	74.00	-11.98	peak
4	2484.400	46.47	-0.82	45.65	54.00	-8.35	AVG
5	2485.550	63.18	-0.82	62.36	74.00	-11.64	peak
6	2485.550	46.37	-0.82	45.55	54.00	-8.45	AVG
7	2486.500	63.79	-0.82	62.97	74.00	-11.03	peak
8	2486.500	46.57	-0.82	45.75	54.00	-8.25	AVG
9	2489.350	62.37	-0.80	61.57	74.00	-12.43	peak
10	2489.350	46.01	-0.80	45.21	54.00	-8.79	AVG
11	2492.850	61.62	-0.79	60.83	74.00	-13.17	peak
12	2492.850	45.72	-0.79	44.93	54.00	-9.07	AVG
13	2494.250	60.49	-0.78	59.71	74.00	-14.29	peak
14	2494.250	45.18	-0.78	44.40	54.00	-9.60	AVG

Note:1.Result (dBuV/m) = Correct Factor (dB/m) + Reading(dBuV).

2.Correction factor (dB/m) = Antenna Factor (dB/m) + Cable loss (dB) – Pre-Amplifier gain (dB).

3. When the peak results are less than average limit, so not need to evaluate the average.



Standard:	FCC Part 15.247	Test Distance:	3 m
Test item:	Band edge	Power:	DC 3.3 V
Frequency:	2452 MHz	Temp.(°C)/Hum.(%RH):	26(°C)/60 %RH
Mode:	Mode 5		
Ant.Polar.:	Vertical		

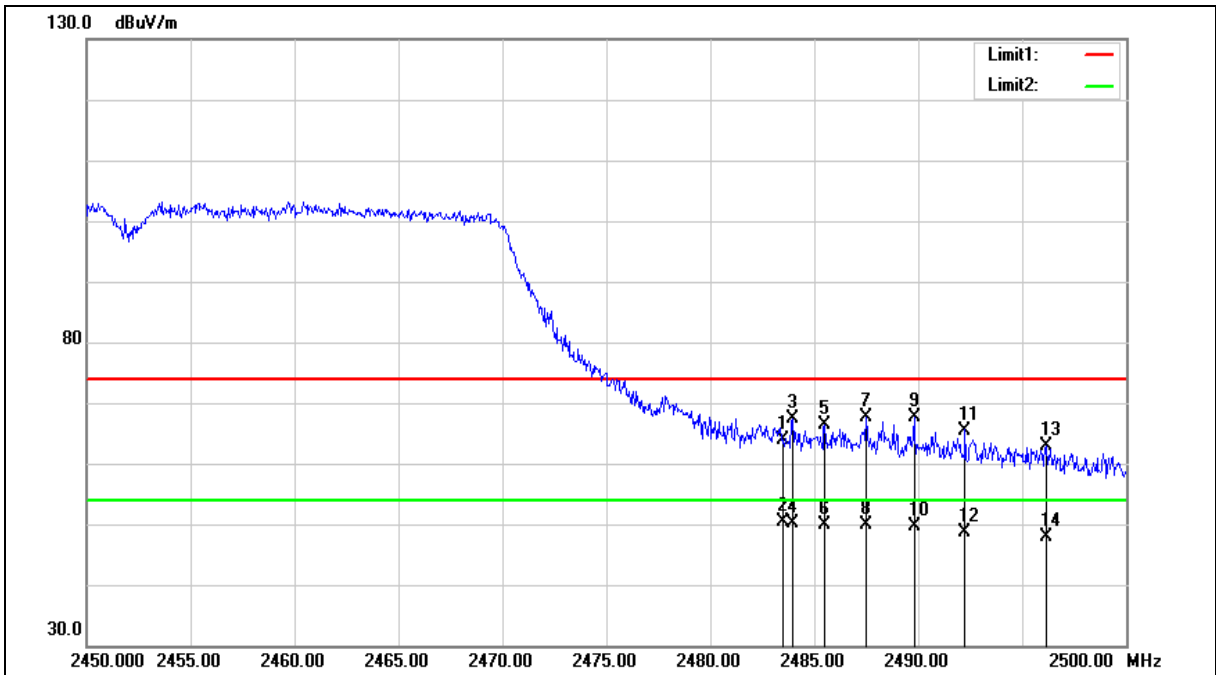



Standard:	FCC Part 15.247	Test Distance:	3 m
Test item:	Band edge	Power:	DC 3.3 V
Frequency:	2452 MHz	Temp.(°C)/Hum.(%RH):	26(°C)/60 %RH
Mode:	Mode 5		
Ant.Polar.:	Vertical		

No.	Frequency (MHz)	Reading (dBUV)	Correct Factor (dB/m)	Result (dBUV/m)	Limit (dBUV/m)	Margin (dB)	Remark
1	2483.500	64.66	-0.82	63.84	74.00	-10.16	peak
2	2483.500	51.10	-0.82	50.28	54.00	-3.72	AVG
3	2483.950	68.28	-0.82	67.46	74.00	-6.54	peak
4	2483.950	50.84	-0.82	50.02	54.00	-3.98	AVG
5	2485.500	67.17	-0.82	66.35	74.00	-7.65	peak
6	2485.500	50.69	-0.82	49.87	54.00	-4.13	AVG
7	2487.500	68.42	-0.80	67.62	74.00	-6.38	peak
8	2487.500	50.76	-0.80	49.96	54.00	-4.04	AVG
9	2489.800	68.50	-0.80	67.70	74.00	-6.30	peak
10	2489.800	50.43	-0.80	49.63	54.00	-4.37	AVG
11	2492.250	66.29	-0.79	65.50	74.00	-8.50	peak
12	2492.250	49.42	-0.79	48.63	54.00	-5.37	AVG
13	2496.150	63.67	-0.77	62.90	74.00	-11.10	peak
14	2496.150	48.76	-0.77	47.99	54.00	-6.01	AVG

Note:1.Result (dBUV/m) = Correct Factor (dB/m) + Reading(dBUV).

2.Correction factor (dB/m) = Antenna Factor (dB/m) + Cable loss (dB) – Pre-Amplifier gain (dB).

3. When the peak results are less than average limit, so not need to evaluate the average.



Standard:	FCC Part 15.247	Test Distance:	3 m
Test item:	Band edge	Power:	DC 3.3 V
Frequency:	2457 MHz	Temp.(°C)/Hum.(%RH):	26(°C)/60 %RH
Mode:	Mode 5		
Ant.Polar.:	Horizontal		

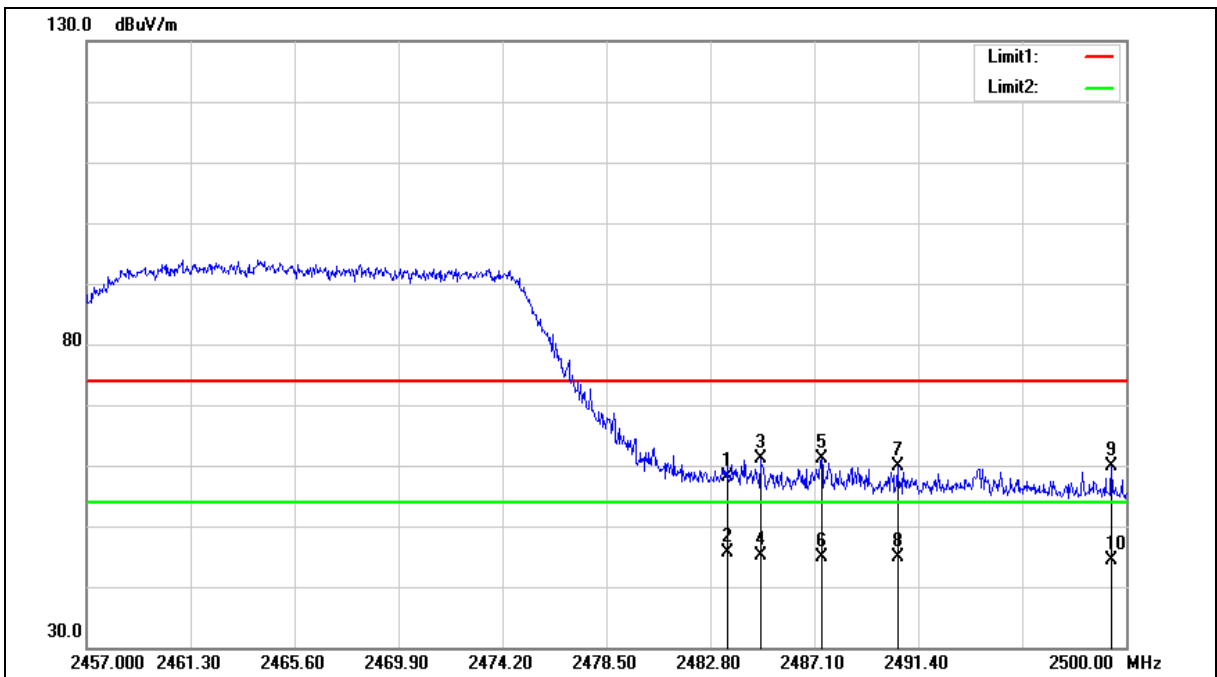



Standard:	FCC Part 15.247	Test Distance:	3 m
Test item:	Band edge	Power:	DC 3.3 V
Frequency:	2457 MHz	Temp.(°C)/Hum.(%RH):	26(°C)/60 %RH
Mode:	Mode 5		
Ant.Polar.:	Horizontal		

No.	Frequency (MHz)	Reading (dBuV)	Correct Factor (dB/m)	Result (dBuV/m)	Limit (dBuV/m)	Margin (dB)	Remark
1	2483.500	58.99	-0.82	58.17	74.00	-15.83	peak
2	2483.500	46.36	-0.82	45.54	54.00	-8.46	AVG
3	2484.864	61.84	-0.82	61.02	74.00	-12.98	peak
4	2484.864	46.07	-0.82	45.25	54.00	-8.75	AVG
5	2487.401	61.99	-0.80	61.19	74.00	-12.81	peak
6	2487.401	45.77	-0.80	44.97	54.00	-9.03	AVG
7	2490.540	60.59	-0.79	59.80	74.00	-14.20	peak
8	2490.540	45.55	-0.79	44.76	54.00	-9.24	AVG
9	2499.398	60.70	-0.76	59.94	74.00	-14.06	peak
10	2499.398	45.18	-0.76	44.42	54.00	-9.58	AVG

Note:1.Result (dBuV/m) = Correct Factor (dB/m) + Reading(dBuV).

2.Correction factor (dB/m) = Antenna Factor (dB/m) + Cable loss (dB) – Pre-Amplifier gain (dB).

3. When the peak results are less than average limit, so not need to evaluate the average.



Standard:	FCC Part 15.247	Test Distance:	3 m
Test item:	Band edge	Power:	DC 3.3 V
Frequency:	2457 MHz	Temp.(°C)/Hum.(%RH):	26(°C)/60 %RH
Mode:	Mode 5		
Ant.Polar.:	Vertical		

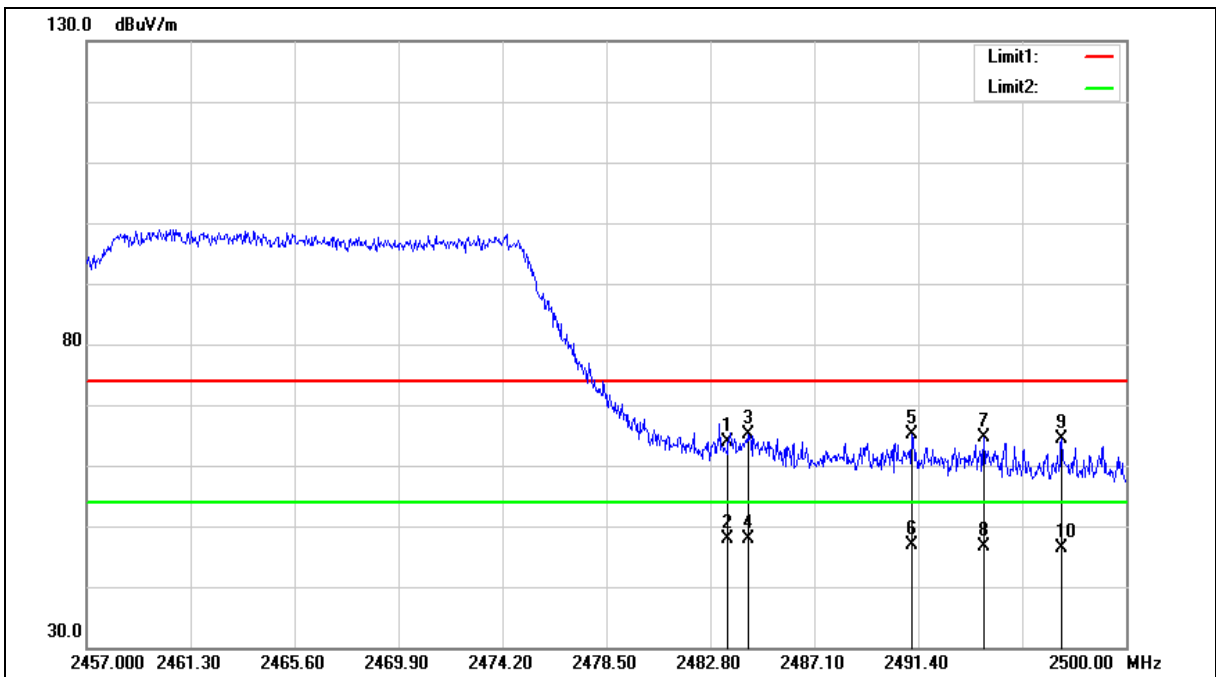



Standard:	FCC Part 15.247	Test Distance:	3 m
Test item:	Band edge	Power:	DC 3.3 V
Frequency:	2457 MHz	Temp.(°C)/Hum.(%RH):	26(°C)/60 %RH
Mode:	Mode 5		
Ant.Polar.:	Vertical		

No.	Frequency (MHz)	Reading (dBUV)	Correct Factor (dB/m)	Result (dBUV/m)	Limit (dBUV/m)	Margin (dB)	Remark
1	2483.500	64.78	-0.82	63.96	74.00	-10.04	peak
2	2483.500	48.66	-0.82	47.84	54.00	-6.16	AVG
3	2484.348	65.85	-0.82	65.03	74.00	-8.97	peak
4	2484.348	48.75	-0.82	47.93	54.00	-6.07	AVG
5	2491.142	65.96	-0.79	65.17	74.00	-8.83	peak
6	2491.142	47.78	-0.79	46.99	54.00	-7.01	AVG
7	2494.109	65.47	-0.79	64.68	74.00	-9.32	peak
8	2494.109	47.40	-0.79	46.61	54.00	-7.39	AVG
9	2497.334	65.03	-0.77	64.26	74.00	-9.74	peak
10	2497.334	47.05	-0.77	46.28	54.00	-7.72	AVG

Note:1.Result (dBUV/m) = Correct Factor (dB/m) + Reading(dBUV).

2.Correction factor (dB/m) = Antenna Factor (dB/m) + Cable loss (dB) – Pre-Amplifier gain (dB).

3. When the peak results are less than average limit, so not need to evaluate the average.



Standard:	FCC Part 15.247	Test Distance:	3 m
Test item:	Band edge	Power:	DC 3.3 V
Frequency:	2462 MHz	Temp.(°C)/Hum.(%RH):	26(°C)/60 %RH
Mode:	Mode 5		
Ant.Polar.:	Horizontal		

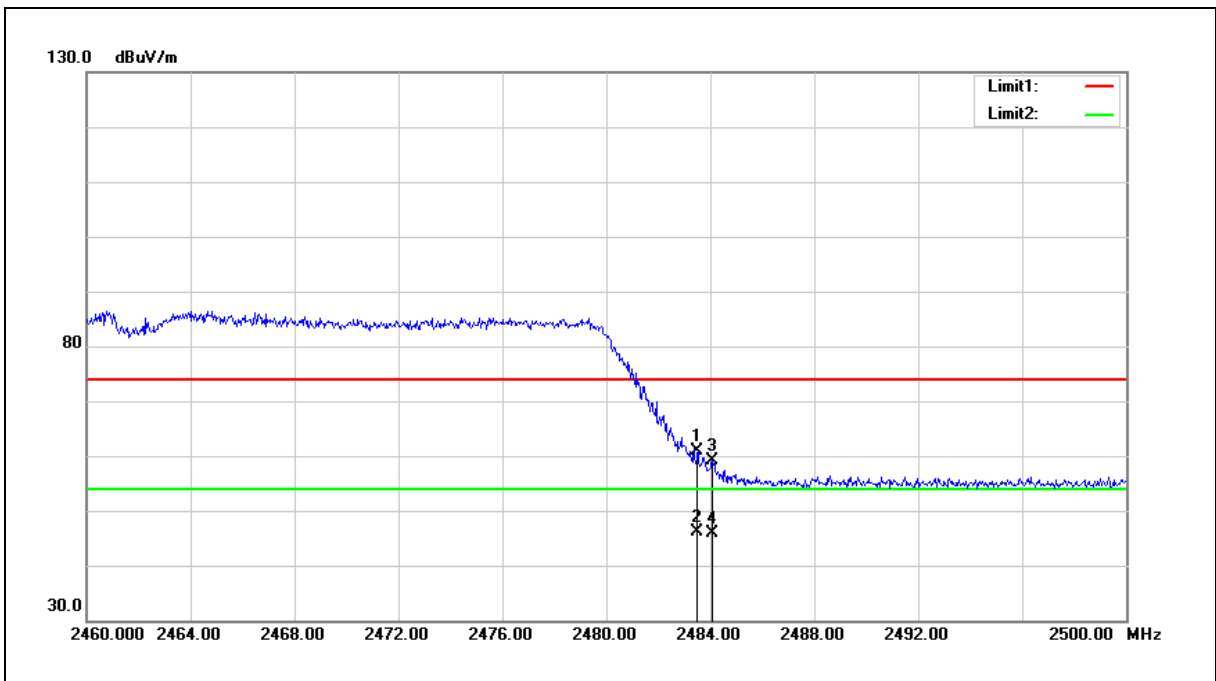

No.	Frequency (MHz)	Reading (dBuV)	Correct Factor (dB/m)	Result (dBuV/m)	Limit (dBuV/m)	Margin (dB)	Remark
1	2483.500	61.64	-0.82	60.82	74.00	-13.18	peak
2	2483.500	47.00	-0.82	46.18	54.00	-7.82	AVG
3	2484.080	59.87	-0.82	59.05	74.00	-14.95	peak
4	2484.080	46.70	-0.82	45.88	54.00	-8.12	AVG

- Note:1.Result (dBuV/m) = Correct Factor (dB/m) + Reading(dBuV).
- 2.Correction factor (dB/m) = Antenna Factor (dB/m) + Cable loss (dB) – Pre-Amplifier gain (dB).
3. When the peak results are less than average limit, so not need to evaluate the average.



Standard:	FCC Part 15.247	Test Distance:	3 m
Test item:	Band edge	Power:	DC 3.3 V
Frequency:	2462 MHz	Temp.(°C)/Hum.(%RH):	26(°C)/60 %RH
Mode:	Mode 5		
Ant.Polar.:	Vertical		

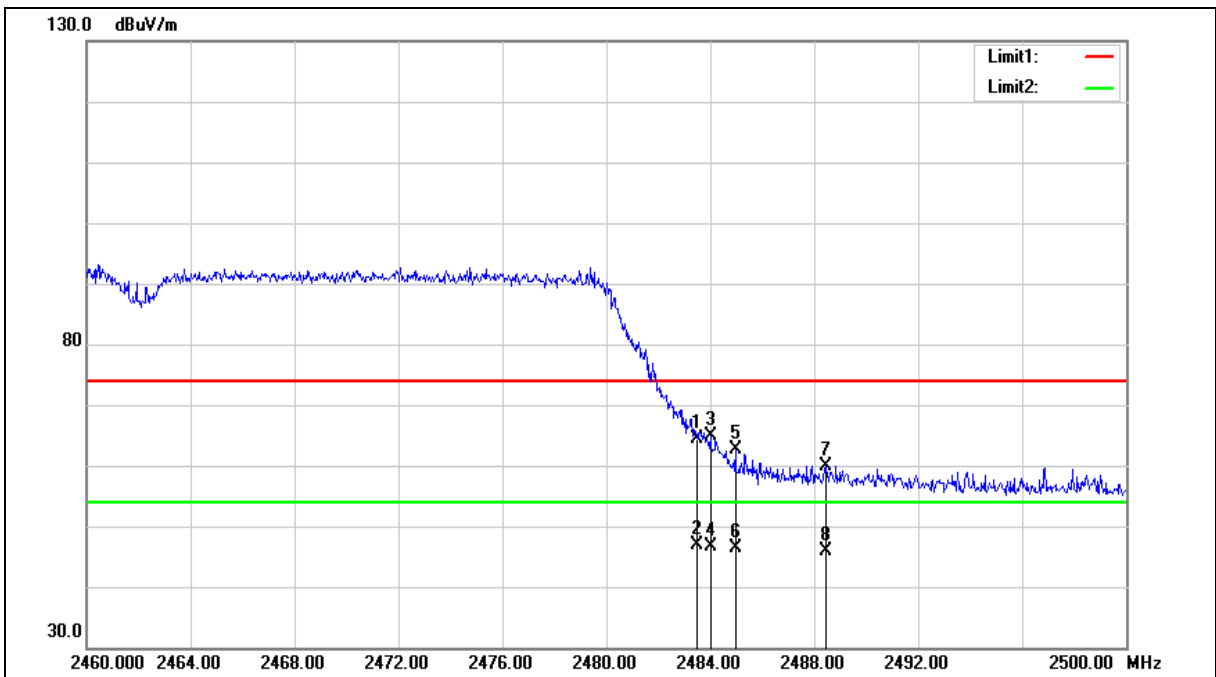



Standard:	FCC Part 15.247	Test Distance:	3 m
Test item:	Band edge	Power:	DC 3.3 V
Frequency:	2462 MHz	Temp.(°C)/Hum.(%RH):	26(°C)/60 %RH
Mode:	Mode 5		
Ant.Polar.:	Vertical		

No.	Frequency (MHz)	Reading (dBuV)	Correct Factor (dB/m)	Result (dBuV/m)	Limit (dBuV/m)	Margin (dB)	Remark
1	2483.500	65.24	-0.82	64.42	74.00	-9.58	peak
2	2483.500	47.74	-0.82	46.92	54.00	-7.08	AVG
3	2484.000	65.80	-0.82	64.98	74.00	-9.02	peak
4	2484.000	47.37	-0.82	46.55	54.00	-7.45	AVG
5	2484.960	63.41	-0.82	62.59	74.00	-11.41	peak
6	2484.960	47.20	-0.82	46.38	54.00	-7.62	AVG
7	2488.440	60.76	-0.80	59.96	74.00	-14.04	peak
8	2488.440	46.78	-0.80	45.98	54.00	-8.02	AVG

Note:1.Result (dBuV/m) = Correct Factor (dB/m) + Reading(dBuV).

2.Correction factor (dB/m) = Antenna Factor (dB/m) + Cable loss (dB) – Pre-Amplifier gain (dB).

3. When the peak results are less than average limit, so not need to evaluate the average.

----END----