

Ke Mei Ou Laboratory Co., Ltd.

7A, Jiexiangge, JiahuiXincheng, No.3027, Shennan Rd., Futian,
Shenzhen, Guangdong, P.R.China. Zip Code: 518033
Tel: + 86 755 83642690 Fax: + 86 755 83297077
www.kmolab.com

FCC TEST REPORT

Under
FCC 15 Subpart C, Paragraph 15.247: 2007

Operating in 2400 ~ 2483.5 MHz Band

Prepared For :

ASUSTek Computer Inc.

No.150, Li-Te Rd., Peitou, Taipei 112, Taiwan R.O.C

FCC ID: MSQ-USBBT211
EUT: Tiny Bluetooth dongle
Model: USB-BT211

August 21, 2009

Report Type: Original Report
Test Engineer: Jacky Huang _____
Test Date: June 17, 2009 _____

Review By: _____ Apollo Liu / Manager

The test report consists 36pages in total. It may be duplicated completely for legal use with the allowance of the applicant. It shall not be reproduced except in full, without the written approval of Ke Mei Ou Laboratory Corporation. The test result in the report only applied to the tested sample.

TABLE OF CONTENTS

1. General Information..... 3

 1. 1 Notes 3

 1. 2 Testing Laboratory 3

 1. 3 Details of Applicant 3

 1. 4 Application Details 3

 1. 5 Test Item 3

 1. 6 Test Standards 3

2. Technical Test..... 4

 2. 1 Summary of Test Results 4

 2. 2 Antenna Requirement 4

3. EUT Modifications..... 4

4. Conducted Power Line Test 5

 4. 1 Test Equipment 5

 4. 2 Test Procedure 5

 4. 3 Test Setup 5

 4. 4 Configuration of the EUT 6

 4. 5 EUT Operating Condition 7

 4. 6 Conducted Power Line Emission Limits 7

 4. 7 Conducted Power Line Test Result 8

5. FCC Part 15.247 Requirements for FHSS Systems 10

 5. 1 Test Equipment 10

 5. 2 Test Procedure 10

 5. 3 Test Setup 10

 5. 4 Configuration of the EUT 10

 5. 5 EUT Operating Condition 10

 5. 6 Limit 11

 5. 7 Test Result 11

6. Transmitter Spurious Radiated Emission at 3 Meters..... 21

 6. 1 Test Equipment 21

 6. 2 Test Procedure 21

 6. 3 Test Setup 21

 6. 4 Configuration of the EUT 21

 6. 5 EUT Operating Condition 21

 6. 6 Limit 22

 6. 7 Test Result 23

7. RF Exposure Requirements 24

 7. 1 Test Equipment 24

 7. 2 Limit 24

 7. 3 Test Result 24

8. Photos of Testing 25

 8. 1 EUT Test Photographs 25

 8. 2 EUT Detailed Photographs 26

9. FCC ID Label 35

10. Test Equipment 36

1. General Information

1.1 Notes

The test results of this report relate exclusively to the test item specified in 1.5. The KMO Lab does not assume responsibility for any conclusions and generalizations drawn from the test results with regard to other specimens or samples of the type of the equipment represented by the test item. The test report may only be reproduced or published in full. Reproduction or publication of extracts from the report requires the prior written approval of the KMO Lab.

1.2 Testing Laboratory

Site on File with the Federal Communications Commission – United States
Registration Number: 963441

Site Listed with Industry Canada of Ottawa, Canada
Registration Number: 7353A

1.3 Details of Applicant

Name : ASUSTek Computer Inc.
Address : No.150, Li-Te Rd., Peitou, Taipei 112, Taiwan R.O.C.
Contact : N/A
Tel : N/A
Fax : N/A

1.4 Application Details

Date of Receipt of Application : June 4, 2009
Date of Receipt of Test Item : June 17, 2009
Date of Test : June 17~August 21, 2009

1.5 Test Item

Manufacturer : Same Applicant
Address : Same Applicant
Trade Name : ASUS
Model No. : USB-BT211
Description : Tiny Bluetooth dongle

Additional Information

Frequency : 2402~2480MHz
Maximum Range : N/A
Number of Channels : 79
Transmitter Antenna : The transmitter's antenna is on PCB layout
Modulation : GFSK for 1Mbps, pi/4-DQPSK for 2 Mbps, 8DPSK for 3Mbps.
Power Supply : DC 5V(From Host)
Current Consumption : N/A

1.6 Test Standards

FCC 15 Subpart C, Paragraph 15.247: 2007
--

Note: All radiated measurements were made in all three orthogonal planes. The values reported are the maximum values.

2. Technical Test

2.1 Summary of Test Results

The EUT has been tested according to the following specifications:

Standard	Test Type	Result	Notes
FCC Part 15, Paragraph 15.203, 15.247(b)(4)(i)	Antenna Requirement	PASS	Complies
FCC Part 15, Paragraph 15.107, 15.207	Conducted Test	PASS	Complies
FCC Part 15, Paragraph 15.247(b)(1)	Peak Output Power	PASS	Complies
FCC Part 15, Paragraph 15.247(a)	20dB Bandwidth	PASS	Complies.
FCC Part 15, Paragraph 15.247(c)	100kHz Bandwidth of Frequency Band Edges	PASS	Complies.
FCC Part 15, Paragraph 15.209(a)(f)	Spurious Emission	PASS	Complies
FCC Part 15, Paragraph 15.247(a)(1)	Frequency Separation	PASS	Complies
FCC Part 15, Paragraph 15.247(a)(1)(iii)	Number of Hopping Frequency	PASS	Complies
FCC Part 15, Paragraph 15.247(a)(1)(iii)	Time of Occupancy	PASS	Complies
FCC Part 15, Paragraph 15.247(c)	Peak Power Density	PASS	Complies

* The digital circuit porting of the EUT has been tested and verified to comply with FCC Part 15, Subpart B., Class B Digital Devices and the associated Radio Receiver has also been tested and found to comply with FCC Part 15, Subpart B – Radio Receivers.

2.2 Antenna Requirement

A. Regulation

FCC section 15.203, An intentional radiator shall be designed to ensure that no antenna other than that furnished by the responsible party shall be used with the device. The use of a permanently attached antenna or of an antenna that uses a unique coupling to the intentional radiator shall be considered sufficient to comply with the provisions of Part 15C. The manufacturer may design the unit so that the user can replace a broken antenna, but the use of a standard antenna jack or electrical connector is prohibited. This requirement does not apply to carrier current devices or to devices operated under the provisions of Sections 15.211, 15.213, 15.217, 15.219, or 15.221. Further, this requirement does not apply to intentional radiators that must be professionally installed, such as perimeter protection systems and some field disturbance sensors, or to other intentional radiators which, in accordance with Section 15.31(d), must be measured at the installation site. However, the installer shall be responsible for ensuring that the proper antenna is employed so that the limits in this Part are not exceeded.

B. Result

The EUT no antenna connector for printed antenna. Therefore the EUT complies with Section 15.203 of the FCC rules.

3. EUT Modifications

No modification by test lab.

4. Conducted Power Line Test

4.1 Test Equipment

Please refer to Section 10 this report.

4.2 Test Procedure

The EUT and simulators are connected to the main power through a line impedance stabilization network (L.I.S.N.). This provides a 50 ohm/50uH coupling impedance for the measuring equipment. The peripheral devices are also connected to the main power through a LISN that provides a 50ohm/50uH coupling impedance with 50ohm termination.

Both sides of A.C. line are checked for maximum conducted interference. In order to find the maximum emission., the relative positions of equipment and all of the interface cables must be changed according to ANSI C63.4:2003 on conducted measurement. Conducted emissions were invested over the frequency range from 0.15MHz to 30MHz using a receiver bandwidth of 9kHz.

4.3 Test Setup

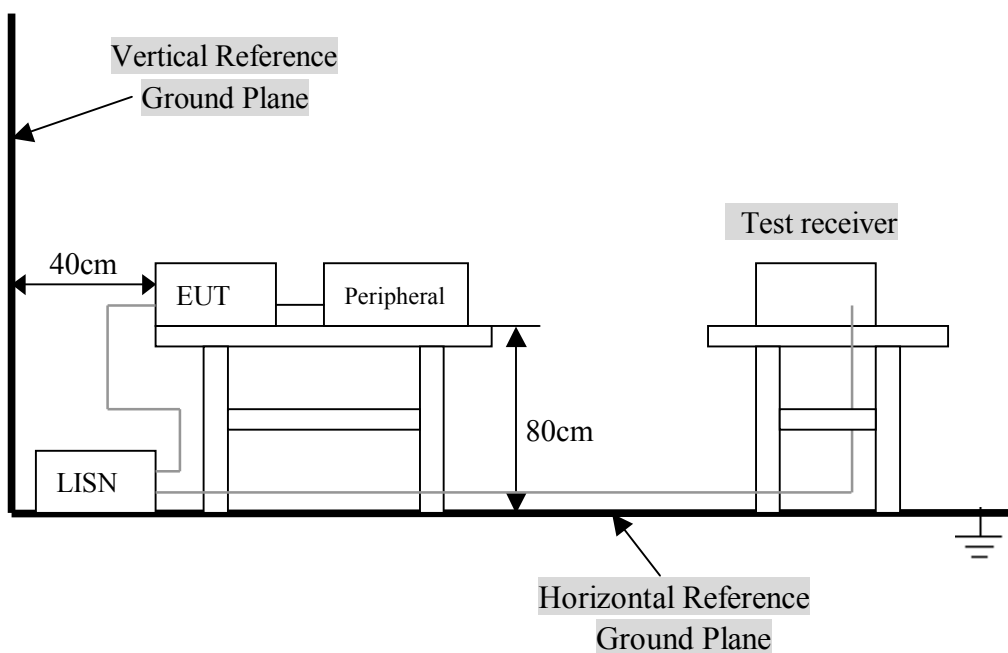

For the actual test configuration, Please refer to the related items – Photos of Testing.

4. 4 Configuration of the EUT

The EUT was configured according to ANSI C63.4-2003. EUT was used DC5V. The operation frequency is from 2400MHz~2483.5MHz. Enable the signal transmitted from the EUT to Notebook PC. All interface ports were connected to the appropriate peripherals. All peripherals and cables are listed below.

Note:

- 1) Operating Modes: Each of lowest, middle and highest channel frequencies transmits continuously for emissions measurements. The EUT operates in normal FHSS.
- 2) Special Test Software & Hardware: Special firmware and hardware provided by the Applicant are installed to allow the EUT to operate in FHSS at each channel frequency continuously. For example, the transmitter will be operated at each of lowest, middle and highest frequencies individually continuously during testing.
- 3) Transmitter Test Antenna: The EUT is tested with the antenna fitted in a manner typical of normal intended use as an integral / non-integral antenna equipment as describe with the test results.
- 4) Frequency(ies) Tested: 2402MHz, 2441MHz and 2480MHz were pre-tested, The worst case one, was chosen for conducted emission test.
- 5) Above 1GHz, the 2402MHz, 2441MHz and 2480MHz were tested individually.
- 6) Normal Test Modulation: FHSS
- 7) Modulating Signal Source: Internal

* Associated Antenna Descriptions: The antenna used in this product is embedded antenna.

A. EUT

Device	Manufacturer	Model #	FCC ID
Tiny Bluetooth dongle	ASUSTeK Computer Inc.	USB-BT211	MSQ-USBBT211

B. Internal Devices

Device	Manufacturer	Model #	FCC ID
N/A			

C. Peripherals

Device	Manufacturer	Model # Serial #	FCC ID/ DoC	Cable
Printer	HP	HP930C	DoC	1.5m unshielded power cord 1.2m unshielded data cable.
Modem	GVC	N/A	DoC	1.5m unshielded power cord 1.2m unshielded data cable.
Notebook	DELL	PP10L	DoC	1.5m unshielded power cord
PC	Dell	2400n	DoC	1.5m unshielded power cord

4.5 EUT Operating Condition

Operating condition is according to ANSI C63.4 - 2003.

- A. Setup the EUT and simulators as shown on follow.
- B. Enable RF signal and confirm EUT active.
- C. Modulate output capacity of EUT up to specification.

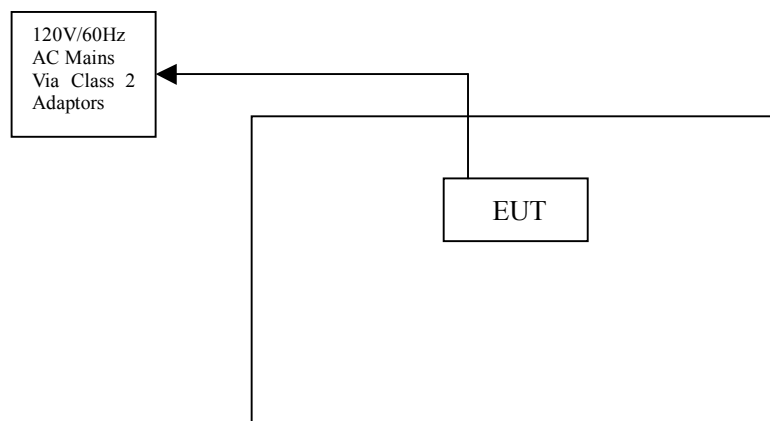

4.6 Conducted Power Line Emission Limits

FCC Part 15 Paragraph 15.207 (dBuV)		
Frequency Range (MHz)	Class A QP/AV	Class B QP/AV
0.15 – 0.5	79/66	66-56/56-46
0.5 – 5.0	73/60	56/46
5.0 - 30	73/60	60/50

NOTE : In the above table, the tighter limit applies at the band edges.

4. 7 Conducted Power Line Test Result

Product	: Tiny Bluetooth dongle	Test Mode	: CH Low – CH High, GFSK
Test Item	: Conducted Emission Data	Temperature	: 25 °C
Test Voltage	: DC 5V(DC From Host)	Humidity	: 56%RH
Test Result	: PASS		

The frequency spectrum from 0.15 MHz to 30 MHz was investigated. All readings are quasi -peak values with a resolution bandwidth of 9 KHz.

- Temperature : 26 °C
- Humidity : 53 % RH

FCC Part 15 Paragraph 15.207							
Frequency (MHz)	Emission (dBuV)		LINE/NEUTRAL	Limit (dBuV)		Margin (dB)	
	QP	AV		QP	AV	QP	AV
0.162	45.57	32.83	Line	65.36	55.36	-19.79	-22.53
0.166	48.09	37.44	Neutral	65.16	55.16	-17.07	-17.72
0.178	42.87	30.07	Line	64.58	54.58	-21.71	-24.51
0.194	42.03	27.58	Neutral	63.86	53.86	-21.83	-26.28
0.226	36.85	28.94	Line	62.60	52.60	-25.75	-23.66
0.210	44.42	36.53	Neutral	63.21	53.21	-18.79	-16.68

Note: NF = No Significant Peak was Found.

Note:

- 1.Uncertainty in conducted emission measured is <+/- -2dB.
- 2.The emission levels of other frequencies were very low against the limit.
- 3.All Reading Levels are Quasi-Peak and Average value.
- 4.Emission = Meter Reading + Factor; Factor = Insertion Loss + Cable Loss.
- 5.Margin Value = Emission Level - Limit Value.

Conducted Emission

EN55022

EUT: *Tiny Bluetooth dongle, M/N: USB-BT211*

Manufacturer:

Operating Condition: *Transmitting*

Test Site:

Operator: *Jacky Huang*

Test Specification: *LINE&NEUTRAL*

Comment:



RBW 9 kHz Marker 1 [T2]
MT 100 ms 42.25 dBµV
PREAMP OFF 226.00000000 kHz

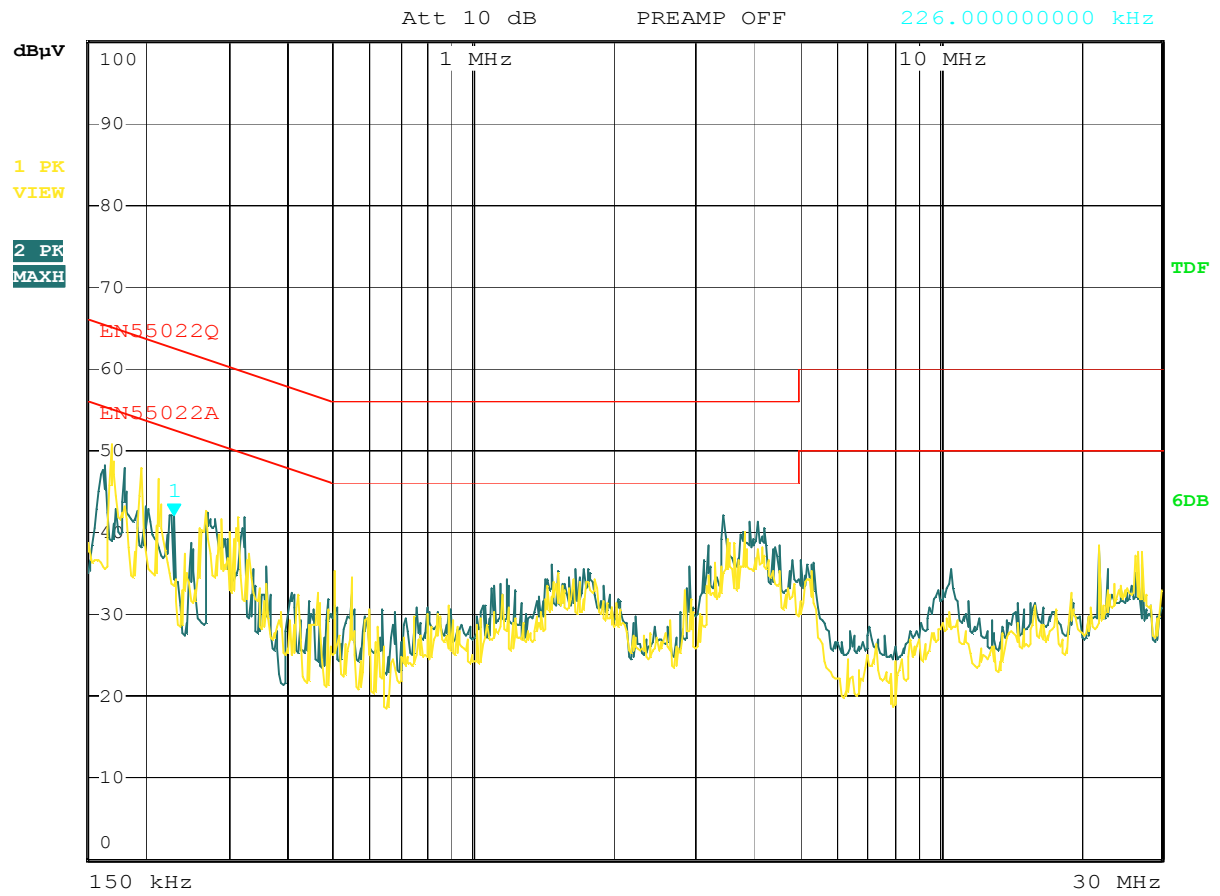

Date: 17.JUN.2009 13:42:05

5. FCC Part 15.247 Requirements for FHSS Systems

5.1 Test Equipment

Please refer to Section 10 this report.

5.2 Test Procedure

Refer to FCC 15.247(a)(2), ANSI C63.4: 2003

20 dB Bandwidth:

- Place the EUT on the table and set it in the transmitting mode.
- Remove the antenna from the EUT and then connect a low loss RF cable from the antenna port to the spectrum analyzer.
- Set the spectrum analyzer as RBW = 30 kHz, VBW = 100 kHz, Span = 2 MHz, Sweep = 100ms.
- Mark the peak frequency and -20dB (upper and lower) frequency.
- Repeat until all the rest channels are investigated.

Peak Power:

The transmitter output is connected to the test receiver. The test receiver is set to the peak power detection. The power is equal to the reading level on test receiver plus cable loss at the EUT RF output terminal.

100kHz Bandwidth of Band Edges Measurement:

- The transmitter output was connected to the spectrum analyzer via a low lose cable.
- Set both RBW and VBW of spectrum analyzer to 100kHz with suitable frequency span including 100kHz bandwidth from band edge.
- The band edges was measured and recorded.

Peak Power Spectral Density:

- The transmitter output is connected to a test receiver, The spectrum analyzer's resolution bandwidth was set at 3kHz RBW and 30kHz VBW as that of the fundamental frequency. Set the sweep time=100s.
- The power spectral density was measured and recorded.
- The sweep time is allowed to be longer than span/3kHz for a full response of the mixer in the spectrum analyzer.

Frequency Separation:

- Place the EUT on the table and set it in the transmitting mode.
- Remove the antenna from the EUT and then connect a low loss RF cable from the antenna port to the spectrum analyzer.
- Set the spectrum analyzer as RBW = 100 kHz, VBW = 100 kHz, Span = 2 MHz, Sweep = 100ms.
- Set center frequency spectrum analyzer = middle of hopping channel.

Number of Hopping Frequency:

- Place the EUT on the table and set it in the transmitting mode.
- Remove the antenna from the EUT and then connect a low loss RF cable from the antenna port to the spectrum analyzer.
- Set spectrum analyzer Start=2400MHz, Stop=2483.5MHz, RBW = 100 kHz, VBW = 300 kHz, Sweep=100ms
- Max hold, view and count how many channel in the band.

Time of Occupancy (Dwell Time):

- Place the EUT on the table and set it in the transmitting mode.
- Remove the antenna from the EUT and then connect a low loss RF cable from the antenna port to the spectrum analyzer.
- Set center frequency of spectrum analyzer = operating frequency, RBW = 100 kHz, VBW = 300 kHz, Sweep=2ms
- Repeat above procedures until all frequency measured were complete.

5.3 Test Setup

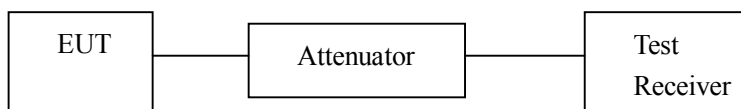

5.4 Configuration of the EUT

Same as section 4.4 of this report

5.5 EUT Operating Condition

Same as section 4.5 of this report.

5. 6 Limit

20 dB Bandwidth: For frequency hopping systems operating in the 2400MHz~2483.5MHz no limit for 20dB bandwidth
Peak Power: For frequency hopping systems operating in the 2400~2483.5MHz band employing at least 75 hopping channels, and all frequency hopping systems in the 5725~5850MHz band: 1 Watt. For all other frequency hopping systems in the 2400~2483.5MHz band: 0.125Watts.

100kHz Bandwidth of Band Edges Measurement: According to §15.247(c), in any 100kHz bandwidth outside the frequency bands in which the spread spectrum intentional radiator is operating, the radio frequency power that is produced by the intentional radiator shall be at least 20dB below that in the 100kHz bandwidth within the band that contains the highest level of the desired power. In addition, radiated emissions which fall in the restricted bands, as defined in §15.205(a), must also comply with the radiated emission limits specified in 15.3209(a).

Peak Power Spectral Density: According to §15.247(d), for direct sequence systems, the peak power spectral density conducted from the intentional radiator to the antenna shall not be greater than 8dBm in any 3kHz band during any time interval of continuous transmission

Frequency Separation: According to §15.247(a)(1), Frequency hopping systems shall have hopping channel carrier frequencies separated by minimum of 25kHz or the 20dB bandwidth of the hopping channel, whichever is greater.

Number of Hopping Frequency: According to §15.247(a)(1)(iii), Frequency hopping systems operating in the 2400~2483.5MHz bands shall use at least 15 hopping frequencies.

Time of Occupancy (Dwell Time): According to §15.247(a)(1)(iii), Frequency hopping systems operating in the 2400~2483.5MHz. The average time of occupancy on any frequency shall not greater than 0.4 s within period of 0.4 seconds multiplied by the number of hopping channel employed.

5. 7 Test Result

A. 20 dB Bandwidth

Product	: Tiny Bluetooth dongle	Test Mode	: CH Low ~ CH High, GFSK
Test Item	: 20 dB BW	Temperature	: 25 °C
Test Voltage	: DC 5V (DC From Host)	Humidity	: 56%RH
Test Result	: PASS		

Channel	Channel Frequency	20 dB Down BW (kHz)
Low	2402	996
Mid	2441	980
High	2480	1008

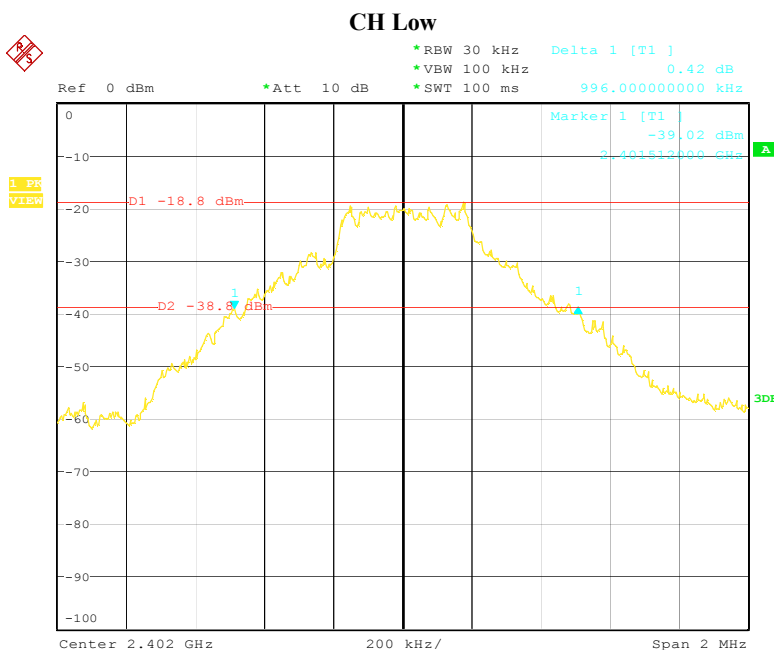

Date: 23.JUN.2009 13:58:43

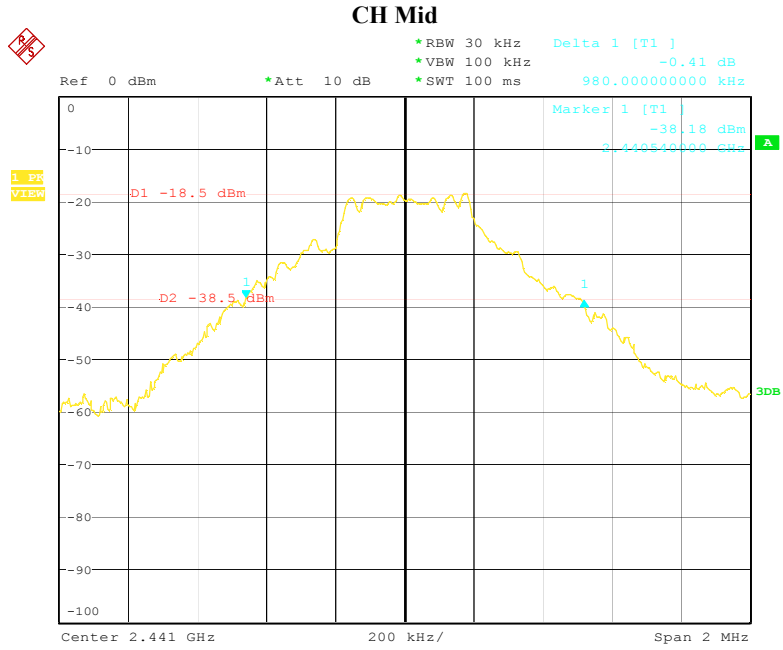

Date: 23.JUN.2009 14:01:23

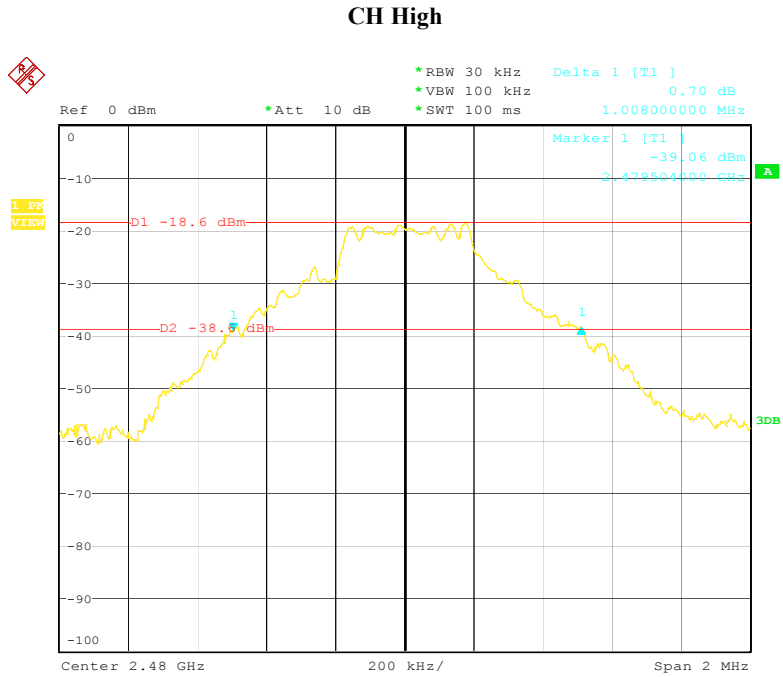

Date: 23.JUN.2009 14:03:31

B. Peak Power

Product : Tiny Bluetooth dongle Test Mode : CH Low ~ CH High, GFSK
 Test Item : Peak Power Temperature : 25 °C
 Test Voltage : DC 5V(DC From Host) Humidity : 56%RH
 Test Result : **PASS**

Channel	Frequency (MHz)	Output Power (dBm)	FCC Limit (W/dBm)	Result
Low	2402	-1.07	1.00/30.00	PASS
Mid	2441	-0.38		PASS
High	2480	0.29		PASS

C. 100kHz Band Edges Measurement

Product : Tiny Bluetooth dongle Test Mode : CH Low ~ CH High, GFSK
 Test Item : Band Edges Measurement Temperature : 25 °C
 Test Voltage : DC 5V (DC From Host) Humidity : 56%RH
 Test Result : **PASS**

Channel	Detector	Radiated Method Max. Field Strength of Fundamental (dBuV/m)	Conducted Method Between Carrier Max. Power and Local Max. Emission in Restrict Band(dBc)	The Max. Field Strength in Restrict Band (dBuV/m)	Limt @3m (dBuVm) Peak / Average	Margin (dB)
Low	Peak	83.96	45.63	38.33	74.0 / 54.0	-35.67
High	Peak	81.15	48.74	32.41	74.0 / 54.0	-41.59

- Note:**
- (1) According to step 2 of Marker-Delta Method DA 00-705 (following plots included).
 - (2) According to step 3 of Marker-Delta Method:
The Max. Field Strength in Restrict Band = Filed Strength of Fundamental – Between Carrier Max Power and Local Max. Emission in Restrict Band
 - (3) The average measurement was not performed when the peak measured data under the limit of average detection. If the readings given are average, peak measurement should also be supplied.

Channel: Low

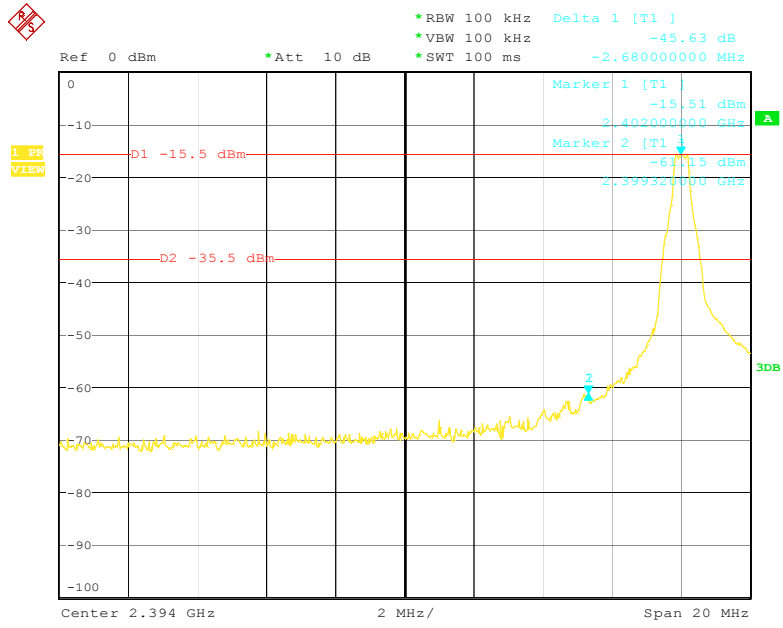

Date: 23.JUN.2009 14:13:02

Channel: High

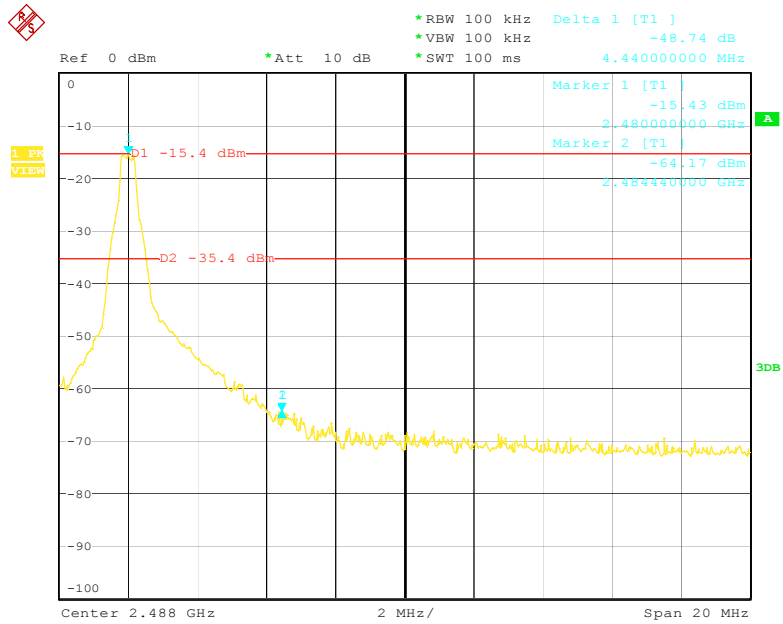

Date: 23.JUN.2009 14:15:24

D. Peak Power Spectral Density

Product	: Tiny Bluetooth dongle	Test Mode	: CH Low ~ CH High, GFSK
Test Item	: Peak Power Spectral Density	Temperature	: 25 °C
Test Voltage	: DC 5V (DC From Host)	Humidity	: 56%RH
Test Result	: PASS		

Channel	Frequency (MHz)	PPSD (dBm)	FCC Limit (dBm)	Result
Low	2402	-23.58	8.00	PASS
Mid	2441	-23.31		PASS
High	2480	-23.31		PASS

Channel: Low

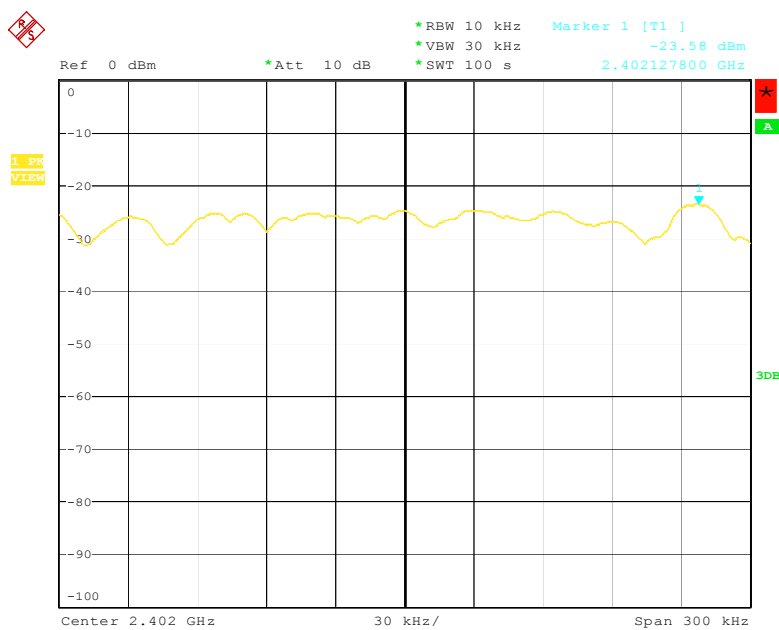

Date: 23.JUN.2009 14:26:34

Channel: Mid

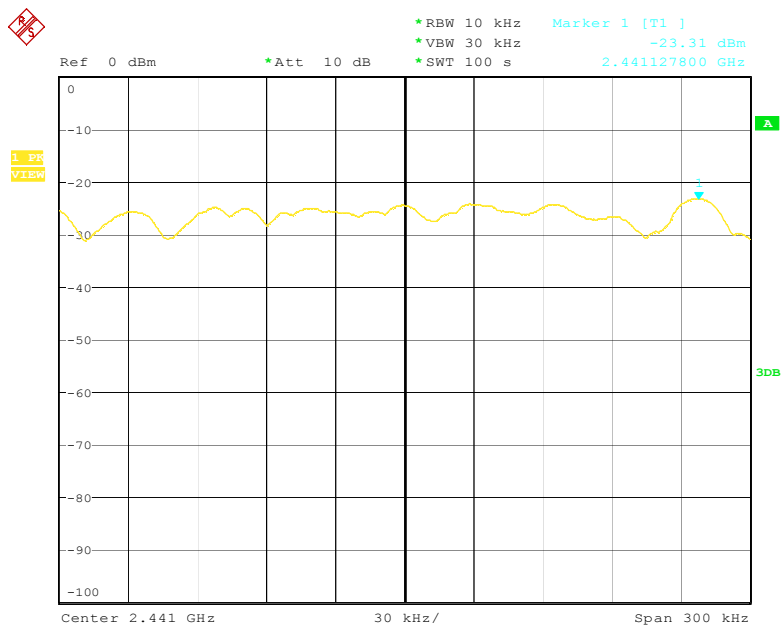

Date: 23.JUN.2009 14:24:01

Channel: High

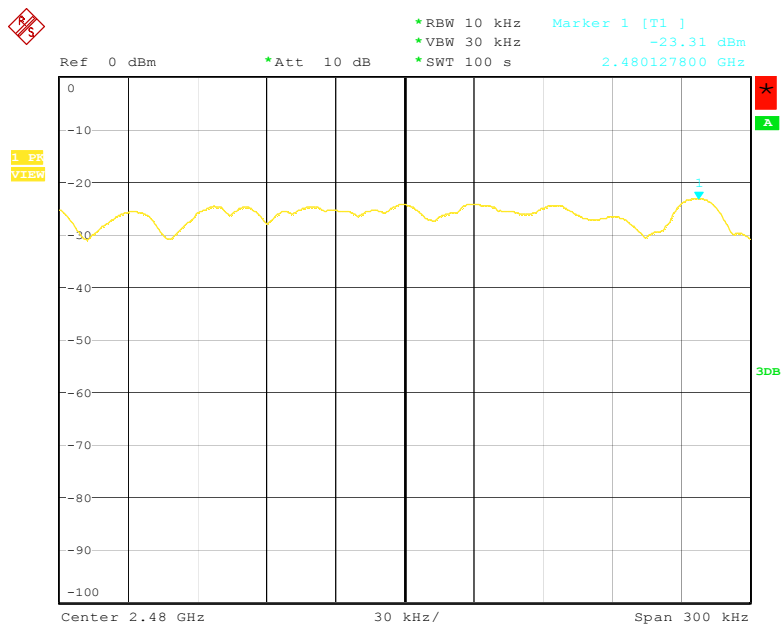

Date: 23.JUN.2009 14:21:38

E. Frequency Separation

Product	: Tiny Bluetooth dongle	Test Mode	: CH Low ~ CH High, GFSK
Test Item	: Frequency Separation	Temperature	: 25 °C
Test Voltage	: DC 5V	Humidity	: 56%RH
Test Result	: PASS		

Channel	Channel Frequency (MHz)	Separation Read Value (kHz)	Separation Limit (kHz)
Low	2402	1000	>25kHz
Mid	2441	1000	>25kHz
High	2480	1000	>25kHz

Channel: Low

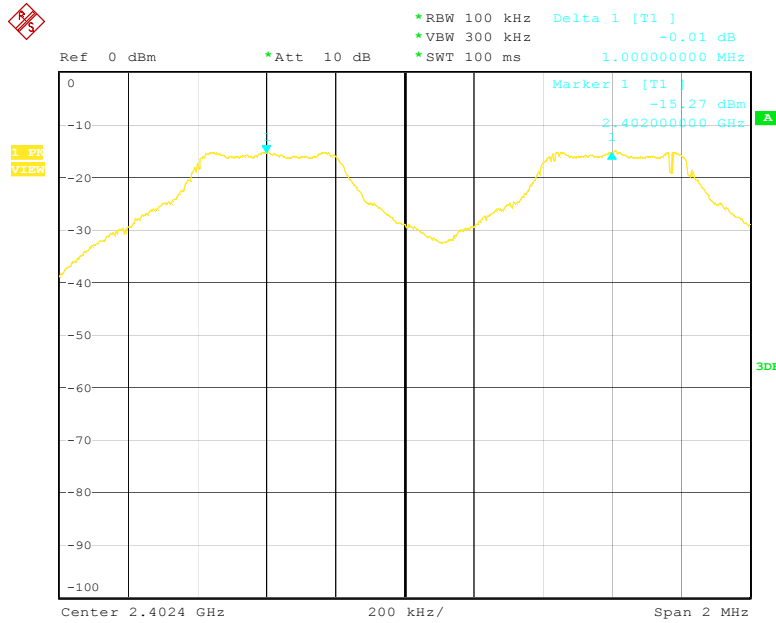

Date: 23.JUN.2009 14:34:01

Channel: Mid

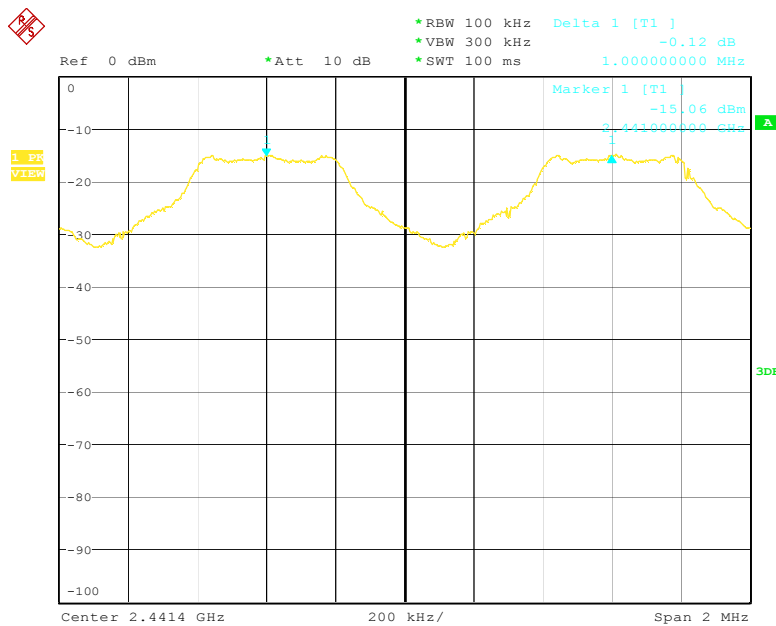

Date: 23.JUN.2009 14:40:17

Channel: High

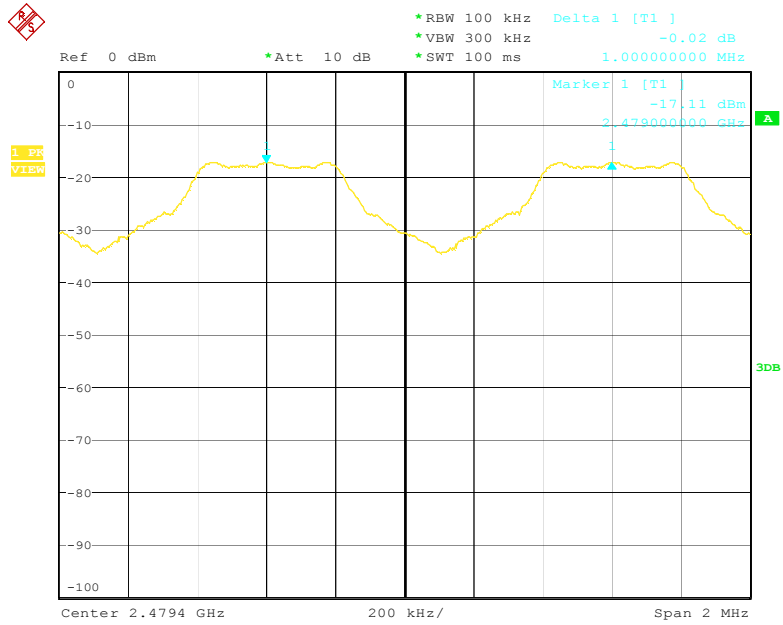

Date: 23.JUN.2009 15:00:15

F. Number of Hopping Frequency

Product	: Tiny Bluetooth dongle	Test Mode	: CH Low ~ CH High, GFSK
Test Item	: Number of Hopping Frequency	Temperature	: 25 °C
Test Voltage	: DC 5V	Humidity	: 56%RH
Test Result	: PASS		

Hopping Channel Frequency Ranger	Quantity Hopping Channel Read Value	Quantity of Hopping Channel Limit
2402~2480	79	75

Channel: Low

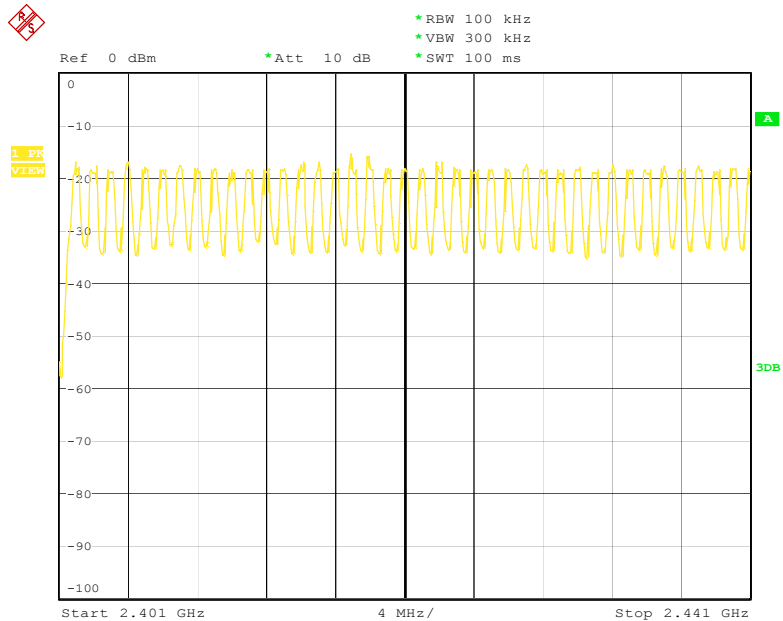

Date: 23.JUN.2009 15:18:24

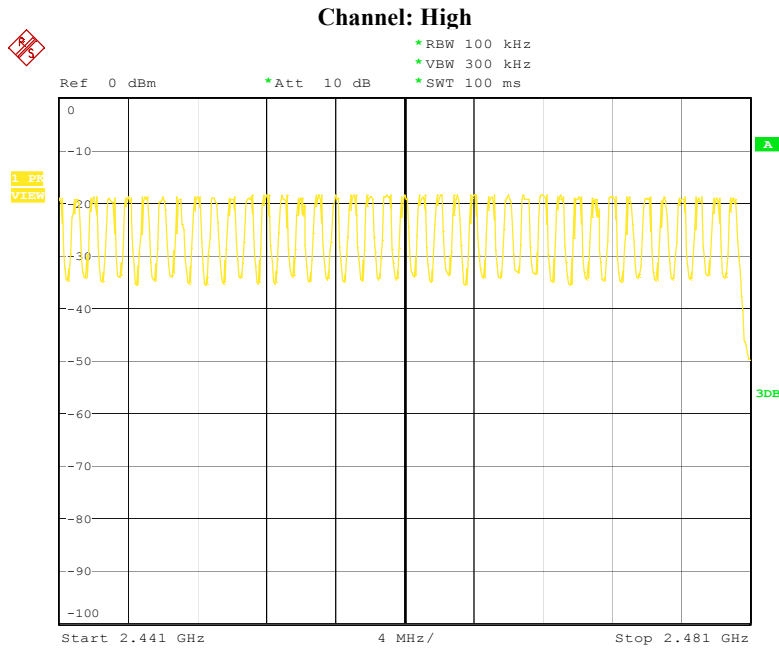

Date: 23.JUN.2009 15:21:38

G. Time of Occupancy (Dwell Time)

Product	: Tiny Bluetooth dongle	Test Mode	: CH Mid, GFSK
Test Item	: Time of Occupancy	Temperature	: 25 °C
Test Voltage	: DC 5V	Humidity	: 56%RH
Test Result	: PASS		

Channel	Channel Frequency(MHz)	Dwell Time (ms)	Time of occupancy on the Tx channel in 31.6sec	Average time of occupancy Limit(ms)
DH1	2441	0.552	176.64	400
DH3	2441	1.812	289.92	400
DH5	2441	3.100	330.67	400

DH1 Dwell time = 0.552 ms x (1600/2)/79 x 31.6 = 176.64(ms)

DH3 Dwell time = 1.812 ms x (1600/4)/79 x 31.6 = 289.92(ms)

DH5 Dwell time = 3.100 ms x (1600/6)/79 x 31.6 = 330.67(ms)

DH1

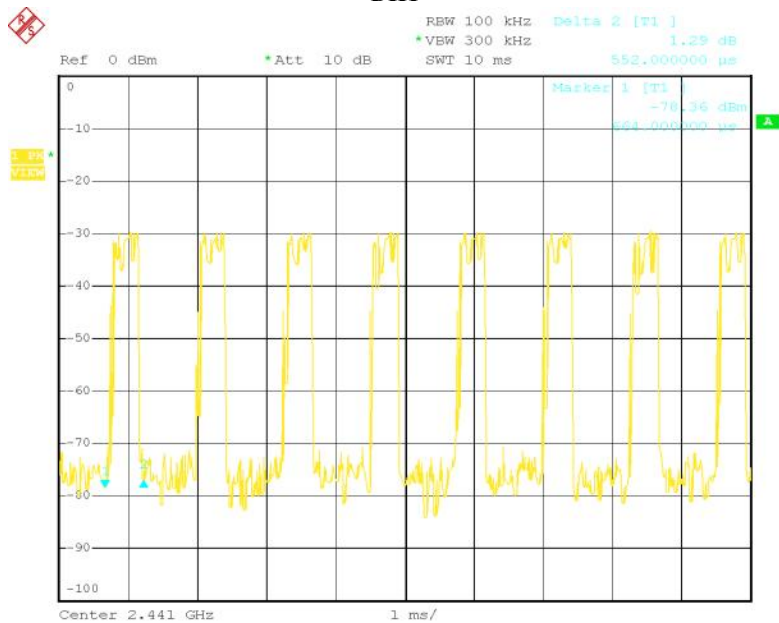

DH3

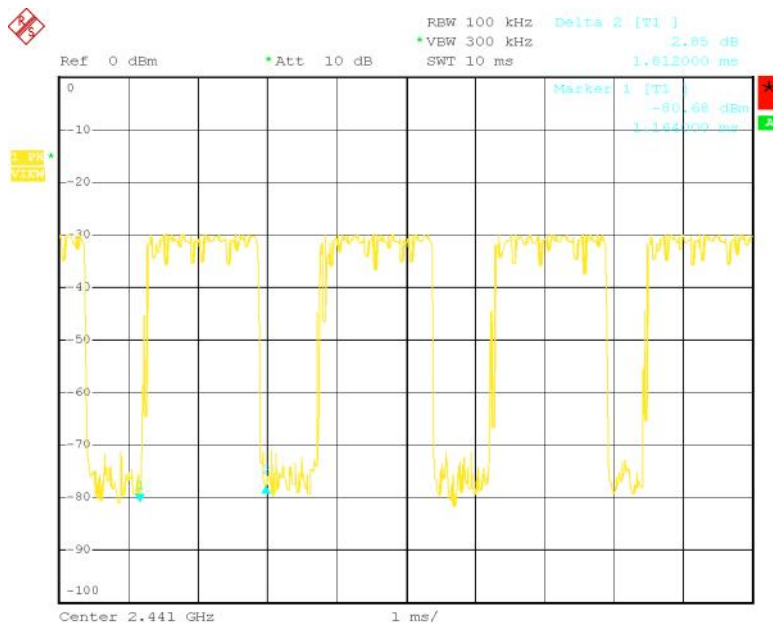

DH5

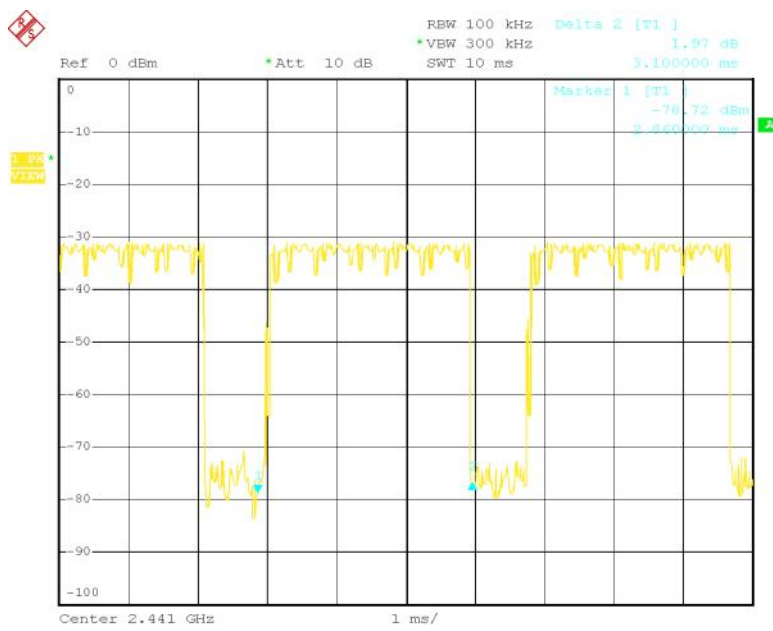

6. Transmitter Spurious Radiated Emission at 3 Meters

6.1 Test Equipment

Please refer to Section 10 this report.

6.2 Test Procedure

1. The EUT was tested according to ANSI C63.4 - 2003.
2. The EUT, peripherals were put on the turntable which table size is 1m x 1.5 m, table high 0.8 m. All set up is according to ANSI C63.4-2003.
3. The frequency spectrum from 30 MHz to 1 GHz was investigated. All readings from 30 MHz to 1 GHz are quasi-peak values with a resolution bandwidth of 120 KHz. All readings are above 1 GHz , peak values with a resolution bandwidth of 1 MHz . Measurements were made at 3 meters.
4. The antenna high is varied from 1 m to 4 m high to find the maximum emission for each frequency.
5. Maximizing procedure was performed on the six (6) highest emissions to ensure EUT compliance is with all installation combinations. All data was recorded in the peak detection mode. Quasi-peak readings was performed only when an emission was found to be marginal (within -4 dB of specification limit), and are distinguished with a "QP" in the data table.
6. The antenna polarization: Vertical polarization and Horizontal polarization.

6.3 Test Setup

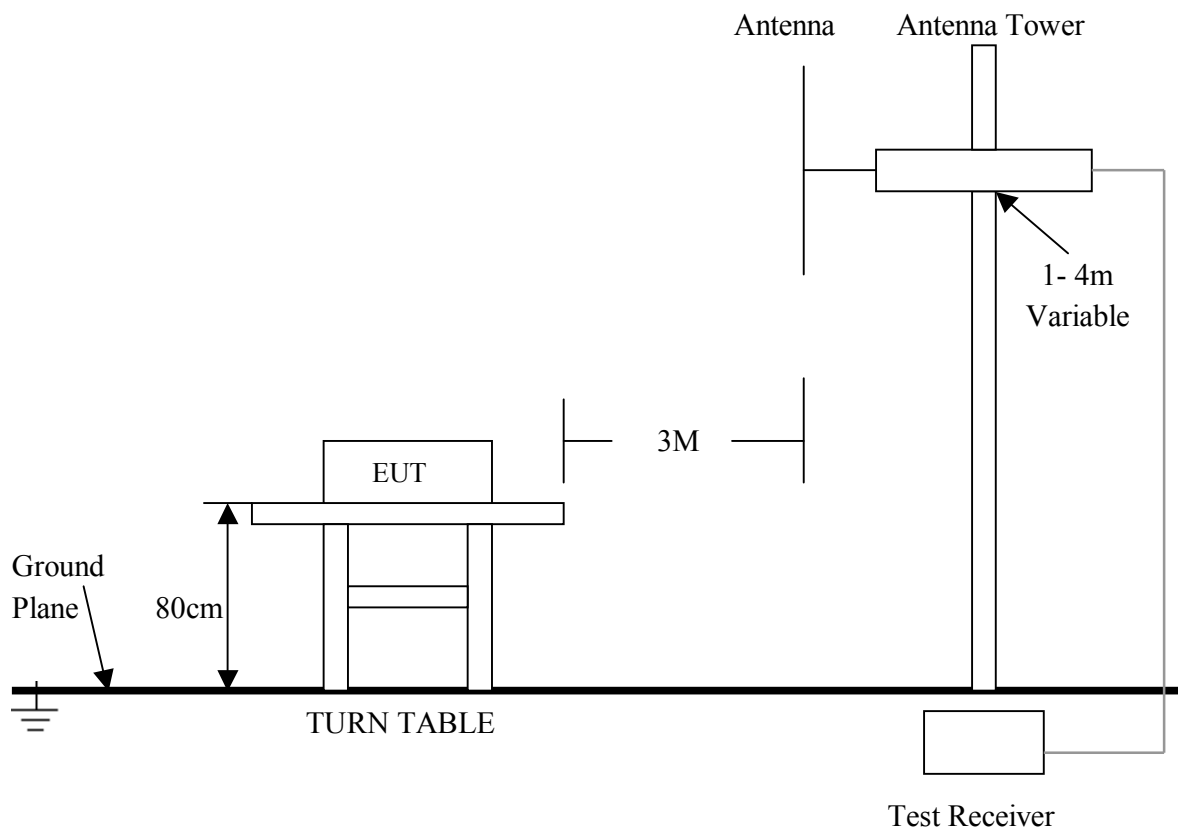

For the actual test configuration , please refer to the related items – Photos of Testing

6.4 Configuration of the EUT

Same as section 4.4 of this report

6.5 EUT Operating Condition

Same as section 4.5 of this report.

6.6 Limit

In any 100 KHz bandwidth outside the operating frequency band, the radio frequency power that is produced by modulation products of the spreading sequence, the information sequence and the carrier frequency shall be either at least 20 dB below that in any 100 KHz bandwidth within the band that contains the highest level of the desired power or shall not exceed the general levels specified in section 15.209(a), which lesser attenuation.

All other emissions inside restricted bands specified in section 15.205(a) shall not exceed the general radiated emission limits specified in section 15.209(a)

Note:

Applies to harmonics/spurious emissions that fall in the restricted bands listed in section 15.205. The maximum permitted average field strength is listed in section 15.209.

47 CFR § 15.237(c): The emission limits as specified above are based on measurement instrument employing an average detector. The provisions in section 15.35 for limiting peak emissions apply.

FCC CFR 47, Part 15, Subpart C, Para. 15.205(a) – Restricted Frequency Bands

MHz	MHz	MHz	GHz
0.090–0.110	16.42–16.423	399.9–410	4.5–5.15
1.495–0.505	16.69475–16.69525	608–614	5.35–5.46
2.1735–2.1905	16.80425–16.80475	960–1240	7.25–7.75
4.125–4.128	25.5–25.67	1300–1427	8.025–8.5
4.17725–4.17775	37.5–38.25	1435–1626.5	9.0–9.2
4.20725–4.20775	73–74.6	1645.5–1646.5	9.3–9.5
6.215–6.218	74.8–75.2	1660–1710	10.6–12.7
6.26775–6.26825	108–121.94	1718.8–1722.2	13.25–13.4
6.31175–6.31225	123–138	2200–2300	14.47–14.5
8.291–8.294	149.9–150.05	2310–2390	15.35–16.2
8.362–8.366	156.52475–156.52525	2483.5–2500	17.7–21.4
8.37625–8.38675	156.7–156.9	2655–2900	22.01–23.12
8.41425–8.41475	162.0125–167.17	3260–3267	23.6–24.0
12.29–12.293	167.72–173.2	3332–3339	31.2–31.8
12.51975–12.52025	240–285	3345.8–3358	36.43–36.5
12.57675–12.57725	322–335.4	3600–4400	(2)
13.36–13.41.			

¹ Until February 1, 1999, this restricted band shall be 0.490–0.510 MHz.

² Above 38.6

FCC 47 CFR, Part 15.209(a) – Field Strength Limits within Restricted Frequency Bands

Frequency (MHz)	Field strength (microvolts/meter)	Measurement distance (meters)
0.009–0.490	2400/F(kHz)	300
0.490–1.705	24000/F(kHz)	30
1.705–30.0	30	30
30–88	100**	3
88–216	150**	3
216–960	200**	3
Above 960	500	3

6.7 Test Result

Product	: Tiny Bluetooth dongle	Test Mode	: CH Low ~ CH High, GFSK
Test Item	: Spurious Radiated Emissions	Temperature	: 25 °C
Test Voltage	: DC 5V	Humidity	: 56%RH
Test Result	: PASS		

Harmonics Radiated Emission Data

CH Low

Freq. (MHz)	Emission (dBuV/m) Peak Detector	HORIZ / VERT	Limits (dBuV/m) Peak / Average	Margin (dB)
4804.00	48.23	HORZ	74.0 / 54.0	-25.77
4804.00	46.31	VERT	74.0 / 54.0	-27.69
7206.00	48.44	HORZ	74.0 / 54.0	-25.56
7206.00	46.15	VERT	74.0 / 54.0	-27.85
24020.00	-	HORZ	74.0 / 54.0	-
24020.00	-	VERT	74.0 / 54.0	-

CH Mid

Freq. (MHz)	Emission (dBuV/m) Peak Detector	HORIZ / VERT	Limits (dBuV/m) Peak / Average	Margin (dB)
4882.00	48.65	HORZ	74.0 / 54.0	-25.35
4882.00	46.57	VERT	74.0 / 54.0	-27.43
7323.00	48.22	HORZ	74.0 / 54.0	-25.78
7323.00	46.01	VERT	74.0 / 54.0	-27.99
24410.00	-	HORZ	74.0 / 54.0	-
24410.00	-	VERT	74.0 / 54.0	-

CH High

Freq. (MHz)	Emission (dBuV/m) Peak Detector	HORIZ / VERT	Limits (dBuV/m) Peak / Average	Margin (dB)
4960.00	48.78	HORZ	74.0 / 54.0	-25.22
4960.00	46.27	VERT	74.0 / 54.0	-27.73
7440.00	48.88	HORZ	74.0 / 54.0	-25.12
7440.00	46.53	VERT	74.0 / 54.0	-27.47
24800.00	-	HORZ	74.0 / 54.0	-
24800.00	-	VERT	74.0 / 54.0	-

- Note:**
- (1) All Reading Levels below 1GHz are Quasi-Peak, above are peak and average value.
 - (2) Emission Level = Reading Level + Probe Factor + Cable Loss.
 - (3) Receiver setting (Peak Detector) : RBW=1MHz; VBW=1MHz; Span=100MHz
 - (4) Receiver setting (AVG Detector): RBW=1MHz; VBW=30Hz; Span=20MHz
 - (5) The average measurement was not performed when the peak measured data under the limit of average detection. If the readings given are average, peak measurement should also be supplied.
 - (6) Where an emission level is indicated by a -, levels had a margin greater than 20 dB when compared to the limit.

Product	: Tiny Bluetooth dongle	Test Mode	: CH High, GFSK
Test Item	: Spurious Radiated Emissions	Temperature	: 25 °C
Test Voltage	: DC 5V	Humidity	: 56%RH
Test Result	: PASS		

General Radiated Emission Data

Freq. (MHz)	Emission (dBuV/m) QP Detector	HORIZ / VERT	Limits (dBuV/m)	Margin (dB)
41.16	22.69	HORZ	40.0	-17.31
86.04	22.48	VERT	40.0	-17.52
139.16	27.44	HORZ	43.5	-16.06
159.40	28.53	VERT	43.5	-14.97
437.16	31.59	HORZ	46.0	-14.41
350.52	28.73	VERT	46.0	-17.27

- Note:**
- (1) All Readings below 1GHz are Quasi-Peak, above are performed with peak and/or average measurements as necessary.
 - (2) Emission Level = Reading Level + Probe Factor + Cable Loss.

7. RF Exposure Requirements

7.1 Test Equipment

Please refer to Section 10 this report.

7.2 Limit

According to FCC 15.247(i), Systems operating under provisions of this section shall be operated in a manner that ensures that the public is not exposed to radio frequency energy levels in excess of the Commissions guidelines.

FCC 1.1310: The criteria listed in the following table shall be used to evaluate the environmental impact of human exposure to radio-frequency (RF) radiation as specified in 1.1307(b)(1) of this chapter.

TABLE 1—LIMITS FOR MAXIMUM PERMISSIBLE EXPOSURE (MPE)

Frequency range (MHz)	Electric field strength (V/m)	Magnetic field strength (A/m)	Power density (mW/cm ²)	Averaging time (minutes)
(A) Limits for Occupational/Controlled Exposures				
0.3–3.0	614	1.63	*(100)	6
3.0–30	1842/f	4.89/f	*(900/f ²)	6
30–300	61.4	0.163	1.0	6
300–1500			f/300	6
1500–100,000			5	6
(B) Limits for General Population/Uncontrolled Exposure				
0.3–1.34	614	1.63	*(100)	30
1.34–30	824/f	2.19/f	*(180/f ²)	30
30–300	27.5	0.073	0.2	30
300–1500			f/1500	30
1500–100,000			1.0	30

f = frequency in MHz

* = Plane-wave equivalent power density

NOTE 1 TO TABLE 1: Occupational/controlled limits apply in situations in which persons are exposed as a consequence of their employment provided those persons are fully aware of the potential for exposure and can exercise control over their exposure. Limits for occupational/controlled exposure also apply in situations when an individual is transient through a location where occupational/controlled limits apply provided he or she is made aware of the potential for exposure.

NOTE 2 TO TABLE 1: General population/uncontrolled exposures apply in situations in which the general public may be exposed, or in which persons that are exposed as a consequence of their employment may not be fully aware of the potential for exposure or can not exercise control over their exposure.

7.3 Test Result

Product	: Tiny Bluetooth dongle	Test Mode	: CH Low ~ CH High, GFSK
Test Item	: RF Exposure	Temperature	: 25 °C
Test Voltage	: DC 5V	Humidity	: 56%RH
Test Result	: PASS		

Evaluation of RF Exposure Compliance Requirements	
MPE Prediction of MPE according to equation from page 19 of OET Bulletin 65, Edition 97-01	
RF Exposure Requirements	Compliance with FCC Rules
S=PG/4πR ² Where: S=Power density P=Power input to antenna G=Power gain of the antenna relative to an isotropic radiator R=Distance to the center of radiation of the antenna	Maximum output power at antenna input terminal: 0.29 dBm = 1.069 mW Prediction distance: < 20 cm Antenna gain : 1 dBi Prediction frequency: 2480MHz MPE limit for uncontrolled exposure at prediction frequency: 1.0 mW/cm ² Remark: No non-compliance noted. (SAR evaluation is not required for the PORTABLE device while its maximum output power is low than the general population low threshold: $60/f_{(GHz)} = 60/2.480=24.19mW$)

8. Photos of Testing

8.1 EUT Test Photographs

Conducted emission test view



Radiated emission test view



8. 2 EUT Detailed Photographs

Main & RF board component side







Main & RF board solder side







EUT inside whole view







Main board component side



Main board solder side

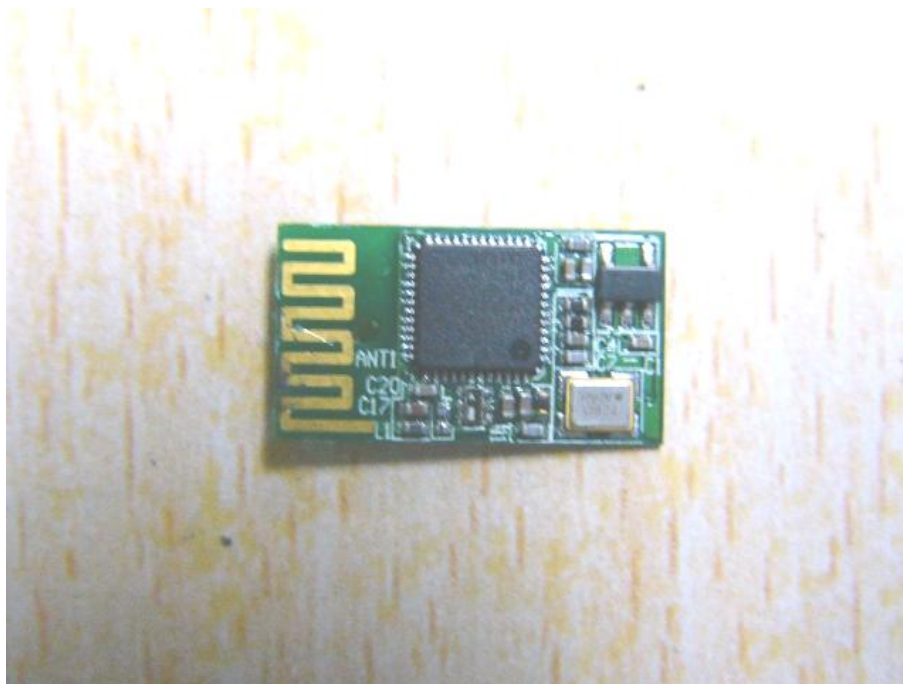

9. FCC ID Label

FCC ID: MSQ-USBBT211

This device complies with Part 15 of the FCC Rules. Operation is subject to the following two conditions: (1) this device may not cause harmful interference, and (2) this device must accept any interference received, including interference that may cause undesired operation.

The Label must not be a stick-on paper label. The Label on these products must be permanently affixed to the product and readily visible at the time of purchase and must last the expected lifetime of the equipment not be readily detachable.

Proposed Label Location on EUT

EUT Bottom View/Proposed FCC ID Label Location



10. Test Equipment

The following test equipments were used during the radiated & conducted emission test:

Equipment/ Facilities	Manufacturer	Model #	Serial No.	Due Date
Turntable	SinTek	N/A	N/A	NCR
Antenna Tower	SinTek	N/A	N/A	NCR
OATS	SinTek	N/A	N/A	Oct. 9, 2010
Bilog Antenna	SCHAFFNER	CBL6111C	2775	June 12, 2010
Pre-Amplifier	HP	8449B	3008B00965	June 12, 2010
Horn Antenna	EMCO	3115	9602-4659	June 12, 2010
Horn Antenna	Rohde & Schwarz	AT4560	SB3435/03	May 4, 2010
EMI Test Receiver	Rohde & Schwarz	ESPI7	100013	July 09, 2010
Spectrum Analyzer	Rohde & Schwarz	FSP40	100273	Sep.18, 2009
Signal Generator	FLUKE	PM5418+Y/C	LO747012	Feb.10, 2010
Signal Generator	FLUKE	PM5418TX	LO738007	Feb.10, 2010
Loop Antenna	SCHWARZBECK	FMZB1516	113	Jan. 30, 2010
Loop Antenna	Rohde & Schwarz	HFH2-Z2	872096/16	Jan. 30, 2010
Trilog-Super Broadband Antenna	SCHWARZBECK	VULB9161	9161-4079	Sep.18, 2009
Trilog-Super Broadband Antenna	SCHWARZBECK	VULB9161	9161-4080	Sep.18, 2009
Broad-Band Horn Antenna	SCHWARZBECK	BBHA 9120D	9120D-564	Sep.18, 2009
Broad-Band Horn Antenna	SCHWARZBECK	BBHA 9120D	9120D-565	Sep.18, 2009
Ultra Broadband Antenna	Rohde & Schwarz	HL 562	100110	June.05, 2010
AMN	Rohde & Schwarz	ESH3-Z5	100196	Oct. 23, 2009
AMN	Rohde & Schwarz	ESH3-Z5	100197	Oct. 23, 2009
Pulse Limiter	Rohde & Schwarz	ESH3-Z2	N/A	N/A
Absorbing Clamp	Rohde & Schwarz	MDS-21	N/A	Oct. 29,2009
KMO Shielded Room	KMO	KMO-001	N/A	N/A
Coaxial Cable with N-Connectors	SCHWARZBECK	AK9515H	95549	Sep.18, 2009
Power Meter	Rohde & Schwarz	NRVD	100041	Feb.10, 2010
Radio Communication Test Set	Rohde & Schwarz	CMS 54	846621/024	Feb.10, 2010
Modulation Analyzer	Hewlett-Packard	8901B	2303A00362	Feb.10, 2010
SOHO Telephone Switching System	IKE	2000-108C	N/A	Feb.10, 2010
Temperature Chamber	TABAI	PSL-4GTW	N/A	Feb.10, 2010