



FCC 47 CFR PART 15 SUBPART C

TEST REPORT

For

Broad Range Wireless Family Router

**Model: RT-G32; RT-G32 V2; RT-G32_V2; RT-G32 V3;
RT-G32_V3; RT-G32 B; RT-G32 B1; RT-N10+; RT-N10Plus;
RT-N10B; RT-N10 B1; RT-N10 V2; RT-N10_V2; RT-N11+;
RT-N11 V2; RT-N11_V2; RT-N11 B**

Trade Name: ASUS

Issued to

**ASUSTeK COMPUTER INC.
NO. 150, Li-Te Rd., Peitou, Taipei, Taiwan, R. O. C.**

Issued by

**Compliance Certification Services Inc.
No. 81-1, Lane 210, Pa-De 2nd Rd., Luchu Hsiang,
Taoyuan Shien, (338) Taiwan, R.O.C.
TEL: 886-3-324-0332
FAX: 886-3-324-5235
<http://www.ccsrf.com>
service@ccsrf.com**



Note: This report shall not be reproduced except in full, without the written approval of Compliance Certification Services Inc. This document may be altered or revised by Compliance Certification Services Inc. personnel only, and shall be noted in the revision section of the document.



Revision History

Rev.	Issue Date	Revisions	Effect Page	Revised By
00	January 25, 2010	Initial Issue	ALL	Kosame Lin



TABLE OF CONTENTS

- 1. TEST RESULT CERTIFICATION4**
- 2. EUT DESCRIPTION.....5**
- 3. TEST METHODOLOGY.....6**
 - 3.1 EUT CONFIGURATION.....6
 - 3.2 EUT EXERCISE.....6
 - 3.3 GENERAL TEST PROCEDURES6
 - 3.4 FCC PART 15.205 RESTRICTED BANDS OF OPERATIONS7
 - 3.5 DESCRIPTION OF TEST MODES8
- 4. INSTRUMENT CALIBRATION9**
 - 4.1 MEASURING INSTRUMENT CALIBRATION.....9
 - 4.2 MEASUREMENT EQUIPMENT USED.....9
 - 4.3 MEASUREMENT UNCERTAINTY.....10
- 5. FACILITIES AND ACCREDITATIONS11**
 - 5.1 FACILTIES11
 - 5.2 EQUIPMENT.....11
 - 5.3 TABLE OF ACCREDITATIONS AND LISTINGS12
- 6. SETUP OF EQUIPMENT UNDER TEST13**
 - 6.1 SETUP CONFIGURATION OF EUT.....13
 - 6.2 SUPPORT EQUIPMENT13
- 7. FCC PART 15.247 REQUIREMENTS14**
 - 7.1 6dB BANDWIDTH.....14
 - 7.2 PEAK POWER.....22
 - 7.3 AVERAGE POWER30
 - 7.4 BAND EDGES MEASUREMENT.....38
 - 7.5 PEAK POWER SPECTRAL DENSITY55
 - 7.6 SPURIOUS EMISSIONS63
 - 7.7 POWERLINE CONDUCTED EMISSIONS.....86
- APPENDIX I RADIO FREQUENCY EXPOSURE89**
- APPENDIX II PHOTOGRAPHS OF TEST SETUP91**



1. TEST RESULT CERTIFICATION

Applicant: ASUSTeK COMPUTER INC.
 NO. 150,Li-Te Rd., Peitou,Taipei, Taiwan,R. O. C.

Equipment Under Test: Broad Range Wireless Family Router

Trade Name: ASUS

Model: RT-G32; RT-G32 V2; RT-G32_V2; RT-G32 V3;
 RT-G32_V3; RT-G32 B; RT-G32 B1;
 RT-N10+; RT-N10Plus; RT-N10B; RT-N10 B1;
 RT-N10 V2; RT-N10_V2; RT-N11+;
 RT-N11 V2; RT-N11_V2; RT-N11 B

Date of Test: November 23 ~ December 3, 2009

APPLICABLE STANDARDS	
STANDARD	TEST RESULT
FCC 47 CFR Part 15 Subpart C	No non-compliance noted

We hereby certify that:

The above equipment was tested by Compliance Certification Services Inc. The test data, data evaluation, test procedures, and equipment configurations shown in this report were made in accordance with the procedures given in ANSI C63.4: 2003 and the energy emitted by the sample EUT tested as described in this report is in compliance with the requirements of FCC Rules Part 15.207, 15.209, 15.247.

The test results of this report relate only to the tested sample EUT identified in this report.

Approved by:

Ethan Huang
Section Manager

Reviewed by:

Stan Lin
Supervisor



2. EUT DESCRIPTION

Product	Broad Range Wireless Family Router		
Trade Name	ASUS		
Model Number	RT-G32; RT-G32 V2; RT-G32_V2; RT-G32 V3; RT-G32_V3; RT-G32 B; RT-G32 B1; RT-N10+; RT-N10Plus; RT-N10B; RT-N10 B1; RT-N10 V2; RT-N10_V2; RT-N11+; RT-N11 V2; RT-N11_V2; RT-N11 B		
Model Discrepancy	1. All the model numbers (list on this report) are identical, just for marketing purpose only. 2. Client consigns only one model sample (Model number: RT-G32) to test. Therefore, testing Lab. just guarantees the units, which have been tested.		
EUT Power Rating	12VDC		
Power Adapter	OEM	Model	ADS0129-B 120100
			ADS0129-W 120100
Power Adapter Power Rating	For ADS0129-B 120100; ADS0129-W 120100 I/P: 100-240VAC, 50/60Hz, 0.5A O/P: 12VDC, 1.0A		
Operating Frequency Range	2412 ~ 2462 MHz		
Transmit Power	IEEE 802.11b mode: 16.80 dBm IEEE 802.11g mode: 17.60 dBm draft 802.11n 20 MHz Channel mode: 17.47 dBm draft 802.11n 40 MHz Channel mode: 17.26 dBm		
Modulation Technique	IEEE 802.11b mode: DSSS (1, 2, 5.5 and 11 Mbps) IEEE 802.11g mode: OFDM (6, 9, 12, 18, 24, 36, 48 and 54 Mbps) draft 802.11n 20 MHz Channel mode: OFDM (6.5, 7.2, 13, 14.4, 14.44, 19.5, 21.7, 26, 28.89, 28.9, 39, 43.3, 43.33, 52, 57.78, 57.8, 58.5, 65.0, 72.2, 78, 86.67, 104, 115.56, 117, 130, 144.44 Mbps) draft 802.11n 40 MHz Channel mode: OFDM (13.5, 15, 27, 30, 40.5, 45, 54, 60, 81, 90, 108, 120, 121.5, 135, 150, 162, 180, 216, 240, 243, 270, 300 Mbps)		
Number of Channels	IEEE 802.11b/g mode: 11 Channels draft 802.11n 20 MHz Channel mode: 11 Channels draft 802.11n 40 MHz Channel mode: 7 Channels		
Antenna Specification	Dipole Antenna / Gain: 2.25dBi		

Remark:

1. The sample selected for test was production product and was provided by manufacturer.
2. This submittal(s) (test report) is intended for FCC ID: **MSQ-RTG32** filing to comply with Section 15.207, 15.209 and 15.247 of the FCC Part 15, Subpart C Rules.



3. TEST METHODOLOGY

The tests documented in this report were performed in accordance with ANSI C63.4: 2003 and FCC CFR 47 Part 2, Part 15.207, 15.209 and 15.247.

3.1 EUT CONFIGURATION

The EUT configuration for testing is installed on RF field strength measurement to meet the Commissions requirement and operating in a manner that intends to maximize its emission characteristics in a continuous normal application.

3.2 EUT EXERCISE

The EUT was operated in the engineering mode to fix the TX frequency that was for the purpose of the measurements.

According to its specifications, the EUT must comply with the requirements of the Section 15.207, 15.209 and 15.247 under the FCC Rules Part 15 Subpart C.

3.3 GENERAL TEST PROCEDURES

Conducted Emissions

The EUT is placed on the turntable, which is 0.8 m above ground plane. According to the requirements in Section 13.1.4.1 of ANSI C63.4: 2003 Conducted emissions from the EUT measured in the frequency range between 0.15 MHz and 30MHz using CISPR Quasi-peak and average detector modes.

Radiated Emissions

The EUT is placed on a turn table, which is 0.8 m above ground plane. The turntable shall rotate 360 degrees to determine the position of maximum emission level. EUT is set 3m away from the receiving antenna, which varied from 1m to 4m to find out the highest emission. And also, each emission was to be maximized by changing the polarization of receiving antenna both horizontal and vertical. In order to find out the maximum emissions, exploratory radiated emission measurements were made according to the requirements in Section 13.1.4.1 of ANSI C63.4: 2003.



3.4 FCC PART 15.205 RESTRICTED BANDS OF OPERATIONS

(a) Except as shown in paragraph (d) of this section, only spurious emissions are permitted in any of the frequency bands listed below:

MHz	MHz	MHz	GHz
0.090 - 0.110	16.42 - 16.423	399.9 - 410	4.5 - 5.15
¹ 0.495 - 0.505	16.69475 - 16.69525	608 - 614	5.35 - 5.46
2.1735 - 2.1905	16.80425 - 16.80475	960 - 1240	7.25 - 7.75
4.125 - 4.128	25.5 - 25.67	1300 - 1427	8.025 - 8.5
4.17725 - 4.17775	37.5 - 38.25	1435 - 1626.5	9.0 - 9.2
4.20725 - 4.20775	73 - 74.6	1645.5 - 1646.5	9.3 - 9.5
6.215 - 6.218	74.8 - 75.2	1660 - 1710	10.6 - 12.7
6.26775 - 6.26825	108 - 121.94	1718.8 - 1722.2	13.25 - 13.4
6.31175 - 6.31225	123 - 138	2200 - 2300	14.47 - 14.5
8.291 - 8.294	149.9 - 150.05	2310 - 2390	15.35 - 16.2
8.362 - 8.366	156.52475 -	2483.5 - 2500	17.7 - 21.4
8.37625 - 8.38675	156.52525	2655 - 2900	22.01 - 23.12
8.41425 - 8.41475	156.7 - 156.9	3260 - 3267	23.6 - 24.0
12.29 - 12.293	162.0125 - 167.17	3332 - 3339	31.2 - 31.8
12.51975 - 12.52025	167.72 - 173.2	3345.8 - 3358	36.43 - 36.5
12.57675 - 12.57725	240 - 285	3600 - 4400	(²)
13.36 - 13.41	322 - 335.4		

¹ Until February 1, 1999, this restricted band shall be 0.490-0.510 MHz.

² Above 38.6

(b) Except as provided in paragraphs (d) and (e), the field strength of emissions appearing within these frequency bands shall not exceed the limits shown in Section 15.209. At frequencies equal to or less than 1000 MHz, compliance with the limits in Section 15.209 shall be demonstrated using measurement instrumentation employing a CISPR quasi-peak detector. Above 1000 MHz, compliance with the emission limits in Section 15.209 shall be demonstrated based on the average value of the measured emissions. The provisions in Section 15.35 apply to these measurements.



3.5 DESCRIPTION OF TEST MODES

The EUT is a 1x1 SISO transmitter.

The EUT (model: RT-G32) had been tested under operating condition.

Software used to control the EUT for staying in continuous transmitting mode was programmed.

The worst case data rate is determined as the data rate with highest output power.

After verification, all tests were carried out with the worst case test modes as shown below except radiated spurious emission below 1GHz, which worst case was in normal link mode only.

IEEE 802.11b mode:

Channel Low (2412MHz), Channel Mid (2437MHz) and Channel High (2462MHz) with 1Mbps data rate was chosen for full testing.

IEEE 802.11g mode:

Channel Low (2412MHz), Channel Mid (2437MHz) and Channel High (2462MHz) with 6Mbps data rate was chosen for full testing.

draft 802.11n 20 MHz Channel mode:

Channel Low (2412MHz), Channel Mid (2437MHz) and Channel High (2462MHz) with 13.5Mbps data rate were chosen for full testing.

draft 802.11n 40 MHz Channel mode:

Channel Low (2422MHz), Channel Mid (2437MHz) and Channel High (2452MHz) with 13.5Mbps data rate were chosen for full testing.



4. INSTRUMENT CALIBRATION

4.1 MEASURING INSTRUMENT CALIBRATION

The measuring equipment, which was utilized in performing the tests documented herein, has been calibrated in accordance with the manufacturer's recommendations for utilizing calibration equipment, which is traceable to recognized national standards.

4.2 MEASUREMENT EQUIPMENT USED

Equipment Used for Emissions Measurement

Remark: Each piece of equipment is scheduled for calibration once a year.

Conducted Emissions Test Site				
Name of Equipment	Manufacturer	Model	Serial Number	Calibration Due
Spectrum Analyzer	Agilnet	E4446A	MY48250064	10/28/2010
Spectrum Analyzer	R&S	FSEB	825829/011	10/29/2010

3M Semi Anechoic Chamber				
Name of Equipment	Manufacturer	Model	Serial Number	Calibration Due
Spectrum Analyzer	Agilnet	E4446A	MY48250064	10/28/2010
Spectrum Analyzer	R&S	FSEB	825829/011	10/29/2010
Pre-Amplifier	HP	8447D	2944A06530	12/31/2010
Pre-Amplifier	HP	8449B	3008A01738	04/17/2010
EMI Test Receiver	SCHAFFNER	SCR 3501	436	01/21/2010
Loop Antenna	EMCO	6502	2356	05/28/2010
Bilog Antenna	SCHWAZBECK	VULB9160	3084	09/08/2010
Horn Antenna	EMCO	3115	00022250	05/08/2010
Turn Table	CCS	CC-T-1F	N/A	N.C.R
Antenna Tower	CCS	CC-A-1F	N/A	N.C.R
Controller	CCS	CC-C-1F	N/A	N.C.R
Test S/W	LabVIEW 6.1 (Wugu Chamber EMI Teat V1_4.5.3)			

Powerline Conducted Emissions Test Site				
Name of Equipment	Manufacturer	Model	Serial Number	Calibration Due
TEST RECEIVER	R&S	ESHS20	840455/006	02/12/2010
LISN (EUT)	SCHWARZBECK	NSLK 8127	8127382	12/09/2010
LISN	SOLAR	8012-50-R-24-BNC	8305114	12/09/2010
BNC CABLE	MIYAZAKI	5D-FB	BNC A4	05/12/2010
THERMO-HYGRO METER	TECPEL	DTM-303	No.7	11/24/2010
Test S/W	EMI 32.exe			



4.3 MEASUREMENT UNCERTAINTY

Parameter	Uncertainty
Powerline Conducted Emission	± 1.7376
3M Semi Anechoic Chamber / 30MHz ~ 1GHz	± 3.8856
3M Semi Anechoic Chamber / Above 1GHz	± 3.8721

Remark: *This uncertainty represents an expanded uncertainty expressed at approximately the 95% confidence level using a coverage factor of k=2.*



5. FACILITIES AND ACCREDITATIONS

5.1 FACILITIES

All measurement facilities used to collect the measurement data are located at

No.199, Chungsen Road, Hsintien City, Taipei Hsien, Taiwan, R.O.C.

Tel: 886-2-2217-0894 / Fax: 886-2-2217-1029

No.11, Wugong 6th Rd., Wugu Industrial Park, Taipei Hsien 248, Taiwan

Tel: 886-2-2299-9720 / Fax: 886-2-2298-4045

No. 81-1, Lane 210, Pa-De 2nd Rd., Luchu Hsiang, Taoyuan Shien, (338) Taiwan, R.O.C.

Tel: 886-3-324-0332 / Fax: 886-3-324-5235

The sites are constructed in conformance with the requirements of ANSI C63.7, ANSI C63.4: 2003 and CISPR Publication 22.

5.2 EQUIPMENT





Radiated emissions are measured with one or more of the following types of linearly polarized antennas: tuned dipole, biconical, log periodic, bi-log, and/or ridged waveguide, horn. Spectrum analyzers with pre-selectors and quasi-peak detectors are used to perform radiated measurements.

Conducted emissions are measured with Line Impedance Stabilization Networks and EMI Test Receivers.

Calibrated wideband preamplifiers, coaxial cables, and coaxial attenuators are also used for making measurements.

All receiving equipment conforms to CISPR Publication 16-1, "Radio Interference Measuring Apparatus and Measurement Methods."

5.3 TABLE OF ACCREDITATIONS AND LISTINGS

Country	Agency	Scope of Accreditation	Logo
USA	A2LA	CFR 47, FCC Part15/18, CISPR 22, EN 55022, ICES-003, AS/NZS CISPR 22, VCCI V-3, EN 55011, CISPR 11, IEC/EN 61000-4-2/3/4/5/6/8/11, EN 61000-6-1/2/3/4, EN 55024, CISPR 24, AS/NZS CISPR 24, AS/NZS 61000.6.2, EN 55014-1/-2, ETSI EN 300 386 v1.3.2/v1.3.3, IEC/EN 61000-3-2, AS/NZS 61000.3.2, IEC/EN 61000-3-3, AS/NZS 61000.3.3	 ACCREDITED No. 0824-01
USA	FCC MRA	3/10 meter Open Area Test Sites to perform FCC Part 15/18 measurements	 FC _{TW1026}
Japan	VCCI	3/10 meter Open Area Test Sites and conducted test sites to perform radiated/conducted measurements	VCCI R-2882/2541/2798/725/1868 C-402/747/912 T-321/325
Taiwan	TAF	EN 55014-1, CISPR 14, CNS 13781-1, EN 55013, CISPR 13, CNS 13439, EN 55011, CISPR 11, CNS 13803, PLMN09, IS2045-0, LP0002 FCC Part 27/90, Part 15B/C/D/E, RSS-192/193/210/310 ETSI EN 300 328/ 300 220-1/ 300 220-2/ 301 893/ 301 489-01/ 301 489-03/ 301 489-07 / 301 489-17/ 300 440-1/ 300 440-2 AS/NZS 4268, AS/NZS 4771 CISPR 22, EN 55022, CNS 13438, AS/NZS CISPR 22, VCCI, IEC/EN 61000-4-2/3/4/5/6/8/11, CNS 14676-2/3/4/5/6/8, CNS 14934-2/3, CNS 13783-1, CNS 13439, CNS 13803	 IAC-MRA TAF Testing Laboratory 0363
Taiwan	BSMI	CNS 13438, CNS 13783-1, CNS 13439, CNS 14115	SL2-IS-E-0014 / IN-E-0014 /A1-E-0014 /R1-E-0014 /R2-E-0014 /L1-E-0014
Canada	Industry Canada	RSS212, Issue 1	 Canada IC 2324C-3 IC 2324C-5

Note: No part of this report may be used to claim or imply product endorsement by A2LA, TAF or other government agency.



6. SETUP OF EQUIPMENT UNDER TEST

6.1 SETUP CONFIGURATION OF EUT

See test photographs attached in Appendix 1 for the actual connections between EUT and support equipment.

6.2 SUPPORT EQUIPMENT

For Radiated and Conducted Measurement Below 1GHz							
No.	Device Type	Brand	Model	Series No.	FCC ID	Data Cable	Power Cord
1	Traveling Disk	PQI	U172	N/A	FCC Doc	Unshielded, 1.8m	N/A

For Radiated and Conducted Measurement Above 1GHz							
No.	Device Type	Brand	Model	Series No.	FCC ID	Data Cable	Power Cord
	N/A						

For Powerline Measurement							
No.	Device Type	Brand	Model	Series No.	FCC ID	Data Cable	Power Cord
1.	USB Mouse	Dell	MOC5UO	H1606PRO	FCC Doc	Shielded, 1.8m	N/A
2.	USB Keyboard	Dell	SK-8115	N/A	FCC Doc	Shielded, 1.8m with a core	N/A
3.	Modem	TOP-SOLUTION	5JEG4033MKO	L0063CG2D007217	FCC Doc	Shielded, 1.8m	Unshielded, 1.8m
4.	Monitor	SAMSUNG	710V	GS17H9NXA05853A	FCC Doc	Shielded, 1.8m with two cores	Unshielded, 1.8m
5.	Host PC	DELL	DCSM	49QTY1S	FCC Doc	USB Cable: Unshielded, 1.0m LAN Cable: Unshielded, 1.0m	Unshielded, 1.8m
6.	Printer	HP	Deskjet D2360	TH73C1492F	FCC Doc	Shielded, 1.8m	Unshielded, 1.8m
7.	Server Notebook	HP	2210B	CNV7472KG5	FCC Doc	Unshielded, 20m	Unshielded, 1.8m
8.	LAN Load	N/A	N/A	N/A	FCC Doc	Unshielded, 3m X3	N/A

Remark: Grounding was established in accordance with the manufacturer's requirements and conditions for the intended use.

7. FCC PART 15.247 REQUIREMENTS

7.1 6dB BANDWIDTH

LIMIT

According to §15.247(a)(2), systems using digital modulation techniques may operate in the 902 - 928 MHz, 2400 - 2483.5 MHz, and 5725 - 5850 MHz bands. The minimum 6 dB bandwidth shall be at least 500 kHz.

TEST CONFIGURATION

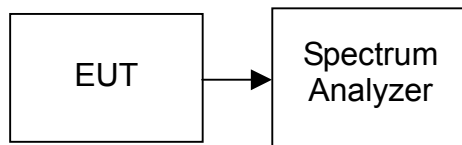

TEST PROCEDURE

1. Place the EUT on the table and set it in the transmitting mode.
2. Remove the antenna from the EUT and then connect a low loss RF cable from the antenna port to the spectrum analyzer.
3. Set the spectrum analyzer as RBW = 100kHz, VBW = 300kHz, Span = 30MHz, Sweep = auto.
4. Mark the peak frequency and -6dB (upper and lower) frequency.
5. Repeat until all the rest channels are investigated.

TEST RESULTS

No non-compliance noted



TEST DATA

Test mode: IEEE 802.11b mode

Channel	Frequency (MHz)	Bandwidth (MHz)	Limit (kHz)	Result
Low	2412	12.204	>500	PASS
Mid	2437	12.204		PASS
High	2462	12.264		PASS

Test mode: IEEE 802.11g mode

Channel	Frequency (MHz)	Bandwidth (MHz)	Limit (kHz)	Result
Low	2412	16.533	>500	PASS
Mid	2437	16.533		PASS
High	2462	16.533		PASS

Test mode: draft 802.11n 20 MHz Channel mode

Channel	Frequency (MHz)	Bandwidth (MHz)	Limit (kHz)	Result
Low	2412	17.615	>500	PASS
Mid	2437	17.675		PASS
High	2462	17.495		PASS

Test mode: draft 802.11n 40 MHz Channel mode

Channel	Frequency (MHz)	Bandwidth (MHz)	Limit (kHz)	Result
Low	2422	36.373	>500	PASS
Mid	2437	36.273		PASS
High	2452	36.373		PASS



Test Plot

IEEE 802.11b mode

6dB Bandwidth (CH Low)

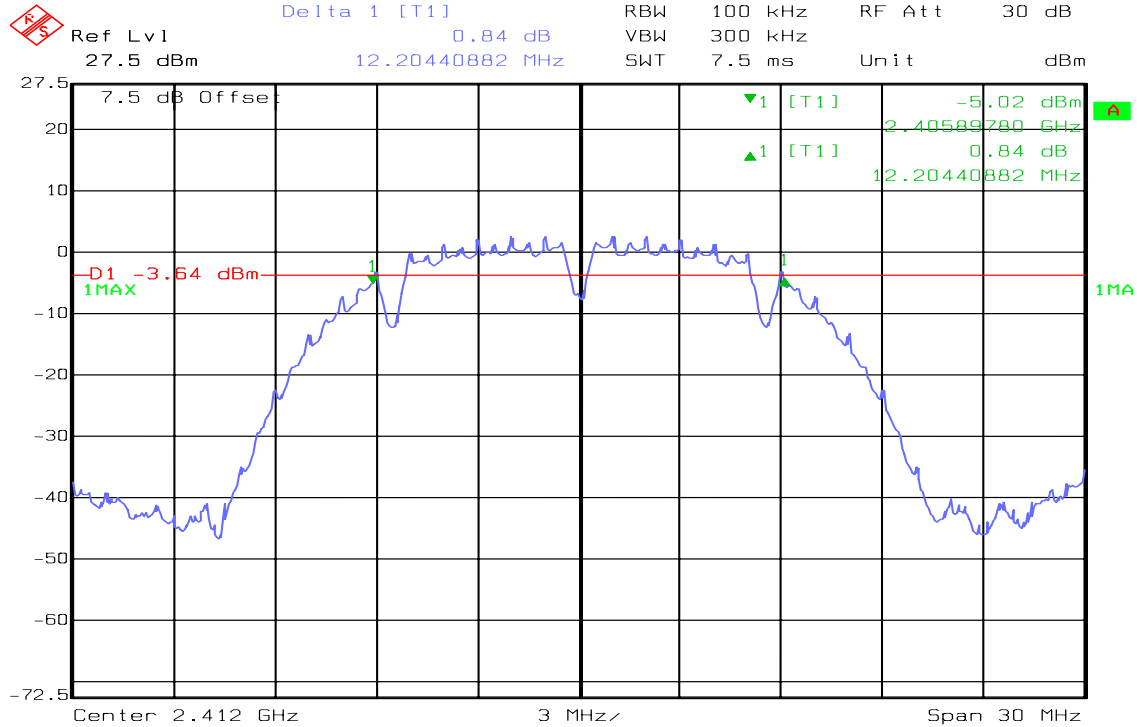

Date: 27.NOV.2009 09:49:20

6dB Bandwidth (CH Mid)

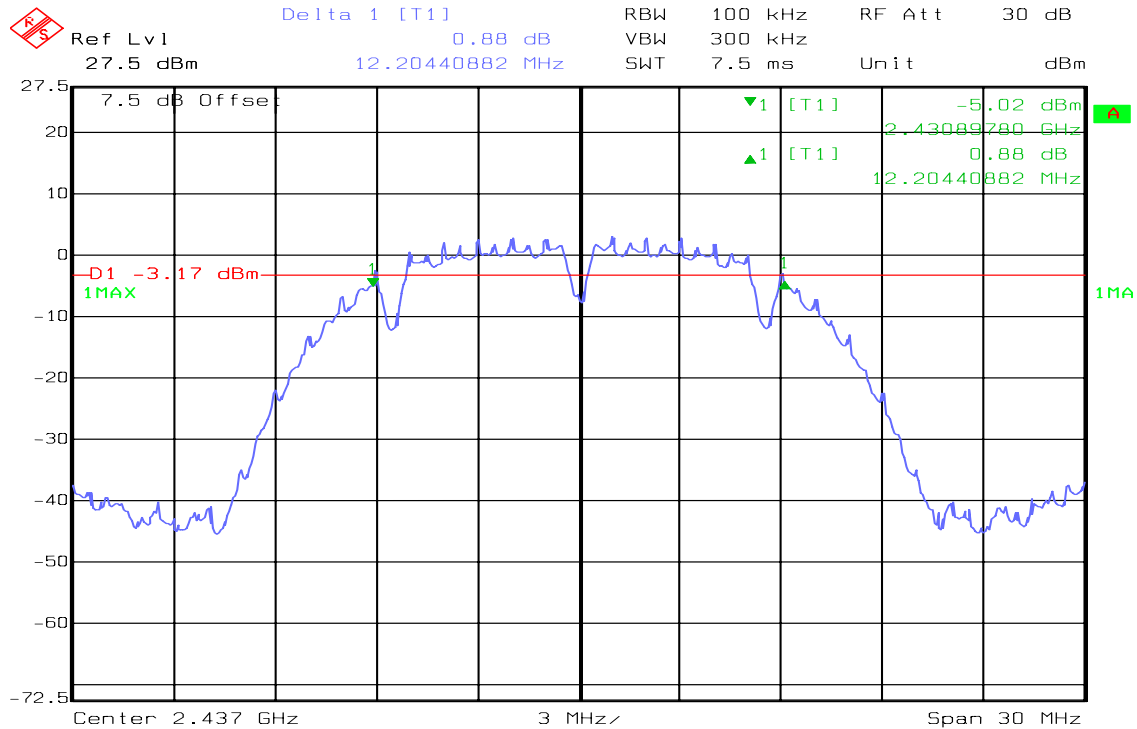

Date: 27.NOV.2009 09:55:28



6dB Bandwidth (CH High)

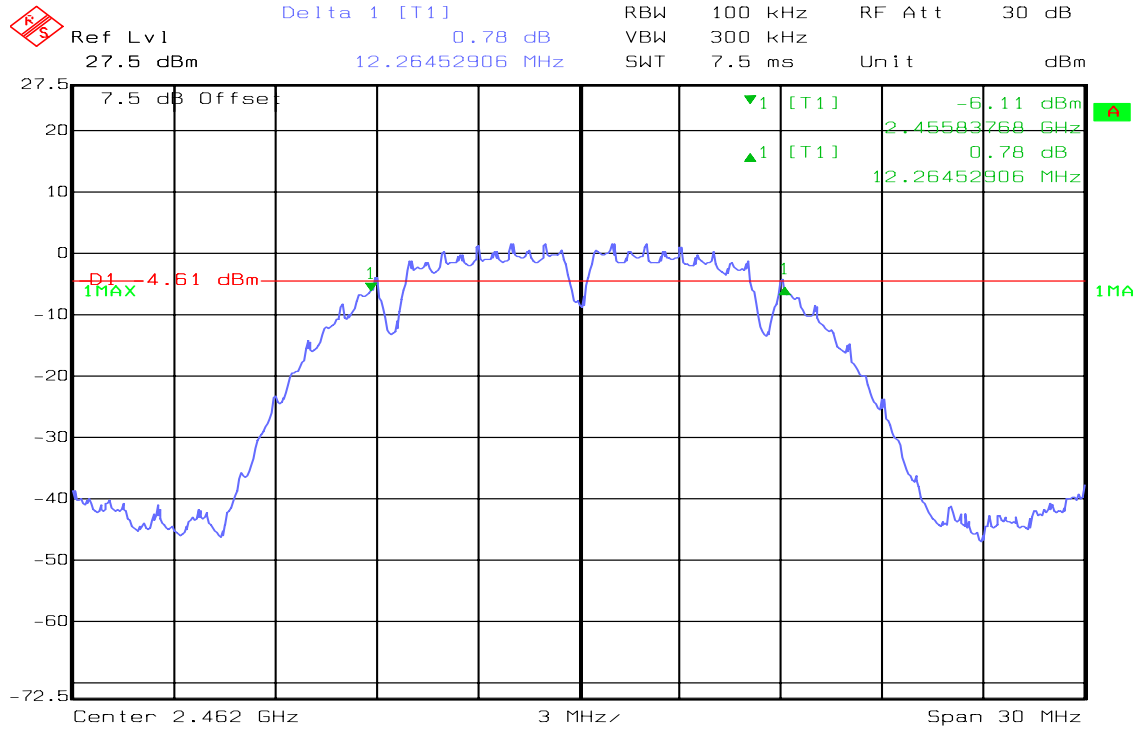

Date: 27.NOV.2009 09:59:06

IEEE 802.11g mode

6dB Bandwidth (CH Low)

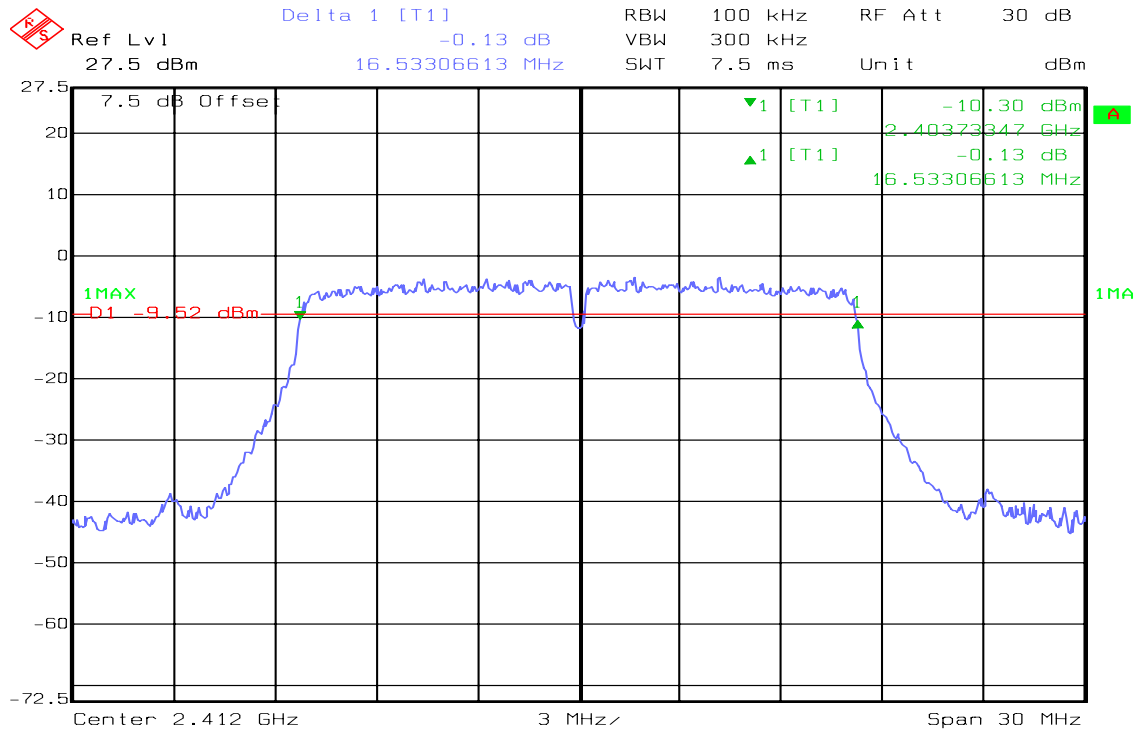

Date: 27.NOV.2009 10:09:13



6dB Bandwidth (CH Mid)

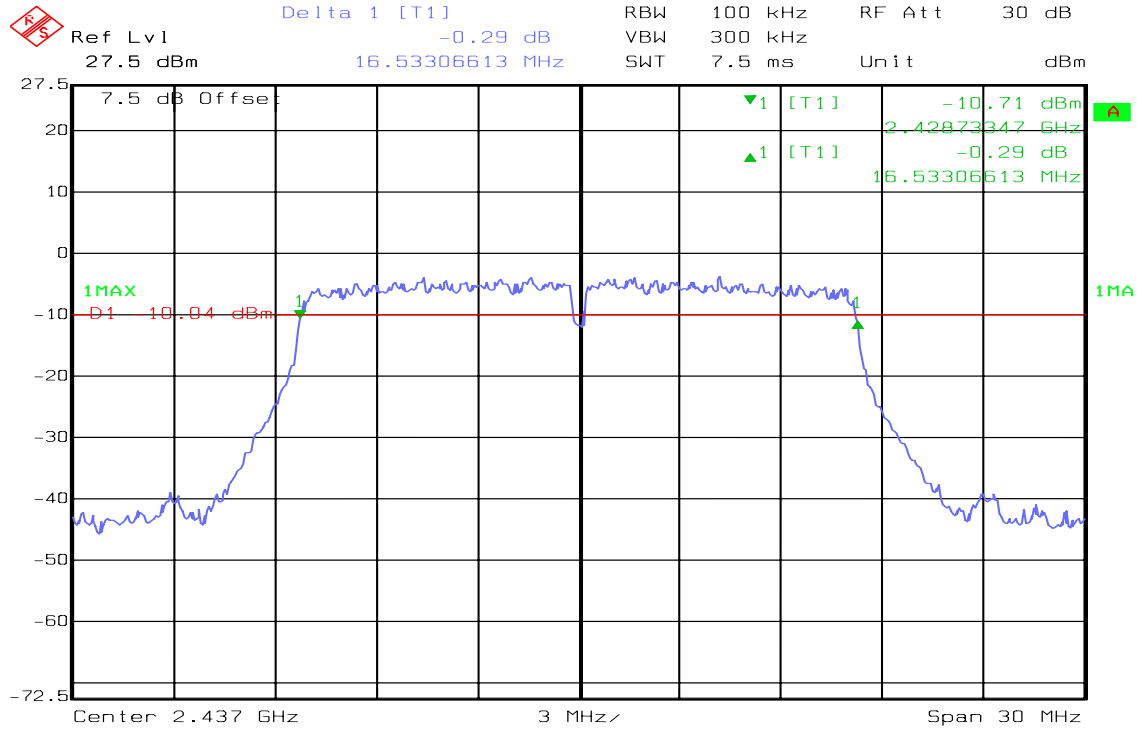

Date: 27.NOV.2009 10:04:25

6dB Bandwidth (CH High)

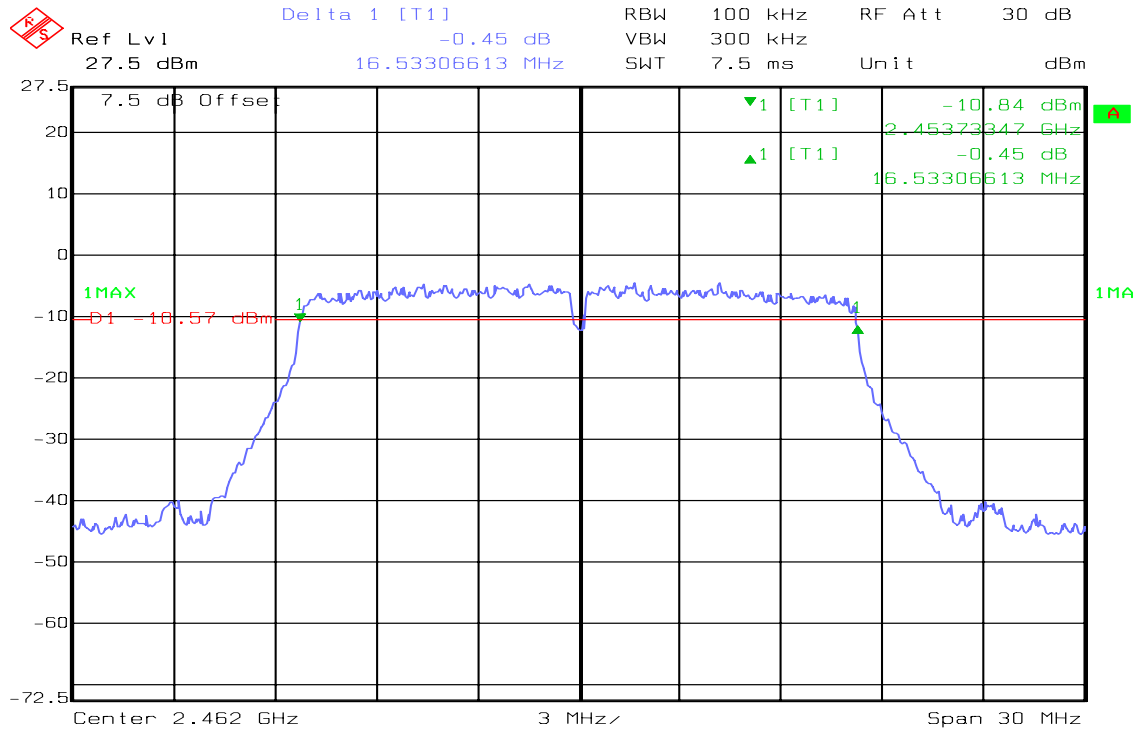

Date: 27.NOV.2009 10:02:27



draft 802.11n 20 MHz Channel mode

6dB Bandwidth (CH Low)

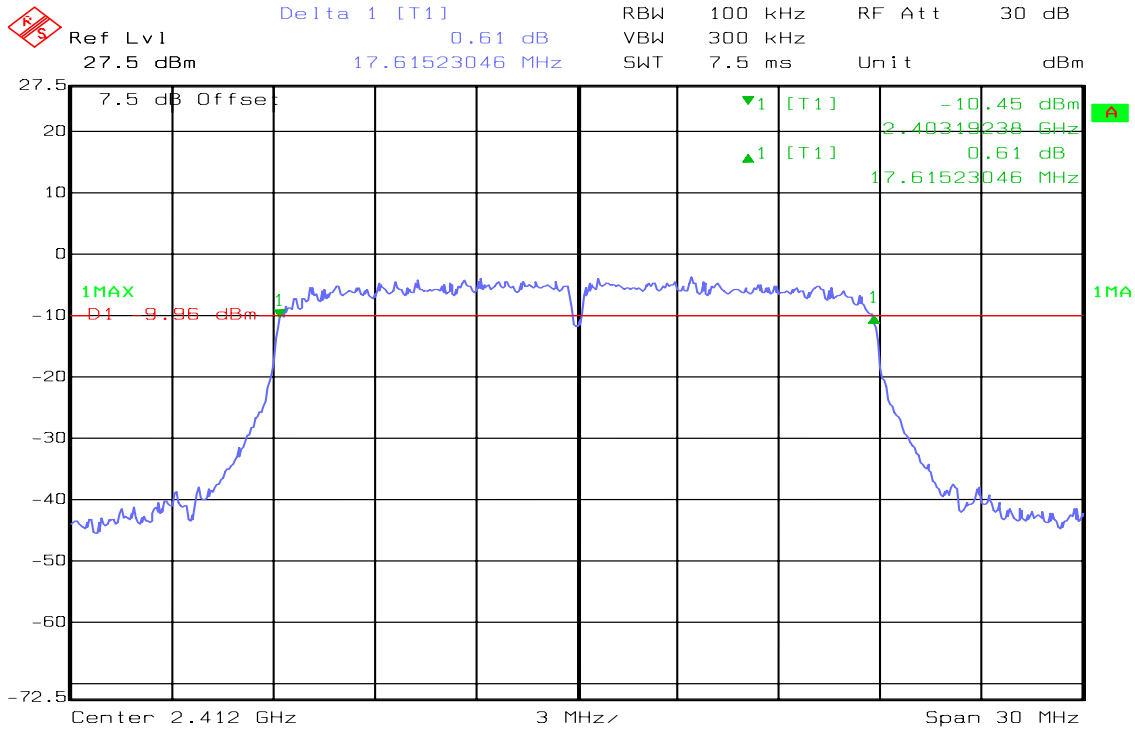

Date: 27.NOV.2009 10:12:12

6dB Bandwidth (CH Mid)

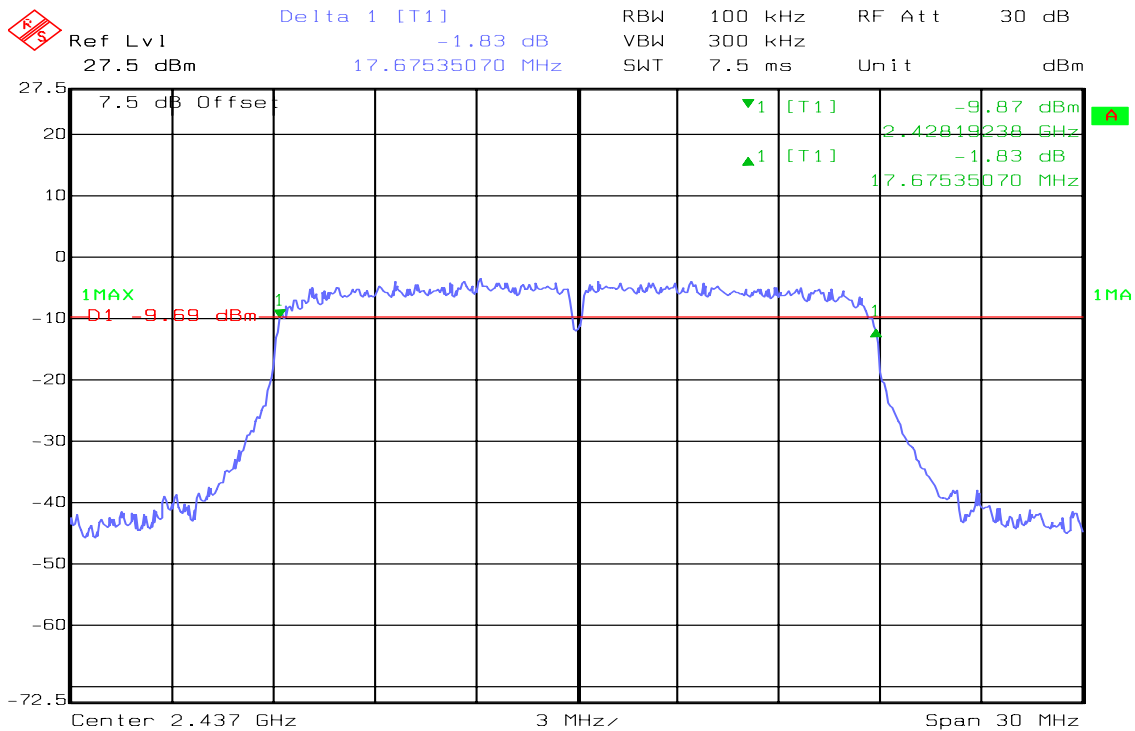

Date: 27.NOV.2009 10:20:36



6dB Bandwidth (CH High)

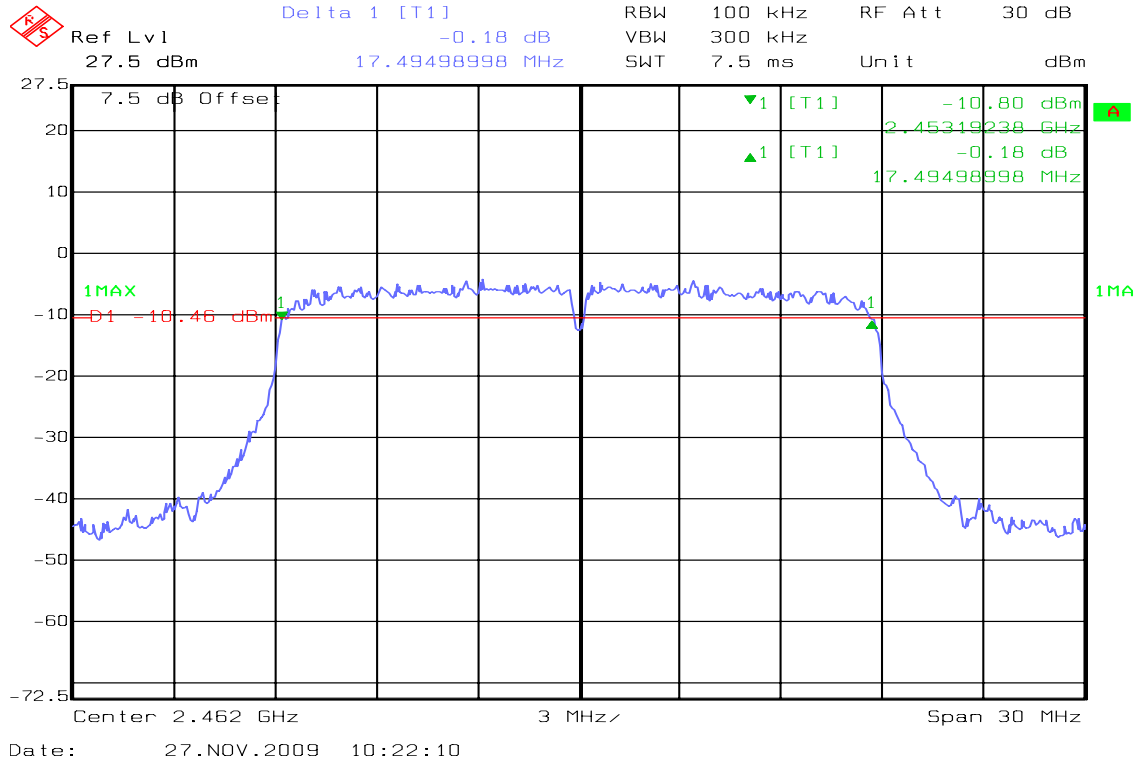

draft 802.11n 40 MHz Channel mode

6dB Bandwidth (CH Low)

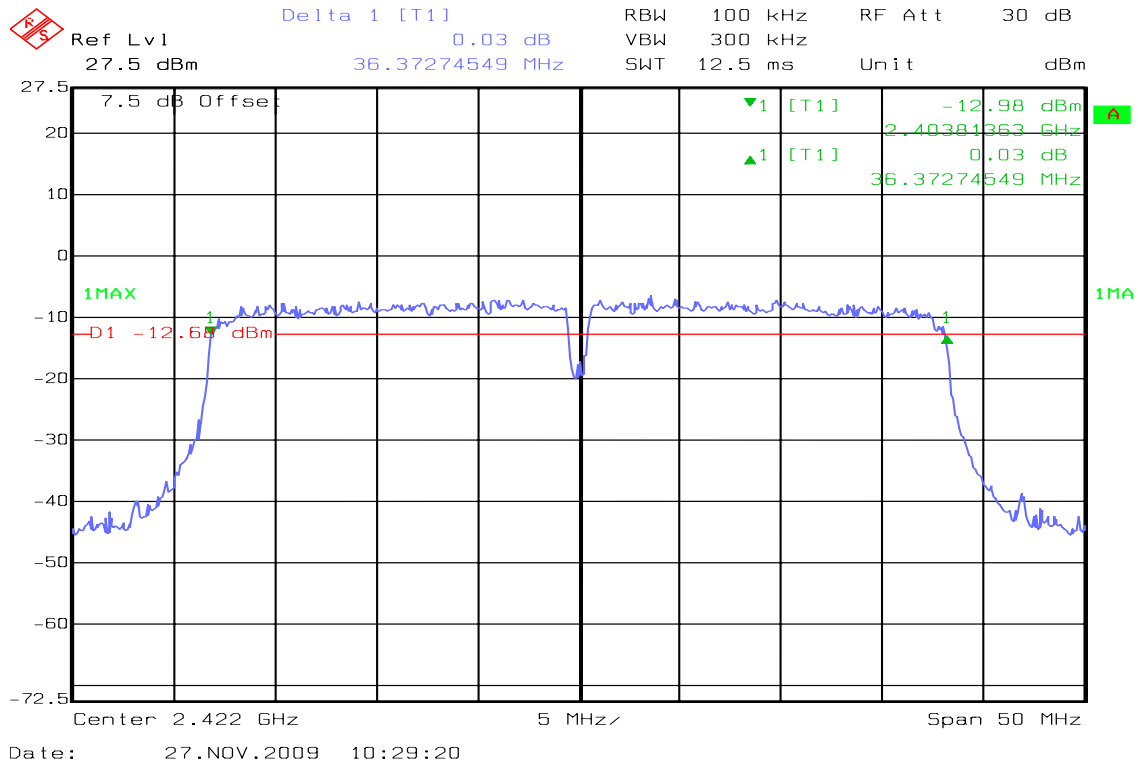



6dB Bandwidth (CH Mid)

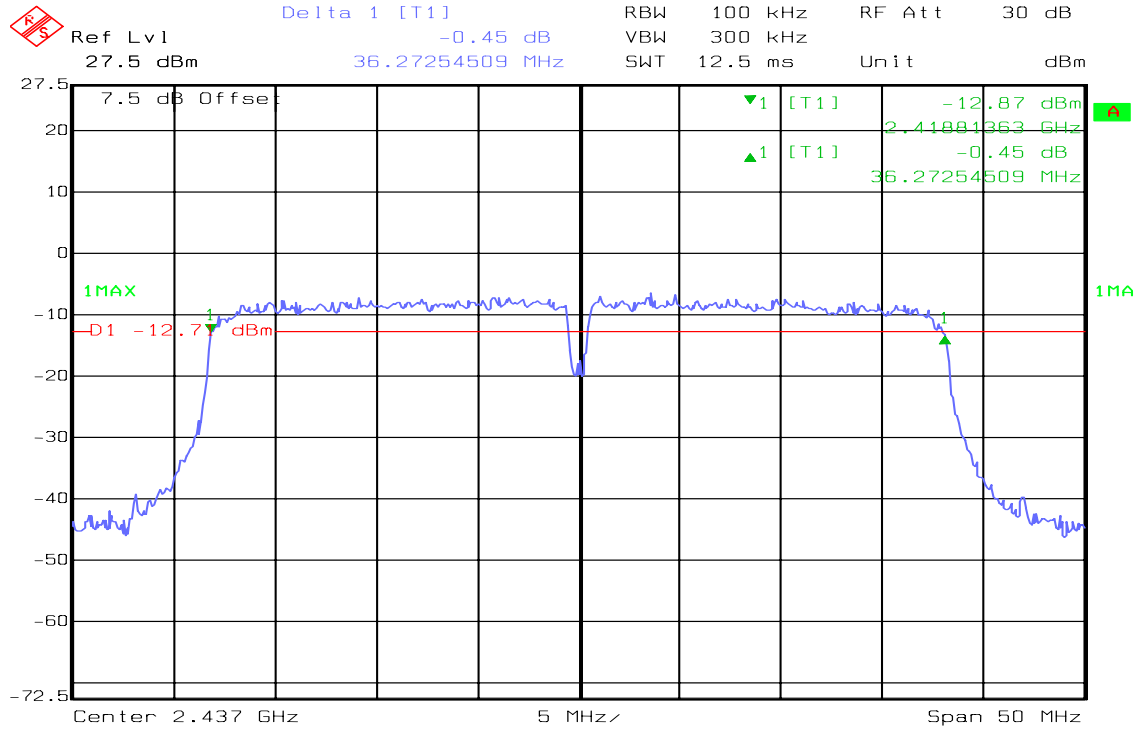

Date: 27.NOV.2009 10:27:18

6dB Bandwidth (CH High)

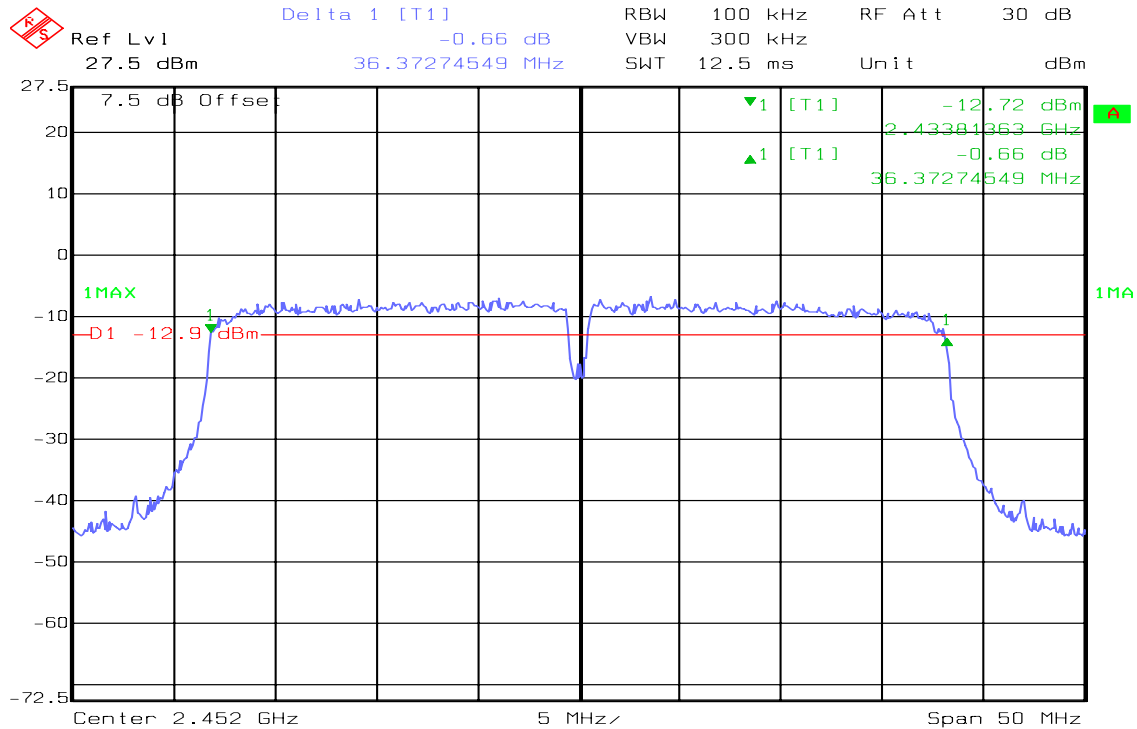

Date: 27.NOV.2009 10:25:07

7.2 PEAK POWER

LIMIT

The maximum peak output power of the intentional radiator shall not exceed the following:

1. According to §15.247(b)(3), for systems using digital modulation in the bands of 902-928 MHz, 2400-2483.5 MHz, and 5725-5850 MHz: 1 Watt.
2. According to §15.247(b)(4), the conducted output power limit specified in paragraph (b) of this section is based on the use of antennas with directional gains that do not exceed 6 dBi. Except as shown in paragraph (c) of this section, if transmitting antennas of directional gain greater than 6 dBi are used, the conducted output power from the intentional radiator shall be reduced below the stated values in paragraphs (b)(1), (b)(2), and (b)(3) of this section, as appropriate, by the amount in dB that the directional gain of the antenna exceeds 6 dBi.

TEST CONFIGURATION

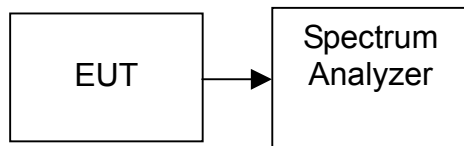

TEST PROCEDURE

The transmitter output is connected to the Spectrum analyzer. The Spectrum analyzer is set to the peak power detection.

TEST RESULTS

No non-compliance noted



TEST DATA

Test mode: IEEE 802.11b mode

Channel	Frequency (MHz)	Output Power (dBm)	Output Power (W)	Limit (W)	Result
Low	2412	16.50	0.04467	1.00	PASS
Mid	2437	16.80	0.04786		PASS
High	2462	15.80	0.03802		PASS

Test mode: IEEE 802.11g mode

Channel	Frequency (MHz)	Output Power (dBm)	Output Power (W)	Limit (W)	Result
Low	2412	17.53	0.05662	1.00	PASS
Mid	2437	17.60	0.05754		PASS
High	2462	16.35	0.04315		PASS

Test mode: draft 802.11n 20 MHz Channel mode

Channel	Frequency (MHz)	Output Power (dBm)	Output Power (W)	Limit (W)	Result
Low	2412	17.47	0.05585	1.00	PASS
Mid	2437	17.36	0.05445		PASS
High	2462	16.68	0.04656		PASS

Test mode: draft 802.11n 40 MHz Channel mode

Channel	Frequency (MHz)	Output Power (dBm)	Output Power (W)	Limit (W)	Result
Low	2422	17.26	0.05321	1.00	PASS
Mid	2437	17.14	0.05176		PASS
High	2452	16.54	0.04508		PASS



Test Plot

IEEE 802.11b mode

Peak Power (CH Low)

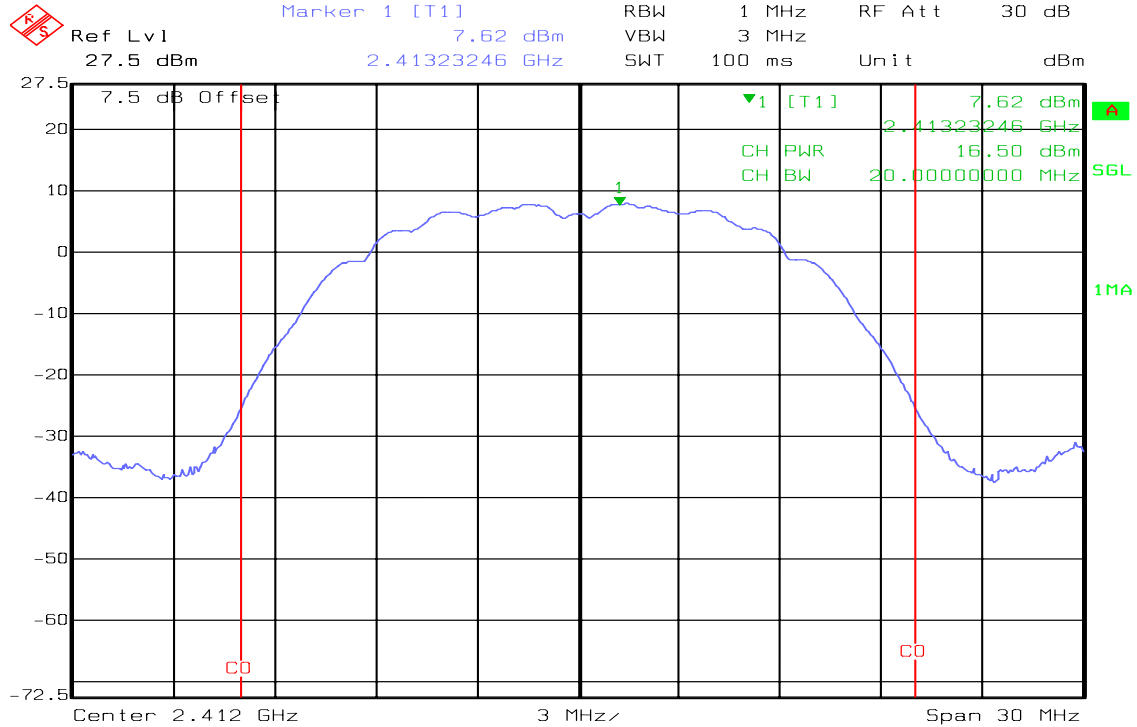

Date: 27.NOV.2009 11:11:22

Peak Power (CH Mid)

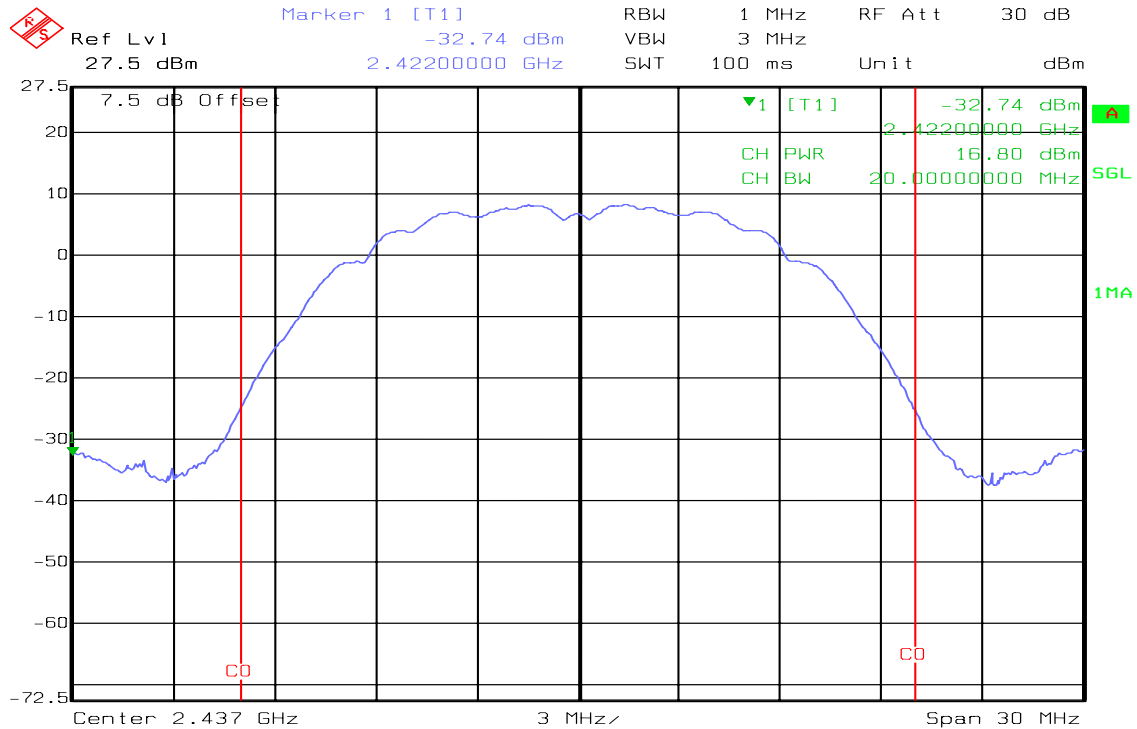

Date: 27.NOV.2009 10:58:21



Peak Power (CH High)

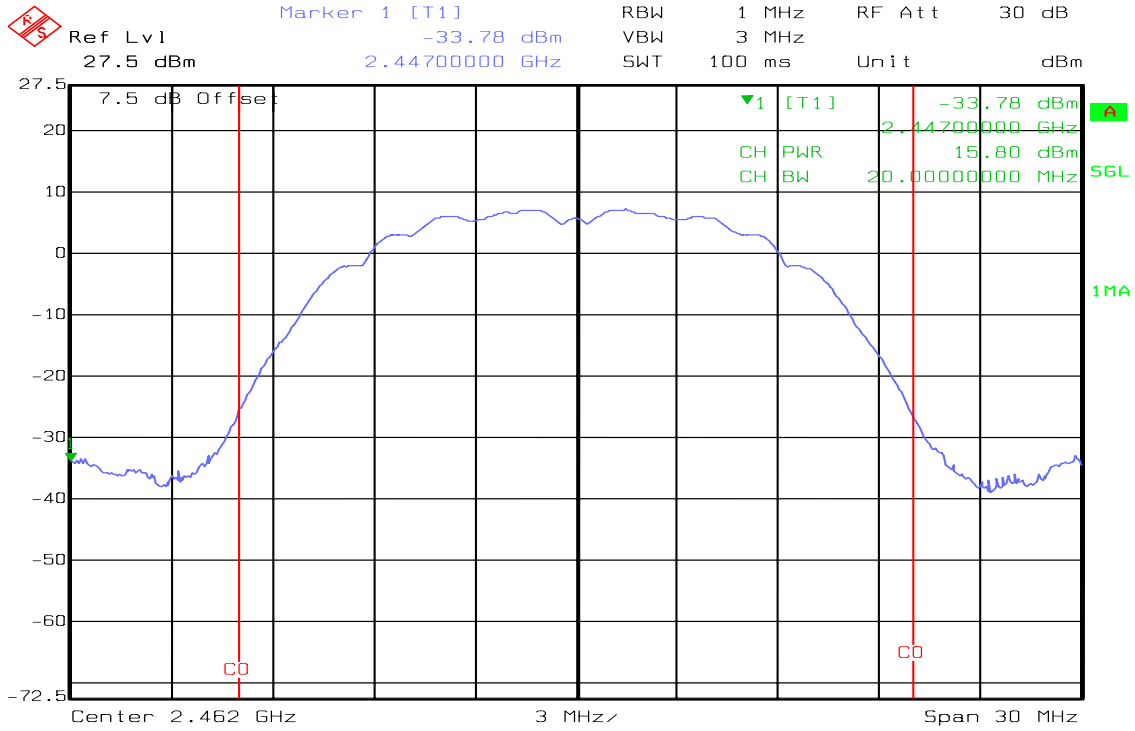

Date: 27.NOV.2009 11:12:31

IEEE 802.11g mode

Peak Power (CH Low)

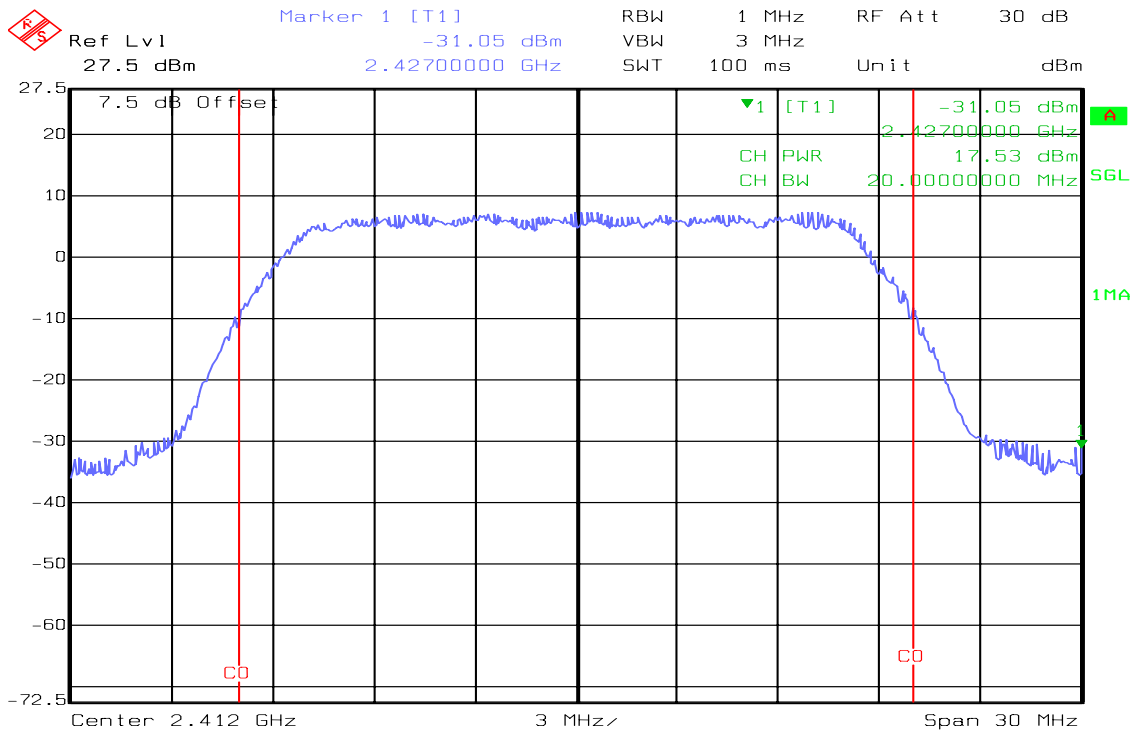

Date: 27.NOV.2009 11:21:43



Peak Power (CH Mid)

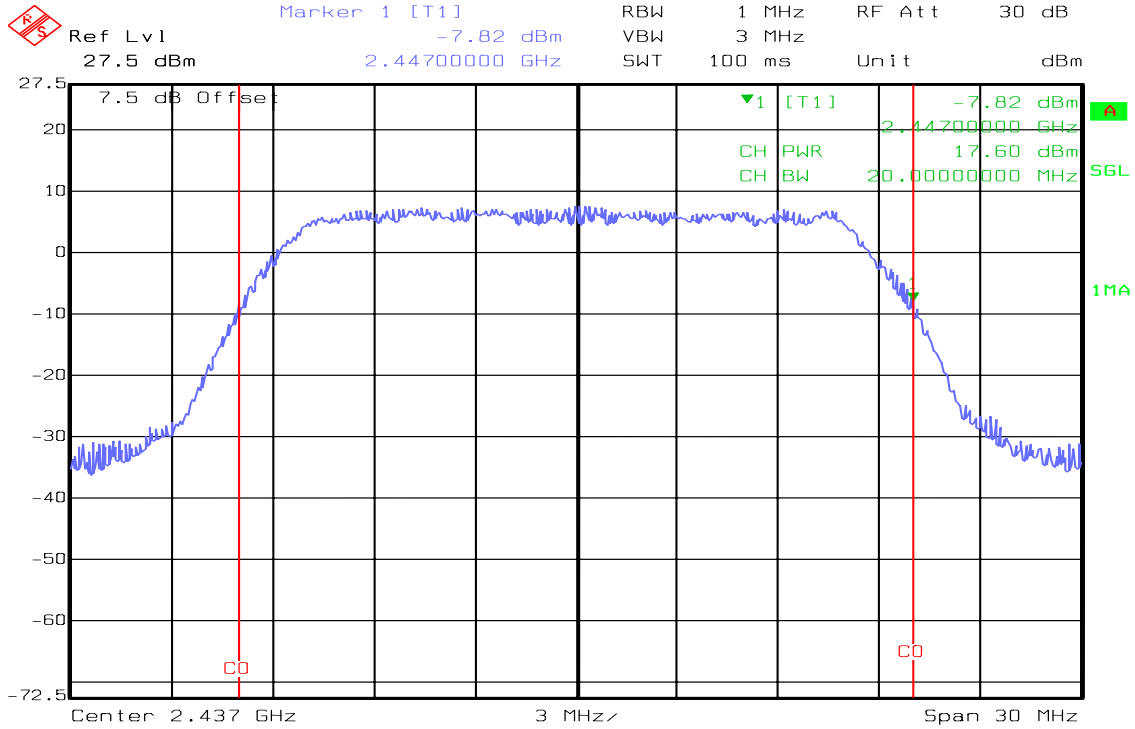

Date: 27.NOV.2009 11:16:38

Peak Power (CH High)

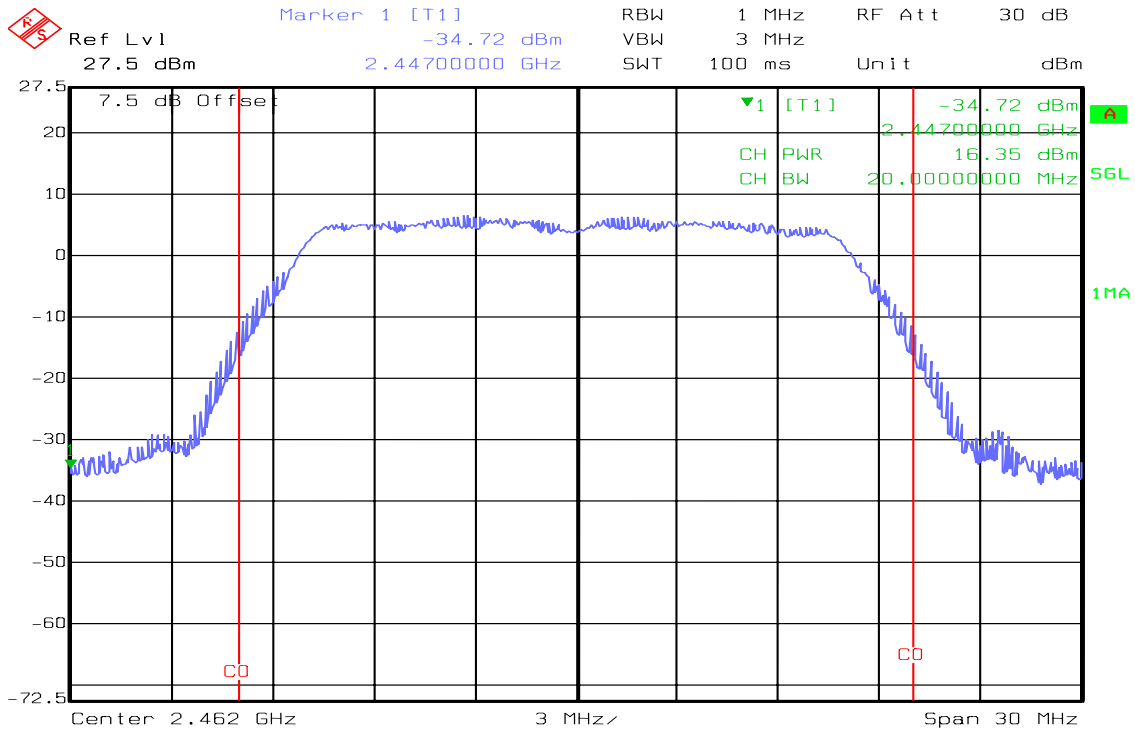

Date: 27.NOV.2009 11:15:34



draft 802.11n 20 MHz Channel mode

Peak Power (CH Low)

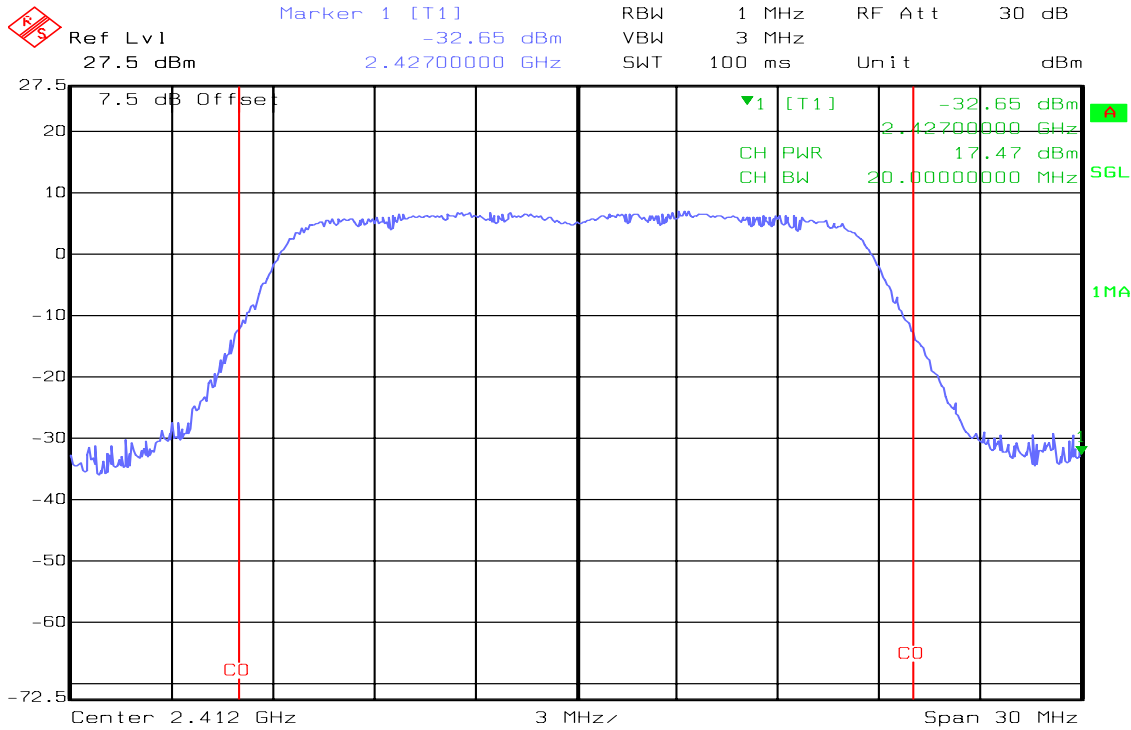

Date: 27.NOV.2009 11:23:51

Peak Power (CH Mid)

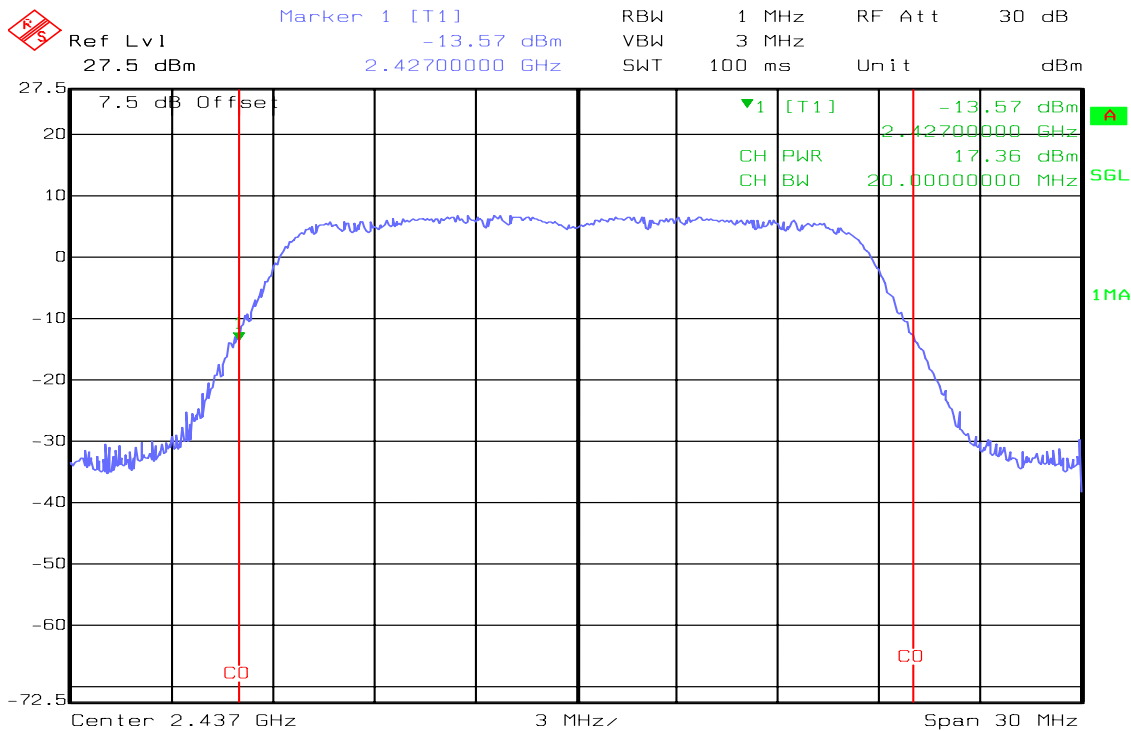

Date: 27.NOV.2009 11:27:41



Peak Power (CH High)

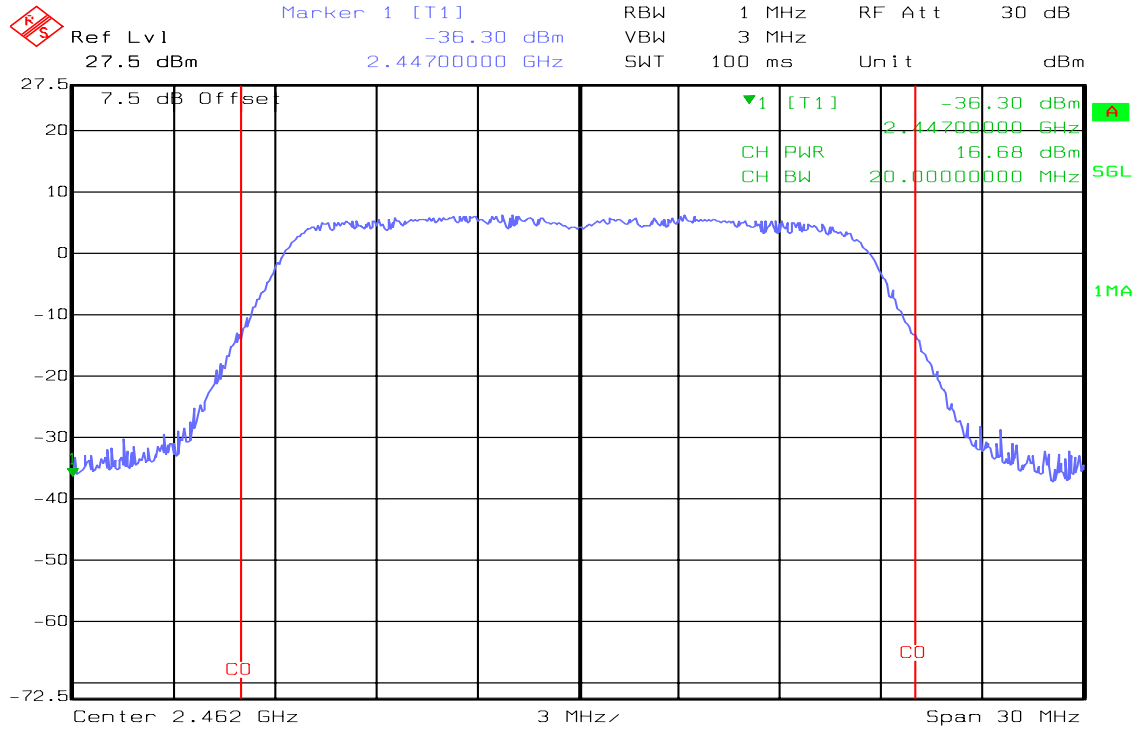

Date: 27.NOV.2009 11:29:13

draft 802.11n 40 MHz Channel mode

Peak Power (CH Low)

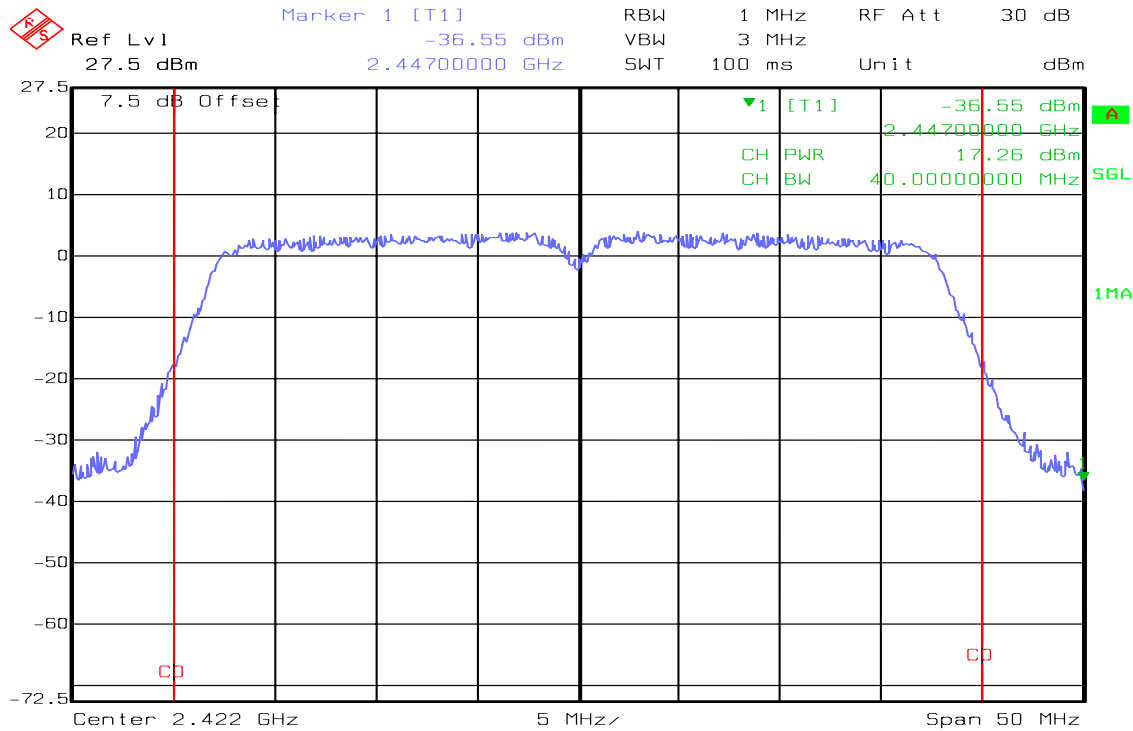

Date: 27.NOV.2009 11:46:12



Peak Power (CH Mid)

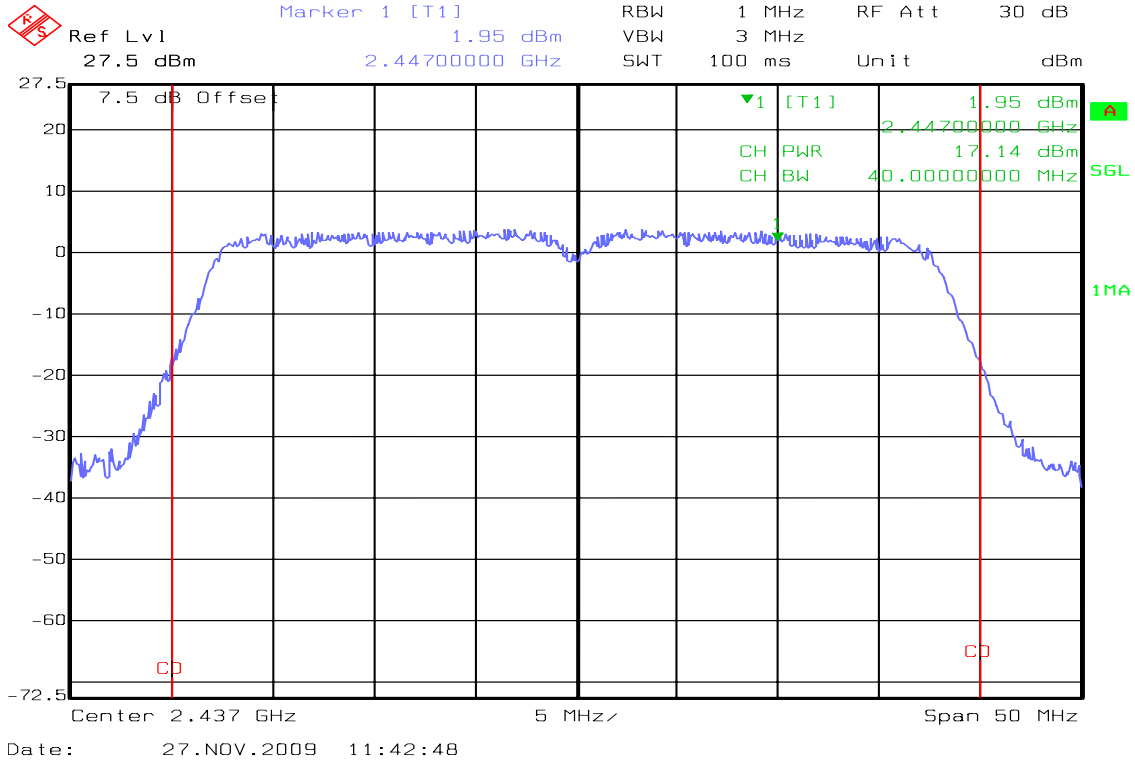

Peak Power (CH High)

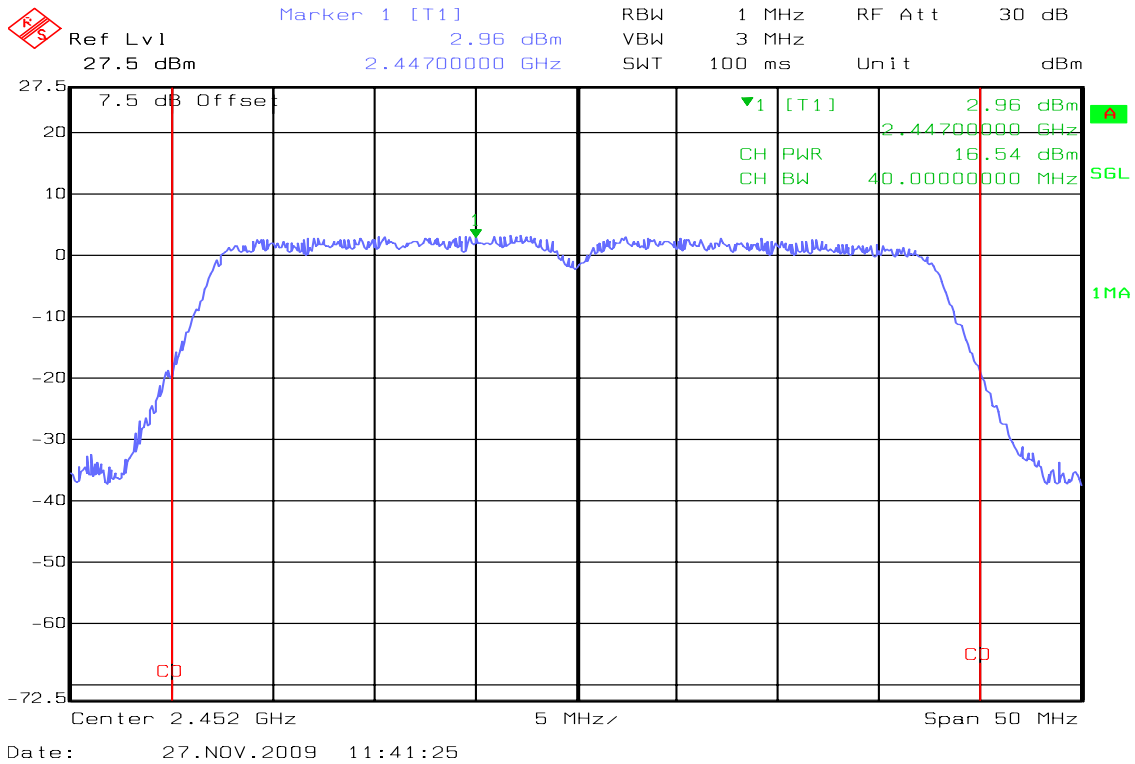



7.3 AVERAGE POWER

LIMIT

None; for reporting purposes only.

TEST CONFIGURATION

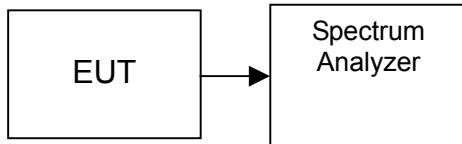

TEST PROCEDURE

The transmitter output is connected to the Spectrum Analyzer. The Spectrum Analyzer is set to the average power detection.

TEST RESULTS

No non-compliance noted



TEST DATA

Test mode: IEEE 802.11b mode

Channel	Frequency (MHz)	Output Power (dBm)	Output Power (W)
Low	2412	13.58	0.02280
Mid	2437	13.34	0.02158
High	2462	12.45	0.01758

Test mode: IEEE 802.11g mode

Channel	Frequency (MHz)	Output Power (dBm)	Output Power (W)
Low	2412	9.74	0.00942
Mid	2437	9.65	0.00923
High	2462	9.21	0.00834

Test mode: draft 802.11n 20 MHz Channel mode

Channel	Frequency (MHz)	Output Power (dBm)	Output Power (W)
Low	2412	9.91	0.00979
Mid	2437	10.07	0.01016
High	2462	9.32	0.00855

Test mode: draft 802.11n 40 MHz Channel mode

Channel	Frequency (MHz)	Output Power (dBm)	Output Power (W)
Low	2422	10.09	0.01021
Mid	2437	9.58	0.00908
High	2452	9.19	0.00830



Test Plot

IEEE 802.11b mode

Average power (CH Low)

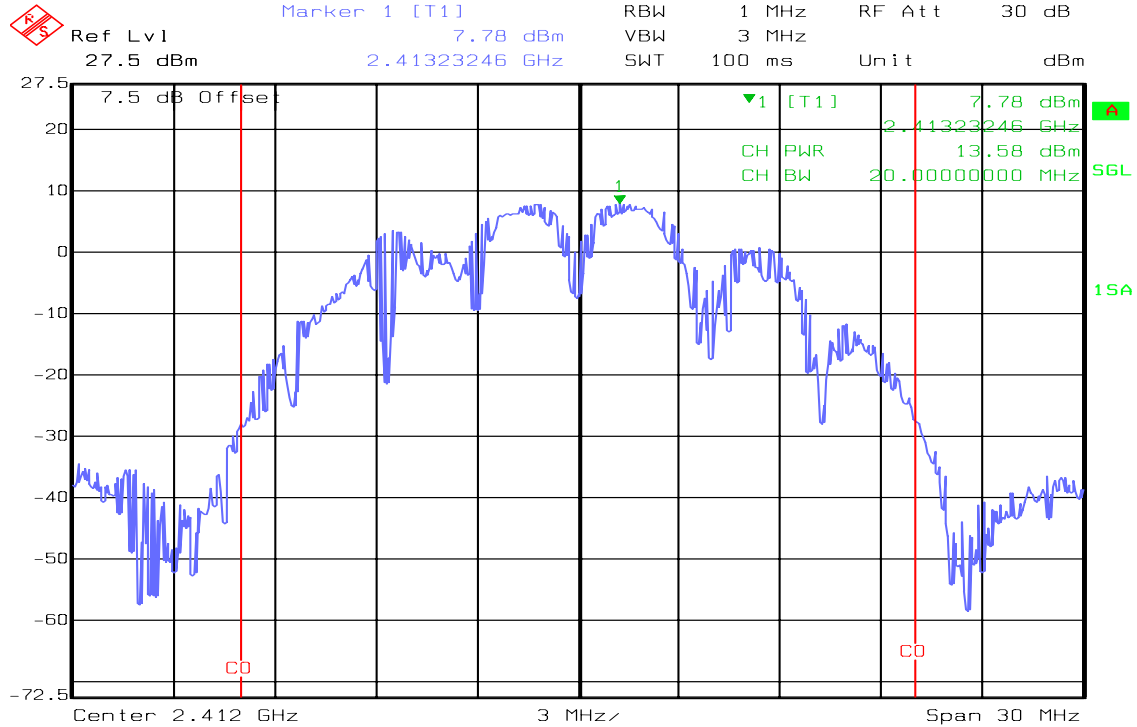

Date: 27.NOV.2009 11:00:45

Average power (CH Mid)

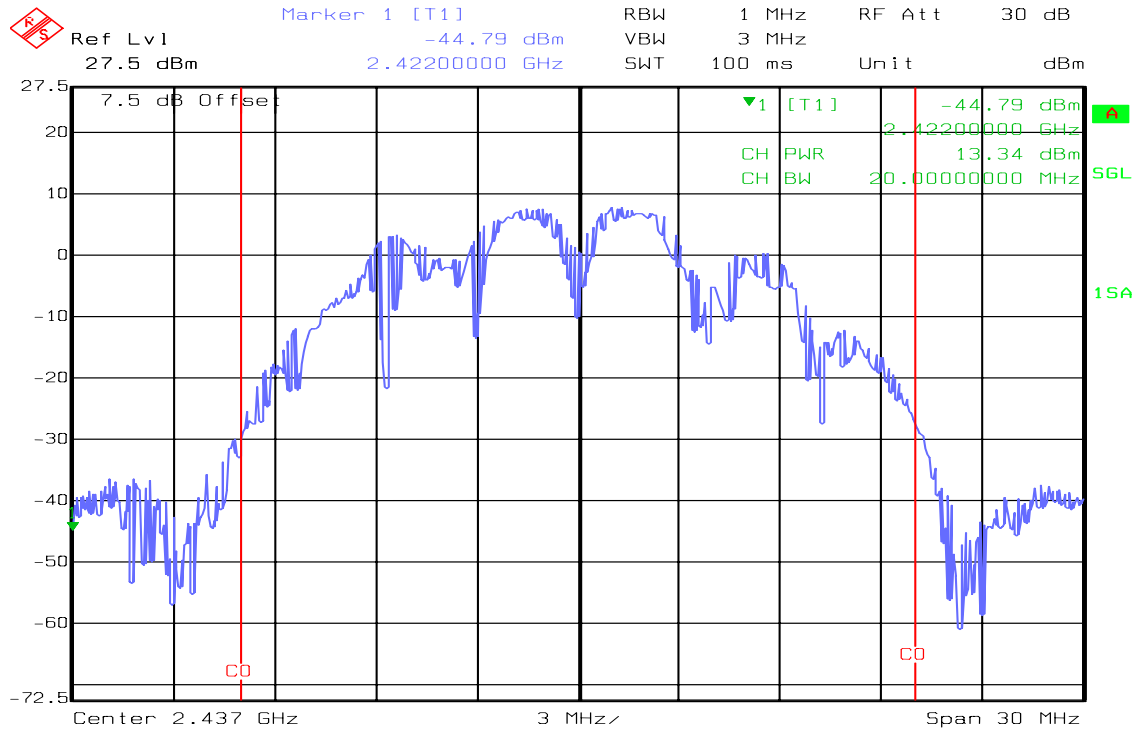

Date: 27.NOV.2009 10:59:35



Average power

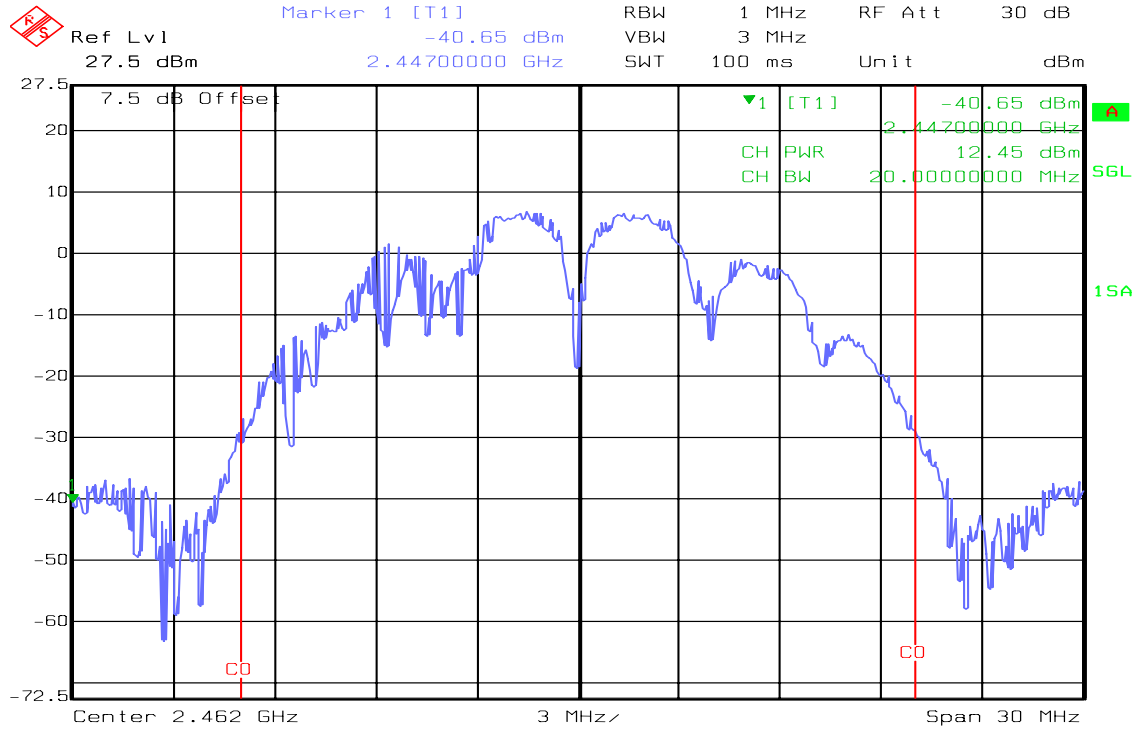

Date: 27.NOV.2009 11:13:20

IEEE 802.11g mode

Average power (CH Low)

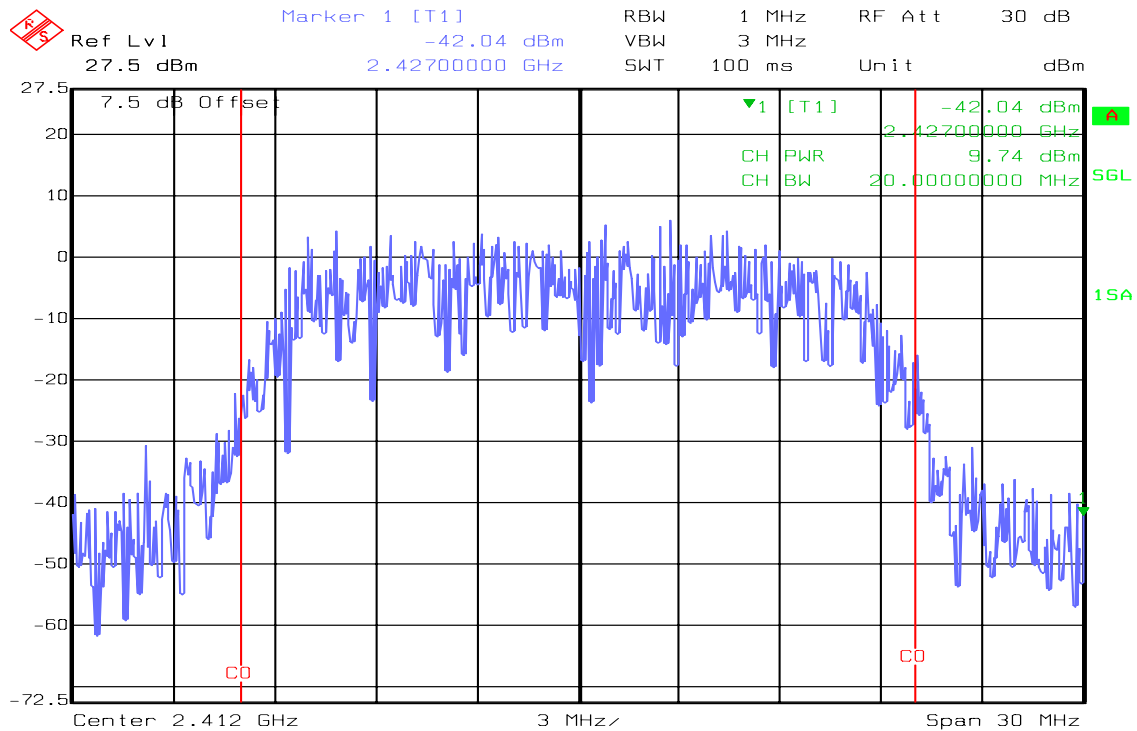

Date: 27.NOV.2009 11:18:54



Average power (CH Mid)

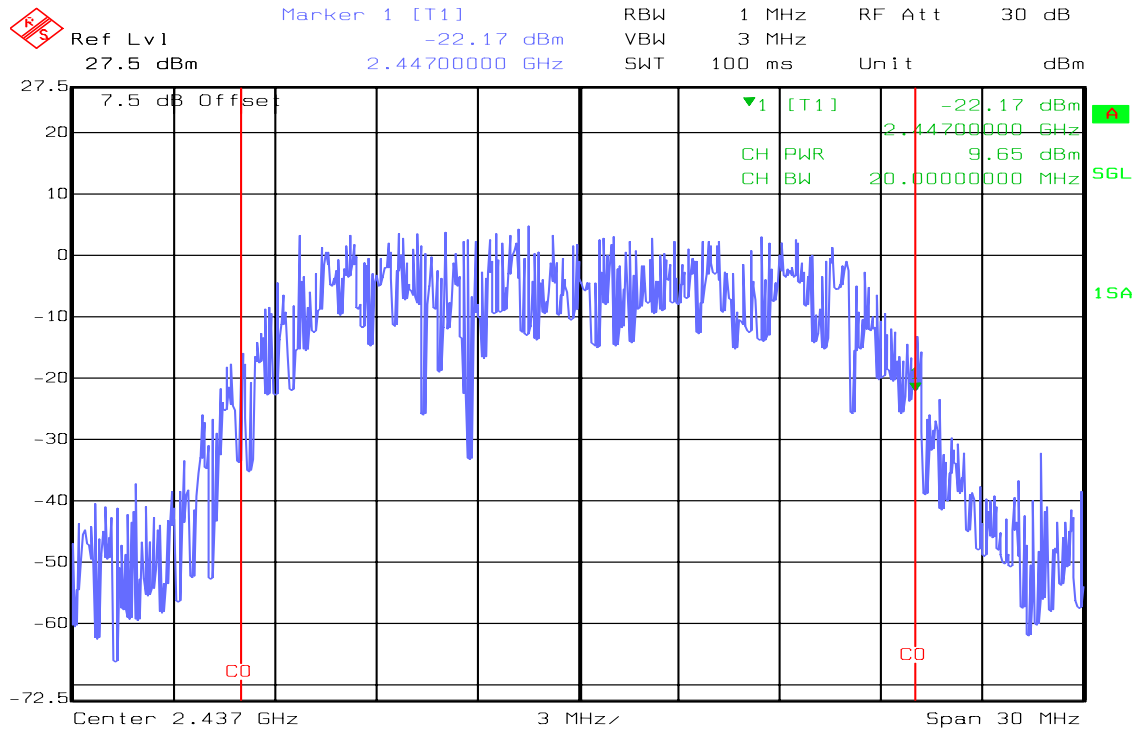

Date: 27.NOV.2009 11:17:38

Average power (CH High)

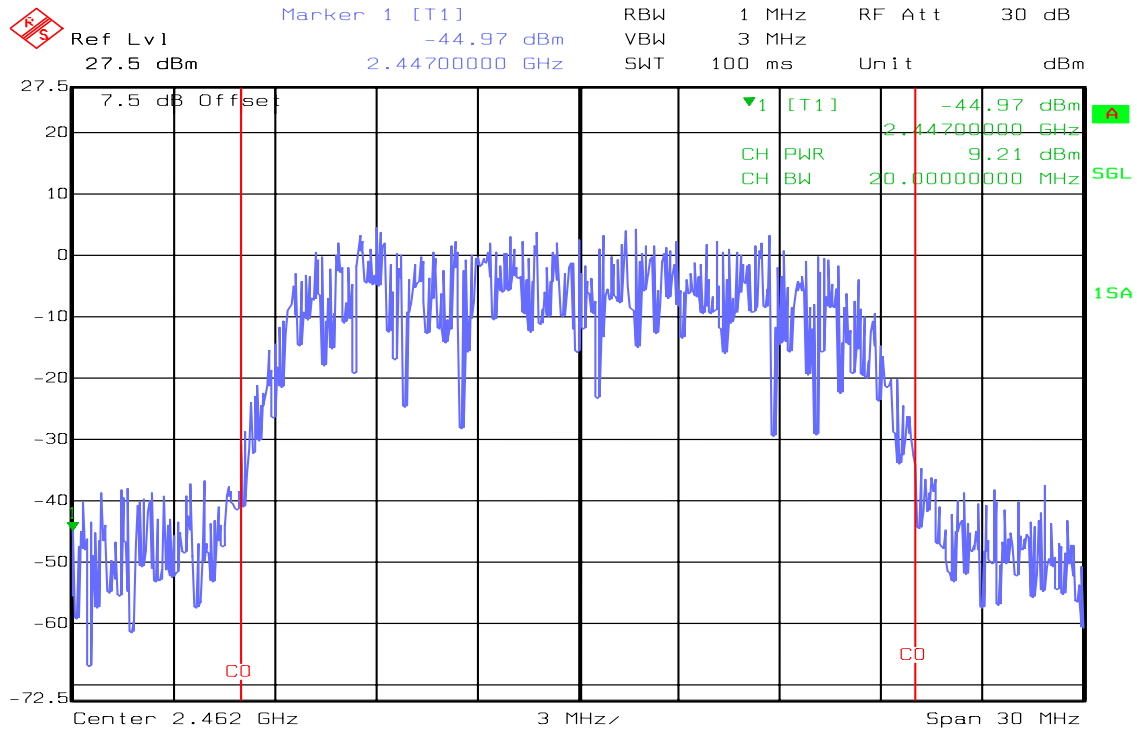

Date: 27.NOV.2009 11:14:47



draft 802.11n 20 MHz Channel mode

Average power (CH Low)

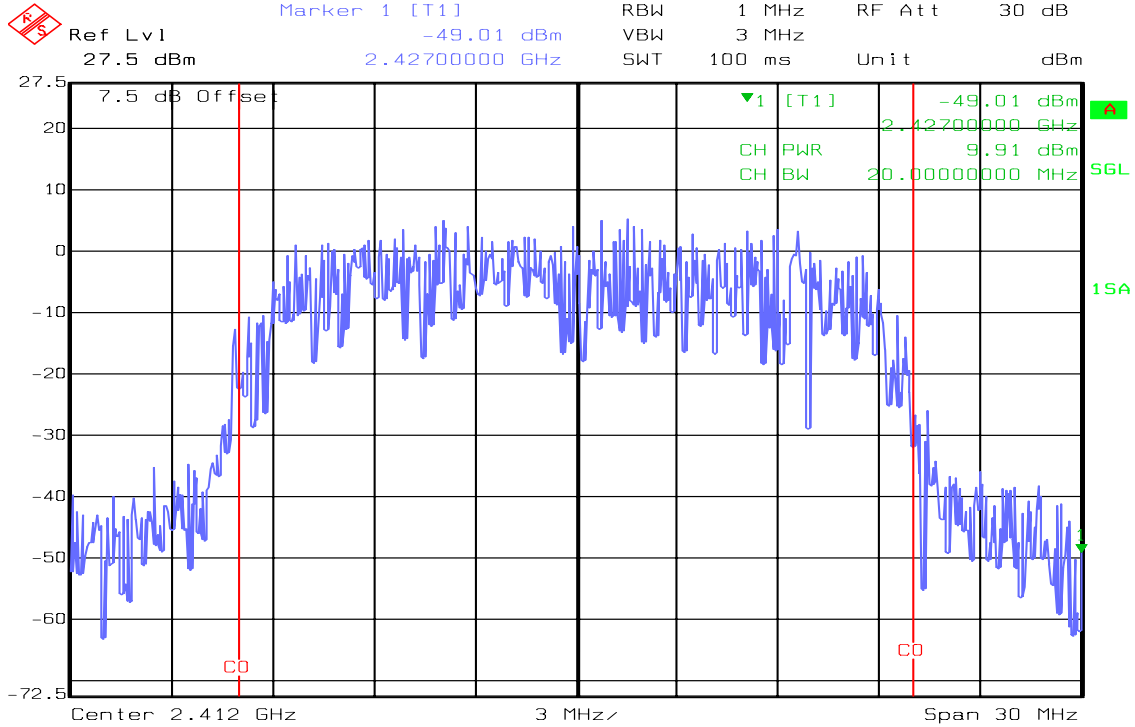

Date: 27.NOV.2009 11:25:07

Average power (CH Mid)

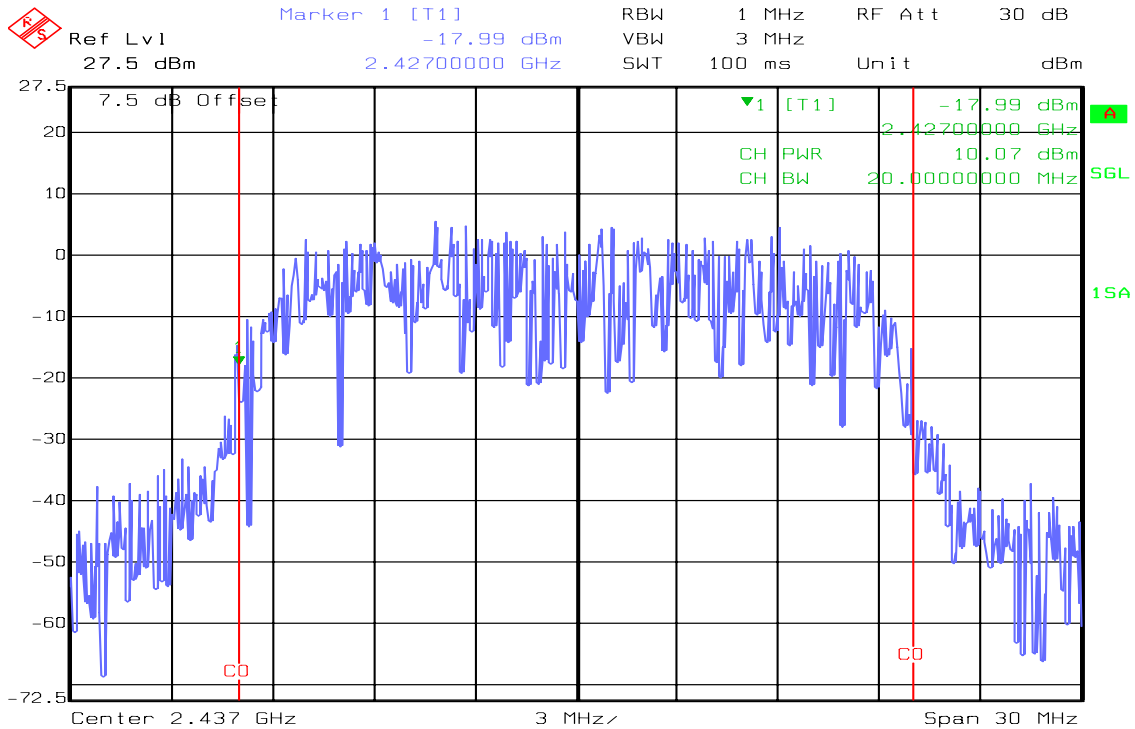

Date: 27.NOV.2009 11:26:56



Average power (CH High)

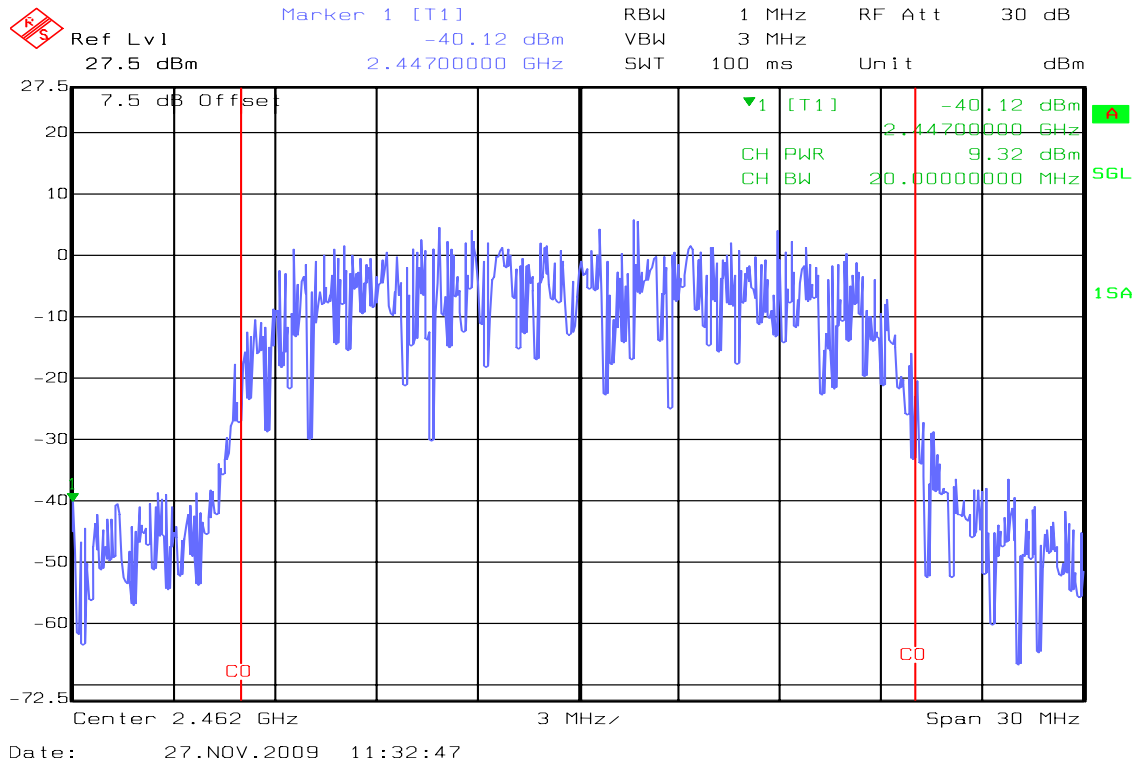

draft 802.11n 40 MHz Channel mode

Average power (CH Low)

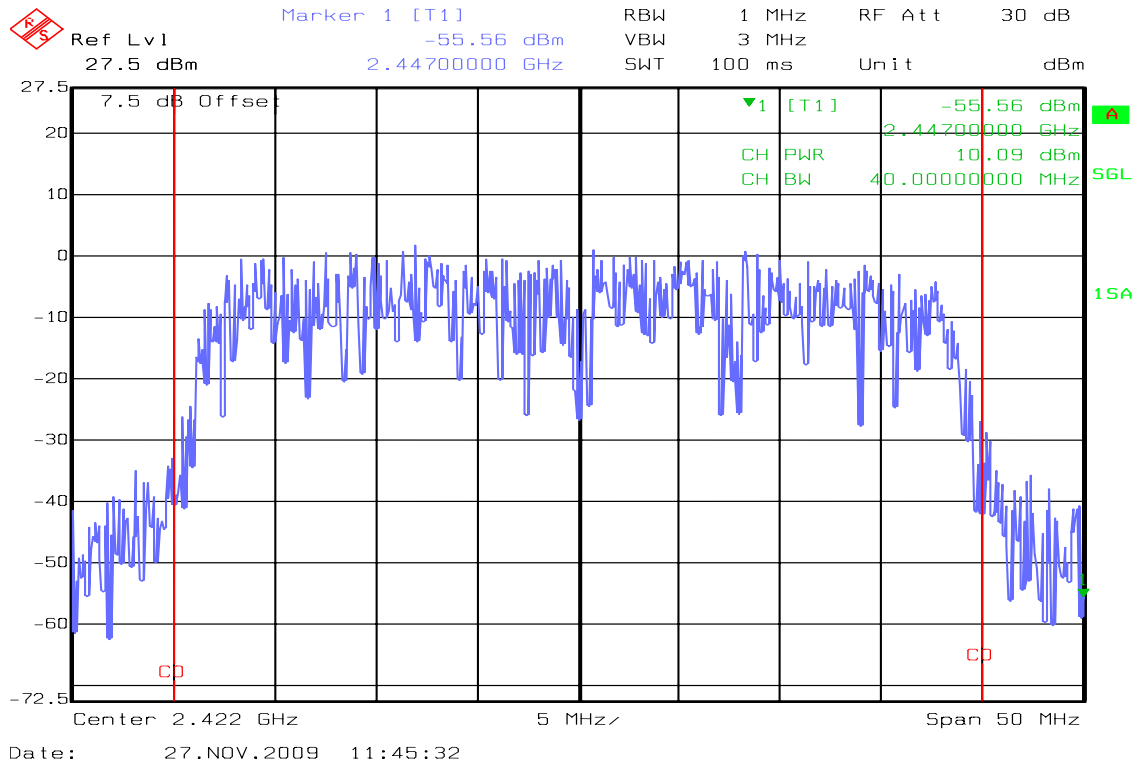



Average power (CH Mid)

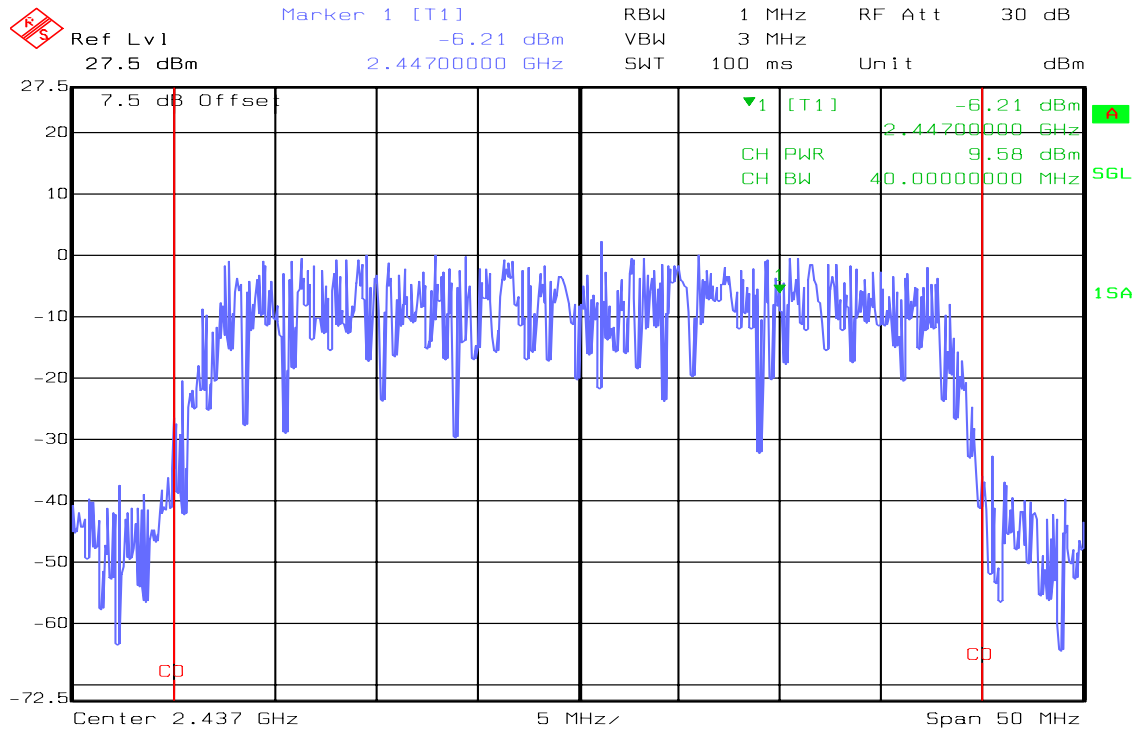

Date: 27.NOV.2009 11:43:48

Average power (CH High)

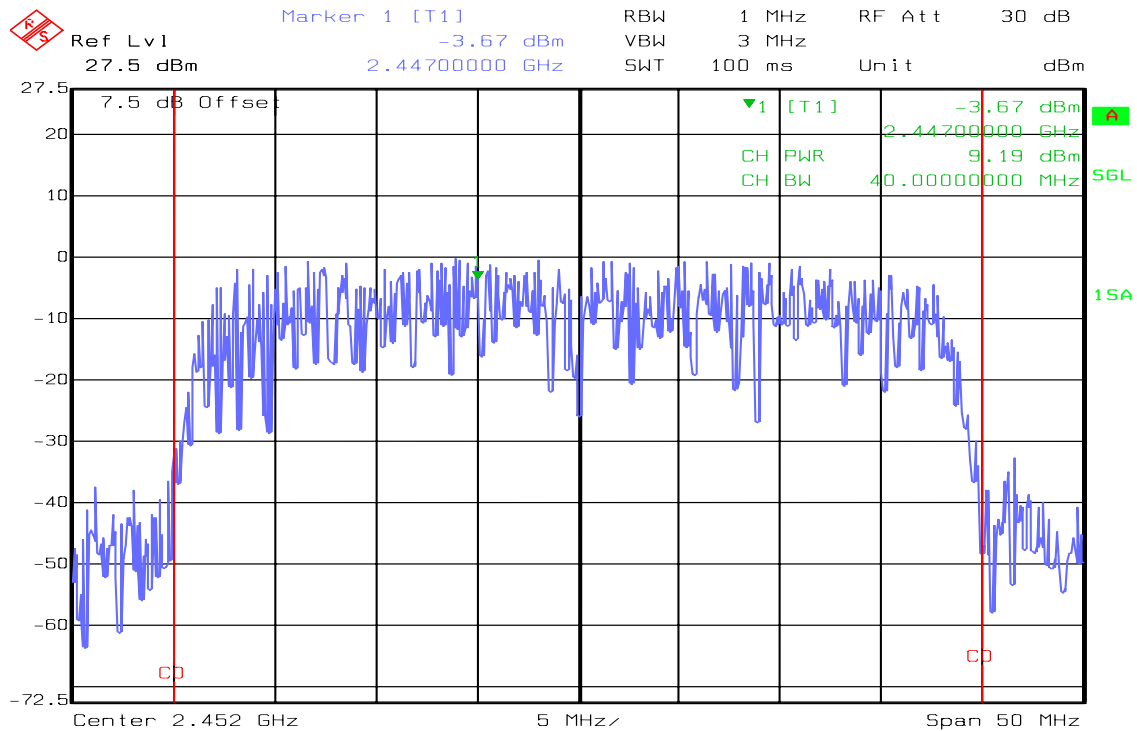

Date: 27.NOV.2009 11:40:44

7.4 BAND EDGES MEASUREMENT

LIMIT

According to §15.247(d), in any 100 kHz bandwidth outside the frequency bands in which the spread spectrum intentional radiator is operating, the radio frequency power that is produced by the intentional radiator shall be at least 20 dB below that in the 100 kHz bandwidth within the band that contains the highest level of the desired power, based on either an RF conducted or a radiated measurement, provided the transmitter demonstrates compliance with the peak conducted power limits. In addition, radiated emissions which fall in the restricted bands, as defined in §15.205(a), must also comply with the radiated emission limits specified in 15.209(a) (see Section 15.205(c)).

TEST CONFIGURATION

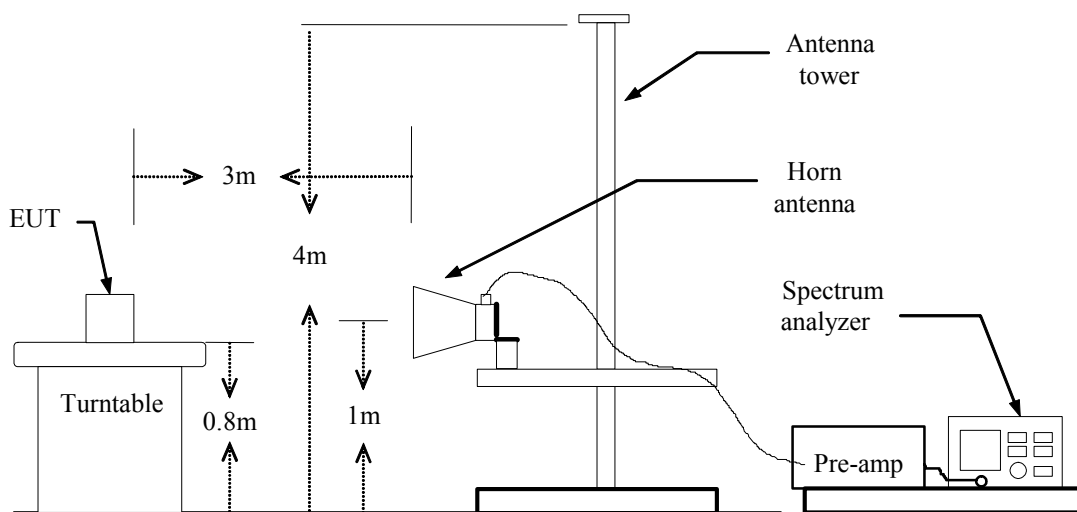

TEST PROCEDURE

1. The EUT is placed on a turntable, which is 0.8m above the ground plane.
2. The turntable shall be rotated for 360 degrees to determine the position of maximum emission level.
3. EUT is set 3m away from the receiving antenna, which is varied from 1m to 4m to find out the highest emission.
4. Set the spectrum analyzer in the following setting in order to capture the lower and upper band-edges of the emission:
 - (a) PEAK: RBW=VBW=1MHz / Sweep=AUTO
 - (b) AVERAGE: RBW=1MHz / VBW=10Hz / Sweep=AUTO
5. Repeat the procedures until all the PEAK and AVERAGE versus POLARIZATION are measured.

TEST RESULTS

Refer to attach spectrum analyzer data chart.



Test Plot

Band Edges (IEEE 802.11b mode / CH Low)

Detector mode: Peak

Polarity: Vertical

Agilent 12:21:37 Nov 23, 2009

R T

Mkr2 2.390 00 GHz
50.59 dB μ V

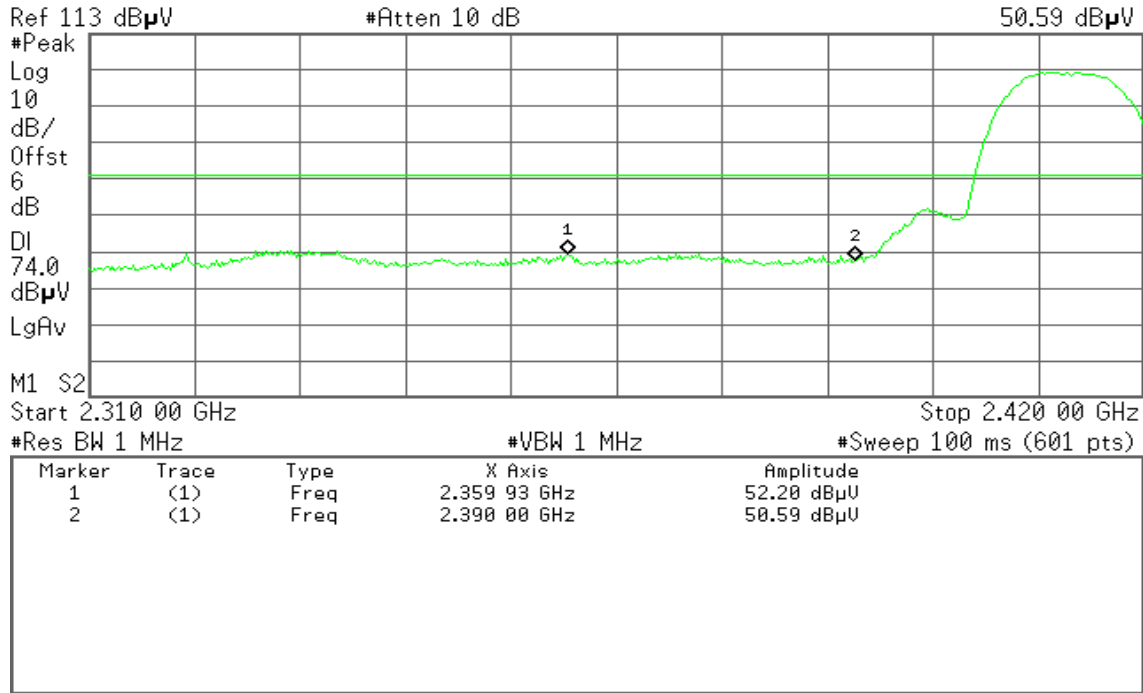

Detector mode: Average

Polarity: Vertical

Agilent 12:22:18 Nov 23, 2009

R T

Mkr2 2.390 00 GHz
38.50 dB μ V

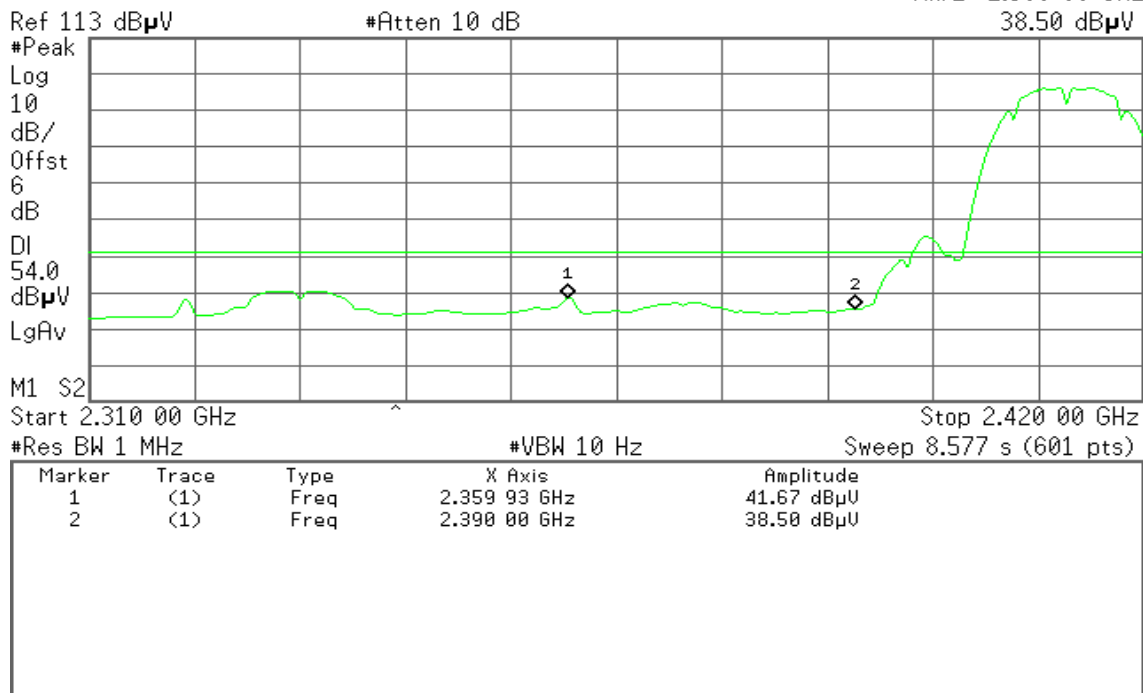



Detector mode: Peak

Polarity: Horizontal

Agilent 12:25:21 Nov 23, 2009

R T

Mkr2 2.390 00 GHz
46.24 dBµV

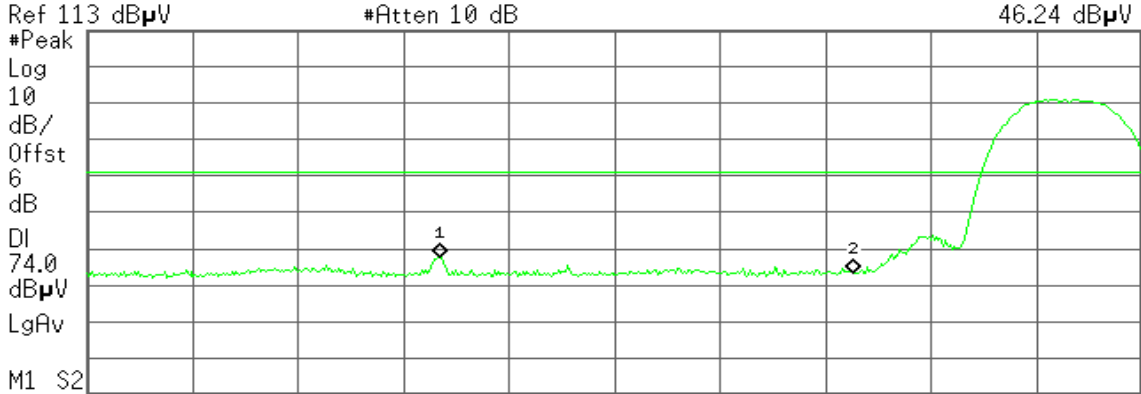

Start 2.310 00 GHz Stop 2.420 00 GHz
#Res BW 1 MHz #VBW 1 MHz #Sweep 100 ms (601 pts)

Marker	Trace	Type	X Axis	Amplitude
1	(1)	Freq	2.346 92 GHz	50.64 dBµU
2	(1)	Freq	2.390 00 GHz	46.24 dBµU

Detector mode: Average

Polarity: Horizontal

Agilent 16:08:26 Nov 23, 2009

R T

Mkr2 2.390 00 GHz
34.29 dBµV

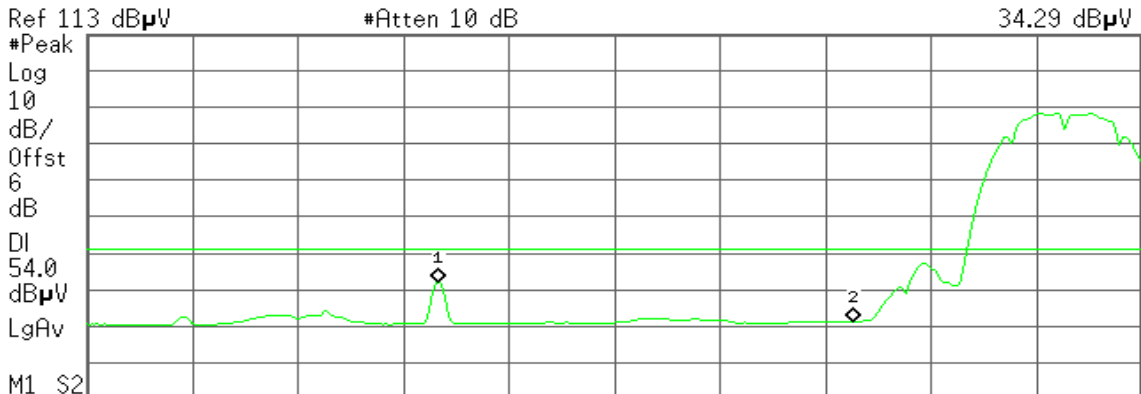

Start 2.310 00 GHz Stop 2.420 00 GHz
#Res BW 1 MHz #VBW 10 Hz Sweep 8.577 s (601 pts)

Marker	Trace	Type	X Axis	Amplitude
1	(1)	Freq	2.346 73 GHz	45.12 dBµU
2	(1)	Freq	2.390 00 GHz	34.29 dBµU



Band Edges (IEEE 802.11b mode / CH High)

Detector mode: Peak

Polarity: Vertical

Agilent 16:17:28 Nov 23, 2009

R T

Mkr1 2.483 50 GHz
49.73 dB μ V

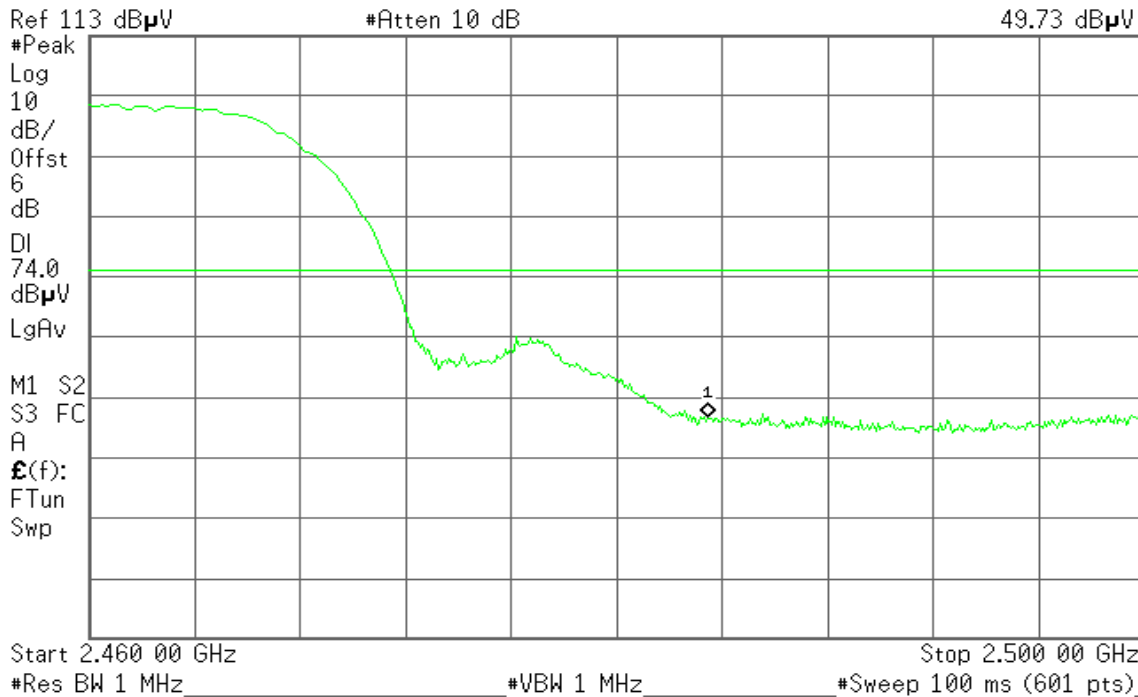

Detector mode: Average

Polarity: Vertical

Agilent 16:18:08 Nov 23, 2009

R T

Mkr1 2.483 50 GHz
37.48 dB μ V

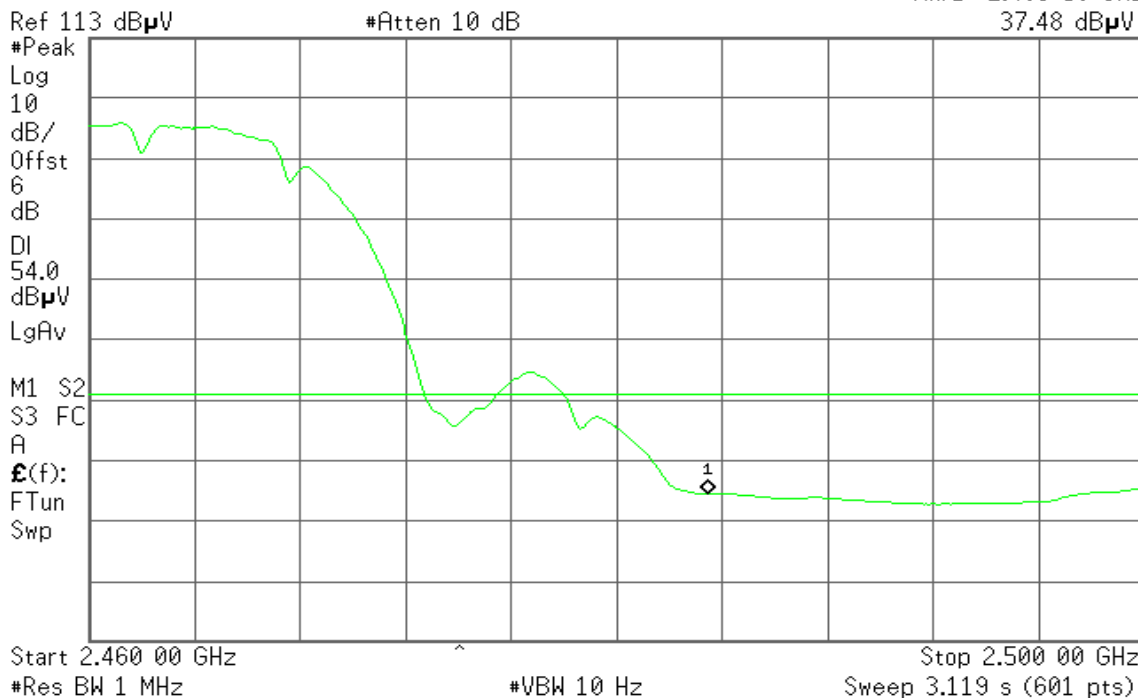



Detector mode: Peak

Polarity: Horizontal

Agilent 16:13:47 Nov 23, 2009

R T

Mkr1 2.483 50 GHz
47.44 dB μ V

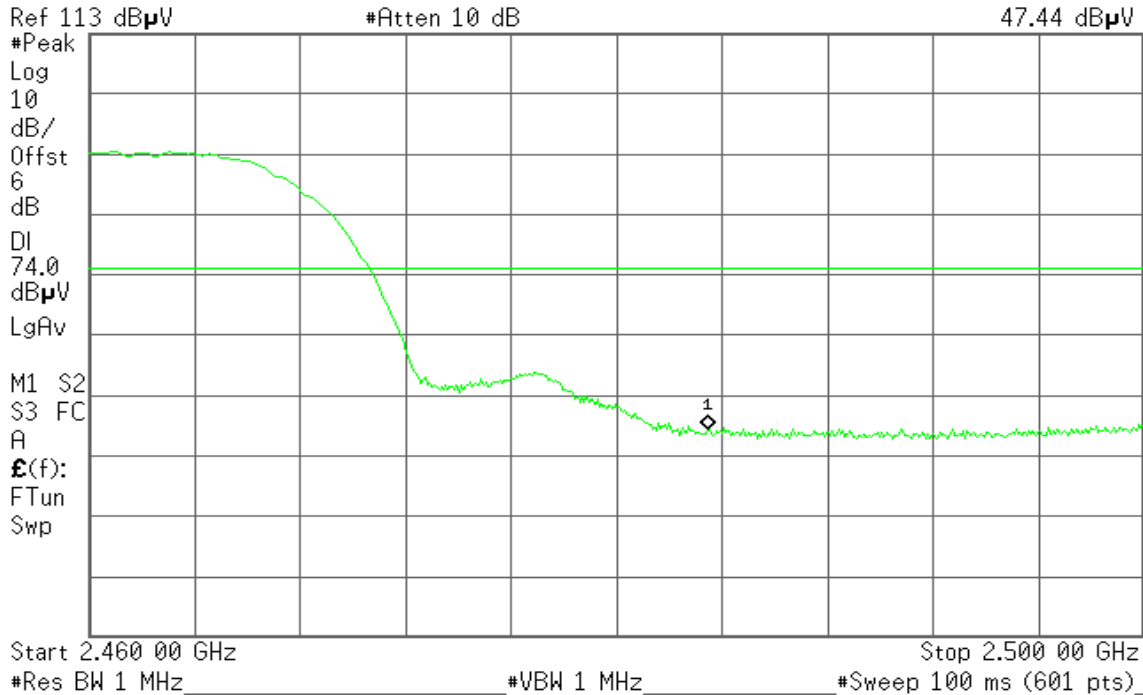

Detector mode: Average

Polarity: Horizontal

Agilent 16:14:17 Nov 23, 2009

R T

Mkr1 2.483 50 GHz
34.20 dB μ V

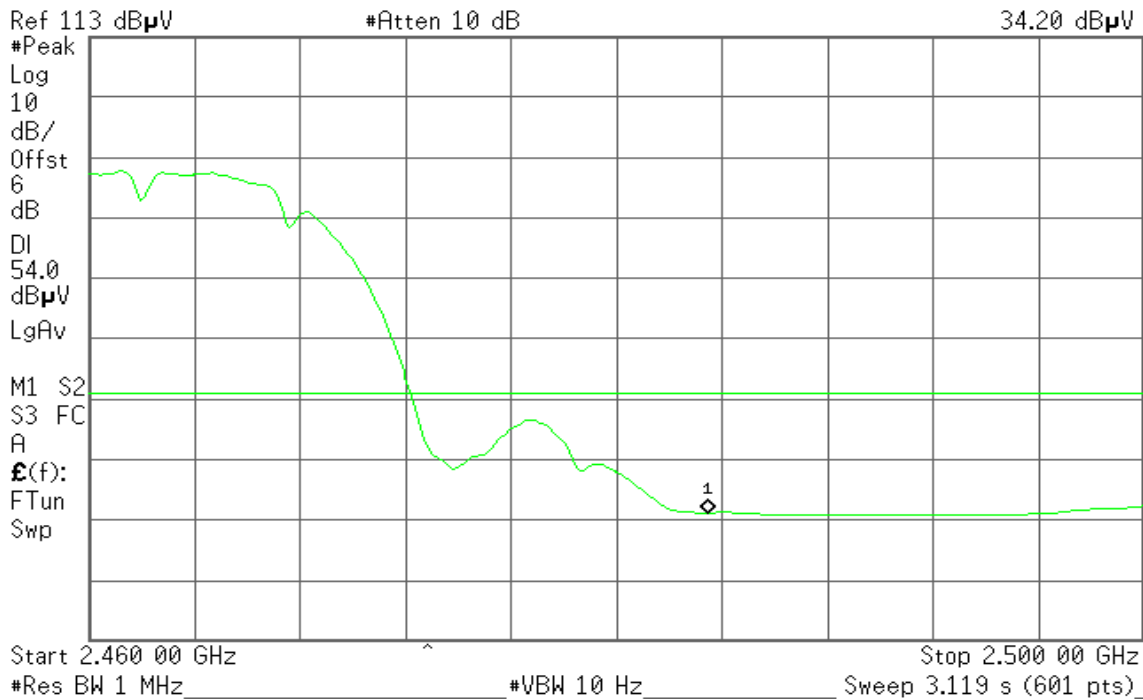



Band Edges (IEEE 802.11g mode / CH Low)

Detector mode: Peak

Polarity: Vertical

Agilent 12:17:22 Nov 23, 2009

R T

Mkr2 2.390 00 GHz
55.56 dB μ V

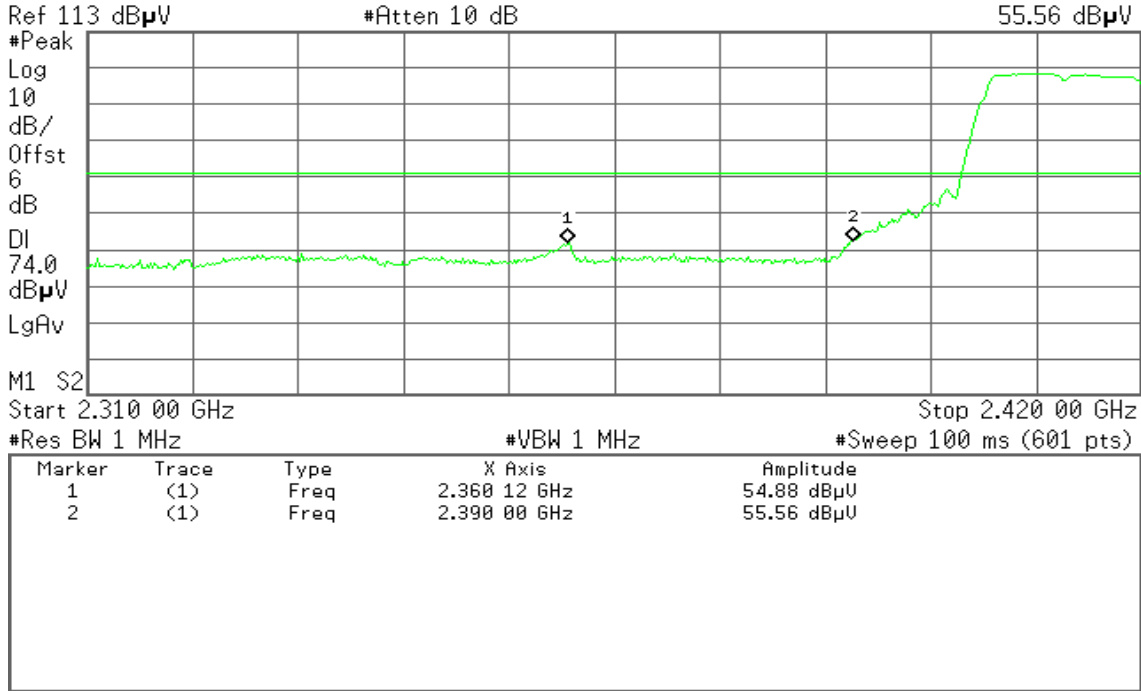

Detector mode: Average

Polarity: Vertical

Agilent 12:18:11 Nov 23, 2009

R T

Mkr2 2.390 00 GHz
39.78 dB μ V

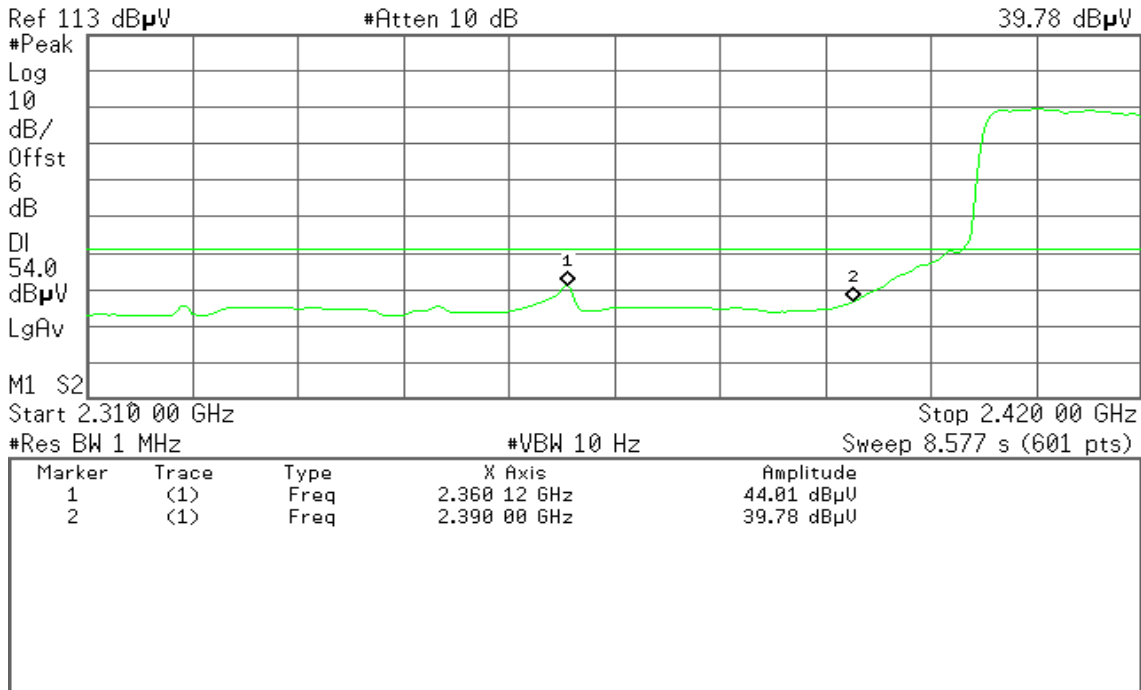



Detector mode: Peak

Polarity: Horizontal

Agilent 10:54:57 Nov 23, 2009

R T

Mkr2 2.390 00 GHz
48.13 dBµV

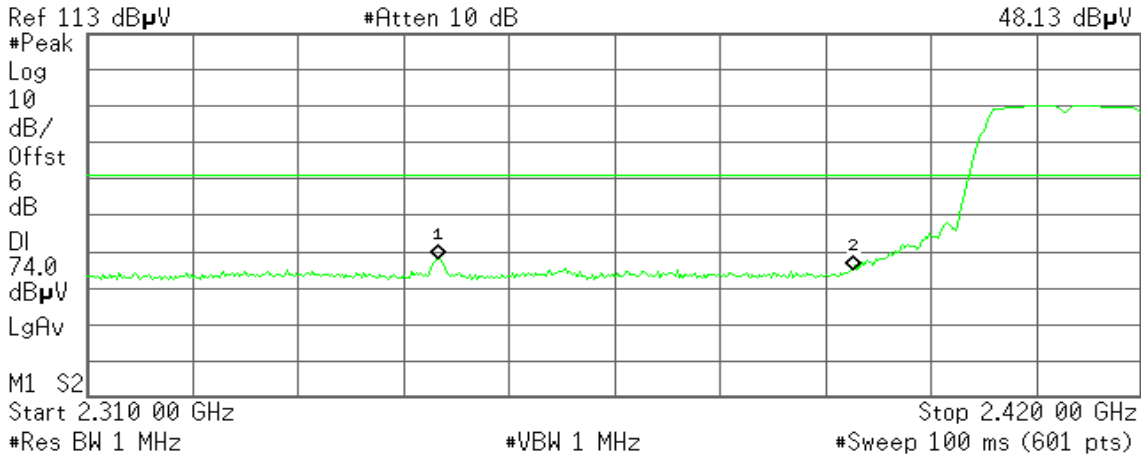

Marker	Trace	Type	X Axis	Amplitude
1	(1)	Freq	2.346 73 GHz	51.27 dBµU
2	(1)	Freq	2.390 00 GHz	48.13 dBµU

Detector mode: Average

Polarity: Horizontal

Agilent 11:46:58 Nov 23, 2009

R T

Mkr2 2.390 00 GHz
36.73 dBµV

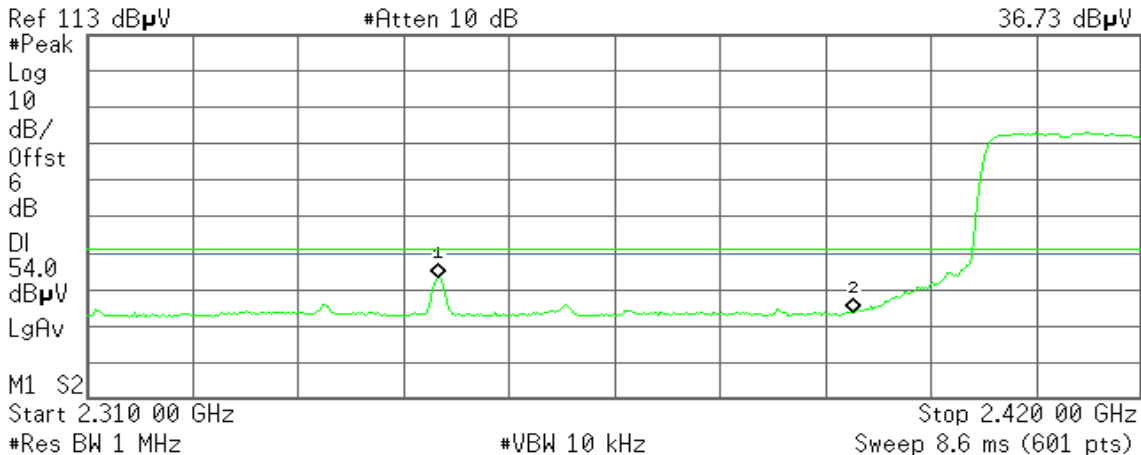

Marker	Trace	Type	X Axis	Amplitude
1	(1)	Freq	2.346 73 GHz	46.38 dBµU
2	(1)	Freq	2.390 00 GHz	36.73 dBµU



Band Edges (IEEE 802.11g mode / CH High)

Detector mode: Peak

Polarity: Vertical

Agilent 16:21:59 Nov 23, 2009

R T

Mkr1 2.483 50 GHz
55.11 dBμV

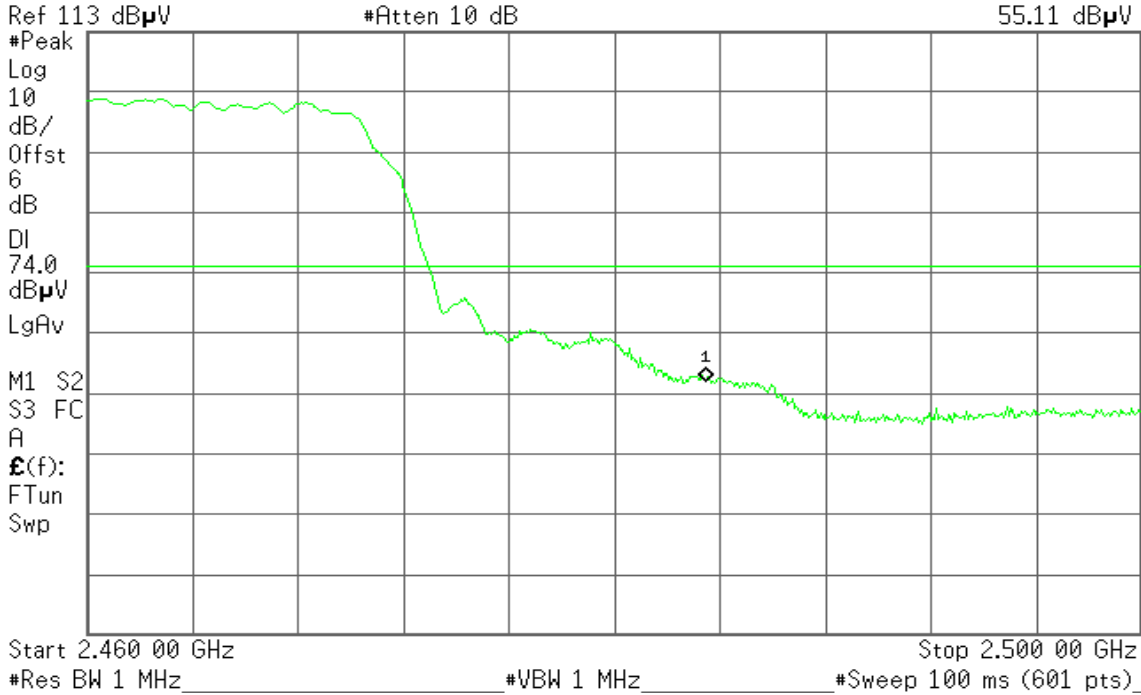

Detector mode: Average

Polarity: Vertical

Agilent 16:22:35 Nov 23, 2009

R T

Mkr1 2.483 50 GHz
39.79 dBμV

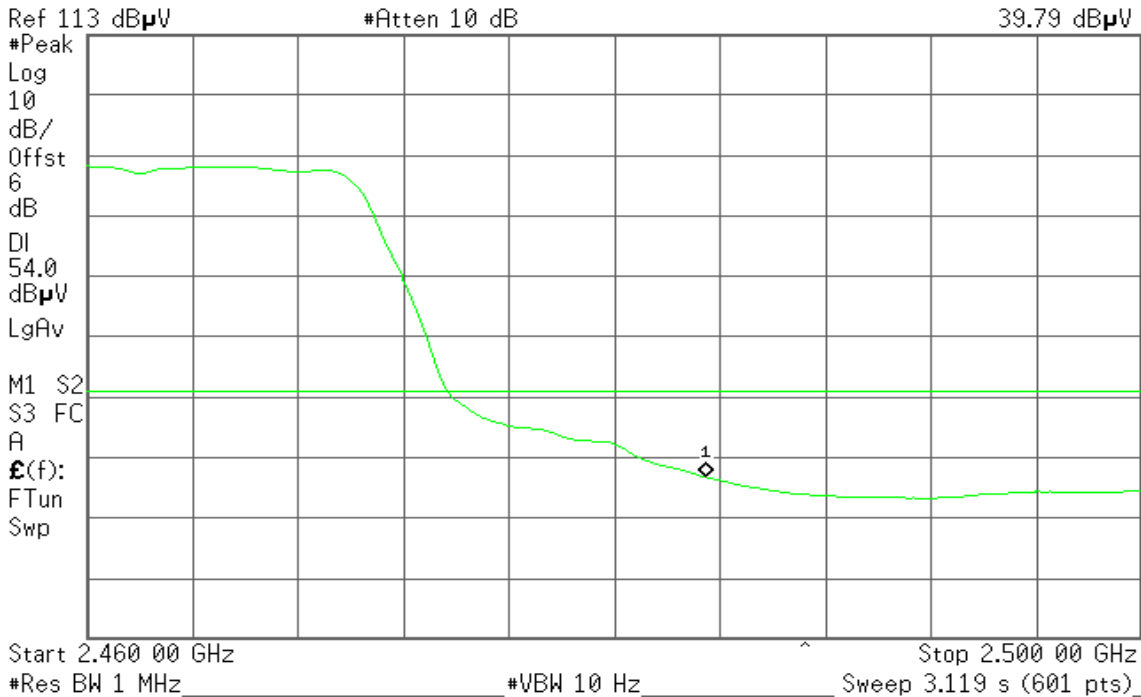



Detector mode: Peak

Polarity: Horizontal

Agilent 16:24:51 Nov 23, 2009

R T

Mkr1 2.483 50 GHz
48.07 dBµV

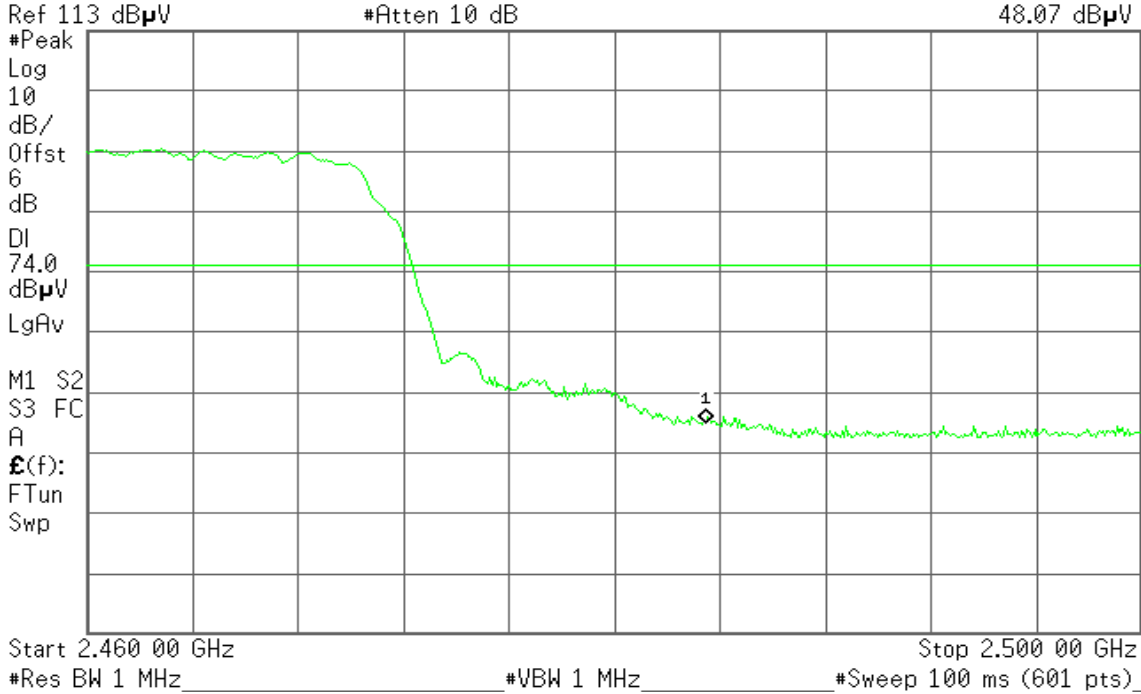

Detector mode: Average

Polarity: Horizontal

Agilent 16:25:27 Nov 23, 2009

R T

Mkr1 2.483 50 GHz
34.62 dBµV

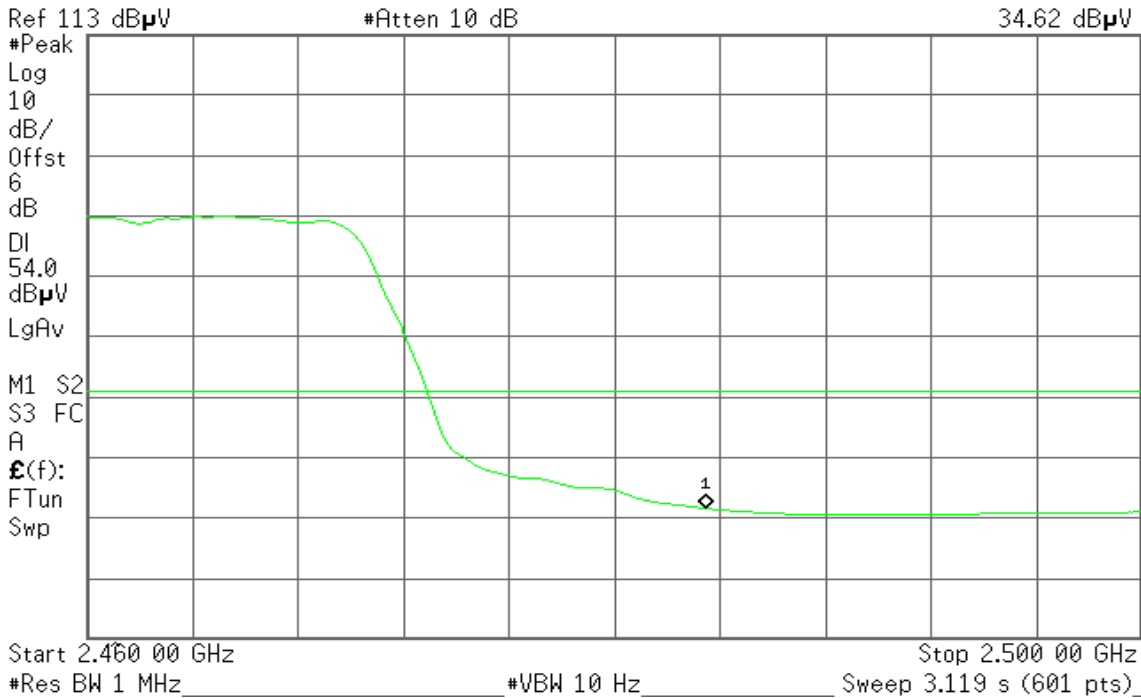



Band Edges (draft 802.11n 20 MHz Channel mode / CH Low)

Detector mode: Peak

Polarity: Vertical

Agilent 10:43:15 Nov 23, 2009

R T

Mkr2 2.390 00 GHz
61.91 dBµV

Ref 113 dBµV

#Atten 10 dB

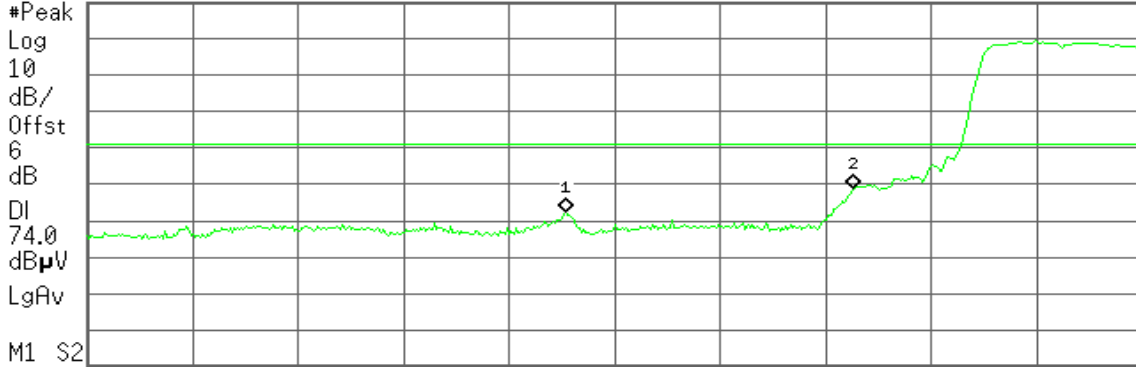

Start 2.310 00 GHz

Stop 2.420 00 GHz

#Res BW 1 MHz

#VBW 1 MHz

#Sweep 100 ms (601 pts)

Marker	Trace	Type	X Axis	Amplitude
1	(1)	Freq	2.359 93 GHz	55.32 dBµU
2	(1)	Freq	2.390 00 GHz	61.91 dBµU

Detector mode: Average

Polarity: Vertical

Agilent 10:44:04 Nov 23, 2009

R T

Mkr2 2.390 00 GHz
42.00 dBµV

Ref 113 dBµV

#Atten 10 dB

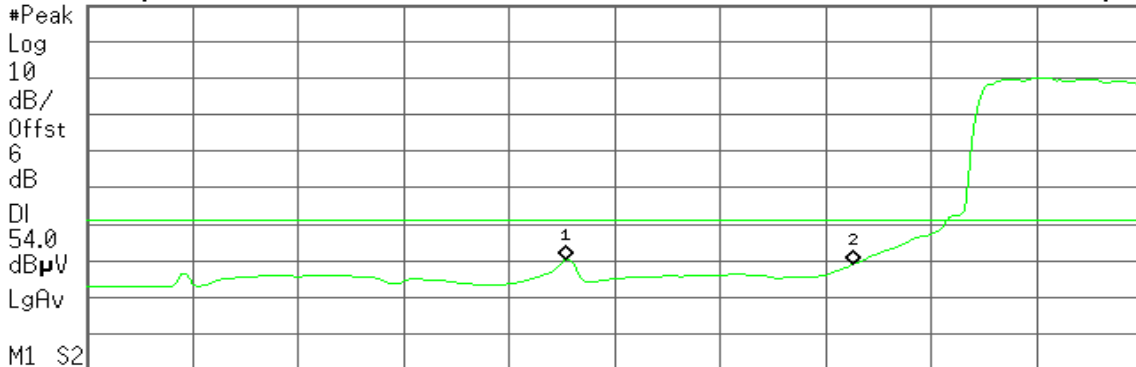

Start 2.310 00 GHz

Stop 2.420 00 GHz

#Res BW 1 MHz

#VBW 10 Hz

Sweep 8.577 s (601 pts)

Marker	Trace	Type	X Axis	Amplitude
1	(1)	Freq	2.359 93 GHz	43.44 dBµU
2	(1)	Freq	2.390 00 GHz	42.00 dBµU



Detector mode: Peak

Polarity: Horizontal

Agilent 10:49:19 Nov 23, 2009

R T

Mkr2 2.390 00 GHz
51.92 dBµV

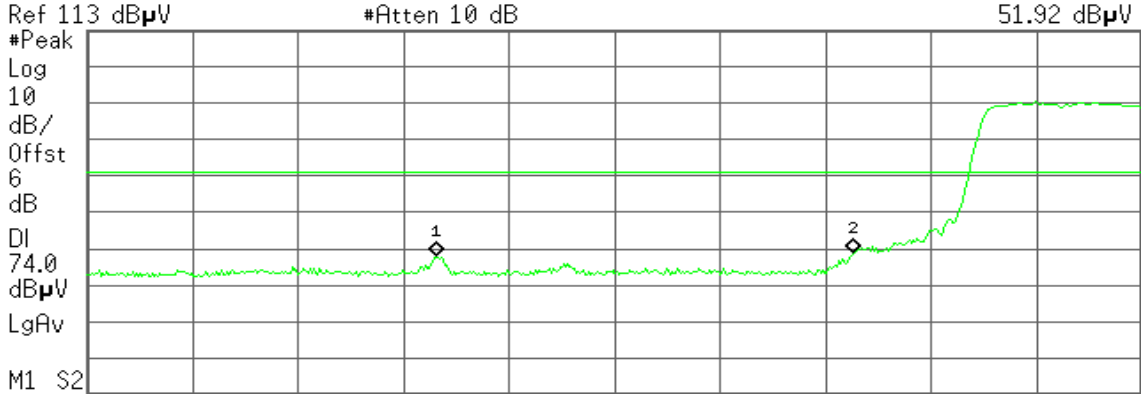

Start 2.310 00 GHz Stop 2.420 00 GHz
#Res BW 1 MHz #VBW 1 MHz #Sweep 100 ms (601 pts)

Marker	Trace	Type	X Axis	Amplitude
1	(1)	Freq	2.346 55 GHz	50.87 dBµU
2	(1)	Freq	2.390 00 GHz	51.92 dBµU

Detector mode: Average

Polarity: Horizontal

Agilent 10:51:06 Nov 23, 2009

R T

Mkr2 2.390 00 GHz
35.20 dBµV

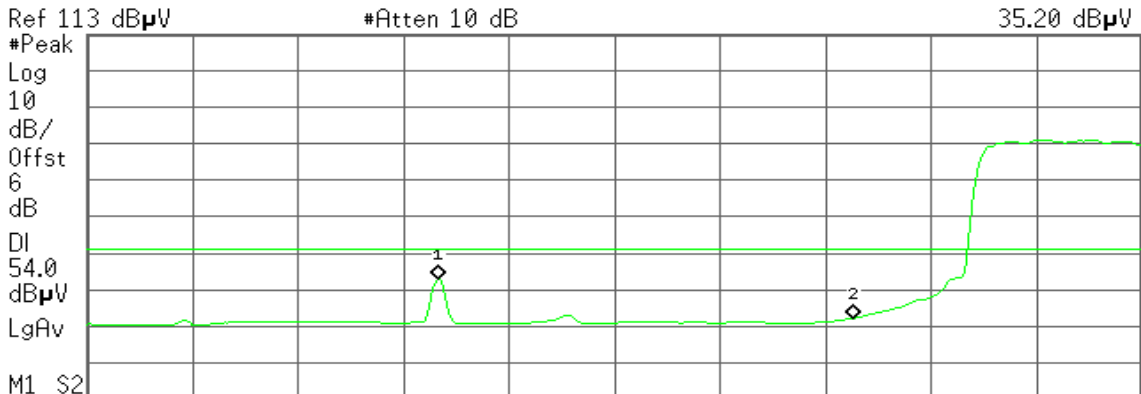

Start 2.310 00 GHz Stop 2.420 00 GHz
#Res BW 1 MHz #VBW 10 Hz Sweep 8.577 s (601 pts)

Marker	Trace	Type	X Axis	Amplitude
1	(1)	Freq	2.346 73 GHz	45.77 dBµU
2	(1)	Freq	2.390 00 GHz	35.20 dBµU



Band Edges (draft 802.11n 20 MHz Channel mode / CH High)

Detector mode: Peak

Polarity: Vertical

Agilent 16:33:19 Nov 23, 2009

R T

Mkr1 2.483 50 GHz
57.18 dBμV

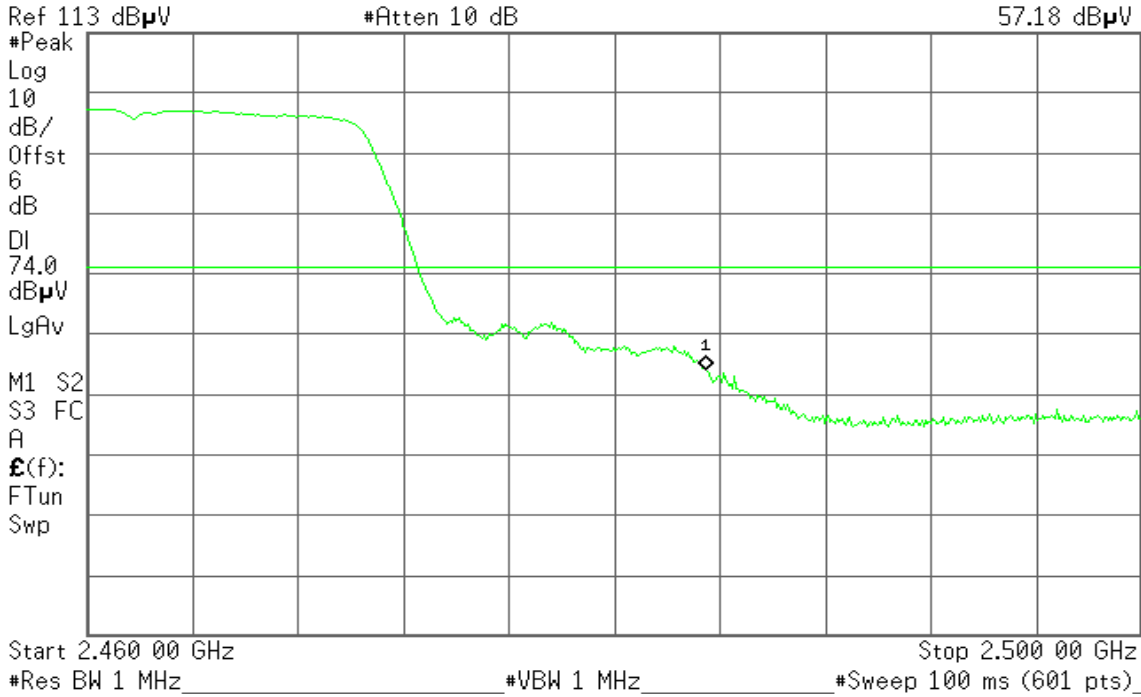

Detector mode: Average

Polarity: Vertical

Agilent 16:30:42 Nov 23, 2009

R T

Mkr1 2.483 50 GHz
34.90 dBμV

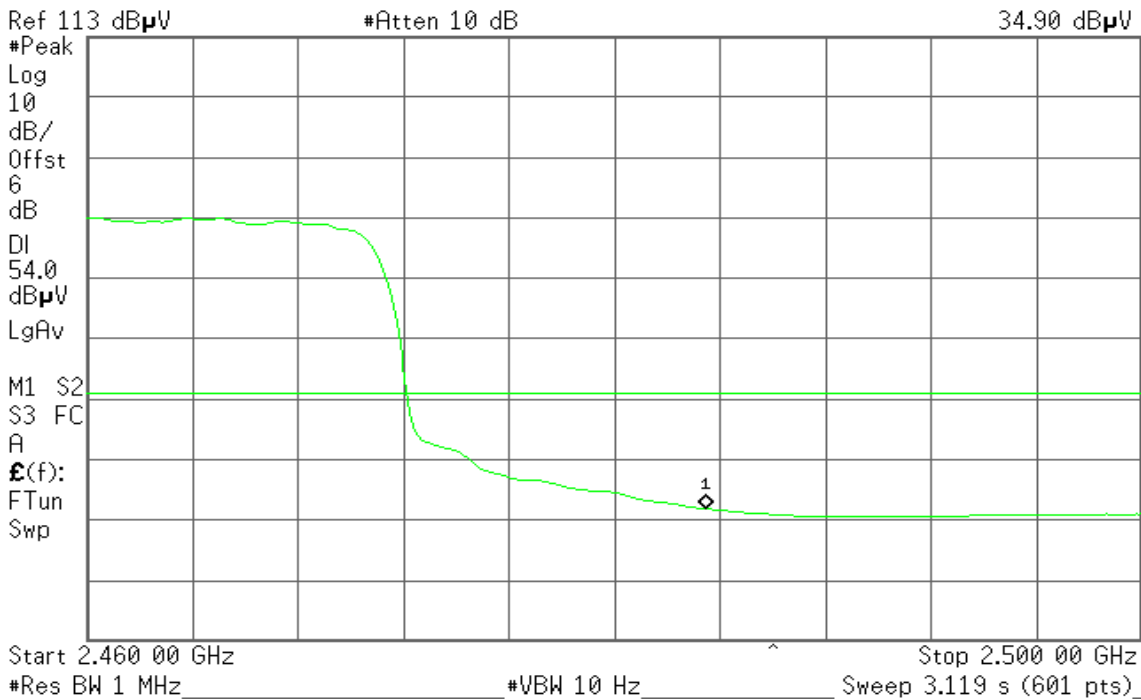



Detector mode: Peak

Polarity: Horizontal

Agilent 16:30:02 Nov 23, 2009

R T

Mkr1 2.483 50 GHz
50.27 dB μ V

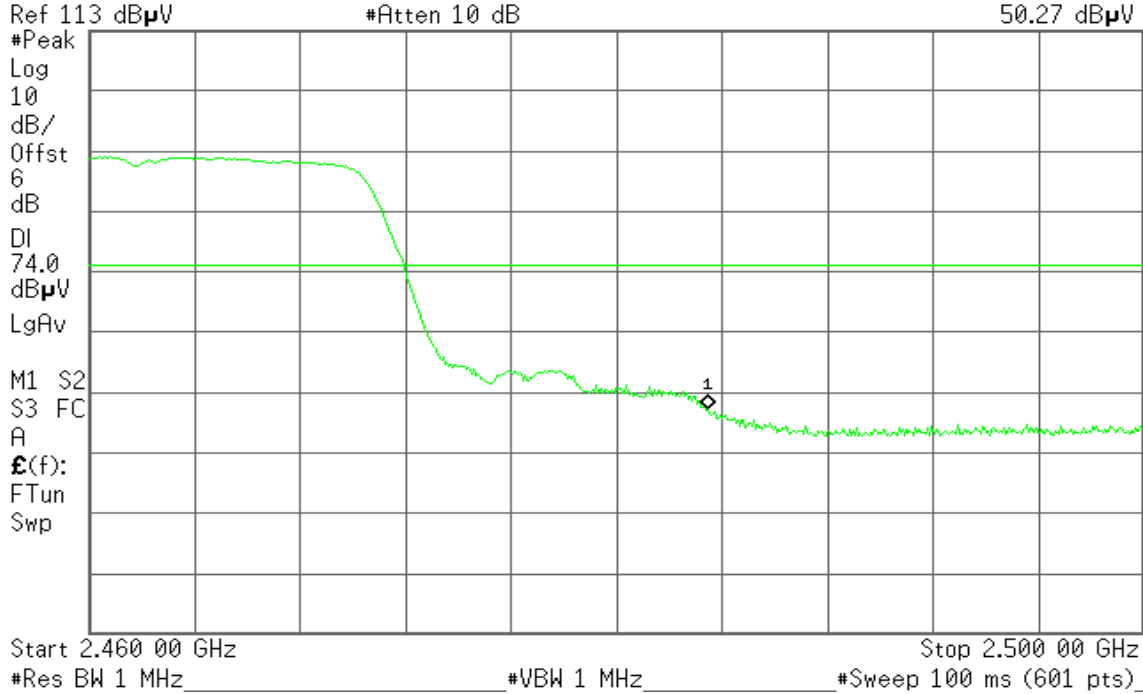

Detector mode: Average

Polarity: Horizontal

Agilent 16:30:42 Nov 23, 2009

R T

Mkr1 2.483 50 GHz
34.90 dB μ V

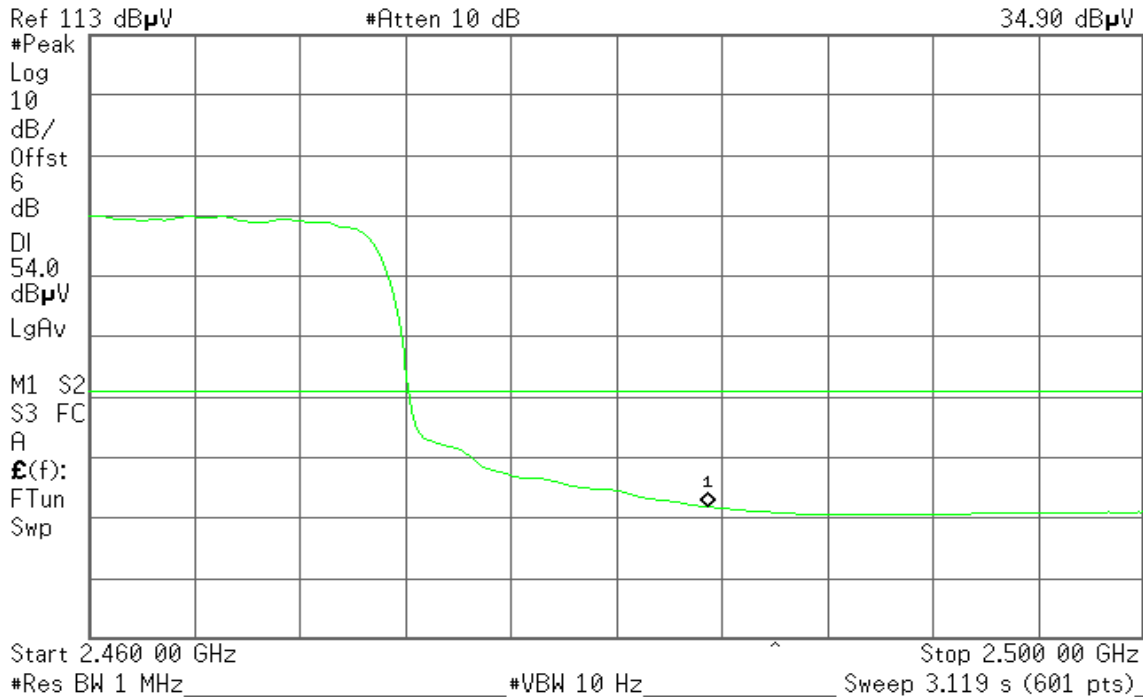



Band Edges (draft 802.11n 40 MHz Channel mode / CH Low)

Detector mode: Peak

Polarity: Vertical

Agilent 10:25:21 Nov 23, 2009

R T

Mkr2 2.390 00 GHz
58.94 dBμV

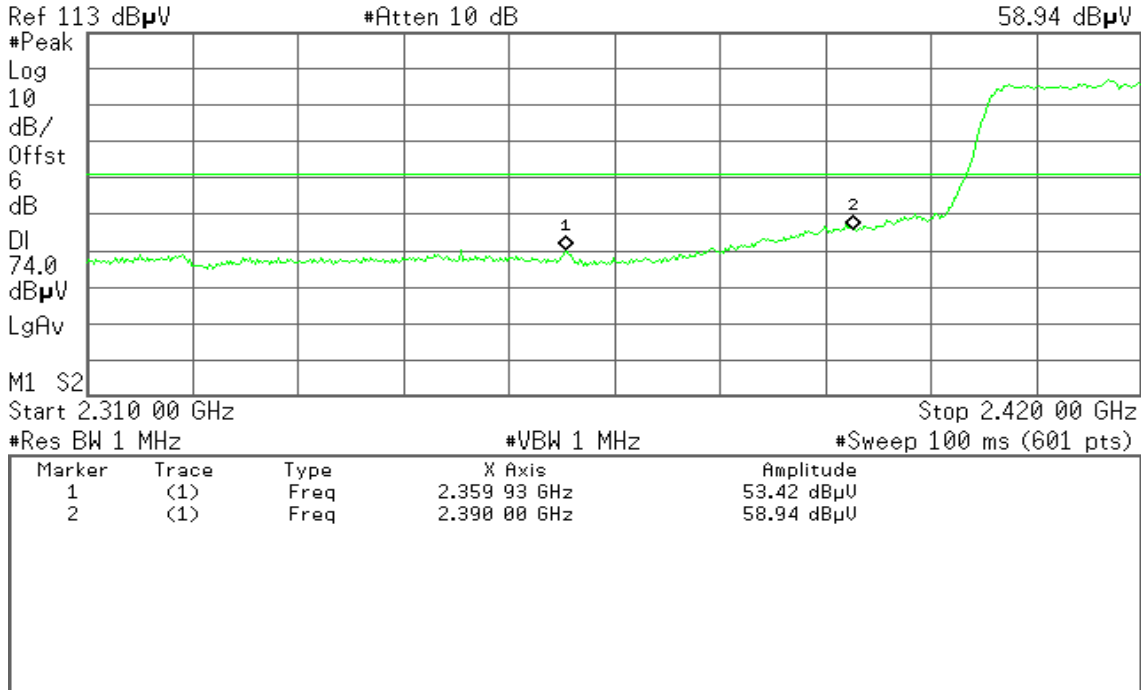

Detector mode: Average

Polarity: Vertical

Agilent 10:26:27 Nov 23, 2009

R T

Mkr2 2.390 00 GHz
45.89 dBμV

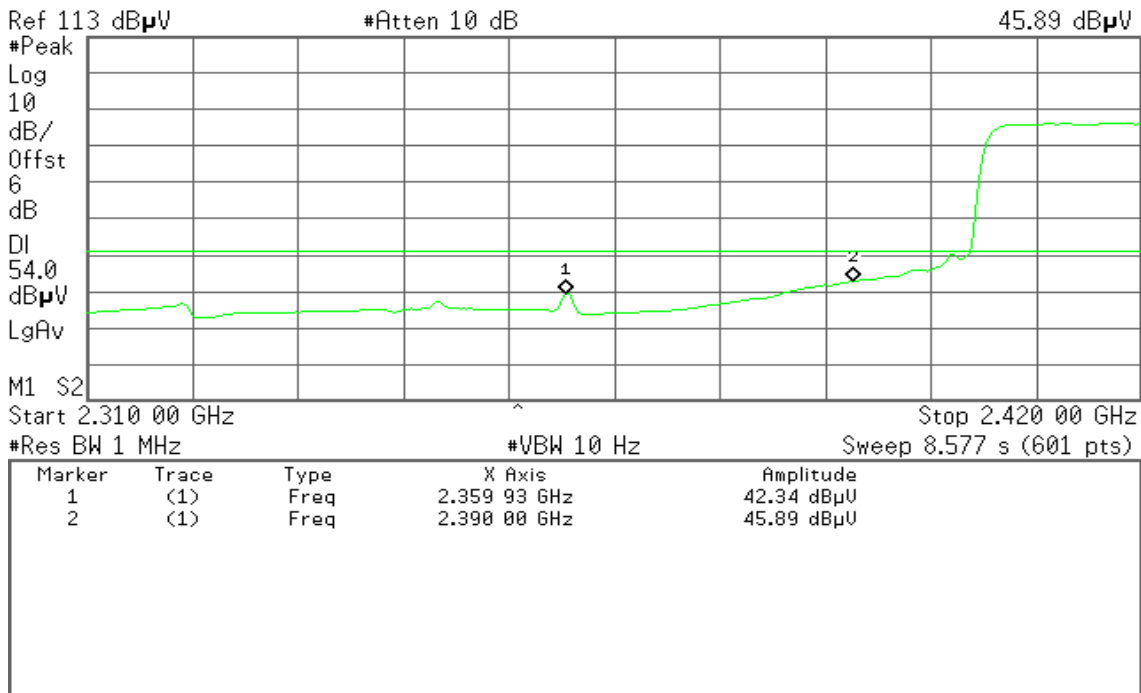



Detector mode: Peak

Polarity: Horizontal

Agilent 10:22:46 Nov 23, 2009

R T

Mkr2 2.390 00 GHz
48.85 dBµV

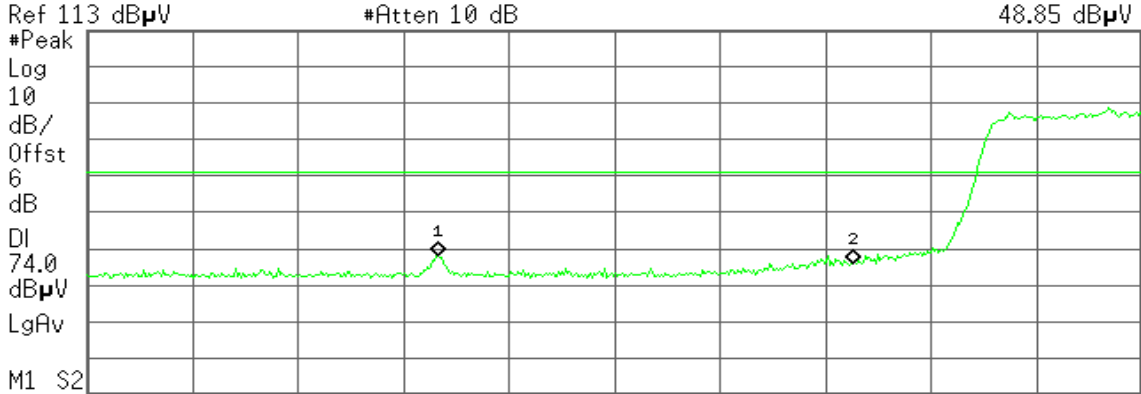

Start 2.310 00 GHz Stop 2.420 00 GHz
#Res BW 1 MHz #VBW 1 MHz #Sweep 100 ms (601 pts)

Marker	Trace	Type	X Axis	Amplitude
1	(1)	Freq	2.346 73 GHz	51.09 dBµU
2	(1)	Freq	2.390 00 GHz	48.85 dBµU

Detector mode: Average

Polarity: Horizontal

Agilent 10:20:11 Nov 23, 2009

R T

Mkr2 2.390 00 GHz
37.93 dBµV

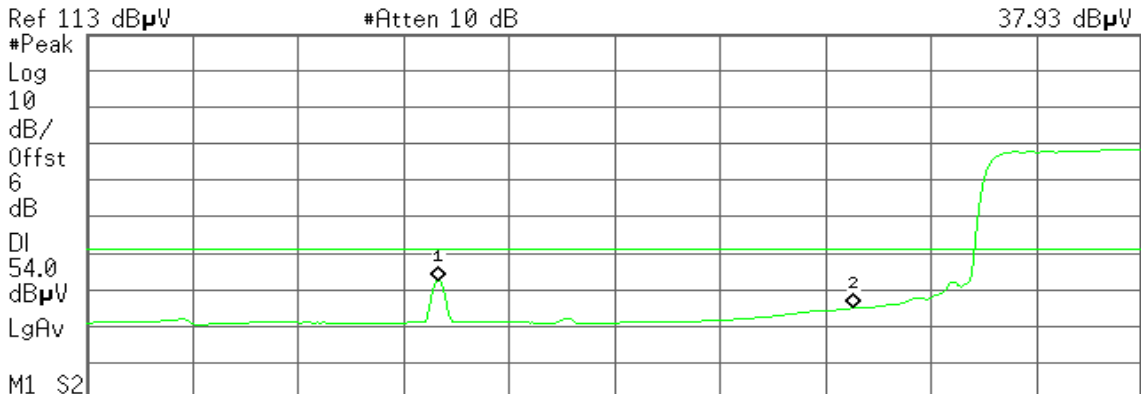

Start 2.310 00 GHz Stop 2.420 00 GHz
#Res BW 1 MHz #VBW 10 Hz Sweep 8.577 s (601 pts)

Marker	Trace	Type	X Axis	Amplitude
1	(1)	Freq	2.346 73 GHz	45.54 dBµU
2	(1)	Freq	2.390 00 GHz	37.93 dBµU



Band Edges (draft 802.11n 40 MHz Channel mode / CH High)

Detector mode: Peak

Polarity: Vertical

Agilent 16:36:44 Nov 23, 2009

R T

Mkr1 2.483 50 GHz
57.58 dBμV

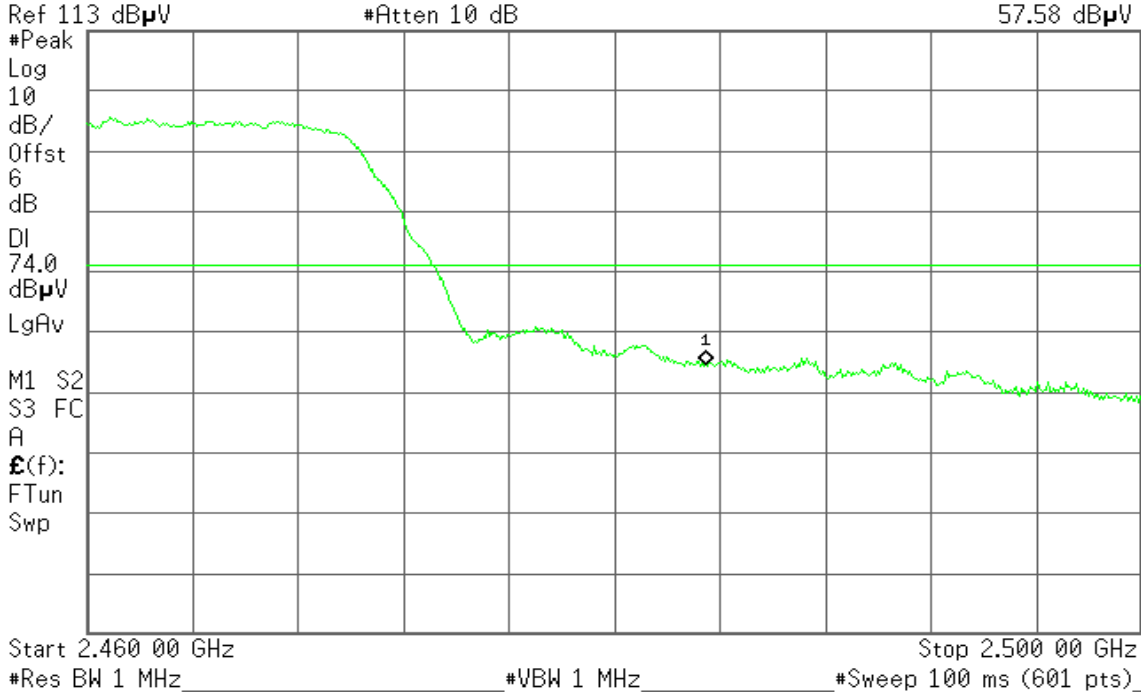

Detector mode: Average

Polarity: Vertical

Agilent 16:37:10 Nov 23, 2009

R T

Mkr1 2.483 50 GHz
44.54 dBμV

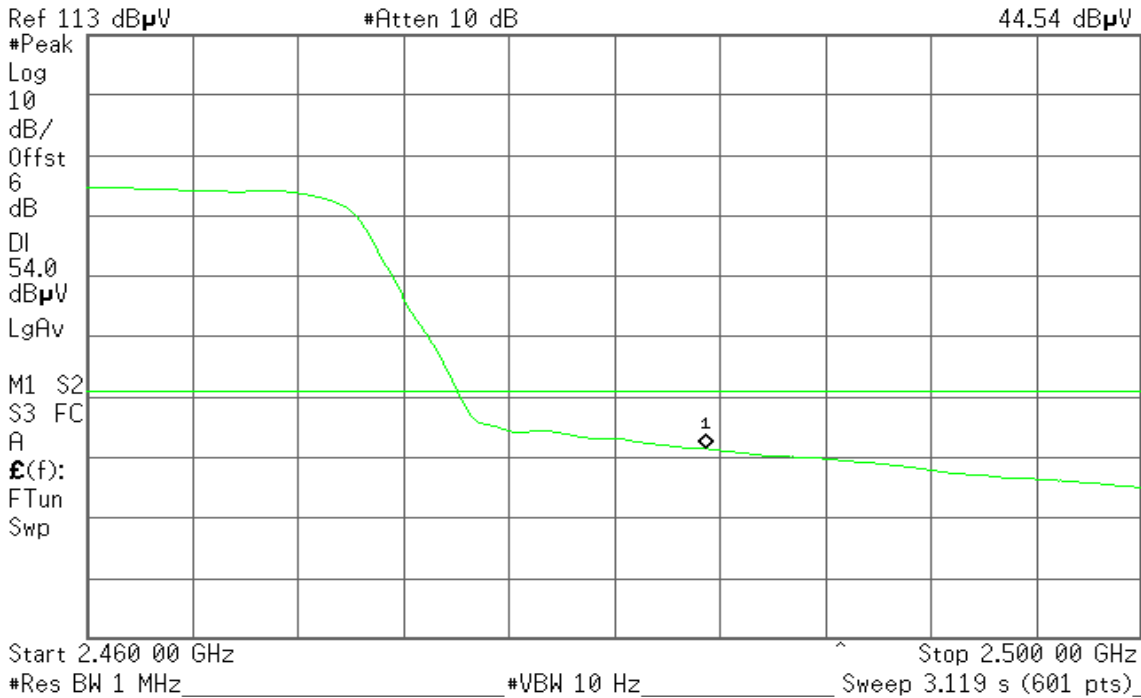



Detector mode: Peak

Polarity: Horizontal

Agilent 16:39:12 Nov 23, 2009

R T

Mkr1 2.483 50 GHz

49.93 dB μ V

Ref 113 dB μ V

#Atten 10 dB

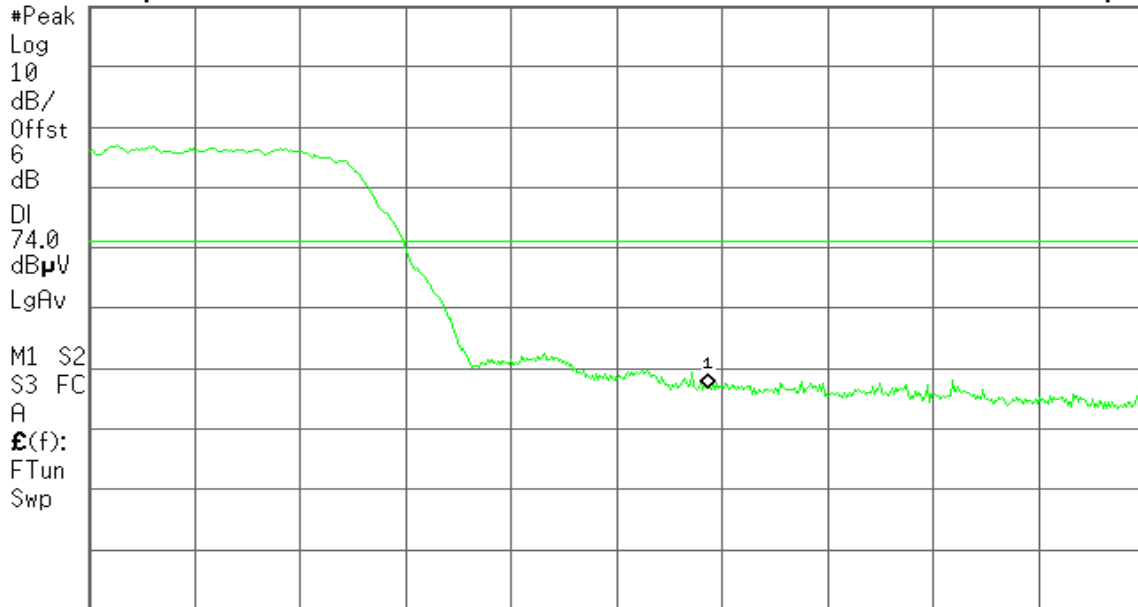

Start 2.460 00 GHz

Stop 2.500 00 GHz

#Res BW 1 MHz

#VBW 1 MHz

#Sweep 100 ms (601 pts)

Detector mode: Average

Polarity: Horizontal

Agilent 16:39:46 Nov 23, 2009

R T

Mkr1 2.483 50 GHz

37.17 dB μ V

Ref 113 dB μ V

#Atten 10 dB

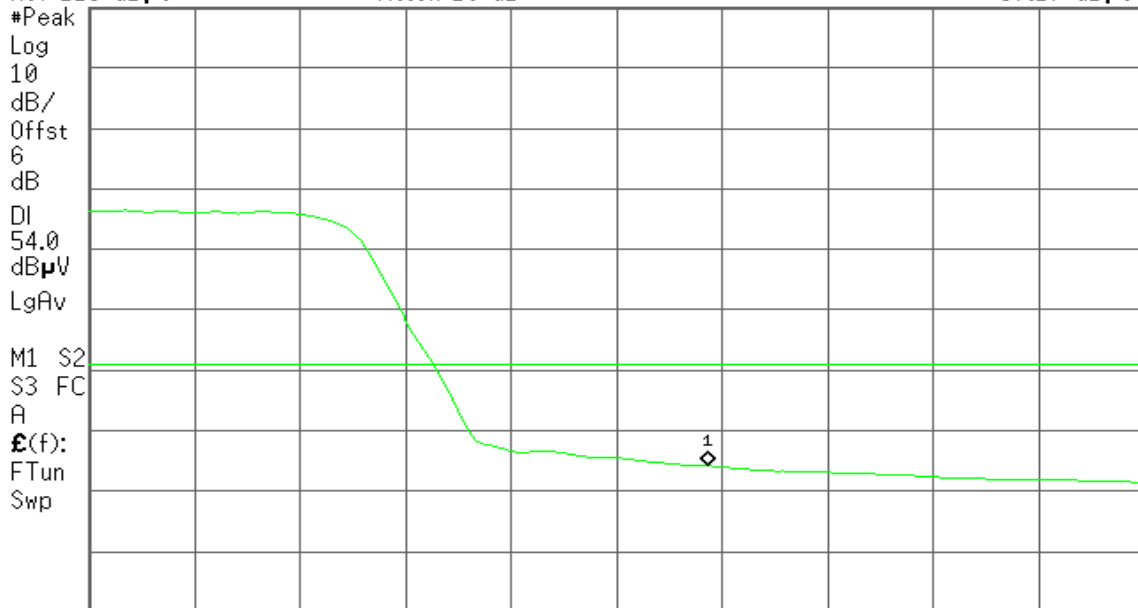

Start 2.460 00 GHz

Stop 2.500 00 GHz

#Res BW 1 MHz

#VBW 10 Hz

Sweep 3.119 s (601 pts)

7.5 PEAK POWER SPECTRAL DENSITY

LIMIT

1. According to §15.247(e), for digitally modulated systems, the power spectral density conducted from the intentional radiator to the antenna shall not be greater than 8 dBm in any 3 kHz band during any time interval of continuous transmission.
2. According to §15.247(f), the digital modulation operation of the hybrid system, with the frequency hopping turned off, shall comply with the power density requirements of paragraph (d) of this section.

TEST CONFIGURATION

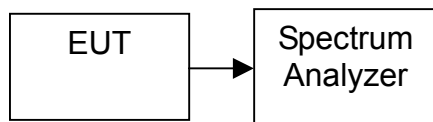

TEST PROCEDURE

1. Place the EUT on the table and set it in transmitting mode.
Remove the antenna from the EUT and then connect a low loss RF cable from the antenna port to the spectrum analyzer.
2. Set the spectrum analyzer as RBW = 3kHz, VBW = 10kHz, Span = 300kHz, Sweep=100s
3. Record the max. reading.
4. Repeat the above procedure until the measurements for all frequencies are completed.

TEST RESULTS

No non-compliance noted



TEST DATA

Test mode: IEEE 802.11b mode

Channel	Frequency (MHz)	PPSD (dBm)	Limit (dBm)	Result
Low	2412	-15.27	8.00	PASS
Mid	2437	-15.76		PASS
High	2462	-16.86		PASS

Test mode: IEEE 802.11g mode

Channel	Frequency (MHz)	PPSD (dBm)	Limit (dBm)	Result
Low	2412	-16.98	8.00	PASS
Mid	2437	-18.11		PASS
High	2462	-19.07		PASS

Test mode: draft 802.11n 20 MHz Channel mode

Channel	Frequency (MHz)	PPSD (dBm)	Limit (dBm)	Result
Low	2412	-17.30	8.00	PASS
Mid	2437	-17.82		PASS
High	2462	-17.95		PASS

Test mode: draft 802.11n 40 MHz Channel mode

Channel	Frequency (MHz)	PPSD (dBm)	Limit (dBm)	Result
Low	2422	-20.28	8.00	PASS
Mid	2437	-18.52		PASS
High	2452	-20.02		PASS



Test Plot

IEEE 802.11b mode

PPSD (CH Low)

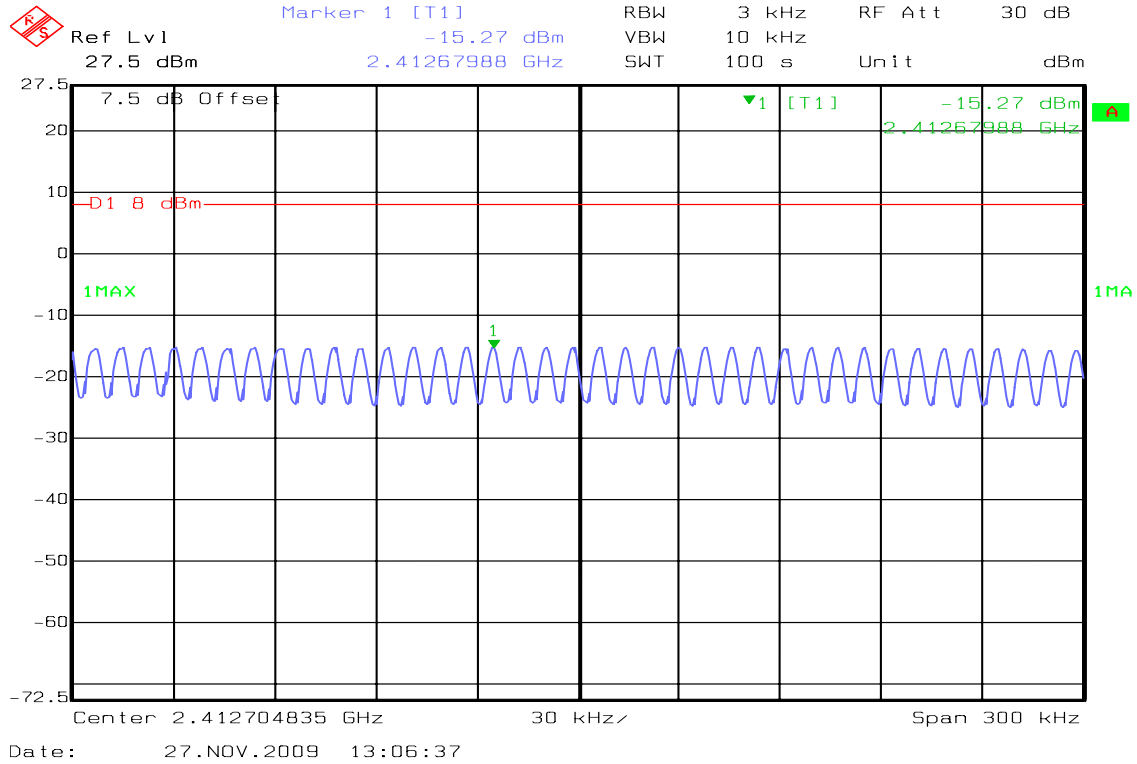

PPSD (CH Mid)

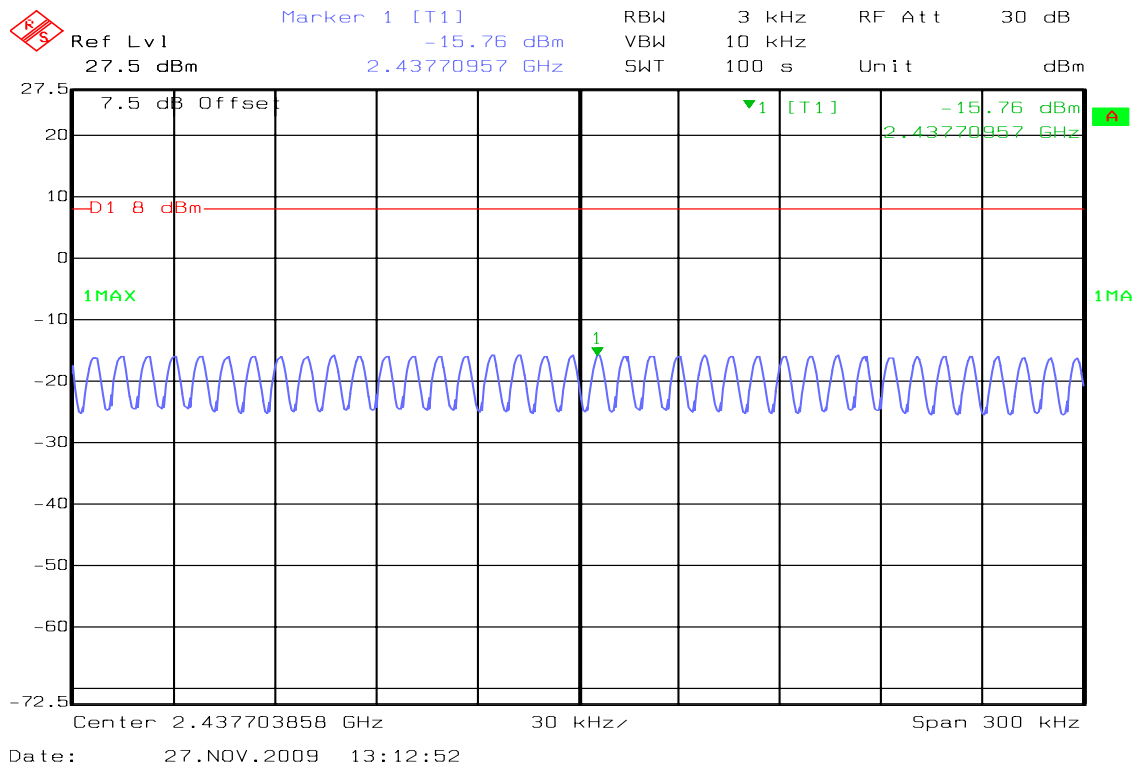



PPSD (CH High)

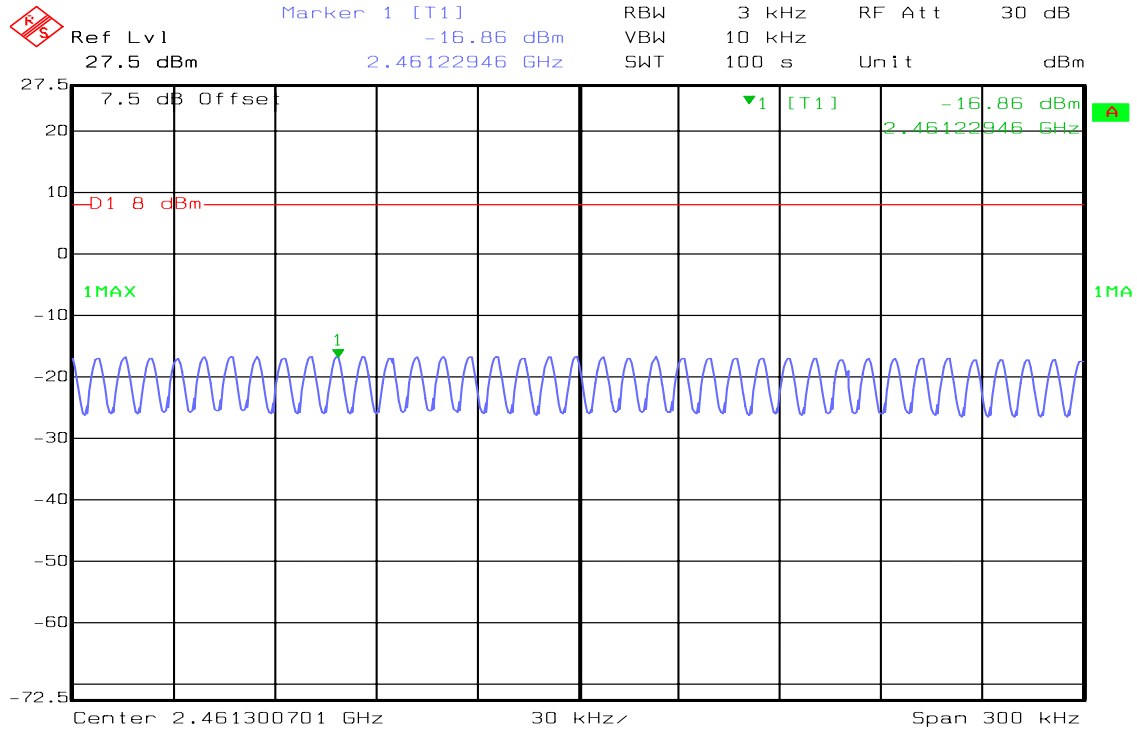

Date: 27.NOV.2009 13:25:37

IEEE 802.11g mode

PPSD (CH Low)

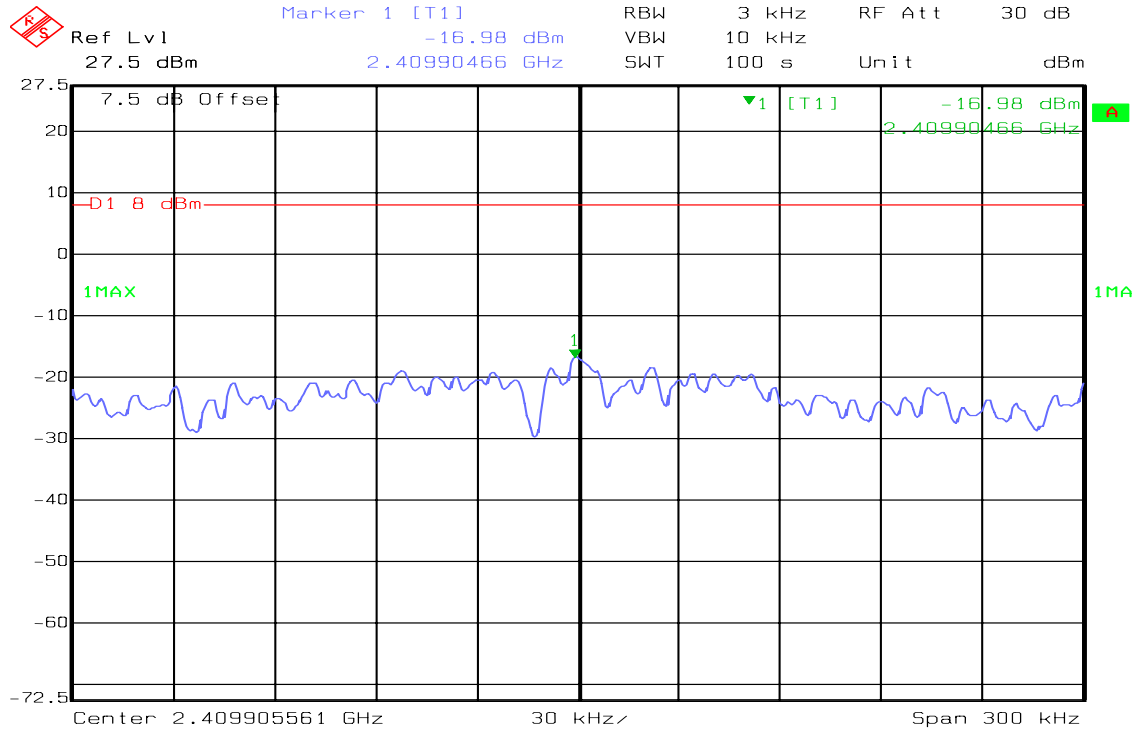

Date: 27.NOV.2009 13:41:34



PPSD (CH Mid)

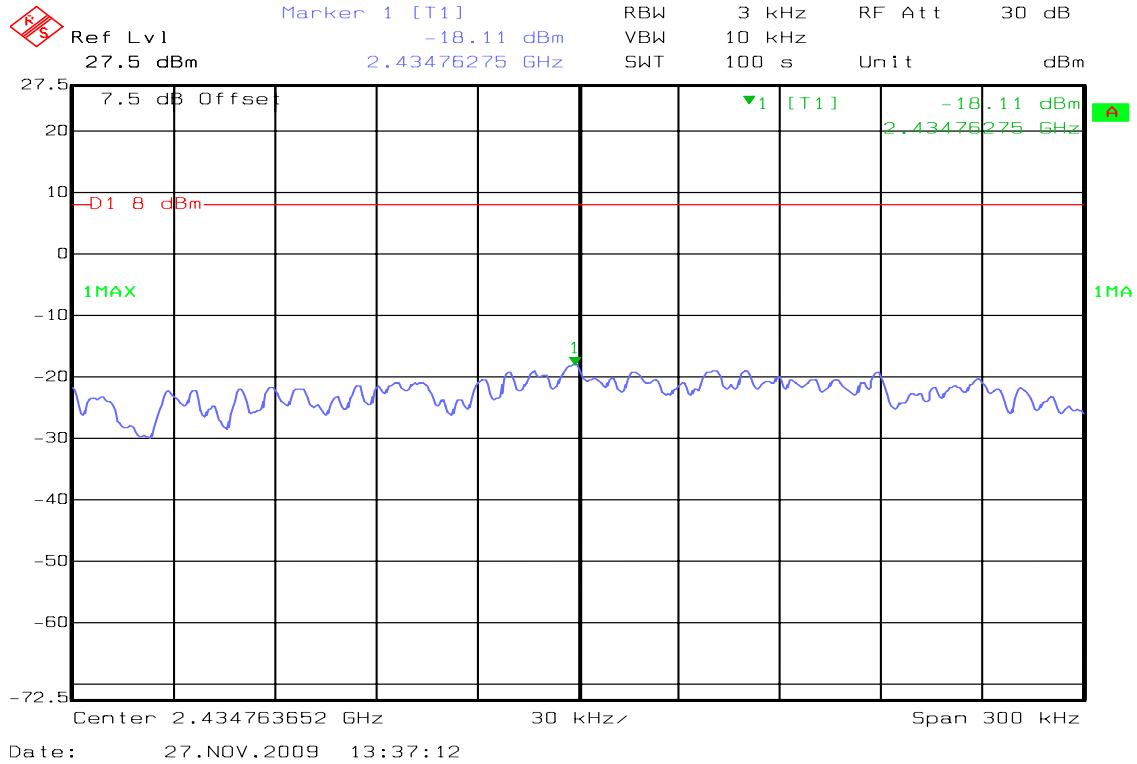

PPSD (CH High)

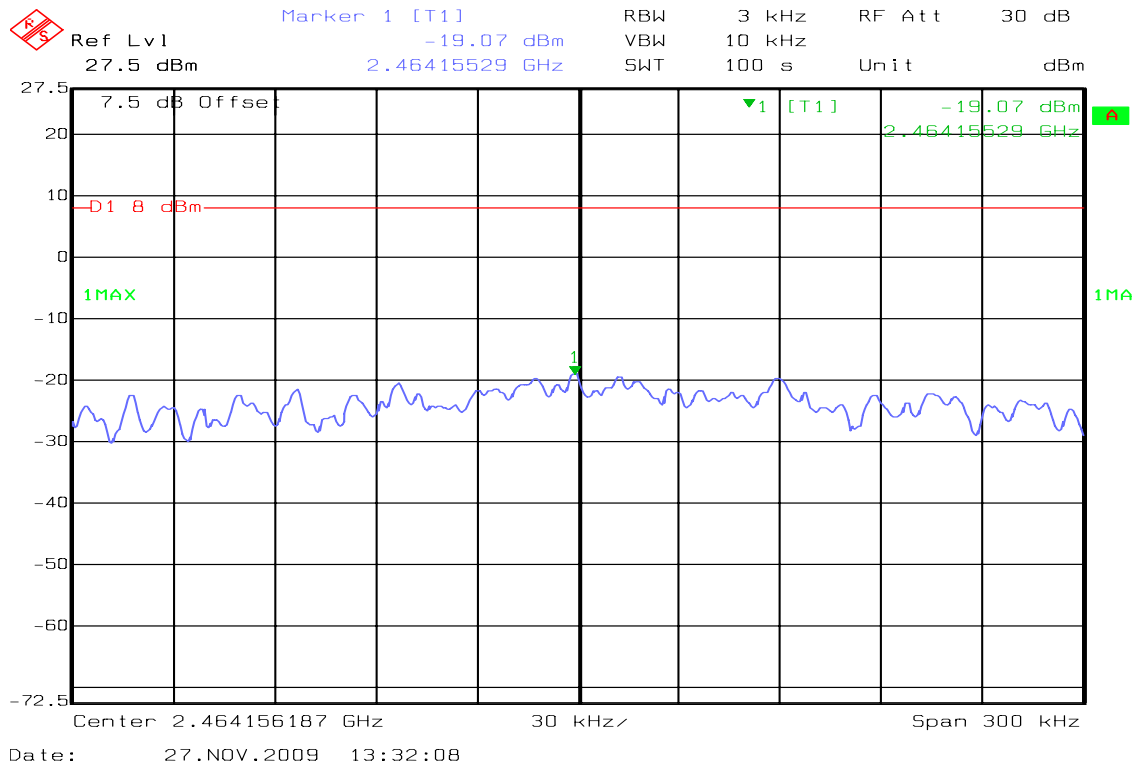



draft 802.11n 20 MHz Channel mode

PPSD (CH Low)

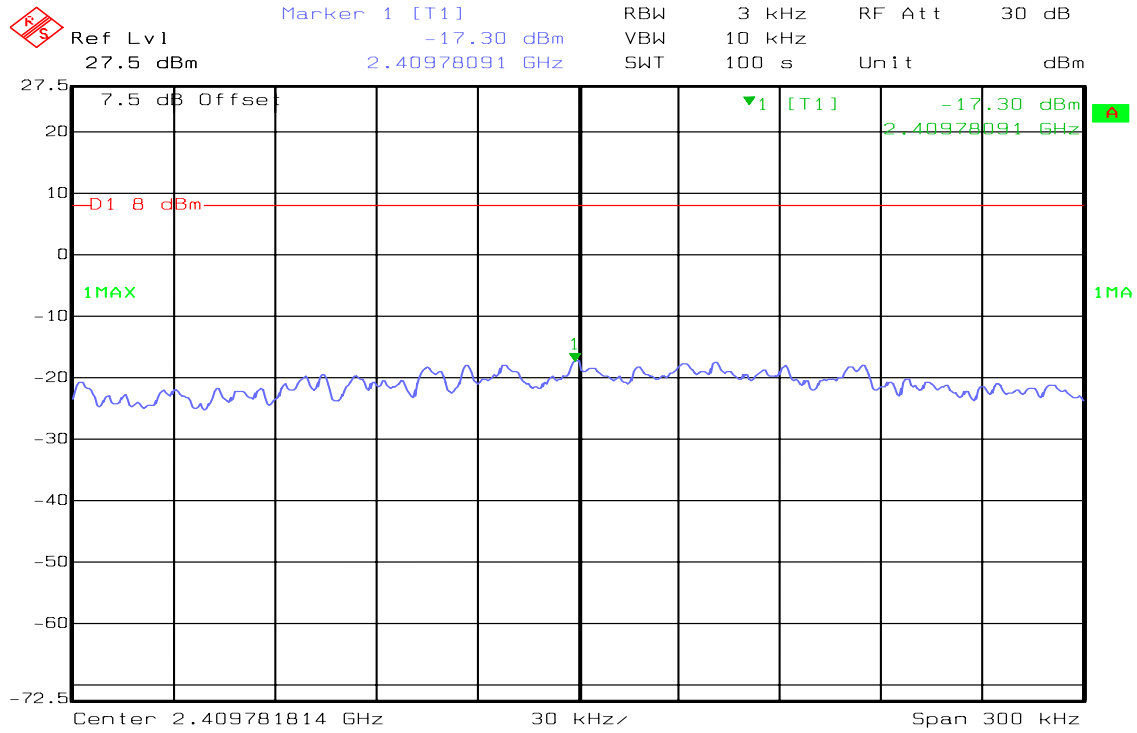

Date: 27.NOV.2009 13:46:30

PPSD (CH Mid)

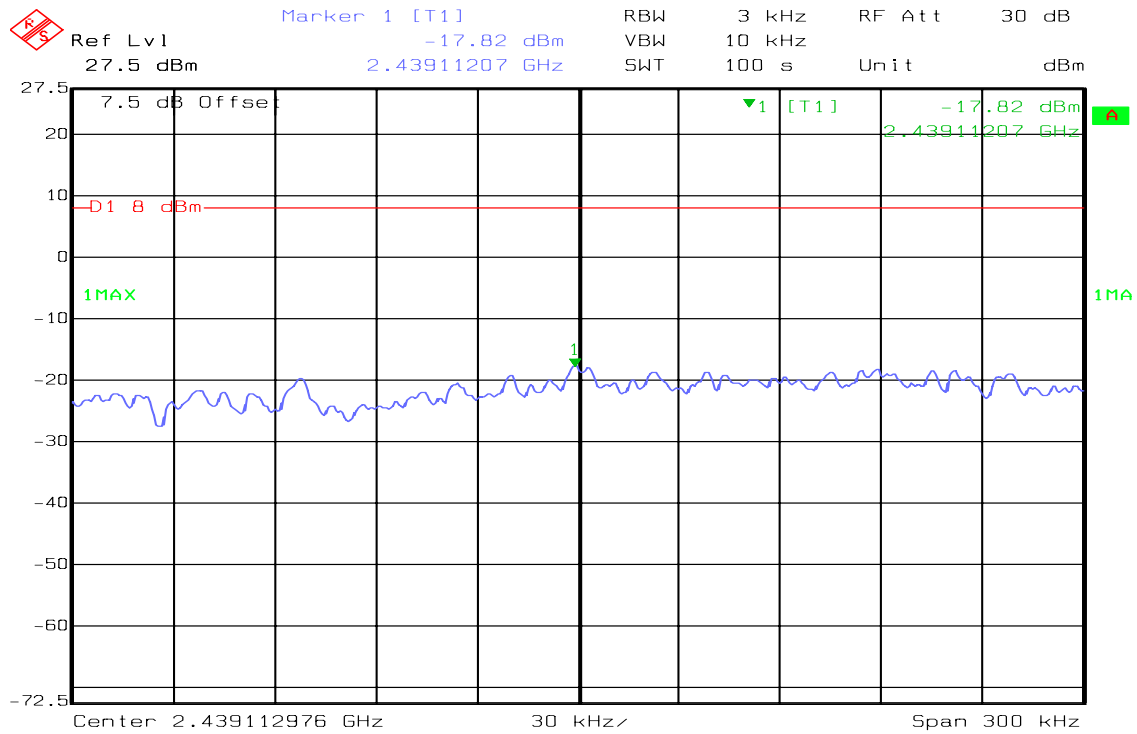

Date: 27.NOV.2009 13:52:42



PPSD (CH High)

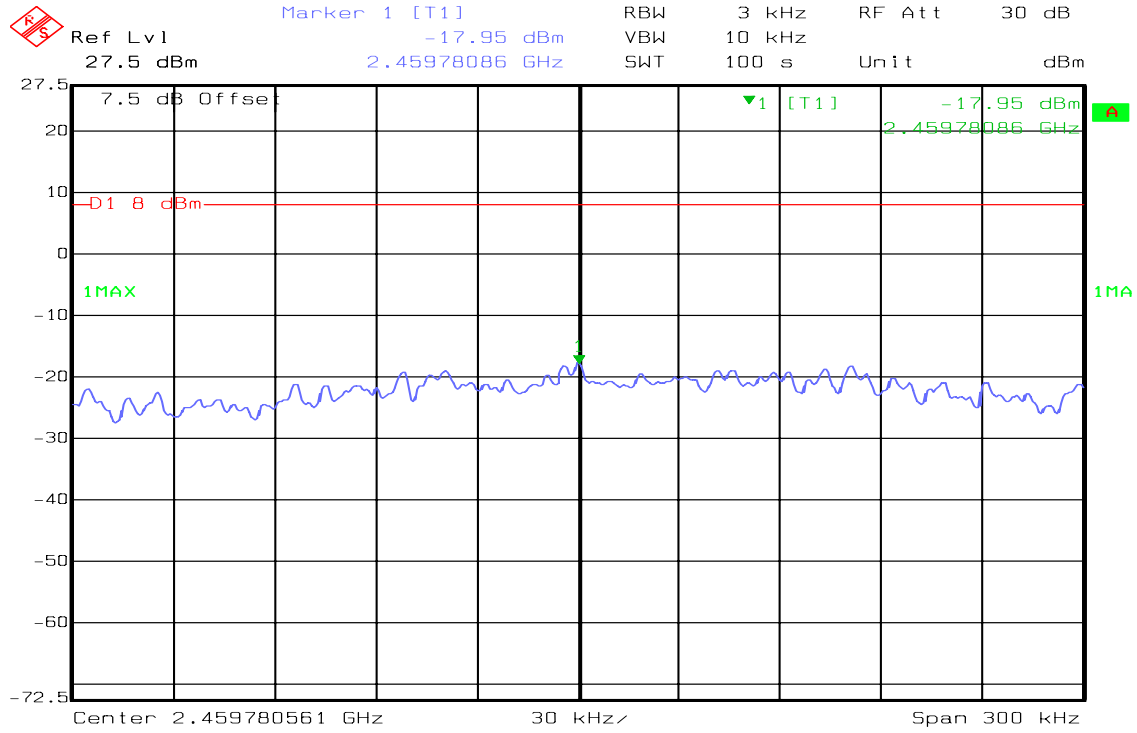

Date: 27.NOV.2009 13:59:40

draft 802.11n 40 MHz Channel mode

PPSD (CH Low)

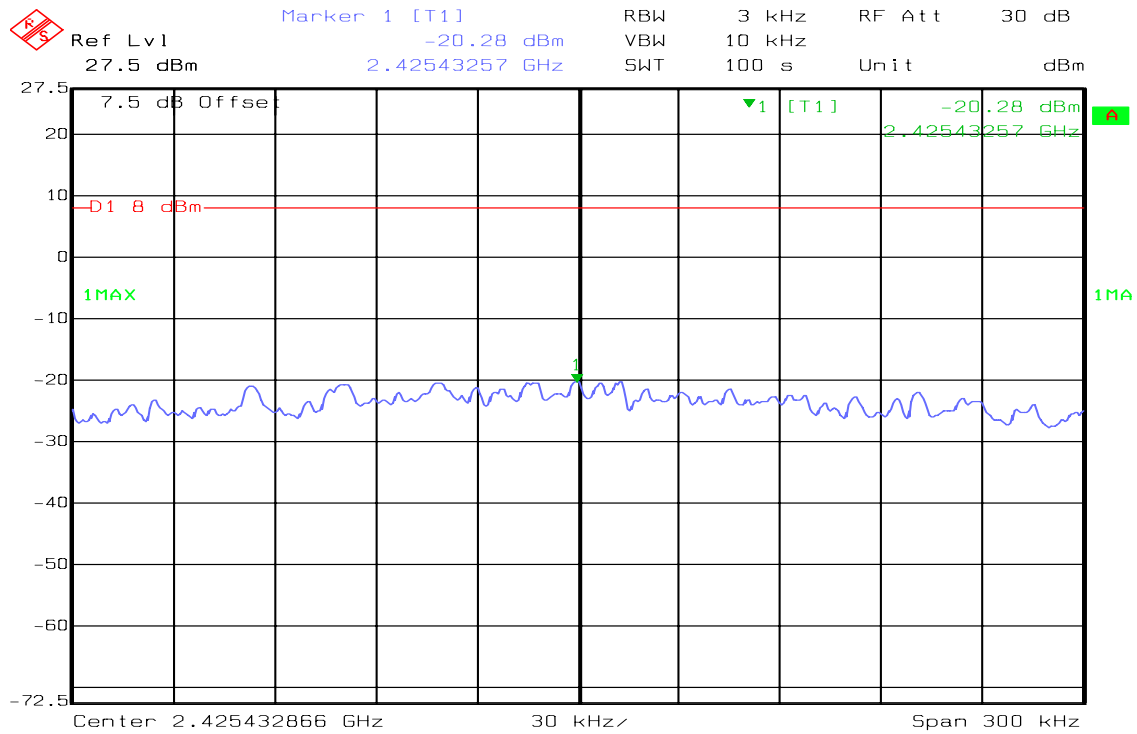

Date: 27.NOV.2009 14:14:26



PPSD (CH Mid)

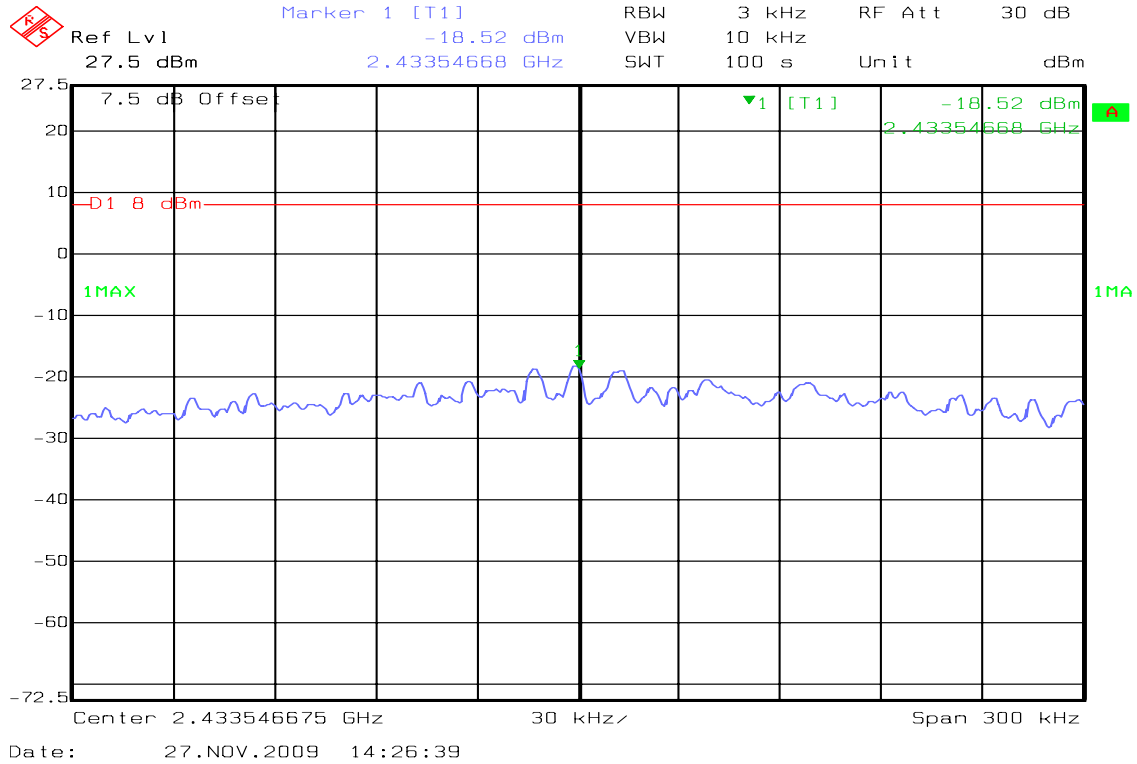

PPSD (CH High)

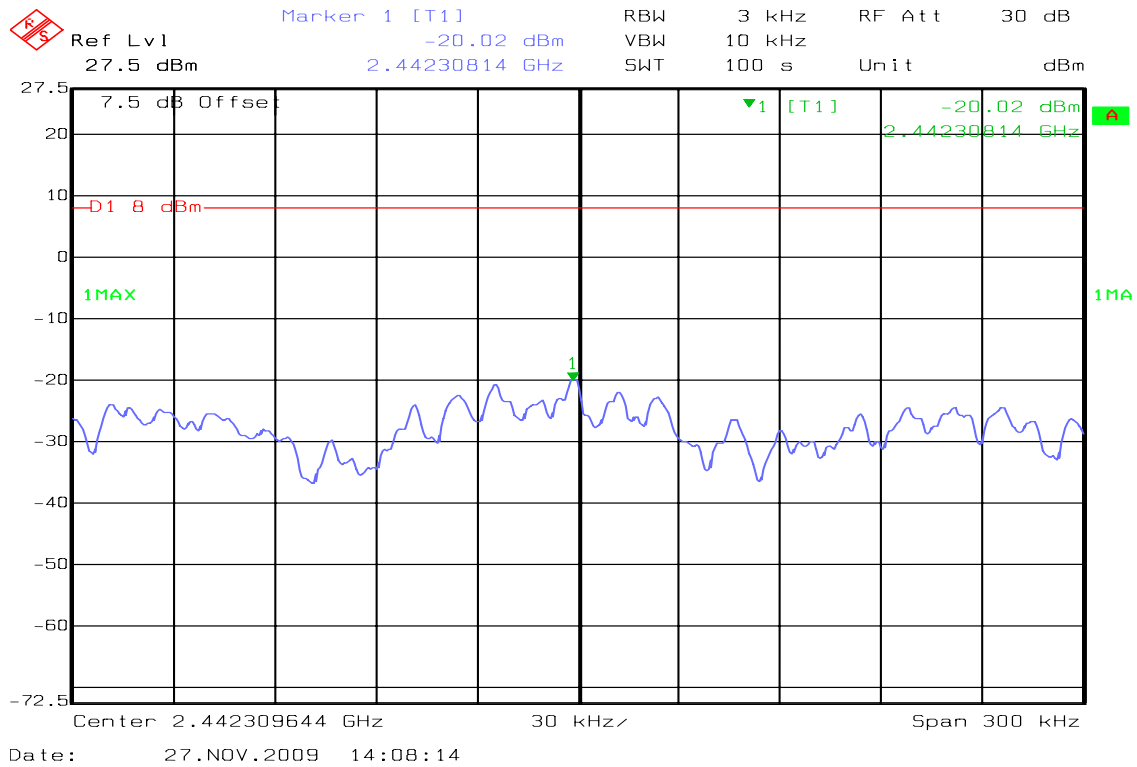

7.6 SPURIOUS EMISSIONS

7.6.1 CONDUCTED MEASUREMENT

LIMIT

According to §15.247(d), in any 100 kHz bandwidth outside the frequency bands in which the spread spectrum intentional radiator is operating, the radio frequency power that is produced by the intentional radiator shall be at least 20 dB below that in the 100 kHz bandwidth within the band that contains the highest level of the desired power, based on either an RF conducted or a radiated measurement, provided the transmitter demonstrates compliance with the peak conducted power limits. In addition, radiated emissions which fall in the restricted bands, as defined in §15.205(a), must also comply with the radiated emission limits specified in 15.209(a) (see Section 15.205(c)).

TEST CONFIGURATION

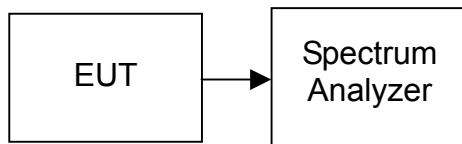

TEST PROCEDURE

Conducted RF measurements of the transmitter output were made to confirm that the EUT antenna port conducted emissions meet the specified limit and to identify any spurious signals that require further investigation or measurements on the radiated emissions site.

The transmitter output is connected to the spectrum analyzer. The resolution bandwidth is set to 100 kHz. The video bandwidth is set to 100 kHz.

Measurements are made over the 30MHz to 26GHz range with the transmitter set to the lowest, middle, and highest channels.

TEST RESULTS

No non-compliance noted.



Test Plot

IEEE 802.11b mode

CH Low

Agilent 15:18:45 Nov 27, 2009

R T

Mkr4 780 MHz
-56.75 dBm

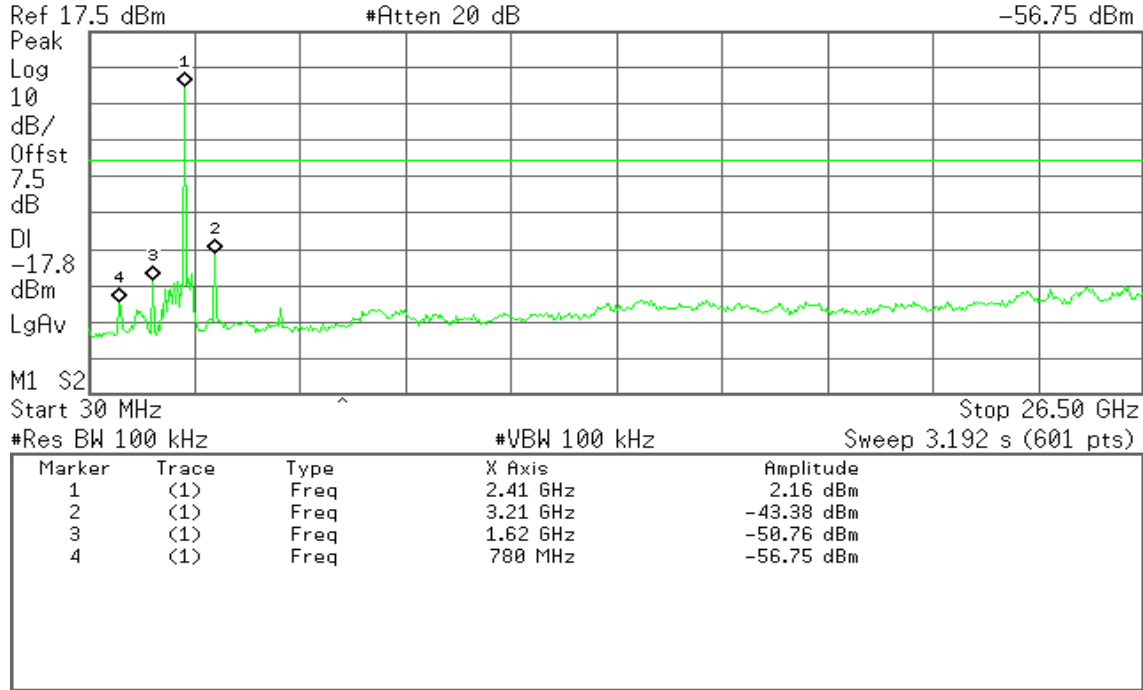

CH Mid

Agilent 15:20:21 Nov 27, 2009

R T

Mkr4 820 MHz
-56.63 dBm

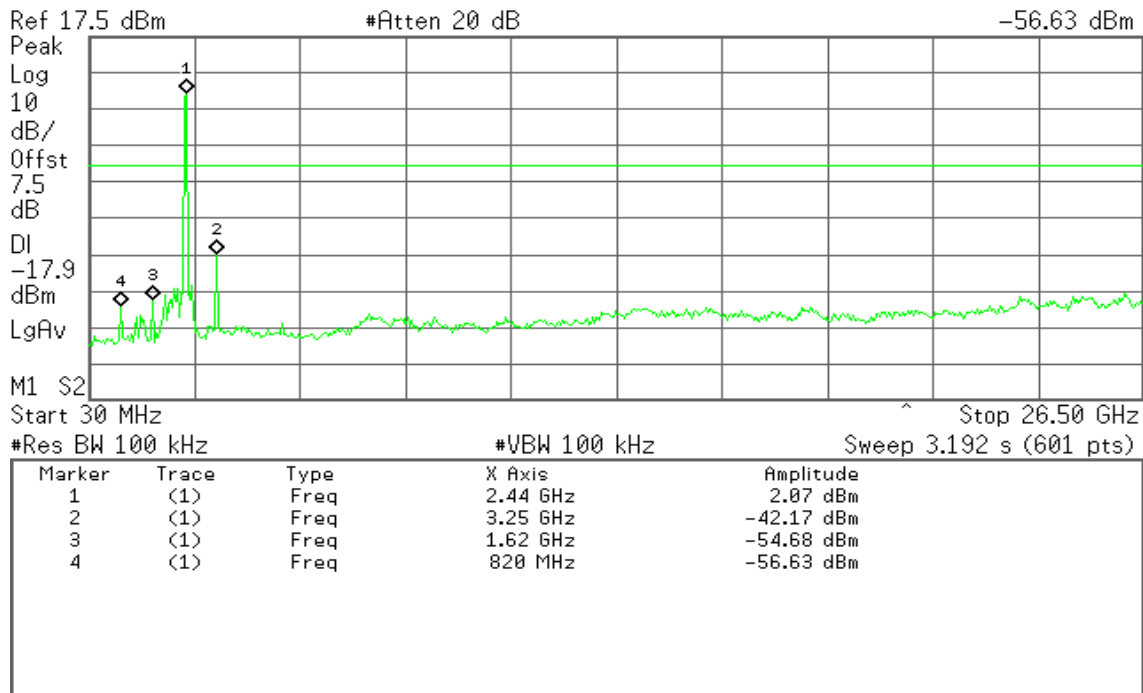



CH High

Agilent 15:22:05 Nov 27, 2009

R T

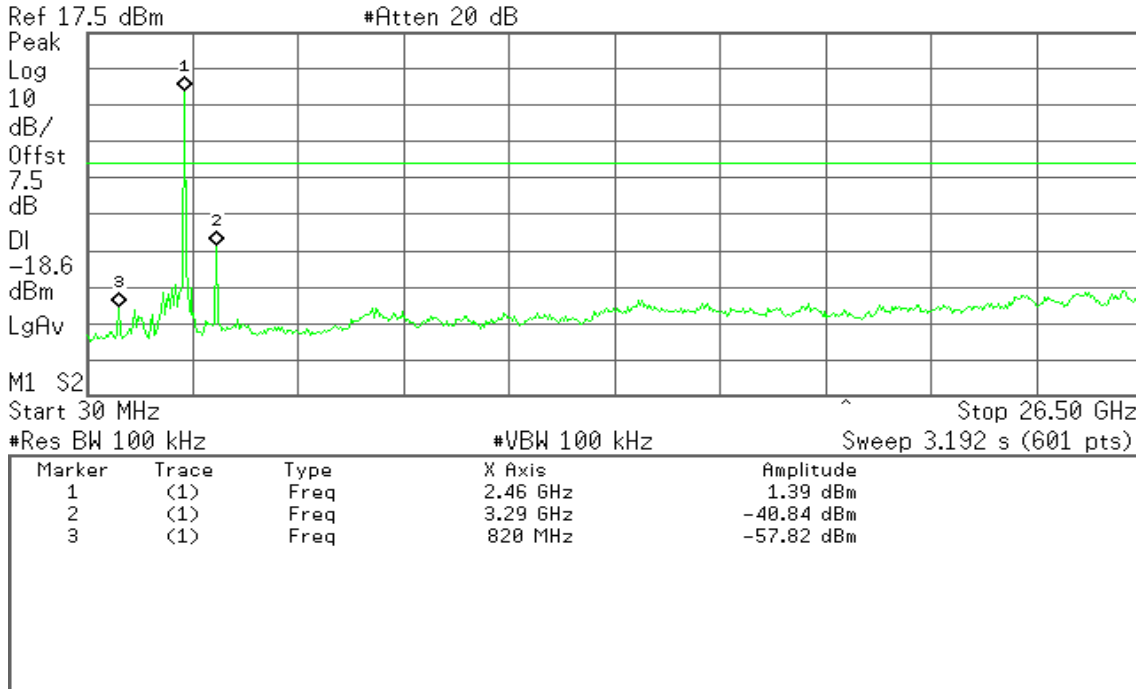

IEEE 802.11g mode

CH Low

Agilent 15:30:55 Nov 27, 2009

R T

Mkr1 2.41 GHz
-4.89 dBm

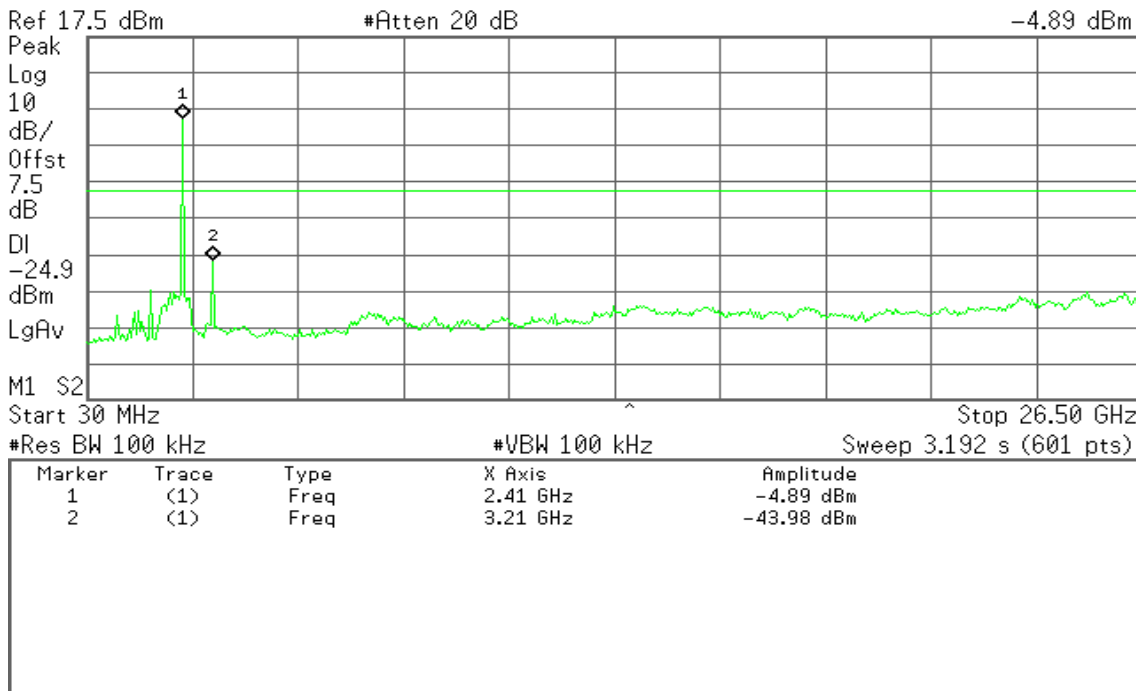



CH Mid

Agilent 15:32:16 Nov 27, 2009

R T

Mkr2 3.25 GHz
-42.44 dBm

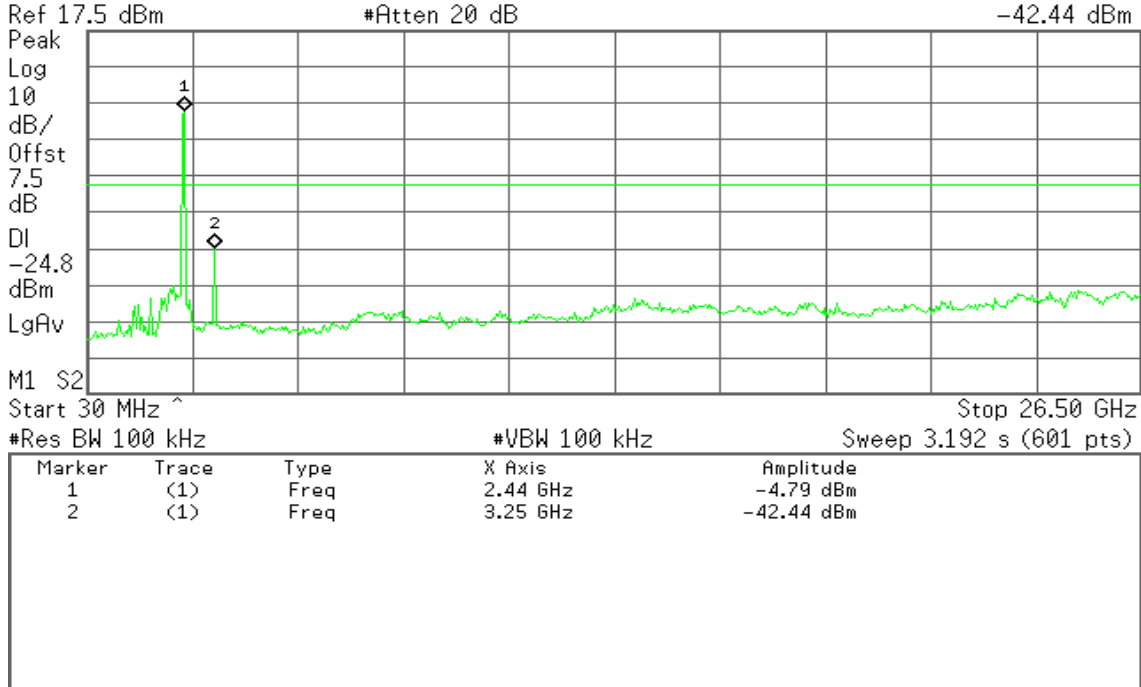

CH High

Agilent 15:23:45 Nov 27, 2009

R T

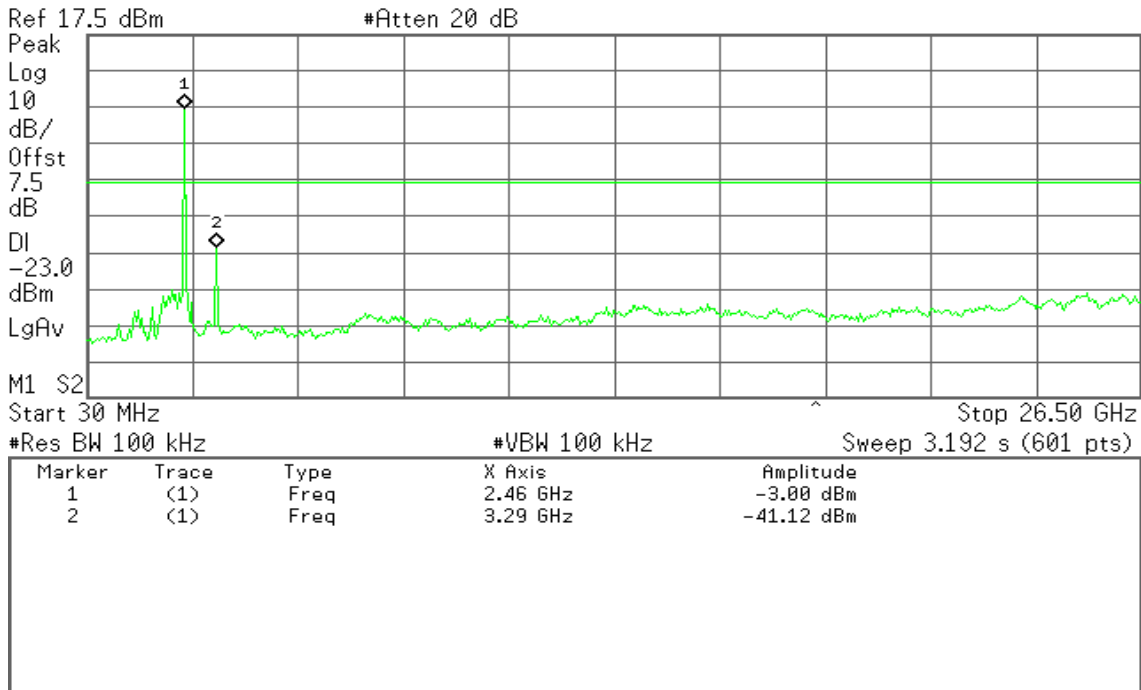



draft 802.11n 20 MHz Channel mode

CH Low

Agilent 15:34:43 Nov 27, 2009

R T

Mkr1 2.41 GHz
-4.50 dBm

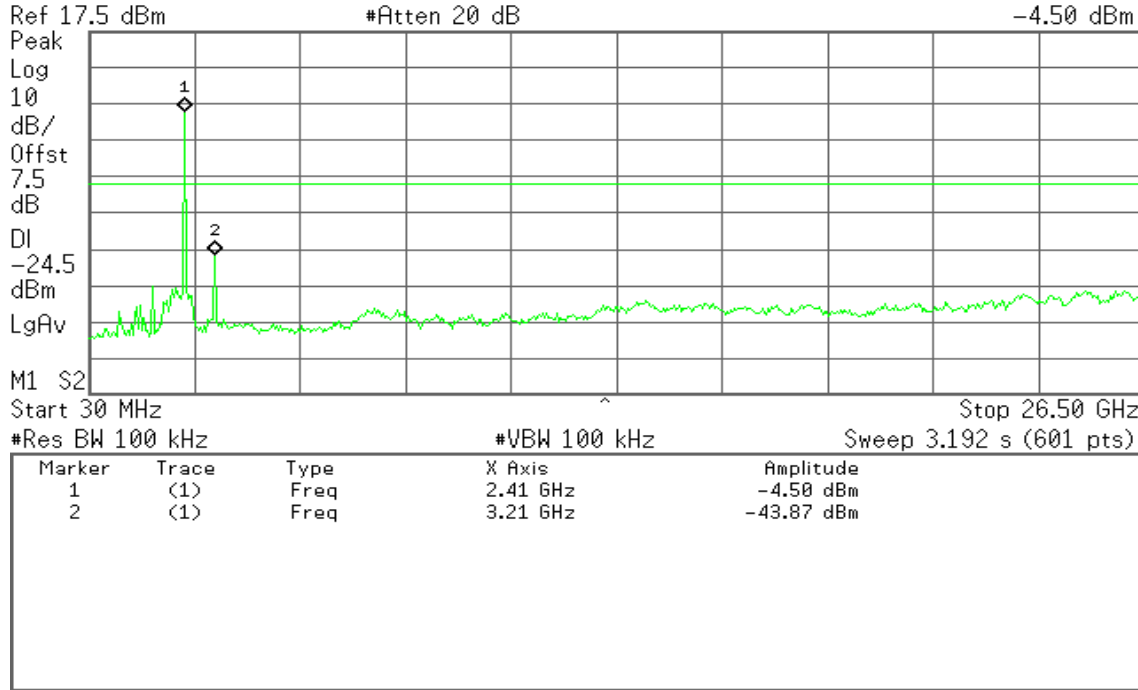

CH Mid

Agilent 15:37:43 Nov 27, 2009

R T

Mkr2 3.25 GHz
-42.54 dBm

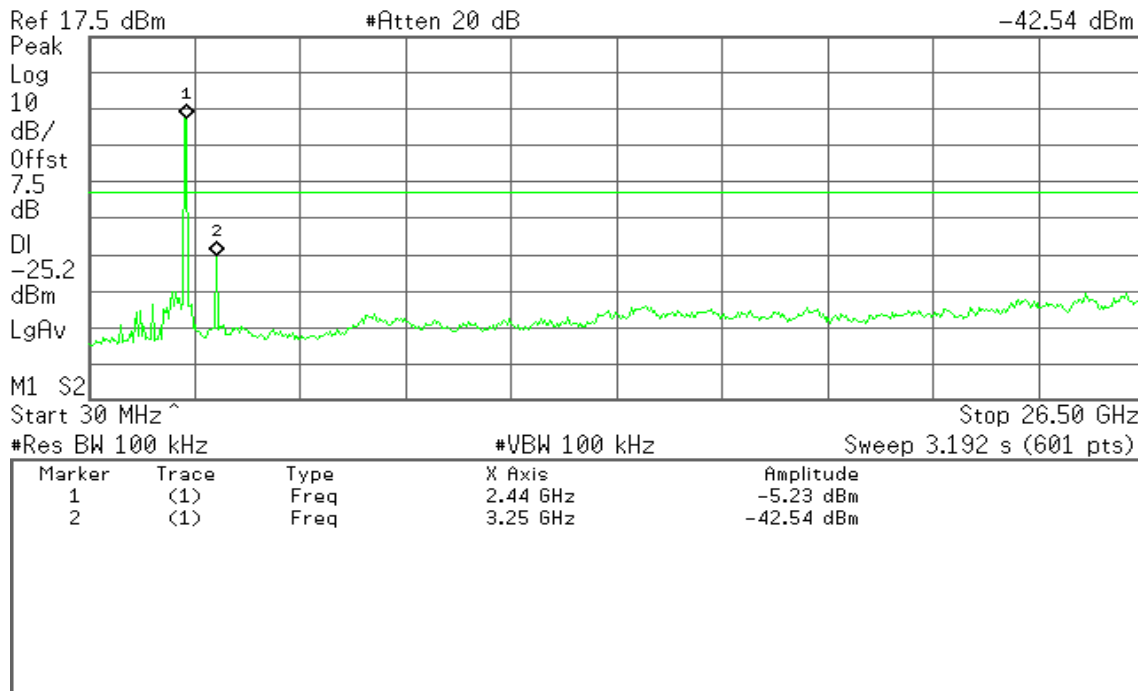



CH High

Agilent 15:39:12 Nov 27, 2009

R T

Mkr1 2.46 GHz
-5.20 dBm

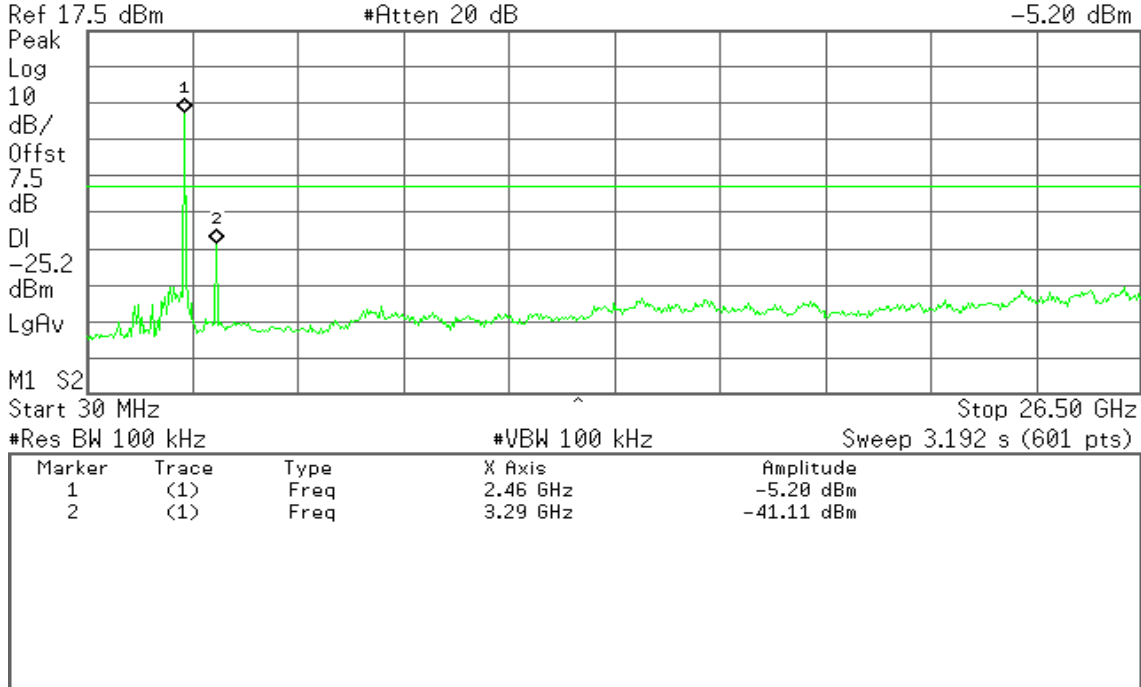

draft 802.11n 40 MHz Channel mode

CH Low

Agilent 15:45:58 Nov 27, 2009

R T

Mkr1 2.42 GHz
-8.32 dBm

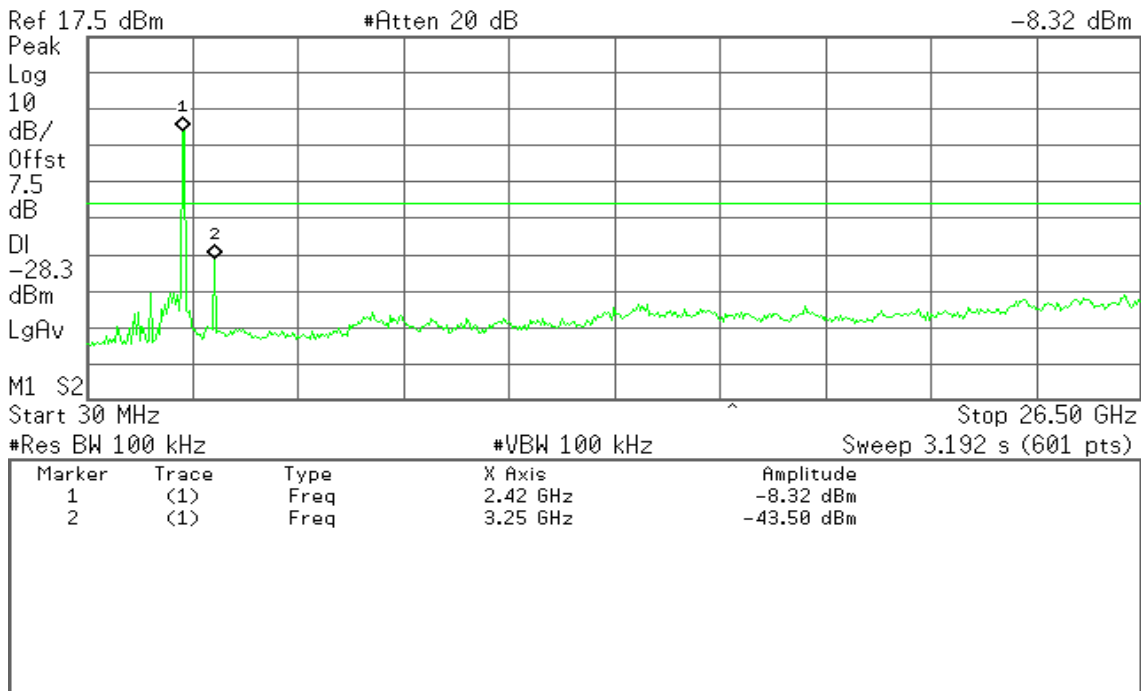



CH Mid

Agilent 15:43:36 Nov 27, 2009

R T

Mkr1 2.44 GHz
-8.06 dBm

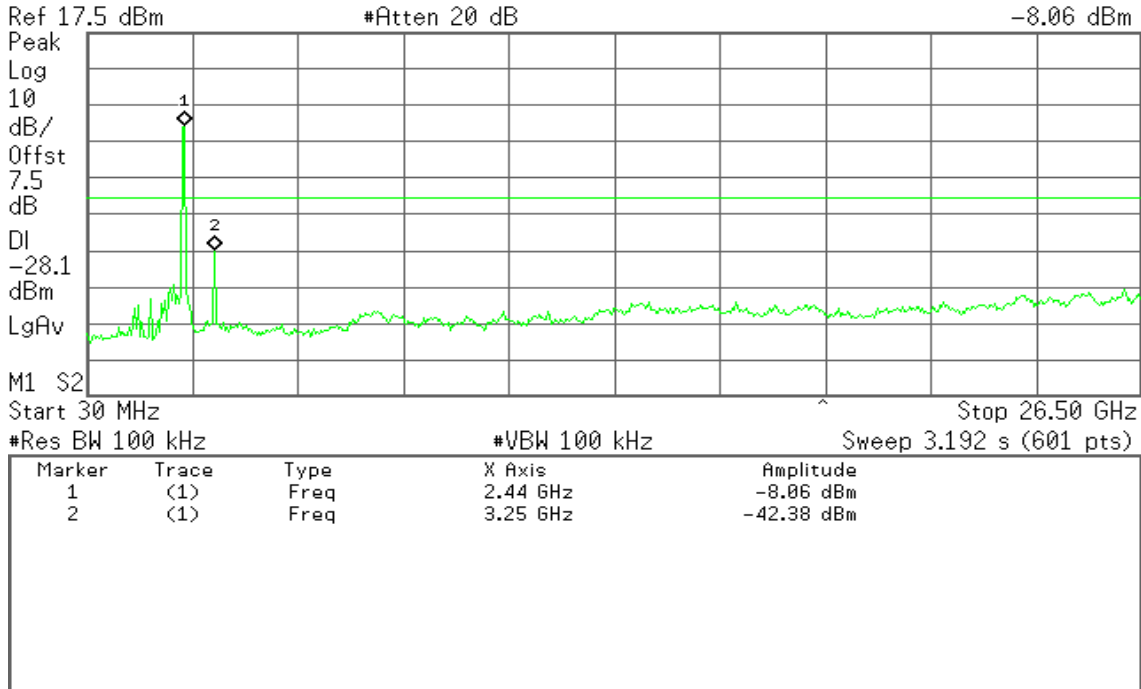

CH High

Agilent 15:42:11 Nov 27, 2009

R T

Mkr1 2.45 GHz
-7.81 dBm

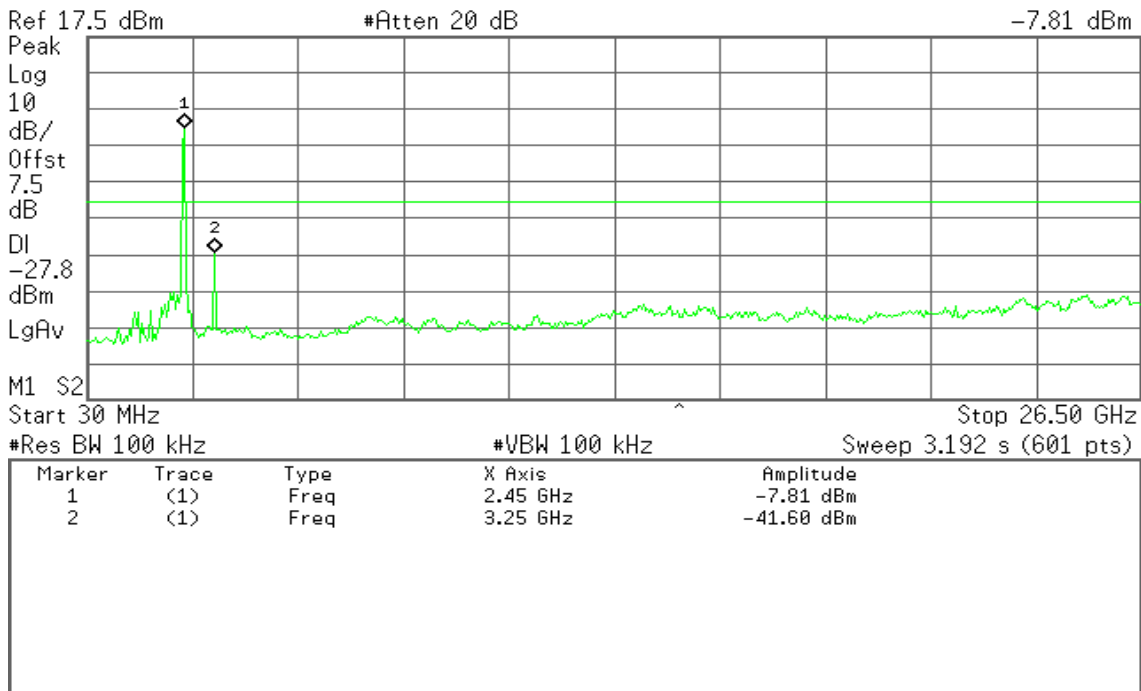



7.6.2 RADIATED EMISSIONS

LIMIT

1. According to §15.209(a), except as provided elsewhere in this Subpart, the emissions from an intentional radiator shall not exceed the field strength levels specified in the following table:

Frequency (MHz)	Field Strength (µV/m)	Measurement Distance (m)
30-88	100*	3
88-216	150*	3
216-960	200*	3
Above 960	500	3

Remark: Except as provided in paragraph (g), fundamental emissions from intentional radiators operating under this Section shall not be located in the frequency bands 54-72 MHz, 76-88 MHz, 174-216 MHz or 470-806 MHz. However, operation within these frequency bands is permitted under other sections of this Part, e.g., Sections 15.231 and 15.241.

2. In the emission table above, the tighter limit applies at the band edges.

Frequency (MHz)	Field Strength (µV/m at 3-meter)	Field Strength (dBµV/m at 3-meter)
30-88	100	40
88-216	150	43.5
216-960	200	46
Above 960	500	54

TEST CONFIGURATION

Below 1 GHz

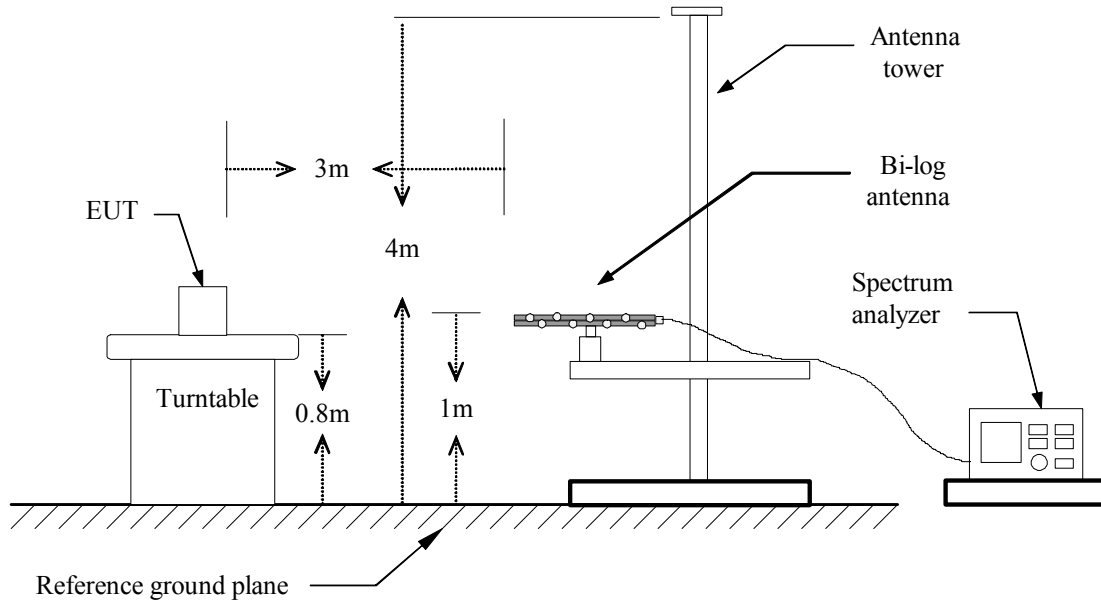

Above 1 GHz

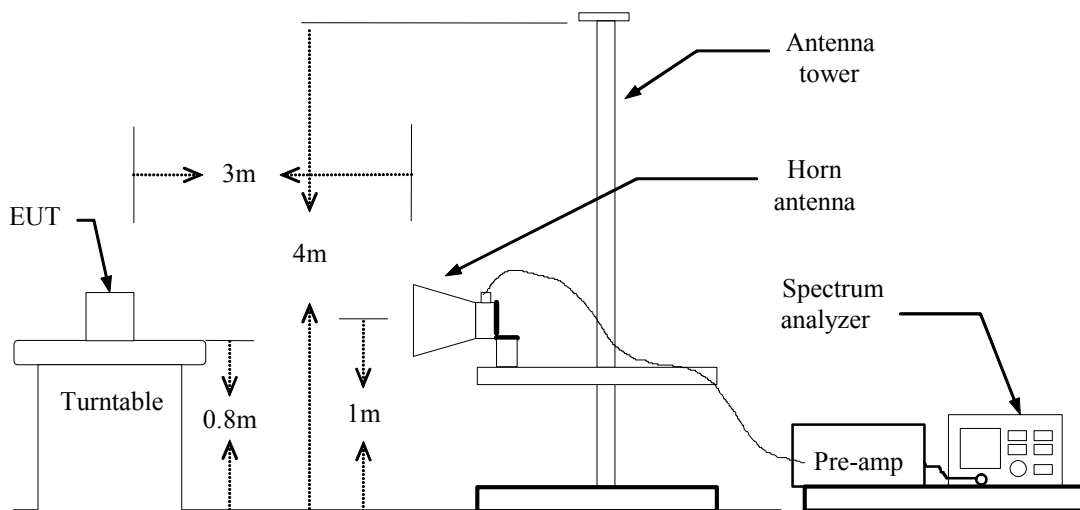



TEST PROCEDURE

1. The EUT is placed on a turntable, which is 0.8m above ground plane.
2. The turntable shall be rotated for 360 degrees to determine the position of maximum emission level.
3. EUT is set 3m away from the receiving antenna, which is varied from 1m to 4m to find out the highest emissions.
4. Maximum procedure was performed on the six highest emissions to ensure EUT compliance.
5. And also, each emission was to be maximized by changing the polarization of receiving antenna both horizontal and vertical.
6. Set the spectrum analyzer in the following setting as:
Below 1GHz:
 RBW=100kHz / VBW=300kHz / Sweep=AUTO
Above 1GHz:
 (a) PEAK: RBW=VBW=1MHz / Sweep=AUTO
 (b) AVERAGE: RBW=1MHz / VBW=10Hz / Sweep=AUTO
7. Repeat above procedures until the measurements for all frequencies are complete.

TEST RESULTS

No non-compliance noted.



TEST DATA

Below 1GHz

Operation Mode: Normal Link **Test Date:** November 30, 2009
Temperature: 18°C **Tested by:** Stan Lin
Humidity: 60% RH **Polarity:** Ver. / Hor.

Frequency (MHz)	Ant. Pol. (H/V)	Reading (dBuV)	Correction Factor (dB/m)	Result (dBuV/m)	Limit (dBuV/m)	Margin (dB)	Remark
32.4628	V	49.20	-14.46	34.74	40.00	-5.26	peak
85.7750	V	48.68	-18.31	30.37	40.00	-9.63	peak
158.5250	V	47.25	-12.33	34.92	43.50	-8.58	peak
231.3120	V	53.37	-13.47	39.90	46.00	-6.10	peak
270.0750	V	48.52	-11.28	37.24	46.00	-8.76	peak
291.9000	V	47.63	-10.71	36.92	46.00	-9.08	peak
321.0000	V	47.23	-9.83	37.40	46.00	-8.60	peak
854.5000	V	39.18	0.44	39.62	46.00	-6.38	peak
88.2000	H	43.74	-18.44	25.30	43.50	-18.20	peak
192.4750	H	49.09	-15.08	34.01	43.50	-9.49	peak
214.3000	H	54.30	-15.05	39.25	43.50	-4.25	peak
277.3500	H	47.82	-11.88	35.94	46.00	-10.06	peak
287.0500	H	46.53	-11.55	34.98	46.00	-11.02	peak
321.0000	H	50.70	-10.52	40.18	46.00	-5.82	peak
350.1000	H	47.89	-9.67	38.22	46.00	-7.78	peak
747.8000	H	40.22	-2.19	38.03	46.00	-7.97	peak

Remark:

1. No emission found between lowest internal used / generated frequency to 30 MHz. (9kHz ~ 30MHz)
2. Measuring frequencies from 9 kHz to the 1GHz.
3. Radiated emissions measured in the measured frequency range were made with an instrument using peak detector or quasi-peak detector mode.
4. Data of measurement within this frequency range shown " --- " in the table above means the reading of emissions are attenuated more than 20dB below the permissible limits or the field strength is too small to be measured.
5. The IF bandwidth of SPA between 30MHz to 1GHz was 100kHz.



Above 1 GHz

Operation Mode: TX / IEEE 802.11b / CH Low

Test Date: November 23, 2009

Temperature: 17°C

Tested by: Alonso Lu

Humidity: 51 % RH

Polarity: Ver. / Hor.

Frequency (MHz)	Ant. Pol. (H/V)	Reading (Peak) (dBuV)	Reading (Average) (dBuV)	Correction Factor (dB/m)	Result (Peak) (dBuV/m)	Result (Average) (dBuV/m)	Limit (Peak) (dBuV/m)	Limit (Average) (dBuV/m)	Margin (dB)	Remark
1386.67	V	55.63	---	-5.48	50.15	---	74.00	54.00	-3.85	Peak
2240.00	V	52.43	46.74	0.27	52.70	47.01	74.00	54.00	-6.99	AVG
2330.00	V	56.39	48.54	-0.25	56.15	48.29	74.00	54.00	-5.71	AVG
2490.00	V	58.63	52.69	1.09	59.72	53.78	74.00	54.00	-0.22	AVG
2573.33	V	57.64	52.12	-0.23	57.41	51.89	74.00	54.00	-2.11	AVG
2650.00	V	53.50	44.99	-0.52	52.97	44.47	74.00	54.00	-9.53	AVG
3216.67	V	46.85	---	1.48	48.33	---	74.00	54.00	-5.67	Peak
4825.00	V	48.01	46.08	7.72	55.73	53.80	74.00	54.00	-0.20	AVG
1600.00	H	55.35	---	-5.32	50.03	---	74.00	54.00	-3.97	Peak
1813.33	H	55.54	---	-3.73	51.81	---	74.00	54.00	-2.19	Peak
2026.67	H	53.61	---	-2.43	51.18	---	74.00	54.00	-2.82	Peak
2133.33	H	53.80	---	-1.87	51.93	---	74.00	54.00	-2.07	Peak
2346.67	H	52.55	---	-1.38	51.17	---	74.00	54.00	-2.83	Peak
2493.33	H	51.26	---	-0.62	50.65	---	74.00	54.00	-3.35	Peak
2560.00	H	54.29	48.53	-0.36	53.93	48.17	74.00	54.00	-5.83	AVG
3091.67	H	46.83	---	1.94	48.77	---	74.00	54.00	-5.23	Peak
3308.33	H	46.08	---	3.42	49.50	---	74.00	54.00	-4.50	Peak
3516.67	H	46.93	---	3.39	50.32	---	74.00	54.00	-3.68	Peak
3841.67	H	46.84	45.62	6.44	53.29	52.06	74.00	54.00	-1.94	AVG
4050.00	H	46.65	44.75	8.12	54.78	52.87	74.00	54.00	-1.12	AVG
4266.67	H	45.08	41.89	7.71	52.79	49.60	74.00	54.00	-4.40	AVG
4875.00	H	46.36	44.07	7.35	53.71	51.42	74.00	54.00	-2.58	AVG

Remark:

1. Measuring frequencies from 1 GHz to the 10th harmonic of highest fundamental frequency.
2. Radiated emissions measured in frequency above 1000MHz were made with an instrument using peak/average detector mode.
3. Average test would be performed if the peak result were greater than the average limit or as required by the applicant.
4. Data of measurement within this frequency range shown " --- " in the table above means the reading of emissions are attenuated more than 20dB below the permissible limits or the field strength is too small to be measured.
5. Measurements above show only up to 6 maximum emissions noted, or would be lesser, with " N/A " remark, if no specific emissions from the EUT are recorded (ie: margin>20dB from the applicable limit) and considered that's already beyond the background noise floor.
6. Margin (dB) = Remark result (dBuV/m) – Average limit (dBuV/m).



Operation Mode: TX / IEEE 802.11b / CH Mid

Test Date: November 23, 2009

Temperature: 17°C

Tested by: Alonso Lu

Humidity: 51 % RH

Polarity: Ver. / Hor.

Frequency (MHz)	Ant. Pol. (H/V)	Reading (Peak) (dBuV)	Reading (Average) (dBuV)	Correction Factor (dB/m)	Result (Peak) (dBuV/m)	Result (Average) (dBuV/m)	Limit (Peak) (dBuV/m)	Limit (Average) (dBuV/m)	Margin (dB)	Remark
1386.67	V	55.76	---	-5.48	50.28	---	74.00	54.00	-3.72	Peak
2160.00	V	52.62	---	-0.96	51.66	---	74.00	54.00	-2.34	Peak
2360.00	V	57.27	48.03	-0.30	56.97	47.73	74.00	54.00	-6.27	AVG
2516.67	V	58.35	50.04	0.91	59.26	50.95	74.00	54.00	-3.05	AVG
2600.00	V	58.53	51.43	-0.77	57.76	50.66	74.00	54.00	-3.34	AVG
2676.67	V	53.28	43.39	-0.39	52.89	43.00	74.00	54.00	-11.00	AVG
3250.00	V	47.85	---	1.62	49.46	---	74.00	54.00	-4.54	Peak
4875.00	V	47.21	43.85	7.95	55.17	51.80	74.00	54.00	-2.20	AVG
1600.00	H	54.42	---	-5.32	49.10	---	74.00	54.00	-4.90	Peak
1813.33	H	55.32	---	-3.73	51.59	---	74.00	54.00	-2.41	Peak
2026.67	H	53.10	---	-2.43	50.67	---	74.00	54.00	-3.33	Peak
2133.33	H	52.68	---	-1.87	50.82	---	74.00	54.00	-3.18	Peak
2346.67	H	52.46	---	-1.38	51.08	---	74.00	54.00	-2.92	Peak
2560.00	H	53.05	49.88	-0.36	52.68	49.52	74.00	54.00	-4.75	AVG
2600.00	H	51.86	---	-0.22	51.64	---	74.00	54.00	-2.36	Peak
2773.33	H	51.65	---	-0.20	51.45	---	74.00	54.00	-2.55	Peak
3308.33	H	46.49	---	3.42	49.91	---	74.00	54.00	-4.09	Peak
3516.67	H	47.21	---	3.39	50.61	---	74.00	54.00	-3.39	Peak
3733.33	H	45.77	---	5.62	51.39	---	74.00	54.00	-2.61	Peak
3841.67	H	45.21	---	6.44	51.66	---	74.00	54.00	-2.34	Peak
4050.00	H	45.85	42.01	8.12	53.98	50.13	74.00	54.00	-3.87	AVG
4266.67	H	44.21	---	7.71	51.92	---	74.00	54.00	-2.08	Peak
4875.00	H	46.50	43.24	7.35	53.84	50.59	74.00	54.00	-3.41	AVG

Remark:

1. Measuring frequencies from 1 GHz to the 10th harmonic of highest fundamental frequency.
2. Radiated emissions measured in frequency above 1000MHz were made with an instrument using peak/average detector mode.
3. Average test would be performed if the peak result were greater than the average limit or as required by the applicant.
4. Data of measurement within this frequency range shown " --- " in the table above means the reading of emissions are attenuated more than 20dB below the permissible limits or the field strength is too small to be measured.
5. Measurements above show only up to 6 maximum emissions noted, or would be lesser, with " N/A " remark, if no specific emissions from the EUT are recorded (ie: margin>20dB from the applicable limit) and considered that's already beyond the background noise floor.
6. Margin (dB) = Remark result (dBuV/m) – Average limit (dBuV/m).



Operation Mode: TX / IEEE 802.11b / CH High

Test Date: November 23, 2009

Temperature: 17°C

Tested by: Alonso Lu

Humidity: 51 % RH

Polarity: Ver. / Hor.

Frequency (MHz)	Ant. Pol. (H/V)	Reading (Peak) (dBuV)	Reading (Average) (dBuV)	Correction Factor (dB/m)	Result (Peak) (dBuV/m)	Result (Average) (dBuV/m)	Limit (Peak) (dBuV/m)	Limit (Average) (dBuV/m)	Margin (dB)	Remark
1386.67	V	55.15	---	-5.48	49.67	---	74.00	54.00	-4.33	Peak
2160.00	V	53.72	46.76	-0.96	52.76	45.80	74.00	54.00	-8.20	AVG
2380.00	V	56.84	48.50	-0.33	56.51	48.17	74.00	54.00	-5.83	AVG
2536.67	V	56.37	49.49	0.51	56.88	50.00	74.00	54.00	-4.00	AVG
2623.33	V	57.52	52.11	-0.66	56.86	51.45	74.00	54.00	-2.55	AVG
3283.33	V	48.42	---	1.75	50.17	---	74.00	54.00	-3.83	Peak
4925.00	V	47.32	44.66	7.90	55.22	52.56	74.00	54.00	-1.44	AVG
1280.00	H	54.40	---	-7.11	47.29	---	74.00	54.00	-6.71	Peak
1600.00	H	55.42	---	-5.32	50.10	---	74.00	54.00	-3.90	Peak
1813.33	H	55.18	---	-3.73	51.44	---	74.00	54.00	-2.56	Peak
2026.67	H	53.21	---	-2.43	50.78	---	74.00	54.00	-3.22	Peak
2133.33	H	53.48	---	-1.87	51.62	---	74.00	54.00	-2.38	Peak
2560.00	H	52.56	49.96	-0.36	52.19	49.60	74.00	54.00	-4.40	AVG
2620.00	H	51.58	---	-0.16	51.42	---	74.00	54.00	-2.58	Peak
2773.33	H	51.59	---	-0.20	51.39	---	74.00	54.00	-2.61	Peak
3308.33	H	45.94	---	3.42	49.36	---	74.00	54.00	-4.64	Peak
3525.00	H	47.40	---	3.35	50.75	---	74.00	54.00	-3.25	Peak
3733.33	H	45.77	---	5.62	51.38	---	74.00	54.00	-2.62	Peak
3841.67	H	47.00	43.70	6.44	53.45	50.14	74.00	54.00	-3.86	AVG
4050.00	H	46.04	42.86	8.12	54.16	50.98	74.00	54.00	-3.02	AVG
4266.67	H	44.48	40.35	7.71	52.19	48.06	74.00	54.00	-5.94	AVG
4825.00	H	49.20	44.63	6.92	56.12	51.55	74.00	54.00	-2.45	AVG

Remark:

1. Measuring frequencies from 1 GHz to the 10th harmonic of highest fundamental frequency.
2. Radiated emissions measured in frequency above 1000MHz were made with an instrument using peak/average detector mode.
3. Average test would be performed if the peak result were greater than the average limit or as required by the applicant.
4. Data of measurement within this frequency range shown " --- " in the table above means the reading of emissions are attenuated more than 20dB below the permissible limits or the field strength is too small to be measured.
5. Measurements above show only up to 6 maximum emissions noted, or would be lesser, with " N/A " remark, if no specific emissions from the EUT are recorded (ie: margin>20dB from the applicable limit) and considered that's already beyond the background noise floor.
6. Margin (dB) = Remark result (dBuV/m) – Average limit (dBuV/m).



Operation Mode: TX / IEEE 802.11g / CH Low

Test Date: November 23, 2009

Temperature: 17°C

Tested by: Alonso Lu

Humidity: 51 % RH

Polarity: Ver. / Hor.

Frequency (MHz)	Ant. Pol. (H/V)	Reading (Peak) (dBuV)	Reading (Average) (dBuV)	Correction Factor (dB/m)	Result (Peak) (dBuV/m)	Result (Average) (dBuV/m)	Limit (Peak) (dBuV/m)	Limit (Average) (dBuV/m)	Margin (dB)	Remark
1386.67	V	54.73	---	-5.48	49.24	---	74.00	54.00	-4.76	Peak
2160.00	V	52.70	---	-0.96	51.74	---	74.00	54.00	-2.26	Peak
2336.67	V	53.98	45.82	-0.26	53.72	45.56	74.00	54.00	-8.44	AVG
2490.00	V	56.68	45.70	1.09	57.77	46.79	74.00	54.00	-7.21	AVG
2566.67	V	55.92	44.67	-0.10	55.82	44.57	74.00	54.00	-9.43	AVG
2653.33	V	50.91	---	-0.51	50.40	---	74.00	54.00	-3.60	Peak
3216.67	V	46.98	---	1.48	48.46	---	74.00	54.00	-5.54	Peak
4825.00	V	40.70	---	7.72	48.43	---	74.00	54.00	-5.57	Peak
1386.67	H	55.54	---	-8.34	47.20	---	74.00	54.00	-6.80	Peak
1600.00	H	54.87	---	-5.32	49.55	---	74.00	54.00	-4.45	Peak
1813.33	H	54.89	---	-3.73	51.16	---	74.00	54.00	-2.84	Peak
2133.33	H	53.00	---	-1.87	51.13	---	74.00	54.00	-2.87	Peak
2346.67	H	52.19	---	-1.38	50.81	---	74.00	54.00	-3.19	Peak
2560.00	H	51.79	---	-0.36	51.43	---	74.00	54.00	-2.57	Peak
2773.33	H	50.67	---	-0.20	50.48	---	74.00	54.00	-3.52	Peak
3516.67	H	45.49	---	3.39	48.89	---	74.00	54.00	-5.11	Peak
3841.67	H	45.42	---	6.44	51.87	---	74.00	54.00	-2.13	Peak
4050.00	H	45.28	43.72	8.12	53.40	51.84	74.00	54.00	-2.16	AVG
4266.67	H	43.12	---	7.71	50.82	---	74.00	54.00	-3.18	Peak

Remark:

1. Measuring frequencies from 1 GHz to the 10th harmonic of highest fundamental frequency.
2. Radiated emissions measured in frequency above 1000MHz were made with an instrument using peak/average detector mode.
3. Average test would be performed if the peak result were greater than the average limit or as required by the applicant.
4. Data of measurement within this frequency range shown " --- " in the table above means the reading of emissions are attenuated more than 20dB below the permissible limits or the field strength is too small to be measured.
5. Measurements above show only up to 6 maximum emissions noted, or would be lesser, with " N/A " remark, if no specific emissions from the EUT are recorded (ie: margin>20dB from the applicable limit) and considered that's already beyond the background noise floor.
6. Margin (dB) = Remark result (dBuV/m) – Average limit (dBuV/m).



Operation Mode: TX / IEEE 802.11g / CH Mid

Test Date: November 23, 2009

Temperature: 17°C

Tested by: Alonso Lu

Humidity: 51 % RH

Polarity: Ver. / Hor.

Frequency (MHz)	Ant. Pol. (H/V)	Reading (Peak) (dBuV)	Reading (Average) (dBuV)	Correction Factor (dB/m)	Result (Peak) (dBuV/m)	Result (Average) (dBuV/m)	Limit (Peak) (dBuV/m)	Limit (Average) (dBuV/m)	Margin (dB)	Remark
1386.67	V	55.18	---	-5.48	49.70	---	74.00	54.00	-4.30	Peak
2160.00	V	53.29	45.45	-0.96	52.33	44.49	74.00	54.00	-9.51	AVG
2240.00	V	52.76	46.62	0.27	53.04	46.89	74.00	54.00	-7.11	AVG
2513.33	V	55.03	43.63	0.98	56.01	44.61	74.00	54.00	-9.39	AVG
2593.33	V	54.71	44.07	-0.64	54.08	43.43	74.00	54.00	-10.57	AVG
3250.00	V	47.52	---	1.62	49.14	---	74.00	54.00	-4.86	Peak
1280.00	H	53.91	---	-7.11	46.80	---	74.00	54.00	-7.20	Peak
1386.67	H	54.77	---	-8.34	46.43	---	74.00	54.00	-7.57	Peak
1600.00	H	54.76	---	-5.32	49.44	---	74.00	54.00	-4.56	Peak
1813.33	H	54.71	---	-3.73	50.98	---	74.00	54.00	-3.02	Peak
2026.67	H	52.14	---	-2.43	49.71	---	74.00	54.00	-4.29	Peak
2133.33	H	52.35	---	-1.87	50.49	---	74.00	54.00	-3.51	Peak
2560.00	H	52.90	49.59	-0.36	52.53	49.23	74.00	54.00	-4.77	AVG
2773.33	H	51.14	---	-0.20	50.94	---	74.00	54.00	-3.06	Peak
3516.67	H	45.67	---	3.39	49.07	---	74.00	54.00	-4.93	Peak
3733.33	H	43.39	---	5.62	49.01	---	74.00	54.00	-4.99	Peak
3841.67	H	45.39	---	6.44	51.84	---	74.00	54.00	-2.16	Peak
4050.00	H	45.62	43.34	8.12	53.74	51.47	74.00	54.00	-2.53	AVG
4266.67	H	42.66	---	7.71	50.37	---	74.00	54.00	-3.63	Peak

Remark:

1. Measuring frequencies from 1 GHz to the 10th harmonic of highest fundamental frequency.
2. Radiated emissions measured in frequency above 1000MHz were made with an instrument using peak/average detector mode.
3. Average test would be performed if the peak result were greater than the average limit or as required by the applicant.
4. Data of measurement within this frequency range shown " --- " in the table above means the reading of emissions are attenuated more than 20dB below the permissible limits or the field strength is too small to be measured.
5. Measurements above show only up to 6 maximum emissions noted, or would be lesser, with " N/A " remark, if no specific emissions from the EUT are recorded (ie: margin>20dB from the applicable limit) and considered that's already beyond the background noise floor.
6. Margin (dB) = Remark result (dBuV/m) – Average limit (dBuV/m).



Operation Mode: TX / IEEE 802.11g / CH High

Test Date: November 23, 2009

Temperature: 17°C

Tested by: Alonso Lu

Humidity: 51 % RH

Polarity: Ver. / Hor.

Frequency (MHz)	Ant. Pol. (H/V)	Reading (Peak) (dBuV)	Reading (Average) (dBuV)	Correction Factor (dB/m)	Result (Peak) (dBuV/m)	Result (Average) (dBuV/m)	Limit (Peak) (dBuV/m)	Limit (Average) (dBuV/m)	Margin (dB)	Remark
1386.67	V	55.22	---	-5.48	49.74	---	74.00	54.00	-4.26	Peak
2240.00	V	51.68	---	0.27	51.95	---	74.00	54.00	-2.05	Peak
2376.67	V	54.13	45.86	-0.32	53.80	45.54	74.00	54.00	-8.46	AVG
2536.67	V	53.59	42.85	0.51	54.10	43.36	74.00	54.00	-10.64	AVG
2620.00	V	55.52	44.44	-0.67	54.85	43.77	74.00	54.00	-10.23	AVG
3283.33	V	47.62	---	1.75	49.37	---	74.00	54.00	-4.63	Peak
1280.00	H	53.87	---	-7.11	46.75	---	74.00	54.00	-7.25	Peak
1600.00	H	54.67	---	-5.32	49.35	---	74.00	54.00	-4.65	Peak
1813.33	H	54.65	---	-3.73	50.92	---	74.00	54.00	-3.08	Peak
2026.67	H	53.85	---	-2.43	51.42	---	74.00	54.00	-2.58	Peak
2133.33	H	52.38	---	-1.87	50.52	---	74.00	54.00	-3.48	Peak
2560.00	H	52.72	49.52	-0.36	52.36	49.16	74.00	54.00	-4.84	AVG
2773.33	H	51.29	---	-0.20	51.10	---	74.00	54.00	-2.90	Peak
3516.67	H	45.70	---	3.39	49.09	---	74.00	54.00	-4.91	Peak
3841.67	H	46.45	43.75	6.44	52.89	50.19	74.00	54.00	-3.81	AVG
4050.00	H	44.32	42.18	8.12	52.44	50.30	74.00	54.00	-3.70	AVG
4266.67	H	43.36	---	7.71	51.07	---	74.00	54.00	-2.93	Peak

Remark:

1. Measuring frequencies from 1 GHz to the 10th harmonic of highest fundamental frequency.
2. Radiated emissions measured in frequency above 1000MHz were made with an instrument using peak/average detector mode.
3. Average test would be performed if the peak result were greater than the average limit or as required by the applicant.
4. Data of measurement within this frequency range shown " --- " in the table above means the reading of emissions are attenuated more than 20dB below the permissible limits or the field strength is too small to be measured.
5. Measurements above show only up to 6 maximum emissions noted, or would be lesser, with " N/A " remark, if no specific emissions from the EUT are recorded (ie: margin>20dB from the applicable limit) and considered that's already beyond the background noise floor.
6. Margin (dB) = Remark result (dBuV/m) – Average limit (dBuV/m).



Operation Mode: TX / draft 802.11n 20 MHz Channel mode / CH Low **Test Date:** November 23, 2009

Temperature: 17°C **Tested by:** Alonso Lu

Humidity: 51 % RH **Polarity:** Ver. / Hor.

Frequency (MHz)	Ant. Pol. (H/V)	Reading (Peak) (dBuV)	Reading (Average) (dBuV)	Correction Factor (dB/m)	Result (Peak) (dBuV/m)	Result (Average) (dBuV/m)	Limit (Peak) (dBuV/m)	Limit (Average) (dBuV/m)	Margin (dB)	Remark
1386.67	V	54.23	---	-5.48	48.75	---	74.00	54.00	-5.25	Peak
2160.00	V	52.81	---	-0.96	51.85	---	74.00	54.00	-2.15	Peak
2360.00	V	56.84	46.13	-0.30	56.55	45.83	74.00	54.00	-8.17	AVG
2483.33	V	57.50	45.92	0.98	58.49	46.90	74.00	54.00	-7.10	AVG
2570.00	V	57.89	46.16	-0.16	57.73	46.00	74.00	54.00	-8.00	AVG
2646.67	V	52.29	---	-0.54	51.75	---	74.00	54.00	-2.25	Peak
3216.67	V	46.84	---	1.48	48.32	---	74.00	54.00	-5.68	Peak
4825.00	V	42.91	---	7.72	50.64	---	74.00	54.00	-3.36	Peak
1600.00	H	55.35	---	-5.32	50.03	---	74.00	54.00	-3.97	Peak
1813.33	H	57.00	54.62	-3.73	53.26	50.89	74.00	54.00	-3.11	AVG
2026.67	H	54.21	---	-2.43	51.78	---	74.00	54.00	-2.22	Peak
2133.33	H	53.02	---	-1.87	51.16	---	74.00	54.00	-2.84	Peak
2346.67	H	53.41	48.55	-1.38	52.03	47.17	74.00	54.00	-6.83	AVG
2560.00	H	54.24	49.63	-0.36	53.87	49.27	74.00	54.00	-4.73	AVG
2773.33	H	52.18	---	-0.20	51.98	---	74.00	54.00	-2.02	Peak
3516.67	H	45.79	---	3.39	49.19	---	74.00	54.00	-4.81	Peak
3841.67	H	46.17	44.92	6.44	52.61	51.36	74.00	54.00	-2.64	AVG
4050.00	H	45.94	43.18	8.12	54.07	51.30	74.00	54.00	-2.70	AVG
4266.67	H	43.28	---	7.71	50.99	---	74.00	54.00	-3.01	Peak

Remark:

1. Measuring frequencies from 1 GHz to the 10th harmonic of highest fundamental frequency.
2. Radiated emissions measured in frequency above 1000MHz were made with an instrument using peak/average detector mode.
3. Average test would be performed if the peak result were greater than the average limit or as required by the applicant.
4. Data of measurement within this frequency range shown " --- " in the table above means the reading of emissions are attenuated more than 20dB below the permissible limits or the field strength is too small to be measured.
5. Measurements above show only up to 6 maximum emissions noted, or would be lesser, with " N/A " remark, if no specific emissions from the EUT are recorded (ie: margin>20dB from the applicable limit) and considered that's already beyond the background noise floor.
6. Margin (dB) = Remark result (dBuV/m) – Average limit (dBuV/m).



Operation Mode: TX / draft 802.11n 20 MHz Channel mode / CH Mid **Test Date:** November 23, 2009
Temperature: 17°C **Tested by:** Alonso Lu
Humidity: 51 % RH **Polarity:** Ver. / Hor.

Frequency (MHz)	Ant. Pol. (H/V)	Reading (Peak) (dBuV)	Reading (Average) (dBuV)	Correction Factor (dB/m)	Result (Peak) (dBuV/m)	Result (Average) (dBuV/m)	Limit (Peak) (dBuV/m)	Limit (Average) (dBuV/m)	Margin (dB)	Remark
1813.33	V	50.80	---	-1.88	48.92	---	74.00	54.00	-5.08	Peak
2160.00	V	53.43	47.33	-0.96	52.47	46.37	74.00	54.00	-7.63	AVG
2240.00	V	51.85	46.54	0.27	52.12	46.81	74.00	54.00	-7.19	AVG
2516.67	V	54.65	43.76	0.91	55.56	44.67	74.00	54.00	-9.33	AVG
2593.33	V	54.94	44.80	-0.64	54.30	44.16	74.00	54.00	-9.84	AVG
3250.00	V	47.28	---	1.62	48.90	---	74.00	54.00	-5.10	Peak
4866.67	V	40.51	---	7.92	48.43	---	74.00	54.00	-5.57	Peak
1600.00	H	55.41	---	-5.32	50.09	---	74.00	54.00	-3.91	Peak
1813.33	H	57.46	54.08	-3.73	53.73	50.35	74.00	54.00	-3.65	AVG
2026.67	H	53.23	---	-2.43	50.80	---	74.00	54.00	-3.20	Peak
2133.33	H	52.07	---	-1.87	50.21	---	74.00	54.00	-3.79	Peak
2346.67	H	52.87	---	-1.38	51.49	---	74.00	54.00	-2.51	Peak
2560.00	H	53.08	47.12	-0.36	52.72	46.76	74.00	54.00	-7.24	AVG
2773.33	H	52.33	47.96	-0.20	52.13	47.76	74.00	54.00	-6.24	AVG
3516.67	H	46.40	---	3.39	49.80	---	74.00	54.00	-4.20	Peak
3841.67	H	46.60	45.29	6.44	53.05	51.73	74.00	54.00	-2.27	AVG
4050.00	H	45.01	44.24	8.12	53.14	52.37	74.00	54.00	-1.63	AVG
4266.67	H	43.72	---	7.71	51.42	---	74.00	54.00	-2.58	Peak

Remark:

1. Measuring frequencies from 1 GHz to the 10th harmonic of highest fundamental frequency.
2. Radiated emissions measured in frequency above 1000MHz were made with an instrument using peak/average detector mode.
3. Average test would be performed if the peak result were greater than the average limit or as required by the applicant.
4. Data of measurement within this frequency range shown " --- " in the table above means the reading of emissions are attenuated more than 20dB below the permissible limits or the field strength is too small to be measured.
5. Measurements above show only up to 6 maximum emissions noted, or would be lesser, with " N/A " remark, if no specific emissions from the EUT are recorded (ie: margin>20dB from the applicable limit) and considered that's already beyond the background noise floor.
6. Margin (dB) = Remark result (dBuV/m) – Average limit (dBuV/m).



Operation Mode: TX / draft 802.11n 20 MHz Channel mode / CH High **Test Date:** November 23, 2009
Temperature: 17°C **Tested by:** Alonso Lu
Humidity: 51 % RH **Polarity:** Ver. / Hor.

Frequency (MHz)	Ant. Pol. (H/V)	Reading (Peak) (dBuV)	Reading (Average) (dBuV)	Correction Factor (dB/m)	Result (Peak) (dBuV/m)	Result (Average) (dBuV/m)	Limit (Peak) (dBuV/m)	Limit (Average) (dBuV/m)	Margin (dB)	Remark
2160.00	V	53.14	47.18	-0.96	52.18	46.22	74.00	54.00	-7.78	AVG
2320.00	V	54.10	47.52	-0.23	53.87	47.29	74.00	54.00	-6.71	ACG
2410.00	V	57.18	46.13	-0.20	56.98	45.93	74.00	54.00	-8.07	AVG
2546.67	V	53.67	43.18	0.31	53.98	43.49	74.00	54.00	-10.51	AVG
2623.33	V	54.66	43.79	-0.66	54.00	43.13	74.00	54.00	-10.87	AVG
3283.33	V	47.12	---	1.75	48.87	---	74.00	54.00	-5.13	Peak
4925.00	V	41.26	---	7.90	49.16	---	74.00	54.00	-4.84	Peak
1600.00	H	55.70	---	-5.32	50.38	---	74.00	54.00	-3.62	Peak
1813.33	H	57.42	53.78	-3.73	53.69	50.05	74.00	54.00	-3.95	AVG
2026.67	H	54.10	---	-2.43	51.67	---	74.00	54.00	-2.33	Peak
2133.33	H	53.16	---	-1.87	51.30	---	74.00	54.00	-2.70	Peak
2346.67	H	52.85	---	-1.38	51.47	---	74.00	54.00	-2.53	Peak
2560.00	H	53.71	48.18	-0.36	53.34	47.82	74.00	54.00	-6.18	AVG
2773.33	H	52.15	---	-0.20	51.96	---	74.00	54.00	-2.04	Peak
3516.67	H	45.79	---	3.39	49.18	---	74.00	54.00	-4.82	Peak
3841.67	H	45.51	---	6.44	51.96	---	74.00	54.00	-2.04	Peak
4050.00	H	44.82	42.52	8.12	52.94	50.65	74.00	54.00	-3.35	AVG
4266.67	H	42.65	---	7.71	50.36	---	74.00	54.00	-3.64	Peak
5325.00	H	40.04	---	8.78	48.83	---	74.00	54.00	-5.17	Peak

Remark:

1. Measuring frequencies from 1 GHz to the 10th harmonic of highest fundamental frequency.
2. Radiated emissions measured in frequency above 1000MHz were made with an instrument using peak/average detector mode.
3. Average test would be performed if the peak result were greater than the average limit or as required by the applicant.
4. Data of measurement within this frequency range shown " --- " in the table above means the reading of emissions are attenuated more than 20dB below the permissible limits or the field strength is too small to be measured.
5. Measurements above show only up to 6 maximum emissions noted, or would be lesser, with " N/A " remark, if no specific emissions from the EUT are recorded (ie: margin>20dB from the applicable limit) and considered that's already beyond the background noise floor.
6. Margin (dB) = Remark result (dBuV/m) – Average limit (dBuV/m).



Operation Mode: TX / draft 802.11n 40 MHz Channel mode / CH Low **Test Date:** November 23, 2009
Temperature: 17°C **Tested by:** Alonso Lu
Humidity: 51 % RH **Polarity:** Ver. / Hor.

Frequency (MHz)	Ant. Pol. (H/V)	Reading (Peak) (dBuV)	Reading (Average) (dBuV)	Correction Factor (dB/m)	Result (Peak) (dBuV/m)	Result (Average) (dBuV/m)	Limit (Peak) (dBuV/m)	Limit (Average) (dBuV/m)	Margin (dB)	Remark
1600.00	V	52.68	---	-3.97	48.71	---	74.00	54.00	-5.29	Peak
2160.00	V	52.27	---	-0.96	51.31	---	74.00	54.00	-2.69	Peak
2320.00	V	54.32	46.15	-0.23	54.09	45.92	74.00	54.00	-8.08	AVG
2496.67	V	54.02	44.03	1.20	55.22	45.23	74.00	54.00	-8.77	AVG
2593.33	V	53.42	43.18	-0.64	52.78	42.54	74.00	54.00	-11.46	AVG
3233.33	V	46.35	---	1.55	47.90	---	74.00	54.00	-6.10	Peak
1600.00	H	55.54	---	-5.32	50.22	---	74.00	54.00	-3.78	Peak
1813.33	H	57.05	53.29	-3.73	53.31	49.56	74.00	54.00	-4.44	AVG
2026.67	H	53.08	---	-2.43	50.65	---	74.00	54.00	-3.35	Peak
2133.33	H	52.56	---	-1.87	50.69	---	74.00	54.00	-3.31	Peak
2346.67	H	51.99	---	-1.38	50.61	---	74.00	54.00	-3.39	Peak
2560.00	H	52.57	47.48	-0.36	52.21	47.12	74.00	54.00	-6.88	AVG
2773.33	H	51.48	---	-0.20	51.28	---	74.00	54.00	-2.72	Peak
3516.67	H	46.67	---	3.39	50.06	---	74.00	54.00	-3.94	Peak
3733.33	H	43.22	---	5.62	48.84	---	74.00	54.00	-5.16	Peak
3841.67	H	45.92	---	6.44	52.36	---	74.00	54.00	-1.64	Peak
4050.00	H	46.95	44.03	8.12	55.07	52.16	74.00	54.00	-1.84	AVG
4266.67	H	42.85	---	7.71	50.55	---	74.00	54.00	-3.45	Peak

Remark:

1. Measuring frequencies from 1 GHz to the 10th harmonic of highest fundamental frequency.
2. Radiated emissions measured in frequency above 1000MHz were made with an instrument using peak/average detector mode.
3. Average test would be performed if the peak result were greater than the average limit or as required by the applicant.
4. Data of measurement within this frequency range shown " --- " in the table above means the reading of emissions are attenuated more than 20dB below the permissible limits or the field strength is too small to be measured.
5. Measurements above show only up to 6 maximum emissions noted, or would be lesser, with " N/A " remark, if no specific emissions from the EUT are recorded (ie: margin>20dB from the applicable limit) and considered that's already beyond the background noise floor.
6. Margin (dB) = Remark result (dBuV/m) – Average limit (dBuV/m).



Operation Mode: TX / draft 802.11n 40 MHz Channel mode / CH Mid **Test Date:** November 23, 2009
Temperature: 17°C **Tested by:** Alonso Lu
Humidity: 51 % RH **Polarity:** Ver. / Hor.

Frequency (MHz)	Ant. Pol. (H/V)	Reading (Peak) (dBuV)	Reading (Average) (dBuV)	Correction Factor (dB/m)	Result (Peak) (dBuV/m)	Result (Average) (dBuV/m)	Limit (Peak) (dBuV/m)	Limit (Average) (dBuV/m)	Margin (dB)	Remark
1813.33	V	51.72	---	-1.88	49.84	---	74.00	54.00	-4.16	Peak
2240.00	V	51.77	---	0.27	52.05	---	74.00	54.00	-1.95	Peak
2360.00	V	55.61	44.89	-0.30	55.32	44.59	74.00	54.00	-9.41	AVG
2520.00	V	53.76	43.71	0.85	54.61	44.56	74.00	54.00	-9.44	AVG
2606.67	V	53.60	---	-0.74	52.87	---	74.00	54.00	-1.13	Peak
3250.00	V	47.40	---	1.62	49.02	---	74.00	54.00	-4.98	Peak
1600.00	H	56.87	---	-5.32	51.55	---	74.00	54.00	-2.45	Peak
1813.33	H	56.50	---	-3.73	52.77	---	74.00	54.00	-1.23	Peak
2026.67	H	53.81	---	-2.43	51.38	---	74.00	54.00	-2.62	Peak
2133.33	H	53.47	---	-1.87	51.60	---	74.00	54.00	-2.40	Peak
2346.67	H	52.88	---	-1.38	51.50	---	74.00	54.00	-2.50	Peak
2560.00	H	52.95	---	-0.36	52.58	---	74.00	54.00	-1.42	Peak
3625.00	H	45.46	---	3.47	48.93	---	74.00	54.00	-5.07	Peak
3733.33	H	44.60	---	5.62	50.22	---	74.00	54.00	-3.78	Peak
3841.67	H	46.24	45.14	6.44	52.68	51.58	74.00	54.00	-2.42	AVG
4050.00	H	46.22	44.03	8.12	54.35	52.16	74.00	54.00	-1.84	AVG
4266.67	H	43.79	---	7.71	51.49	---	74.00	54.00	-2.51	Peak

Remark:

1. Measuring frequencies from 1 GHz to the 10th harmonic of highest fundamental frequency.
2. Radiated emissions measured in frequency above 1000MHz were made with an instrument using peak/average detector mode.
3. Average test would be performed if the peak result were greater than the average limit or as required by the applicant.
4. Data of measurement within this frequency range shown " --- " in the table above means the reading of emissions are attenuated more than 20dB below the permissible limits or the field strength is too small to be measured.
5. Measurements above show only up to 6 maximum emissions noted, or would be lesser, with " N/A " remark, if no specific emissions from the EUT are recorded (ie: margin>20dB from the applicable limit) and considered that's already beyond the background noise floor.
6. Margin (dB) = Remark result (dBuV/m) – Average limit (dBuV/m).



Operation Mode: TX / draft 802.11n 40 MHz Channel mode / CH High **Test Date:** November 23, 2009
Temperature: 17°C **Tested by:** Alonso Lu
Humidity: 51 % RH **Polarity:** Ver. / Hor.

Frequency (MHz)	Ant. Pol. (H/V)	Reading (Peak) (dBuV)	Reading (Average) (dBuV)	Correction Factor (dB/m)	Result (Peak) (dBuV/m)	Result (Average) (dBuV/m)	Limit (Peak) (dBuV/m)	Limit (Average) (dBuV/m)	Margin (dB)	Remark
1813.33	V	51.17	---	-1.88	49.29	---	74.00	54.00	-4.71	Peak
2240.00	V	52.32	---	0.27	52.59	---	74.00	54.00	-1.41	Peak
2350.00	V	54.57	43.26	-0.28	54.29	42.98	74.00	54.00	-11.02	AVG
2526.67	V	54.41	43.70	0.71	55.12	44.41	74.00	54.00	-9.59	AVG
2600.00	V	53.28	---	-0.77	52.51	---	74.00	54.00	-1.49	Peak
3266.67	V	47.48	---	1.68	49.16	---	74.00	54.00	-4.84	Peak
4908.33	V	40.09	---	8.01	48.11	---	74.00	54.00	-5.89	Peak
1600.00	H	56.80	---	-5.32	51.48	---	74.00	54.00	-2.52	Peak
1813.33	H	56.09	---	-3.73	52.36	---	74.00	54.00	-1.64	Peak
2026.67	H	53.86	---	-2.43	51.43	---	74.00	54.00	-2.57	Peak
2133.33	H	52.94	---	-1.87	51.07	---	74.00	54.00	-2.93	Peak
2346.67	H	52.77	---	-1.38	51.39	---	74.00	54.00	-2.61	Peak
2560.00	H	52.85	---	-0.36	52.48	---	74.00	54.00	-1.52	Peak
3266.67	H	46.29	---	3.15	49.44	---	74.00	54.00	-4.56	Peak
3516.67	H	45.96	---	3.39	49.35	---	74.00	54.00	-4.65	Peak
3841.67	H	45.90	43.57	6.44	52.34	50.01	74.00	54.00	-3.99	AVG
4050.00	H	46.70	43.79	8.12	54.82	51.91	74.00	54.00	-2.09	AVG
4266.67	H	43.37	---	7.71	51.08	---	74.00	54.00	-2.92	Peak

Remark:

1. Measuring frequencies from 1 GHz to the 10th harmonic of highest fundamental frequency.
2. Radiated emissions measured in frequency above 1000MHz were made with an instrument using peak/average detector mode.
3. Average test would be performed if the peak result were greater than the average limit or as required by the applicant.
4. Data of measurement within this frequency range shown " --- " in the table above means the reading of emissions are attenuated more than 20dB below the permissible limits or the field strength is too small to be measured.
5. Measurements above show only up to 6 maximum emissions noted, or would be lesser, with " N/A " remark, if no specific emissions from the EUT are recorded (ie: margin>20dB from the applicable limit) and considered that's already beyond the background noise floor.
6. Margin (dB) = Remark result (dBuV/m) – Average limit (dBuV/m).



7.7 POWERLINE CONDUCTED EMISSIONS

LIMIT

According to §15.207(a), except as shown in paragraphs (b) and (c) of this section, for an intentional radiator that is designed to be connected to the public utility (AC) power line, the radio frequency voltage that is conducted back onto the AC power line on any frequency or frequencies within the band 150 kHz to 30 MHz shall not exceed the limits in the following table, as measured using a 50 μH/50 ohms line impedance stabilization network (LISN). Compliance with the provisions of this paragraph shall be based on the measurement of the radio frequency voltage between each power line and ground at the power terminal. The lower limit applies at the boundary between the frequency ranges.

Frequency Range (MHz)	Limits (dBμV)	
	Quasi-peak	Average
0.15 to 0.50	66 to 56*	56 to 46*
0.50 to 5	56	46
5 to 30	60	50

* Decreases with the logarithm of the frequency.

TEST CONFIGURATION

See test photographs attached in Appendix II for the actual connections between EUT and support equipment.

TEST PROCEDURE

1. The EUT was placed on a table, which is 0.8m above ground plane.
2. Maximum procedure was performed on the six highest emissions to ensure EUT compliance.
3. Repeat above procedures until all frequency measured were complete.

TEST RESULTS

The initial step in collecting conducted data is a spectrum analyzer peak scan of the measurement range. Significant peaks are then marked as shown on the following data page, and these signals are then quasi-peaked.



TEST DATA

Operation Mode: Normal Link

Test Date: November 23, 2009

Temperature: 22°C

Tested by: Jin Liao

Humidity: 55% RH

Freq. (MHz)	QP Reading	AV Reading	Corr. factor	QP Result	AV Result	QP Limit	AV Limit	QP Margin	AV Margin	Note
0.168	45.03	33.64	11.21	56.24	44.85	65.08	55.08	-8.84	-10.23	L1
0.238	41.00	34.97	10.87	51.87	45.84	62.17	52.17	-10.30	-6.33	L1
0.567	34.98	20.19	10.56	45.54	30.75	56.00	46.00	-10.46	-15.25	L1
0.894	35.29	21.23	10.53	45.82	31.76	56.00	46.00	-10.18	-14.24	L1
1.689	39.11	27.10	10.52	49.63	37.62	56.00	46.00	-6.37	-8.38	L1
2.794	40.98	28.02	10.53	51.51	38.55	56.00	46.00	-4.49	-7.45	L1
0.152	44.84	24.66	10.99	55.83	35.65	65.87	55.87	-10.04	-20.22	L2
0.238	39.06	27.60	10.54	10.54	38.14	62.17	52.17	-51.63	-14.03	L2
0.558	33.73	13.89	10.26	43.99	24.15	56.00	46.00	-12.01	-21.85	L2
0.871	35.54	21.54	10.23	45.77	31.77	56.00	46.00	-10.23	-14.23	L2
1.716	38.30	26.76	10.23	48.53	36.99	56.00	46.00	-7.47	-9.01	L2
2.750	40.75	27.16	10.24	50.99	37.40	56.00	46.00	-5.01	-8.60	L2

Remark:

1. The measuring frequencies range between 0.15 MHz and 30 MHz.
2. The emissions measured in the frequency range between 0.15 MHz and 30MHz were made with an instrument using Quasi-peak detector and Average detector.
3. The IF bandwidth of SPA between 0.15MHz and 30MHz was 10kHz. The IF bandwidth of Test Receiver between 0.15MHz and 30MHz was 9kHz.
4. L1 = Line One (Live Line) / L2 = Line Two (Neutral Line)



Test Plot

Conducted emissions (Line 1)

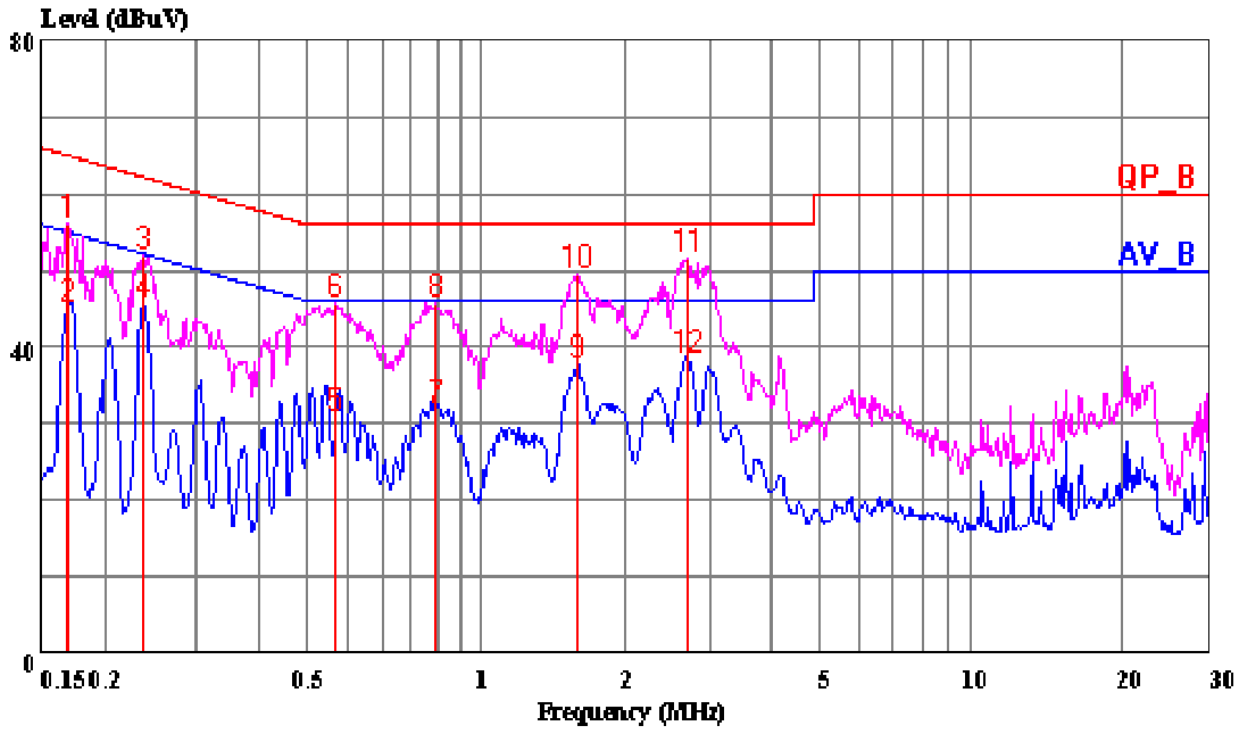

Conducted emissions (Line 2)

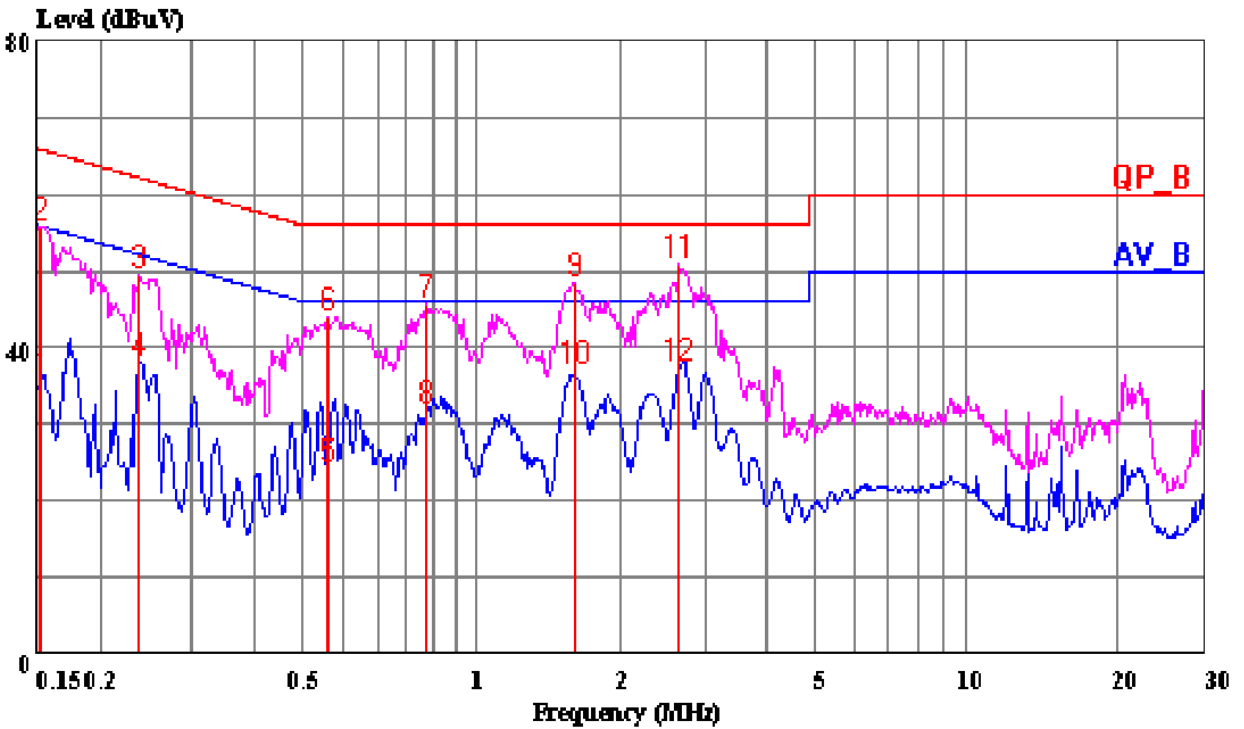



8. APPENDIX I RADIO FREQUENCY EXPOSURE

LIMIT

According to §15.247(i), systems operating under the provisions of this section shall be operated in a manner that ensures that the public is not exposed to radio frequency energy levels in excess of the Commission's guidelines. See § 1.1307(b)(1) of this chapter.

EUT Specification

EUT	Broad Range Wireless Family Router
Frequency band (Operating)	<input checked="" type="checkbox"/> WLAN: 2.412GHz ~ 2.462GHz <input type="checkbox"/> WLAN: 5.18GHz ~ 5.32GHz / 5.50GHz ~ 5.70GHz <input type="checkbox"/> WLAN: 5.745GHz ~ 5.825GHz <input type="checkbox"/> Others
Device category	<input type="checkbox"/> Portable (<20cm separation) <input checked="" type="checkbox"/> Mobile (>20cm separation) <input type="checkbox"/> Others
Exposure classification	<input type="checkbox"/> Occupational/Controlled exposure (S = 5mW/cm ²) <input checked="" type="checkbox"/> General Population/Uncontrolled exposure (S=1mW/cm ²)
Antenna diversity	<input checked="" type="checkbox"/> Single antenna <input type="checkbox"/> Multiple antennas <input type="checkbox"/> Tx diversity <input type="checkbox"/> Rx diversity <input type="checkbox"/> Tx/Rx diversity
Max. output power	IEEE 802.11b mode: 16.80 dBm (47.86mW) IEEE 802.11g mode: 17.60dBm (57.54mW) draft 802.11n 20 MHz Channel mode: 17.47 dBm (55.85mW) draft 802.11n 40 MHz Channel mode: 17.26 dBm (53.21mW)
Antenna gain (Max)	2.25dBi (including cable loss) (Numeric gain: 1.68)
Evaluation applied	<input checked="" type="checkbox"/> MPE Evaluation <input type="checkbox"/> SAR Evaluation <input type="checkbox"/> N/A

Remark:

- The maximum output power is 17.60dBm (57.54mW) at 2437MHz (with 1.68numeric antenna gain.)
- For mobile or fixed location transmitters, no SAR consideration applied. The maximum power density is 1.0 mW/cm² even if the calculation indicates that the power density would be larger.

TEST RESULTS

No non-compliance noted.



Calculation

Given $E = \frac{\sqrt{30 \times P \times G}}{d}$ & $S = \frac{E^2}{3770}$

Where $E =$ Field strength in Volts / meter

$P =$ Power in Watts

$G =$ Numeric antenna gain

$d =$ Distance in meters

$S =$ Power density in milliwatts / square centimeter

Combining equations and re-arranging the terms to express the distance as a function of the remaining variables yields:

$$S = \frac{30 \times P \times G}{3770d^2}$$

Changing to units of mW and cm, using:

$$P (mW) = P (W) / 1000 \text{ and}$$

$$d (cm) = d(m) / 100$$

Yields

$$S = \frac{30 \times (P/1000) \times G}{3770 \times (d/100)^2} = 0.0796 \times \frac{P \times G}{d^2} \quad \text{Equation 1}$$

Where $d =$ Distance in cm

$P =$ Power in mW

$G =$ Numeric antenna gain

$S =$ Power density in mW / cm²

Maximum Permissible Exposure

EUT output power = 57.54mW

Numeric Antenna gain = 1.68

Substituting the MPE safe distance using $d = 20$ cm into Equation 1:

Yields

$$S = 0.000199 \times P \times G$$

Where $P =$ Power in mW

$G =$ Numeric antenna gain

$S =$ Power density in mW / cm²

→ Power density = 0.019 mW / cm²

(For mobile or fixed location transmitters, the maximum power density is 1.0 mW/cm² even if the calculation indicates that the power density would be larger.)