

# TEST REPORT

## CERTIFICATE OF CONFORMITY

**Standard:** 47 CFR FCC Part 15, Subpart E (Section 15.407)  
**Report No.:** RFBFLF-WTW-P23030480-1  
**FCC ID:** MSQ-RTAX6Q00  
**Product:** Wireless-AX3000 Dual-band Router  
**Brand:** ASUS  
**Model No.:** EBR63  
**Received Date:** 2023/3/21  
**Test Date:** 2023/3/21 ~ 2023/6/19  
**Issued Date:** 2023/7/11

**Applicant:** ASUSTeK COMPUTER INC.  
**Address:** 1F., No. 15, Lide Rd., Beitou Dist., Taipei City 112, Taiwan  
**Issued By:** Bureau Veritas Consumer Products Services (H.K.) Ltd., Taoyuan Branch  
Lin Kou Laboratories  
**Lab Address:** No. 47-2, 14th Ling, Chia Pau Vil., Lin Kou Dist., New Taipei City, Taiwan  
**Test Location:** No. 19, Hwa Ya 2nd Rd., Wen Hwa Vil., Kewi Shan Dist., Taoyuan City 33383, Taiwan

**FCC Registration /** 788550 / TW0003  
**Designation Number:**

Approved by: \_\_\_\_\_

*Jeremy Lin*

, Date: \_\_\_\_\_

2023/7/11

Jeremy Lin / Project Engineer

This test report consists of 138 pages in total. It may be duplicated completely for legal use with the approval of the applicant. It should not be reproduced except in full, without the written approval of our laboratory. The test results in the report only apply to the tested sample. The test results in this report are traceable to the national or international standards.



Prepared by : Vera Huang / Specialist

This report is governed by, and incorporates by reference, the Conditions of Testing as posted at the date of issuance of this report at <http://www.bureauveritas.com/home/about-us/our-business/cps/about-us/terms-conditions/> and is intended for your exclusive use. Any copying or replication of this report to or for any other person or entity, or use of our name or trademark, is permitted only with our prior written permission. This report sets forth our findings solely with respect to the test samples identified herein. The results set forth in this report are not indicative or representative of the quality or characteristics of the lot from which a test sample was taken or any similar or identical product unless specifically and expressly noted. Our report includes all of the tests requested by you and the results thereof based upon the information that you provided to us. Measurement uncertainty is only provided upon request for accredited tests. Statements of conformity are based on simple acceptance criteria without taking measurement uncertainty into account, unless otherwise requested in writing. You have 60 days from date of issuance of this report to notify us of any material error or omission caused by our negligence or if you require measurement uncertainty; provided, however, that such notice shall be in writing and shall specifically address the issue you wish to raise. A failure to raise such issue within the prescribed time shall constitute your unqualified acceptance of the completeness of this report, the tests conducted and the correctness of the report contents.

## Table of Contents

<b>Release Control Record</b> .....	<b>4</b>
<b>1 Certificate</b> .....	<b>5</b>
<b>2 Summary of Test Results</b> .....	<b>6</b>
2.1 Measurement Uncertainty .....	6
2.2 Supplementary Information .....	6
<b>3 General Information</b> .....	<b>7</b>
3.1 General Description of EUT .....	7
3.2 Antenna Description of EUT .....	9
3.3 Channel List .....	10
3.4 Test Mode Applicability and Tested Channel Detail .....	12
3.5 Duty Cycle of Test Signal .....	14
3.6 Test Program Used and Operation Descriptions .....	16
3.7 Connection Diagram of EUT and Peripheral Devices .....	16
3.8 Configuration of Peripheral Devices and Cable Connections .....	16
<b>4 Test Instruments</b> .....	<b>17</b>
4.1 26 dB Bandwidth .....	17
4.2 RF Output Power .....	17
4.3 Power Spectral Density .....	17
4.4 6 dB Bandwidth .....	17
4.5 Occupied Bandwidth .....	17
4.6 Frequency Stability .....	18
4.7 AC Power Conducted Emissions .....	18
4.8 Unwanted Emissions below 1 GHz .....	19
4.9 Unwanted Emissions above 1 GHz .....	20
<b>5 Limits of Test Items</b> .....	<b>21</b>
5.1 26 dB Bandwidth .....	21
5.2 RF Output Power .....	21
5.3 Power Spectral Density .....	21
5.4 6 dB Bandwidth .....	22
5.5 Occupied Bandwidth .....	22
5.6 Frequency Stability .....	22
5.7 AC Power Conducted Emissions .....	22
5.8 Unwanted Emissions below 1 GHz .....	22
5.9 Unwanted Emissions above 1 GHz .....	23
<b>6 Test Arrangements</b> .....	<b>24</b>
6.1 26 dB Bandwidth .....	24
6.1.1 Test Setup .....	24
6.1.2 Test Procedure .....	24
6.2 RF Output Power .....	25
6.2.1 Test Setup .....	25
6.2.2 Test Procedure .....	25
6.3 Power Spectral Density .....	26
6.3.1 Test Setup .....	26
6.3.2 Test Procedure .....	26
6.4 6 dB Bandwidth .....	26
6.4.1 Test Setup .....	26
6.4.2 Test Procedure .....	26
6.5 Occupied Bandwidth .....	27
6.5.1 Test Setup .....	27
6.5.2 Test Procedure .....	27
6.6 Frequency Stability .....	27
6.6.1 Test Setup .....	27
6.6.2 Test Procedure .....	27
6.7 AC Power Conducted Emissions .....	28



6.7.1	Test Setup .....	28
6.7.2	Test Procedure.....	28
6.8	Unwanted Emissions below 1 GHz .....	29
6.8.1	Test Setup .....	29
6.8.2	Test Procedure.....	30
6.9	Unwanted Emissions above 1 GHz.....	31
6.9.1	Test Setup .....	31
6.9.2	Test Procedure.....	31
<b>7</b>	<b>Test Results of Test Item .....</b>	<b>32</b>
7.1	26 dB Bandwidth .....	32
7.2	RF Output Power.....	37
7.3	Power Spectral Density .....	48
7.4	6 dB Bandwidth .....	56
7.5	Occupied Bandwidth.....	58
7.6	Frequency Stability .....	64
7.7	AC Power Conducted Emissions .....	65
7.8	Unwanted Emissions below 1 GHz .....	69
7.9	Unwanted Emissions above 1 GHz.....	73
<b>8</b>	<b>Pictures of Test Arrangements .....</b>	<b>137</b>
<b>9</b>	<b>Information of the Testing Laboratories .....</b>	<b>138</b>



## Release Control Record

Issue No.	Description	Date Issued
RFBFLF-WTW-P23030480-1	Original Release	2023/7/11

## 1 Certificate

**Product:** Wireless-AX3000 Dual-band Router

**Brand:** ASUS

**Test Model:** EBR63

**Sample Status:** Engineering Sample

**Applicant:** ASUSTeK COMPUTER INC.

**Test Date:** 2023/3/21 ~ 2023/6/19

**Standard:** 47 CFR FCC Part 15, Subpart E (Section 15.407)

**Measurement procedure:** ANSI C63.10-2013  
KDB 789033 D02 General UNII Test Procedure New Rules v02r01  
KDB 662911 D01 Multiple Transmitter Output v02r01

The above equipment has been tested by **Bureau Veritas Consumer Products Services (H.K.) Ltd., Taoyuan Branch**, and found compliance with the requirement of the above standards. The test record, data evaluation & Equipment Under Test (EUT) configurations represented herein are true and accurate accounts of the measurements of the sample's RF characteristics under the conditions specified in this report.

## 2 Summary of Test Results

47 CFR FCC Part 15, Subpart E (Section 15.407)			
Clause	Test Item	Result	Remark
15.407(a)(2)	26 dB Bandwidth	Pass	For U-NII-2A U-NII-2C Band output power limitation is determined based on 26dBc bandwidth.
15.407(a)(1) 15.407(a)(2)	RF Output Power	Pass	Meet the requirement of limit.
15.407(a)(1) 15.407(a)(2)	Power Spectral Density	Pass	Meet the requirement of limit.
15.407(e)	6 dB Bandwidth	Pass	Meet the requirement of limit. (U-NII-3 Band only)
---	Occupied Bandwidth	-	Reference only.
15.407(g)	Frequency Stability	Pass	Meet the requirement of limit.
15.407(b)(9)	AC Power Conducted Emissions	Pass	Minimum passing margin is -14.84 dB at 16.69400 MHz
15.407(b)(9)	Unwanted Emissions below 1 GHz	Pass	Minimum passing margin is -4.0 dB at 63.95 MHz
15.407(b) (1/10) 15.407(b) (2/10)	Unwanted Emissions above 1 GHz	Pass	Minimum passing margin is -0.2 dB at 5150.00 MHz
15.203	Antenna Requirement	Pass	Antenna connector is IPEX not a standard connector.

Note: Determining compliance based on the results of the compliance measurement, not taking into account measurement instrumentation uncertainty.

### 2.1 Measurement Uncertainty

Where relevant, the following measurement uncertainty levels have been estimated for tests performed on the EUT as specified in CISPR 16-4-2:

Measurement	Specification	Expanded Uncertainty (k=2) (±)
Occupied Bandwidth	-	491.896 Hz
AC Power Conducted Emissions	9 kHz ~ 30 MHz	2.99 dB
Unwanted Emissions below 1 GHz	9 kHz ~ 30 MHz	3.59 dB
	30 MHz ~ 1 GHz	3.6 dB
Unwanted Emissions above 1 GHz	1 GHz ~ 18 GHz	2.29 dB
	18 GHz ~ 40 GHz	2.29 dB

The other instruments specified are routine verified to remain within the calibrated levels, no measurement uncertainty is required to be calculated.

### 2.2 Supplementary Information

There is not any deviation from the test standards for the test method, and no modifications required for compliance.

### 3 General Information

#### 3.1 General Description of EUT

Product	Wireless-AX3000 Dual-band Router
Brand	ASUS
Test Model	EBR63
Status of EUT	Engineering sample
Power Supply Rating	Refer to Note
Modulation Type	256QAM, 64QAM, 16QAM, QPSK, BPSK for OFDM 1024QAM, 256QAM, 64QAM, 16QAM, QPSK, BPSK for OFDMA
Modulation Technology	OFDM, OFDMA
Transfer Rate	802.11a: 54/48/36/24/18/12/9/6 Mbps 802.11n: up to 300 Mbps 802.11ac: up to 1733.3 Mbps 802.11ax: up to 2402 Mbps
Operating Frequency	5180 ~ 5320 MHz, 5500 ~ 5720 MHz, 5745 ~ 5825 MHz
Number of Channel	5180 ~ 5320 MHz: 802.11a, 802.11n (HT20), 802.11ac (VHT20), 802.11ax (HE20): 8 802.11n (HT40), 802.11ac (VHT40), 802.11ax (HE40): 4 802.11ac (VHT80), 802.11ax (HE80): 2 802.11ac (VHT160), 802.11ax (HE160): 1 5500 ~ 5720 MHz: 802.11a, 802.11n (HT20), 802.11ac (VHT20), 802.11ax (HE20): 12 802.11n (HT40), 802.11ac (VHT40), 802.11ax (HE40): 6 802.11ac (VHT80), 802.11ax (HE80): 3 802.11ac (VHT160), 802.11ax (HE160): 1 5745 ~ 5825 MHz: 802.11a, 802.11n (HT20), 802.11ac (VHT20), 802.11ax (HE20): 5 802.11n (HT40), 802.11ac (VHT40), 802.11ax (HE40): 2 802.11ac (VHT80), 802.11ax (HE80): 1
Output Power	CDD Mode: 5180 ~ 5250 MHz: 965.058 mW (29.85 dBm) 5250 ~ 5320 MHz: 243.346 mW (23.86 dBm) 5500 ~ 5720 MHz: 247.724 mW (23.94 dBm) 5745 ~ 5825 MHz: 949.05 mW (29.77 dBm) Beamforming Mode: 5180 ~ 5250 MHz: 950.761 mW (29.78 dBm) 5250 ~ 5320 MHz: 234.71 mW (23.71 dBm) 5500 ~ 5720 MHz: 247.724 mW (23.94 dBm) 5745 ~ 5825 MHz: 949.05 mW (29.77 dBm)
EUT Category	Indoor Access Point

Note:

1. The EUT uses following accessories.

<b>AC Adapter 1</b>		
Brand	Model	Specification
CHENZHOU FRECOM ELECTRONICS CO., LTD.	F24L6-120200SPAU	AC Input : 100-240Vac, 50-60Hz, 0.6A DC Output : 12Vdc, 2A. DC Output Cable : 1.5m without core, wo shielding Plug : US plug Manufacturer : CHENZHOU FRECOM ELECTRONICS CO., LTD.
<b>AC Adapter 2</b>		
Brand	Model	Specification
Shenzhen Keyu Power Supply Technology Co., Ltd.	KA2401A-1202000DE	AC Input : 100-240Vac, 50/60Hz, 0.65A DC Output : 12Vdc, 2A. DC Output Cable : 1.5m without core, wo shielding Plug : EU/UK/AU/US plug Manufacturer : Shenzhen Keyu Power Supply Technology Co., Ltd.
<b>AC Adapter 3</b>		
Brand	Model	Specification
Shenzhen Keyu Power Supply Technology Co., Ltd.	KA2401A-1202000US	AC Input : 100-240Vac, 50-60Hz, 0.65A DC Output : 12Vdc, 2A. DC Output Cable : 1.5m without core, wo shielding Plug : US plug Manufacturer : Shenzhen Keyu Power Supply Technology Co., Ltd.

\*The adapter 1 & 3 was chosen for final test.

2. The above EUT information is declared by manufacturer and for more detailed features description, please refer to the manufacturer's specifications or user's manual.



### 3.2 Antenna Description of EUT

1. The antenna information is listed as below.

Antenna No.	Brand	Model	Antenna Net Gain(dBi)	Frequency range	Antenna Type	Connector Type
1	XINGSHENG	SSR-2303020	3	5.15~5.85GHz	Dipole	IPEX
2	XINGSHENG	SSR-2303021	3	5.15~5.85GHz	Dipole	IPEX

\* Detail antenna specification please refer to antenna datasheet and/or antenna measurement report.

2. The EUT incorporates a MIMO function:

5 GHz Band		
Modulation Mode	TX & RX Configuration	
802.11a	2TX	2RX
802.11n (HT20)	2TX	2RX
802.11n (HT40)	2TX	2RX
802.11ac (VHT20)	2TX	2RX
802.11ac (VHT40)	2TX	2RX
802.11ac (VHT80)	2TX	2RX
802.11ac (VHT160)	2TX	2RX
802.11ax (HE20)	2TX	2RX
802.11ax (HE40)	2TX	2RX
802.11ax (HE80)	2TX	2RX
802.11ax (HE160)	2TX	2RX

Note:

- All of modulation mode support beamforming function except 802.11a modulation mode.
- The EUT support Beamforming and CDD mode, therefore both mode were investigated and the worst case scenario was identified. The worst case data were presented in test report.
- The modulation and bandwidth are similar for 802.11n mode for 20 MHz (40 MHz), 802.11ac mode for 20 MHz (40 MHz, 80 MHz, 160 MHz), and 802.11ax mode for 20 MHz (40 MHz, 80 MHz, 160 MHz), therefore the manufacturer will control the power for 802.11n/ac mode is same as the 802.11ax mode or more lower than it and investigated worst case to representative mode in test report.
- The EUT supports full RU only.

### 3.3 Channel List

#### For 5180 ~ 5320 MHz

8 channels are provided for 802.11a, 802.11n (HT20), 802.11ac (VHT20) and 802.11ax (HE20):

Channel	Frequency	Channel	Frequency
36	5180 MHz	44	5220 MHz
40	5200 MHz	48	5240 MHz
52	5260 MHz	60	5300 MHz
56	5280 MHz	64	5320 MHz

4 channels are provided for 802.11n (HT40), 802.11ac (VHT40) and 802.11ax (HE40):

Channel	Frequency	Channel	Frequency
38	5190 MHz	46	5230 MHz
54	5270 MHz	62	5310 MHz

2 channels are provided for 802.11ac (VHT80), 802.11ax (HE80):

Channel	Frequency	Channel	Frequency
42	5210MHz	58	5290MHz

1 channel is provided for 802.11ac (VHT160), 802.11ax (HE160):

Channel	Frequency
50	5250MHz

#### For 5500 ~ 5720 MHz

12 channels are provided for 802.11a, 802.11n (HT20), 802.11ac (VHT20) and 802.11ax (HE20):

Channel	Frequency	Channel	Frequency
100	5500 MHz	124	5620 MHz
104	5520 MHz	128	5640 MHz
108	5540 MHz	132	5660 MHz
112	5560 MHz	136	5680 MHz
116	5580 MHz	140	5700 MHz
120	5600 MHz	144	5720 MHz

6 channels are provided for 802.11n (HT40), 802.11ac (VHT40) and 802.11ax (HE40):

Channel	Frequency	Channel	Frequency
102	5510 MHz	126	5630 MHz
110	5550 MHz	134	5670 MHz
118	5590 MHz	142	5710 MHz

3 channels are provided for 802.11ac (VHT80) and 802.11ax (HE80):

Channel	Frequency	Channel	Frequency
106	5530 MHz	138	5690 MHz
122	5610 MHz		

1 channel is provided for 802.11ac (VHT160), 802.11ax (HE160):

Channel	Frequency
114	5570MHz

**For 5745 ~ 5825 MHz:**

5 channels are provided for 802.11a, 802.11n (HT20), 802.11ac (VHT20) and 802.11ax (HE20):

Channel	Frequency	Channel	Frequency
149	5745 MHz	161	5805 MHz
153	5765 MHz	165	5825 MHz
157	5785 MHz		

2 channels are provided for 802.11n (HT40), 802.11ac (VHT40) and 802.11ax (HE40):

Channel	Frequency	Channel	Frequency
151	5755 MHz	159	5795 MHz

1 channel is provided for 802.11ac (VHT80) and 802.11ax (HE80):

Channel	Frequency
155	5775 MHz

### 3.4 Test Mode Applicability and Tested Channel Detail

Pre-Scan:	EUT can be used in the following ways: X-axis/ Y-axis/ Z-axis. Pre-scan these ways and find the worst case as a representative test condition.
Worst Case:	Z-AXIS (LAN port left)
EUT Configure Mode:	Mode A: Powered by Adapter 1 Mode B: Powered by Adapter 3

Following channel(s) was (were) selected for the final test as listed below:

Test Item	EUT Configure Mode	Mode	Signal Mode	Tested Channel	Modulation	Data Rate Parameter
26 dB Bandwidth	A	802.11a	CDD	52, 60, 64, 100, 116, 140, 144	BPSK	6Mb/s
		802.11ax (HE20)	CDD	52, 60, 64, 100, 116, 140, 144	BPSK	MCS0
		802.11ax (HE40)	CDD	54, 62, 102, 110, 134, 142	BPSK	MCS0
		802.11ax (HE80)	CDD	58, 106, 122, 138	BPSK	MCS0
		802.11ax (HE160)	CDD	50, 114	BPSK	MCS0
RF Output Power	A	802.11a	CDD	36, 40, 48, 52, 60, 64, 100, 116, 140, 144, 149, 157, 165	BPSK	6Mb/s
		802.11ax (HE20)	CDD & Beamforming	36, 40, 48, 52, 60, 64, 100, 116, 140, 144, 149, 157, 165	BPSK	MCS0
		802.11ax (HE40)	CDD & Beamforming	38, 46, 54, 62, 102, 110, 134, 142, 151, 159	BPSK	MCS0
		802.11ax (HE80)	CDD & Beamforming	42, 58, 106, 122, 138, 155	BPSK	MCS0
		802.11ax (HE160)	CDD & Beamforming	50, 114	BPSK	MCS0
Power Spectral Density	A	802.11a	CDD	36, 40, 48, 52, 60, 64, 100, 116, 140, 144, 149, 157, 165	BPSK	6Mb/s
		802.11ax (HE20)	CDD	36, 40, 48, 52, 60, 64, 100, 116, 140, 144, 149, 157, 165	BPSK	MCS0
		802.11ax (HE40)	CDD	38, 46, 54, 62, 102, 110, 134, 142, 151, 159	BPSK	MCS0
		802.11ax (HE80)	CDD	42, 58, 106, 122, 138, 155	BPSK	MCS0
		802.11ax (HE160)	CDD	50, 114	BPSK	MCS0
6 dB Bandwidth	A	802.11a	CDD	144, 149, 157, 165	BPSK	6Mb/s
		802.11ax (HE20)	CDD	144, 149, 157, 165	BPSK	MCS0
		802.11ax (HE40)	CDD	142, 151, 159	BPSK	MCS0
		802.11ax (HE80)	CDD	138, 155	BPSK	MCS0

Test Item	EUT Configure Mode	Mode	Signal Mode	Tested Channel	Modulation	Data Rate Parameter
Occupied Bandwidth	A	802.11a	CDD	36, 40, 48, 52, 60, 64, 100, 116, 140, 144, 149, 157, 165	BPSK	6Mb/s
		802.11ax (HE20)	CDD	36, 40, 48, 52, 60, 64, 100, 116, 140, 144, 149, 157, 165	BPSK	MCS0
		802.11ax (HE40)	CDD	38, 46, 54, 62, 102, 110, 134, 142, 151, 159	BPSK	MCS0
		802.11ax (HE80)	CDD	42, 58, 106, 122, 138, 155	BPSK	MCS0
		802.11ax (HE160)	CDD	50, 114	BPSK	MCS0
Frequency Stability	A	802.11a	CDD	36	un-modulation	-
AC Power Conducted Emissions	A, B	802.11a	CDD	48	BPSK	6Mb/s
Unwanted Emissions below 1 GHz	A, B	802.11a	CDD	48	BPSK	6Mb/s
Unwanted Emissions above 1 GHz	A	802.11a	CDD	36, 40, 48, 52, 60, 64, 100, 116, 140, 144, 149, 157, 165	BPSK	6Mb/s
		802.11ax (HE20)	CDD	36, 40, 48, 52, 60, 64, 100, 116, 140, 144, 149, 157, 165	BPSK	MCS0
		802.11ax (HE40)	CDD	38, 46, 54, 62, 102, 110, 134, 142, 151, 159	BPSK	MCS0
		802.11ax (HE80)	CDD	42, 58, 106, 122, 138, 155	BPSK	MCS0
		802.11ax (HE160)	CDD	50, 114	BPSK	MCS0

### 3.5 Duty Cycle of Test Signal

**802.11a:** Duty cycle = 5.11 ms / 5.13 ms x 100% = 99.6%

**802.11ax (HE20):** Duty cycle = 3.07 ms / 3.08 ms x 100% = 99.7%

**802.11ax (HE40):** Duty cycle = 3.07 ms / 3.08 ms x 100% = 99.7%

**802.11ax (HE80):** Duty cycle = 3.05 ms / 3.06 ms x 100% = 99.7%

**802.11ax (HE160):** Duty cycle = 3.01 ms / 3.02 ms x 100% = 99.7%

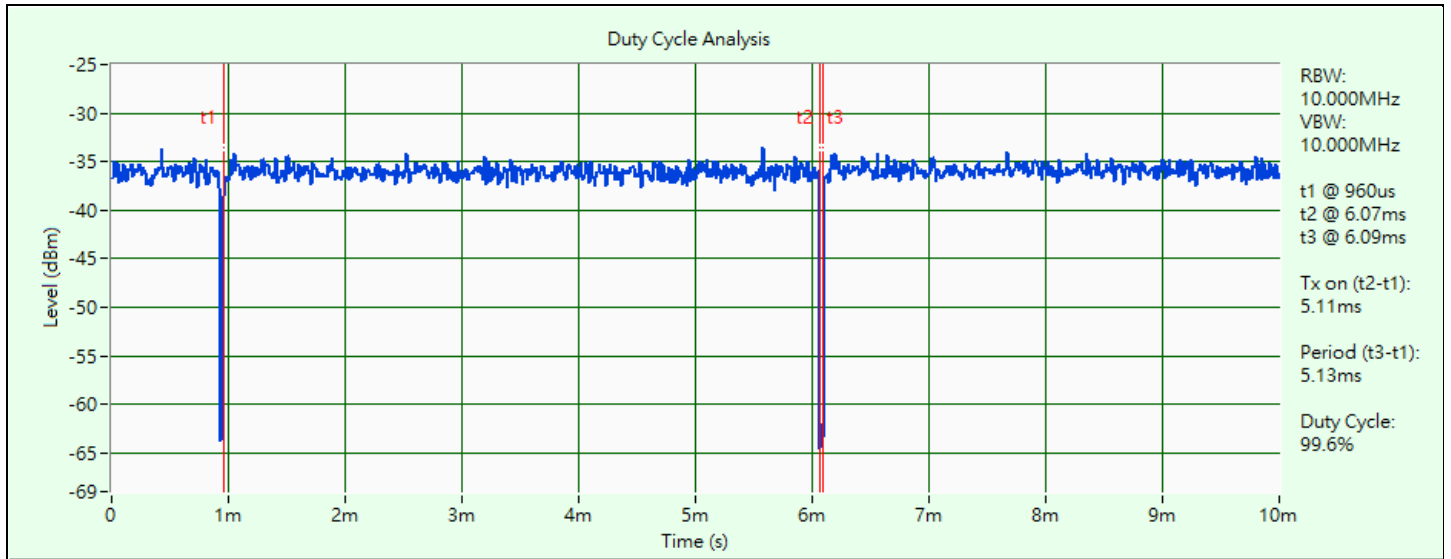

802.11a

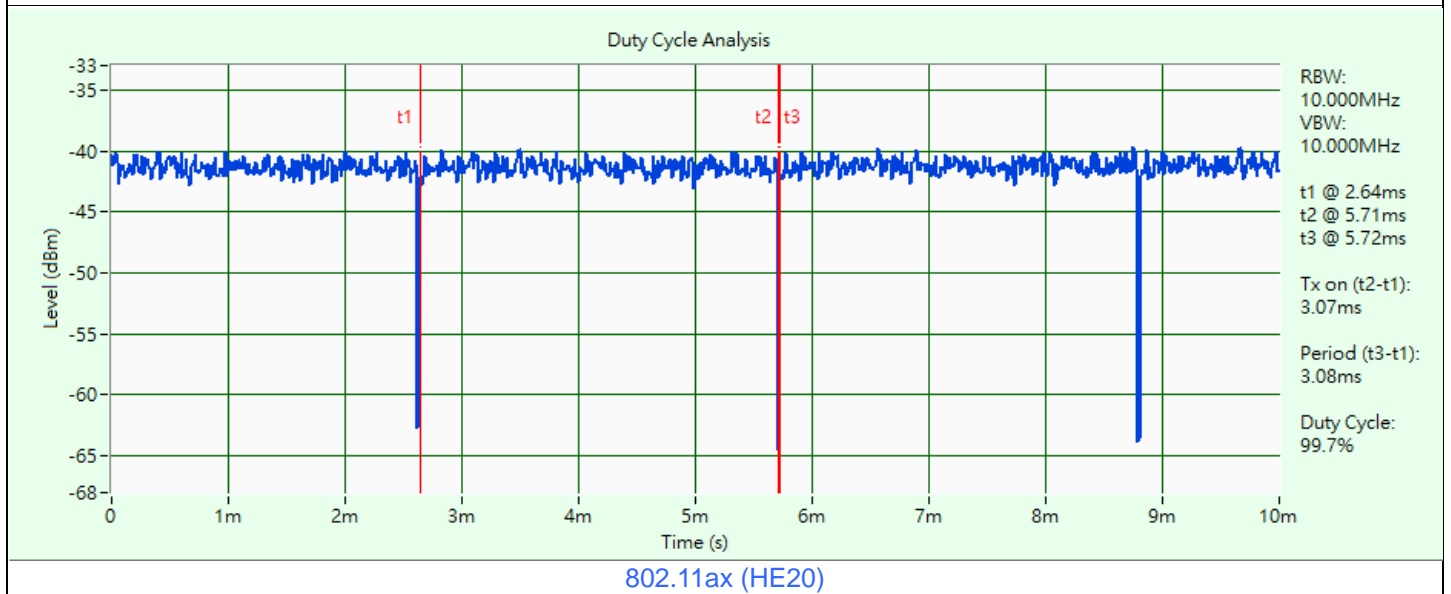

802.11ax (HE20)

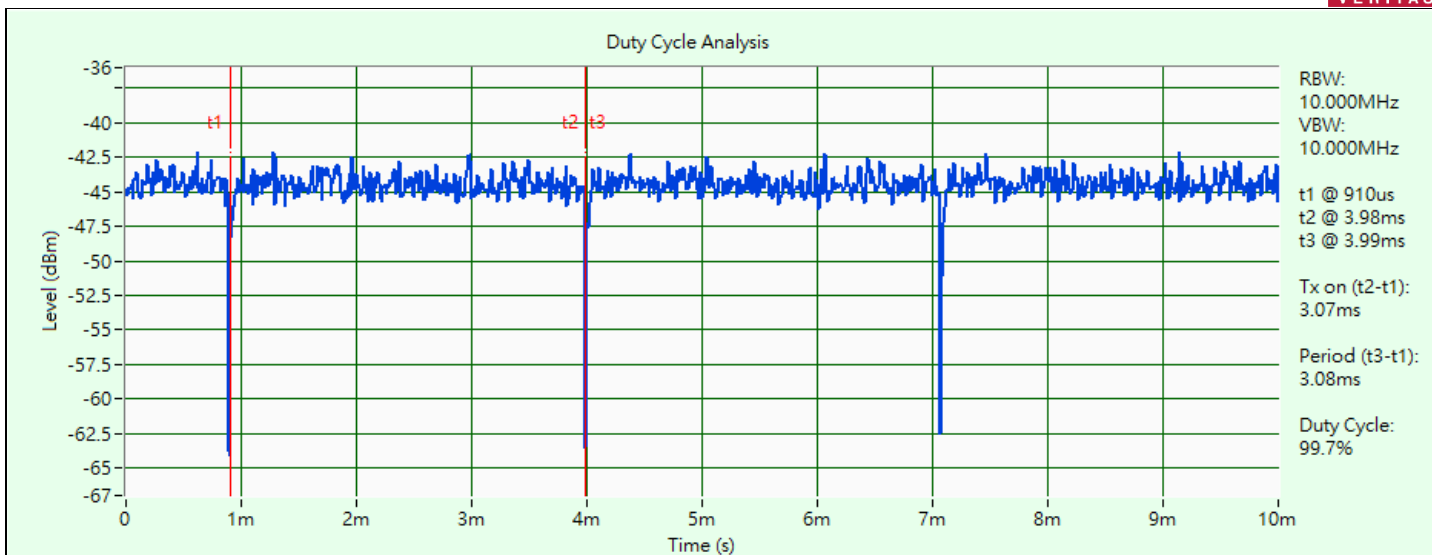

802.11ax (HE40)

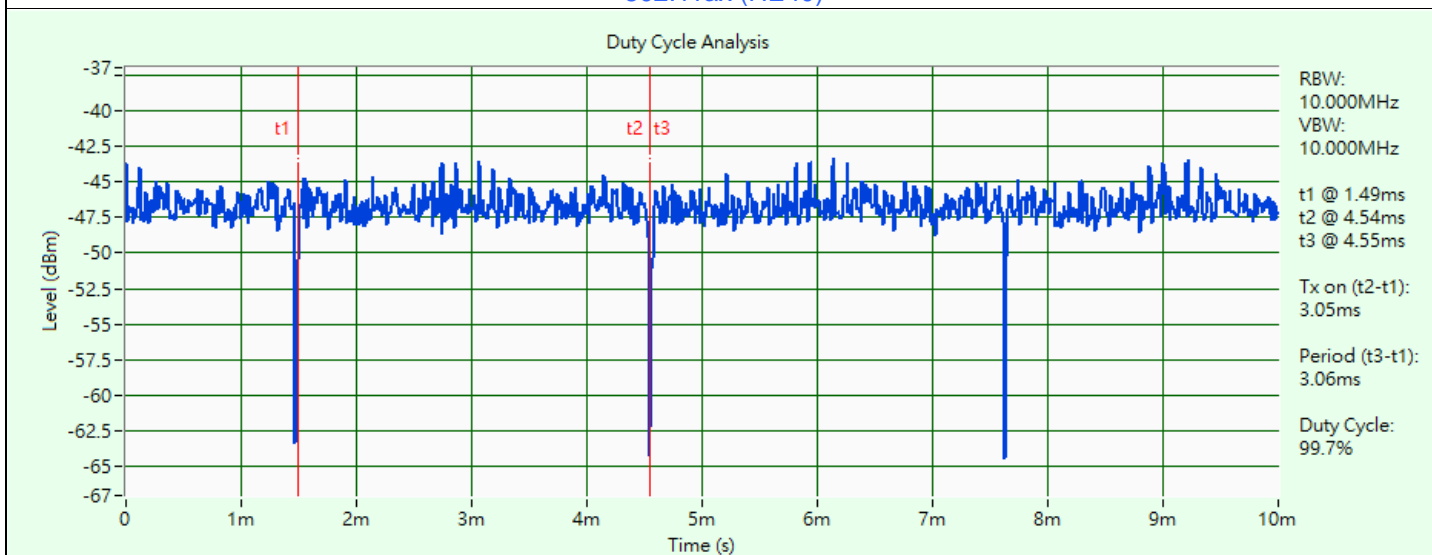

802.11ax (HE80)

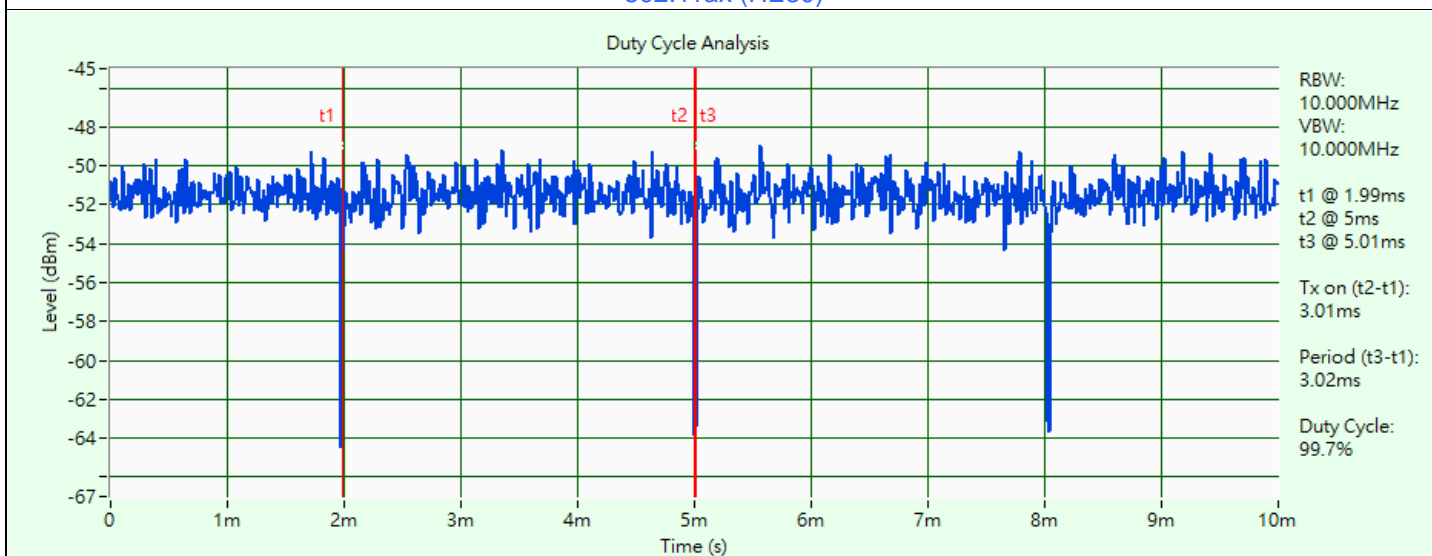

802.11ax (HE160)

### 3.6 Test Program Used and Operation Descriptions

Controlling software accessMTool\_REL\_3\_2\_1\_5 has been activated to set the EUT under transmission condition continuously at specific channel frequency.

### 3.7 Connection Diagram of EUT and Peripheral Devices

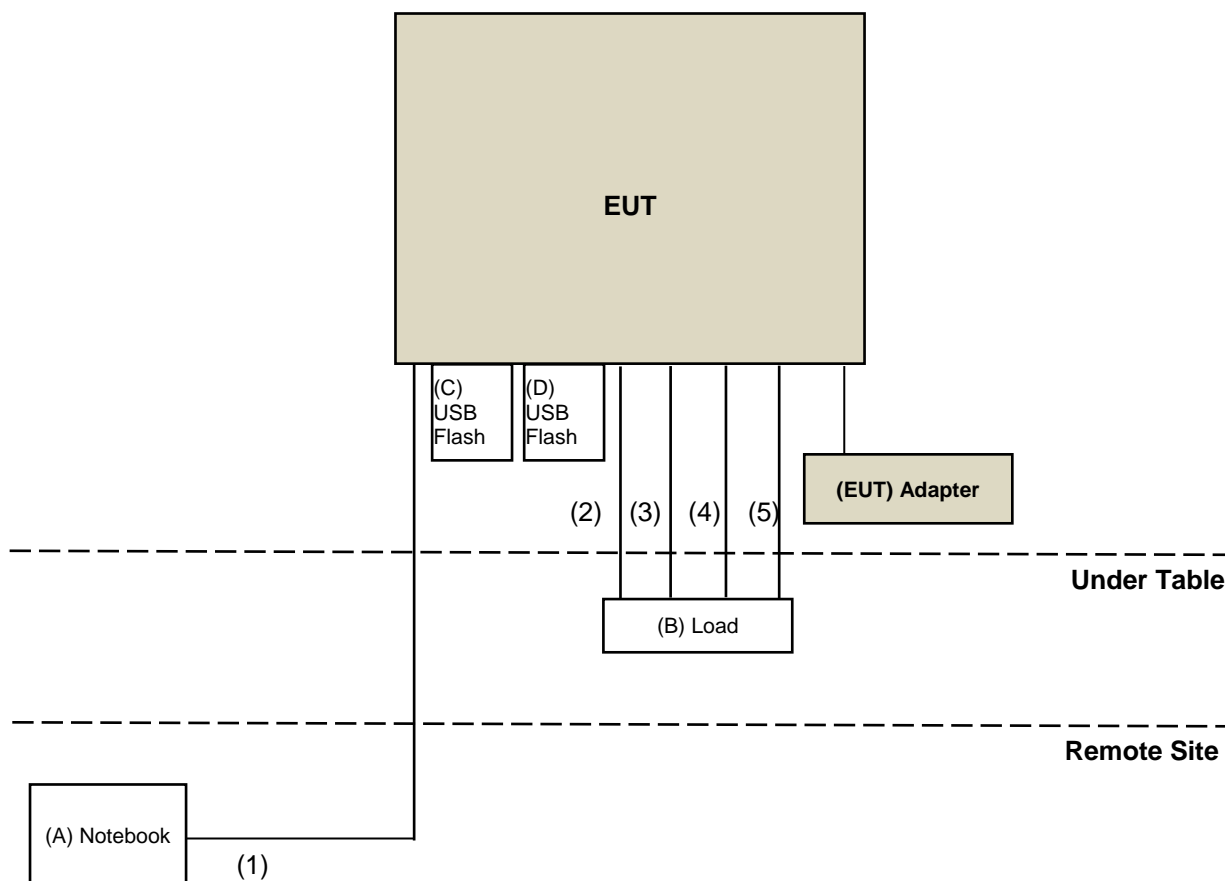

### 3.8 Configuration of Peripheral Devices and Cable Connections

ID	Product	Brand	Model No.	Serial No.	FCC ID	Remarks
A	Notebook	Lenovo	L470	PF0XEHC5	N/A	Provided by Lab
B	Load	N/A	N/A	N/A	N/A	Provided by Lab
C	USB Flash	SanDisk	SDDDC3-032G	N/A	N/A	Provided by Lab
D	USB Flash	SanDisk	SDDDC3-032G	N/A	N/A	Provided by Lab

ID	Cable Descriptions	Qty.	Length (m)	Shielding (Yes/No)	Cores (Qty.)	Remarks
1	RJ-45 Cable	1	6	No	0	Provided by Lab
2	RJ-45 Cable	1	1.5	No	0	Provided by Lab
3	RJ-45 Cable	1	1.5	No	0	Provided by Lab
4	RJ-45 Cable	1	1.5	No	0	Provided by Lab
5	RJ-45 Cable	1	1.5	No	0	Provided by Lab



## 4 Test Instruments

The calibration interval of the all test instruments are 12 months and the calibrations are traceable to NML/ROC and NIST/USA.

### 4.1 26 dB Bandwidth

Description Manufacturer	Model No.	Serial No.	Calibrated Date	Calibrated Until
Signal & Spectrum Analyzer R&S	FSV3044	101105	2023/2/22	2024/2/21
Software BV	ADT_RF Test Software V6.6.5.4	N/A	N/A	N/A

Notes:

1. The test was performed in Oven room.
2. Tested Date: 2023/4/10

### 4.2 RF Output Power

Description Manufacturer	Model No.	Serial No.	Calibrated Date	Calibrated Until
Signal & Spectrum Analyzer R&S	FSV3044	101105	2023/2/22	2024/2/21
Software BV	ADT_RF Test Software V6.6.5.4	N/A	N/A	N/A
USB Wideband Power Sensor Keysight	U2021XA	MY55050005/MY55190004/ MY55190007/MY55210005	2022/7/13	2023/7/12

Notes:

1. The test was performed in Oven room.
2. Tested Date: 2023/4/10

### 4.3 Power Spectral Density

Refer to section 4.1 to get information of the instruments.

### 4.4 6 dB Bandwidth

Refer to section 4.1 to get information of the instruments.

### 4.5 Occupied Bandwidth

Refer to section 4.1 to get information of the instruments.

#### 4.6 Frequency Stability

Description Manufacturer	Model No.	Serial No.	Calibrated Date	Calibrated Until
AC Power Supply JIN YIH Technology	6905S	1720444	N/A	N/A
Digital Multimeter Fluke	87-III	70360742	2022/6/23	2023/6/22
Signal & Spectrum Analyzer R&S	FSV3044	101105	2023/2/22	2024/2/21
Software BV	ADT_RF Test Software V6.6.5.4	N/A	N/A	N/A
Temperature & Humidity Chamber Terchy	HRM-120RF	931022	2022/12/27	2023/12/26

Notes:

1. The test was performed in Oven room.
2. Tested Date: 2023/4/10

#### 4.7 AC Power Conducted Emissions

Description Manufacturer	Model No.	Serial No.	Calibrated Date	Calibrated Until
EMI Test Receiver R&S	ESCI	100613	2022/12/5	2023/12/4
LISN R&S	ESH3-Z5	100116	2023/2/15	2024/2/14
		100311	2022/9/12	2023/9/11
RF Coaxial Cable Woken	5D-FB	Cable-cond1-01	2023/1/7	2024/1/6
Software BVADT	BVADT_Cond_ V7.3.7.4	N/A	N/A	N/A
V-LISN Schwarzbeck	NNBL 8226-2	8226-142	2022/8/31	2023/8/30

Notes:

1. The test was performed in HY - Conduction 1.
2. Tested Date: 2023/3/21 ~ 2023/6/19

#### 4.8 Unwanted Emissions below 1 GHz

Description Manufacturer	Model No.	Serial No.	Calibrated Date	Calibrated Until
Antenna Tower & Turn BV ADT	AT100	AT93021705	N/A	N/A
Bi_Log Antenna Schwarbeck	VULB 9168	9168-160	2022/10/20	2023/10/19
Loop Antenna Electro-Metrics	EM-6879	269	2022/9/19	2023/9/18
Loop Antenna TESEQ	HLA 6121	45745	2022/7/27	2023/7/26
MXE EMI Receiver Keysight	N9038A	MY55420137	2022/4/27	2023/4/26
Preamplifier Agilent	8447D	2944A10638	2022/5/14	2023/5/13
Preamplifier EMCI	EMC001340	980201	2022/9/23	2023/9/22
RF Coaxial Cable EMCI	5D-NM-BM	140903+140902	2023/1/7	2024/1/6
RF Coaxial Cable Woken	8D-FB	Cable-CH9-01	2022/5/14	2023/5/13
Signal & Spectrum Analyzer R&S	FSW43	101867	2022/12/30	2023/12/29
Software BV ADT	ADT_Radiated_ V7.6.15.9.5	N/A	N/A	N/A
Turn Table BV ADT	TT100	TT93021705	N/A	N/A
Turn Table Controller BV ADT	SC100	SC93021705	N/A	N/A

Notes:

1. The test was performed in HY - 966 chamber 4.
2. Tested Date: 2023/3/27

#### 4.9 Unwanted Emissions above 1 GHz

Description Manufacturer	Model No.	Serial No.	Calibrated Date	Calibrated Until
Antenna Tower & Turn BV ADT	AT100	AT93021705	N/A	N/A
Boresight antenna tower fixture BV	BAF-02	5	N/A	N/A
Horn Antenna Schwarzbeck	BBHA 9120D	9120D-1169	2022/11/13	2023/11/12
	BBHA 9170	9170-480	2022/11/13	2023/11/12
		BBHA9170243	2022/11/13	2023/11/12
Notch Filter Micro-Tronics	BRM17690	004	2023/01/11	2024/01/10
	BRM50716	060	2023/01/11	2024/01/10
Preamplifier Agilent	8449B	3008A02367	2023/02/15	2024/02/14
Preamplifier EMCI	EMC 184045	980116	2022/10/01	2023/09/30
RF Coaxial Cable EMCI	EMC102-KM-KM-600	150928	2022/07/09	2023/07/08
	EMC102-KM-KM-3000	150929	2022/07/09	2023/07/08
RF Coaxial Cable HUBER+SUHNER	SUCOFLEX 104	CABLE-CH9-(250795/4)	2023/01/07	2024/01/06
RF Coaxial Cable HUBER+SUHNER&EMCI	SUCOFLEX 104& EMC104-SM-SM8000	CABLE-CH9-02 (248780+171006)	2023/01/07	2024/01/06
Signal & Spectrum Analyzer R&S	FSW43	101867	2022/12/30	2023/12/29
Software BV ADT	ADT_Radiated_ V7.6.15.9.5	N/A	N/A	N/A
Turn Table BV ADT	TT100	TT93021705	N/A	N/A
Turn Table Controller BV ADT	SC100	SC93021705	N/A	N/A

Notes:

1. The test was performed in HY - 966 chamber 4.
2. Tested Date: 2023/3/24 ~ 2023/6/1

## 5 Limits of Test Items

### 5.1 26 dB Bandwidth

The results are for reference only.

### 5.2 RF Output Power

Operation Band	EUT Category	Limit
U-NII-1	Outdoor Access Point	1 Watt (30 dBm) (Max. e.i.r.p $\leq$ 125mW(21 dBm) at any elevation angle above 30 degrees as measured from the horizon)
	Fixed point-to-point Access Point	1 Watt (30 dBm)
	Indoor Access Point	1 Watt (30 dBm)
	Mobile and Portable client device	250mW (24 dBm)

Operation Band	Limit
U-NII-2A	250mW (24 dBm) or 11 dBm+10 log B*
U-NII-2C	250mW (24 dBm) or 11 dBm+10 log B*
U-NII-3	1 Watt (30 dBm)

\*B is the 26 dB emission bandwidth in megahertz

Per KDB 662911 D01 Multiple Transmitter Output Method of conducted output power measurement on IEEE 802.11 devices,

Array Gain = 0 dB (i.e., no array gain) for  $N_{ANT} \leq 4$ ;

Array Gain = 0 dB (i.e., no array gain) for channel widths  $\geq 40$  MHz for any  $N_{ANT}$ ;

Array Gain = 5 log( $N_{ANT}/N_{SS}$ ) dB or 3 dB, whichever is less, for 20-MHz channel widths with  $N_{ANT} \geq 5$ .

For power measurements on all other devices: Array Gain = 10 log( $N_{ANT}/N_{SS}$ ) dB.

### 5.3 Power Spectral Density

Operation Band	EUT Category	Limit
U-NII-1	Outdoor Access Point	17 dBm/MHz
	Fixed point-to-point Access Point	
	Indoor Access Point	
	Mobile and Portable client device	11 dBm/MHz

Operation Band	Limit
U-NII-2A	11 dBm/ MHz
U-NII-2C	11 dBm/ MHz
U-NII-3	30 dBm/ 500 kHz

#### 5.4 6 dB Bandwidth

Within the 5.725-5.850 GHz band, the minimum 6 dB bandwidth of U-NII devices shall be at least 500 kHz.

#### 5.5 Occupied Bandwidth

The results are for reference only.

#### 5.6 Frequency Stability

The frequency of the carrier signal shall be maintained within band of operation.

#### 5.7 AC Power Conducted Emissions

Frequency (MHz)	Conducted Limit (dBuV)	
	Quasi-peak	Average
0.15 - 0.5	66 - 56	56 - 46
0.50 - 5.0	56	46
5.0 - 30.0	60	50

Notes:

1. The lower limit shall apply at the transition frequencies.
2. The limit decreases in line with the logarithm of the frequency in the range of 0.15 to 0.50 MHz.

#### 5.8 Unwanted Emissions below 1 GHz

Radiated emissions which fall in the restricted bands must comply with the radiated emission limits specified as below table.

Frequencies (MHz)	Field Strength (microvolts/meter)	Measurement Distance (meters)
0.009 ~ 0.490	2400/F(kHz)	300
0.490 ~ 1.705	24000/F(kHz)	30
1.705 ~ 30.0	30	30
30 ~ 88	100	3
88 ~ 216	150	3
216 ~ 960	200	3
Above 960	500	3

Notes:

1. The lower limit shall apply at the transition frequencies.
2. Emission level (dBuV/m) = 20 log Emission level (uV/m).

## 5.9 Unwanted Emissions above 1 GHz

Radiated emissions which fall in the restricted bands must comply with the radiated emission limits specified as below table.

Frequencies (MHz)	Field Strength (microvolts/meter)	Measurement Distance (meters)
Above 960	500	3

Notes:

3. The lower limit shall apply at the transition frequencies.
4. Emission level (dBuV/m) = 20 log Emission level (uV/m).
5. For frequencies above 1000 MHz, the field strength limits are based on average detector, however, the peak field strength of any emission shall not exceed the maximum permitted average limits, specified above by more than 20 dB under any condition of modulation.

Limits of unwanted emission out of the restricted bands

Applicable To		Limit	
789033 D02 General UNII Test Procedure New Rules v02r01		Field Strength at 3 m	
		PK: 74 (dBµV/m)	AV: 54 (dBµV/m)
Frequency Band	Applicable To	EIRP Limit	Equivalent Field Strength at 3 m
5150~5250 MHz	15.407(b)(1)	PK: -27 (dBm/MHz)	PK: 68.2 (dBµV/m)
5250~5350 MHz	15.407(b)(2)		
5470~5725 MHz	15.407(b)(3)		
5725~5850 MHz	15.407(b)(4)(i)	PK: -27 (dBm/MHz) <sup>*1</sup> PK: 10 (dBm/MHz) <sup>*2</sup> PK: 15.6 (dBm/MHz) <sup>*3</sup> PK: 27 (dBm/MHz) <sup>*4</sup>	PK: 68.2 (dBµV/m) <sup>*1</sup> PK: 105.2 (dBµV/m) <sup>*2</sup> PK: 110.8 (dBµV/m) <sup>*3</sup> PK: 122.2 (dBµV/m) <sup>*4</sup>
*1 beyond 75 MHz or more above of the band edge.		*2 below the band edge increasing linearly to 10 dBm/MHz at 25 MHz above.	
*3 below the band edge increasing linearly to a level of 15.6 dBm/MHz at 5 MHz above.		*4 from 5 MHz above or below the band edge increasing linearly to a level of 27 dBm/MHz at the band edge.	

Note: The following formula is used to convert the equipment isotropic radiated power (eirp) to field strength:

$$E = \frac{1000000\sqrt{30P}}{3} \mu\text{V/m, where } P \text{ is the eirp (Watts).}$$

## 6 Test Arrangements

### 6.1 26 dB Bandwidth

#### 6.1.1 Test Setup

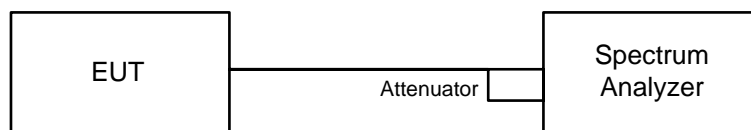

#### 6.1.2 Test Procedure

- a. Set RBW = approximately 1% of the emission bandwidth.
- b. Set the VBW > RBW.
- c. Detector = Peak.
- d. Trace mode = max hold.
- e. Measure the maximum width of the emission that is 26 dB down from the peak of the emission. Compare this with the RBW setting of the analyzer. Readjust RBW and repeat measurement as needed until the RBW/EBW ratio is approximately 1%.



## 6.2 RF Output Power

### 6.2.1 Test Setup

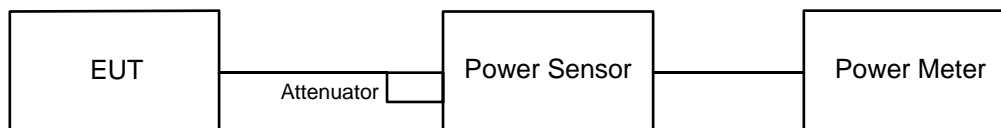

#### For channel straddling:

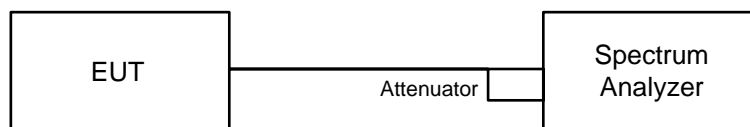

### 6.2.2 Test Procedure

Method PM is used to perform output power measurement, trigger and gating function of wide band power meter is enabled to measure max output power of TX on burst and set the detector to average. Duty factor is not added to measured value.

#### For channel straddling:

##### Method SA-1

- a. Set span to encompass the entire emission bandwidth (EBW) of the signal.
- b. Set RBW = 1 MHz, Set VBW  $\geq$  3 MHz, Detector = RMS
- c. Sweep points  $\geq$   $[2 \times \text{span} / \text{RBW}]$ . (This gives bin-to-bin spacing  $\leq$  RBW / 2, so that narrowband signals are not lost between frequency bins.)
- d. Sweep time = auto, trigger set to "free run".
- e. Trace average at least 100 traces in power averaging mode.
- f. Record the max value

Note: When measuring straddle channel power, use compute power by integrating the spectrum across the 26 dB EBW or 99% OBW of the signal using the instrument's band power measurement function, with band limits set equal to the EBW or OBW band edges. If the instrument does not have a band power function, then sum the spectrum levels (in power units) at 1 MHz intervals extending across the 26 dB EBW or 99% OBW of the spectrum.

## 6.3 Power Spectral Density

### 6.3.1 Test Setup

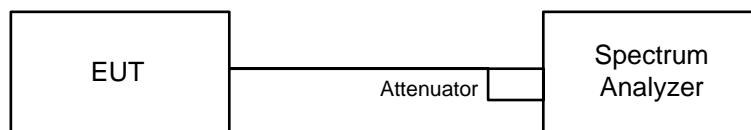

### 6.3.2 Test Procedure

#### For specified measurement bandwidth 1 MHz:

##### Method SA-1

- Set span to encompass the entire emission bandwidth (EBW) of the signal.
- Set RBW = 1 MHz, Set VBW  $\geq$  3 MHz, Detector = RMS
- Sweep points  $\geq$   $[2 \times \text{span} / \text{RBW}]$ . (This gives bin-to-bin spacing  $\leq$  RBW / 2, so that narrowband signals are not lost between frequency bins.)
- Sweep time = auto, trigger set to "free run".
- Trace average at least 100 traces in power averaging mode.
- Record the max value

#### For specified measurement bandwidth 500 kHz:

##### Method SA-1

- Set span to encompass the entire emission bandwidth (EBW) of the signal.
- Set RBW = 300 kHz, Set VBW  $\geq$  1 MHz, Detector = RMS
- Scale the observed power level to an equivalent value in 500 kHz by adjusting (increasing) the measured power by a bandwidth correction factor (BWCF) where  $\text{BWCF} = 10\log(500 \text{ kHz}/300 \text{ kHz})$
- Sweep points  $\geq$   $[2 \times \text{span} / \text{RBW}]$ . (This gives bin-to-bin spacing  $\leq$  RBW / 2, so that narrowband signals are not lost between frequency bins.)
- Sweep time = auto, trigger set to "free run".
- Trace average at least 100 traces in power averaging mode.
- Record the max value

## 6.4 6 dB Bandwidth

### 6.4.1 Test Setup

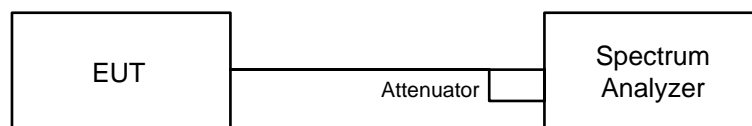

### 6.4.2 Test Procedure

- Set resolution bandwidth (RBW) = 100 kHz.
- Set the video bandwidth (VBW)  $\geq$  3 x RBW, Detector = Peak.
- Trace mode = max hold.
- Sweep = auto couple.
- Measure the maximum width of the emission that is constrained by the frequencies associated with the two amplitude points (upper and lower) that are attenuated by 6 dB relative to the maximum level measured in the fundamental emission.

## 6.5 Occupied Bandwidth

### 6.5.1 Test Setup

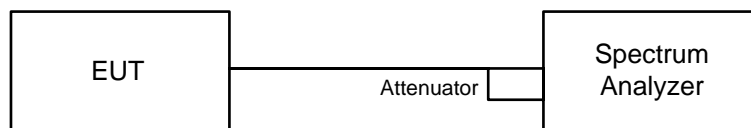

### 6.5.2 Test Procedure

The transmitter output was connected to the spectrum analyzer through an attenuator. The bandwidth of the fundamental frequency was measured by spectrum analyzer with resolution bandwidth in the range of 1% to 5% of the anticipated emission bandwidth, and a video bandwidth at least 3x the resolution bandwidth and set the detector to Sampling. The width of a frequency band such that, below the lower and above the upper frequency limits, the mean powers emitted are each equal to a specified percentage 0.5% of the total mean power of a given emission.

## 6.6 Frequency Stability

### 6.6.1 Test Setup

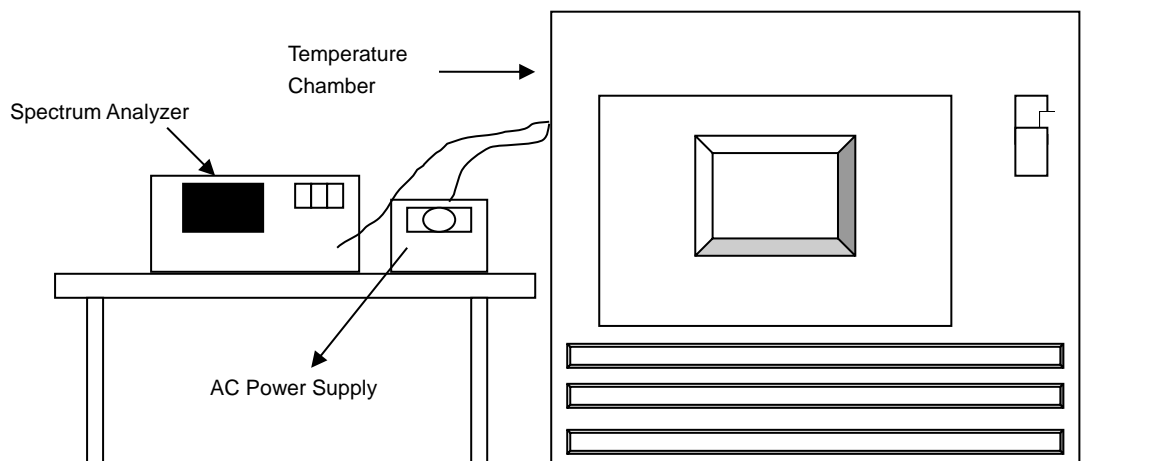

### 6.6.2 Test Procedure

- The EUT was placed inside the environmental test chamber and powered by nominal AC voltage.
- Turn the EUT on and couple its output to a spectrum analyzer.
- Turn the EUT off and set the chamber to the highest temperature specified.
- Allow sufficient time (approximately 30 min) for the temperature of the chamber to stabilize, turn the EUT on and measure the operating frequency after 2, 5, and 10 Minutes.
- Repeat step (d) with the temperature chamber set to the next desired temperature until measurements down to the lowest specified temperature have been completed.
- The test chamber was allowed to stabilize at +20 degree C for a minimum of 30 Minutes. The supply voltage was then adjusted on the EUT from 85% to 115% and the frequency record.

## 6.7 AC Power Conducted Emissions

### 6.7.1 Test Setup

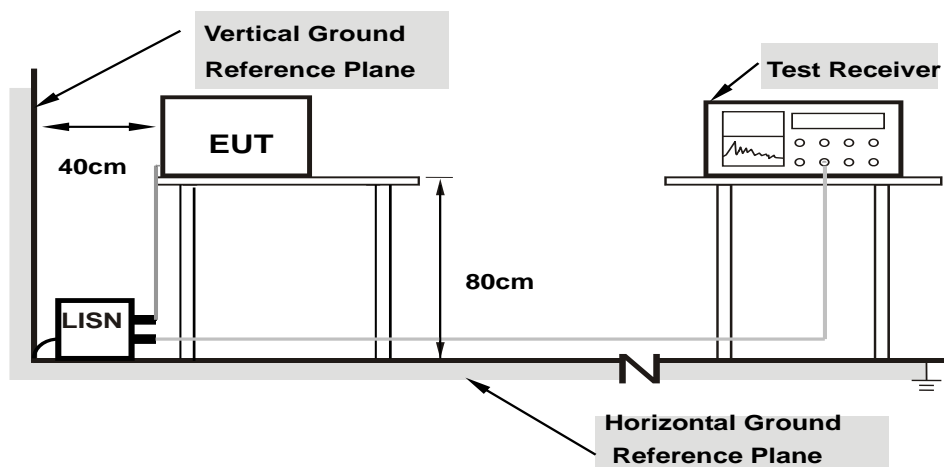

**Note: 1.Support units were connected to second LISN.**

For the actual test configuration, please refer to the attached file (Test Setup Photo).

### 6.7.2 Test Procedure

- The EUT was placed on a 0.8 meter to the top of table and placed 0.4 meters from the conducting wall of the shielded room with EUT being connected to the power mains through a line impedance stabilization network (LISN). Other support units were connected to the power mains through another LISN. The two LISNs provide 50 ohm/ 50 uH of coupling impedance for the measuring instrument.
- Both lines of the power mains connected to the EUT were checked for maximum conducted interference.
- The frequency range from 150 kHz to 30 MHz was searched. Emission levels under (Limit – 20 dB) was not recorded.

Note: The resolution bandwidth and video bandwidth of test receiver is 9 kHz for quasi-peak detection (QP) and average detection (AV) at frequency 0.15 MHz-30 MHz.

## 6.8 Unwanted Emissions below 1 GHz

### 6.8.1 Test Setup

#### For Radiated emission below 30 MHz

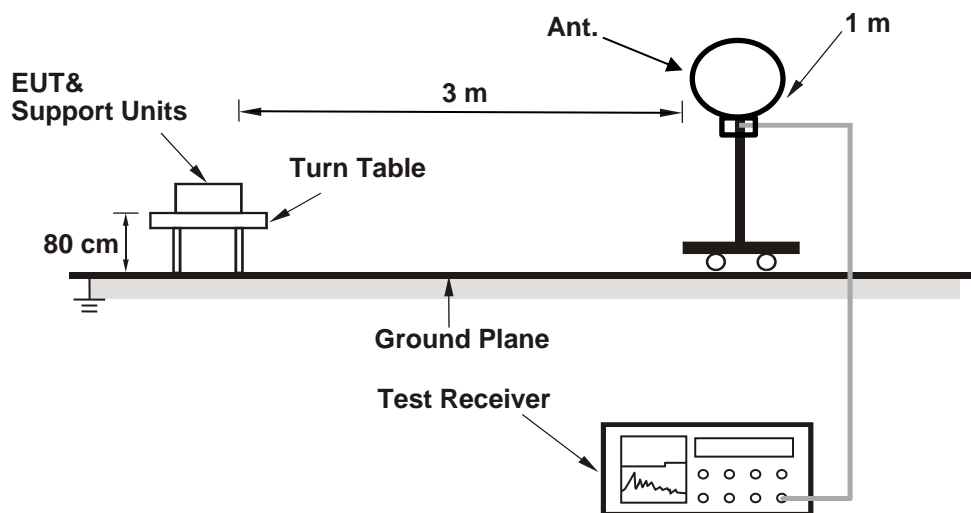

#### For Radiated emission above 30 MHz

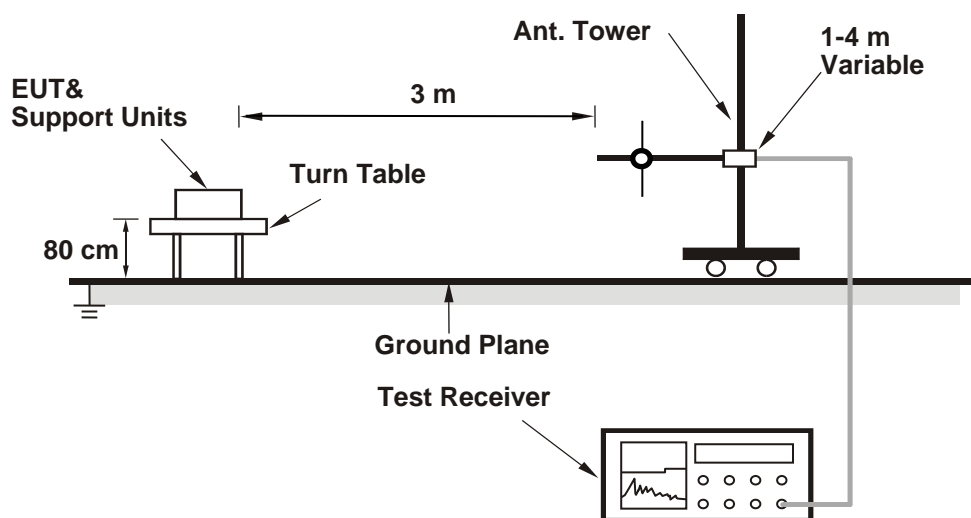

For the actual test configuration, please refer to the attached file (Test Setup Photo).

## 6.8.2 Test Procedure

### For Radiated emission below 30 MHz

- a. The EUT was placed on the top of a rotating table 0.8 meters above the ground at 3 meter chamber room for test. The table was rotated 360 degrees to determine the position of the highest radiation.
- b. The EUT was set 3 meters away from the interference-receiving antenna, which was mounted on the top of a variable-height antenna tower.
- c. Parallel, perpendicular, and ground-parallel orientations of the antenna are set to make the measurement.
- d. For each suspected emission, the EUT was arranged to its worst case and the rotatable table was turned from 0 degrees to 360 degrees to find the maximum reading.
- e. The test-receiver system was set to Quasi-Peak Detect Function and Specified Bandwidth with Maximum Hold Mode, except for the frequency band (9 kHz to 90 kHz and 110 kHz to 490 kHz) set to average detect function and peak detect function.

#### Notes:

1. The resolution bandwidth and video bandwidth of test receiver/spectrum analyzer is 200 Hz at frequency below 150 kHz.
2. The resolution bandwidth and video bandwidth of test receiver/spectrum analyzer is 9 kHz or 10 kHz at frequency (150 kHz to 30 MHz).
3. All modes of operation were investigated and the worst-case emissions are reported.

### For Radiated emission above 30 MHz

- a. The EUT was placed on the top of a rotating table 0.8 meters above the ground at 3 meter chamber room for test. The table was rotated 360 degrees to determine the position of the highest radiation.
- b. The EUT was set 3 meters away from the interference-receiving antenna, which was mounted on the top of a variable-height antenna tower.
- c. The height of antenna is varied from one meter to four meters above the ground to determine the maximum value of the field strength. Both horizontal and vertical polarizations of the antenna are set to make the measurement.
- d. For each suspected emission, the EUT was arranged to its worst case and then the antenna was tuned to heights from 1 meter to 4 meters and the rotatable table was turned from 0 degrees to 360 degrees to find the maximum reading.
- e. The test-receiver system was set to Quasi-peak(QP) detect function, Average(AV) detect function, Peak(PK) detect function and specified bandwidth with maximum hold mode when the test frequency is below 1 GHz.

#### Notes:

1. The resolution bandwidth and video bandwidth of test receiver/spectrum analyzer is 120 kHz for Quasi-peak detection (QP), Average detection (AV), Peak detection (PK) at frequency (30MHz to 1 GHz).
2. All modes of operation were investigated and the worst-case emissions are reported.

## 6.9 Unwanted Emissions above 1 GHz

### 6.9.1 Test Setup

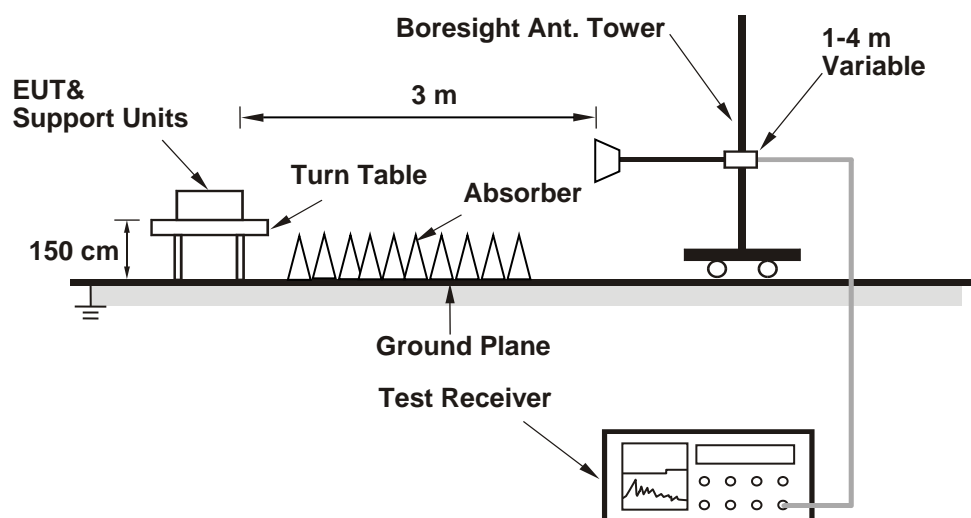

For the actual test configuration, please refer to the attached file (Test Setup Photo).

### 6.9.2 Test Procedure

- The EUT was placed on the top of a rotating table 1.5 meters above the ground at 3 meter chamber room for test. The table was rotated 360 degrees to determine the position of the highest radiation.
- The EUT was set 3 meters away from the interference-receiving antenna, which was mounted on the top of a variable-height antenna tower.
- The height of antenna is varied from one meter to four meters above the ground to determine the maximum value of the field strength. Both horizontal and vertical polarizations of the antenna are set to make the measurement.
- For each suspected emission, the EUT was arranged to its worst case and then the antenna was tuned to heights from 1 meter to 4 meters and the rotatable table was turned from 0 degrees to 360 degrees to find the maximum reading.
- The test-receiver system was set to peak and average detects function and specified bandwidth with maximum hold mode when the test frequency is above 1 GHz. If the peak reading value also meets average limit, measurement with the average detector is unnecessary.

#### Notes:

- The resolution bandwidth of test receiver/spectrum analyzer is 1 MHz and the video bandwidth is 3 MHz for Peak detection (PK) and Average detection (AV) at frequency above 1 GHz.
- For fundamental and harmonic signal measurement, the resolution bandwidth of test receiver/spectrum analyzer is 1 MHz and the video bandwidth is  $\geq 1/T$  (Duty cycle  $< 98\%$ ) or 10 Hz (Duty cycle  $\geq 98\%$ ) for Average detection (AV) at frequency above 1 GHz.
- All modes of operation were investigated and the worst-case emissions are reported.

## 7 Test Results of Test Item

### 7.1 26 dB Bandwidth

Input Power:	120 Vac, 60 Hz	Environmental Conditions:	25°C, 60% RH	Tested By:	Jisyong Wang
--------------	----------------	---------------------------	--------------	------------	--------------

#### 802.11a

Channel	Frequency (MHz)	26 dB Bandwidth (MHz)	
		Chain 0	Chain 1
52	5260	22.32	22.15
60	5300	22.13	22.15
64	5320	22.82	23.06
100	5500	22.76	22.22
116	5580	22.07	22.20
140	5700	21.71	21.72
144 (U-NII-2C)	5720	16.21	16.16
144 (U-NII-3)	5720	6.31	6.30

Determined Output Power Limit			
Channel Number	Freq.(MHz)	Min. B(MHz)	Determined Conducted Power Limit (dBm)
52	5260	22.15	24.45 > 24
60	5300	22.13	24.44 > 24
64	5320	22.82	24.58 > 24
100	5500	22.22	24.46 > 24
116	5580	22.07	24.43 > 24
140	5700	21.71	24.36 > 24
144 (U-NII-2C)	5720	16.16	23.08 < 24

Note: For U-NII-2A, U-NII-2C Band output power limitation is determined based on 26dBc bandwidth.



**802.11ax (HE20)**

Channel	Frequency (MHz)	26 dB Bandwidth (MHz)	
		Chain 0	Chain 1
52	5260	25.05	23.96
60	5300	23.72	23.62
64	5320	23.85	24.53
100	5500	23.62	23.66
116	5580	23.46	23.65
140	5700	21.94	21.97
144 (U-NII-2C)	5720	17.56	17.62
144 (U-NII-3)	5720	6.94	6.13

Determined Output Power Limit			
Channel Number	Freq.(MHz)	Min. B(MHz)	Determined Conducted Power Limit (dBm)
52	5260	23.96	24.79 > 24
60	5300	23.62	24.73 > 24
64	5320	23.85	24.77 > 24
100	5500	23.62	24.73 > 24
116	5580	23.46	24.7 > 24
140	5700	21.94	24.41 > 24
144 (U-NII-2C)	5720	17.56	23.44 < 24

Note: For U-NII-2A, U-NII-2C Band output power limitation is determined based on 26dBc bandwidth.

**802.11ax (HE40)**

Channel	Frequency (MHz)	26 dB Bandwidth (MHz)	
		Chain 0	Chain 1
54	5270	43.15	42.62
62	5310	44.49	44.54
102	5510	43.26	44.05
110	5550	42.68	43.45
134	5670	42.52	44.23
142 (U-NII-2C)	5710	36.56	37.44
142 (U-NII-3)	5710	6.35	6.33

Determined Output Power Limit			
Channel Number	Freq.(MHz)	Min. B(MHz)	Determined Conducted Power Limit (dBm)
54	5270	42.62	27.29 > 24
62	5310	44.49	27.48 > 24
102	5510	43.26	27.36 > 24
110	5550	42.68	27.3 > 24
134	5670	42.52	27.28 > 24
142 (U-NII-2C)	5710	36.56	26.63 > 24

Note: For U-NII-2A, U-NII-2C Band output power limitation is determined based on 26dBc bandwidth.

**802.11ax (HE80)**

Channel	Frequency (MHz)	26 dB Bandwidth (MHz)	
		Chain 0	Chain 1
58	5290	86.29	86.80
106	5530	85.72	84.21
122	5610	84.75	84.83
138 (U-NII-2C)	5690	78.26	77.26
138 (U-NII-3)	5690	6.55	6.51

Determined Output Power Limit			
Channel Number	Freq.(MHz)	Min. B(MHz)	Determined Conducted Power Limit (dBm)
58	5290	86.29	30.35 > 24
106	5530	84.21	30.25 > 24
122	5610	84.75	30.28 > 24
138 (U-NII-2C)	5690	77.26	29.87 > 24

Note: For U-NII-2A, U-NII-2C Band output power limitation is determined based on 26dBc bandwidth.

**802.11ax (HE160)**

Channel	Frequency (MHz)	26 dB Bandwidth (MHz)	
		Chain 0	Chain 1
50 (U-NII-1)	5250	83.84	83.67
50 (U-NII-2A)	5250	84.64	84.27
114	5570	168.23	167.85

Determined Output Power Limit			
Channel Number	Freq.(MHz)	Min. B(MHz)	Determined Conducted Power Limit (dBm)
50 (U-NII-2A)	5250	84.27	30.25 > 24
114	5570	167.85	33.24 > 24

Note: For U-NII-2A, U-NII-2C Band output power limitation is determined based on 26dBc bandwidth.



### Spectrum Plot of Minimum Value

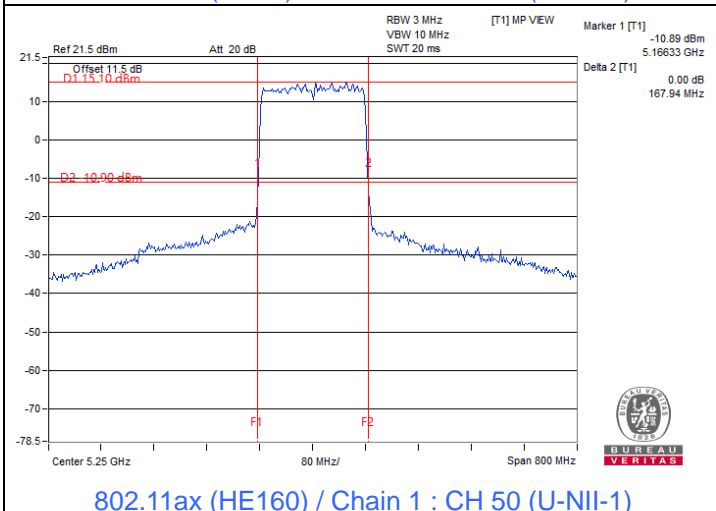
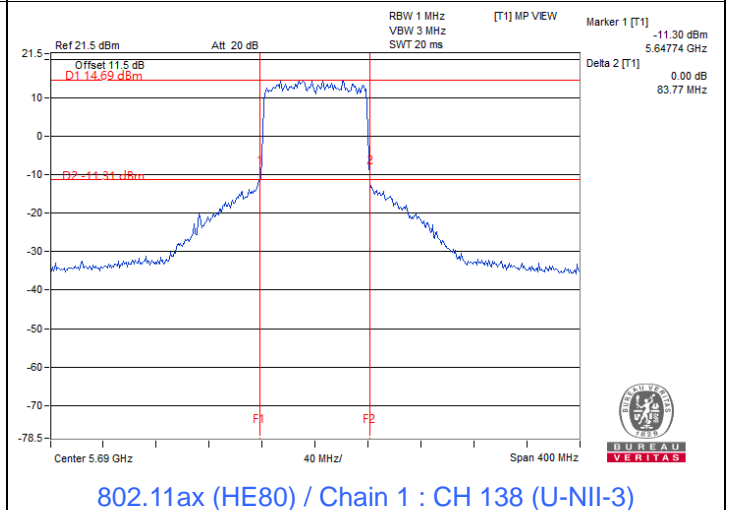
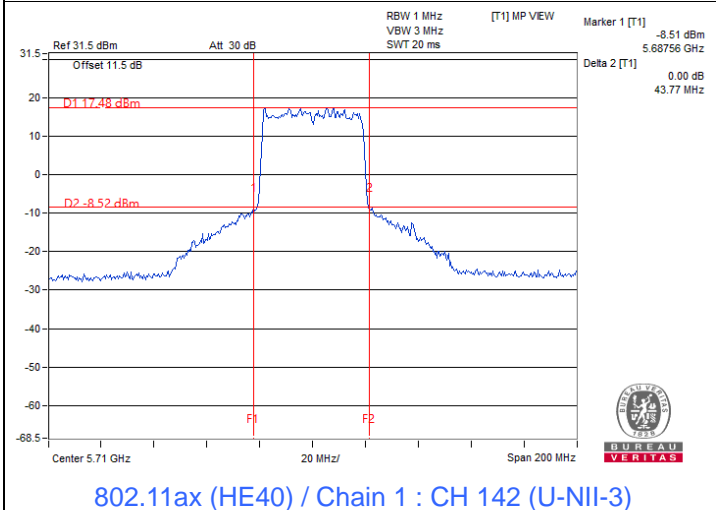
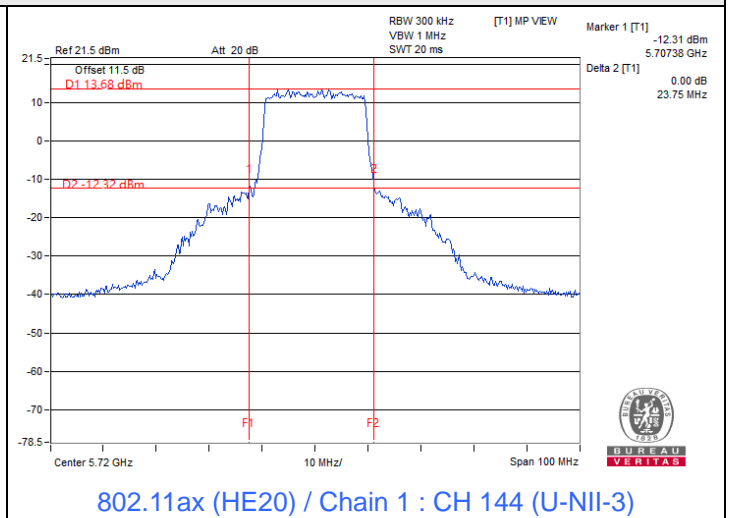
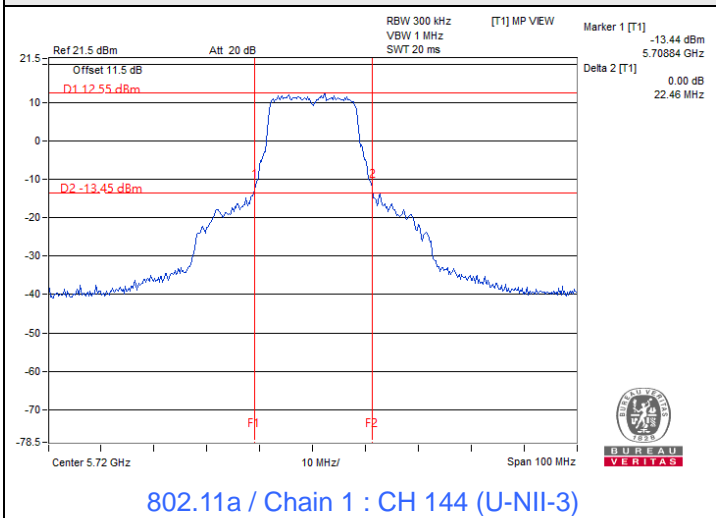

#### Notes:

1. For U-NII-2C straddle channel = 5725 MHz - Marker 1
2. For U-NII-3 straddle channel = Marker 1 + Delta 2 - 5725 MHz
3. For U-NII-1 straddle channel = 5250 MHz - Marker 1
4. For U-NII-2A straddle channel = Marker 1 + Delta 2 - 5250 MHz

## 7.2 RF Output Power

Input Power:	120 Vac, 60 Hz	Environmental Conditions:	25°C, 60% RH	Tested By:	Jisyong Wang
--------------	----------------	---------------------------	--------------	------------	--------------

### 802.11a CDD

Chan.	Chan. Freq. (MHz)	Average Power (dBm)		Total Power (mW)	Total Power (dBm)	Power Limit (dBm)	Test Result
		Chain 0	Chain 1				
36	5180	21.85	22.49	330.528	25.19	30	Pass
40	5200	25.65	25.81	748.348	28.74	30	Pass
48	5240	26.79	26.88	<b>965.058</b>	<b>29.85</b>	30	Pass
52	5260	20.98	20.72	<b>243.346</b>	<b>23.86</b>	24	Pass
60	5300	20.82	20.64	236.659	23.74	24	Pass
64	5320	20.92	20.65	239.74	23.80	24	Pass
100	5500	20.68	20.00	216.95	23.36	24	Pass
116	5580	20.72	19.85	214.637	23.32	24	Pass
140	5700	19.17	18.85	159.34	22.02	24	Pass
*144 (U-NII-2C)	5720	18.15	18.84	141.873	21.52	23.08	Pass
*144 (U-NII-3)	5720	12.00	12.18	32.369	15.10	30	Pass
149	5745	26.43	27.03	944.203	29.75	30	Pass
157	5785	26.41	27.06	945.682	29.76	30	Pass
165	5825	26.38	27.09	946.192	29.76	30	Pass

#### Notes:

- \* : Test was performed in accordance with measurement follow FCC KDB 789033 UNII test procedure Method SA-1 and use spectrum analyzer test.
- Directional gain is the maximum gain of antennas.
- For U-NII-1, the maximum gain is 3 dBi < 6 dBi, so the output power limit shall not be reduced.
- For U-NII-2A, the maximum gain is 3 dBi < 6 dBi, so the output power limit shall not be reduced.
- For U-NII-2C, the maximum gain is 3 dBi < 6 dBi, so the output power limit shall not be reduced.
- For U-NII-3, the maximum gain is 3 dBi < 6 dBi, so the output power limit shall not be reduced.

## 802.11ax (HE20) CDD

Chan.	Chan. Freq. (MHz)	Average Power (dBm)		Total Power (mW)	Total Power (dBm)	Power Limit (dBm)	Test Result
		Chain 0	Chain 1				
36	5180	21.83	22.44	327.793	25.16	30	Pass
40	5200	25.45	25.51	706.383	28.49	30	Pass
48	5240	26.71	26.83	950.761	29.78	30	Pass
52	5260	20.98	20.39	234.71	23.71	24	Pass
60	5300	20.78	20.55	233.175	23.68	24	Pass
64	5320	20.82	20.47	232.211	23.66	24	Pass
100	5500	21.29	20.17	238.578	23.78	24	Pass
116	5580	21.07	20.11	230.503	23.63	24	Pass
140	5700	18.82	18.53	147.493	21.69	24	Pass
*144 (U-NII-2C)	5720	17.44	18.07	119.584	20.78	23.44	Pass
*144 (U-NII-3)	5720	12.27	12.91	36.409	15.61	30	Pass
149	5745	26.93	26.54	943.991	29.75	30	Pass
157	5785	26.91	26.61	<b>949.05</b>	<b>29.77</b>	30	Pass
165	5825	26.92	26.59	948.076	29.77	30	Pass

## Notes:

- \* : Test was performed in accordance with measurement follow FCC KDB 789033 UNII test procedure Method SA-1 and use spectrum analyzer test.
- Directional gain is the maximum gain of antennas.
- For U-NII-1, the maximum gain is 3 dBi < 6 dBi, so the output power limit shall not be reduced.
- For U-NII-2A, the maximum gain is 3 dBi < 6 dBi, so the output power limit shall not be reduced.
- For U-NII-2C, the maximum gain is 3 dBi < 6 dBi, so the output power limit shall not be reduced.
- For U-NII-3, the maximum gain is 3 dBi < 6 dBi, so the output power limit shall not be reduced.

### 802.11ax (HE40) CDD

Chan.	Chan. Freq. (MHz)	Average Power (dBm)		Total Power (mW)	Total Power (dBm)	Power Limit (dBm)	Test Result
		Chain 0	Chain 1				
38	5190	18.36	17.93	130.636	21.16	30	Pass
46	5230	24.83	24.66	596.504	27.76	30	Pass
54	5270	20.81	20.21	225.458	23.53	24	Pass
62	5310	17.97	17.55	119.547	20.78	24	Pass
102	5510	19.83	19.63	187.994	22.74	24	Pass
110	5550	21.05	20.69	244.57	23.88	24	Pass
134	5670	20.45	20.39	220.313	23.43	24	Pass
*142 (U-NII-2C)	5710	17.98	19.50	151.931	21.82	24	Pass
*142 (U-NII-3)	5710	8.16	8.90	14.309	11.56	30	Pass
151	5755	26.55	26.71	920.669	29.64	30	Pass
159	5795	26.42	26.79	916.06	29.62	30	Pass

#### Notes:

1. \* : Test was performed in accordance with measurement follow FCC KDB 789033 UNII test procedure Method SA-1 and use spectrum analyzer test.
2. Directional gain is the maximum gain of antennas.
3. For U-NII-1, the maximum gain is 3 dBi < 6 dBi, so the output power limit shall not be reduced.
4. For U-NII-2A, the maximum gain is 3 dBi < 6 dBi, so the output power limit shall not be reduced.
5. For U-NII-2C, the maximum gain is 3 dBi < 6 dBi, so the output power limit shall not be reduced.
6. For U-NII-3, the maximum gain is 3 dBi < 6 dBi, so the output power limit shall not be reduced.

### 802.11ax (HE80) CDD

Chan.	Chan. Freq. (MHz)	Average Power (dBm)		Total Power (mW)	Total Power (dBm)	Power Limit (dBm)	Test Result
		Chain 0	Chain 1				
42	5210	19.53	19.44	177.645	22.50	30	Pass
58	5290	19.72	18.89	171.202	22.34	24	Pass
106	5530	21.12	20.73	<b>247.724</b>	<b>23.94</b>	24	Pass
122	5610	20.62	20.53	228.325	23.59	24	Pass
*138 (U-NII-2C)	5690	18.86	20.36	185.556	22.68	24	Pass
*138 (U-NII-3)	5690	5.07	6.32	7.499	8.75	30	Pass
155	5775	21.51	22.21	307.921	24.88	30	Pass

#### Notes:

- \* : Test was performed in accordance with measurement follow FCC KDB 789033 UNII test procedure Method SA-1 and use spectrum analyzer test.
- Directional gain is the maximum gain of antennas.
- For U-NII-1, the maximum gain is 3 dBi < 6 dBi, so the output power limit shall not be reduced.
- For U-NII-2A, the maximum gain is 3 dBi < 6 dBi, so the output power limit shall not be reduced.
- For U-NII-2C, the maximum gain is 3 dBi < 6 dBi, so the output power limit shall not be reduced.
- For U-NII-3, the maximum gain is 3 dBi < 6 dBi, so the output power limit shall not be reduced.

### 802.11ax (HE160) CDD

Chan.	Chan. Freq. (MHz)	Average Power (dBm)		Total Power (mW)	Total Power (dBm)	Power Limit (dBm)	Test Result
		Chain 0	Chain 1				
*50 (U-NII-1)	5250	16.12	16.51	85.697	19.33	30	Pass
*50 (U-NII-2A)	5250	16.46	16.91	93.35	19.70	24	Pass
114	5570	18.65	17.61	130.959	21.17	24	Pass

#### Notes:

- \* : Test was performed in accordance with measurement follow FCC KDB 789033 UNII test procedure Method SA-1 and use spectrum analyzer test.
- Directional gain is the maximum gain of antennas.
- For U-NII-1, the maximum gain is 3 dBi < 6 dBi, so the output power limit shall not be reduced.
- For U-NII-2A, the maximum gain is 3 dBi < 6 dBi, so the output power limit shall not be reduced.
- For U-NII-2C, the maximum gain is 3 dBi < 6 dBi, so the output power limit shall not be reduced.



### 802.11ax (HE20) Beamforming

Chan.	Chan. Freq. (MHz)	Average Power (dBm)		Total Power (mW)	Total Power (dBm)	Power Limit (dBm)	Test Result
		Chain 0	Chain 1				
36	5180	21.83	22.44	327.793	25.16	29.99	Pass
40	5200	25.45	25.51	706.383	28.49	29.99	Pass
48	5240	26.71	26.83	<b>950.761</b>	<b>29.78</b>	29.99	Pass
52	5260	20.98	20.39	<b>234.71</b>	<b>23.71</b>	23.99	Pass
60	5300	20.78	20.55	233.175	23.68	23.99	Pass
64	5320	20.82	20.47	232.211	23.66	23.99	Pass
100	5500	21.29	20.17	238.578	23.78	23.99	Pass
116	5580	21.07	20.11	230.503	23.63	23.99	Pass
140	5700	18.82	18.53	147.493	21.69	23.99	Pass
*144 (U-NII-2C)	5720	17.44	18.07	119.584	20.78	23.43	Pass
*144 (U-NII-3)	5720	12.27	12.91	36.409	15.61	29.99	Pass
149	5745	26.93	26.54	943.991	29.75	29.99	Pass
157	5785	26.91	26.61	<b>949.05</b>	<b>29.77</b>	29.99	Pass
165	5825	26.92	26.59	948.076	29.77	29.99	Pass

#### Notes:

- \* : Test was performed in accordance with measurement follow FCC KDB 789033 UNII test procedure Method SA-1 and use spectrum analyzer test.
- Directional gain = gain of antenna element + 10 log (2 of TX antenna elements)
- For U-NII-1, the directional gain is 6.01 dBi > 6 dBi, so the output power limit shall be reduced to 30-(6.01-6) = 29.99 dBm.
- For U-NII-2A, the directional gain is 6.01 dBi > 6 dBi, so the output power limit shall be reduced to [Determined Conducted Power Limit-(6.01-6)].
- For U-NII-2C, the directional gain is 6.01 dBi > 6 dBi, so the output power limit shall be reduced to [Determined Conducted Power Limit-(6.01-6)].
- For U-NII-3, the directional gain is 6.01 dBi > 6 dBi, so the output power limit shall be reduced to 30-(6.01-6) = 29.99 dBm.

## 802.11ax (HE40) Beamforming

Chan.	Chan. Freq. (MHz)	Average Power (dBm)		Total Power (mW)	Total Power (dBm)	Power Limit (dBm)	Test Result
		Chain 0	Chain 1				
38	5190	18.36	17.93	130.636	21.16	29.99	Pass
46	5230	24.83	24.66	596.504	27.76	29.99	Pass
54	5270	20.81	20.21	225.458	23.53	23.99	Pass
62	5310	17.97	17.55	119.547	20.78	23.99	Pass
102	5510	19.83	19.63	187.994	22.74	23.99	Pass
110	5550	21.05	20.69	244.57	23.88	23.99	Pass
134	5670	20.45	20.39	220.313	23.43	23.99	Pass
*142 (U-NII-2C)	5710	17.98	19.50	151.931	21.82	23.99	Pass
*142 (U-NII-3)	5710	8.16	8.90	14.309	11.56	29.99	Pass
151	5755	26.55	26.71	920.669	29.64	29.99	Pass
159	5795	26.42	26.79	916.06	29.62	29.99	Pass

### Notes:

- \* : Test was performed in accordance with measurement follow FCC KDB 789033 UNII test procedure Method SA-1 and use spectrum analyzer test.
- Directional gain = gain of antenna element + 10 log (2 of TX antenna elements)
- For U-NII-1, the directional gain is 6.01 dBi > 6 dBi, so the output power limit shall be reduced to  $30 - (6.01 - 6) = 29.99$  dBm.
- For U-NII-2A, the directional gain is 6.01 dBi > 6 dBi, so the output power limit shall be reduced to [Determined Conducted Power Limit - (6.01 - 6)].
- For U-NII-2C, the directional gain is 6.01 dBi > 6 dBi, so the output power limit shall be reduced to [Determined Conducted Power Limit - (6.01 - 6)].
- For U-NII-3, the directional gain is 6.01 dBi > 6 dBi, so the output power limit shall be reduced to  $30 - (6.01 - 6) = 29.99$  dBm.

### 802.11ax (HE80) Beamforming

Chan.	Chan. Freq. (MHz)	Average Power (dBm)		Total Power (mW)	Total Power (dBm)	Power Limit (dBm)	Test Result
		Chain 0	Chain 1				
42	5210	19.53	19.44	177.645	22.50	29.99	Pass
58	5290	19.72	18.89	171.202	22.34	23.99	Pass
106	5530	21.12	20.73	<b>247.724</b>	<b>23.94</b>	23.99	Pass
122	5610	20.62	20.53	228.325	23.59	23.99	Pass
*138 (U-NII-2C)	5690	18.86	20.36	185.556	22.68	23.99	Pass
*138 (U-NII-3)	5690	5.07	6.32	7.499	8.75	29.99	Pass
155	5775	21.51	22.21	307.921	24.88	29.99	Pass

#### Notes:

- \* : Test was performed in accordance with measurement follow FCC KDB 789033 UNII test procedure Method SA-1 and use spectrum analyzer test.
- Directional gain = gain of antenna element + 10 log (2 of TX antenna elements)
- For U-NII-1, the directional gain is 6.01 dBi > 6 dBi, so the output power limit shall be reduced to  $30 - (6.01 - 6) = 29.99$  dBm.
- For U-NII-2A, the directional gain is 6.01 dBi > 6 dBi, so the output power limit shall be reduced to [Determined Conducted Power Limit - (6.01 - 6)].
- For U-NII-2C, the directional gain is 6.01 dBi > 6 dBi, so the output power limit shall be reduced to [Determined Conducted Power Limit - (6.01 - 6)].
- For U-NII-3, the directional gain is 6.01 dBi > 6 dBi, so the output power limit shall be reduced to  $30 - (6.01 - 6) = 29.99$  dBm.

### 802.11ax (HE160) Beamforming

Chan.	Chan. Freq. (MHz)	Average Power (dBm)		Total Power (mW)	Total Power (dBm)	Power Limit (dBm)	Test Result
		Chain 0	Chain 1				
*50 (U-NII-1)	5250	16.12	16.51	85.697	19.33	29.99	Pass
*50 (U-NII-2A)	5250	16.46	16.91	93.35	19.70	23.99	Pass
114	5570	18.65	17.61	130.959	21.17	23.99	Pass

#### Notes:

- \* : Test was performed in accordance with measurement follow FCC KDB 789033 UNII test procedure Method SA-1 and use spectrum analyzer test.
- Directional gain = gain of antenna element + 10 log (2 of TX antenna elements)
- For U-NII-1, the directional gain is 6.01 dBi > 6 dBi, so the output power limit shall be reduced to  $30 - (6.01 - 6) = 29.99$  dBm.
- For U-NII-2A, the directional gain is 6.01 dBi > 6 dBi, so the output power limit shall be reduced to [Determined Conducted Power Limit - (6.01 - 6)].
- For U-NII-2C, the directional gain is 6.01 dBi > 6 dBi, so the output power limit shall be reduced to [Determined Conducted Power Limit - (6.01 - 6)].



### Spectrum Plot for channel straddling

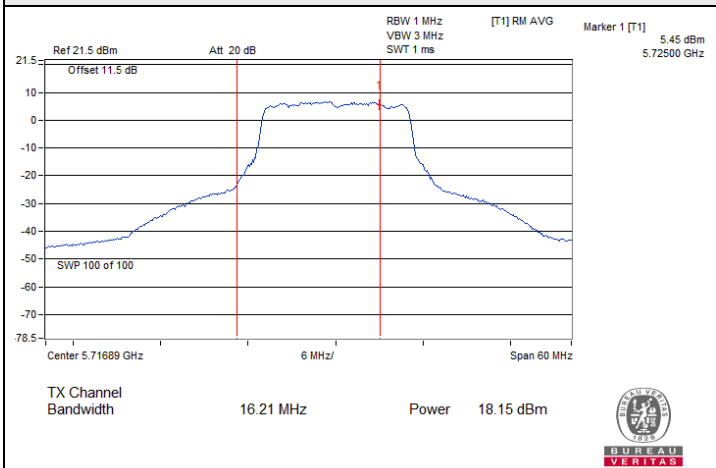

802.11a / Chain 0 : CH 144 (U-NII-2C)

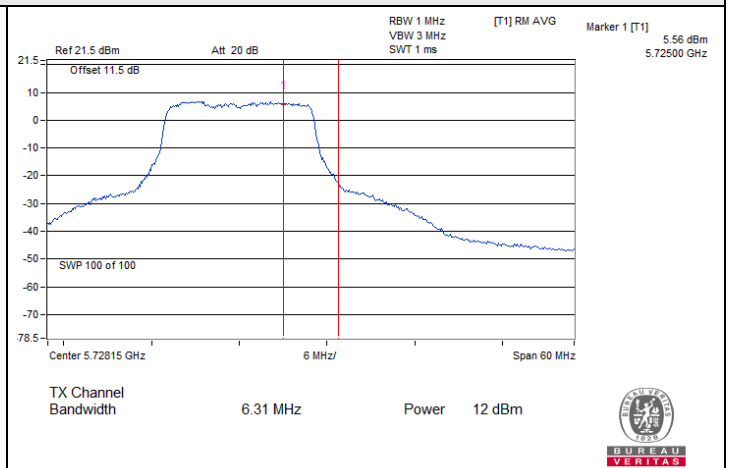

802.11a / Chain 0 : CH 144 (U-NII-3)

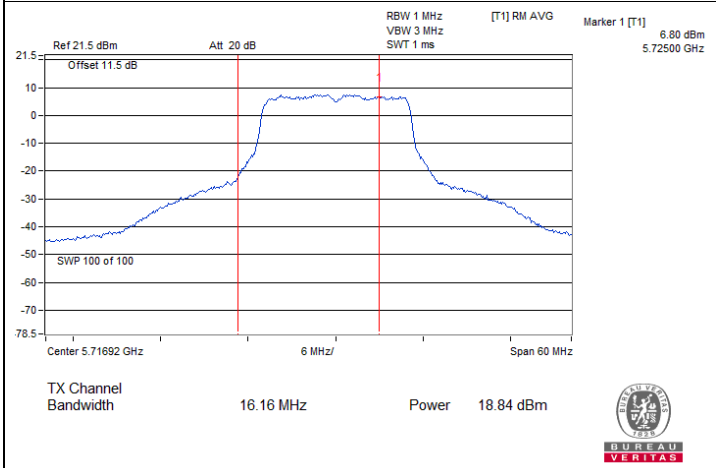

802.11a / Chain 1 : CH 144 (U-NII-2C)

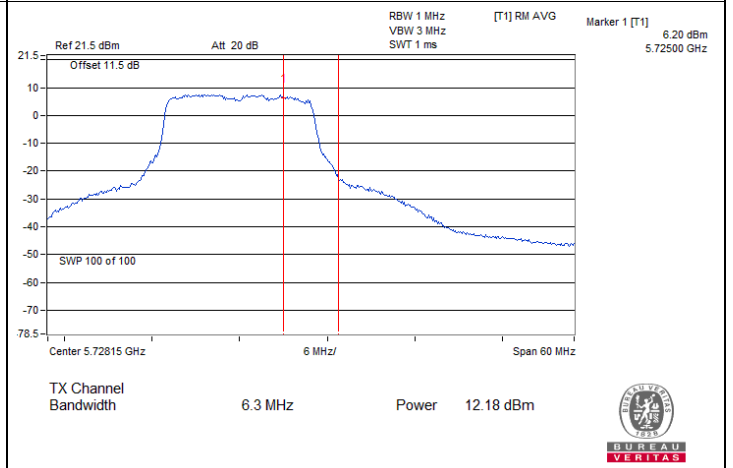

802.11a / Chain 1 : CH 144 (U-NII-3)

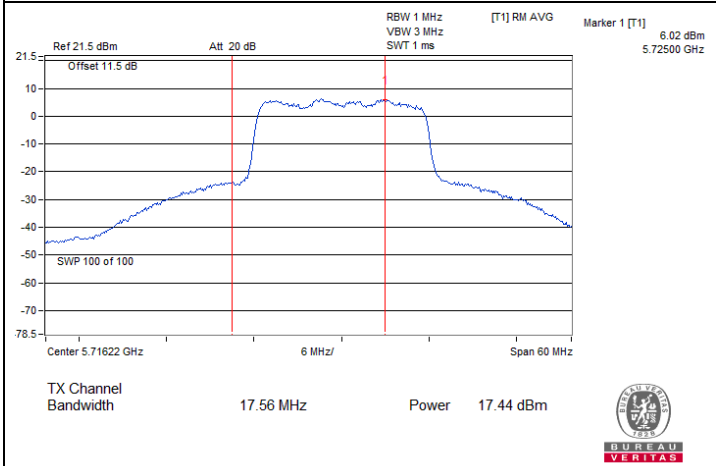

802.11ax (HE20) / Chain 0 : CH 144 (U-NII-2C)

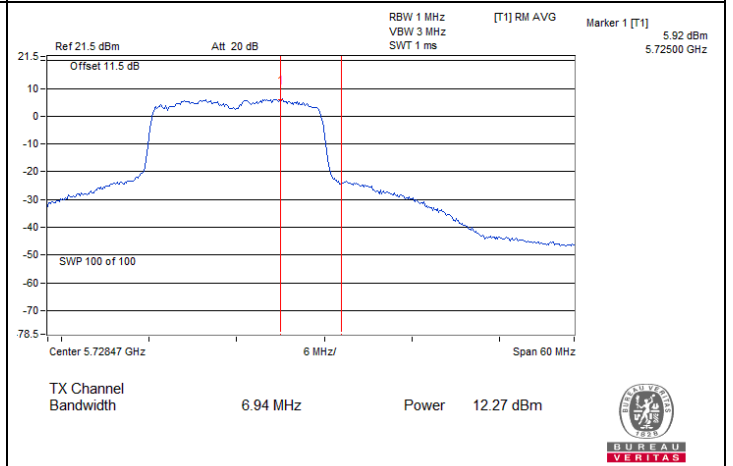

802.11ax (HE20) / Chain 0 : CH 144 (U-NII-3)



### Spectrum Plot for channel straddling

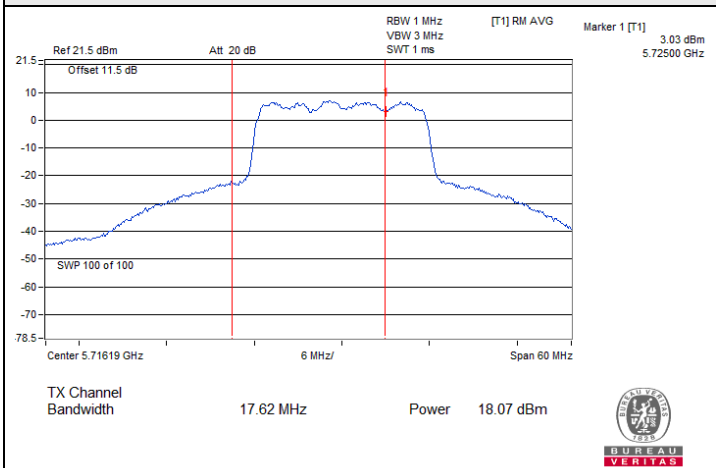

802.11ax (HE20) / Chain 1 : CH 144 (U-NII-2C)

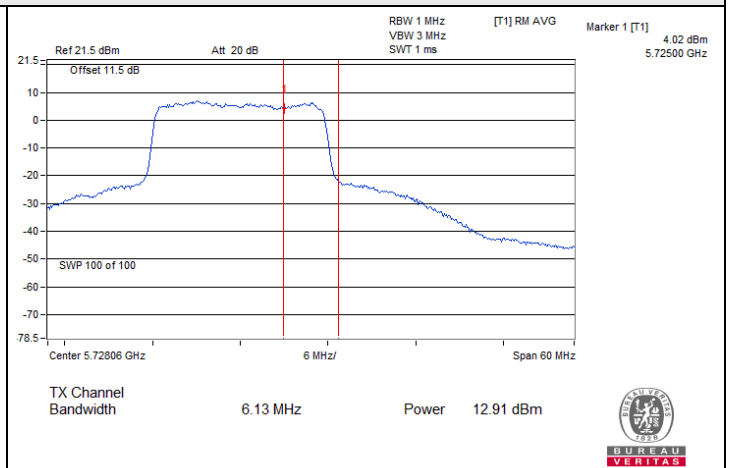

802.11ax (HE20) / Chain 1 : CH 144 (U-NII-3)

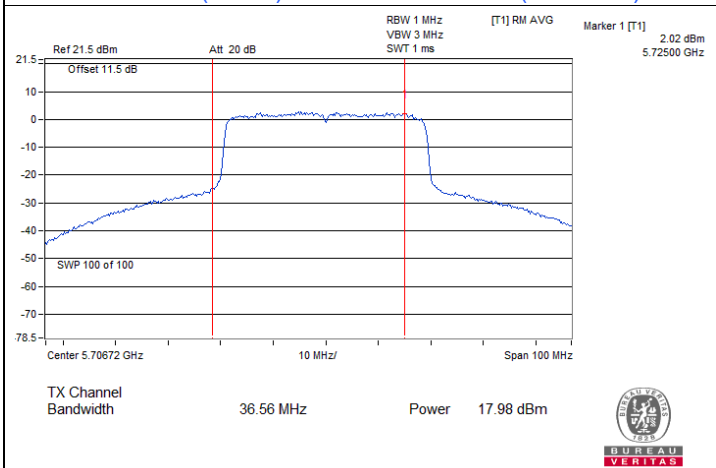

802.11ax (HE40) / Chain 0 : CH 142 (U-NII-2C)

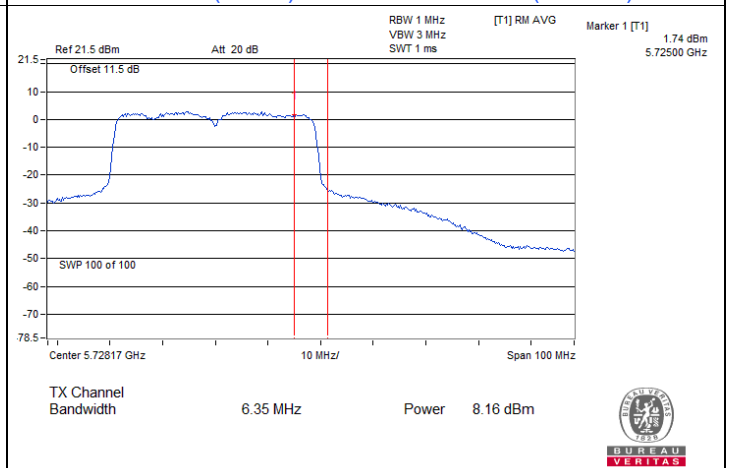

802.11ax (HE40) / Chain 0 : CH 142 (U-NII-3)

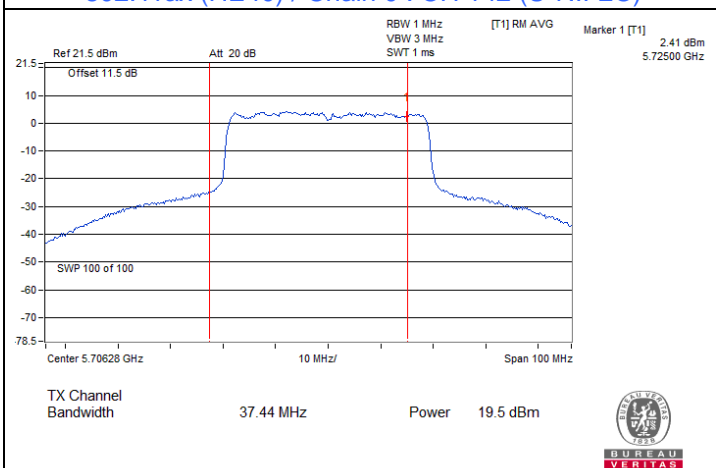

802.11ax (HE40) / Chain 1 : CH 142 (U-NII-2C)

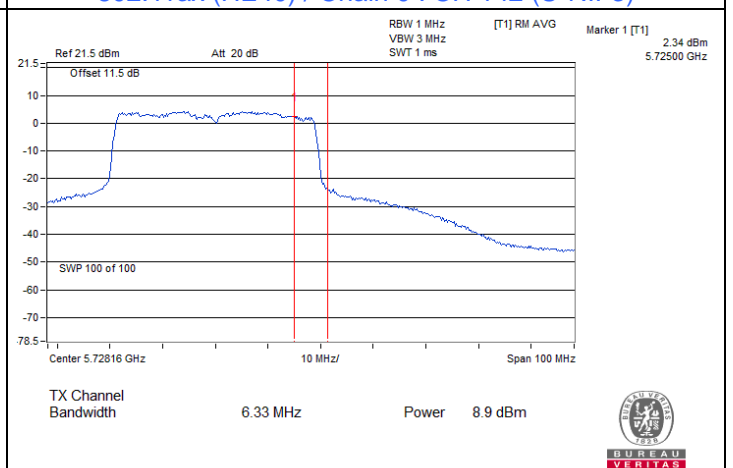

802.11ax (HE40) / Chain 1 : CH 142 (U-NII-3)



### Spectrum Plot for channel straddling

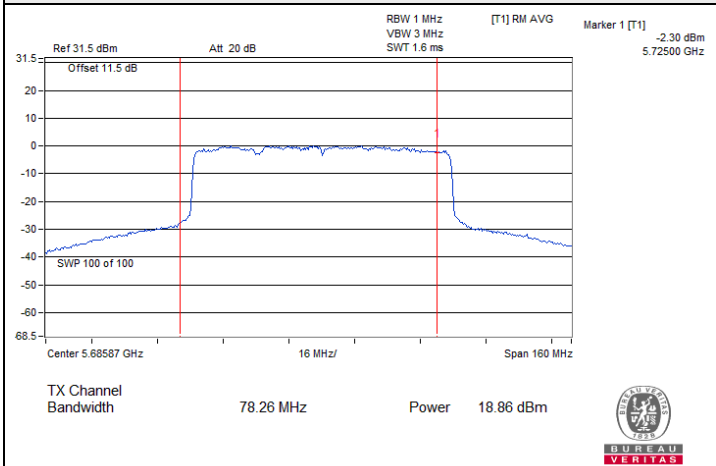

802.11ax (HE80) / Chain 0 : CH 138 (U-NII-2C)

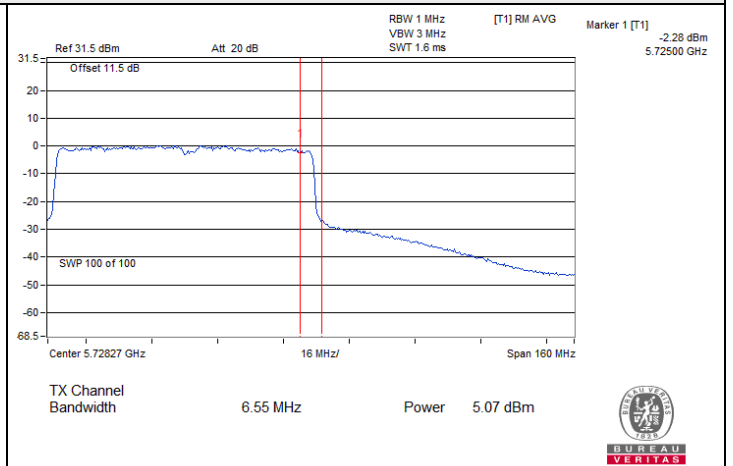

802.11ax (HE80) / Chain 0 : CH 138 (U-NII-3)

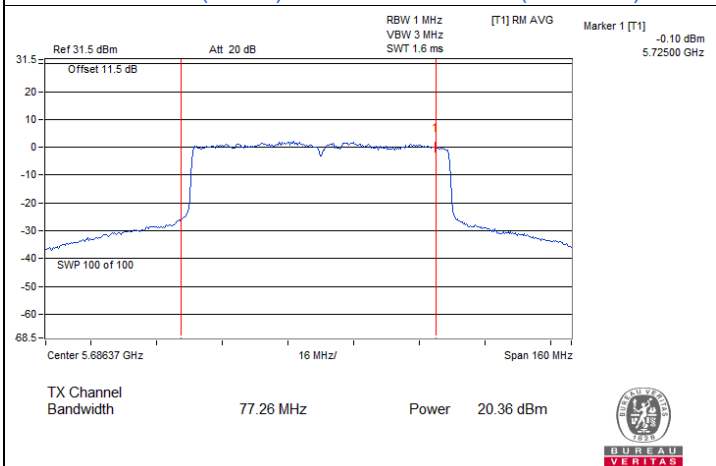

802.11ax (HE80) / Chain 1 : CH 138 (U-NII-2C)

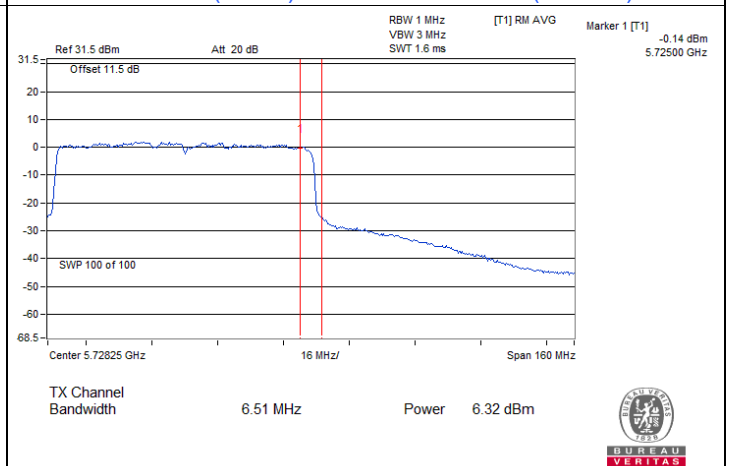

802.11ax (HE80) / Chain 1 : CH 138 (U-NII-3)

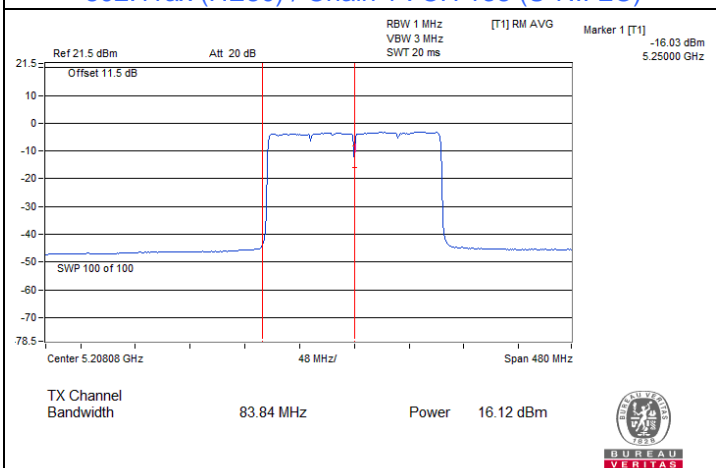

802.11ax (HE160) / Chain 0 : CH 50 (U-NII-1)

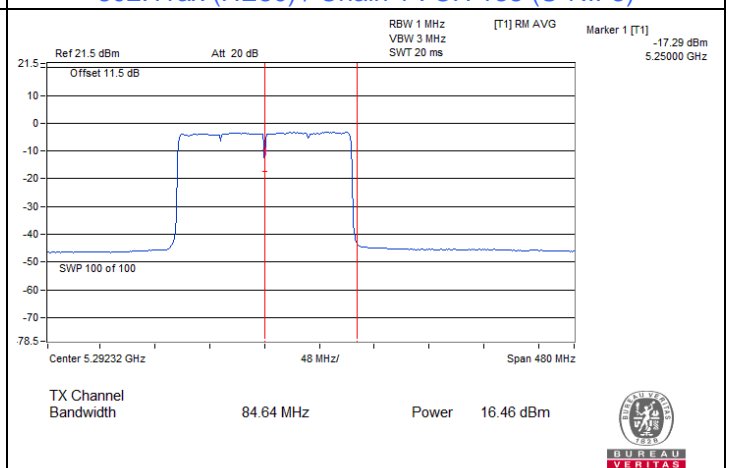

802.11ax (HE160) / Chain 0 : CH 50 (U-NII-2A)



### Spectrum Plot for channel straddling

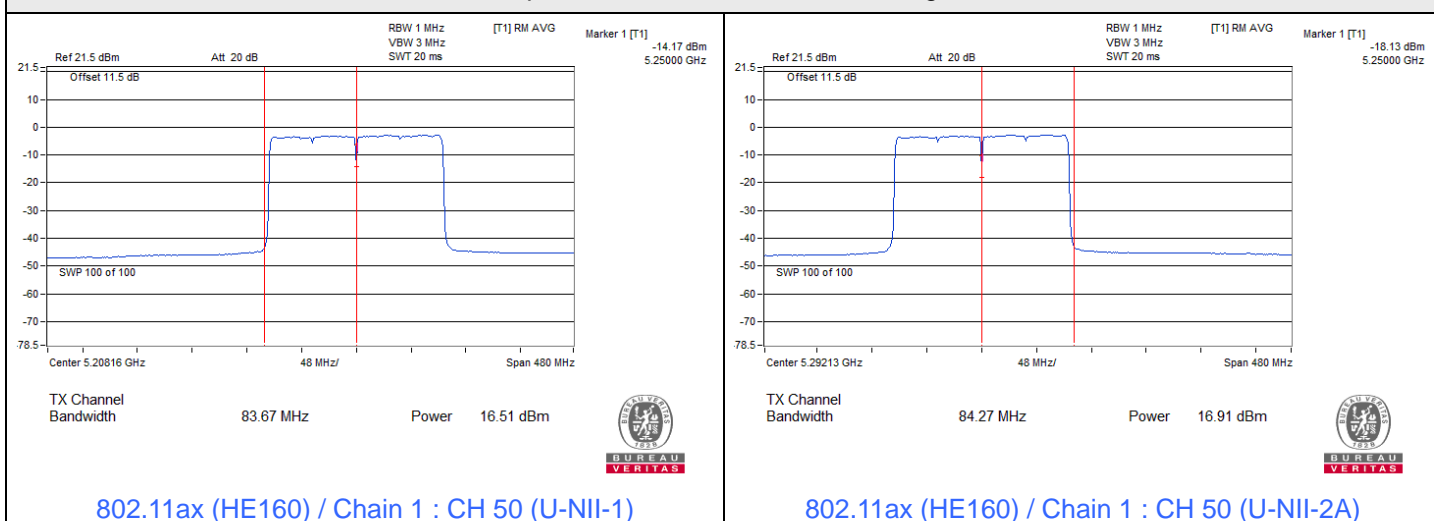

### 7.3 Power Spectral Density

Input Power:	120 Vac, 60 Hz	Environmental Conditions:	25°C, 60% RH	Tested By:	Jisyong Wang
--------------	----------------	---------------------------	--------------	------------	--------------

#### 802.11a

Chan.	Chan. Freq. (MHz)	PSD (dBm/MHz)		Total PSD (dBm/MHz)	Max. PSD Limit (dBm/MHz)	Test Result
		Chain 0	Chain 1			
36	5180	8.78	9.45	12.14	16.99	Pass
40	5200	12.64	12.81	15.74	16.99	Pass
48	5240	13.22	14.26	16.78	16.99	Pass
52	5260	7.53	8.04	10.80	10.99	Pass
60	5300	7.32	8.13	10.75	10.99	Pass
64	5320	7.38	8.18	10.81	10.99	Pass
100	5500	7.63	7.84	10.75	10.99	Pass
116	5580	7.50	7.64	10.58	10.99	Pass
140	5700	5.40	5.97	8.70	10.99	Pass
144 (U-NII-2C)	5720	7.45	7.66	10.57	10.99	Pass

#### Notes:

- Method E) 2) a) of power density measurement of KDB 662911 is using for calculating total power density. Total power density is summing entire spectra across corresponding frequency bins on the various outputs by computer.
- Directional gain = gain of antenna element + 10 log (2 of TX antenna elements)
- For U-NII-1, the directional gain is 6.01 dBi > 6dBi, so the power density limit shall be reduced to 17-(6.01-6) = 16.99 dBm/MHz.
- For U-NII-2A, the directional gain is 6.01 dBi > 6 dBi, so the power density limit shall be reduced to 11-(6.01-6) = 10.99 dBm/MHz.
- For U-NII-2C, the directional gain is 6.01 dBi > 6 dBi, so the power density limit shall be reduced to 11-(6.01-6) = 10.99 dBm/MHz.



**802.11ax (HE20)**

Chan.	Chan. Freq. (MHz)	PSD (dBm/MHz)		Total PSD (dBm/MHz)	Max. PSD Limit (dBm/MHz)	Test Result
		Chain 0	Chain 1			
36	5180	8.82	9.39	12.12	16.99	Pass
40	5200	11.35	12.52	14.98	16.99	Pass
48	5240	13.38	14.01	16.72	16.99	Pass
52	5260	7.49	8.08	10.81	10.99	Pass
60	5300	7.33	8.06	10.72	10.99	Pass
64	5320	7.30	7.89	10.62	10.99	Pass
100	5500	7.37	8.02	10.72	10.99	Pass
116	5580	7.42	7.95	10.70	10.99	Pass
140	5700	4.78	5.60	8.22	10.99	Pass
144 (U-NII-2C)	5720	6.99	7.87	10.46	10.99	Pass

**Notes:**

- Method E) 2) a) of power density measurement of KDB 662911 is using for calculating total power density. Total power density is summing entire spectra across corresponding frequency bins on the various outputs by computer.
- Directional gain = gain of antenna element + 10 log (2 of TX antenna elements)
- For U-NII-1, the directional gain is 6.01 dBi > 6dBi, so the power density limit shall be reduced to 17-(6.01-6) = 16.99 dBm/MHz.
- For U-NII-2A, the directional gain is 6.01 dBi > 6 dBi, so the power density limit shall be reduced to 11-(6.01-6) = 10.99 dBm/MHz.
- For U-NII-2C, the directional gain is 6.01 dBi > 6 dBi, so the power density limit shall be reduced to 11-(6.01-6) = 10.99 dBm/MHz.

**802.11ax (HE40)**

Chan.	Chan. Freq. (MHz)	PSD (dBm/MHz)		Total PSD (dBm/MHz)	Max. PSD Limit (dBm/MHz)	Test Result
		Chain 0	Chain 1			
38	5190	2.33	1.84	5.10	16.99	Pass
46	5230	8.80	8.64	11.73	16.99	Pass
54	5270	3.66	5.05	7.42	10.99	Pass
62	5310	1.91	1.50	4.72	10.99	Pass
102	5510	3.06	4.41	6.80	10.99	Pass
110	5550	4.17	5.63	7.97	10.99	Pass
134	5670	3.60	5.20	7.48	10.99	Pass
142 (U-NII-2C)	5710	3.34	5.17	7.36	10.99	Pass

**Notes:**

- Method E) 2) a) of power density measurement of KDB 662911 is using for calculating total power density. Total power density is summing entire spectra across corresponding frequency bins on the various outputs by computer.
- Directional gain = gain of antenna element + 10 log (2 of TX antenna elements)
- For U-NII-1, the directional gain is 6.01 dBi > 6dBi, so the power density limit shall be reduced to 17-(6.01-6) = 16.99 dBm/MHz.
- For U-NII-2A, the directional gain is 6.01 dBi > 6 dBi, so the power density limit shall be reduced to 11-(6.01-6) = 10.99 dBm/MHz.
- For U-NII-2C, the directional gain is 6.01 dBi > 6 dBi, so the power density limit shall be reduced to 11-(6.01-6) = 10.99 dBm/MHz.

**802.11ax (HE80)**

Chan.	Chan. Freq. (MHz)	PSD (dBm/MHz)		Total PSD (dBm/MHz)	Max. PSD Limit (dBm/MHz)	Test Result
		Chain 0	Chain 1			
42	5210	0.50	0.43	3.48	16.99	Pass
58	5290	0.71	-0.23	3.28	10.99	Pass
106	5530	1.03	2.60	4.90	10.99	Pass
122	5610	0.79	2.12	4.52	10.99	Pass
138 (U-NII-2C)	5690	0.65	2.02	4.40	10.99	Pass

**Notes:**

- Method E) 2) a) of power density measurement of KDB 662911 is using for calculating total power density. Total power density is summing entire spectra across corresponding frequency bins on the various outputs by computer.
- Directional gain = gain of antenna element + 10 log (2 of TX antenna elements)
- For U-NII-1, the directional gain is 6.01 dBi > 6dBi, so the power density limit shall be reduced to 17-(6.01-6) = 16.99 dBm/MHz.
- For U-NII-2A, the directional gain is 6.01 dBi > 6 dBi, so the power density limit shall be reduced to 11-(6.01-6) = 10.99 dBm/MHz.
- For U-NII-2C, the directional gain is 6.01 dBi > 6 dBi, so the power density limit shall be reduced to 11-(6.01-6) = 10.99 dBm/MHz.

**802.11ax (HE160)**

Chan.	Chan. Freq. (MHz)	PSD (dBm/MHz)		Total PSD (dBm/MHz)	Max. PSD Limit (dBm/MHz)	Test Result
		Chain 0	Chain 1			
50 (U-NII-1)	5250	-2.96	-2.95	0.06	16.99	Pass
50 (U-NII-2A)	5250	-2.66	-2.58	0.39	10.99	Pass
114	5570	-3.41	-4.43	-0.88	10.99	Pass

**Notes:**

1. Method E) 2) a) of power density measurement of KDB 662911 is using for calculating total power density. Total power density is summing entire spectra across corresponding frequency bins on the various outputs by computer.
2. Directional gain = gain of antenna element + 10 log (2 of TX antenna elements)
3. For U-NII-1, the directional gain is 6.01 dBi > 6dBi, so the power density limit shall be reduced to 17-(6.01-6) = 16.99 dBm/MHz.
4. For U-NII-2A, the directional gain is 6.01 dBi > 6 dBi, so the power density limit shall be reduced to 11-(6.01-6) = 10.99 dBm/MHz.
5. For U-NII-2C, the directional gain is 6.01 dBi > 6 dBi, so the power density limit shall be reduced to 11-(6.01-6) = 10.99 dBm/MHz.

### 802.11a

Chan.	Chan. Freq. (MHz)	PSD (dBm/300kHz)		Total PSD (dBm/300kHz)	Total PSD (dBm/500kHz)	PSD Limit (dBm/500kHz)	Test Result
		Chain 0	Chain 1				
144 (U-NII-3)	5720	-1.44	-1.19	1.7	3.92	29.99	Pass
149	5745	4.04	4.32	7.19	9.41	29.99	Pass
157	5785	4.18	4.54	7.37	9.59	29.99	Pass
165	5825	4.04	4.52	7.3	9.52	29.99	Pass

Notes:

1. Method E) 2) b) Measure and sum spectral maxima across the outputs of KDB 662911 is using for calculating total power density.
2. Directional gain = gain of antenna element + 10 log (2 of TX antenna elements)
3. For U-NII-3, the directional gain is 6.01 dBi > 6 dBi, so the power density limit shall be reduced to  $30 - (6.01 - 6) = 29.99$  dBm/500kHz.

### 802.11ax (HE20)

Chan.	Chan. Freq. (MHz)	PSD (dBm/300kHz)		Total PSD (dBm/300kHz)	Total PSD (dBm/500kHz)	PSD Limit (dBm/500kHz)	Test Result
		Chain 0	Chain 1				
144 (U-NII-3)	5720	-2.68	-2.24	0.56	2.78	29.99	Pass
149	5745	2.77	3.02	5.91	8.13	29.99	Pass
157	5785	2.73	3.01	5.88	8.10	29.99	Pass
165	5825	2.81	3.16	6	8.22	29.99	Pass

Notes:

1. Method E) 2) b) Measure and sum spectral maxima across the outputs of KDB 662911 is using for calculating total power density.
2. Directional gain = gain of antenna element + 10 log (2 of TX antenna elements)
3. For U-NII-3, the directional gain is 6.01 dBi > 6 dBi, so the power density limit shall be reduced to  $30 - (6.01 - 6) = 29.99$  dBm/500kHz.

### 802.11ax (HE40)

Chan.	Chan. Freq. (MHz)	PSD (dBm/300kHz)		Total PSD (dBm/300kHz)	Total PSD (dBm/500kHz)	PSD Limit (dBm/500kHz)	Test Result
		Chain 0	Chain 1				
142 (U-NII-3)	5710	-6.98	-5.23	-3.01	-0.79	29.99	Pass
151	5755	-0.47	-0.10	2.73	4.95	29.99	Pass
159	5795	-0.44	-0.10	2.74	4.96	29.99	Pass

Notes:

1. Method E) 2) b) Measure and sum spectral maxima across the outputs of KDB 662911 is using for calculating total power density.
2. Directional gain = gain of antenna element + 10 log (2 of TX antenna elements)
3. For U-NII-3, the directional gain is 6.01 dBi > 6 dBi, so the power density limit shall be reduced to  $30 - (6.01 - 6) = 29.99$  dBm/500kHz.

### 802.11ax (HE80)

Chan.	Chan. Freq. (MHz)	PSD (dBm/300kHz)		Total PSD (dBm/300kHz)	Total PSD (dBm/500kHz)	PSD Limit (dBm/500kHz)	Test Result
		Chain 0	Chain 1				
138 (U-NII-3)	5690	-10.34	-8.73	-6.45	-4.23	29.99	Pass
155	5775	-6.68	-5.94	-3.28	-1.06	29.99	Pass

Notes:

1. Method E) 2) b) Measure and sum spectral maxima across the outputs of KDB 662911 is using for calculating total power density.
2. Directional gain = gain of antenna element + 10 log (2 of TX antenna elements)
3. For U-NII-3, the directional gain is 6.01 dBi > 6 dBi, so the power density limit shall be reduced to  $30 - (6.01 - 6) = 29.99$  dBm/500kHz.

### Spectrum Plot of Maximum Value

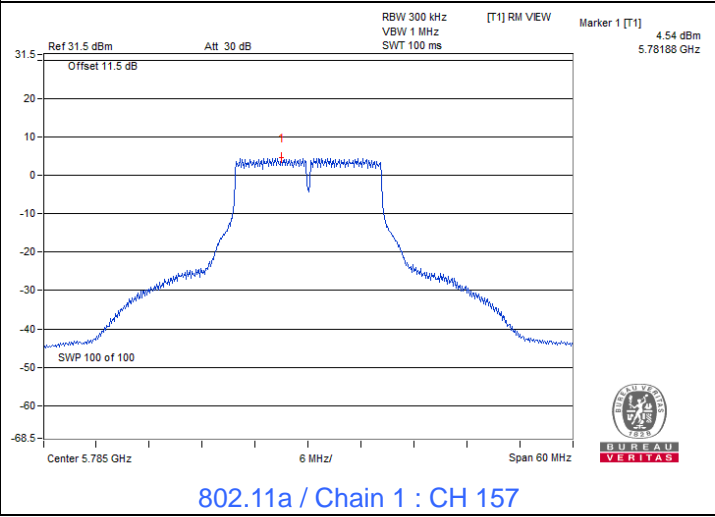
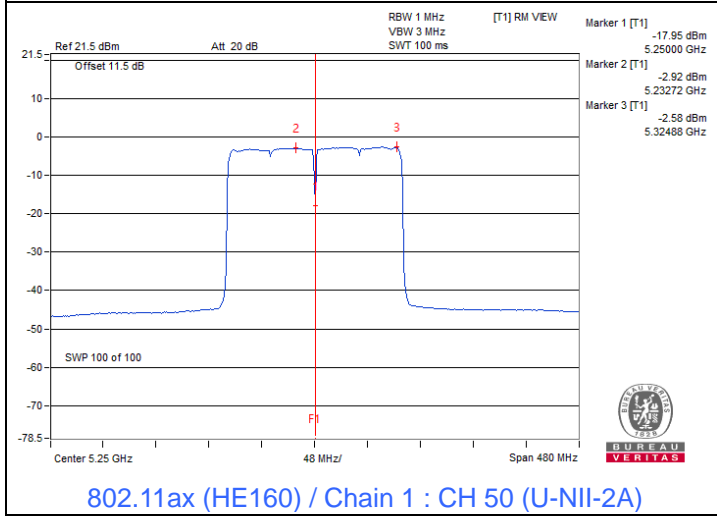
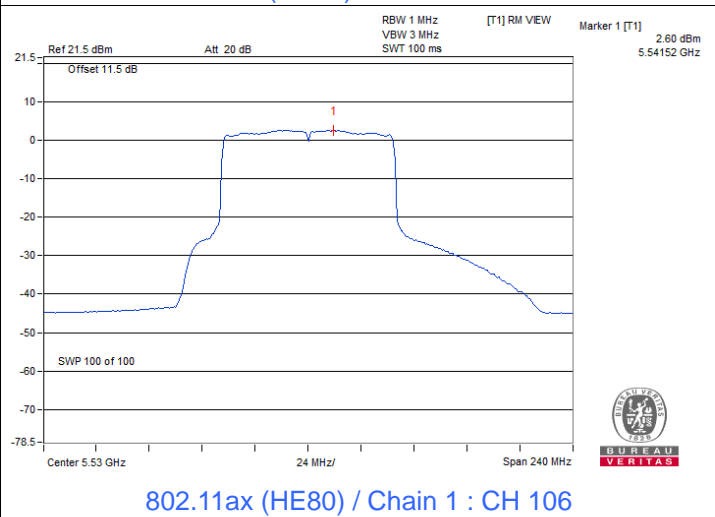
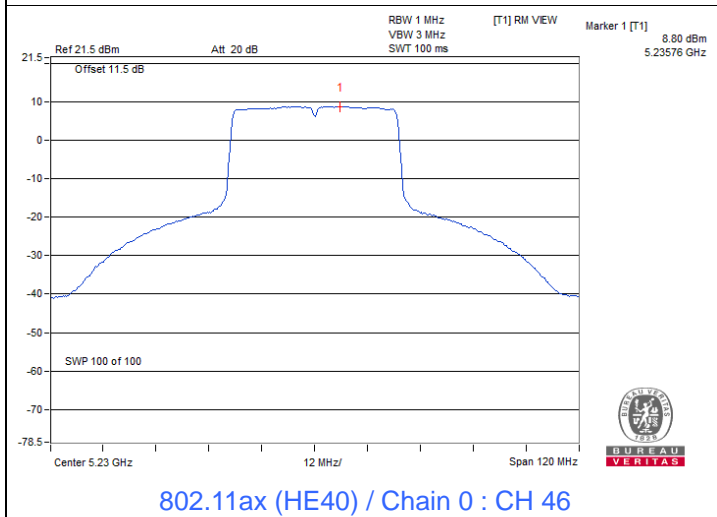
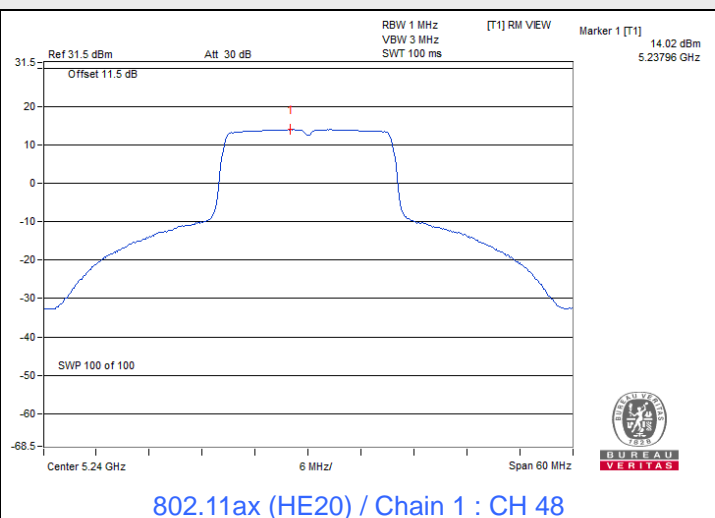
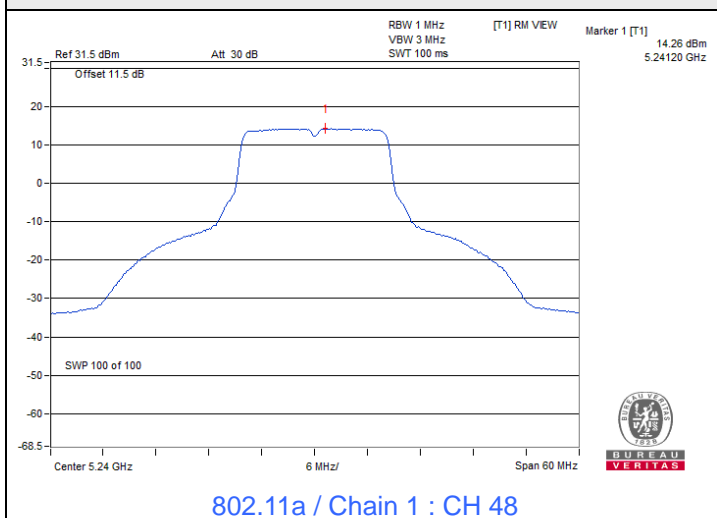

### Spectrum Plot of Maximum Value

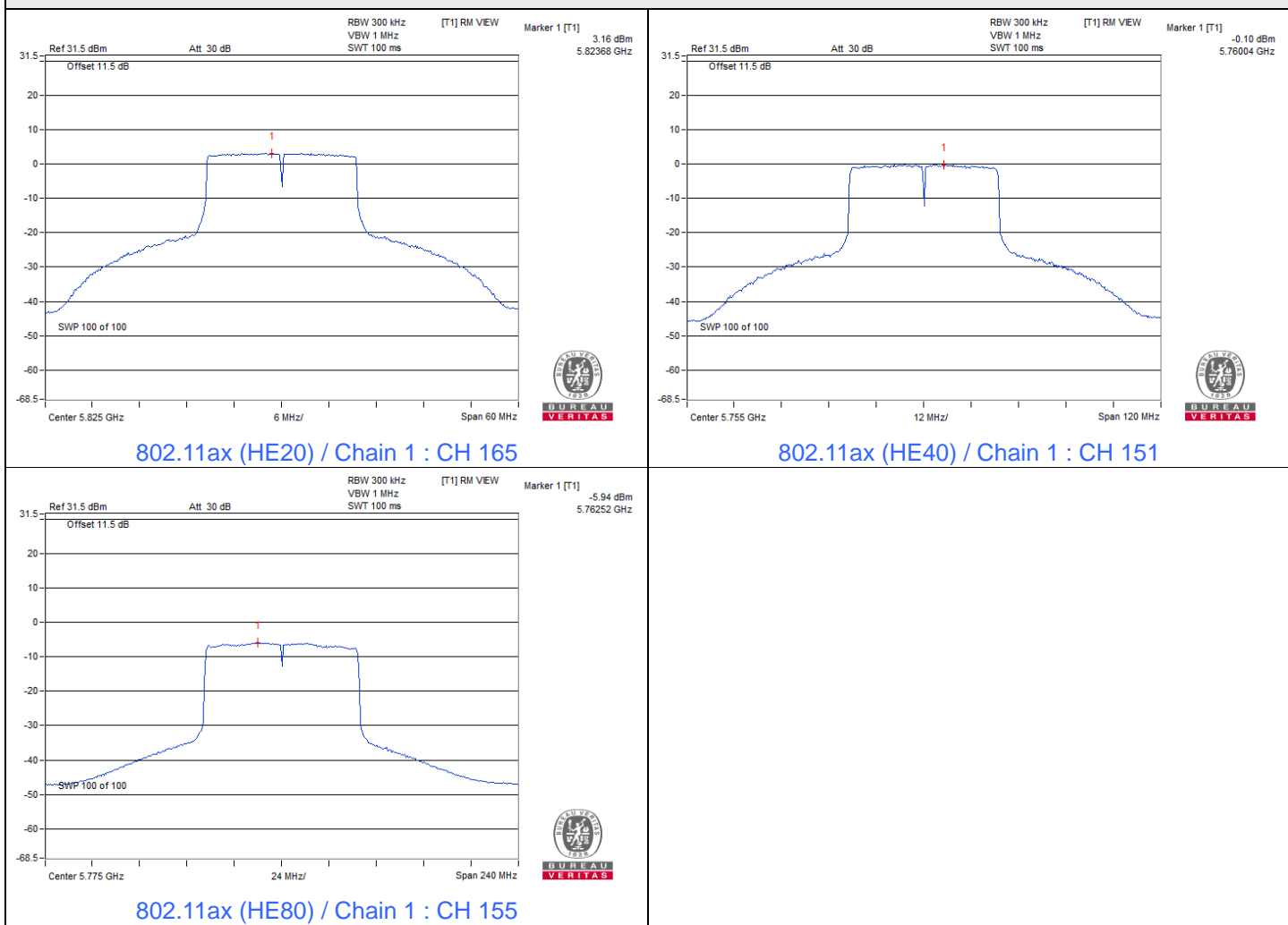

#### 7.4 6 dB Bandwidth

Input Power:	120 Vac, 60 Hz	Environmental Conditions:	25°C, 60% RH	Tested By:	Jisyong Wang
--------------	----------------	---------------------------	--------------	------------	--------------

##### 802.11a

Channel	Frequency (MHz)	6 dB Bandwidth (MHz)		Minimum Limit (MHz)	Test Result
		Chain 0	Chain 1		
144 (U-NII-3)	5720	3.21	3.22	0.5	Pass
149	5745	16.39	16.39	0.5	Pass
157	5785	16.39	16.40	0.5	Pass
165	5825	16.40	16.39	0.5	Pass

##### 802.11ax (HE20)

Channel	Frequency (MHz)	6 dB Bandwidth (MHz)		Minimum Limit (MHz)	Test Result
		Chain 0	Chain 1		
144 (U-NII-3)	5720	4.51	4.52	0.5	Pass
149	5745	19.00	19.00	0.5	Pass
157	5785	18.96	19.01	0.5	Pass
165	5825	19.00	19.03	0.5	Pass

##### 802.11ax (HE40)

Channel	Frequency (MHz)	6 dB Bandwidth (MHz)		Minimum Limit (MHz)	Test Result
		Chain 0	Chain 1		
142 (U-NII-3)	5710	4.00	3.96	0.5	Pass
151	5755	37.76	37.78	0.5	Pass
159	5795	37.81	37.83	0.5	Pass

##### 802.11ax (HE80)

Channel	Frequency (MHz)	6 dB Bandwidth (MHz)		Minimum Limit (MHz)	Test Result
		Chain 0	Chain 1		
138 (U-NII-3)	5690	3.80	3.31	0.5	Pass
155	5775	77.86	77.86	0.5	Pass





### Spectrum Plot of Minimum Value

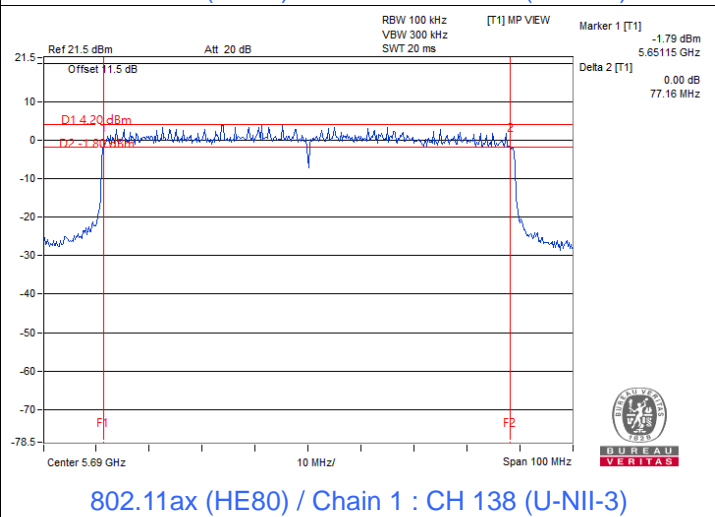
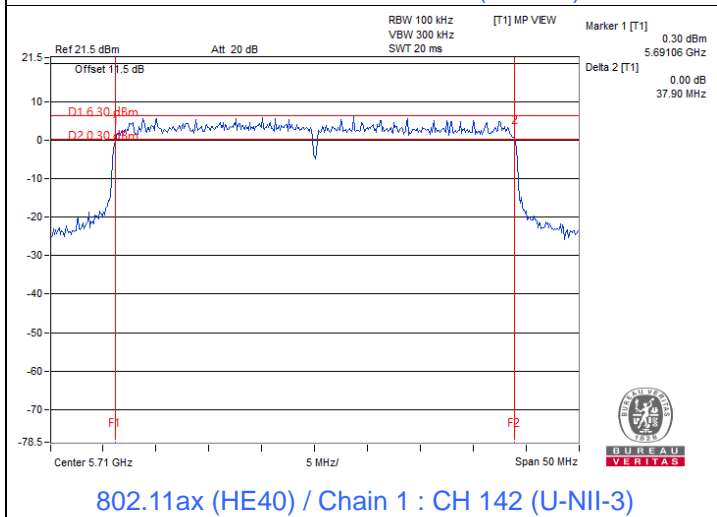
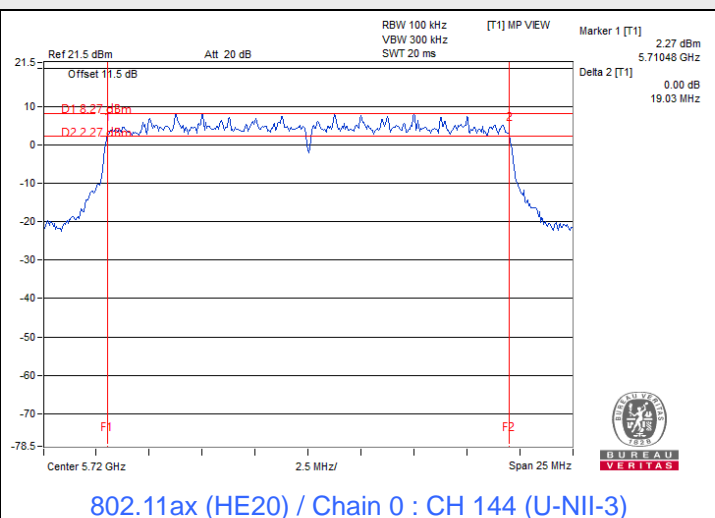
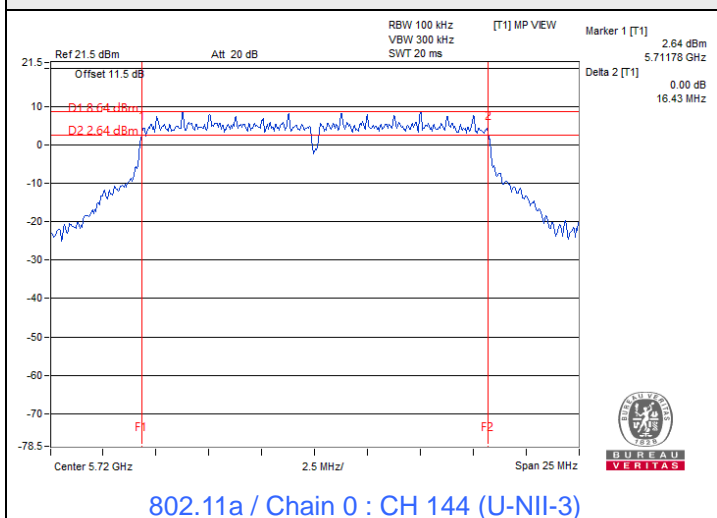

Note: For U-NII-3 straddle channel = Marker 1 + Delta 2 - 5725 MHz

## 7.5 Occupied Bandwidth

Input Power:	120 Vac, 60 Hz	Environmental Conditions:	25°C, 60% RH	Tested By:	Jisyong Wang
--------------	----------------	---------------------------	--------------	------------	--------------

### 802.11a

Channel	Frequency (MHz)	Occupied Bandwidth (MHz)	
		Chain 0	Chain 1
36	5180	17.04	17.28
40	5200	18.00	18.00
48	5240	18.12	18.12
52	5260	17.16	17.16
60	5300	17.16	17.16
64	5320	17.28	17.40
100	5500	17.28	17.28
116	5580	17.28	17.16
140	5700	17.16	17.16
144 (U-NII-2C)	5720	13.64	13.64
144 (U-NII-3)	5720	3.64	3.64
149	5745	17.83	17.92
157	5785	17.83	18.09
165	5825	17.83	18.00

### 802.11ax (HE20)

Channel	Frequency (MHz)	Occupied Bandwidth (MHz)	
		Chain 0	Chain 1
36	5180	19.20	19.32
40	5200	19.32	19.32
48	5240	19.56	19.56
52	5260	19.20	19.20
60	5300	19.20	19.20
64	5320	19.20	19.20
100	5500	19.20	19.20
116	5580	19.20	19.20
140	5700	19.08	19.08
144 (U-NII-2C)	5720	14.60	14.60
144 (U-NII-3)	5720	4.60	4.60
149	5745	19.39	19.39
157	5785	19.39	19.39
165	5825	19.39	19.48

**802.11ax (HE40)**

Channel	Frequency (MHz)	Occupied Bandwidth (MHz)	
		Chain 0	Chain 1
38	5190	38.16	37.92
46	5230	37.92	37.92
54	5270	37.92	37.92
62	5310	37.92	37.92
102	5510	37.92	38.16
110	5550	37.92	38.09
134	5670	37.92	37.92
142 (U-NII-2C)	5710	34.20	34.20
142 (U-NII-3)	5710	3.96	3.96
151	5755	38.26	38.26
159	5795	38.26	38.26

**802.11ax (HE80)**

Channel	Frequency (MHz)	Occupied Bandwidth (MHz)	
		Chain 0	Chain 1
42	5210	77.28	76.80
58	5290	77.76	77.28
106	5530	77.22	77.22
122	5610	77.28	77.28
138 (U-NII-2C)	5690	73.88	73.88
138 (U-NII-3)	5690	3.40	3.40
155	5775	77.22	77.22

**802.11ax (HE160)**

Channel	Frequency (MHz)	Occupied Bandwidth (MHz)	
		Chain 0	Chain 1
50 (U-NII-1)	5250	77.76	78.72
50 (U-NII-2A)	5250	77.76	77.76
114	5570	157.44	156.48



### Spectrum Plot of Maximum Value

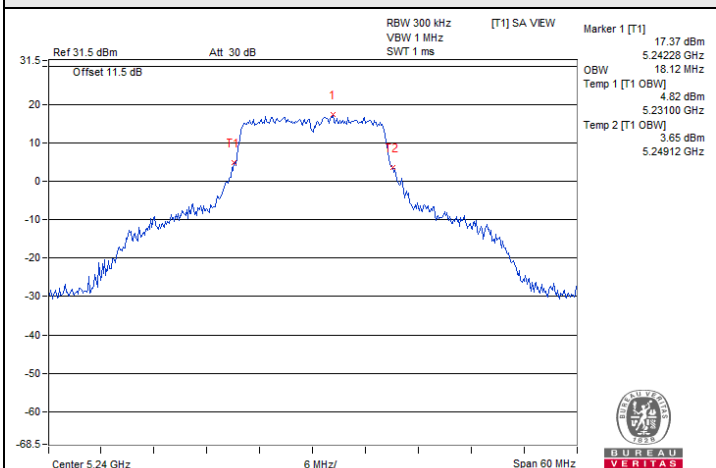

802.11a / Chain 0 : CH 48

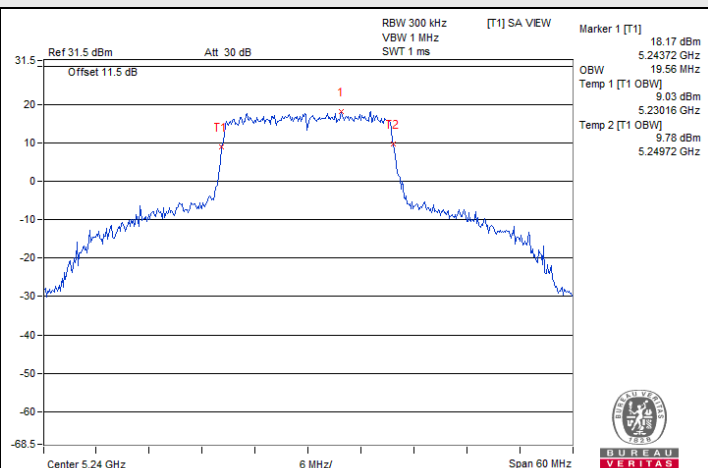

802.11ax (HE20) / Chain 0 : CH 48

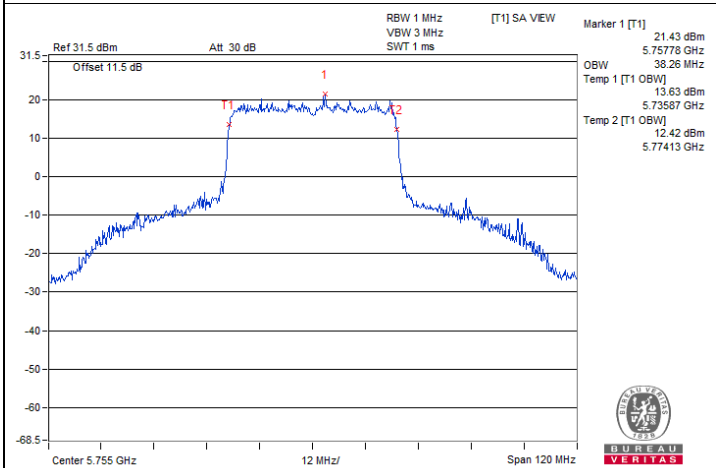

802.11ax (HE40) / Chain 0 : CH 151

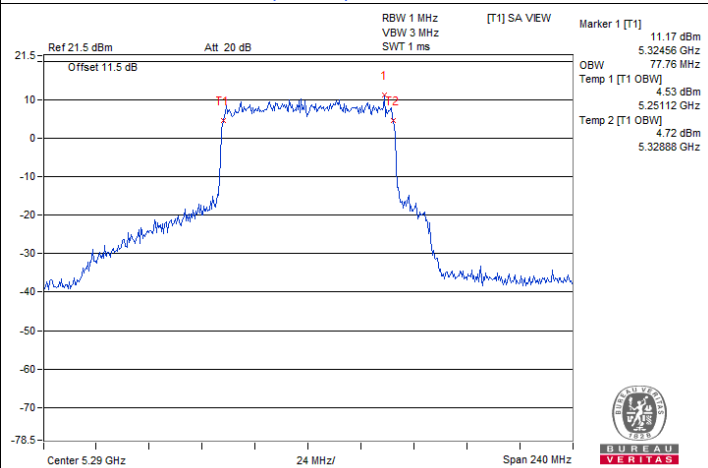

802.11ax (HE80) / Chain 0 : CH 58

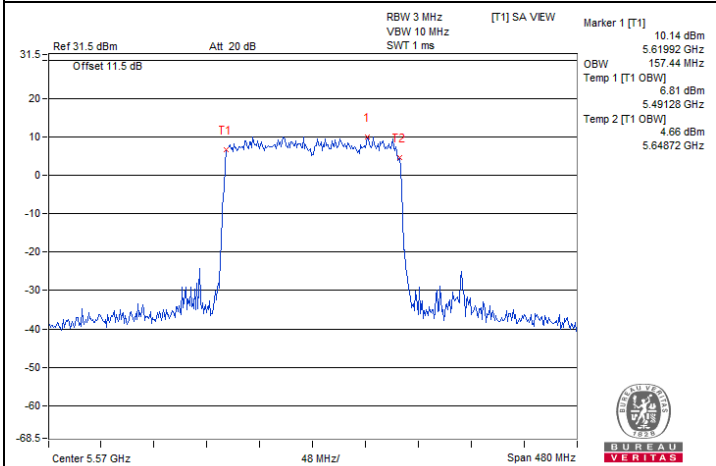

802.11ax (HE160) / Chain 0 : CH 114



### Spectrum Plot for nearby DFS band (DFS is required, if 99% OCP straddle into U-NII-2A)

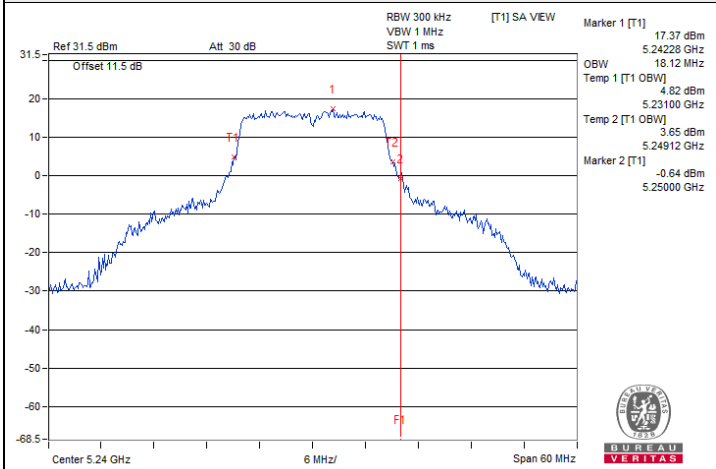

802.11a / Chain 0 : CH 48

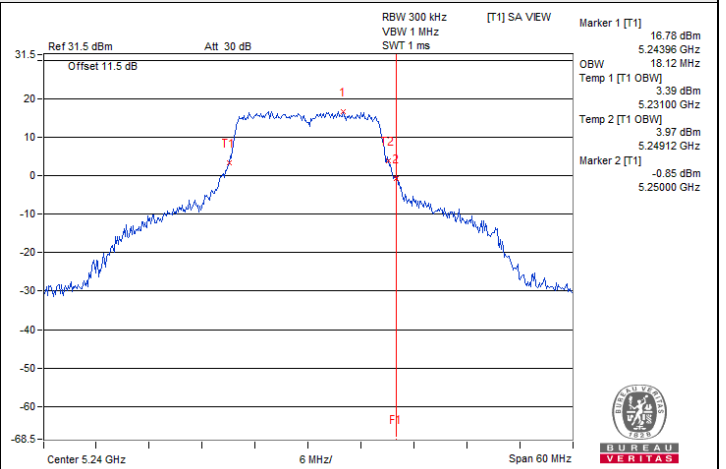

802.11a / Chain 1 : CH 48

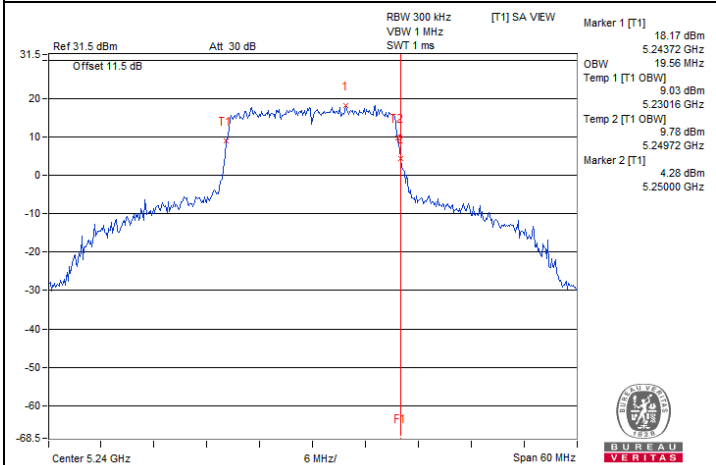

802.11ax (HE20) / Chain 0 : CH 48

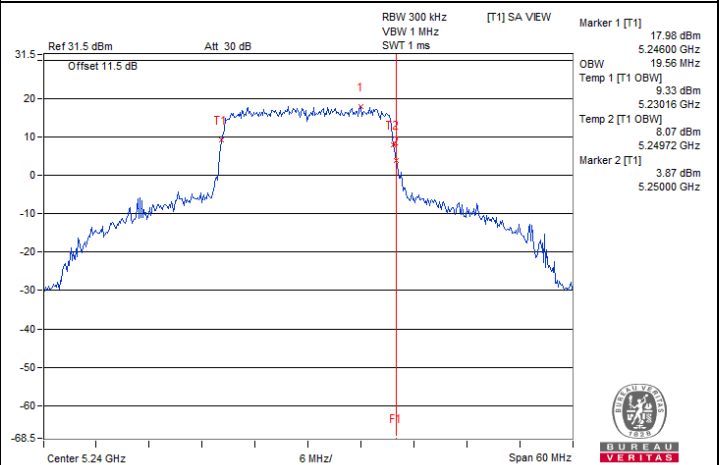

802.11ax (HE20) / Chain 1 : CH 48

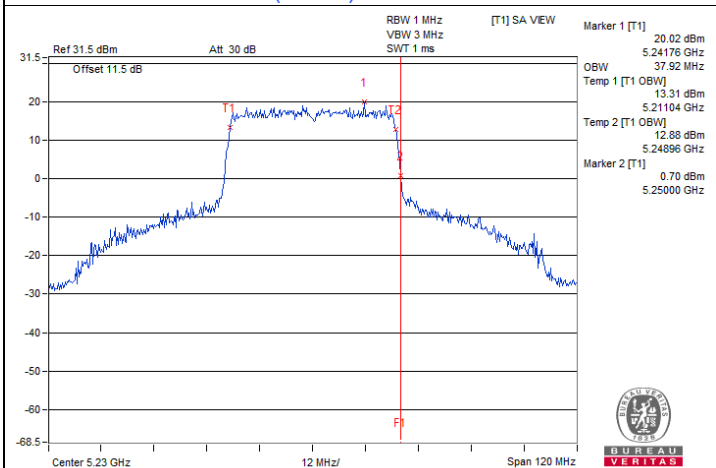

802.11ax (HE40) / Chain 0 : CH 46

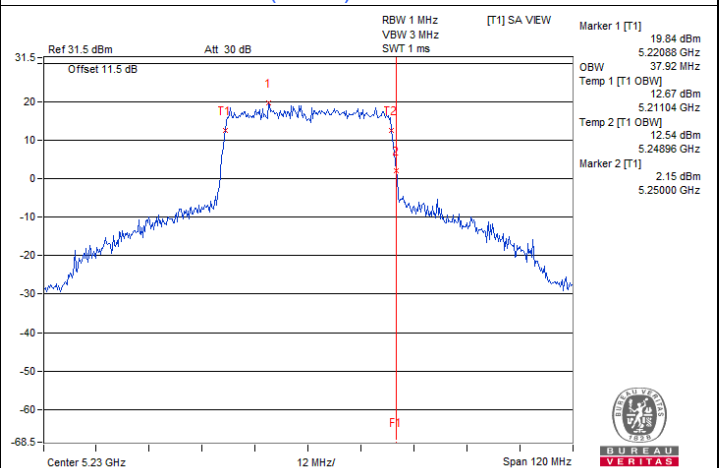

802.11ax (HE40) / Chain 1 : CH 46



### Spectrum Plot for nearby DFS band (DFS is required, if 99% OCP straddle into U-NII-2A)

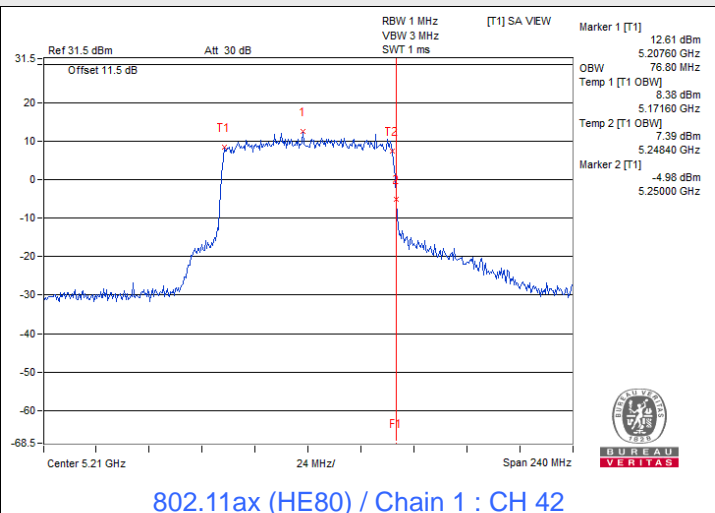
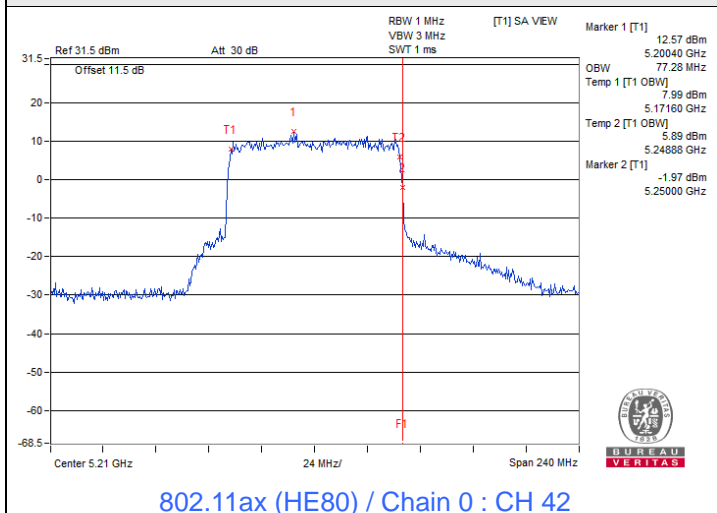

### Spectrum Plot for nearby DFS band (DFS is required, if 99% OCP straddle into U-NII-2C)

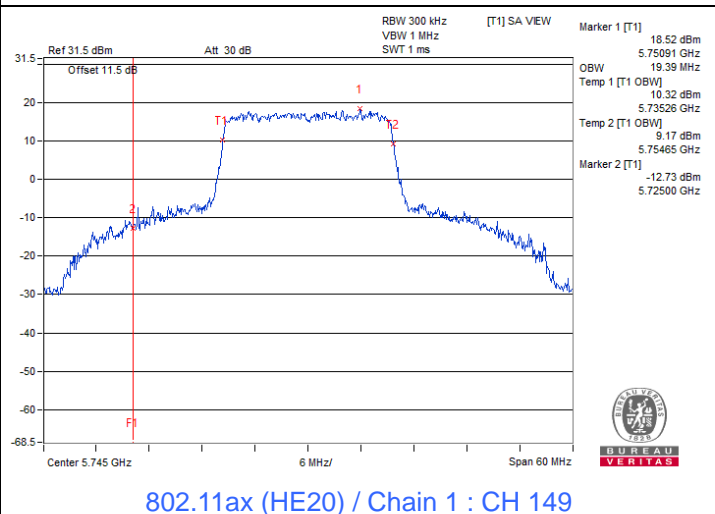
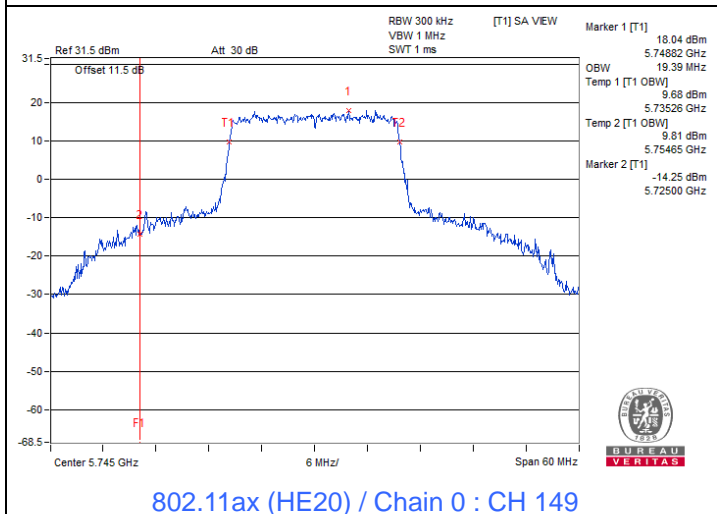
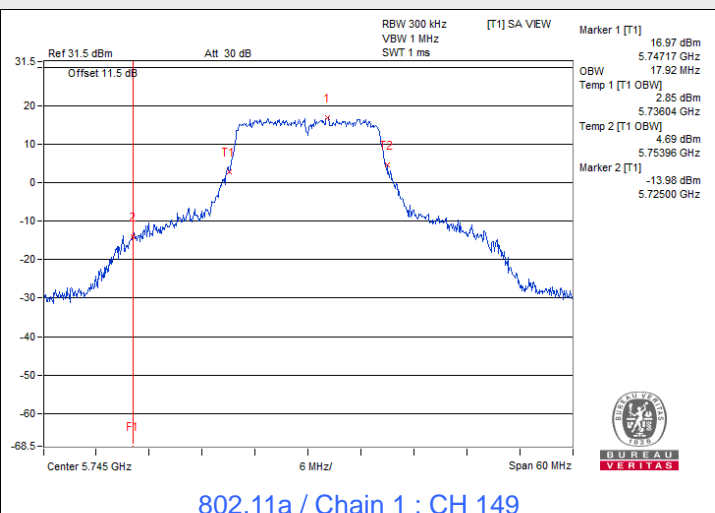
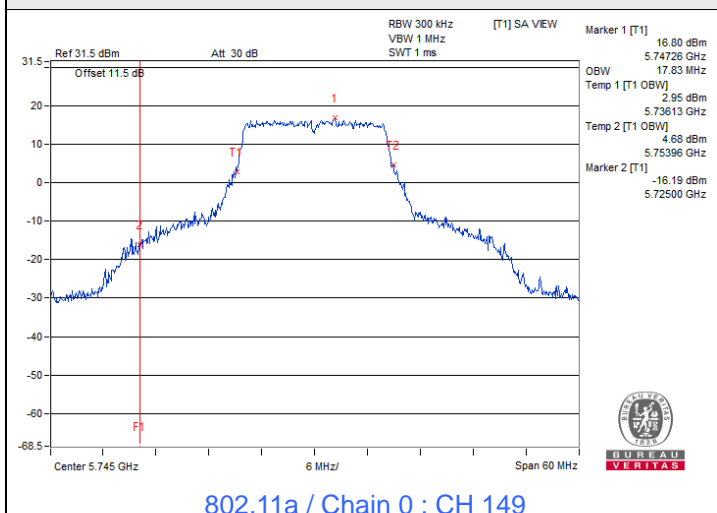



### Spectrum Plot for nearby DFS band (DFS is required, if 99% OCP straddle into U-NII-2C)

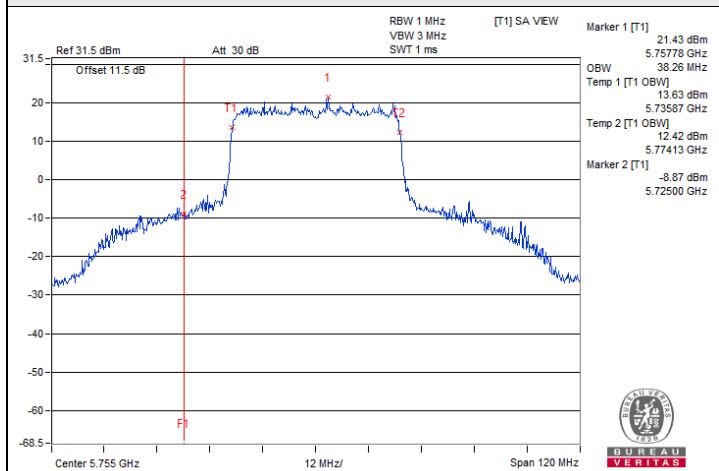

802.11ax (HE40) / Chain 0 : CH 151

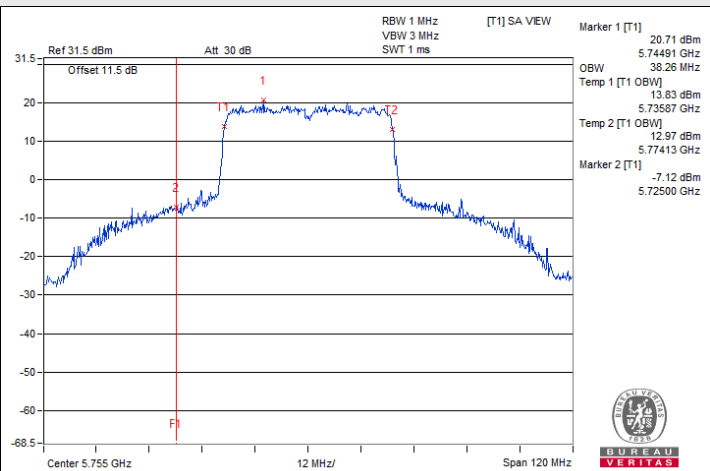

802.11ax (HE40) / Chain 1 : CH 151

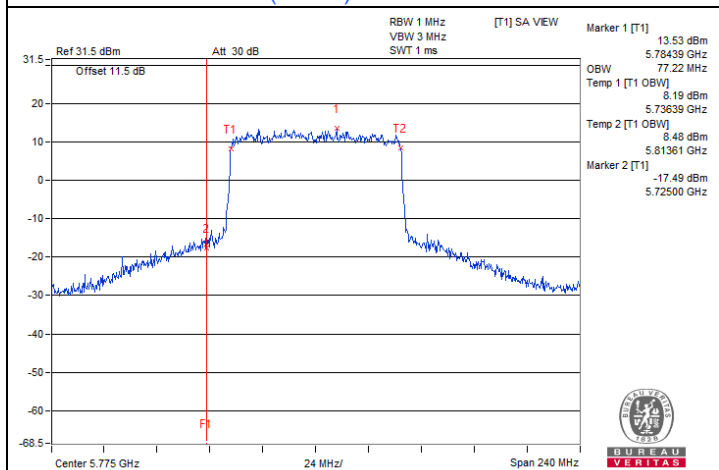

802.11ax (HE80) / Chain 0 : CH 155

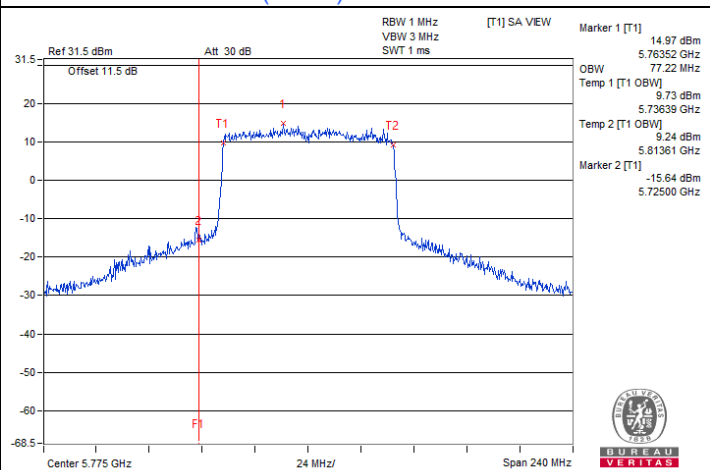

802.11ax (HE80) / Chain 1 : CH 155

## 7.6 Frequency Stability

Input Power:	120 Vac, 60 Hz	Environmental Conditions:	25°C, 60% RH	Tested By:	Jisyong Wang
--------------	----------------	---------------------------	--------------	------------	--------------

### 802.11a

Frequency Stability Versus Temperature									
Operating Frequency: 5180 MHz									
Temp. (°C)	Power Supply (Vac)	0 Minute		2 Minutes		5 Minutes		10 Minutes	
		Measured Frequency (MHz)	Test Result	Measured Frequency (MHz)	Test Result	Measured Frequency (MHz)	Test Result	Measured Frequency (MHz)	Test Result
40	120	5180.0079	Pass	5180.0068	Pass	5180.0088	Pass	5180.0079	Pass
30	120	5179.9942	Pass	5179.9953	Pass	5179.9936	Pass	5179.9935	Pass
20	120	5179.9901	Pass	5179.9876	Pass	5179.9898	Pass	5179.9859	Pass
10	120	5179.9962	Pass	5179.9979	Pass	5179.9965	Pass	5179.9969	Pass
0	120	5180.013	Pass	5180.0128	Pass	5180.0121	Pass	5180.014	Pass

Frequency Stability Versus Voltage									
Operating Frequency: 5180 MHz									
Temp. (°C)	Power Supply (Vac)	0 Minute		2 Minutes		5 Minutes		10 Minutes	
		Measured Frequency (MHz)	Test Result	Measured Frequency (MHz)	Test Result	Measured Frequency (MHz)	Test Result	Measured Frequency (MHz)	Test Result
20	138	5179.9911	Pass	5179.9932	Pass	5179.9957	Pass	5179.9911	Pass
	120	5179.9901	Pass	5179.9876	Pass	5179.9898	Pass	5179.9859	Pass
	102	5179.9788	Pass	5179.9791	Pass	5179.9806	Pass	5179.9775	Pass



## 7.7 AC Power Conducted Emissions

### Mode A

RF Mode	802.11a	Channel	CH 48 : 5240 MHz
Frequency Range	150kHz ~ 30MHz	Detector Function & Resolution Bandwidth	Quasi-Peak (QP) / Average (AV), 9 kHz
Input Power	120 Vac, 60 Hz	Environmental Conditions	25°C, 70% RH
Tested By	Thomas Cheng		

Phase Of Power : Line (L)										
No	Frequency (MHz)	Correction Factor (dB)	Reading Value (dBuV)		Emission Level (dBuV)		Limit (dBuV)		Margin (dB)	
			Q.P.	AV.	Q.P.	AV.	Q.P.	AV.	Q.P.	AV.
1	0.15800	9.62	35.88	18.25	45.50	27.87	65.57	55.57	-20.07	-27.70
2	0.17400	9.63	32.59	17.70	42.22	27.33	64.77	54.77	-22.55	-27.44
3	0.65800	9.68	21.93	16.65	31.61	26.33	56.00	46.00	-24.39	-19.67
4	1.08200	9.69	14.85	6.63	24.54	16.32	56.00	46.00	-31.46	-29.68
5	9.97000	9.79	13.28	7.62	23.07	17.41	60.00	50.00	-36.93	-32.59
6	21.08200	9.77	13.93	7.41	23.70	17.18	60.00	50.00	-36.30	-32.82

#### Remarks:

1. Q.P. and AV. are abbreviations of quasi-peak and average individually.
2. The emission levels of other frequencies were very low against the limit.
3. Margin value = Emission level – Limit value
4. Correction factor = Insertion loss + Cable loss
5. Emission Level = Correction Factor + Reading Value

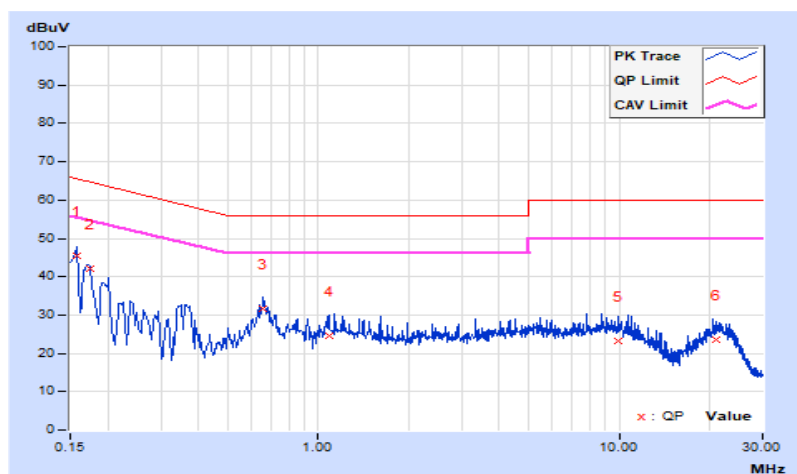

RF Mode	802.11a	Channel	CH 48 : 5240 MHz
Frequency Range	150kHz ~ 30MHz	Detector Function & Resolution Bandwidth	Quasi-Peak (QP) / Average (AV), 9 kHz
Input Power	120 Vac, 60 Hz	Environmental Conditions	25°C, 70% RH
Tested By	Thomas Cheng		

Phase Of Power : Neutral (N)										
No	Frequency (MHz)	Correction Factor (dB)	Reading Value (dBuV)		Emission Level (dBuV)		Limit (dBuV)		Margin (dB)	
			Q.P.	AV.	Q.P.	AV.	Q.P.	AV.	Q.P.	AV.
1	0.15000	9.62	34.42	17.41	44.04	27.03	66.00	56.00	-21.96	-28.97
2	0.16977	9.63	33.27	17.55	42.90	27.18	64.97	54.97	-22.07	-27.79
3	0.68200	9.68	19.64	14.68	29.32	24.36	56.00	46.00	-26.68	-21.64
4	1.13800	9.70	16.53	9.42	26.23	19.12	56.00	46.00	-29.77	-26.88
5	11.31400	9.82	7.07	1.48	16.89	11.30	60.00	50.00	-43.11	-38.70
6	22.21000	9.88	11.95	5.64	21.83	15.52	60.00	50.00	-38.17	-34.48

Remarks:

1. Q.P. and AV. are abbreviations of quasi-peak and average individually.
2. The emission levels of other frequencies were very low against the limit.
3. Margin value = Emission level – Limit value
4. Correction factor = Insertion loss + Cable loss
5. Emission Level = Correction Factor + Reading Value

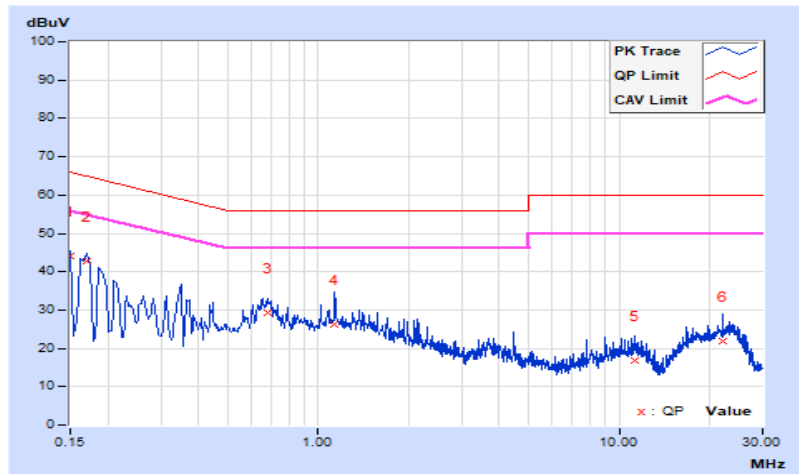

## Mode B

RF Mode	802.11a	Channel	CH 48 : 5240 MHz
Frequency Range	150kHz ~ 30MHz	Detector Function & Resolution Bandwidth	Quasi-Peak (QP) / Average (AV), 9 kHz
Input Power	120 Vac, 60 Hz	Environmental Conditions	25°C, 70% RH
Tested By	Adair Peng		

### Phase Of Power : Line (L)

No	Frequency (MHz)	Correction Factor (dB)	Reading Value (dBuV)		Emission Level (dBuV)		Limit (dBuV)		Margin (dB)	
			Q.P.	AV.	Q.P.	AV.	Q.P.	AV.	Q.P.	AV.
1	0.15400	9.62	39.89	23.60	49.51	33.22	65.78	55.78	-16.27	-22.56
2	0.19800	9.64	28.79	15.75	38.43	25.39	63.69	53.69	-25.26	-28.30
3	0.24600	9.65	25.97	9.09	35.62	18.74	61.89	51.89	-26.27	-33.15
4	0.34600	9.66	18.76	4.36	28.42	14.02	59.06	49.06	-30.64	-35.04
5	2.91000	9.72	9.49	1.26	19.21	10.98	56.00	46.00	-36.79	-35.02
<b>6</b>	<b>16.69400</b>	<b>9.78</b>	<b>31.52</b>	<b>25.38</b>	<b>41.30</b>	<b>35.16</b>	<b>60.00</b>	<b>50.00</b>	<b>-18.70</b>	<b>-14.84</b>

#### Remarks:

1. Q.P. and AV. are abbreviations of quasi-peak and average individually.
2. The emission levels of other frequencies were very low against the limit.
3. Margin value = Emission level – Limit value
4. Correction factor = Insertion loss + Cable loss
5. Emission Level = Correction Factor + Reading Value

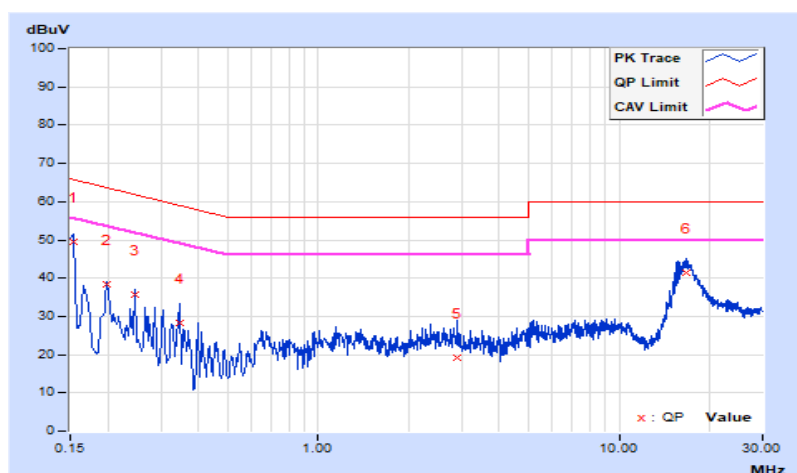

RF Mode	802.11a	Channel	CH 48 : 5240 MHz
Frequency Range	150kHz ~ 30MHz	Detector Function & Resolution Bandwidth	Quasi-Peak (QP) / Average (AV), 9 kHz
Input Power	120 Vac, 60 Hz	Environmental Conditions	25°C, 70% RH
Tested By	Adair Peng		

Phase Of Power : Neutral (N)										
No	Frequency (MHz)	Correction Factor (dB)	Reading Value (dBuV)		Emission Level (dBuV)		Limit (dBuV)		Margin (dB)	
			Q.P.	AV.	Q.P.	AV.	Q.P.	AV.	Q.P.	AV.
1	0.15800	9.62	39.04	23.44	48.66	33.06	65.57	55.57	-16.91	-22.51
2	0.18200	9.63	33.14	15.86	42.77	25.49	64.39	54.39	-21.62	-28.90
3	0.19400	9.64	32.56	17.45	42.20	27.09	63.86	53.86	-21.66	-26.77
4	0.37800	9.67	29.39	18.29	39.06	27.96	58.32	48.32	-19.26	-20.36
5	5.42200	9.76	9.06	1.66	18.82	11.42	60.00	50.00	-41.18	-38.58
6	16.82200	9.86	29.45	23.60	39.31	33.46	60.00	50.00	-20.69	-16.54

Remarks:

1. Q.P. and AV. are abbreviations of quasi-peak and average individually.
2. The emission levels of other frequencies were very low against the limit.
3. Margin value = Emission level – Limit value
4. Correction factor = Insertion loss + Cable loss
5. Emission Level = Correction Factor + Reading Value

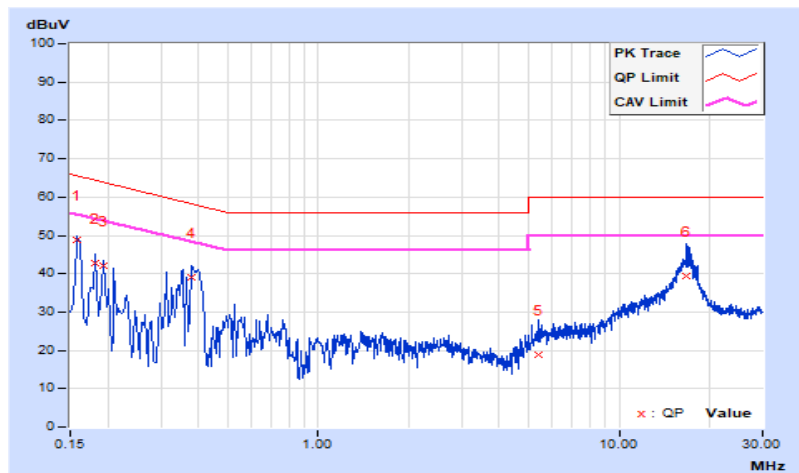

## 7.8 Unwanted Emissions below 1 GHz

### Mode A

RF Mode	802.11a	Channel	CH 48 : 5240 MHz
Frequency Range	30 MHz ~ 1 GHz	Detector Function & Bandwidth	Quasi-Peak (QP), RB = 120kHz
Input Power	120 Vac, 60 Hz	Environmental Conditions	23°C, 67% RH
Tested By	Adair Peng		

Antenna Polarity & Test Distance : Horizontal at 3 m								
No	Frequency (MHz)	Emission Level (dBuV/m)	Limit (dBuV/m)	Margin (dB)	Antenna Height (m)	Table Angle (Degree)	Raw Value (dBuV)	Correction Factor (dB/m)
1	55.22	35.2 QP	40.0	-4.8	1.00 H	335	44.2	-9.0
2	63.95	34.7 QP	40.0	-5.3	1.49 H	17	44.9	-10.2
3	95.96	37.0 QP	43.5	-6.5	1.49 H	159	51.1	-14.1
4	119.24	39.3 QP	43.5	-4.2	1.49 H	114	50.5	-11.2
5	167.74	34.2 QP	43.5	-9.3	1.00 H	313	43.1	-8.9
6	500.45	35.3 QP	46.0	-10.7	1.99 H	316	37.8	-2.5

#### Remarks:

1. Emission Level(dBuV/m) = Raw Value(dBuV) + Correction Factor(dB/m)
2. Correction Factor(dB/m) = Antenna Factor(dB/m) + Cable Factor(dB) – Pre-Amplifier Factor(dB)
3. Margin value = Emission Level – Limit value
4. The other emission levels were very low against the limit of frequency range 30 MHz ~ 1 GHz.
5. The emission levels were very low against the limit of frequency range 9 kHz ~ 30 MHz: the amplitude of spurious emissions attenuated more than 20 dB below the permissible value to be report.

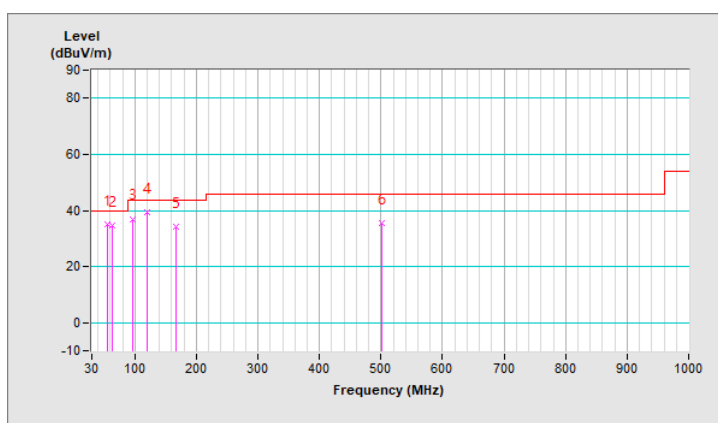

RF Mode	802.11a	Channel	CH 48 : 5240 MHz
Frequency Range	30 MHz ~ 1 GHz	Detector Function & Bandwidth	Quasi-Peak (QP), RB = 120kHz
Input Power	120 Vac, 60 Hz	Environmental Conditions	23°C, 67% RH
Tested By	Adair Peng		

Antenna Polarity & Test Distance : Vertical at 3 m								
No	Frequency (MHz)	Emission Level (dBuV/m)	Limit (dBuV/m)	Margin (dB)	Antenna Height (m)	Table Angle (Degree)	Raw Value (dBuV)	Correction Factor (dB/m)
1	63.95	36.0 QP	40.0	-4.0	1.00 V	164	46.2	-10.2
2	98.87	37.3 QP	43.5	-6.2	1.99 V	60	50.9	-13.6
3	119.24	38.9 QP	43.5	-4.6	1.51 V	0	50.1	-11.2
4	375.32	27.3 QP	46.0	-18.7	1.00 V	282	32.5	-5.2
5	552.83	31.1 QP	46.0	-14.9	1.00 V	128	32.7	-1.6
6	651.77	31.4 QP	46.0	-14.6	1.51 V	173	30.8	0.6

Remarks:

1. Emission Level(dBuV/m) = Raw Value(dBuV) + Correction Factor(dB/m)
2. Correction Factor(dB/m) = Antenna Factor(dB/m) + Cable Factor(dB) – Pre-Amplifier Factor(dB)
3. Margin value = Emission Level – Limit value
4. The other emission levels were very low against the limit of frequency range 30 MHz ~ 1 GHz.
5. The emission levels were very low against the limit of frequency range 9 kHz ~ 30 MHz: the amplitude of spurious emissions attenuated more than 20 dB below the permissible value to be report.

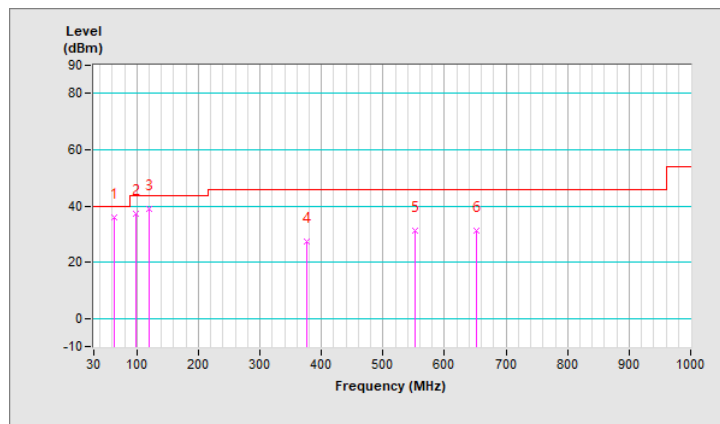

## Mode B

RF Mode	802.11a	Channel	CH 48 : 5240 MHz
Frequency Range	30 MHz ~ 1 GHz	Detector Function & Bandwidth	Quasi-Peak (QP), RB = 120kHz
Input Power	120 Vac, 60 Hz	Environmental Conditions	23°C, 67% RH
Tested By	Adair Peng		

Antenna Polarity & Test Distance : Horizontal at 3 m								
No	Frequency (MHz)	Emission Level (dBuV/m)	Limit (dBuV/m)	Margin (dB)	Antenna Height (m)	Table Angle (Degree)	Raw Value (dBuV)	Correction Factor (dB/m)
1	55.22	35.8 QP	40.0	-4.2	1.49 H	180	45.2	-9.4
2	95.96	35.9 QP	43.5	-7.6	1.00 H	234	50.3	-14.4
3	111.48	33.0 QP	43.5	-10.5	1.99 H	172	45.1	-12.1
4	135.73	31.9 QP	43.5	-11.6	1.99 H	22	41.7	-9.8
5	167.74	31.0 QP	43.5	-12.5	1.00 H	297	40.2	-9.2
6	528.58	32.1 QP	46.0	-13.9	1.49 H	225	35.6	-3.5

### Remarks:

1. Emission Level(dBuV/m) = Raw Value(dBuV) + Correction Factor(dB/m)
2. Correction Factor(dB/m) = Antenna Factor(dB/m) + Cable Factor(dB) – Pre-Amplifier Factor(dB)
3. Margin value = Emission Level – Limit value
4. The other emission levels were very low against the limit of frequency range 30 MHz ~ 1 GHz.
5. The emission levels were very low against the limit of frequency range 9 kHz ~ 30 MHz: the amplitude of spurious emissions attenuated more than 20 dB below the permissible value to be report.

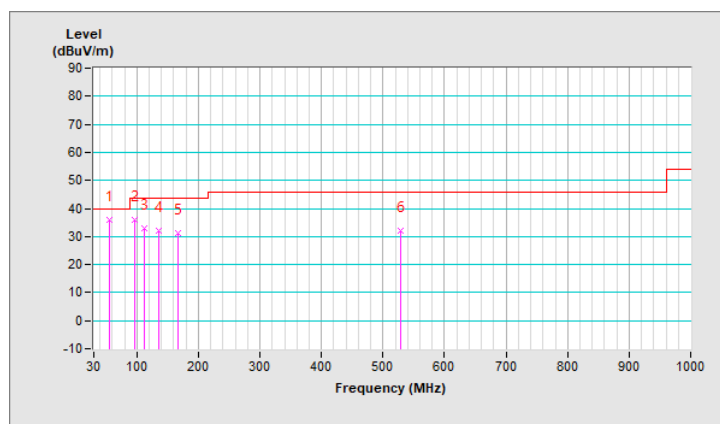

RF Mode	802.11a	Channel	CH 48 : 5240 MHz
Frequency Range	30 MHz ~ 1 GHz	Detector Function & Bandwidth	Quasi-Peak (QP), RB = 120kHz
Input Power	120 Vac, 60 Hz	Environmental Conditions	23°C, 67% RH
Tested By	Adair Peng		

Antenna Polarity & Test Distance : Vertical at 3 m								
No	Frequency (MHz)	Emission Level (dBuV/m)	Limit (dBuV/m)	Margin (dB)	Antenna Height (m)	Table Angle (Degree)	Raw Value (dBuV)	Correction Factor (dB/m)
1	60.07	35.5 QP	40.0	-4.5	2.00 V	6	45.3	-9.8
2	95.96	35.2 QP	43.5	-8.3	1.00 V	260	49.6	-14.4
3	135.73	31.8 QP	43.5	-11.7	2.00 V	241	41.6	-9.8
4	167.74	30.7 QP	43.5	-12.8	1.00 V	168	39.9	-9.2
5	467.47	29.3 QP	46.0	-16.7	1.00 V	132	33.9	-4.6
6	696.39	30.5 QP	46.0	-15.5	1.50 V	118	30.5	0.0

Remarks:

1. Emission Level(dBuV/m) = Raw Value(dBuV) + Correction Factor(dB/m)
2. Correction Factor(dB/m) = Antenna Factor(dB/m) + Cable Factor(dB) – Pre-Amplifier Factor(dB)
3. Margin value = Emission Level – Limit value
4. The other emission levels were very low against the limit of frequency range 30 MHz ~ 1 GHz.
5. The emission levels were very low against the limit of frequency range 9 kHz ~ 30 MHz: the amplitude of spurious emissions attenuated more than 20 dB below the permissible value to be report.

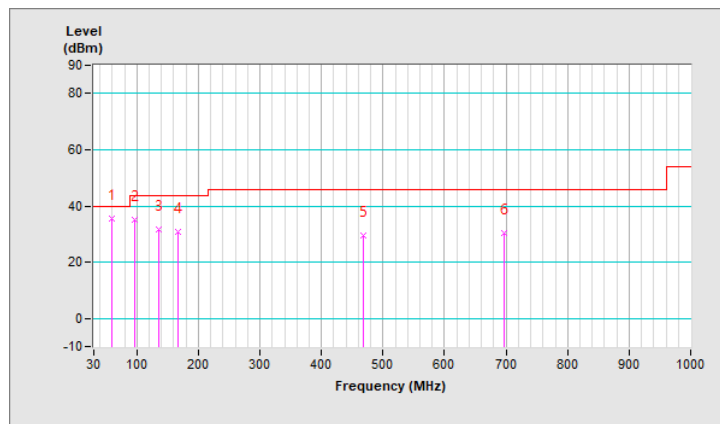



## 7.9 Unwanted Emissions above 1 GHz

RF Mode	802.11a	Channel	CH 36 : 5180 MHz
Frequency Range	1 GHz ~ 40 GHz	Detector Function & Bandwidth	Peak (PK), RB = 1 MHz, VB = 3 MHz Peak (AV), RB = 1 MHz, VB = 10 Hz
Input Power	120 Vac, 60 Hz	Environmental Conditions	23°C, 67% RH
Tested By	Adair Peng		

Antenna Polarity & Test Distance : Horizontal at 3 m								
No	Frequency (MHz)	Emission Level (dBuV/m)	Limit (dBuV/m)	Margin (dB)	Antenna Height (m)	Table Angle (Degree)	Raw Value (dBuV)	Correction Factor (dB/m)
1	5150.00	65.8 PK	74.0	-8.2	2.80 H	189	44.8	21.0
2	5150.00	53.1 AV	54.0	-0.9	2.80 H	189	32.1	21.0
3	*5180.00	122.2 PK			2.80 H	189	81.0	41.2
4	*5180.00	112.8 AV			2.80 H	189	71.6	41.2
5	#10360.00	61.5 PK	68.2	-6.7	2.35 H	158	37.1	24.4
Antenna Polarity & Test Distance : Vertical at 3 m								
No	Frequency (MHz)	Emission Level (dBuV/m)	Limit (dBuV/m)	Margin (dB)	Antenna Height (m)	Table Angle (Degree)	Raw Value (dBuV)	Correction Factor (dB/m)
1	5150.00	61.1 PK	74.0	-12.9	3.09 V	266	40.1	21.0
2	5150.00	48.1 AV	54.0	-5.9	3.09 V	266	27.1	21.0
3	*5180.00	112.2 PK			3.09 V	266	71.0	41.2
4	*5180.00	102.7 AV			3.09 V	266	61.5	41.2
5	#10360.00	61.3 PK	68.2	-6.9	3.26 V	297	36.9	24.4

### Remarks:

1. Emission Level(dBuV/m) = Raw Value(dBuV) + Correction Factor(dB/m)
2. Correction Factor(dB/m) = Antenna Factor(dB/m) + Cable Factor(dB) – Pre-Amplifier Factor(dB)
3. Margin value = Emission Level – Limit value
4. The other emission levels were very low against the limit.
5. " \* " : Fundamental frequency, the limit was restricted at the RF Output Power.
6. " # " : The radiated frequency is out of the restricted band.

RF Mode	802.11a	Channel	CH 40 : 5200 MHz
Frequency Range	1 GHz ~ 40 GHz	Detector Function & Bandwidth	Peak (PK), RB = 1 MHz, VB = 3 MHz Peak (AV), RB = 1 MHz, VB = 10 Hz
Input Power	120 Vac, 60 Hz	Environmental Conditions	23°C, 67% RH
Tested By	Adair Peng		

Antenna Polarity & Test Distance : Horizontal at 3 m								
No	Frequency (MHz)	Emission Level (dBuV/m)	Limit (dBuV/m)	Margin (dB)	Antenna Height (m)	Table Angle (Degree)	Raw Value (dBuV)	Correction Factor (dB/m)
1	5150.00	68.6 PK	74.0	-5.4	3.35 H	192	47.6	21.0
2	5150.00	53.7 AV	54.0	-0.3	3.35 H	192	32.7	21.0
3	*5200.00	125.9 PK			3.35 H	192	84.8	41.1
4	*5200.00	116.3 AV			3.35 H	192	75.2	41.1
5	#10400.00	61.9 PK	68.2	-6.3	2.39 H	161	37.3	24.6

Antenna Polarity & Test Distance : Vertical at 3 m								
No	Frequency (MHz)	Emission Level (dBuV/m)	Limit (dBuV/m)	Margin (dB)	Antenna Height (m)	Table Angle (Degree)	Raw Value (dBuV)	Correction Factor (dB/m)
1	5150.00	61.2 PK	74.0	-12.8	3.27 V	287	40.2	21.0
2	5150.00	47.9 AV	54.0	-6.1	3.27 V	287	26.9	21.0
3	*5200.00	117.2 PK			3.27 V	287	76.1	41.1
4	*5200.00	107.7 AV			3.27 V	287	66.6	41.1
5	#10400.00	61.7 PK	68.2	-6.5	3.23 V	295	37.1	24.6

**Remarks:**

1. Emission Level(dBuV/m) = Raw Value(dBuV) + Correction Factor(dB/m)
2. Correction Factor(dB/m) = Antenna Factor(dB/m) + Cable Factor(dB) – Pre-Amplifier Factor(dB)
3. Margin value = Emission Level – Limit value
4. The other emission levels were very low against the limit.
5. " \* ": Fundamental frequency, the limit was restricted at the RF Output Power.
6. " # ": The radiated frequency is out of the restricted band.



RF Mode	802.11a	Channel	CH 48 : 5240 MHz
Frequency Range	1 GHz ~ 40 GHz	Detector Function & Bandwidth	Peak (PK), RB = 1 MHz, VB = 3 MHz Peak (AV), RB = 1 MHz, VB = 10 Hz
Input Power	120 Vac, 60 Hz	Environmental Conditions	23°C, 67% RH
Tested By	Adair Peng		

Antenna Polarity & Test Distance : Horizontal at 3 m								
No	Frequency (MHz)	Emission Level (dBuV/m)	Limit (dBuV/m)	Margin (dB)	Antenna Height (m)	Table Angle (Degree)	Raw Value (dBuV)	Correction Factor (dB/m)
1	*5240.00	121.4 PK			3.28 H	16	80.5	40.9
2	*5240.00	112.3 AV			3.28 H	16	71.4	40.9
3	5350.00	59.8 PK	74.0	-14.2	3.28 H	16	38.8	21.0
4	5350.00	48.9 AV	54.0	-5.1	3.28 H	16	27.9	21.0
5	#10480.00	63.2 PK	68.2	-5.0	2.21 H	185	38.3	24.9

Antenna Polarity & Test Distance : Vertical at 3 m								
No	Frequency (MHz)	Emission Level (dBuV/m)	Limit (dBuV/m)	Margin (dB)	Antenna Height (m)	Table Angle (Degree)	Raw Value (dBuV)	Correction Factor (dB/m)
1	*5240.00	117.4 PK			3.72 V	289	76.5	40.9
2	*5240.00	107.8 AV			3.72 V	289	66.9	40.9
3	5350.00	57.8 PK	74.0	-16.2	3.72 V	289	36.8	21.0
4	5350.00	47.4 AV	54.0	-6.6	3.72 V	289	26.4	21.0
5	#10480.00	62.8 PK	68.2	-5.4	2.98 V	286	37.9	24.9

Remarks:

1. Emission Level(dBuV/m) = Raw Value(dBuV) + Correction Factor(dB/m)
2. Correction Factor(dB/m) = Antenna Factor(dB/m) + Cable Factor(dB) – Pre-Amplifier Factor(dB)
3. Margin value = Emission Level – Limit value
4. The other emission levels were very low against the limit.
5. " \* ": Fundamental frequency, the limit was restricted at the RF Output Power.
6. " # ": The radiated frequency is out of the restricted band.



RF Mode	802.11a	Channel	CH 52 : 5260 MHz
Frequency Range	1 GHz ~ 40 GHz	Detector Function & Bandwidth	Peak (PK), RB = 1 MHz, VB = 3 MHz Peak (AV), RB = 1 MHz, VB = 10 Hz
Input Power	120 Vac, 60 Hz	Environmental Conditions	23°C, 67% RH
Tested By	Adair Peng		

Antenna Polarity & Test Distance : Horizontal at 3 m

No	Frequency (MHz)	Emission Level (dBuV/m)	Limit (dBuV/m)	Margin (dB)	Antenna Height (m)	Table Angle (Degree)	Raw Value (dBuV)	Correction Factor (dB/m)
1	5150.00	61.1 PK	74.0	-12.9	2.37 H	191	40.1	21.0
2	5150.00	48.8 AV	54.0	-5.2	2.37 H	191	27.8	21.0
3	*5260.00	118.2 PK			2.37 H	191	77.4	40.8
4	*5260.00	108.8 AV			2.37 H	191	68.0	40.8
5	#10520.00	62.5 PK	68.2	-5.7	2.24 H	166	37.5	25.0

Antenna Polarity & Test Distance : Vertical at 3 m

No	Frequency (MHz)	Emission Level (dBuV/m)	Limit (dBuV/m)	Margin (dB)	Antenna Height (m)	Table Angle (Degree)	Raw Value (dBuV)	Correction Factor (dB/m)
1	5150.00	60.6 PK	74.0	-13.4	2.89 V	277	39.6	21.0
2	5150.00	48.4 AV	54.0	-5.6	2.89 V	277	27.4	21.0
3	*5260.00	114.7 PK			2.89 V	277	73.9	40.8
4	*5260.00	105.5 AV			2.89 V	277	64.7	40.8
5	#10520.00	62.4 PK	68.2	-5.8	3.10 V	293	37.4	25.0

Remarks:

1. Emission Level(dBuV/m) = Raw Value(dBuV) + Correction Factor(dB/m)
2. Correction Factor(dB/m) = Antenna Factor(dB/m) + Cable Factor(dB) – Pre-Amplifier Factor(dB)
3. Margin value = Emission Level – Limit value
4. The other emission levels were very low against the limit.
5. " \* ": Fundamental frequency, the limit was restricted at the RF Output Power.
6. " # ": The radiated frequency is out of the restricted band.



RF Mode	802.11a	Channel	CH 60 : 5300 MHz
Frequency Range	1 GHz ~ 40 GHz	Detector Function & Bandwidth	Peak (PK), RB = 1 MHz, VB = 3 MHz Peak (AV), RB = 1 MHz, VB = 10 Hz
Input Power	120 Vac, 60 Hz	Environmental Conditions	23°C, 67% RH
Tested By	Adair Peng		

Antenna Polarity & Test Distance : Horizontal at 3 m

No	Frequency (MHz)	Emission Level (dBuV/m)	Limit (dBuV/m)	Margin (dB)	Antenna Height (m)	Table Angle (Degree)	Raw Value (dBuV)	Correction Factor (dB/m)
1	*5300.00	117.2 PK			2.69 H	176	76.4	40.8
2	*5300.00	107.8 AV			2.69 H	176	67.0	40.8
3	10600.00	62.3 PK	74.0	-11.7	2.33 H	165	37.3	25.0
4	10600.00	49.4 AV	54.0	-4.6	2.33 H	165	24.4	25.0

Antenna Polarity & Test Distance : Vertical at 3 m

No	Frequency (MHz)	Emission Level (dBuV/m)	Limit (dBuV/m)	Margin (dB)	Antenna Height (m)	Table Angle (Degree)	Raw Value (dBuV)	Correction Factor (dB/m)
1	*5300.00	114.8 PK			2.84 V	275	74.0	40.8
2	*5300.00	105.4 AV			2.84 V	275	64.6	40.8
3	10600.00	62.0 PK	74.0	-12.0	3.14 V	296	37.0	25.0
4	10600.00	49.2 AV	54.0	-4.8	3.14 V	296	24.2	25.0

Remarks:

1. Emission Level(dBuV/m) = Raw Value(dBuV) + Correction Factor(dB/m)
2. Correction Factor(dB/m) = Antenna Factor(dB/m) + Cable Factor(dB) – Pre-Amplifier Factor(dB)
3. Margin value = Emission Level – Limit value
4. The other emission levels were very low against the limit.
5. " \* " : Fundamental frequency, the limit was restricted at the RF Output Power.

RF Mode	802.11a	Channel	CH 64 : 5320 MHz
Frequency Range	1 GHz ~ 40 GHz	Detector Function & Bandwidth	Peak (PK), RB = 1 MHz, VB = 3 MHz Peak (AV), RB = 1 MHz, VB = 10 Hz
Input Power	120 Vac, 60 Hz	Environmental Conditions	23°C, 67% RH
Tested By	Adair Peng		

Antenna Polarity & Test Distance : Horizontal at 3 m								
No	Frequency (MHz)	Emission Level (dBuV/m)	Limit (dBuV/m)	Margin (dB)	Antenna Height (m)	Table Angle (Degree)	Raw Value (dBuV)	Correction Factor (dB/m)
1	*5320.00	117.9 PK			2.70 H	190	77.0	40.9
2	*5320.00	108.5 AV			2.70 H	190	67.6	40.9
3	5350.00	62.6 PK	74.0	-11.4	2.70 H	190	41.6	21.0
4	5350.00	50.3 AV	54.0	-3.7	2.70 H	190	29.3	21.0
5	10640.00	63.3 PK	74.0	-10.7	2.34 H	169	37.6	25.7
6	10640.00	50.0 AV	54.0	-4.0	2.34 H	169	24.3	25.7
Antenna Polarity & Test Distance : Vertical at 3 m								
No	Frequency (MHz)	Emission Level (dBuV/m)	Limit (dBuV/m)	Margin (dB)	Antenna Height (m)	Table Angle (Degree)	Raw Value (dBuV)	Correction Factor (dB/m)
1	*5320.00	113.2 PK			2.83 V	285	72.3	40.9
2	*5320.00	104.4 AV			2.83 V	285	63.5	40.9
3	5350.00	61.1 PK	74.0	-12.9	2.83 V	285	40.1	21.0
4	5350.00	49.4 AV	54.0	-4.6	2.83 V	285	28.4	21.0
5	10640.00	63.1 PK	74.0	-10.9	3.11 V	299	37.4	25.7
6	10640.00	49.8 AV	54.0	-4.2	3.11 V	299	24.1	25.7

**Remarks:**

1. Emission Level(dBuV/m) = Raw Value(dBuV) + Correction Factor(dB/m)
2. Correction Factor(dB/m) = Antenna Factor(dB/m) + Cable Factor(dB) – Pre-Amplifier Factor(dB)
3. Margin value = Emission Level – Limit value
4. The other emission levels were very low against the limit.
5. " \* ": Fundamental frequency, the limit was restricted at the RF Output Power.

RF Mode	802.11a	Channel	CH 100 : 5500 MHz
Frequency Range	1 GHz ~ 40 GHz	Detector Function & Bandwidth	Peak (PK), RB = 1 MHz, VB = 3 MHz Peak (AV), RB = 1 MHz, VB = 10 Hz
Input Power	120 Vac, 60 Hz	Environmental Conditions	23°C, 67% RH
Tested By	Adair Peng		

Antenna Polarity & Test Distance : Horizontal at 3 m								
No	Frequency (MHz)	Emission Level (dBuV/m)	Limit (dBuV/m)	Margin (dB)	Antenna Height (m)	Table Angle (Degree)	Raw Value (dBuV)	Correction Factor (dB/m)
1	5460.00	62.3 PK	74.0	-11.7	3.97 H	0	40.9	21.4
2	5460.00	49.5 AV	54.0	-4.5	3.97 H	0	28.1	21.4
3	#5470.00	64.3 PK	68.2	-3.9	3.97 H	0	42.9	21.4
4	*5500.00	117.8 PK			3.97 H	0	76.3	41.5
5	*5500.00	108.7 AV			3.97 H	0	67.2	41.5
6	11000.00	63.0 PK	74.0	-11.0	2.33 H	305	36.3	26.7
7	11000.00	49.9 AV	54.0	-4.1	2.33 H	305	23.2	26.7
Antenna Polarity & Test Distance : Vertical at 3 m								
No	Frequency (MHz)	Emission Level (dBuV/m)	Limit (dBuV/m)	Margin (dB)	Antenna Height (m)	Table Angle (Degree)	Raw Value (dBuV)	Correction Factor (dB/m)
1	5460.00	61.3 PK	74.0	-12.7	3.45 V	288	39.9	21.4
2	5460.00	48.4 AV	54.0	-5.6	3.45 V	288	27.0	21.4
3	#5470.00	62.3 PK	68.2	-5.9	3.45 V	288	40.9	21.4
4	*5500.00	114.0 PK			3.45 V	288	72.5	41.5
5	*5500.00	104.7 AV			3.45 V	288	63.2	41.5
6	11000.00	62.7 PK	74.0	-11.3	2.98 V	41	36.0	26.7
7	11000.00	49.6 AV	54.0	-4.4	2.98 V	41	22.9	26.7

**Remarks:**

1. Emission Level(dBuV/m) = Raw Value(dBuV) + Correction Factor(dB/m)
2. Correction Factor(dB/m) = Antenna Factor(dB/m) + Cable Factor(dB) – Pre-Amplifier Factor(dB)
3. Margin value = Emission Level – Limit value
4. The other emission levels were very low against the limit.
5. " \* " : Fundamental frequency, the limit was restricted at the RF Output Power.
6. " # " : The radiated frequency is out of the restricted band.



RF Mode	802.11a	Channel	CH 116 : 5580 MHz
Frequency Range	1 GHz ~ 40 GHz	Detector Function & Bandwidth	Peak (PK), RB = 1 MHz, VB = 3 MHz Peak (AV), RB = 1 MHz, VB = 10 Hz
Input Power	120 Vac, 60 Hz	Environmental Conditions	23°C, 67% RH
Tested By	Adair Peng		

Antenna Polarity & Test Distance : Horizontal at 3 m								
No	Frequency (MHz)	Emission Level (dBuV/m)	Limit (dBuV/m)	Margin (dB)	Antenna Height (m)	Table Angle (Degree)	Raw Value (dBuV)	Correction Factor (dB/m)
1	*5580.00	117.0 PK			3.67 H	356	75.4	41.6
2	*5580.00	107.7 AV			3.67 H	356	66.1	41.6
3	11160.00	62.0 PK	74.0	-12.0	2.38 H	311	36.2	25.8
4	11160.00	48.9 AV	54.0	-5.1	2.38 H	311	23.1	25.8
Antenna Polarity & Test Distance : Vertical at 3 m								
No	Frequency (MHz)	Emission Level (dBuV/m)	Limit (dBuV/m)	Margin (dB)	Antenna Height (m)	Table Angle (Degree)	Raw Value (dBuV)	Correction Factor (dB/m)
1	*5580.00	113.2 PK			3.44 V	290	71.6	41.6
2	*5580.00	103.7 AV			3.44 V	290	62.1	41.6
3	11160.00	61.8 PK	74.0	-12.2	3.03 V	45	36.0	25.8
4	11160.00	48.7 AV	54.0	-5.3	3.03 V	45	22.9	25.8

Remarks:

1. Emission Level(dBuV/m) = Raw Value(dBuV) + Correction Factor(dB/m)
2. Correction Factor(dB/m) = Antenna Factor(dB/m) + Cable Factor(dB) – Pre-Amplifier Factor(dB)
3. Margin value = Emission Level – Limit value
4. The other emission levels were very low against the limit.
5. " \* " : Fundamental frequency, the limit was restricted at the RF Output Power.





RF Mode	802.11a	Channel	CH 140 : 5700 MHz
Frequency Range	1 GHz ~ 40 GHz	Detector Function & Bandwidth	Peak (PK), RB = 1 MHz, VB = 3 MHz Peak (AV), RB = 1 MHz, VB = 10 Hz
Input Power	120 Vac, 60 Hz	Environmental Conditions	23°C, 67% RH
Tested By	Adair Peng		

Antenna Polarity & Test Distance : Horizontal at 3 m

No	Frequency (MHz)	Emission Level (dBuV/m)	Limit (dBuV/m)	Margin (dB)	Antenna Height (m)	Table Angle (Degree)	Raw Value (dBuV)	Correction Factor (dB/m)
1	*5700.00	119.3 PK			2.84 H	196	77.6	41.7
2	*5700.00	109.9 AV			2.84 H	196	68.2	41.7
3	#5725.00	67.8 PK	68.2	-0.4	2.84 H	196	45.6	22.2
4	11400.00	63.7 PK	74.0	-10.3	2.42 H	169	36.7	27.0
5	11400.00	50.6 AV	54.0	-3.4	2.42 H	169	23.6	27.0

Antenna Polarity & Test Distance : Vertical at 3 m

No	Frequency (MHz)	Emission Level (dBuV/m)	Limit (dBuV/m)	Margin (dB)	Antenna Height (m)	Table Angle (Degree)	Raw Value (dBuV)	Correction Factor (dB/m)
1	*5700.00	110.1 PK			3.33 V	285	68.4	41.7
2	*5700.00	101.8 AV			3.33 V	285	60.1	41.7
3	#5725.00	65.8 PK	68.2	-2.4	3.33 V	285	43.6	22.2
4	11400.00	63.5 PK	74.0	-10.5	3.21 V	299	36.5	27.0
5	11400.00	50.4 AV	54.0	-3.6	3.21 V	299	23.4	27.0

Remarks:

1. Emission Level(dBuV/m) = Raw Value(dBuV) + Correction Factor(dB/m)
2. Correction Factor(dB/m) = Antenna Factor(dB/m) + Cable Factor(dB) – Pre-Amplifier Factor(dB)
3. Margin value = Emission Level – Limit value
4. The other emission levels were very low against the limit.
5. " \* ": Fundamental frequency, the limit was restricted at the RF Output Power.
6. " # ": The radiated frequency is out of the restricted band.

RF Mode	802.11a	Channel	CH 144 : 5720 MHz
Frequency Range	1 GHz ~ 40 GHz	Detector Function & Bandwidth	Peak (PK), RB = 1 MHz, VB = 3 MHz Peak (AV), RB = 1 MHz, VB = 10 Hz
Input Power	120 Vac, 60 Hz	Environmental Conditions	23°C, 67% RH
Tested By	Adair Peng		

Antenna Polarity & Test Distance : Horizontal at 3 m								
No	Frequency (MHz)	Emission Level (dBuV/m)	Limit (dBuV/m)	Margin (dB)	Antenna Height (m)	Table Angle (Degree)	Raw Value (dBuV)	Correction Factor (dB/m)
1	#5470.00	62.1 PK	68.2	-6.1	3.84 H	4	40.7	21.4
2	*5720.00	116.8 PK			3.84 H	4	74.9	41.9
3	*5720.00	107.5 AV			3.84 H	4	65.6	41.9
4	#5850.00	62.7 PK	68.2	-5.5	3.84 H	4	40.2	22.5
5	11440.00	63.1 PK	74.0	-10.9	2.43 H	313	36.0	27.1
6	11440.00	49.9 AV	54.0	-4.1	2.43 H	313	22.8	27.1
Antenna Polarity & Test Distance : Vertical at 3 m								
No	Frequency (MHz)	Emission Level (dBuV/m)	Limit (dBuV/m)	Margin (dB)	Antenna Height (m)	Table Angle (Degree)	Raw Value (dBuV)	Correction Factor (dB/m)
1	#5470.00	61.9 PK	68.2	-6.3	3.49 V	290	40.5	21.4
2	*5720.00	112.8 PK			3.49 V	290	70.9	41.9
3	*5720.00	103.4 AV			3.49 V	290	61.5	41.9
4	#5850.00	62.6 PK	68.2	-5.6	3.49 V	290	40.1	22.5
5	11440.00	62.8 PK	74.0	-11.2	3.08 V	39	35.7	27.1
6	11440.00	49.7 AV	54.0	-4.3	3.08 V	39	22.6	27.1

**Remarks:**

1. Emission Level(dBuV/m) = Raw Value(dBuV) + Correction Factor(dB/m)
2. Correction Factor(dB/m) = Antenna Factor(dB/m) + Cable Factor(dB) – Pre-Amplifier Factor(dB)
3. Margin value = Emission Level – Limit value
4. The other emission levels were very low against the limit.
5. " \* " : Fundamental frequency, the limit was restricted at the RF Output Power.
6. " # " : The radiated frequency is out of the restricted band.

RF Mode	802.11a	Channel	CH 149 : 5745 MHz
Frequency Range	1 GHz ~ 40 GHz	Detector Function & Bandwidth	Peak (PK), RB = 1 MHz, VB = 3 MHz Peak (AV), RB = 1 MHz, VB = 10 Hz
Input Power	120 Vac, 60 Hz	Environmental Conditions	23°C, 67% RH
Tested By	Adair Peng		

Antenna Polarity & Test Distance : Horizontal at 3 m								
No	Frequency (MHz)	Emission Level (dBuV/m)	Limit (dBuV/m)	Margin (dB)	Antenna Height (m)	Table Angle (Degree)	Raw Value (dBuV)	Correction Factor (dB/m)
1	#5638.80	63.3 PK	68.2	-4.9	3.19 H	17	41.5	21.8
2	*5745.00	122.3 PK			3.19 H	17	80.3	42.0
3	*5745.00	113.0 AV			3.19 H	17	71.0	42.0
4	#5984.40	62.0 PK	68.2	-6.2	3.19 H	17	39.4	22.6
5	11490.00	62.8 PK	74.0	-11.2	2.29 H	302	35.6	27.2
6	11490.00	49.7 AV	54.0	-4.3	2.29 H	302	22.5	27.2
Antenna Polarity & Test Distance : Vertical at 3 m								
No	Frequency (MHz)	Emission Level (dBuV/m)	Limit (dBuV/m)	Margin (dB)	Antenna Height (m)	Table Angle (Degree)	Raw Value (dBuV)	Correction Factor (dB/m)
1	#5641.60	61.4 PK	68.2	-6.8	3.70 V	269	39.6	21.8
2	*5745.00	120.4 PK			3.70 V	269	78.4	42.0
3	*5745.00	110.6 AV			3.70 V	269	68.6	42.0
4	#5990.40	61.0 PK	68.2	-7.2	3.70 V	269	38.4	22.6
5	11490.00	62.5 PK	74.0	-11.5	2.91 V	37	35.3	27.2
6	11490.00	49.4 AV	54.0	-4.6	2.91 V	37	22.2	27.2

**Remarks:**

1. Emission Level(dBuV/m) = Raw Value(dBuV) + Correction Factor(dB/m)
2. Correction Factor(dB/m) = Antenna Factor(dB/m) + Cable Factor(dB) – Pre-Amplifier Factor(dB)
3. Margin value = Emission Level – Limit value
4. The other emission levels were very low against the limit.
5. " \* ": Fundamental frequency, the limit was restricted at the RF Output Power.

RF Mode	802.11a	Channel	CH 157 : 5785 MHz
Frequency Range	1 GHz ~ 40 GHz	Detector Function & Bandwidth	Peak (PK), RB = 1 MHz, VB = 3 MHz Peak (AV), RB = 1 MHz, VB = 10 Hz
Input Power	120 Vac, 60 Hz	Environmental Conditions	23°C, 67% RH
Tested By	Adair Peng		

Antenna Polarity & Test Distance : Horizontal at 3 m								
No	Frequency (MHz)	Emission Level (dBuV/m)	Limit (dBuV/m)	Margin (dB)	Antenna Height (m)	Table Angle (Degree)	Raw Value (dBuV)	Correction Factor (dB/m)
1	#5650.40	61.9 PK	68.5	-6.5	3.62 H	13	40.0	21.9
2	*5785.00	122.8 PK			3.62 H	13	80.6	42.2
3	*5785.00	113.4 AV			3.62 H	13	71.2	42.2
4	#5942.40	62.2 PK	68.2	-6.0	3.62 H	13	39.7	22.5
5	11570.00	62.8 PK	74.0	-11.2	2.33 H	309	35.6	27.2
6	11570.00	49.7 AV	54.0	-4.3	2.33 H	309	22.5	27.2
Antenna Polarity & Test Distance : Vertical at 3 m								
No	Frequency (MHz)	Emission Level (dBuV/m)	Limit (dBuV/m)	Margin (dB)	Antenna Height (m)	Table Angle (Degree)	Raw Value (dBuV)	Correction Factor (dB/m)
1	#5626.80	61.6 PK	68.2	-6.6	3.49 V	266	39.8	21.8
2	*5785.00	119.9 PK			3.49 V	266	77.7	42.2
3	*5785.00	110.4 AV			3.49 V	266	68.2	42.2
4	#5997.20	61.9 PK	68.2	-6.3	3.49 V	266	39.3	22.6
5	11570.00	62.5 PK	74.0	-11.5	2.96 V	45	35.3	27.2
6	11570.00	49.6 AV	54.0	-4.4	2.96 V	45	22.4	27.2

**Remarks:**

1. Emission Level(dBuV/m) = Raw Value(dBuV) + Correction Factor(dB/m)
2. Correction Factor(dB/m) = Antenna Factor(dB/m) + Cable Factor(dB) – Pre-Amplifier Factor(dB)
3. Margin value = Emission Level – Limit value
4. The other emission levels were very low against the limit.
5. " \* " : Fundamental frequency, the limit was restricted at the RF Output Power.
6. " # " : The radiated frequency is out of the restricted band.



RF Mode	802.11a	Channel	CH 165 : 5825 MHz
Frequency Range	1 GHz ~ 40 GHz	Detector Function & Bandwidth	Peak (PK), RB = 1 MHz, VB = 3 MHz Peak (AV), RB = 1 MHz, VB = 10 Hz
Input Power	120 Vac, 60 Hz	Environmental Conditions	23°C, 67% RH
Tested By	Adair Peng		

Antenna Polarity & Test Distance : Horizontal at 3 m

No	Frequency (MHz)	Emission Level (dBuV/m)	Limit (dBuV/m)	Margin (dB)	Antenna Height (m)	Table Angle (Degree)	Raw Value (dBuV)	Correction Factor (dB/m)
1	#5615.60	62.0 PK	68.2	-6.2	3.27 H	6	40.2	21.8
2	*5825.00	123.5 PK			3.27 H	6	81.1	42.4
3	*5825.00	113.9 AV			3.27 H	6	71.5	42.4
4	#5931.20	62.0 PK	68.2	-6.2	3.27 H	6	39.5	22.5
5	11650.00	62.3 PK	74.0	-11.7	2.35 H	314	35.8	26.5
6	11650.00	49.1 AV	54.0	-4.9	2.35 H	314	22.6	26.5

Antenna Polarity & Test Distance : Vertical at 3 m

No	Frequency (MHz)	Emission Level (dBuV/m)	Limit (dBuV/m)	Margin (dB)	Antenna Height (m)	Table Angle (Degree)	Raw Value (dBuV)	Correction Factor (dB/m)
1	#5620.40	60.1 PK	68.2	-8.1	3.42 V	271	38.3	21.8
2	*5825.00	119.7 PK			3.42 V	271	77.3	42.4
3	*5825.00	110.0 AV			3.42 V	271	67.6	42.4
4	#5930.80	61.0 PK	68.2	-7.2	3.42 V	271	38.5	22.5
5	11650.00	62.1 PK	74.0	-11.9	3.02 V	47	35.6	26.5
6	11650.00	48.8 AV	54.0	-5.2	3.02 V	47	22.3	26.5

Remarks:

1. Emission Level(dBuV/m) = Raw Value(dBuV) + Correction Factor(dB/m)
2. Correction Factor(dB/m) = Antenna Factor(dB/m) + Cable Factor(dB) – Pre-Amplifier Factor(dB)
3. Margin value = Emission Level – Limit value
4. The other emission levels were very low against the limit.
5. " \* " : Fundamental frequency, the limit was restricted at the RF Output Power.
6. " # " : The radiated frequency is out of the restricted band.



RF Mode	802.11ax (HE20)	Channel	CH 36 : 5180 MHz
Frequency Range	1 GHz ~ 40 GHz	Detector Function & Bandwidth	Peak (PK), RB = 1 MHz, VB = 3 MHz Peak (AV), RB = 1 MHz, VB = 10 Hz
Input Power	120 Vac, 60 Hz	Environmental Conditions	23°C, 67% RH
Tested By	Adair Peng		

Antenna Polarity & Test Distance : Horizontal at 3 m

No	Frequency (MHz)	Emission Level (dBuV/m)	Limit (dBuV/m)	Margin (dB)	Antenna Height (m)	Table Angle (Degree)	Raw Value (dBuV)	Correction Factor (dB/m)
1	5150.00	66.6 PK	74.0	-7.4	2.79 H	188	45.6	21.0
2	5150.00	53.2 AV	54.0	-0.8	2.79 H	188	32.2	21.0
3	*5180.00	123.7 PK			2.79 H	188	82.5	41.2
4	*5180.00	111.9 AV			2.79 H	188	70.7	41.2
5	#10360.00	61.6 PK	68.2	-6.6	2.43 H	161	37.2	24.4

Antenna Polarity & Test Distance : Vertical at 3 m

No	Frequency (MHz)	Emission Level (dBuV/m)	Limit (dBuV/m)	Margin (dB)	Antenna Height (m)	Table Angle (Degree)	Raw Value (dBuV)	Correction Factor (dB/m)
1	5150.00	62.8 PK	74.0	-11.2	3.39 V	281	41.8	21.0
2	5150.00	49.3 AV	54.0	-4.7	3.39 V	281	28.3	21.0
3	*5180.00	113.2 PK			3.39 V	281	72.0	41.2
4	*5180.00	102.2 AV			3.39 V	281	61.0	41.2
5	#10360.00	61.3 PK	68.2	-6.9	3.09 V	297	36.9	24.4

Remarks:

1. Emission Level(dBuV/m) = Raw Value(dBuV) + Correction Factor(dB/m)
2. Correction Factor(dB/m) = Antenna Factor(dB/m) + Cable Factor(dB) – Pre-Amplifier Factor(dB)
3. Margin value = Emission Level – Limit value
4. The other emission levels were very low against the limit.
5. " \* ": Fundamental frequency, the limit was restricted at the RF Output Power.
6. " # ": The radiated frequency is out of the restricted band.

RF Mode	802.11ax (HE20)	Channel	CH 40 : 5200 MHz
Frequency Range	1 GHz ~ 40 GHz	Detector Function & Bandwidth	Peak (PK), RB = 1 MHz, VB = 3 MHz Peak (AV), RB = 1 MHz, VB = 10 Hz
Input Power	120 Vac, 60 Hz	Environmental Conditions	23°C, 67% RH
Tested By	Adair Peng		

Antenna Polarity & Test Distance : Horizontal at 3 m								
No	Frequency (MHz)	Emission Level (dBuV/m)	Limit (dBuV/m)	Margin (dB)	Antenna Height (m)	Table Angle (Degree)	Raw Value (dBuV)	Correction Factor (dB/m)
1	5150.00	66.4 PK	74.0	-7.6	2.78 H	179	45.4	21.0
2	5150.00	53.6 AV	54.0	-0.4	2.78 H	179	32.6	21.0
3	*5200.00	125.9 PK			2.78 H	179	84.8	41.1
4	*5200.00	114.0 AV			2.78 H	179	72.9	41.1
5	#10400.00	61.8 PK	68.2	-6.4	2.43 H	160	37.2	24.6

Antenna Polarity & Test Distance : Vertical at 3 m								
No	Frequency (MHz)	Emission Level (dBuV/m)	Limit (dBuV/m)	Margin (dB)	Antenna Height (m)	Table Angle (Degree)	Raw Value (dBuV)	Correction Factor (dB/m)
1	5150.00	62.3 PK	74.0	-11.7	3.23 V	283	41.3	21.0
2	5150.00	48.4 AV	54.0	-5.6	3.23 V	283	27.4	21.0
3	*5200.00	116.5 PK			3.23 V	283	75.4	41.1
4	*5200.00	104.5 AV			3.23 V	283	63.4	41.1
5	#10400.00	61.6 PK	68.2	-6.6	3.18 V	290	37.0	24.6

**Remarks:**

1. Emission Level(dBuV/m) = Raw Value(dBuV) + Correction Factor(dB/m)
2. Correction Factor(dB/m) = Antenna Factor(dB/m) + Cable Factor(dB) – Pre-Amplifier Factor(dB)
3. Margin value = Emission Level – Limit value
4. The other emission levels were very low against the limit.
5. " \* ": Fundamental frequency, the limit was restricted at the RF Output Power.
6. " # ": The radiated frequency is out of the restricted band.

RF Mode	802.11ax (HE20)	Channel	CH 48 : 5240 MHz
Frequency Range	1 GHz ~ 40 GHz	Detector Function & Bandwidth	Peak (PK), RB = 1 MHz, VB = 3 MHz Peak (AV), RB = 1 MHz, VB = 10 Hz
Input Power	120 Vac, 60 Hz	Environmental Conditions	23°C, 67% RH
Tested By	Adair Peng		

Antenna Polarity & Test Distance : Horizontal at 3 m								
No	Frequency (MHz)	Emission Level (dBuV/m)	Limit (dBuV/m)	Margin (dB)	Antenna Height (m)	Table Angle (Degree)	Raw Value (dBuV)	Correction Factor (dB/m)
1	5150.00	62.6 PK	74.0	-11.4	2.25 H	181	41.6	21.0
2	5150.00	50.8 AV	54.0	-3.2	2.25 H	181	29.8	21.0
3	*5240.00	125.2 PK			2.25 H	181	84.3	40.9
4	*5240.00	112.5 AV			2.25 H	181	71.6	40.9
5	5445.00	63.4 PK	74.0	-10.6	2.25 H	181	41.9	21.5
6	5445.00	50.9 AV	54.0	-3.1	2.25 H	181	29.4	21.5
7	#10480.00	63.2 PK	68.2	-5.0	2.18 H	164	38.3	24.9
Antenna Polarity & Test Distance : Vertical at 3 m								
No	Frequency (MHz)	Emission Level (dBuV/m)	Limit (dBuV/m)	Margin (dB)	Antenna Height (m)	Table Angle (Degree)	Raw Value (dBuV)	Correction Factor (dB/m)
1	*5240.00	121.4 PK			2.93 V	267	80.5	40.9
2	*5240.00	109.1 AV			2.93 V	267	68.2	40.9
3	5350.00	61.1 PK	74.0	-12.9	2.93 V	267	40.1	21.0
4	5350.00	48.3 AV	54.0	-5.7	2.93 V	267	27.3	21.0
5	#10480.00	62.3 PK	68.2	-5.9	2.98 V	284	37.4	24.9

**Remarks:**

1. Emission Level(dBuV/m) = Raw Value(dBuV) + Correction Factor(dB/m)
2. Correction Factor(dB/m) = Antenna Factor(dB/m) + Cable Factor(dB) – Pre-Amplifier Factor(dB)
3. Margin value = Emission Level – Limit value
4. The other emission levels were very low against the limit.
5. " \* ": Fundamental frequency, the limit was restricted at the RF Output Power.
6. " # ": The radiated frequency is out of the restricted band.



RF Mode	802.11ax (HE20)	Channel	CH 52 : 5260 MHz
Frequency Range	1 GHz ~ 40 GHz	Detector Function & Bandwidth	Peak (PK), RB = 1 MHz, VB = 3 MHz Peak (AV), RB = 1 MHz, VB = 10 Hz
Input Power	120 Vac, 60 Hz	Environmental Conditions	23°C, 67% RH
Tested By	Adair Peng		

Antenna Polarity & Test Distance : Horizontal at 3 m								
No	Frequency (MHz)	Emission Level (dBuV/m)	Limit (dBuV/m)	Margin (dB)	Antenna Height (m)	Table Angle (Degree)	Raw Value (dBuV)	Correction Factor (dB/m)
1	5150.00	60.8 PK	74.0	-13.2	2.37 H	188	39.8	21.0
2	5150.00	48.6 AV	54.0	-5.4	2.37 H	188	27.6	21.0
3	*5260.00	120.3 PK			2.37 H	188	79.5	40.8
4	*5260.00	107.9 AV			2.37 H	188	67.1	40.8
5	#10520.00	62.4 PK	68.2	-5.8	2.35 H	172	37.4	25.0

Antenna Polarity & Test Distance : Vertical at 3 m								
No	Frequency (MHz)	Emission Level (dBuV/m)	Limit (dBuV/m)	Margin (dB)	Antenna Height (m)	Table Angle (Degree)	Raw Value (dBuV)	Correction Factor (dB/m)
1	5150.00	60.2 PK	74.0	-13.8	2.87 V	277	39.2	21.0
2	5150.00	48.2 AV	54.0	-5.8	2.87 V	277	27.2	21.0
3	*5260.00	115.6 PK			2.87 V	277	74.8	40.8
4	*5260.00	104.3 AV			2.87 V	277	63.5	40.8
5	#10520.00	62.1 PK	68.2	-6.1	3.05 V	296	37.1	25.0

**Remarks:**

1. Emission Level(dBuV/m) = Raw Value(dBuV) + Correction Factor(dB/m)
2. Correction Factor(dB/m) = Antenna Factor(dB/m) + Cable Factor(dB) – Pre-Amplifier Factor(dB)
3. Margin value = Emission Level – Limit value
4. The other emission levels were very low against the limit.
5. " \* ": Fundamental frequency, the limit was restricted at the RF Output Power.
6. " # ": The radiated frequency is out of the restricted band.



RF Mode	802.11ax (HE20)	Channel	CH 60 : 5300 MHz
Frequency Range	1 GHz ~ 40 GHz	Detector Function & Bandwidth	Peak (PK), RB = 1 MHz, VB = 3 MHz Peak (AV), RB = 1 MHz, VB = 10 Hz
Input Power	120 Vac, 60 Hz	Environmental Conditions	23°C, 67% RH
Tested By	Adair Peng		

Antenna Polarity & Test Distance : Horizontal at 3 m								
No	Frequency (MHz)	Emission Level (dBuV/m)	Limit (dBuV/m)	Margin (dB)	Antenna Height (m)	Table Angle (Degree)	Raw Value (dBuV)	Correction Factor (dB/m)
1	*5300.00	119.6 PK			2.71 H	179	78.8	40.8
2	*5300.00	107.3 AV			2.71 H	179	66.5	40.8
3	10600.00	62.4 PK	74.0	-11.6	2.25 H	166	37.4	25.0
4	10600.00	49.5 AV	54.0	-4.5	2.25 H	166	24.5	25.0

Antenna Polarity & Test Distance : Vertical at 3 m								
No	Frequency (MHz)	Emission Level (dBuV/m)	Limit (dBuV/m)	Margin (dB)	Antenna Height (m)	Table Angle (Degree)	Raw Value (dBuV)	Correction Factor (dB/m)
1	*5300.00	116.9 PK			2.83 V	276	76.1	40.8
2	*5300.00	104.4 AV			2.83 V	276	63.6	40.8
3	10600.00	62.1 PK	74.0	-11.9	3.01 V	292	37.1	25.0
4	10600.00	49.2 AV	54.0	-4.8	3.01 V	292	24.2	25.0

Remarks:

1. Emission Level(dBuV/m) = Raw Value(dBuV) + Correction Factor(dB/m)
2. Correction Factor(dB/m) = Antenna Factor(dB/m) + Cable Factor(dB) – Pre-Amplifier Factor(dB)
3. Margin value = Emission Level – Limit value
4. The other emission levels were very low against the limit.
5. " \* " : Fundamental frequency, the limit was restricted at the RF Output Power.



RF Mode	802.11ax (HE20)	Channel	CH 64 : 5320 MHz
Frequency Range	1 GHz ~ 40 GHz	Detector Function & Bandwidth	Peak (PK), RB = 1 MHz, VB = 3 MHz Peak (AV), RB = 1 MHz, VB = 10 Hz
Input Power	120 Vac, 60 Hz	Environmental Conditions	23°C, 67% RH
Tested By	Adair Peng		

Antenna Polarity & Test Distance : Horizontal at 3 m

No	Frequency (MHz)	Emission Level (dBuV/m)	Limit (dBuV/m)	Margin (dB)	Antenna Height (m)	Table Angle (Degree)	Raw Value (dBuV)	Correction Factor (dB/m)
1	*5320.00	119.5 PK			2.46 H	182	78.6	40.9
2	*5320.00	107.7 AV			2.46 H	182	66.8	40.9
3	5350.00	64.6 PK	74.0	-9.4	2.46 H	182	43.6	21.0
4	5350.00	51.6 AV	54.0	-2.4	2.46 H	182	30.6	21.0
5	10640.00	63.1 PK	74.0	-10.9	2.31 H	159	37.4	25.7
6	10640.00	49.9 AV	54.0	-4.1	2.31 H	159	24.2	25.7

Antenna Polarity & Test Distance : Vertical at 3 m

No	Frequency (MHz)	Emission Level (dBuV/m)	Limit (dBuV/m)	Margin (dB)	Antenna Height (m)	Table Angle (Degree)	Raw Value (dBuV)	Correction Factor (dB/m)
1	*5320.00	114.9 PK			2.83 V	287	74.0	40.9
2	*5320.00	103.4 AV			2.83 V	287	62.5	40.9
3	5350.00	61.8 PK	74.0	-12.2	2.83 V	287	40.8	21.0
4	5350.00	49.8 AV	54.0	-4.2	2.83 V	287	28.8	21.0
5	10640.00	63.0 PK	74.0	-11.0	3.12 V	290	37.3	25.7
6	10640.00	49.8 AV	54.0	-4.2	3.12 V	290	24.1	25.7

Remarks:

1. Emission Level(dBuV/m) = Raw Value(dBuV) + Correction Factor(dB/m)
2. Correction Factor(dB/m) = Antenna Factor(dB/m) + Cable Factor(dB) – Pre-Amplifier Factor(dB)
3. Margin value = Emission Level – Limit value
4. The other emission levels were very low against the limit.
5. " \* ": Fundamental frequency, the limit was restricted at the RF Output Power.

RF Mode	802.11ax (HE20)	Channel	CH 100 : 5500 MHz
Frequency Range	1 GHz ~ 40 GHz	Detector Function & Bandwidth	Peak (PK), RB = 1 MHz, VB = 3 MHz Peak (AV), RB = 1 MHz, VB = 10 Hz
Input Power	120 Vac, 60 Hz	Environmental Conditions	23°C, 67% RH
Tested By	Adair Peng		

Antenna Polarity & Test Distance : Horizontal at 3 m								
No	Frequency (MHz)	Emission Level (dBuV/m)	Limit (dBuV/m)	Margin (dB)	Antenna Height (m)	Table Angle (Degree)	Raw Value (dBuV)	Correction Factor (dB/m)
1	5460.00	63.1 PK	74.0	-10.9	3.79 H	0	41.7	21.4
2	5460.00	49.5 AV	54.0	-4.5	3.79 H	0	28.1	21.4
3	#5470.00	64.3 PK	68.2	-3.9	3.79 H	0	42.9	21.4
4	*5500.00	119.2 PK			3.79 H	0	77.7	41.5
5	*5500.00	107.6 AV			3.79 H	0	66.1	41.5
6	11000.00	62.9 PK	74.0	-11.1	2.39 H	305	36.2	26.7
7	11000.00	49.7 AV	54.0	-4.3	2.39 H	305	23.0	26.7
Antenna Polarity & Test Distance : Vertical at 3 m								
No	Frequency (MHz)	Emission Level (dBuV/m)	Limit (dBuV/m)	Margin (dB)	Antenna Height (m)	Table Angle (Degree)	Raw Value (dBuV)	Correction Factor (dB/m)
1	5460.00	62.3 PK	74.0	-11.7	3.48 V	287	40.9	21.4
2	5460.00	49.0 AV	54.0	-5.0	3.48 V	287	27.6	21.4
3	#5470.00	64.2 PK	68.2	-4.0	3.48 V	287	42.8	21.4
4	*5500.00	116.1 PK			3.48 V	287	74.6	41.5
5	*5500.00	103.6 AV			3.48 V	287	62.1	41.5
6	11000.00	62.7 PK	74.0	-11.3	2.96 V	47	36.0	26.7
7	11000.00	50.5 AV	54.0	-3.5	2.96 V	47	23.8	26.7

**Remarks:**

1. Emission Level(dBuV/m) = Raw Value(dBuV) + Correction Factor(dB/m)
2. Correction Factor(dB/m) = Antenna Factor(dB/m) + Cable Factor(dB) – Pre-Amplifier Factor(dB)
3. Margin value = Emission Level – Limit value
4. The other emission levels were very low against the limit.
5. " \* ": Fundamental frequency, the limit was restricted at the RF Output Power.
6. " # ": The radiated frequency is out of the restricted band.



RF Mode	802.11ax (HE20)	Channel	CH 116 : 5580 MHz
Frequency Range	1 GHz ~ 40 GHz	Detector Function & Bandwidth	Peak (PK), RB = 1 MHz, VB = 3 MHz Peak (AV), RB = 1 MHz, VB = 10 Hz
Input Power	120 Vac, 60 Hz	Environmental Conditions	23°C, 67% RH
Tested By	Adair Peng		

Antenna Polarity & Test Distance : Horizontal at 3 m								
No	Frequency (MHz)	Emission Level (dBuV/m)	Limit (dBuV/m)	Margin (dB)	Antenna Height (m)	Table Angle (Degree)	Raw Value (dBuV)	Correction Factor (dB/m)
1	*5580.00	119.0 PK			3.65 H	359	77.4	41.6
2	*5580.00	106.9 AV			3.65 H	359	65.3	41.6
3	11160.00	61.8 PK	74.0	-12.2	2.33 H	303	36.0	25.8
4	11160.00	48.7 AV	54.0	-5.3	2.33 H	303	22.9	25.8

Antenna Polarity & Test Distance : Vertical at 3 m								
No	Frequency (MHz)	Emission Level (dBuV/m)	Limit (dBuV/m)	Margin (dB)	Antenna Height (m)	Table Angle (Degree)	Raw Value (dBuV)	Correction Factor (dB/m)
1	*5580.00	115.1 PK			3.50 V	290	73.5	41.6
2	*5580.00	102.9 AV			3.50 V	290	61.3	41.6
3	11160.00	61.7 PK	74.0	-12.3	3.00 V	45	35.9	25.8
4	11160.00	48.5 AV	54.0	-5.5	3.00 V	45	22.7	25.8

Remarks:

1. Emission Level(dBuV/m) = Raw Value(dBuV) + Correction Factor(dB/m)
2. Correction Factor(dB/m) = Antenna Factor(dB/m) + Cable Factor(dB) – Pre-Amplifier Factor(dB)
3. Margin value = Emission Level – Limit value
4. The other emission levels were very low against the limit.
5. " \* ": Fundamental frequency, the limit was restricted at the RF Output Power.



RF Mode	802.11ax (HE20)	Channel	CH 140 : 5700 MHz
Frequency Range	1 GHz ~ 40 GHz	Detector Function & Bandwidth	Peak (PK), RB = 1 MHz, VB = 3 MHz Peak (AV), RB = 1 MHz, VB = 10 Hz
Input Power	120 Vac, 60 Hz	Environmental Conditions	23°C, 67% RH
Tested By	Adair Peng		

Antenna Polarity & Test Distance : Horizontal at 3 m								
No	Frequency (MHz)	Emission Level (dBuV/m)	Limit (dBuV/m)	Margin (dB)	Antenna Height (m)	Table Angle (Degree)	Raw Value (dBuV)	Correction Factor (dB/m)
1	*5700.00	119.3 PK			2.12 H	187	77.6	41.7
2	*5700.00	107.1 AV			2.12 H	187	65.4	41.7
3	#5725.00	67.7 PK	68.2	-0.5	2.12 H	187	45.5	22.2
4	11400.00	63.6 PK	74.0	-10.4	2.53 H	167	36.6	27.0
5	11400.00	50.5 AV	54.0	-3.5	2.53 H	167	23.5	27.0

Antenna Polarity & Test Distance : Vertical at 3 m								
No	Frequency (MHz)	Emission Level (dBuV/m)	Limit (dBuV/m)	Margin (dB)	Antenna Height (m)	Table Angle (Degree)	Raw Value (dBuV)	Correction Factor (dB/m)
1	*5700.00	110.8 PK			3.28 V	290	69.1	41.7
2	*5700.00	98.1 AV			3.28 V	290	56.4	41.7
3	#5725.00	62.0 PK	68.2	-6.2	3.28 V	290	39.8	22.2
4	11400.00	63.5 PK	74.0	-10.5	3.01 V	287	36.5	27.0
5	11400.00	50.3 AV	54.0	-3.7	3.01 V	287	23.3	27.0

Remarks:

1. Emission Level(dBuV/m) = Raw Value(dBuV) + Correction Factor(dB/m)
2. Correction Factor(dB/m) = Antenna Factor(dB/m) + Cable Factor(dB) – Pre-Amplifier Factor(dB)
3. Margin value = Emission Level – Limit value
4. The other emission levels were very low against the limit.
5. " \* " : Fundamental frequency, the limit was restricted at the RF Output Power.
6. " # " : The radiated frequency is out of the restricted band.



RF Mode	802.11ax (HE20)	Channel	CH 144 : 5720 MHz
Frequency Range	1 GHz ~ 40 GHz	Detector Function & Bandwidth	Peak (PK), RB = 1 MHz, VB = 3 MHz Peak (AV), RB = 1 MHz, VB = 10 Hz
Input Power	120 Vac, 60 Hz	Environmental Conditions	23°C, 67% RH
Tested By	Adair Peng		

Antenna Polarity & Test Distance : Horizontal at 3 m								
No	Frequency (MHz)	Emission Level (dBuV/m)	Limit (dBuV/m)	Margin (dB)	Antenna Height (m)	Table Angle (Degree)	Raw Value (dBuV)	Correction Factor (dB/m)
1	#5470.00	62.6 PK	68.2	-5.6	3.85 H	3	41.2	21.4
2	*5720.00	119.0 PK			3.85 H	3	77.1	41.9
3	*5720.00	107.2 AV			3.85 H	3	65.3	41.9
4	#5850.00	63.9 PK	68.2	-4.3	3.85 H	3	41.4	22.5
5	11440.00	63.1 PK	74.0	-10.9	2.30 H	315	36.0	27.1
6	11440.00	49.8 AV	54.0	-4.2	2.30 H	315	22.7	27.1

Antenna Polarity & Test Distance : Vertical at 3 m								
No	Frequency (MHz)	Emission Level (dBuV/m)	Limit (dBuV/m)	Margin (dB)	Antenna Height (m)	Table Angle (Degree)	Raw Value (dBuV)	Correction Factor (dB/m)
1	#5470.00	62.4 PK	68.2	-5.8	3.49 V	287	41.0	21.4
2	*5720.00	114.1 PK			3.49 V	287	72.2	41.9
3	*5720.00	102.5 AV			3.49 V	287	60.6	41.9
4	#5850.00	63.6 PK	68.2	-4.6	3.49 V	287	41.1	22.5
5	11440.00	62.9 PK	74.0	-11.1	3.08 V	48	35.8	27.1
6	11440.00	49.7 AV	54.0	-4.3	3.08 V	48	22.6	27.1

Remarks:

1. Emission Level(dBuV/m) = Raw Value(dBuV) + Correction Factor(dB/m)
2. Correction Factor(dB/m) = Antenna Factor(dB/m) + Cable Factor(dB) – Pre-Amplifier Factor(dB)
3. Margin value = Emission Level – Limit value
4. The other emission levels were very low against the limit.
5. " \* ": Fundamental frequency, the limit was restricted at the RF Output Power.
6. " # ": The radiated frequency is out of the restricted band.

RF Mode	802.11ax (HE20)	Channel	CH 149 : 5745 MHz
Frequency Range	1 GHz ~ 40 GHz	Detector Function & Bandwidth	Peak (PK), RB = 1 MHz, VB = 3 MHz Peak (AV), RB = 1 MHz, VB = 10 Hz
Input Power	120 Vac, 60 Hz	Environmental Conditions	23°C, 67% RH
Tested By	Adair Peng		

Antenna Polarity & Test Distance : Horizontal at 3 m								
No	Frequency (MHz)	Emission Level (dBuV/m)	Limit (dBuV/m)	Margin (dB)	Antenna Height (m)	Table Angle (Degree)	Raw Value (dBuV)	Correction Factor (dB/m)
1	#5637.60	64.1 PK	68.2	-4.1	3.86 H	5	42.3	21.8
2	*5745.00	124.8 PK			3.86 H	5	82.8	42.0
3	*5745.00	112.7 AV			3.86 H	5	70.7	42.0
4	#5994.80	62.4 PK	68.2	-5.8	3.86 H	5	39.8	22.6
5	11490.00	62.8 PK	74.0	-11.2	2.27 H	314	35.6	27.2
6	11490.00	49.8 AV	54.0	-4.2	2.27 H	314	22.6	27.2
Antenna Polarity & Test Distance : Vertical at 3 m								
No	Frequency (MHz)	Emission Level (dBuV/m)	Limit (dBuV/m)	Margin (dB)	Antenna Height (m)	Table Angle (Degree)	Raw Value (dBuV)	Correction Factor (dB/m)
1	#5634.80	62.3 PK	68.2	-5.9	3.87 V	279	40.5	21.8
2	*5745.00	121.6 PK			3.87 V	279	79.6	42.0
3	*5745.00	109.4 AV			3.87 V	279	67.4	42.0
4	#5975.20	60.9 PK	68.2	-7.3	3.87 V	279	38.3	22.6
5	11490.00	62.7 PK	74.0	-11.3	2.93 V	40	35.5	27.2
6	11490.00	49.6 AV	54.0	-4.4	2.93 V	40	22.4	27.2

**Remarks:**

1. Emission Level(dBuV/m) = Raw Value(dBuV) + Correction Factor(dB/m)
2. Correction Factor(dB/m) = Antenna Factor(dB/m) + Cable Factor(dB) – Pre-Amplifier Factor(dB)
3. Margin value = Emission Level – Limit value
4. The other emission levels were very low against the limit.
5. " \* ": Fundamental frequency, the limit was restricted at the RF Output Power.





RF Mode	802.11ax (HE20)	Channel	CH 157 : 5785 MHz
Frequency Range	1 GHz ~ 40 GHz	Detector Function & Bandwidth	Peak (PK), RB = 1 MHz, VB = 3 MHz Peak (AV), RB = 1 MHz, VB = 10 Hz
Input Power	120 Vac, 60 Hz	Environmental Conditions	23°C, 67% RH
Tested By	Adair Peng		

Antenna Polarity & Test Distance : Horizontal at 3 m								
No	Frequency (MHz)	Emission Level (dBuV/m)	Limit (dBuV/m)	Margin (dB)	Antenna Height (m)	Table Angle (Degree)	Raw Value (dBuV)	Correction Factor (dB/m)
1	#5630.40	61.7 PK	68.2	-6.5	3.82 H	1	39.9	21.8
2	*5785.00	125.4 PK			3.82 H	1	83.2	42.2
3	*5785.00	113.9 AV			3.82 H	1	71.7	42.2
4	#5926.40	62.9 PK	68.2	-5.3	3.82 H	1	40.4	22.5
5	11570.00	62.8 PK	74.0	-11.2	2.33 H	304	35.6	27.2
6	11570.00	49.8 AV	54.0	-4.2	2.33 H	304	22.6	27.2

Antenna Polarity & Test Distance : Vertical at 3 m								
No	Frequency (MHz)	Emission Level (dBuV/m)	Limit (dBuV/m)	Margin (dB)	Antenna Height (m)	Table Angle (Degree)	Raw Value (dBuV)	Correction Factor (dB/m)
1	#5646.00	60.5 PK	68.2	-7.7	3.82 V	270	38.6	21.9
2	*5785.00	122.1 PK			3.82 V	270	79.9	42.2
3	*5785.00	110.1 AV			3.82 V	270	67.9	42.2
4	#5962.40	62.2 PK	68.2	-6.0	3.82 V	270	39.6	22.6
5	11570.00	62.7 PK	74.0	-11.3	2.96 V	38	35.5	27.2
6	11570.00	49.6 AV	54.0	-4.4	2.96 V	38	22.4	27.2

Remarks:

1. Emission Level(dBuV/m) = Raw Value(dBuV) + Correction Factor(dB/m)
2. Correction Factor(dB/m) = Antenna Factor(dB/m) + Cable Factor(dB) – Pre-Amplifier Factor(dB)
3. Margin value = Emission Level – Limit value
4. The other emission levels were very low against the limit.
5. " \* " : Fundamental frequency, the limit was restricted at the RF Output Power.
6. " # " : The radiated frequency is out of the restricted band.



RF Mode	802.11ax (HE20)	Channel	CH 165 : 5825 MHz
Frequency Range	1 GHz ~ 40 GHz	Detector Function & Bandwidth	Peak (PK), RB = 1 MHz, VB = 3 MHz Peak (AV), RB = 1 MHz, VB = 10 Hz
Input Power	120 Vac, 60 Hz	Environmental Conditions	23°C, 67% RH
Tested By	Adair Peng		

Antenna Polarity & Test Distance : Horizontal at 3 m								
No	Frequency (MHz)	Emission Level (dBuV/m)	Limit (dBuV/m)	Margin (dB)	Antenna Height (m)	Table Angle (Degree)	Raw Value (dBuV)	Correction Factor (dB/m)
1	#5618.00	62.4 PK	68.2	-5.8	3.74 H	2	40.6	21.8
2	*5825.00	125.8 PK			3.74 H	2	83.4	42.4
3	*5825.00	113.6 AV			3.74 H	2	71.2	42.4
4	#5928.00	63.2 PK	68.2	-5.0	3.74 H	2	40.7	22.5
5	11650.00	62.3 PK	74.0	-11.7	2.32 H	307	35.8	26.5
6	11650.00	49.1 AV	54.0	-4.9	2.32 H	307	22.6	26.5
Antenna Polarity & Test Distance : Vertical at 3 m								
No	Frequency (MHz)	Emission Level (dBuV/m)	Limit (dBuV/m)	Margin (dB)	Antenna Height (m)	Table Angle (Degree)	Raw Value (dBuV)	Correction Factor (dB/m)
1	#5611.60	60.7 PK	68.2	-7.5	3.79 V	287	39.0	21.7
2	*5825.00	122.0 PK			3.79 V	287	79.6	42.4
3	*5825.00	110.1 AV			3.79 V	287	67.7	42.4
4	#5951.60	61.3 PK	68.2	-6.9	3.79 V	287	38.8	22.5
5	11650.00	61.8 PK	74.0	-12.2	2.96 V	44	35.3	26.5
6	11650.00	48.8 AV	54.0	-5.2	2.96 V	44	22.3	26.5

Remarks:

1. Emission Level(dBuV/m) = Raw Value(dBuV) + Correction Factor(dB/m)
2. Correction Factor(dB/m) = Antenna Factor(dB/m) + Cable Factor(dB) – Pre-Amplifier Factor(dB)
3. Margin value = Emission Level – Limit value
4. The other emission levels were very low against the limit.
5. " \* " : Fundamental frequency, the limit was restricted at the RF Output Power.
6. " # " : The radiated frequency is out of the restricted band.

RF Mode	802.11ax (HE40)	Channel	CH 38 : 5190 MHz
Frequency Range	1 GHz ~ 40 GHz	Detector Function & Bandwidth	Peak (PK), RB = 1 MHz, VB = 3 MHz Peak (AV), RB = 1 MHz, VB = 10 Hz
Input Power	120 Vac, 60 Hz	Environmental Conditions	23°C, 67% RH
Tested By	Adair Peng		

Antenna Polarity & Test Distance : Horizontal at 3 m								
No	Frequency (MHz)	Emission Level (dBuV/m)	Limit (dBuV/m)	Margin (dB)	Antenna Height (m)	Table Angle (Degree)	Raw Value (dBuV)	Correction Factor (dB/m)
1	5150.00	66.7 PK	74.0	-7.3	3.37 H	195	45.7	21.0
<b>2</b>	<b>5150.00</b>	<b>53.8 AV</b>	<b>54.0</b>	<b>-0.2</b>	<b>3.37 H</b>	<b>195</b>	<b>32.8</b>	<b>21.0</b>
3	*5190.00	117.7 PK			3.37 H	195	76.6	41.1
4	*5190.00	105.1 AV			3.37 H	195	64.0	41.1
5	#10380.00	61.8 PK	68.2	-6.4	2.63 H	165	37.3	24.5

Antenna Polarity & Test Distance : Vertical at 3 m								
No	Frequency (MHz)	Emission Level (dBuV/m)	Limit (dBuV/m)	Margin (dB)	Antenna Height (m)	Table Angle (Degree)	Raw Value (dBuV)	Correction Factor (dB/m)
1	5150.00	63.5 PK	74.0	-10.5	3.03 V	291	42.5	21.0
2	5150.00	49.3 AV	54.0	-4.7	3.03 V	291	28.3	21.0
3	*5190.00	108.5 PK			3.03 V	291	67.4	41.1
4	*5190.00	96.0 AV			3.03 V	291	54.9	41.1
5	#10380.00	61.6 PK	68.2	-6.6	3.09 V	287	37.1	24.5

**Remarks:**

1. Emission Level(dBuV/m) = Raw Value(dBuV) + Correction Factor(dB/m)
2. Correction Factor(dB/m) = Antenna Factor(dB/m) + Cable Factor(dB) – Pre-Amplifier Factor(dB)
3. Margin value = Emission Level – Limit value
4. The other emission levels were very low against the limit.
5. " \* ": Fundamental frequency, the limit was restricted at the RF Output Power.
6. " # ": The radiated frequency is out of the restricted band.

RF Mode	802.11ax (HE40)	Channel	CH 46 : 5230 MHz
Frequency Range	1 GHz ~ 40 GHz	Detector Function & Bandwidth	Peak (PK), RB = 1 MHz, VB = 3 MHz Peak (AV), RB = 1 MHz, VB = 10 Hz
Input Power	120 Vac, 60 Hz	Environmental Conditions	23°C, 67% RH
Tested By	Adair Peng		

Antenna Polarity & Test Distance : Horizontal at 3 m								
No	Frequency (MHz)	Emission Level (dBuV/m)	Limit (dBuV/m)	Margin (dB)	Antenna Height (m)	Table Angle (Degree)	Raw Value (dBuV)	Correction Factor (dB/m)
1	5150.00	66.5 PK	74.0	-7.5	2.73 H	190	45.5	21.0
2	5150.00	53.3 AV	54.0	-0.7	2.73 H	190	32.3	21.0
3	*5230.00	123.8 PK			2.73 H	190	82.9	40.9
4	*5230.00	111.5 AV			2.73 H	190	70.6	40.9
5	5350.00	65.0 PK	74.0	-9.0	2.73 H	190	44.0	21.0
6	5350.00	51.9 AV	54.0	-2.1	2.73 H	190	30.9	21.0
7	#10460.00	62.4 PK	68.2	-5.8	2.82 H	158	37.5	24.9
Antenna Polarity & Test Distance : Vertical at 3 m								
No	Frequency (MHz)	Emission Level (dBuV/m)	Limit (dBuV/m)	Margin (dB)	Antenna Height (m)	Table Angle (Degree)	Raw Value (dBuV)	Correction Factor (dB/m)
1	5150.00	62.4 PK	74.0	-11.6	2.98 V	287	41.4	21.0
2	5150.00	48.7 AV	54.0	-5.3	2.98 V	287	27.7	21.0
3	*5230.00	115.3 PK			2.98 V	287	74.4	40.9
4	*5230.00	102.3 AV			2.98 V	287	61.4	40.9
5	5350.00	61.8 PK	74.0	-12.2	2.98 V	287	40.8	21.0
6	5350.00	48.5 AV	54.0	-5.5	2.98 V	287	27.5	21.0
7	#10460.00	62.1 PK	68.2	-6.1	3.15 V	293	37.2	24.9

**Remarks:**

1. Emission Level(dBuV/m) = Raw Value(dBuV) + Correction Factor(dB/m)
2. Correction Factor(dB/m) = Antenna Factor(dB/m) + Cable Factor(dB) – Pre-Amplifier Factor(dB)
3. Margin value = Emission Level – Limit value
4. The other emission levels were very low against the limit.
5. " \* " : Fundamental frequency, the limit was restricted at the RF Output Power.
6. " # " : The radiated frequency is out of the restricted band.

RF Mode	802.11ax (HE40)	Channel	CH 54 : 5270 MHz
Frequency Range	1 GHz ~ 40 GHz	Detector Function & Bandwidth	Peak (PK), RB = 1 MHz, VB = 3 MHz Peak (AV), RB = 1 MHz, VB = 10 Hz
Input Power	120 Vac, 60 Hz	Environmental Conditions	23°C, 67% RH
Tested By	Adair Peng		

Antenna Polarity & Test Distance : Horizontal at 3 m								
No	Frequency (MHz)	Emission Level (dBuV/m)	Limit (dBuV/m)	Margin (dB)	Antenna Height (m)	Table Angle (Degree)	Raw Value (dBuV)	Correction Factor (dB/m)
1	5150.00	61.6 PK	74.0	-12.4	2.37 H	183	40.6	21.0
2	5150.00	49.1 AV	54.0	-4.9	2.37 H	183	28.1	21.0
3	*5270.00	117.7 PK			2.37 H	183	76.9	40.8
4	*5270.00	105.2 AV			2.37 H	183	64.4	40.8
5	#10540.00	62.6 PK	68.2	-5.6	2.36 H	167	37.5	25.1

Antenna Polarity & Test Distance : Vertical at 3 m								
No	Frequency (MHz)	Emission Level (dBuV/m)	Limit (dBuV/m)	Margin (dB)	Antenna Height (m)	Table Angle (Degree)	Raw Value (dBuV)	Correction Factor (dB/m)
1	5150.00	60.7 PK	74.0	-13.3	2.88 V	273	39.7	21.0
2	5150.00	48.3 AV	54.0	-5.7	2.88 V	273	27.3	21.0
3	*5270.00	114.3 PK			2.88 V	273	73.5	40.8
4	*5270.00	102.3 AV			2.88 V	273	61.5	40.8
5	#10540.00	62.4 PK	68.2	-5.8	3.15 V	286	37.3	25.1

**Remarks:**

1. Emission Level(dBuV/m) = Raw Value(dBuV) + Correction Factor(dB/m)
2. Correction Factor(dB/m) = Antenna Factor(dB/m) + Cable Factor(dB) – Pre-Amplifier Factor(dB)
3. Margin value = Emission Level – Limit value
4. The other emission levels were very low against the limit.
5. " \* ": Fundamental frequency, the limit was restricted at the RF Output Power.
6. " # ": The radiated frequency is out of the restricted band.

RF Mode	802.11ax (HE40)	Channel	CH 62 : 5310 MHz
Frequency Range	1 GHz ~ 40 GHz	Detector Function & Bandwidth	Peak (PK), RB = 1 MHz, VB = 3 MHz Peak (AV), RB = 1 MHz, VB = 10 Hz
Input Power	120 Vac, 60 Hz	Environmental Conditions	23°C, 67% RH
Tested By	Adair Peng		

Antenna Polarity & Test Distance : Horizontal at 3 m								
No	Frequency (MHz)	Emission Level (dBuV/m)	Limit (dBuV/m)	Margin (dB)	Antenna Height (m)	Table Angle (Degree)	Raw Value (dBuV)	Correction Factor (dB/m)
1	*5310.00	116.2 PK			2.81 H	194	75.4	40.8
2	*5310.00	103.7 AV			2.81 H	194	62.9	40.8
3	5350.00	66.1 PK	74.0	-7.9	2.81 H	194	45.1	21.0
4	5350.00	53.1 AV	54.0	-0.9	2.81 H	194	32.1	21.0
5	10620.00	62.7 PK	74.0	-11.3	2.63 H	168	37.4	25.3
6	10620.00	49.7 AV	54.0	-4.3	2.63 H	168	24.4	25.3
Antenna Polarity & Test Distance : Vertical at 3 m								
No	Frequency (MHz)	Emission Level (dBuV/m)	Limit (dBuV/m)	Margin (dB)	Antenna Height (m)	Table Angle (Degree)	Raw Value (dBuV)	Correction Factor (dB/m)
1	*5310.00	106.9 PK			3.26 V	285	66.1	40.8
2	*5310.00	94.7 AV			3.26 V	285	53.9	40.8
3	5350.00	62.4 PK	74.0	-11.6	3.26 V	285	41.4	21.0
4	5350.00	48.8 AV	54.0	-5.2	3.26 V	285	27.8	21.0
5	10620.00	62.5 PK	74.0	-11.5	3.13 V	293	37.2	25.3
6	10620.00	49.5 AV	54.0	-4.5	3.13 V	293	24.2	25.3

**Remarks:**

1. Emission Level(dBuV/m) = Raw Value(dBuV) + Correction Factor(dB/m)
2. Correction Factor(dB/m) = Antenna Factor(dB/m) + Cable Factor(dB) – Pre-Amplifier Factor(dB)
3. Margin value = Emission Level – Limit value
4. The other emission levels were very low against the limit.
5. " \* ": Fundamental frequency, the limit was restricted at the RF Output Power.

RF Mode	802.11ax (HE40)	Channel	CH 102 : 5510 MHz
Frequency Range	1 GHz ~ 40 GHz	Detector Function & Bandwidth	Peak (PK), RB = 1 MHz, VB = 3 MHz Peak (AV), RB = 1 MHz, VB = 10 Hz
Input Power	120 Vac, 60 Hz	Environmental Conditions	23°C, 67% RH
Tested By	Adair Peng		

Antenna Polarity & Test Distance : Horizontal at 3 m								
No	Frequency (MHz)	Emission Level (dBuV/m)	Limit (dBuV/m)	Margin (dB)	Antenna Height (m)	Table Angle (Degree)	Raw Value (dBuV)	Correction Factor (dB/m)
1	5460.00	65.4 PK	74.0	-8.6	2.74 H	195	44.0	21.4
2	5460.00	52.3 AV	54.0	-1.7	2.74 H	195	30.9	21.4
3	#5470.00	67.6 PK	68.2	-0.6	2.74 H	195	46.2	21.4
4	*5510.00	118.4 PK			2.74 H	195	76.9	41.5
5	*5510.00	105.9 AV			2.74 H	195	64.4	41.5
6	11020.00	63.0 PK	74.0	-11.0	2.60 H	171	36.3	26.7
7	11020.00	49.7 AV	54.0	-4.3	2.60 H	171	23.0	26.7
Antenna Polarity & Test Distance : Vertical at 3 m								
No	Frequency (MHz)	Emission Level (dBuV/m)	Limit (dBuV/m)	Margin (dB)	Antenna Height (m)	Table Angle (Degree)	Raw Value (dBuV)	Correction Factor (dB/m)
1	5460.00	61.5 PK	74.0	-12.5	3.33 V	289	40.1	21.4
2	5460.00	48.8 AV	54.0	-5.2	3.33 V	289	27.4	21.4
3	#5470.00	62.8 PK	68.2	-5.4	3.33 V	289	41.4	21.4
4	*5510.00	109.4 PK			3.33 V	289	67.9	41.5
5	*5510.00	96.8 AV			3.33 V	289	55.3	41.5
6	11020.00	62.8 PK	74.0	-11.2	3.06 V	291	36.1	26.7
7	11020.00	49.5 AV	54.0	-4.5	3.06 V	291	22.8	26.7

**Remarks:**

1. Emission Level(dBuV/m) = Raw Value(dBuV) + Correction Factor(dB/m)
2. Correction Factor(dB/m) = Antenna Factor(dB/m) + Cable Factor(dB) – Pre-Amplifier Factor(dB)
3. Margin value = Emission Level – Limit value
4. The other emission levels were very low against the limit.
5. " \* " : Fundamental frequency, the limit was restricted at the RF Output Power.
6. " # " : The radiated frequency is out of the restricted band.



RF Mode	802.11ax (HE40)	Channel	CH 110 : 5550 MHz
Frequency Range	1 GHz ~ 40 GHz	Detector Function & Bandwidth	Peak (PK), RB = 1 MHz, VB = 3 MHz Peak (AV), RB = 1 MHz, VB = 10 Hz
Input Power	120 Vac, 60 Hz	Environmental Conditions	23°C, 67% RH
Tested By	Adair Peng		

Antenna Polarity & Test Distance : Horizontal at 3 m								
No	Frequency (MHz)	Emission Level (dBuV/m)	Limit (dBuV/m)	Margin (dB)	Antenna Height (m)	Table Angle (Degree)	Raw Value (dBuV)	Correction Factor (dB/m)
1	*5550.00	117.8 PK			3.71 H	1	76.3	41.5
2	*5550.00	105.4 AV			3.71 H	1	63.9	41.5
3	11100.00	62.5 PK	74.0	-11.5	2.28 H	313	36.3	26.2
4	11100.00	49.2 AV	54.0	-4.8	2.28 H	313	23.0	26.2
Antenna Polarity & Test Distance : Vertical at 3 m								
No	Frequency (MHz)	Emission Level (dBuV/m)	Limit (dBuV/m)	Margin (dB)	Antenna Height (m)	Table Angle (Degree)	Raw Value (dBuV)	Correction Factor (dB/m)
1	*5550.00	113.9 PK			3.50 V	290	72.4	41.5
2	*5550.00	101.3 AV			3.50 V	290	59.8	41.5
3	11100.00	62.2 PK	74.0	-11.8	3.08 V	39	36.0	26.2
4	11100.00	49.0 AV	54.0	-5.0	3.08 V	39	22.8	26.2

Remarks:

1. Emission Level(dBuV/m) = Raw Value(dBuV) + Correction Factor(dB/m)
2. Correction Factor(dB/m) = Antenna Factor(dB/m) + Cable Factor(dB) – Pre-Amplifier Factor(dB)
3. Margin value = Emission Level – Limit value
4. The other emission levels were very low against the limit.
5. " \* " : Fundamental frequency, the limit was restricted at the RF Output Power.





RF Mode	802.11ax (HE40)	Channel	CH 134 : 5670 MHz
Frequency Range	1 GHz ~ 40 GHz	Detector Function & Bandwidth	Peak (PK), RB = 1 MHz, VB = 3 MHz Peak (AV), RB = 1 MHz, VB = 10 Hz
Input Power	120 Vac, 60 Hz	Environmental Conditions	23°C, 67% RH
Tested By	Adair Peng		

Antenna Polarity & Test Distance : Horizontal at 3 m								
No	Frequency (MHz)	Emission Level (dBuV/m)	Limit (dBuV/m)	Margin (dB)	Antenna Height (m)	Table Angle (Degree)	Raw Value (dBuV)	Correction Factor (dB/m)
1	*5670.00	116.7 PK			3.93 H	0	75.0	41.7
2	*5670.00	104.6 AV			3.93 H	0	62.9	41.7
3	#5725.00	65.2 PK	68.2	-3.0	3.93 H	0	43.0	22.2
4	11340.00	62.6 PK	74.0	-11.4	2.30 H	304	36.2	26.4
5	11340.00	49.5 AV	54.0	-4.5	2.30 H	304	23.1	26.4
Antenna Polarity & Test Distance : Vertical at 3 m								
No	Frequency (MHz)	Emission Level (dBuV/m)	Limit (dBuV/m)	Margin (dB)	Antenna Height (m)	Table Angle (Degree)	Raw Value (dBuV)	Correction Factor (dB/m)
1	*5670.00	112.6 PK			3.39 V	287	70.9	41.7
2	*5670.00	100.5 AV			3.39 V	287	58.8	41.7
3	#5725.00	65.1 PK	68.2	-3.1	3.39 V	287	42.9	22.2
4	11340.00	62.4 PK	74.0	-11.6	2.99 V	45	36.0	26.4
5	11340.00	49.2 AV	54.0	-4.8	2.99 V	45	22.8	26.4

Remarks:

1. Emission Level(dBuV/m) = Raw Value(dBuV) + Correction Factor(dB/m)
2. Correction Factor(dB/m) = Antenna Factor(dB/m) + Cable Factor(dB) – Pre-Amplifier Factor(dB)
3. Margin value = Emission Level – Limit value
4. The other emission levels were very low against the limit.
5. " \* ": Fundamental frequency, the limit was restricted at the RF Output Power.
6. " # ": The radiated frequency is out of the restricted band.



RF Mode	802.11ax (HE40)	Channel	CH 142 : 5710 MHz
Frequency Range	1 GHz ~ 40 GHz	Detector Function & Bandwidth	Peak (PK), RB = 1 MHz, VB = 3 MHz Peak (AV), RB = 1 MHz, VB = 10 Hz
Input Power	120 Vac, 60 Hz	Environmental Conditions	23°C, 67% RH
Tested By	Adair Peng		

Antenna Polarity & Test Distance : Horizontal at 3 m

No	Frequency (MHz)	Emission Level (dBuV/m)	Limit (dBuV/m)	Margin (dB)	Antenna Height (m)	Table Angle (Degree)	Raw Value (dBuV)	Correction Factor (dB/m)
1	#5470.00	62.9 PK	68.2	-5.3	3.86 H	359	41.5	21.4
2	*5710.00	117.4 PK			3.86 H	359	75.6	41.8
3	*5710.00	104.7 AV			3.86 H	359	62.9	41.8
4	#5850.00	64.6 PK	68.2	-3.6	3.86 H	359	42.1	22.5
5	11420.00	63.1 PK	74.0	-10.9	2.26 H	299	36.0	27.1
6	11420.00	50.0 AV	54.0	-4.0	2.26 H	299	22.9	27.1

Antenna Polarity & Test Distance : Vertical at 3 m

No	Frequency (MHz)	Emission Level (dBuV/m)	Limit (dBuV/m)	Margin (dB)	Antenna Height (m)	Table Angle (Degree)	Raw Value (dBuV)	Correction Factor (dB/m)
1	#5470.00	62.7 PK	68.2	-5.5	3.50 V	286	41.3	21.4
2	*5710.00	113.0 PK			3.50 V	286	71.2	41.8
3	*5710.00	100.4 AV			3.50 V	286	58.6	41.8
4	#5850.00	64.5 PK	68.2	-3.7	3.50 V	286	42.0	22.5
5	11420.00	62.9 PK	74.0	-11.1	3.00 V	45	35.8	27.1
6	11420.00	49.9 AV	54.0	-4.1	3.00 V	45	22.8	27.1

Remarks:

1. Emission Level(dBuV/m) = Raw Value(dBuV) + Correction Factor(dB/m)
2. Correction Factor(dB/m) = Antenna Factor(dB/m) + Cable Factor(dB) – Pre-Amplifier Factor(dB)
3. Margin value = Emission Level – Limit value
4. The other emission levels were very low against the limit.
5. " \* ": Fundamental frequency, the limit was restricted at the RF Output Power.
6. " # ": The radiated frequency is out of the restricted band.



RF Mode	802.11ax (HE40)	Channel	CH 151 : 5755 MHz
Frequency Range	1 GHz ~ 40 GHz	Detector Function & Bandwidth	Peak (PK), RB = 1 MHz, VB = 3 MHz Peak (AV), RB = 1 MHz, VB = 10 Hz
Input Power	120 Vac, 60 Hz	Environmental Conditions	23°C, 67% RH
Tested By	Adair Peng		

Antenna Polarity & Test Distance : Horizontal at 3 m

No	Frequency (MHz)	Emission Level (dBuV/m)	Limit (dBuV/m)	Margin (dB)	Antenna Height (m)	Table Angle (Degree)	Raw Value (dBuV)	Correction Factor (dB/m)
1	#5645.60	66.3 PK	68.2	-1.9	3.41 H	346	44.4	21.9
2	*5755.00	122.7 PK			3.41 H	346	80.6	42.1
3	*5755.00	110.1 AV			3.41 H	346	68.0	42.1
4	#5944.40	62.1 PK	68.2	-6.1	3.41 H	346	39.6	22.5
5	11510.00	62.9 PK	74.0	-11.1	2.27 H	296	35.6	27.3
6	11510.00	49.8 AV	54.0	-4.2	2.27 H	296	22.5	27.3

Antenna Polarity & Test Distance : Vertical at 3 m

No	Frequency (MHz)	Emission Level (dBuV/m)	Limit (dBuV/m)	Margin (dB)	Antenna Height (m)	Table Angle (Degree)	Raw Value (dBuV)	Correction Factor (dB/m)
1	#5646.80	64.5 PK	68.2	-3.7	3.55 V	287	42.6	21.9
2	*5755.00	118.7 PK			3.55 V	287	76.6	42.1
3	*5755.00	106.0 AV			3.55 V	287	63.9	42.1
4	#5932.40	63.1 PK	68.2	-5.1	3.55 V	287	40.6	22.5
5	11510.00	62.8 PK	74.0	-11.2	3.03 V	41	35.5	27.3
6	11510.00	49.6 AV	54.0	-4.4	3.03 V	41	22.3	27.3

Remarks:

1. Emission Level(dBuV/m) = Raw Value(dBuV) + Correction Factor(dB/m)
2. Correction Factor(dB/m) = Antenna Factor(dB/m) + Cable Factor(dB) – Pre-Amplifier Factor(dB)
3. Margin value = Emission Level – Limit value
4. The other emission levels were very low against the limit.
5. " \* ": Fundamental frequency, the limit was restricted at the RF Output Power.



RF Mode	802.11ax (HE40)	Channel	CH 159 : 5795 MHz
Frequency Range	1 GHz ~ 40 GHz	Detector Function & Bandwidth	Peak (PK), RB = 1 MHz, VB = 3 MHz Peak (AV), RB = 1 MHz, VB = 10 Hz
Input Power	120 Vac, 60 Hz	Environmental Conditions	23°C, 67% RH
Tested By	Adair Peng		

Antenna Polarity & Test Distance : Horizontal at 3 m								
No	Frequency (MHz)	Emission Level (dBuV/m)	Limit (dBuV/m)	Margin (dB)	Antenna Height (m)	Table Angle (Degree)	Raw Value (dBuV)	Correction Factor (dB/m)
1	#5649.20	64.6 PK	68.2	-3.6	3.72 H	3	42.7	21.9
2	*5795.00	122.8 PK			3.72 H	3	80.6	42.2
3	*5795.00	109.6 AV			3.72 H	3	67.4	42.2
4	#5940.80	63.2 PK	68.2	-5.0	3.72 H	3	40.7	22.5
5	11590.00	62.9 PK	74.0	-11.1	2.22 H	293	35.8	27.1
6	11590.00	49.7 AV	54.0	-4.3	2.22 H	293	22.6	27.1
Antenna Polarity & Test Distance : Vertical at 3 m								
No	Frequency (MHz)	Emission Level (dBuV/m)	Limit (dBuV/m)	Margin (dB)	Antenna Height (m)	Table Angle (Degree)	Raw Value (dBuV)	Correction Factor (dB/m)
1	#5639.60	62.3 PK	68.2	-5.9	3.44 V	285	40.5	21.8
2	*5795.00	117.3 PK			3.44 V	285	75.1	42.2
3	*5795.00	104.9 AV			3.44 V	285	62.7	42.2
4	#5933.20	62.7 PK	68.2	-5.5	3.44 V	285	40.2	22.5
5	11590.00	62.6 PK	74.0	-11.4	3.05 V	39	35.5	27.1
6	11590.00	49.5 AV	54.0	-4.5	3.05 V	39	22.4	27.1

## Remarks:

1. Emission Level(dBuV/m) = Raw Value(dBuV) + Correction Factor(dB/m)
2. Correction Factor(dB/m) = Antenna Factor(dB/m) + Cable Factor(dB) – Pre-Amplifier Factor(dB)
3. Margin value = Emission Level – Limit value
4. The other emission levels were very low against the limit.
5. " \* " : Fundamental frequency, the limit was restricted at the RF Output Power.
6. " # " : The radiated frequency is out of the restricted band.

RF Mode	802.11ax (HE80)	Channel	CH 42 : 5210 MHz
Frequency Range	1 GHz ~ 40 GHz	Detector Function & Bandwidth	Peak (PK), RB = 1 MHz, VB = 3 MHz Peak (AV), RB = 1 MHz, VB = 10 Hz
Input Power	120 Vac, 60 Hz	Environmental Conditions	23°C, 67% RH
Tested By	Adair Peng		

Antenna Polarity & Test Distance : Horizontal at 3 m								
No	Frequency (MHz)	Emission Level (dBuV/m)	Limit (dBuV/m)	Margin (dB)	Antenna Height (m)	Table Angle (Degree)	Raw Value (dBuV)	Correction Factor (dB/m)
1	5150.00	66.2 PK	74.0	-7.8	2.75 H	191	45.2	21.0
2	<b>5150.00</b>	<b>53.8 AV</b>	<b>54.0</b>	<b>-0.2</b>	<b>2.75 H</b>	<b>191</b>	<b>32.8</b>	<b>21.0</b>
3	*5210.00	116.0 PK			2.75 H	191	75.0	41.0
4	*5210.00	103.5 AV			2.75 H	191	62.5	41.0
5	#10420.00	61.9 PK	68.2	-6.3	2.67 H	162	37.3	24.6

Antenna Polarity & Test Distance : Vertical at 3 m								
No	Frequency (MHz)	Emission Level (dBuV/m)	Limit (dBuV/m)	Margin (dB)	Antenna Height (m)	Table Angle (Degree)	Raw Value (dBuV)	Correction Factor (dB/m)
1	5150.00	63.1 PK	74.0	-10.9	3.25 V	286	42.1	21.0
2	5150.00	51.0 AV	54.0	-3.0	3.25 V	286	30.0	21.0
3	*5210.00	107.5 PK			3.25 V	286	66.5	41.0
4	*5210.00	94.5 AV			3.25 V	286	53.5	41.0
5	#10420.00	61.6 PK	68.2	-6.6	2.97 V	299	37.0	24.6

**Remarks:**

1. Emission Level(dBuV/m) = Raw Value(dBuV) + Correction Factor(dB/m)
2. Correction Factor(dB/m) = Antenna Factor(dB/m) + Cable Factor(dB) – Pre-Amplifier Factor(dB)
3. Margin value = Emission Level – Limit value
4. The other emission levels were very low against the limit.
5. " \* ": Fundamental frequency, the limit was restricted at the RF Output Power.
6. " # ": The radiated frequency is out of the restricted band.



RF Mode	802.11ax (HE80)	Channel	CH 58 : 5290 MHz
Frequency Range	1 GHz ~ 40 GHz	Detector Function & Bandwidth	Peak (PK), RB = 1 MHz, VB = 3 MHz Peak (AV), RB = 1 MHz, VB = 10 Hz
Input Power	120 Vac, 60 Hz	Environmental Conditions	23°C, 67% RH
Tested By	Adair Peng		

Antenna Polarity & Test Distance : Horizontal at 3 m								
No	Frequency (MHz)	Emission Level (dBuV/m)	Limit (dBuV/m)	Margin (dB)	Antenna Height (m)	Table Angle (Degree)	Raw Value (dBuV)	Correction Factor (dB/m)
1	*5290.00	115.6 PK			2.68 H	190	74.8	40.8
2	*5290.00	102.7 AV			2.68 H	190	61.9	40.8
3	5350.00	65.4 PK	74.0	-8.6	2.68 H	190	44.4	21.0
4	5350.00	53.6 AV	54.0	-0.4	2.68 H	190	32.6	21.0
5	#10580.00	62.4 PK	68.2	-5.8	2.53 H	169	37.4	25.0

Antenna Polarity & Test Distance : Vertical at 3 m								
No	Frequency (MHz)	Emission Level (dBuV/m)	Limit (dBuV/m)	Margin (dB)	Antenna Height (m)	Table Angle (Degree)	Raw Value (dBuV)	Correction Factor (dB/m)
1	*5290.00	106.5 PK			2.97 V	286	65.7	40.8
2	*5290.00	93.7 AV			2.97 V	286	52.9	40.8
3	5350.00	61.9 PK	74.0	-12.1	2.97 V	286	40.9	21.0
4	5350.00	48.4 AV	54.0	-5.6	2.97 V	286	27.4	21.0
5	#10580.00	62.1 PK	68.2	-6.1	3.03 V	297	37.1	25.0

Remarks:

1. Emission Level(dBuV/m) = Raw Value(dBuV) + Correction Factor(dB/m)
2. Correction Factor(dB/m) = Antenna Factor(dB/m) + Cable Factor(dB) – Pre-Amplifier Factor(dB)
3. Margin value = Emission Level – Limit value
4. The other emission levels were very low against the limit.
5. " \* " : Fundamental frequency, the limit was restricted at the RF Output Power.
6. " # " : The radiated frequency is out of the restricted band.

RF Mode	802.11ax (HE80)	Channel	CH 106 : 5530 MHz
Frequency Range	1 GHz ~ 40 GHz	Detector Function & Bandwidth	Peak (PK), RB = 1 MHz, VB = 3 MHz Peak (AV), RB = 1 MHz, VB = 10 Hz
Input Power	120 Vac, 60 Hz	Environmental Conditions	23°C, 67% RH
Tested By	Adair Peng		

Antenna Polarity & Test Distance : Horizontal at 3 m								
No	Frequency (MHz)	Emission Level (dBuV/m)	Limit (dBuV/m)	Margin (dB)	Antenna Height (m)	Table Angle (Degree)	Raw Value (dBuV)	Correction Factor (dB/m)
1	5460.00	63.8 PK	74.0	-10.2	3.54 H	3	42.4	21.4
2	5460.00	50.6 AV	54.0	-3.4	3.54 H	3	29.2	21.4
3	#5470.00	64.2 PK	68.2	-4.0	3.54 H	3	42.8	21.4
4	*5530.00	114.8 PK			3.54 H	3	73.3	41.5
5	*5530.00	102.3 AV			3.54 H	3	60.8	41.5
6	11060.00	62.6 PK	74.0	-11.4	2.28 H	305	36.2	26.4
7	11060.00	49.6 AV	54.0	-4.4	2.28 H	305	23.2	26.4
Antenna Polarity & Test Distance : Vertical at 3 m								
No	Frequency (MHz)	Emission Level (dBuV/m)	Limit (dBuV/m)	Margin (dB)	Antenna Height (m)	Table Angle (Degree)	Raw Value (dBuV)	Correction Factor (dB/m)
1	5460.00	62.7 PK	74.0	-11.3	3.39 V	282	41.3	21.4
2	5460.00	49.9 AV	54.0	-4.1	3.39 V	282	28.5	21.4
3	#5470.00	64.0 PK	68.2	-4.2	3.39 V	282	42.6	21.4
4	*5530.00	110.2 PK			3.39 V	282	68.7	41.5
5	*5530.00	97.9 AV			3.39 V	282	56.4	41.5
6	11060.00	62.4 PK	74.0	-11.6	3.08 V	46	36.0	26.4
7	11060.00	49.4 AV	54.0	-4.6	3.08 V	46	23.0	26.4

**Remarks:**

1. Emission Level(dBuV/m) = Raw Value(dBuV) + Correction Factor(dB/m)
2. Correction Factor(dB/m) = Antenna Factor(dB/m) + Cable Factor(dB) – Pre-Amplifier Factor(dB)
3. Margin value = Emission Level – Limit value
4. The other emission levels were very low against the limit.
5. " \* ": Fundamental frequency, the limit was restricted at the RF Output Power.
6. " # ": The radiated frequency is out of the restricted band.

RF Mode	802.11ax (HE80)	Channel	CH 122 : 5610 MHz
Frequency Range	1 GHz ~ 40 GHz	Detector Function & Bandwidth	Peak (PK), RB = 1 MHz, VB = 3 MHz Peak (AV), RB = 1 MHz, VB = 10 Hz
Input Power	120 Vac, 60 Hz	Environmental Conditions	23°C, 67% RH
Tested By	Adair Peng		

Antenna Polarity & Test Distance : Horizontal at 3 m								
No	Frequency (MHz)	Emission Level (dBuV/m)	Limit (dBuV/m)	Margin (dB)	Antenna Height (m)	Table Angle (Degree)	Raw Value (dBuV)	Correction Factor (dB/m)
1	*5610.00	114.5 PK			3.25 H	348	72.9	41.6
2	*5610.00	101.9 AV			3.25 H	348	60.3	41.6
3	#5725.00	65.4 PK	68.2	-2.8	3.25 H	348	43.2	22.2
4	11220.00	61.8 PK	74.0	-12.2	2.25 H	314	36.0	25.8
5	11220.00	49.1 AV	54.0	-4.9	2.25 H	314	23.3	25.8
Antenna Polarity & Test Distance : Vertical at 3 m								
No	Frequency (MHz)	Emission Level (dBuV/m)	Limit (dBuV/m)	Margin (dB)	Antenna Height (m)	Table Angle (Degree)	Raw Value (dBuV)	Correction Factor (dB/m)
1	*5610.00	109.2 PK			3.53 V	293	67.6	41.6
2	*5610.00	97.6 AV			3.53 V	293	56.0	41.6
3	#5725.00	64.2 PK	68.2	-4.0	3.53 V	293	42.0	22.2
4	11220.00	61.7 PK	74.0	-12.3	2.96 V	40	35.9	25.8
5	11220.00	48.9 AV	54.0	-5.1	2.96 V	40	23.1	25.8

**Remarks:**

1. Emission Level(dBuV/m) = Raw Value(dBuV) + Correction Factor(dB/m)
2. Correction Factor(dB/m) = Antenna Factor(dB/m) + Cable Factor(dB) – Pre-Amplifier Factor(dB)
3. Margin value = Emission Level – Limit value
4. The other emission levels were very low against the limit.
5. " \* " : Fundamental frequency, the limit was restricted at the RF Output Power.
6. " # " : The radiated frequency is out of the restricted band.





RF Mode	802.11ax (HE80)	Channel	CH 138 : 5690 MHz
Frequency Range	1 GHz ~ 40 GHz	Detector Function & Bandwidth	Peak (PK), RB = 1 MHz, VB = 3 MHz Peak (AV), RB = 1 MHz, VB = 10 Hz
Input Power	120 Vac, 60 Hz	Environmental Conditions	23°C, 67% RH
Tested By	Adair Peng		

Antenna Polarity & Test Distance : Horizontal at 3 m								
No	Frequency (MHz)	Emission Level (dBuV/m)	Limit (dBuV/m)	Margin (dB)	Antenna Height (m)	Table Angle (Degree)	Raw Value (dBuV)	Correction Factor (dB/m)
1	#5470.00	62.6 PK	68.2	-5.6	3.93 H	359	41.2	21.4
2	*5690.00	112.9 PK			3.93 H	359	71.2	41.7
3	*5690.00	100.9 AV			3.93 H	359	59.2	41.7
4	#5850.00	64.3 PK	68.2	-3.9	3.93 H	359	41.8	22.5
5	11380.00	62.6 PK	74.0	-11.4	2.31 H	303	35.8	26.8
6	11380.00	49.8 AV	54.0	-4.2	2.31 H	303	23.0	26.8

Antenna Polarity & Test Distance : Vertical at 3 m								
No	Frequency (MHz)	Emission Level (dBuV/m)	Limit (dBuV/m)	Margin (dB)	Antenna Height (m)	Table Angle (Degree)	Raw Value (dBuV)	Correction Factor (dB/m)
1	#5470.00	62.4 PK	68.2	-5.8	3.47 V	291	41.0	21.4
2	*5690.00	109.6 PK			3.47 V	291	67.9	41.7
3	*5690.00	96.9 AV			3.47 V	291	55.2	41.7
4	#5850.00	64.1 PK	68.2	-4.1	3.47 V	291	41.6	22.5
5	11380.00	62.4 PK	74.0	-11.6	3.08 V	45	35.6	26.8
6	11380.00	49.7 AV	54.0	-4.3	3.08 V	45	22.9	26.8

Remarks:

1. Emission Level(dBuV/m) = Raw Value(dBuV) + Correction Factor(dB/m)
2. Correction Factor(dB/m) = Antenna Factor(dB/m) + Cable Factor(dB) – Pre-Amplifier Factor(dB)
3. Margin value = Emission Level – Limit value
4. The other emission levels were very low against the limit.
5. " \* ": Fundamental frequency, the limit was restricted at the RF Output Power.
6. " # ": The radiated frequency is out of the restricted band.

RF Mode	802.11ax (HE80)	Channel	CH 155 : 5775 MHz
Frequency Range	1 GHz ~ 40 GHz	Detector Function & Bandwidth	Peak (PK), RB = 1 MHz, VB = 3 MHz Peak (AV), RB = 1 MHz, VB = 10 Hz
Input Power	120 Vac, 60 Hz	Environmental Conditions	23°C, 67% RH
Tested By	Adair Peng		

Antenna Polarity & Test Distance : Horizontal at 3 m								
No	Frequency (MHz)	Emission Level (dBuV/m)	Limit (dBuV/m)	Margin (dB)	Antenna Height (m)	Table Angle (Degree)	Raw Value (dBuV)	Correction Factor (dB/m)
1	#5642.00	67.8 PK	68.2	-0.4	2.77 H	354	46.0	21.8
2	*5775.00	118.6 PK			2.77 H	354	76.5	42.1
3	*5775.00	106.2 AV			2.77 H	354	64.1	42.1
4	#5930.00	63.8 PK	68.2	-4.4	2.77 H	354	41.3	22.5
5	11550.00	63.7 PK	74.0	-10.3	2.61 H	188	36.4	27.3
6	11550.00	50.5 AV	54.0	-3.5	2.61 H	188	23.2	27.3
Antenna Polarity & Test Distance : Vertical at 3 m								
No	Frequency (MHz)	Emission Level (dBuV/m)	Limit (dBuV/m)	Margin (dB)	Antenna Height (m)	Table Angle (Degree)	Raw Value (dBuV)	Correction Factor (dB/m)
1	#5640.40	62.2 PK	68.2	-6.0	3.23 V	289	40.4	21.8
2	*5775.00	108.4 PK			3.23 V	289	66.3	42.1
3	*5775.00	96.8 AV			3.23 V	289	54.7	42.1
4	#5945.60	62.6 PK	68.2	-5.6	3.23 V	289	40.1	22.5
5	11550.00	63.3 PK	74.0	-10.7	2.89 V	312	36.0	27.3
6	11550.00	50.2 AV	54.0	-3.8	2.89 V	312	22.9	27.3

**Remarks:**

1. Emission Level(dBuV/m) = Raw Value(dBuV) + Correction Factor(dB/m)
2. Correction Factor(dB/m) = Antenna Factor(dB/m) + Cable Factor(dB) – Pre-Amplifier Factor(dB)
3. Margin value = Emission Level – Limit value
4. The other emission levels were very low against the limit.
5. " \* ": Fundamental frequency, the limit was restricted at the RF Output Power.



RF Mode	802.11ax (HE160)	Channel	CH 50 : 5250 MHz
Frequency Range	1 GHz ~ 40 GHz	Detector Function & Bandwidth	Peak (PK), RB = 1 MHz, VB = 3 MHz Peak (AV), RB = 1 MHz, VB = 10 Hz
Input Power	120 Vac, 60 Hz	Environmental Conditions	23°C, 67% RH
Tested By	Adair Peng		

Antenna Polarity & Test Distance : Horizontal at 3 m								
No	Frequency (MHz)	Emission Level (dBuV/m)	Limit (dBuV/m)	Margin (dB)	Antenna Height (m)	Table Angle (Degree)	Raw Value (dBuV)	Correction Factor (dB/m)
1	5150.00	70.2 PK	74.0	-3.8	2.77 H	192	49.2	21.0
2	5150.00	53.0 AV	54.0	-1.0	2.77 H	192	32.0	21.0
3	*5250.00	112.1 PK			2.77 H	192	71.3	40.8
4	*5250.00	99.9 AV			2.77 H	192	59.1	40.8
5	5350.00	69.1 PK	74.0	-4.9	2.77 H	192	48.1	21.0
6	5350.00	53.5 AV	54.0	-0.5	2.77 H	192	32.5	21.0
7	#10500.00	62.3 PK	68.2	-5.9	2.42 H	177	37.3	25.0
Antenna Polarity & Test Distance : Vertical at 3 m								
No	Frequency (MHz)	Emission Level (dBuV/m)	Limit (dBuV/m)	Margin (dB)	Antenna Height (m)	Table Angle (Degree)	Raw Value (dBuV)	Correction Factor (dB/m)
1	5150.00	63.9 PK	74.0	-10.1	2.93 V	282	42.9	21.0
2	5150.00	49.2 AV	54.0	-4.8	2.93 V	282	28.2	21.0
3	*5250.00	103.5 PK			2.93 V	282	62.7	40.8
4	*5250.00	90.9 AV			2.93 V	282	50.1	40.8
5	5350.00	62.0 PK	74.0	-12.0	2.93 V	282	41.0	21.0
6	5350.00	48.4 AV	54.0	-5.6	2.93 V	282	27.4	21.0
7	#10500.00	62.1 PK	68.2	-6.1	3.06 V	287	37.1	25.0

Remarks:

1. Emission Level(dBuV/m) = Raw Value(dBuV) + Correction Factor(dB/m)
2. Correction Factor(dB/m) = Antenna Factor(dB/m) + Cable Factor(dB) – Pre-Amplifier Factor(dB)
3. Margin value = Emission Level – Limit value
4. The other emission levels were very low against the limit.
5. " \* " : Fundamental frequency, the limit was restricted at the RF Output Power.
6. " # " : The radiated frequency is out of the restricted band.



RF Mode	802.11ax (HE160)	Channel	CH 114 : 5570 MHz
Frequency Range	1 GHz ~ 40 GHz	Detector Function & Bandwidth	Peak (PK), RB = 1 MHz, VB = 3 MHz Peak (AV), RB = 1 MHz, VB = 10 Hz
Input Power	120 Vac, 60 Hz	Environmental Conditions	23°C, 67% RH
Tested By	Adair Peng		

Antenna Polarity & Test Distance : Horizontal at 3 m

No	Frequency (MHz)	Emission Level (dBuV/m)	Limit (dBuV/m)	Margin (dB)	Antenna Height (m)	Table Angle (Degree)	Raw Value (dBuV)	Correction Factor (dB/m)
1	5460.00	67.9 PK	74.0	-6.1	2.83 H	193	46.5	21.4
2	5460.00	52.8 AV	54.0	-1.2	2.83 H	193	31.4	21.4
3	#5470.00	67.6 PK	68.2	-0.6	2.83 H	193	46.2	21.4
4	*5570.00	111.1 PK			2.83 H	193	69.5	41.6
5	*5570.00	99.1 AV			2.83 H	193	57.5	41.6
6	#5725.00	64.7 PK	68.2	-3.5	2.83 H	193	42.5	22.2
7	11140.00	62.4 PK	74.0	-11.6	2.58 H	167	36.3	26.1
8	11140.00	49.4 AV	54.0	-4.6	2.58 H	167	23.3	26.1

Antenna Polarity & Test Distance : Vertical at 3 m

No	Frequency (MHz)	Emission Level (dBuV/m)	Limit (dBuV/m)	Margin (dB)	Antenna Height (m)	Table Angle (Degree)	Raw Value (dBuV)	Correction Factor (dB/m)
1	5460.00	62.5 PK	74.0	-11.5	3.09 V	287	41.1	21.4
2	5460.00	49.3 AV	54.0	-4.7	3.09 V	287	27.9	21.4
3	#5470.00	61.8 PK	68.2	-6.4	3.09 V	287	40.4	21.4
4	*5570.00	101.8 PK			3.09 V	287	60.2	41.6
5	*5570.00	90.0 AV			3.09 V	287	48.4	41.6
6	#5725.00	62.9 PK	68.2	-5.3	3.09 V	287	40.7	22.2
7	11140.00	62.2 PK	74.0	-11.8	3.17 V	282	36.1	26.1
8	11140.00	49.2 AV	54.0	-4.8	3.17 V	282	23.1	26.1

Remarks:

1. Emission Level(dBuV/m) = Raw Value(dBuV) + Correction Factor(dB/m)
2. Correction Factor(dB/m) = Antenna Factor(dB/m) + Cable Factor(dB) – Pre-Amplifier Factor(dB)
3. Margin value = Emission Level – Limit value
4. The other emission levels were very low against the limit.
5. " \* " : Fundamental frequency, the limit was restricted at the RF Output Power.
6. " # " : The radiated frequency is out of the restricted band.

Plot of Band Edge

Frequency Range	4.5 GHz ~ 5.46 GHz	Detector Function & Bandwidth	Peak (PK), RB = 1 MHz, VB = 3 MHz Peak (AV), RB = 1 MHz, VB = 10 Hz
-----------------	--------------------	-------------------------------	--

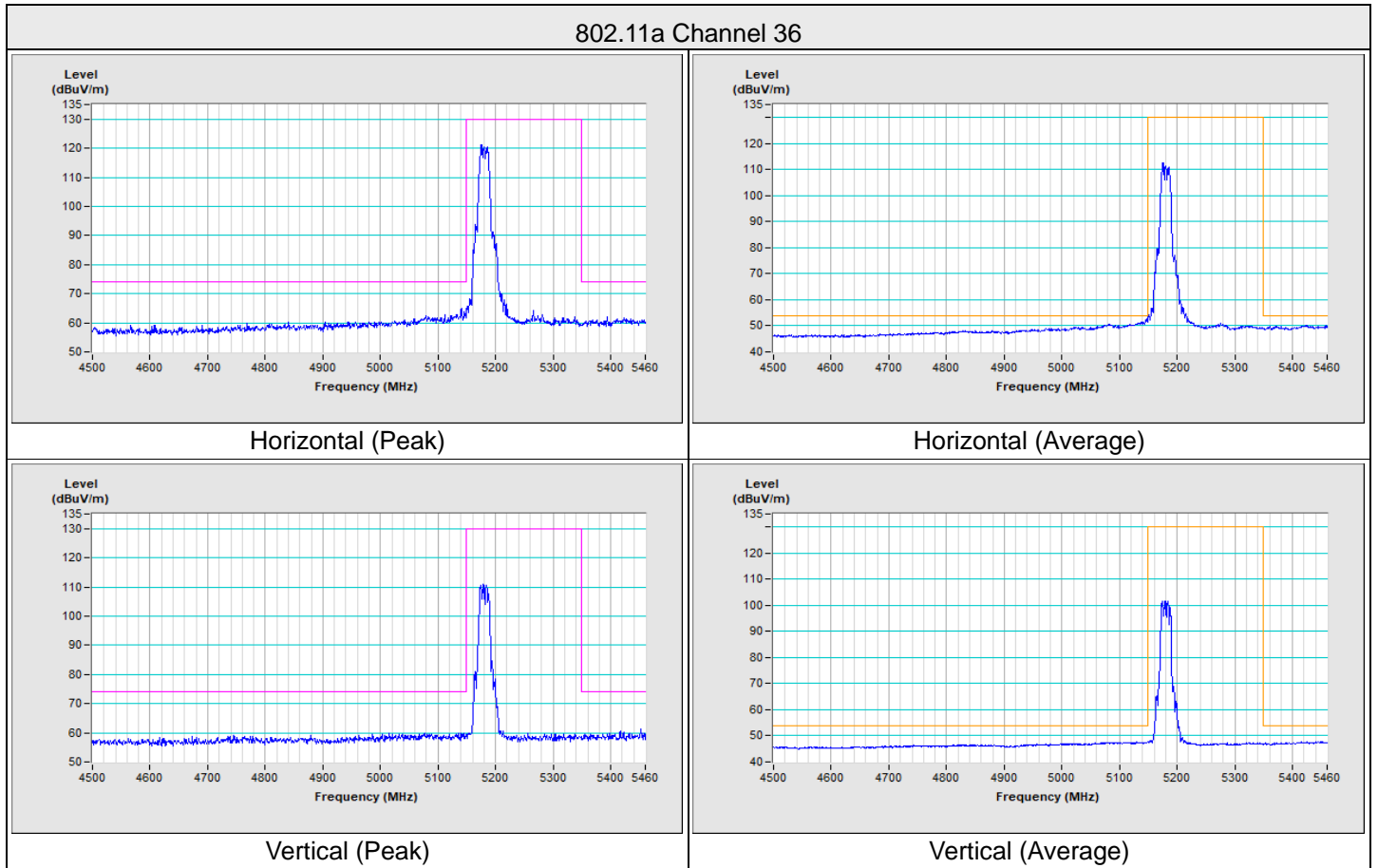

### 802.11a Channel 48

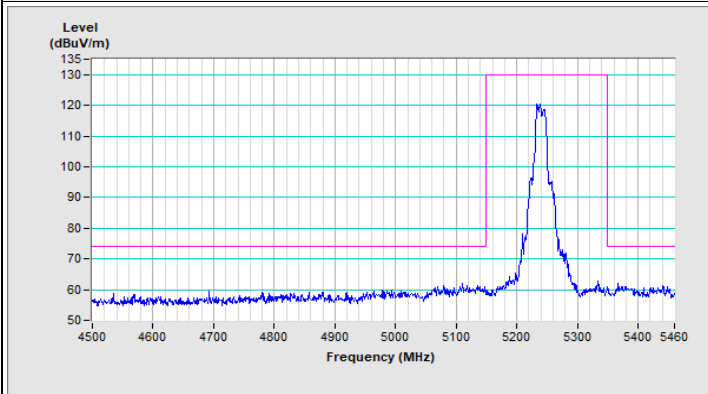

Horizontal (Peak)

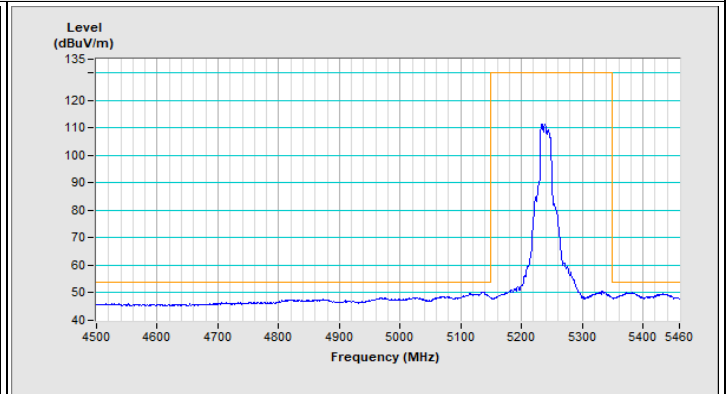

Horizontal (Average)

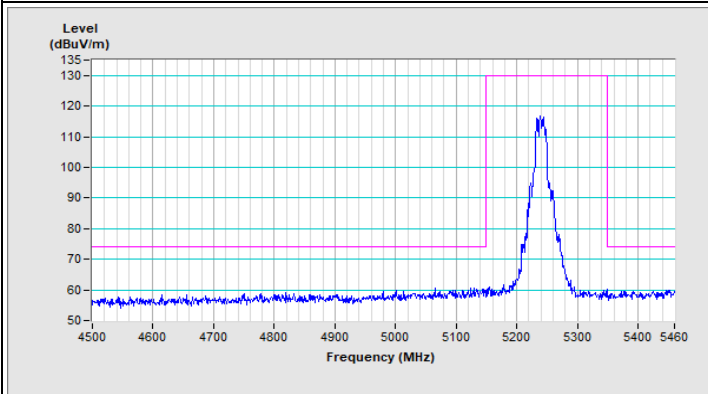

Vertical (Peak)

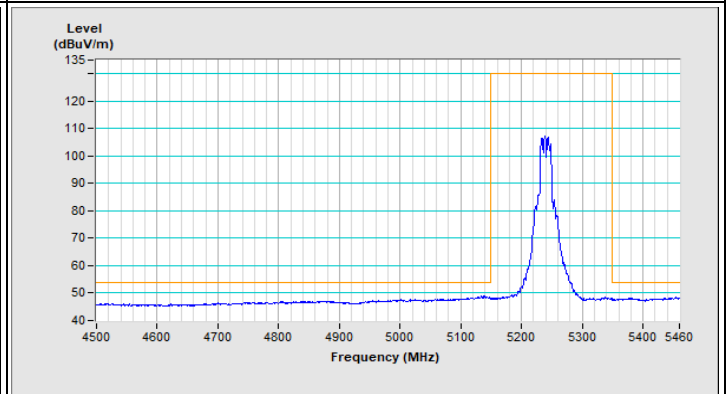

Vertical (Average)

### 802.11a Channel 52

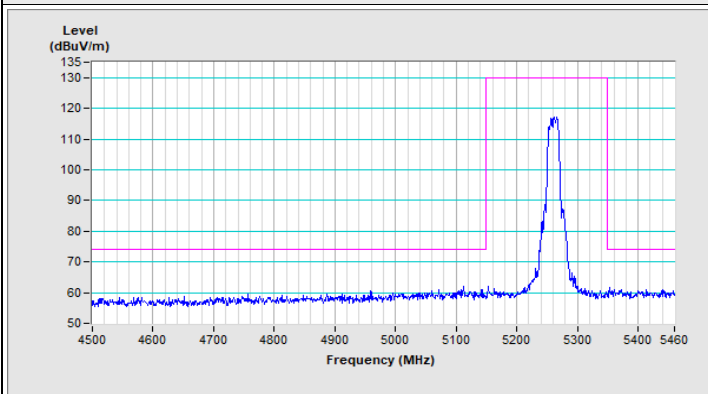

Horizontal (Peak)

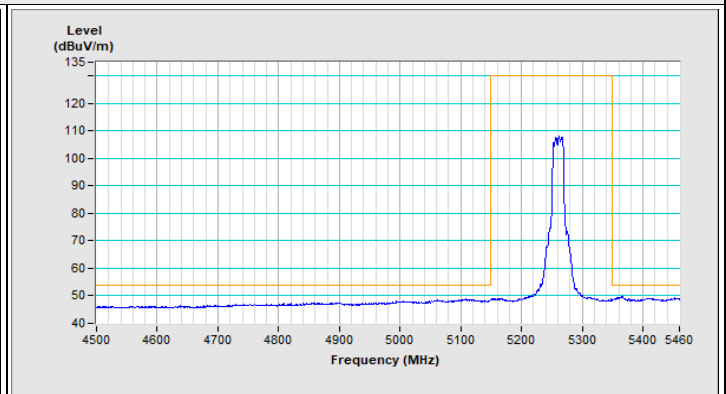

Horizontal (Average)

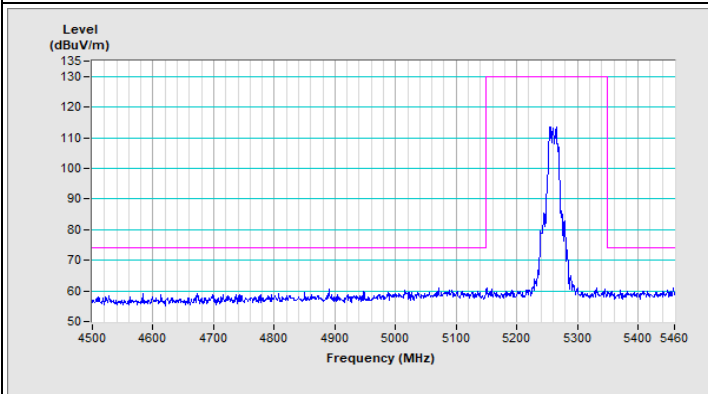

Vertical (Peak)

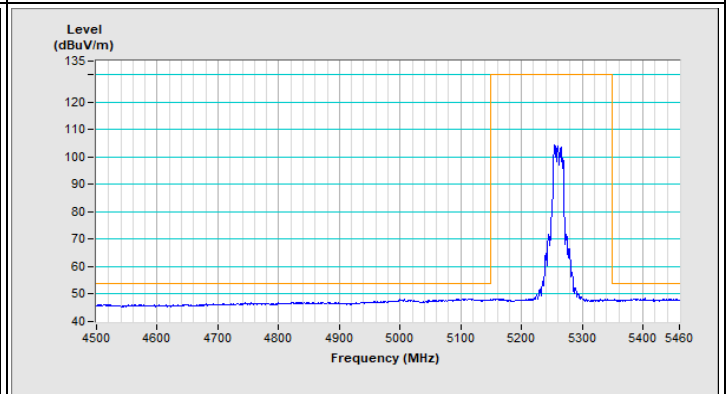

Vertical (Average)

### 802.11a Channel 64

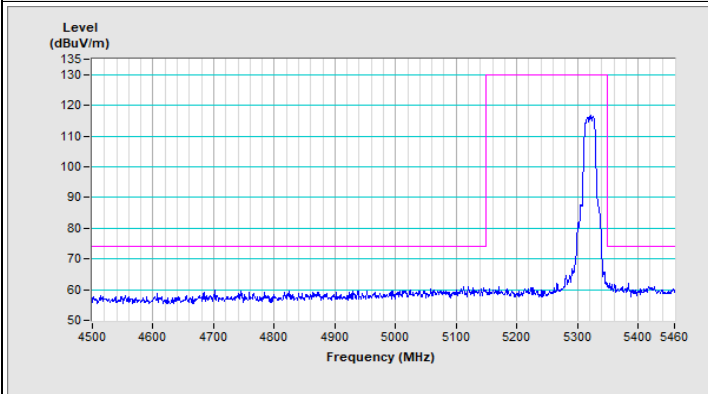

Horizontal (Peak)

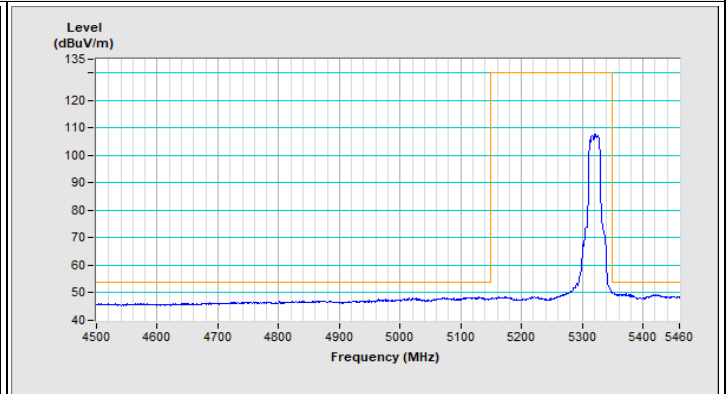

Horizontal (Average)

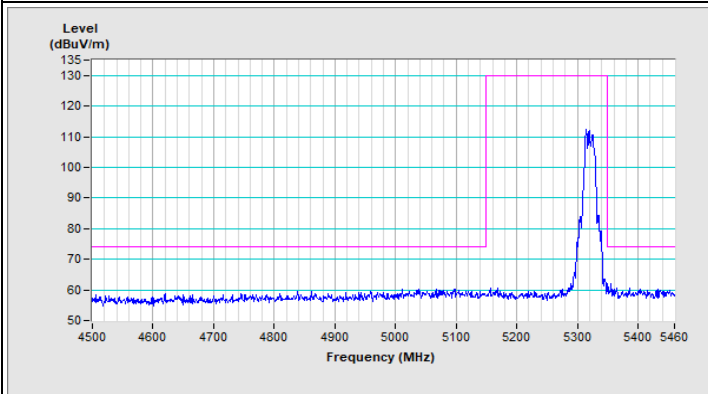

Vertical (Peak)

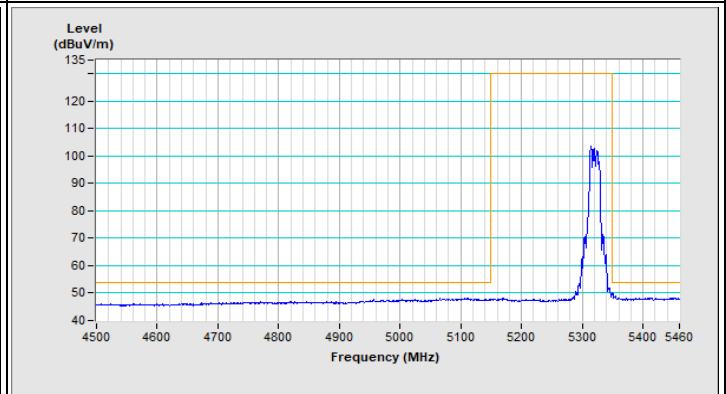

Vertical (Average)

### 802.11a Channel 100

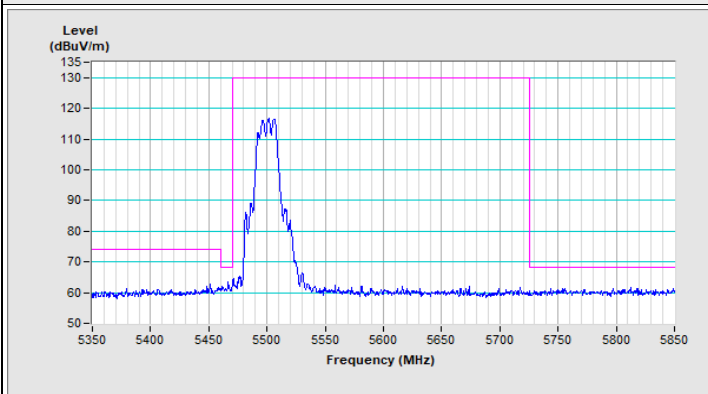

Horizontal (Peak)

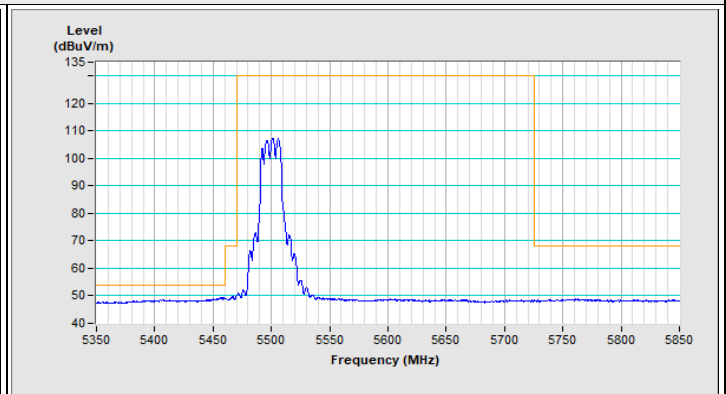

Horizontal (Average)

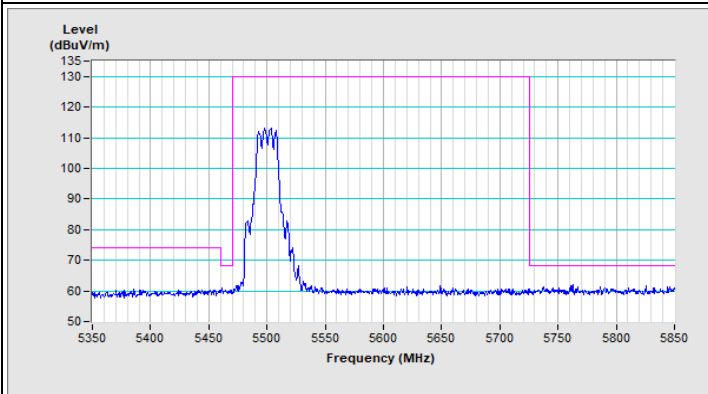

Vertical (Peak)

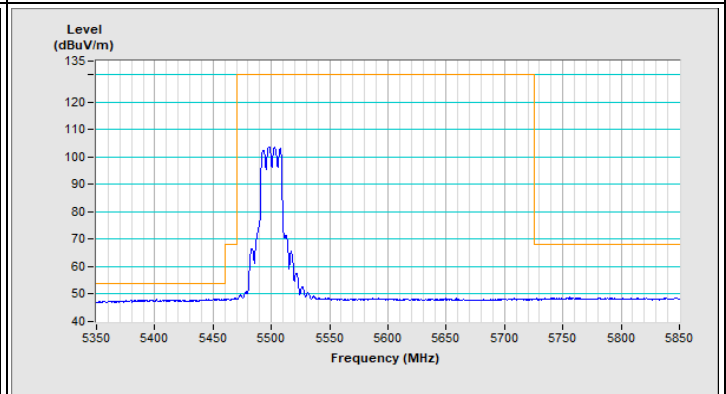

Vertical (Average)

### 802.11a Channel 140

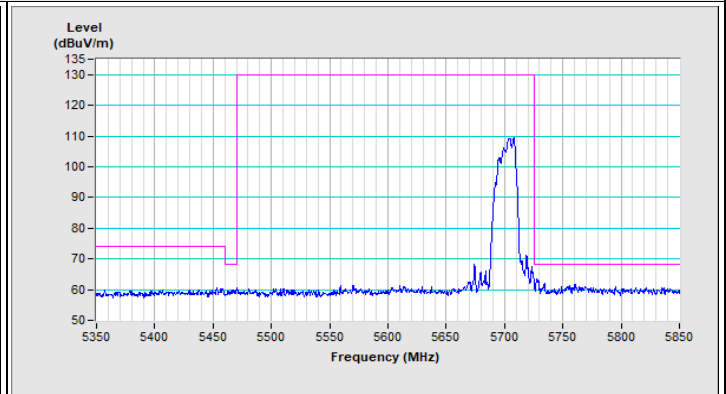
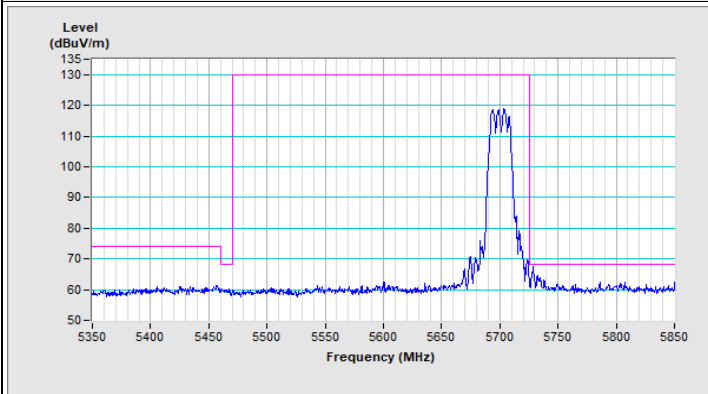

### 802.11a Channel 144

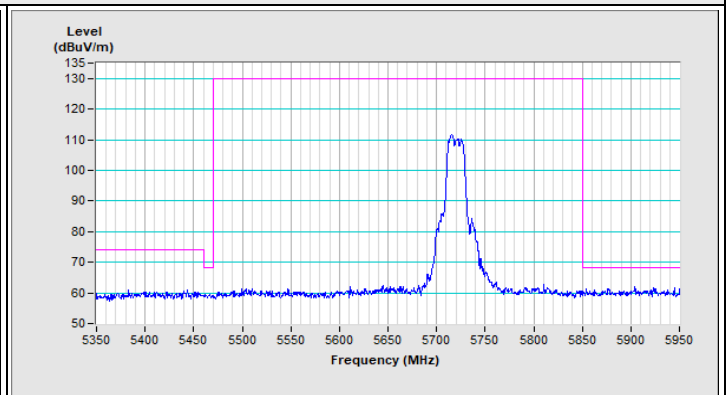
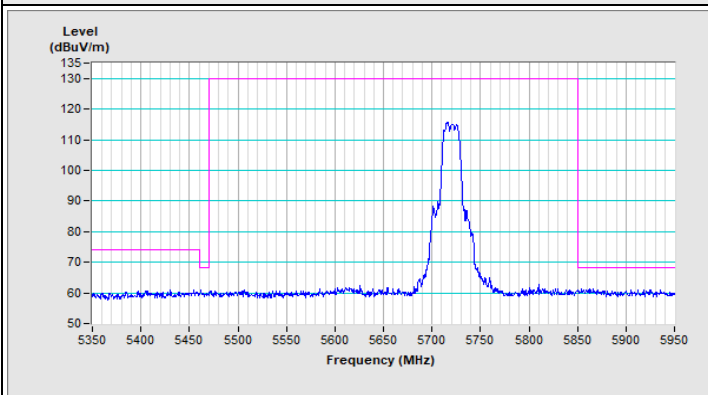

### 802.11a Channel 149

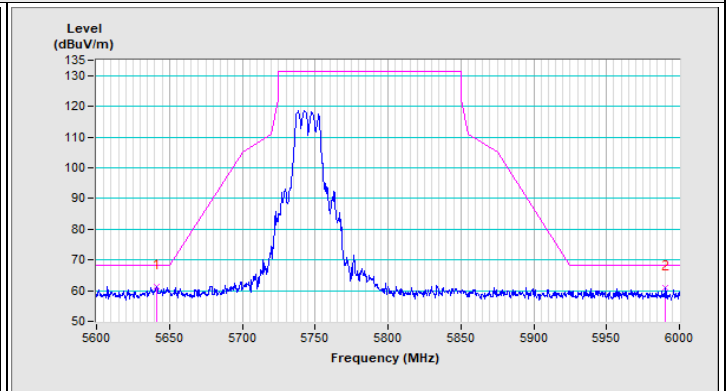
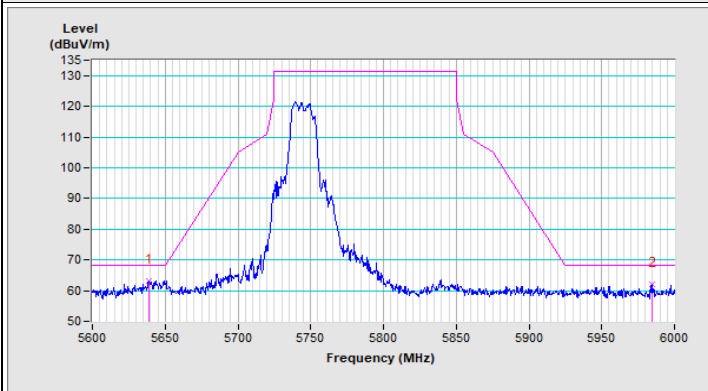



### 802.11a Channel 157

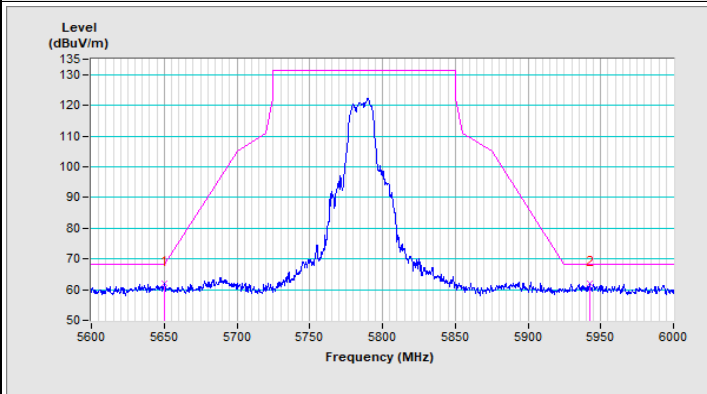

Horizontal (Peak)

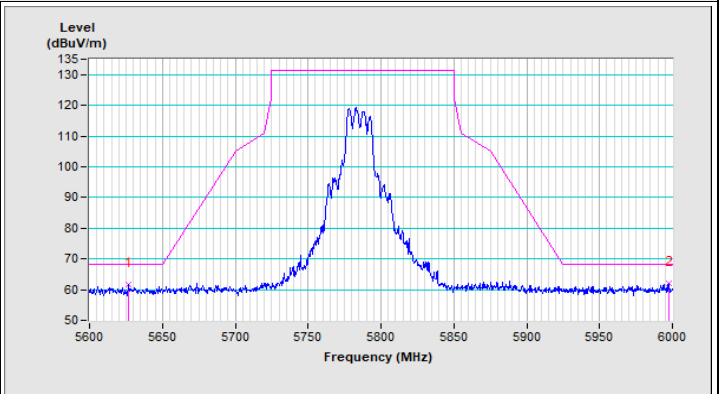

Vertical (Peak)

### 802.11a Channel 165

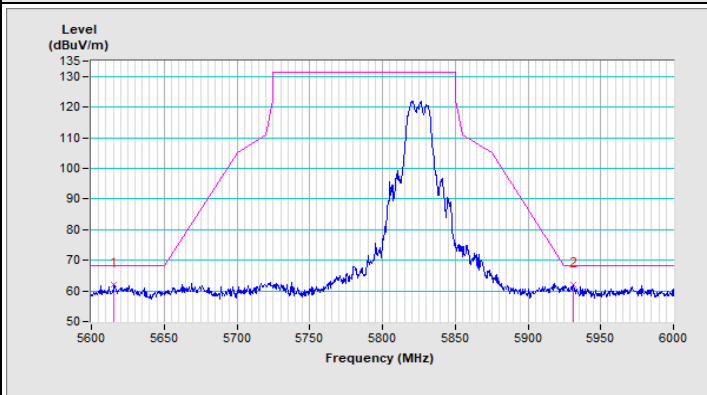

Horizontal (Peak)

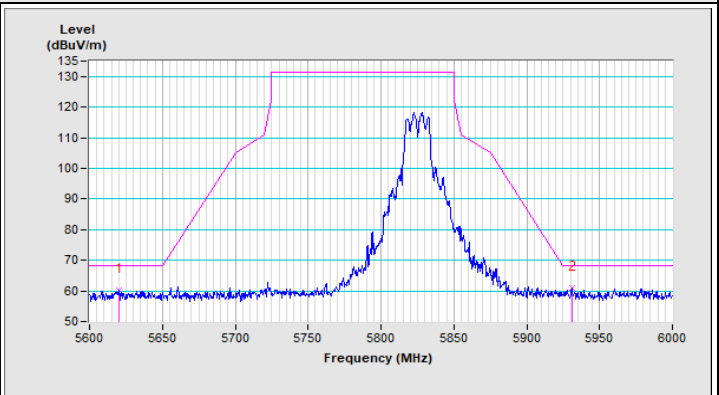

Vertical (Peak)

Frequency Range	4.5 GHz ~ 5.46 GHz	Detector Function & Bandwidth	Peak (PK), RB = 1 MHz, VB = 3 MHz Peak (AV), RB = 1 MHz, VB = 10 Hz
-----------------	--------------------	-------------------------------	--

802.11ax (HE20) Channel 36

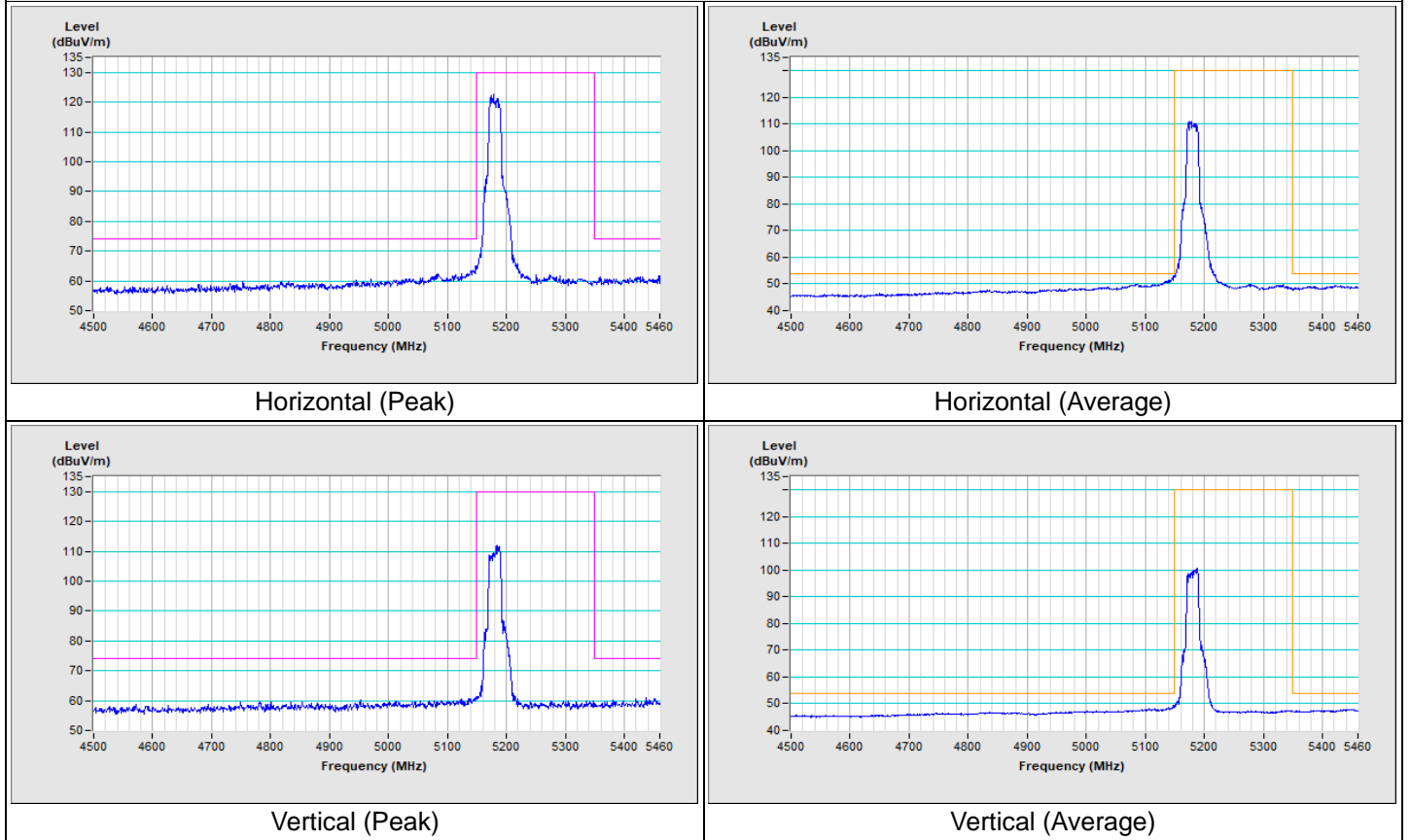

### 802.11ax (HE20) Channel 48

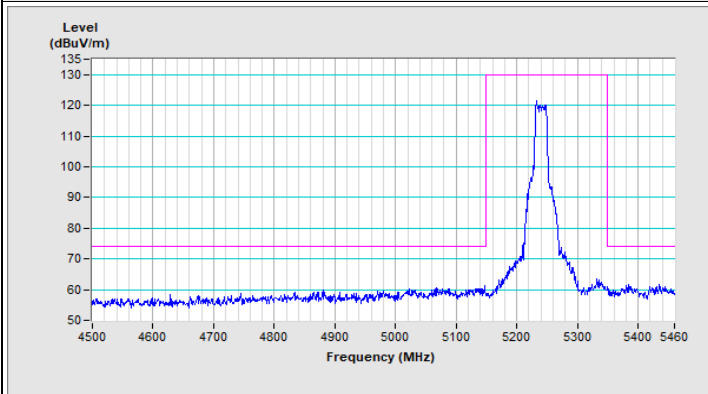

Horizontal (Peak)

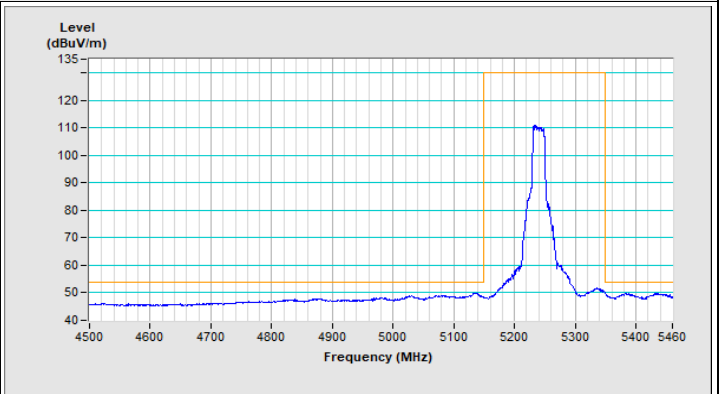

Horizontal (Average)

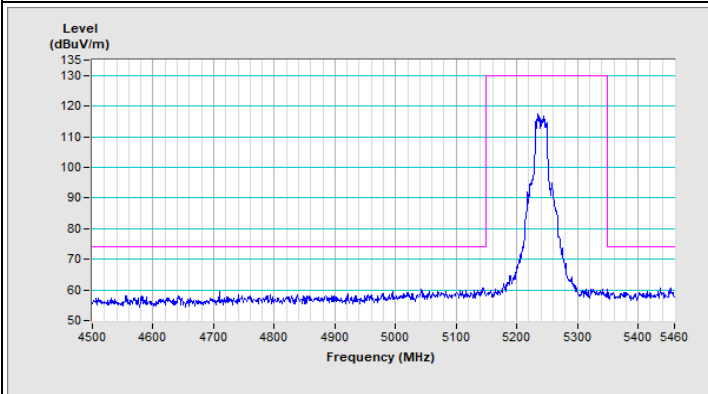

Vertical (Peak)

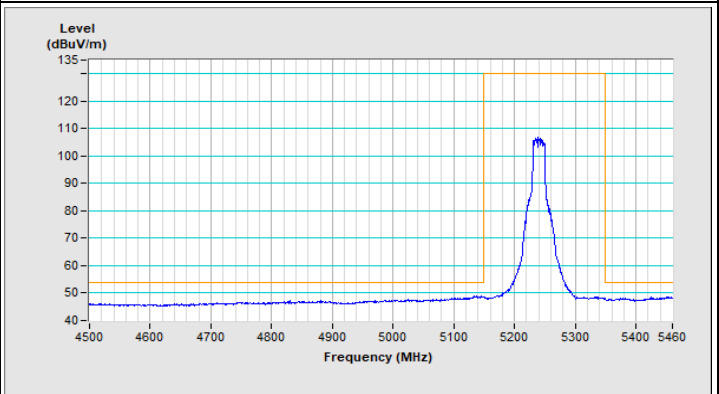

Vertical (Average)

### 802.11ax (HE20) Channel 52

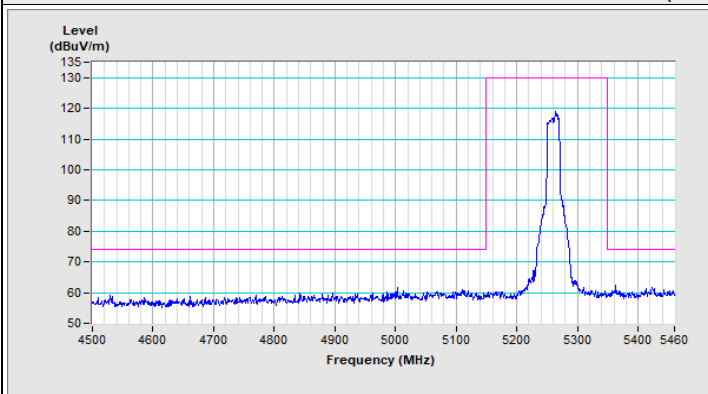

Horizontal (Peak)

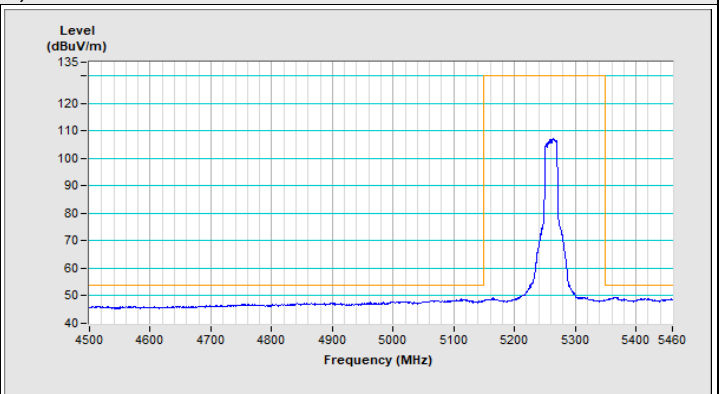

Horizontal (Average)

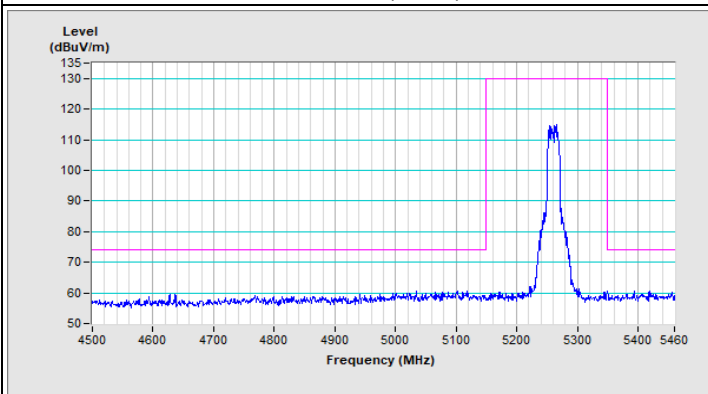

Vertical (Peak)

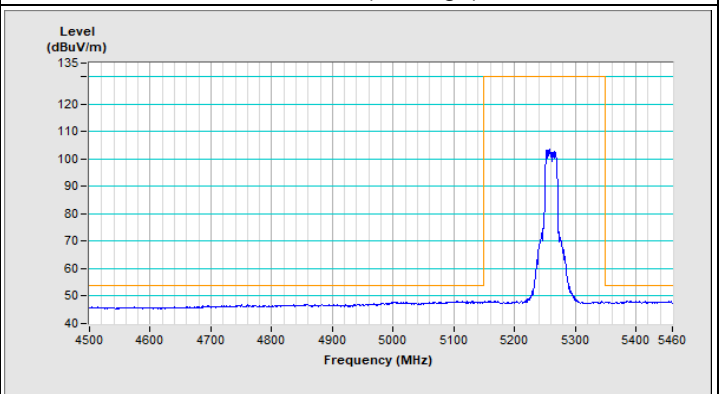

Vertical (Average)

### 802.11ax (HE20) Channel 64

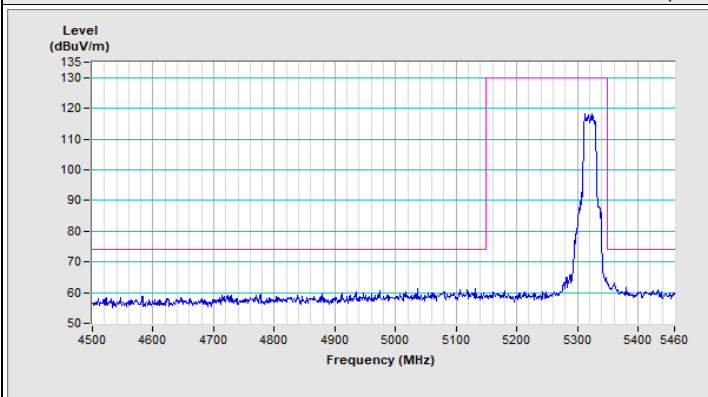

Horizontal (Peak)

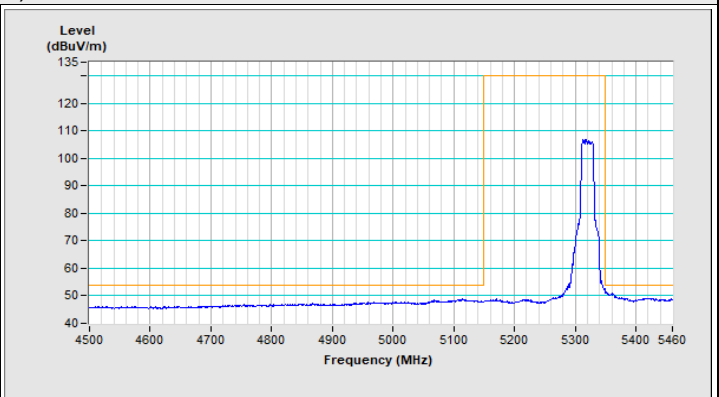

Horizontal (Average)

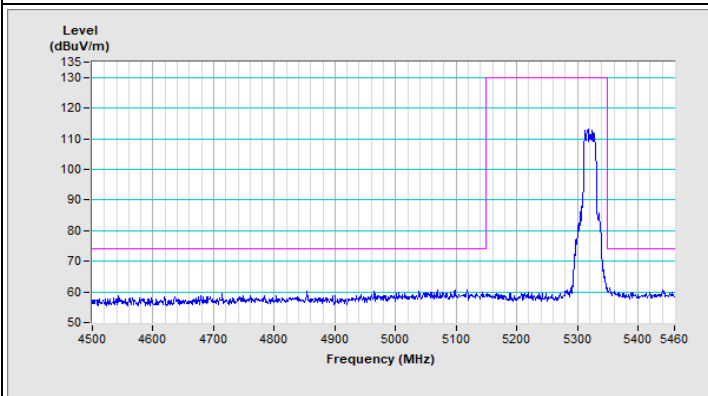

Vertical (Peak)

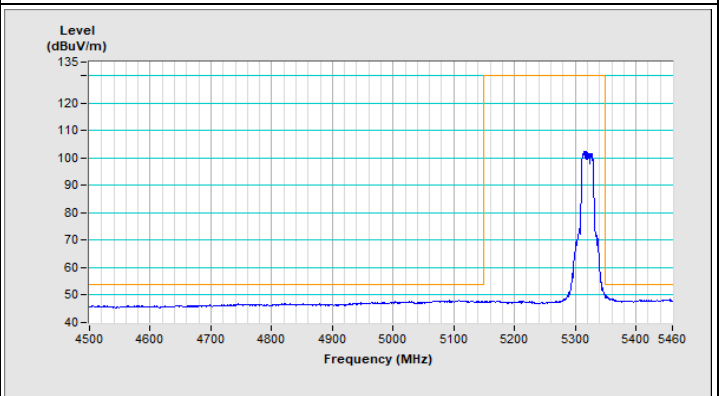

Vertical (Average)

### 802.11ax (HE20) Channel 100

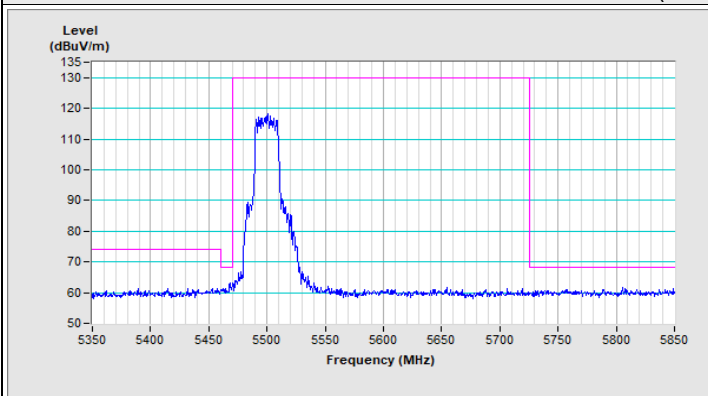

Horizontal (Peak)

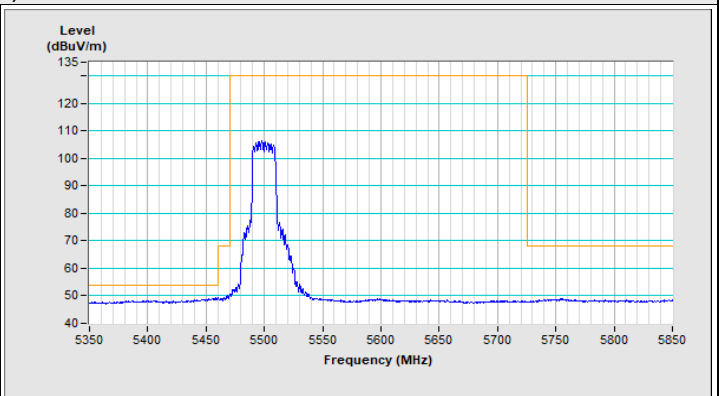

Horizontal (Average)

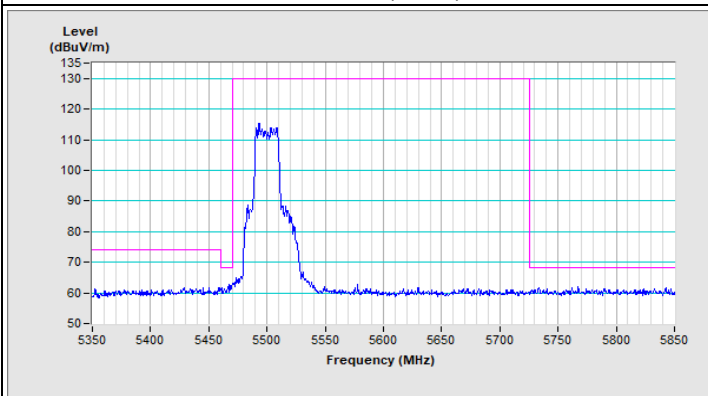

Vertical (Peak)

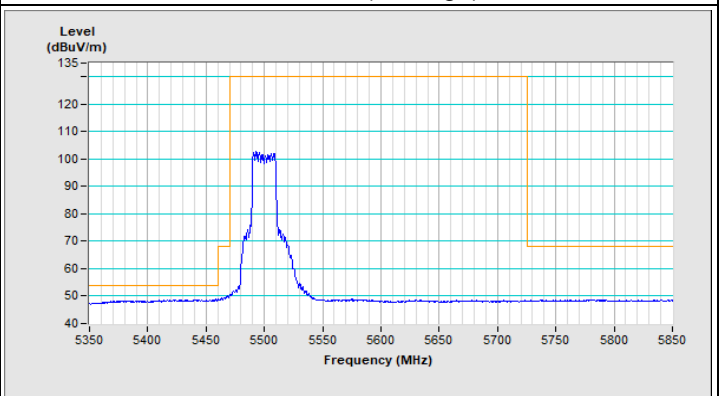

Vertical (Average)

### 802.11ax (HE20) Channel 140

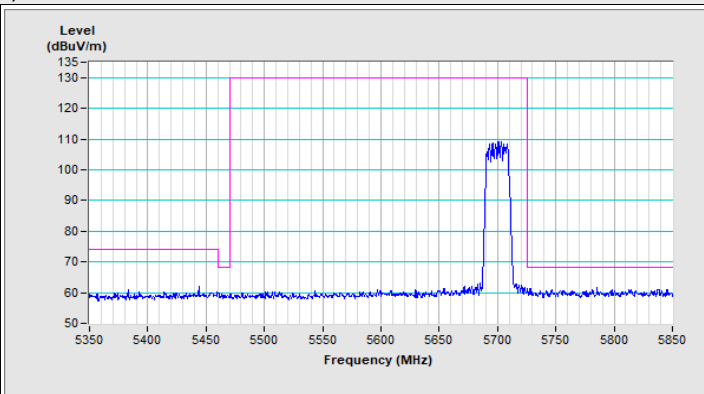
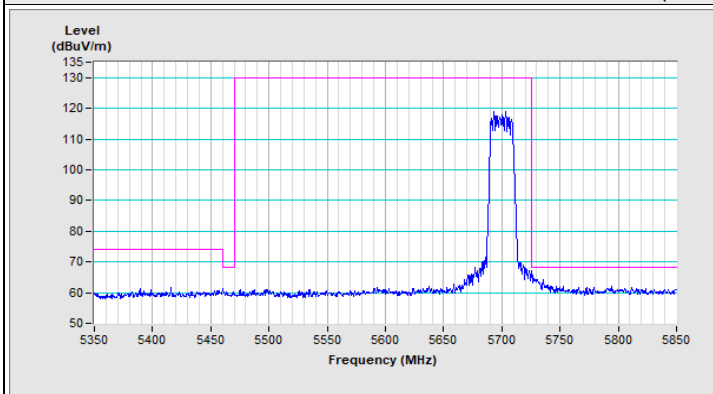

### 802.11ax (HE20) Channel 144

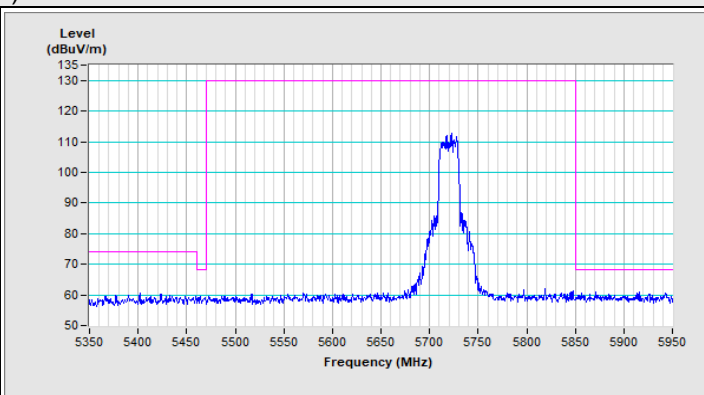
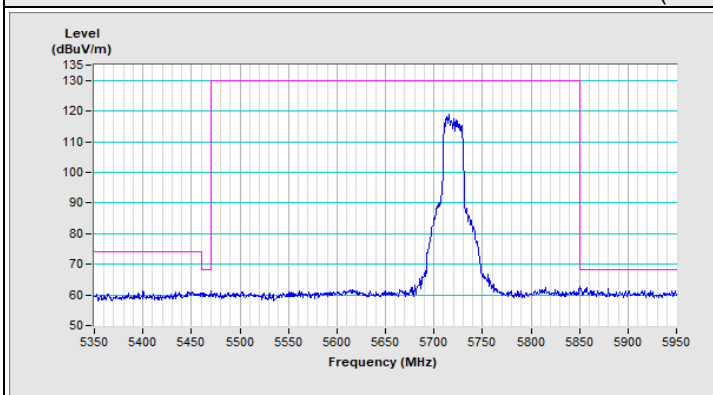

### 802.11ax (HE20) Channel 149

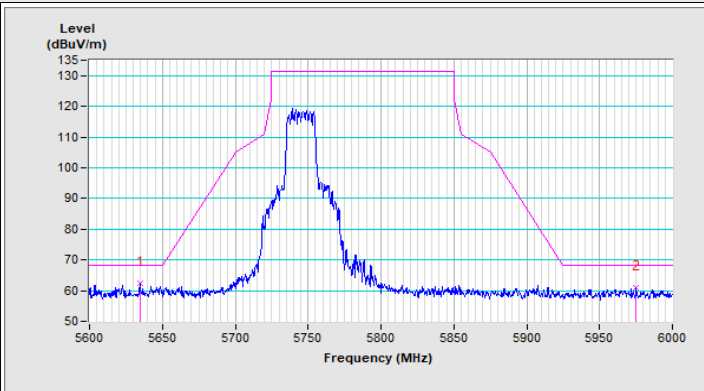
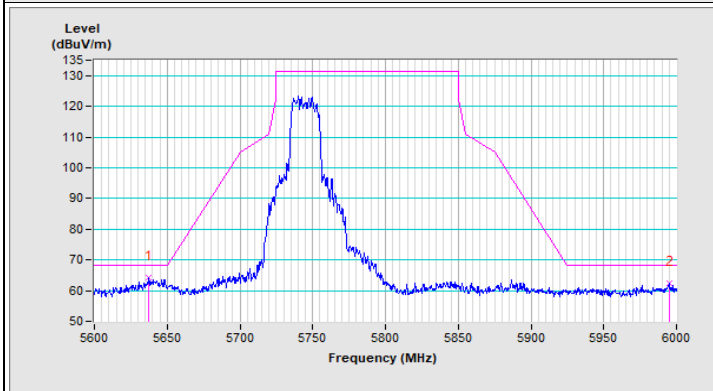

### 802.11ax (HE20) Channel 157

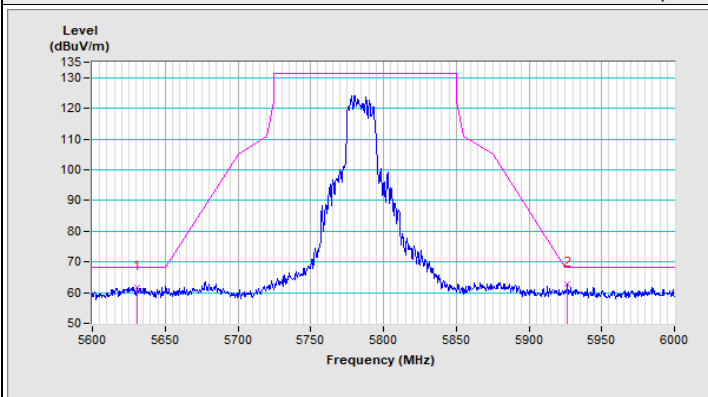

Horizontal (Peak)

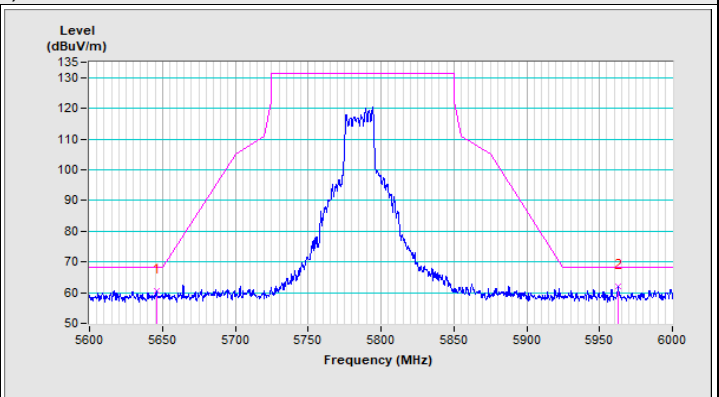

Vertical (Peak)

### 802.11ax (HE20) Channel 165

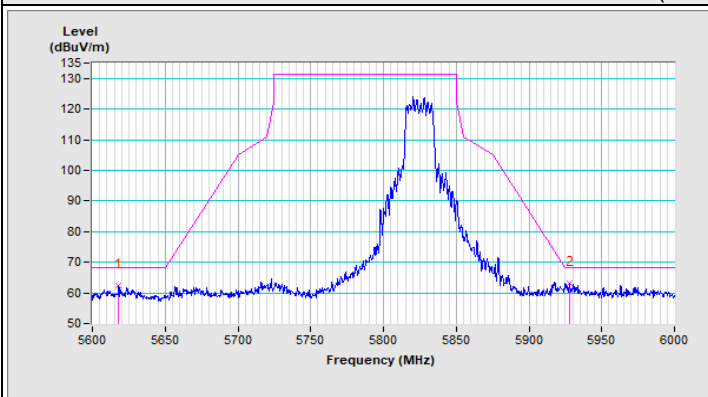

Horizontal (Peak)

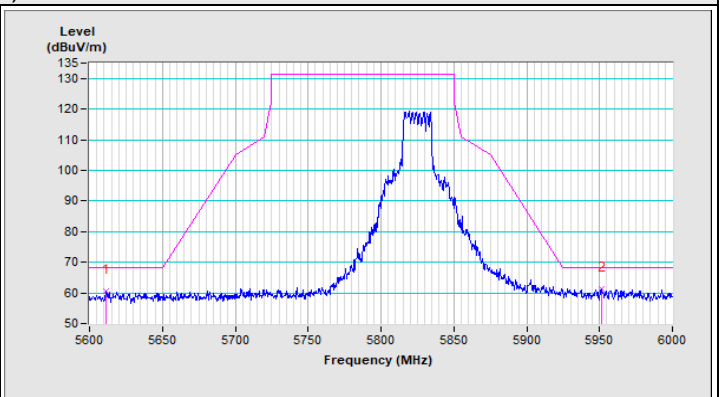

Vertical (Peak)

Frequency Range	4.5 GHz ~ 5.46 GHz	Detector Function & Bandwidth	Peak (PK), RB = 1 MHz, VB = 3 MHz Peak (AV), RB = 1 MHz, VB = 10 Hz
-----------------	--------------------	-------------------------------	--

802.11ax (HE40) Channel 38

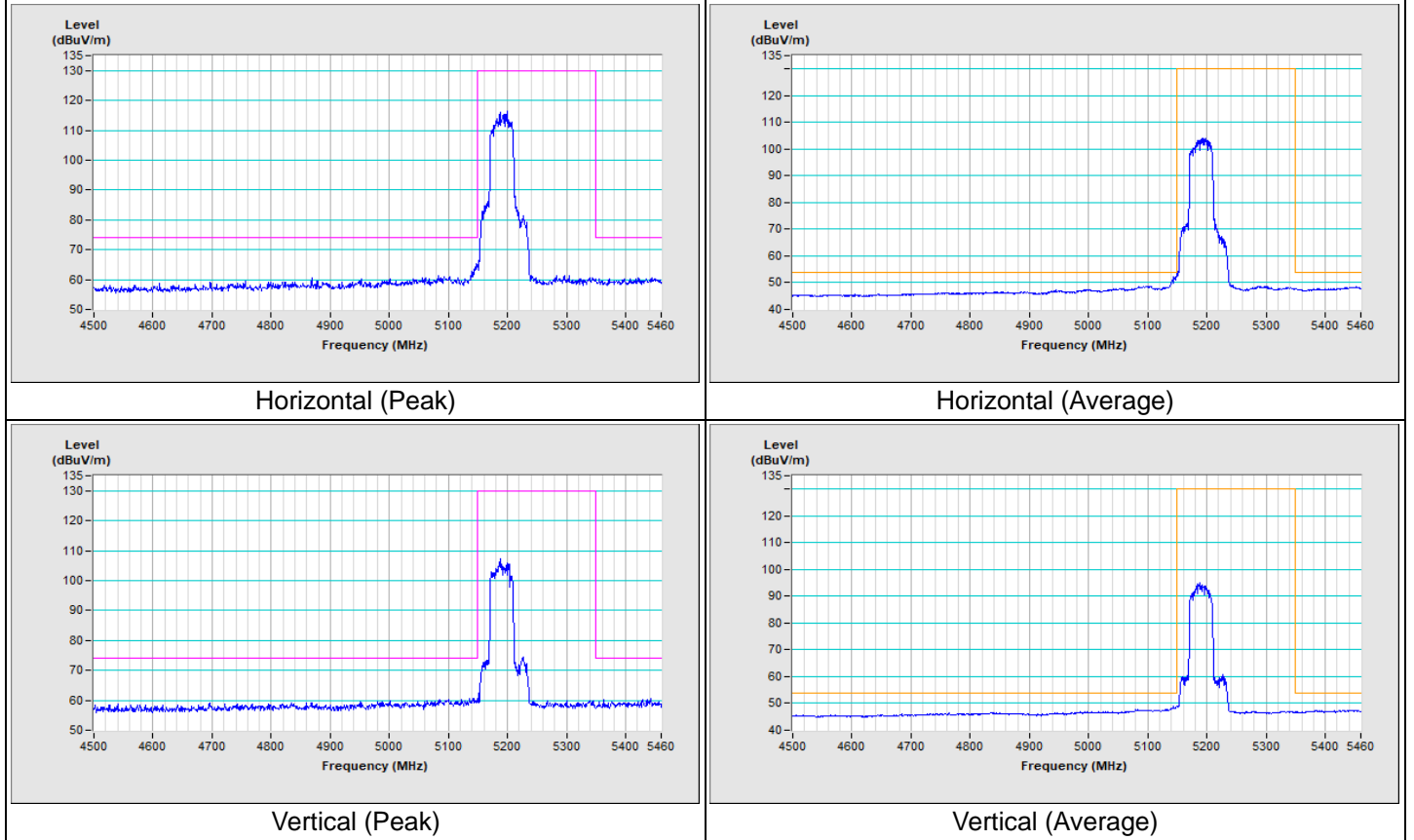

### 802.11ax (HE40) Channel 46

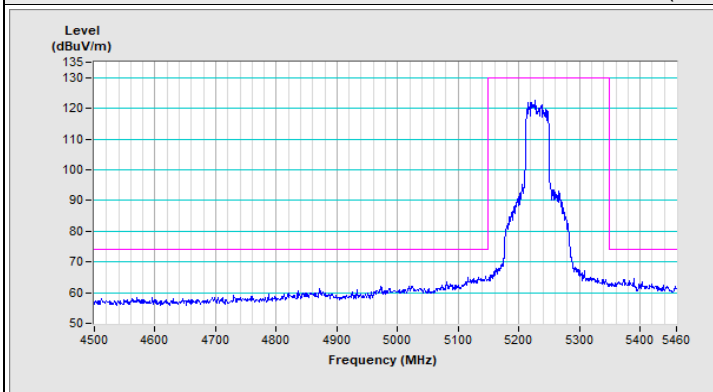

Horizontal (Peak)

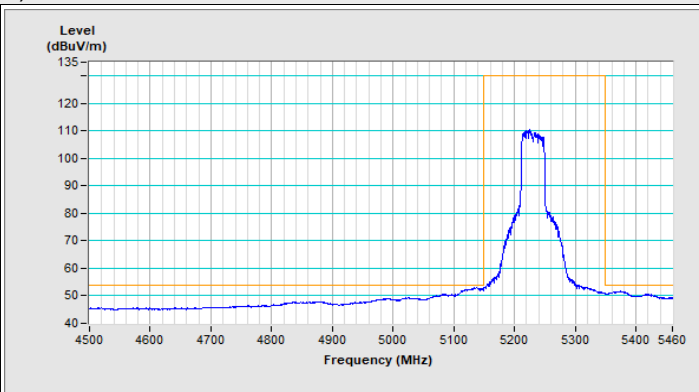

Horizontal (Average)

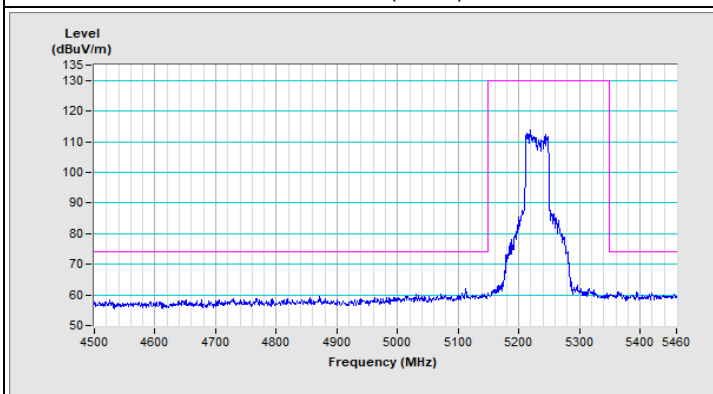

Vertical (Peak)

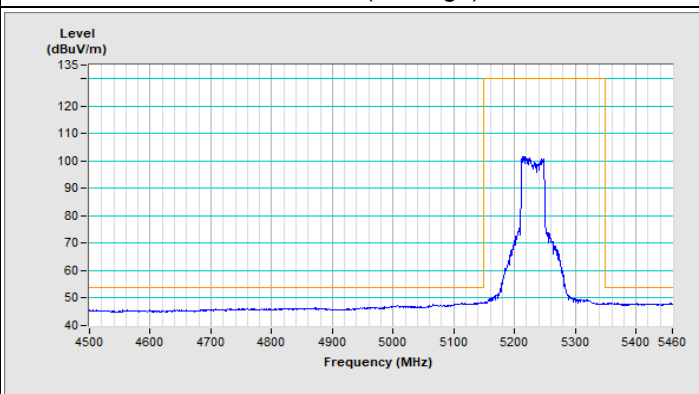

Vertical (Average)

### 802.11ax (HE40) Channel 54

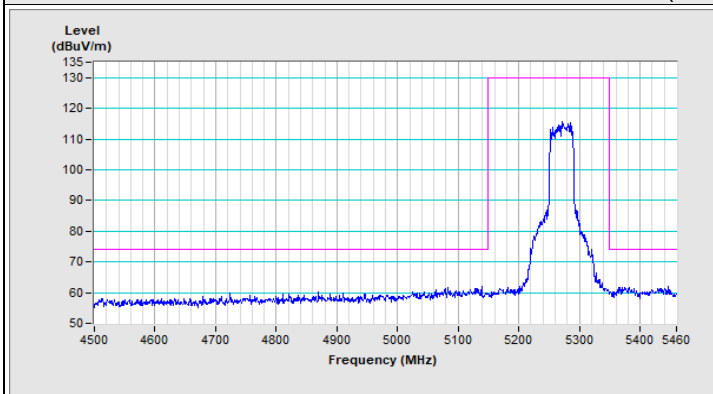

Horizontal (Peak)

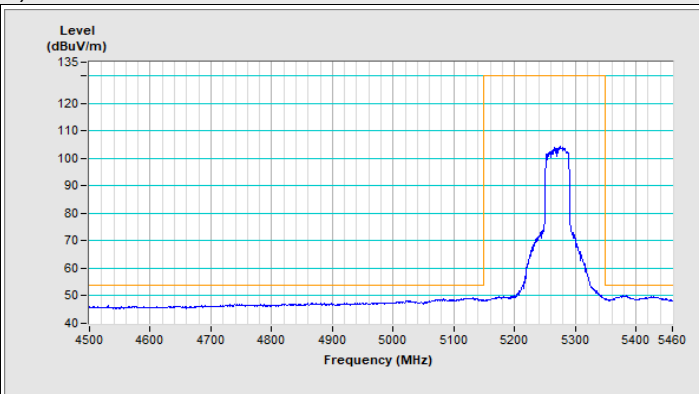

Horizontal (Average)

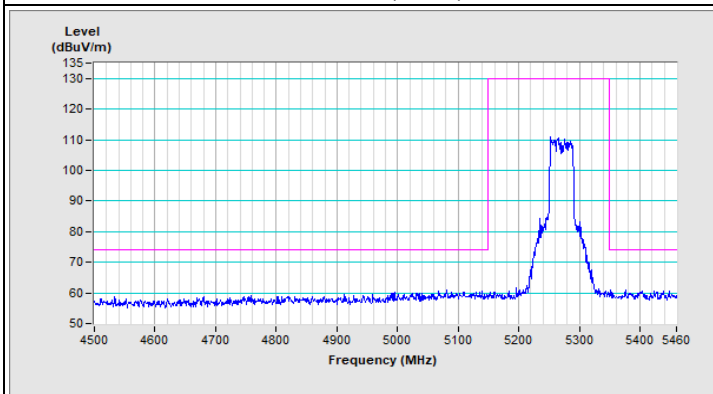

Vertical (Peak)

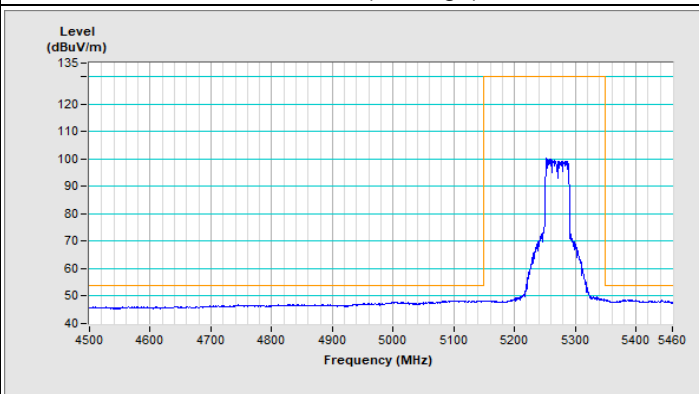

Vertical (Average)



### 802.11ax (HE40) Channel 62

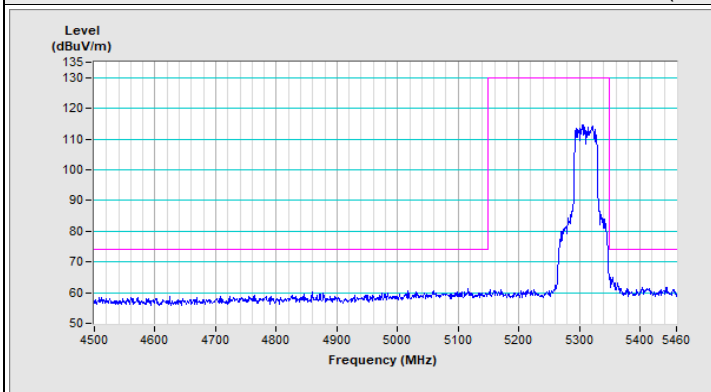

Horizontal (Peak)

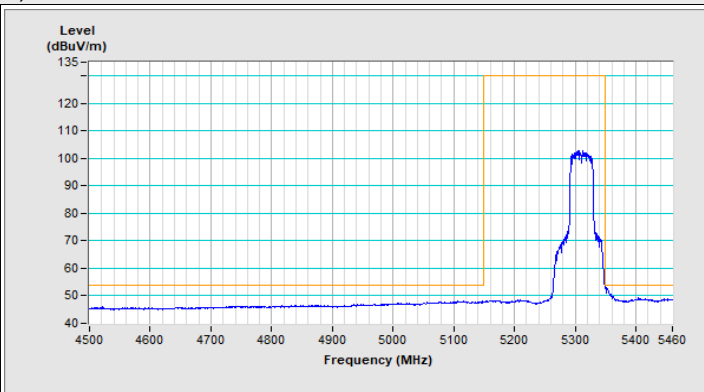

Horizontal (Average)

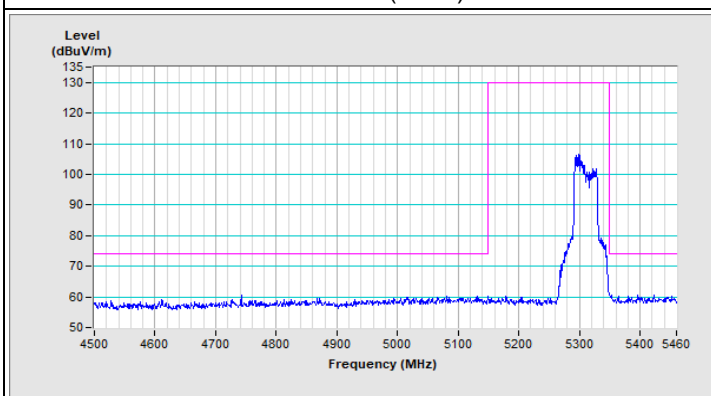

Vertical (Peak)

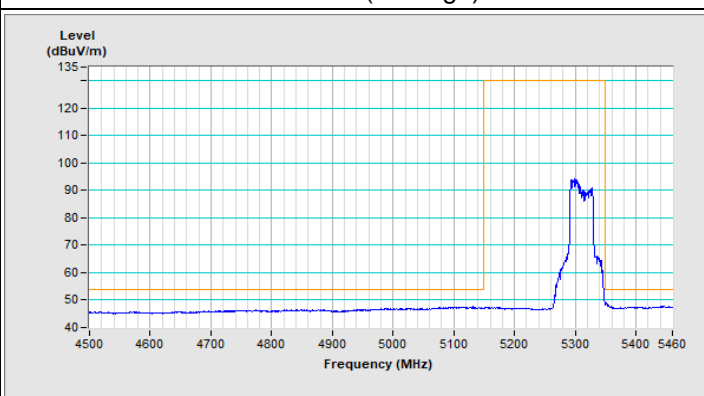

Vertical (Average)

### 802.11ax (HE40) Channel 102

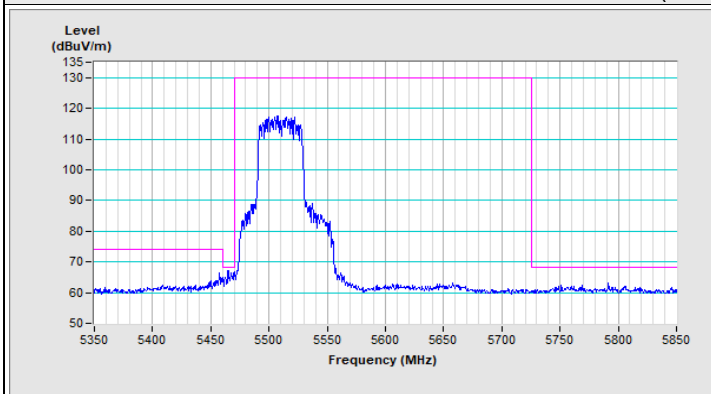

Horizontal (Peak)

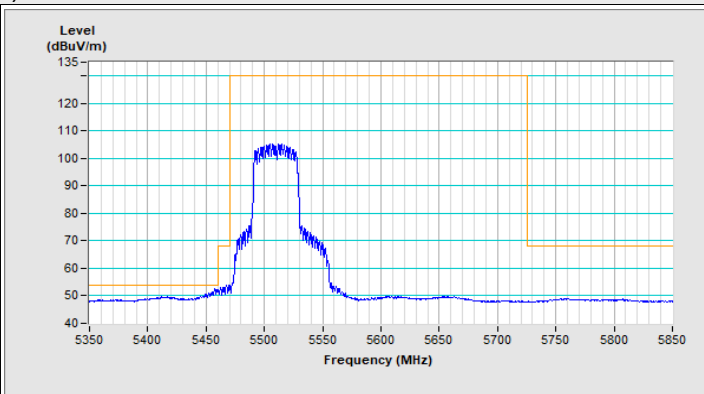

Horizontal (Average)

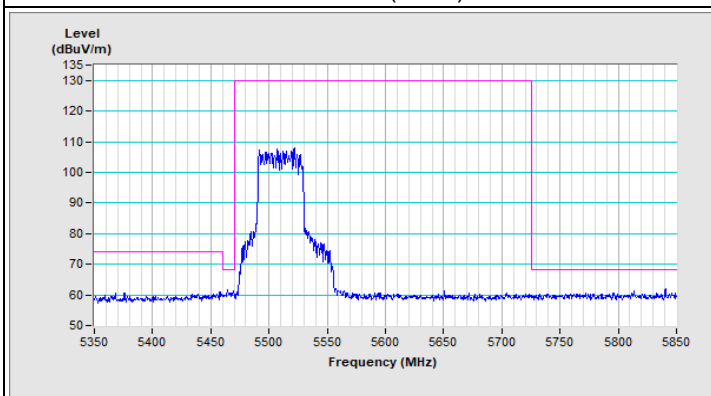

Vertical (Peak)

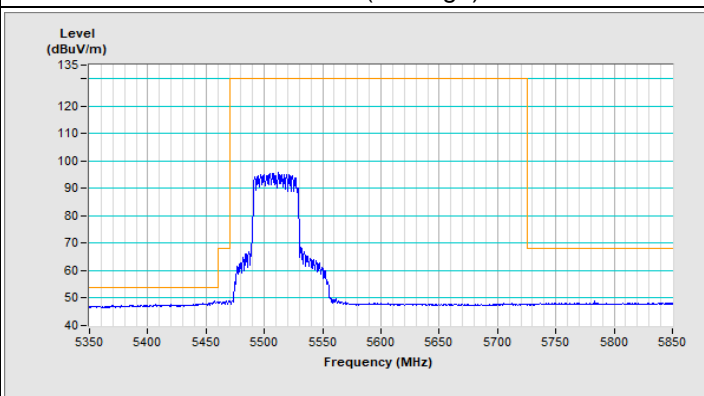

Vertical (Average)

### 802.11ax (HE40) Channel 134

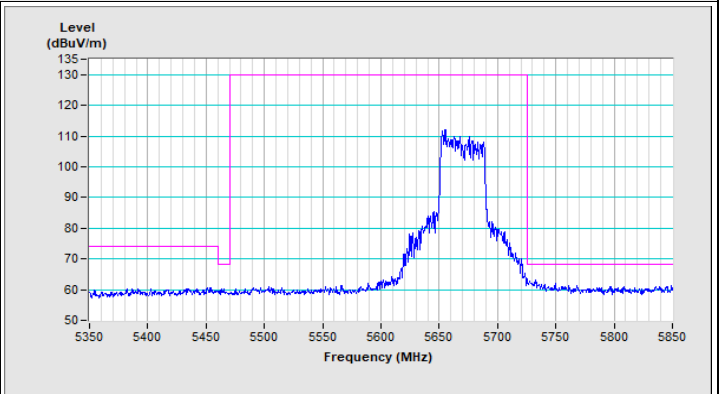
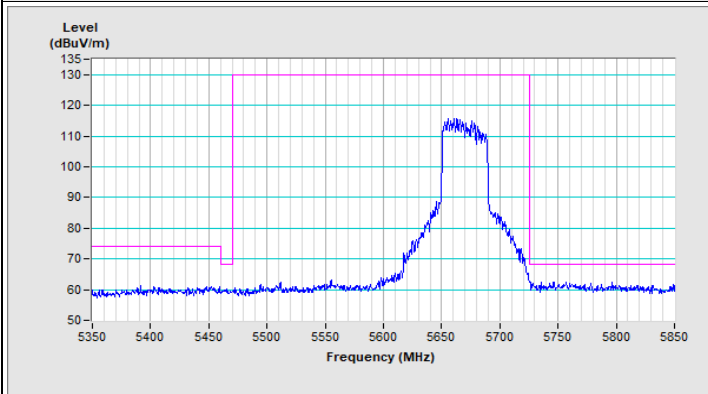

### 802.11ax (HE40) Channel 142

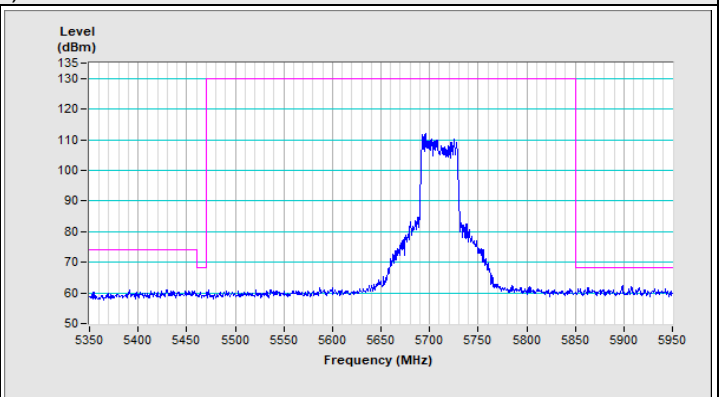
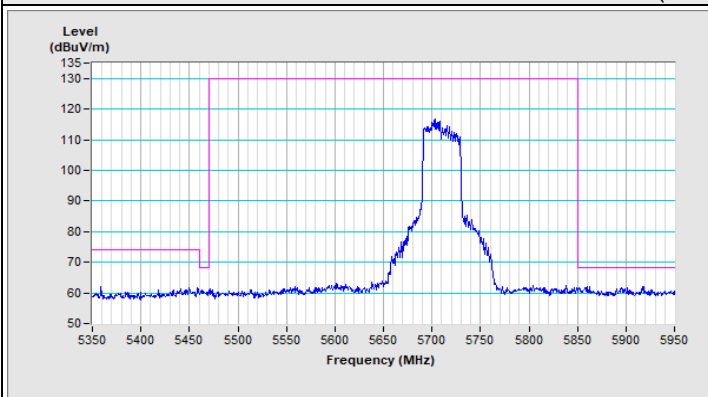

### 802.11ax (HE40) Channel 151

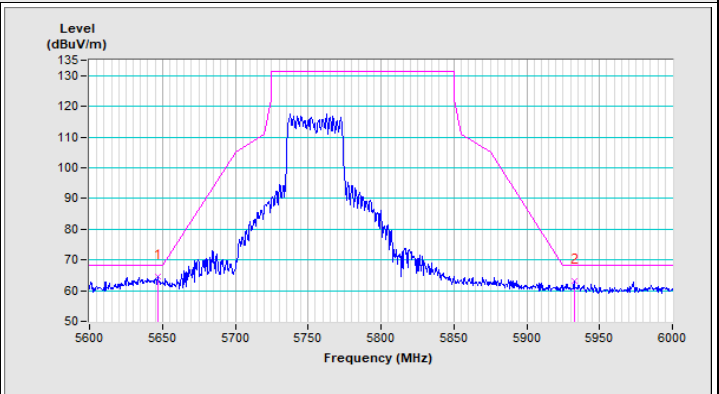
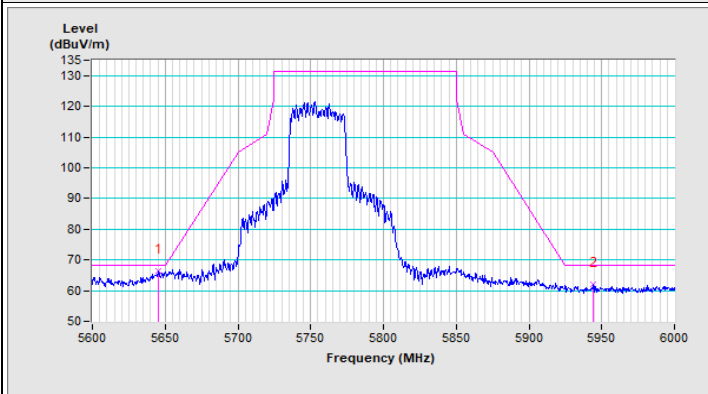

### 802.11ax (HE40) Channel 159

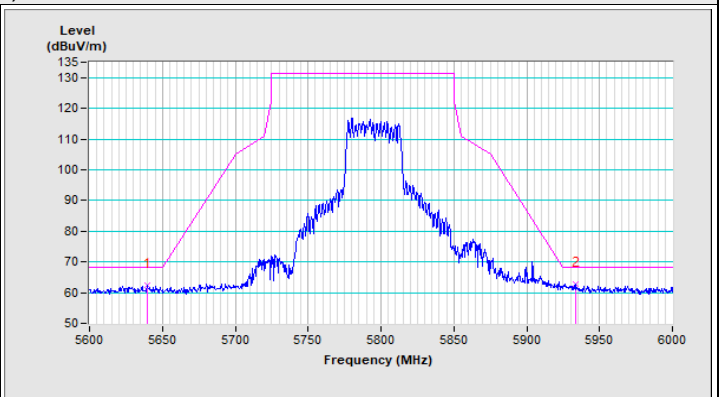
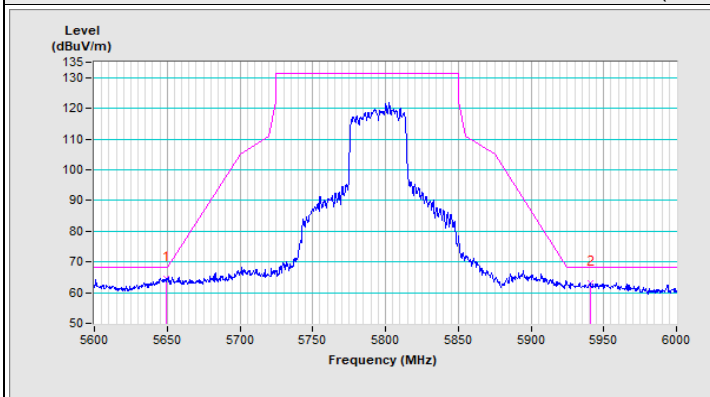

Frequency Range	4.5 GHz ~ 5.46 GHz	Detector Function & Bandwidth	Peak (PK), RB = 1 MHz, VB = 3 MHz Peak (AV), RB = 1 MHz, VB = 10 Hz
-----------------	--------------------	-------------------------------	--

802.11ax (HE80) Channel 42

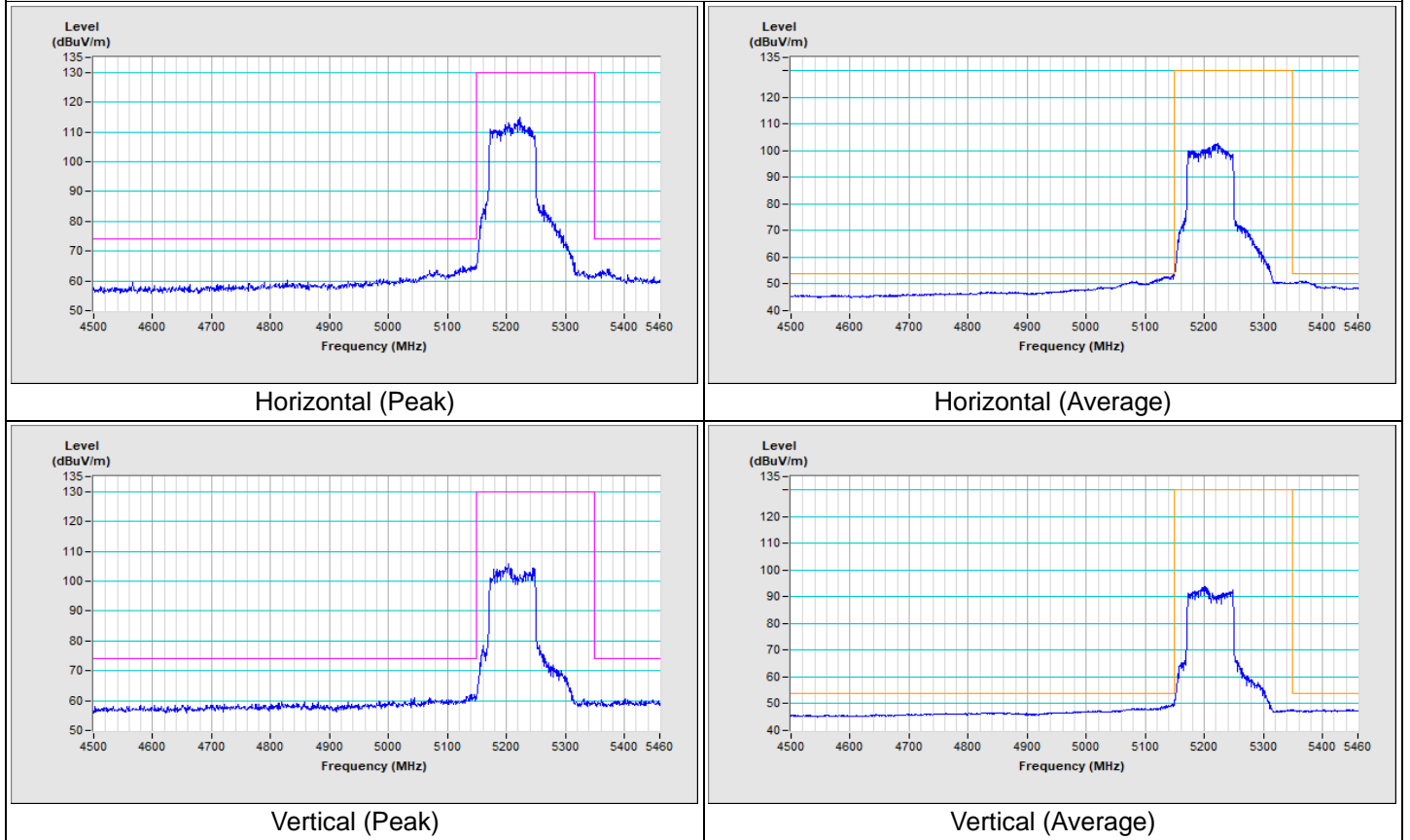

### 802.11ax (HE80) Channel 58

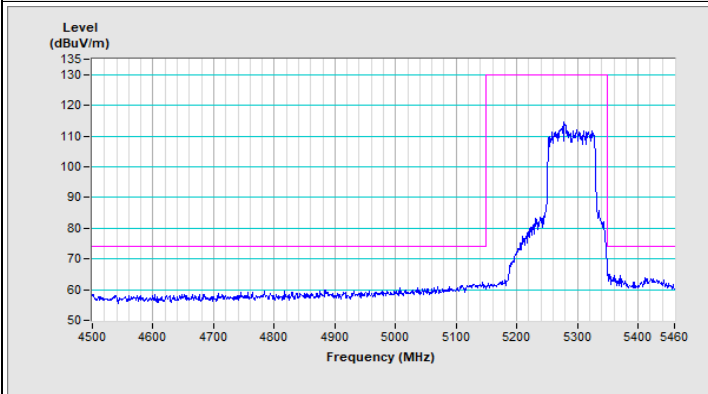

Horizontal (Peak)

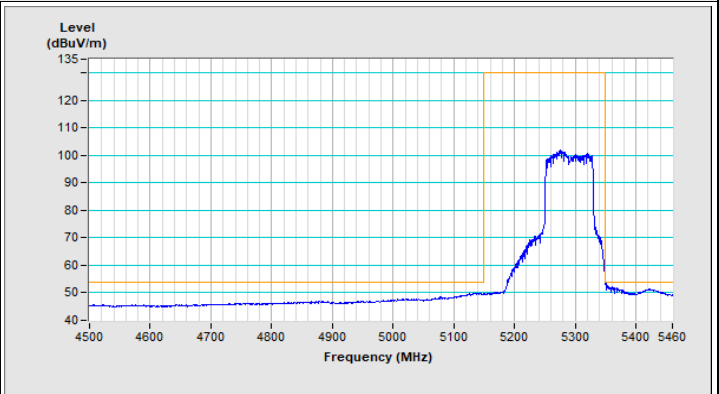

Horizontal (Average)

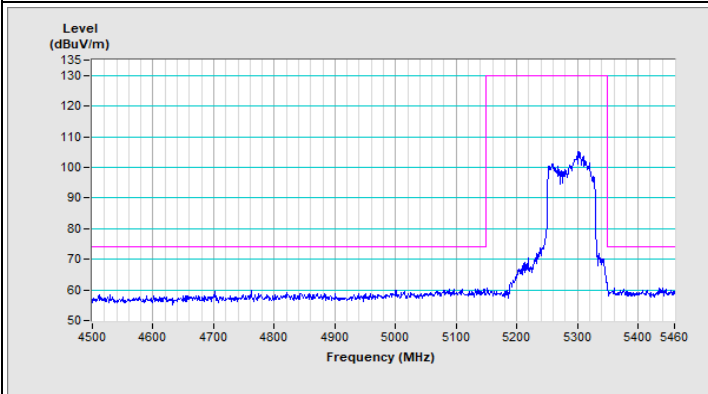

Vertical (Peak)

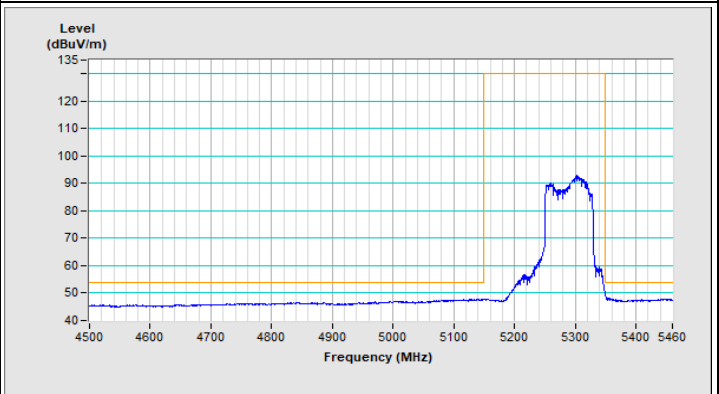

Vertical (Average)

### 802.11ax (HE80) Channel 106

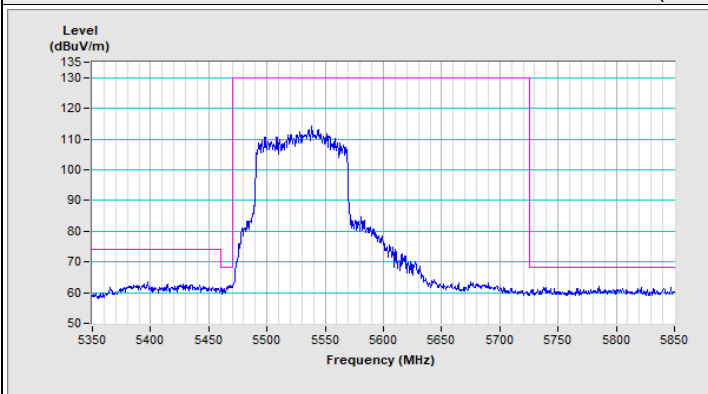

Horizontal (Peak)

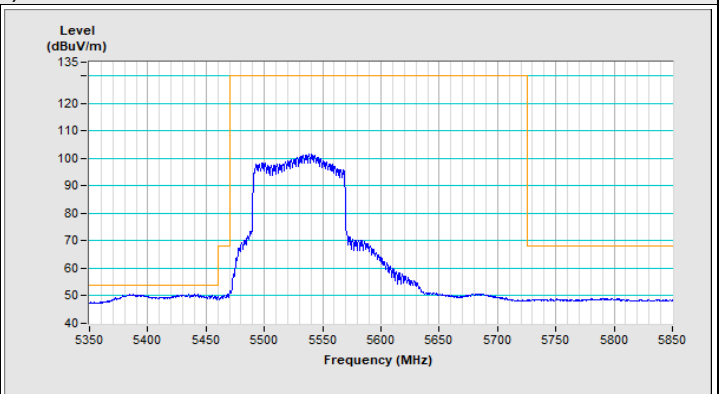

Horizontal (Average)

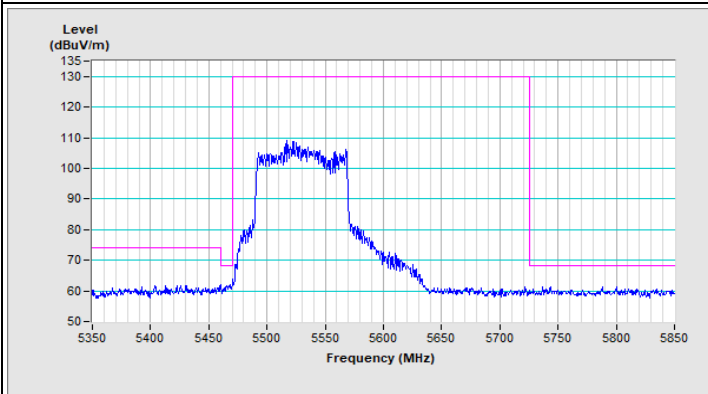

Vertical (Peak)

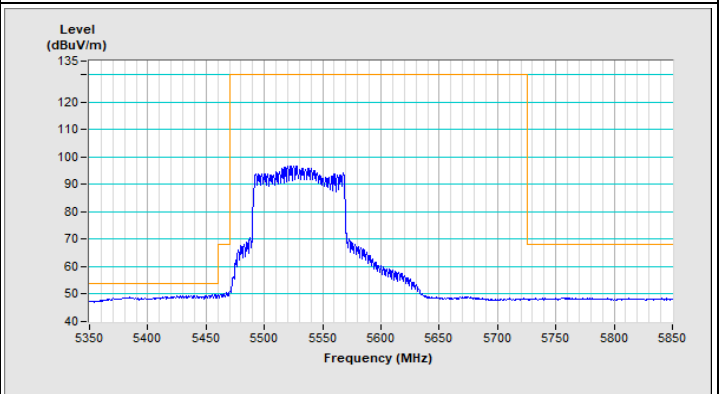

Vertical (Average)

### 802.11ax (HE80) Channel 122

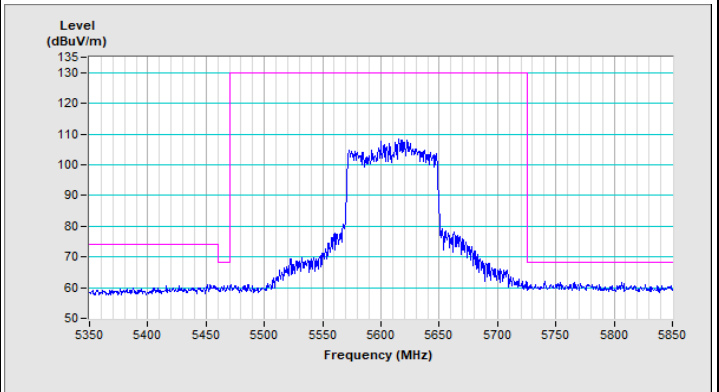
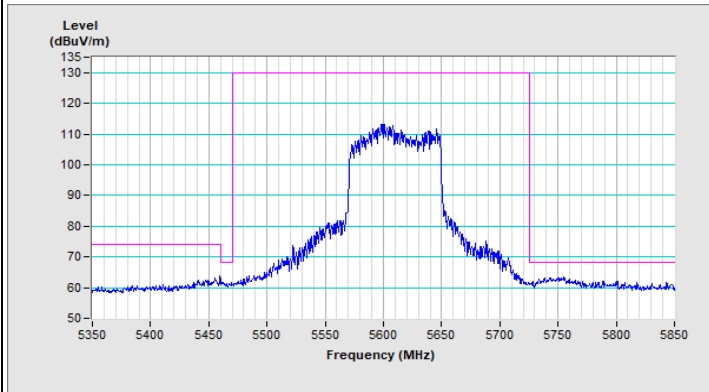

### 802.11ax (HE80) Channel 138

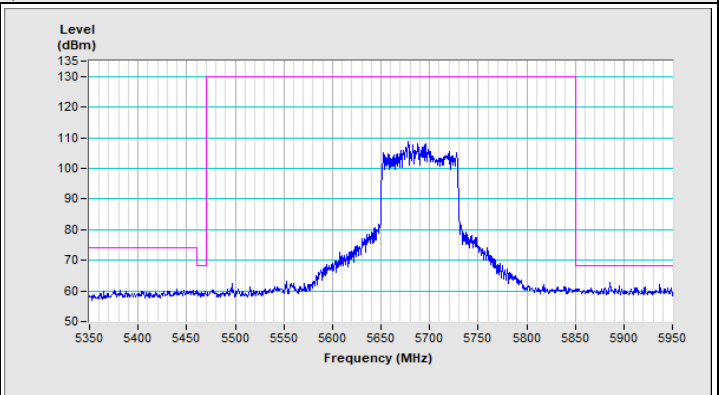
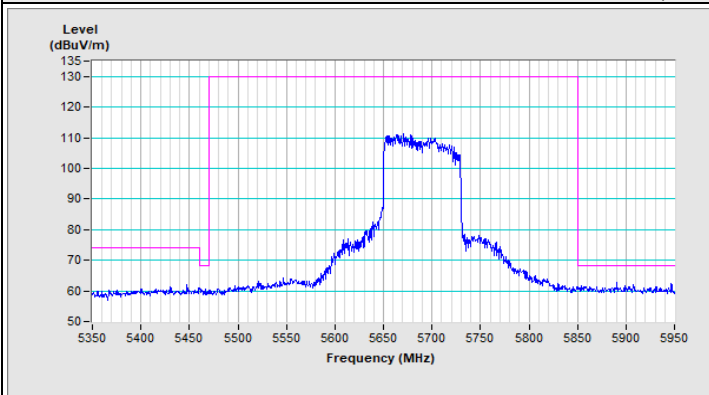

### 802.11ax (HE80) Channel 155

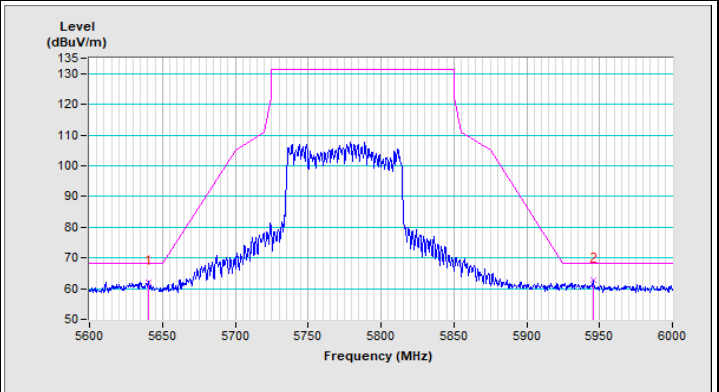
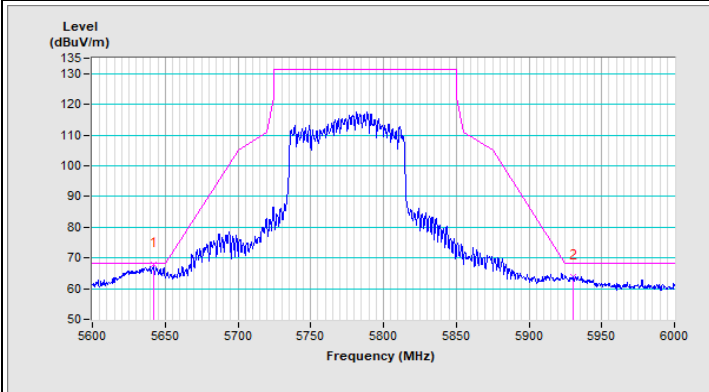

Frequency Range	4.5 GHz ~ 5.46 GHz	Detector Function & Bandwidth	Peak (PK), RB = 1 MHz, VB = 3 MHz Peak (AV), RB = 1 MHz, VB = 10 Hz
-----------------	--------------------	-------------------------------	--

802.11ax (HE160) Channel 50

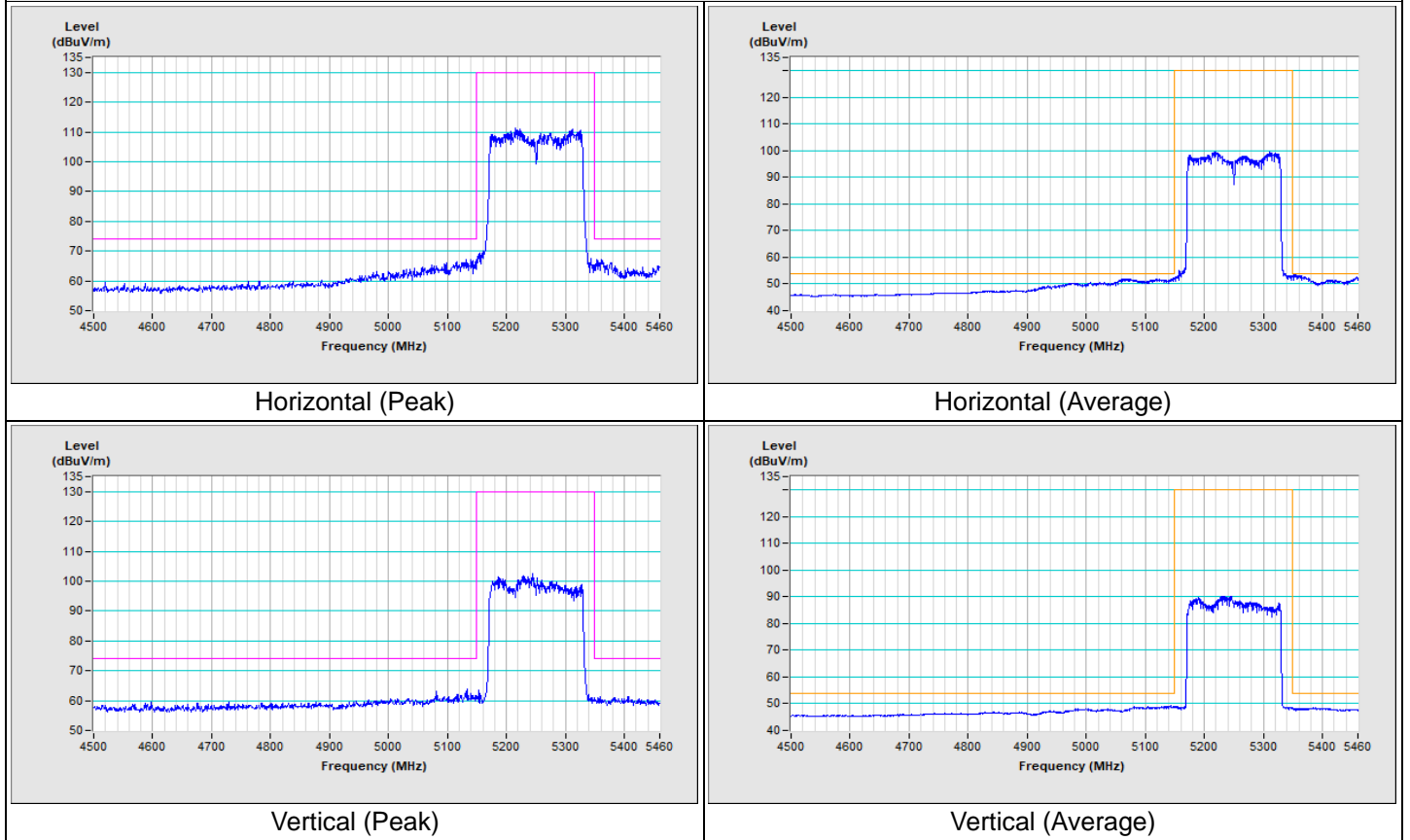

### 802.11ax (HE160) Channel 114

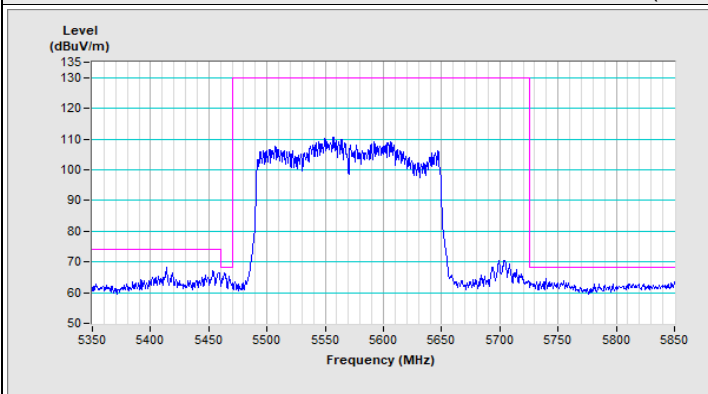

Horizontal (Peak)

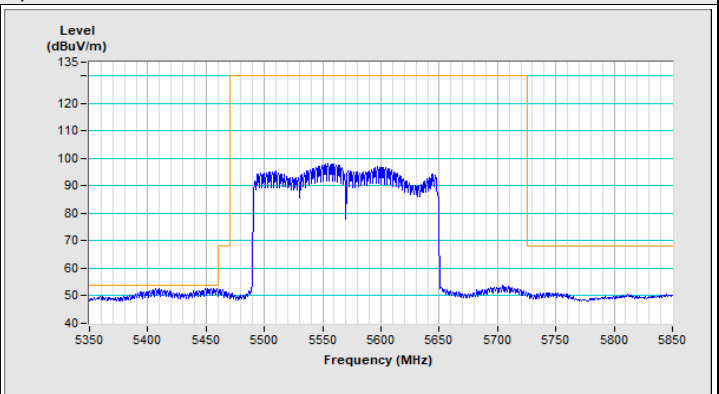

Horizontal (Average)

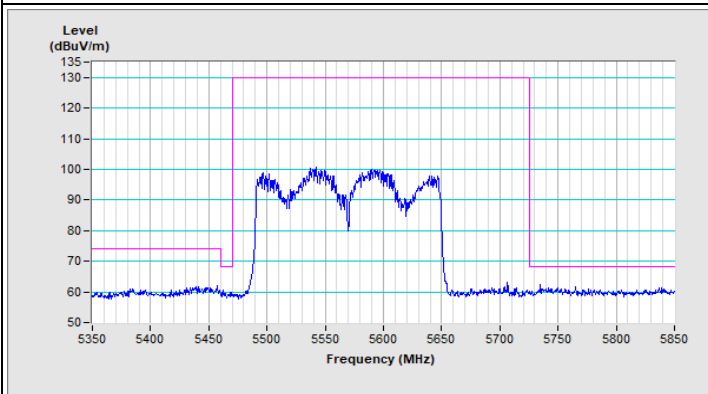

Vertical (Peak)

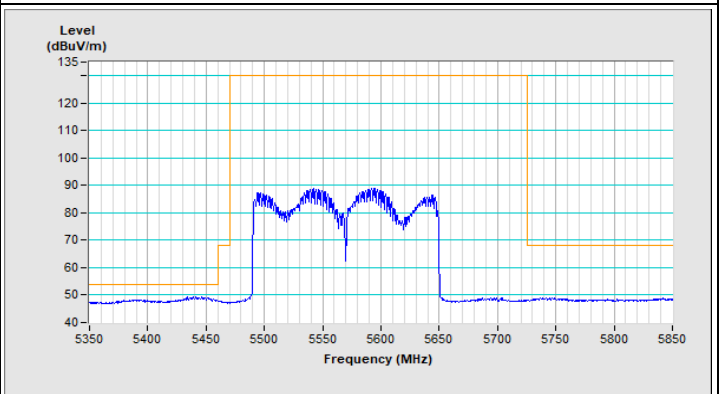

Vertical (Average)



## 8 Pictures of Test Arrangements

Please refer to the attached file (Test Setup Photo)

## 9 Information of the Testing Laboratories

We, Bureau Veritas Consumer Products Services (H.K.) Ltd., Taoyuan Branch, were founded in 1988 to provide our best service in EMC, Radio, Telecom and Safety consultation. Our laboratories are FCC recognized accredited test firms and accredited according to ISO/IEC 17025.

If you have any comments, please feel free to contact us at the following:

**Lin Kou EMC/RF Lab**

Tel: 886-2-26052180

Fax: 886-2-26051924

**Hsin Chu EMC/RF/Telecom Lab**

Tel: 886-3-6668565

Fax: 886-3-6668323

**Hwa Ya EMC/RF/Safety Lab**

Tel: 886-3-3183232

Fax: 886-3-3270892

**Email:** [service.adt@bureauveritas.com](mailto:service.adt@bureauveritas.com)

**Web Site:** <http://ee.bureauveritas.com.tw>

The address and road map of all our labs can be found in our web site also.

--- END ---