



WHA YU INDUSTRIAL CO., LTD.(HEAD OFFICE)

DONGGUAN AEON TECH CO.,LTD.(CHINA)

SPECIFICATION FOR APPROVAL

CUSTOMER: *ASUS*



PART NAME: *RF Antenna Assembly*

PART NO.:

REVISION:

W. Y. P/NO.: *C660-510613-A(SRF2023779)*

REV.: *X2*

	MANUFACTURER SIGNATURE	CUSTOMER SIGNATURE
APPROVED BY :	<i>Stone</i> 	
DATE :	<i>5/25</i>	

WHA YU GROUP

WHA YU INDUSTRIAL CO., LTD.(HEAD OFFICE)

譚裕實業股份有限公司

Address: No. 326, Sec. 2, Kung Tao 5 Road, Hsin Chu City, Taiwan, R.O.C.

Tel:+886-3-5714225(REP.) Fax:+ 886-3-5713853 · + 886-3-5723600

DONGGUAN AEON TECH CO.,LTD.(CHINA)

東莞台霖電子通訊有限公司

Address:Hupan Industrial District,Tai Ling Shan Town,Dong Guan City,Guangdong,China

Tel:+86-769-85655858 Fax:+86-769-85655258

Contents

<i>Item</i>	<i>Description</i>	<i>Page</i>
1.	規格表 1
2.	成品圖 2
3.	測試報告 3~20

RF Antenna Assembly

Specification

1. Electrical Properties With housing/With Cable loss(ANT2)

- 1.1 Frequency Range.....2.412 ~ 2.472 , 5.15~5.85 GHz
- 1.2 Impedance50Ω Nominal
- 1.3 VSWR 1.92 : 1 Max.
- 1.4 Return Loss..... 10 dB Min.
- 1.5 Radiation Omni-directional
- 1.6 2D Peak Gain.....
 - 2.45GHz 3.33dBi
 - 5.2GHz 2.12dBi
 - 5.3GHz 2.96dBi
 - 5.6GHz 2.58dBi
 - 5.785GHz 3.35dBi
- 1.7 Cable Loss..... 0.3 dB Max.
- 1.8 Polarization..... Linear
- 1.9 Cable..... 1.37 low loss Coaxial Cable
- 1.10 Connector..... I-PEX MHF Connector
- 1.11 Core.....NA

2. Physical Properties :

- 2.1 Operating Temp. -10°C ~ +60°C
- 2.2 Storage Temp. -10°C ~ +70°C

CG-

REV	DATE	DESCRIPTION
X1	05/19-2023	New Issue

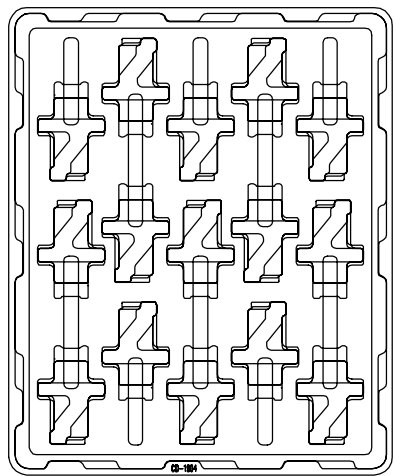
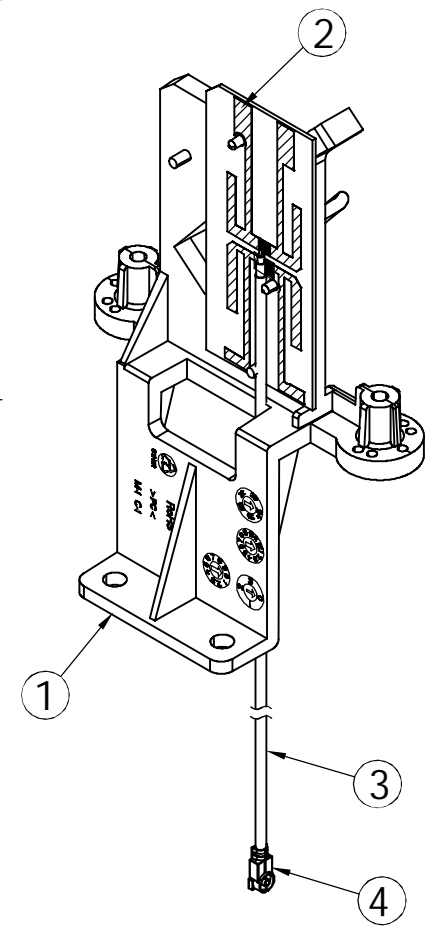
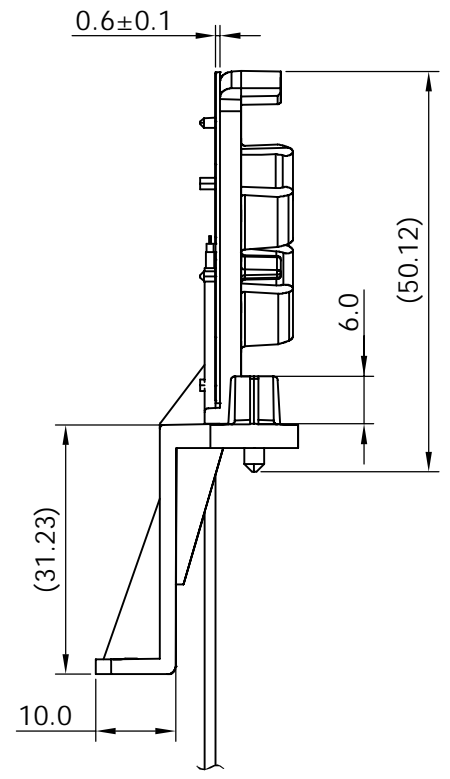
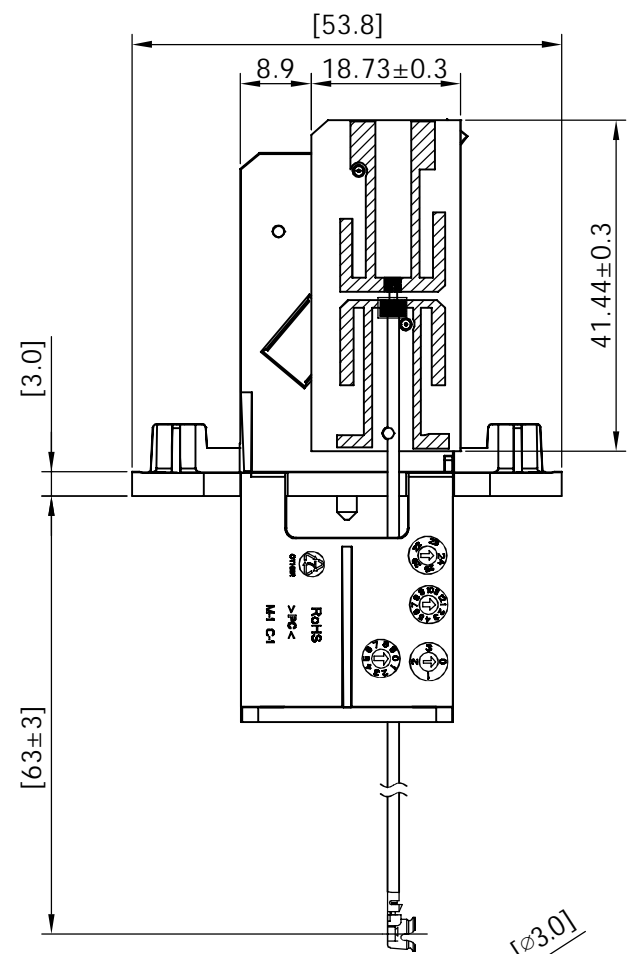

Packing : 15pcs/Tray

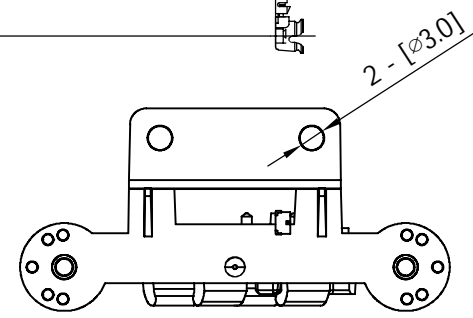

NO	DESCRIPTION	Q'TY	REMARK
4	Connector I-PEX MHF Connector	1	
3	Cable Φ 1.37mm Low loss Cable;L=90±3mm;Black[黑色]	1	
2	PCB FR4;24mil;1/2 Oz	1	
1	Holder PCR-PC6600 ; 白色	1	

180-315	±0.20	APPROVED	
80-180	±0.15		
30-80	±0.15	CHECKED	
6-30	±0.10		
0-6	±0.05	DRAWING	
<table border="1"> <tr> <td>CUSTOMER'S SINGATURE</td> </tr> </table>			CUSTOMER'S SINGATURE
CUSTOMER'S SINGATURE			

CUSTOMER: ASUS		
PART NO :		
PART NAME: RF Antenna Assembly		
W.Y P/NO : C660-510613-A		
REV	UNIT	FILE : SRF2023779
X1	mm	SHEET : 1/1

M.gear Wha Yu Group

THIS DRAWING, AND IT'S INHERANT DESIGN CONCEPTS, ARE THE PROPERTY OF WHA YU AND AS SUCH MAY NOT BE COPIED, REPRODUCED, OR GIVEN TO THIRD PARTIES WITHOUT THE WRITTEN CONSENT OF WHA YU.

XC5
C660-510603-A
(PCB)Antenna
Report

Version: V 1.00

Released Date: 2023/05/26

Prepared By: Cathy

Reviewed By: Stone



WHA YU INDUSTRIAL CO., LTD.
TEL : 886-3-5714225 FAX : 886-3-5713853 / 5723600¹
Website : www.whayu.com
E-mail : market@whayu.com

Contents

- Revised History
- Conclusion & Comments
- Specification
- Antenna Placement & Solution
- Test Setup for S-parameter Measurement
- Return Loss Results
- Isolation Results
- Test Setup for Radiation Pattern Measurement
- 2D Radiation Pattern Results
- Results Summary (return loss, isolation, peak gain, efficiency)

Revision History

Released Date	Version	Record
2023/02/03	1.00	Antenna Testing Report NEW Design
2023/05/26	1.01	客戶重新測試XC5的antenna composite gain

Specification

Requirements of Antenna Design

RF Function	Number of ANT	Frequency Band	Remark
WiFi	2	2.412G Hz~2.472GHz/5.15GHz~5.850GHz	

Requirements of Measurement

Test Item	Specification	Remark
Return Loss	> 10dB	
Isolation	NA	
Efficiency	2.4G> 80% / 5G>70%	
Radiation pattern	Scale: +10 ~ -40dBi, Angle step size: 5 degree	

Antenna Placement & Solution

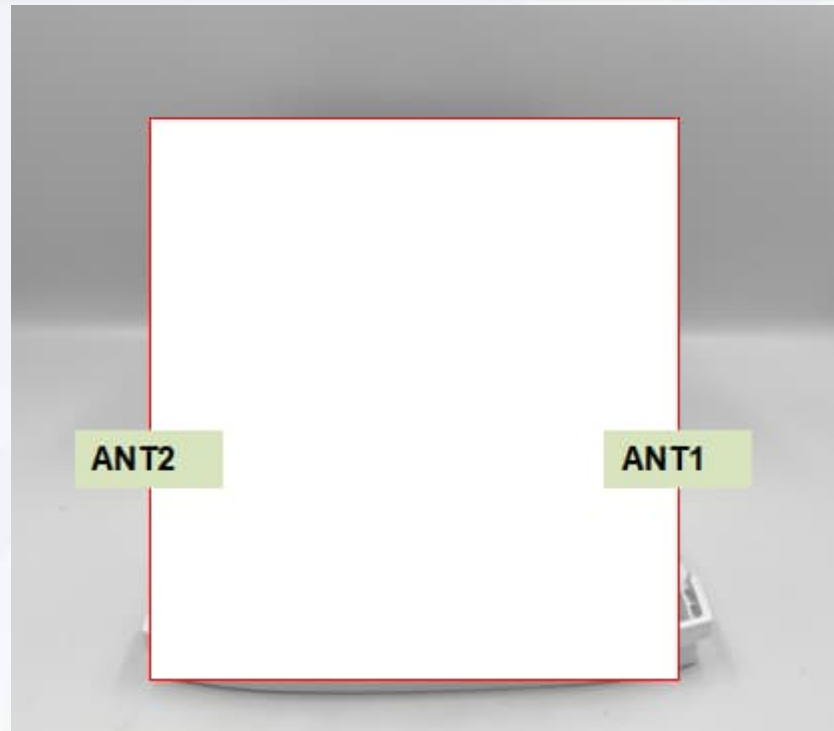

Antenna	ANT Type	Size (L * W * T)	Cable Length (mm)	Cable Type
ANT1	PCB Dipole	41*18.73*0.6	Exp 63mm	Ø1.37Black
ANT2	PCB Dipole	41*18.73*0.6	Exp 63mm	Ø1.37Black

Antenna Placement & Solution

Antenna	Previous Version	Current Version
ANT	ANT_v1.00 	

Test Setup for Radiation Pattern Measurement

Chamber Information

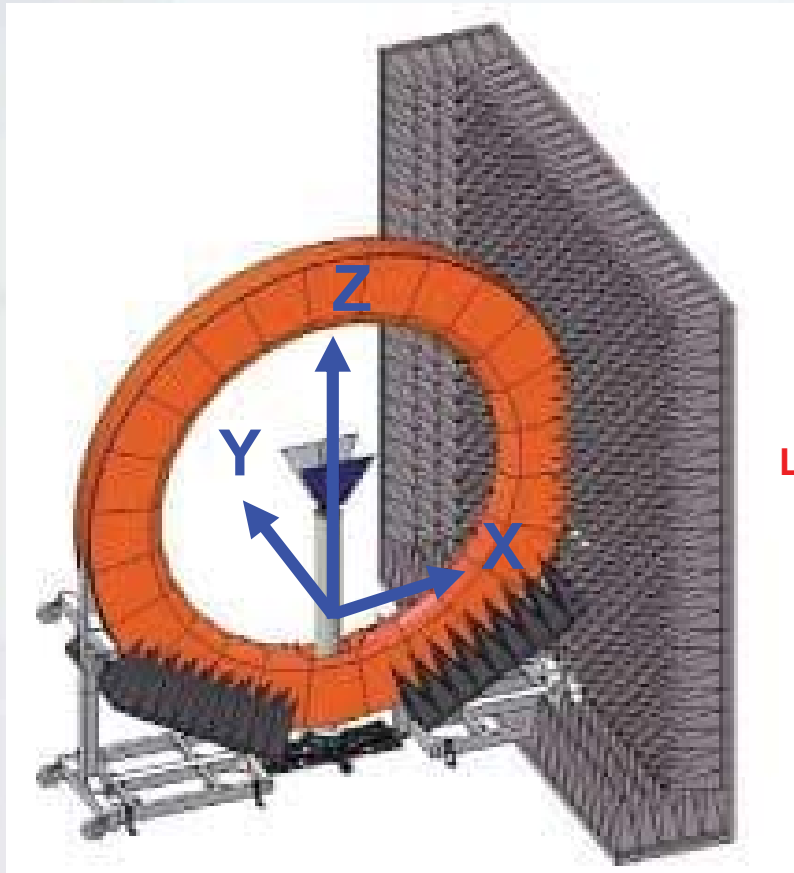

- SATIMO SG-24L Multi-Probe Antenna Measurement System
 - Angle between probes: 15°
 - Frequency range: 400 MHz – 9 GHz
 - Chamber Room Size: 5m L x 5m W x 5m H

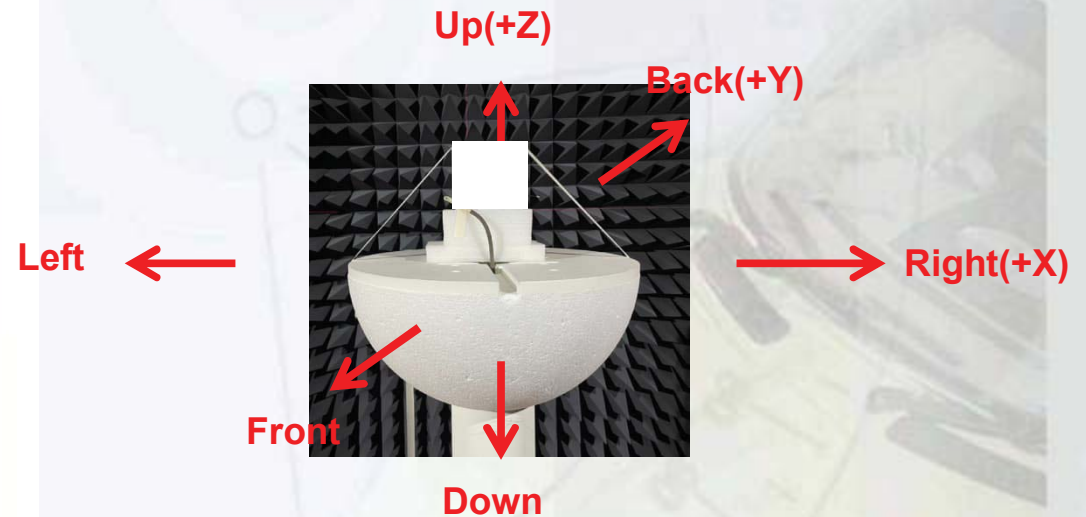

2D Radiation Pattern Results

(Dual Band)_ANT1 (2.4G)

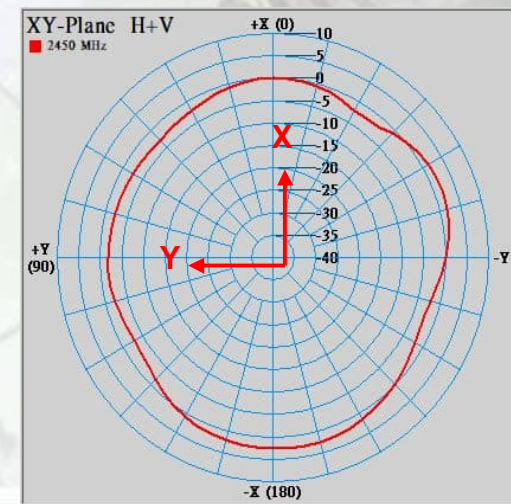
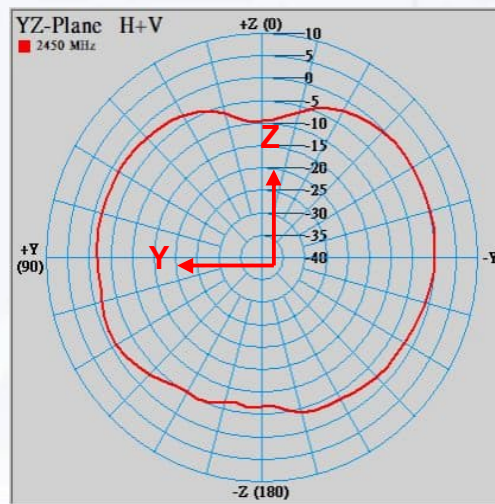
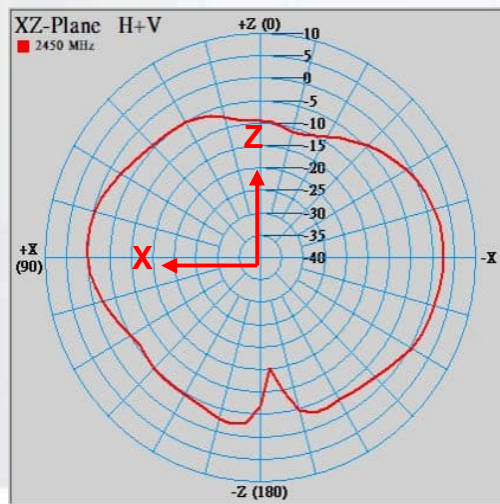
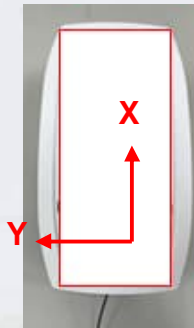
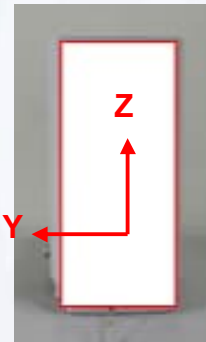
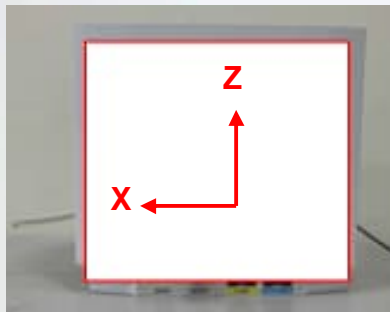

2D Radiation Pattern Results

(Dual Band)_ANT1 (5G)

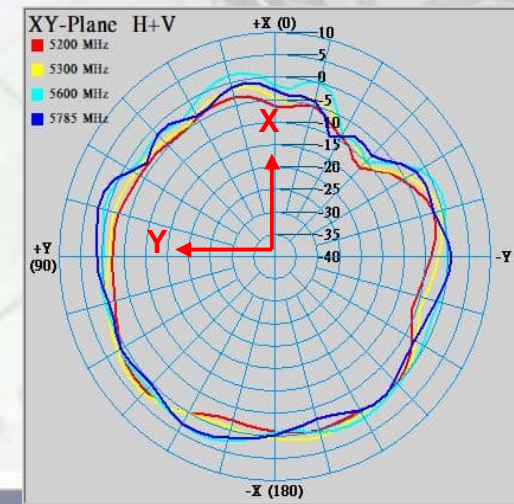
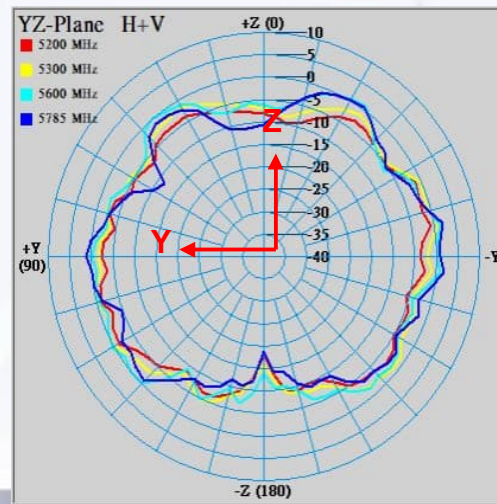
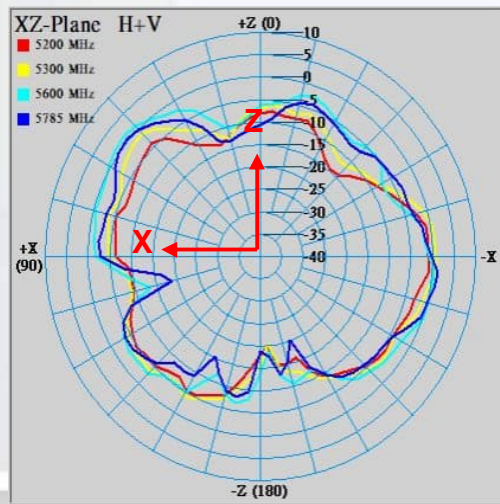
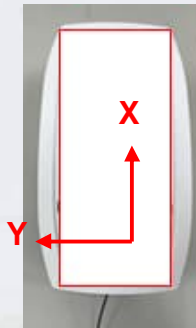
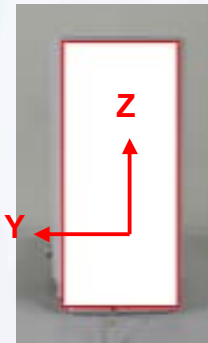
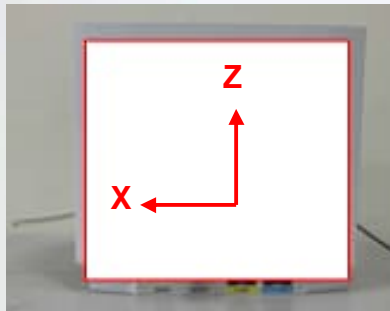

2D Radiation Pattern Results

(Dual Band)_ANT2 (2.4G)

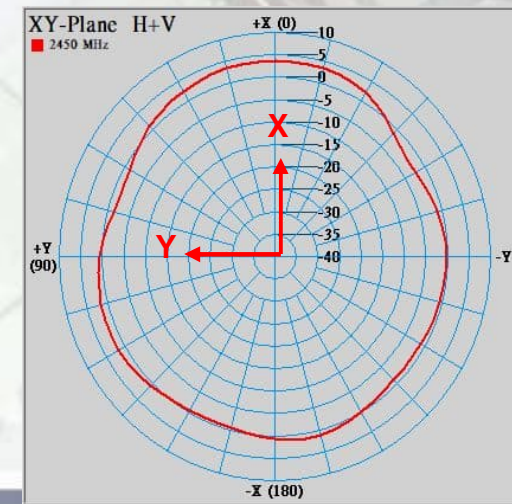
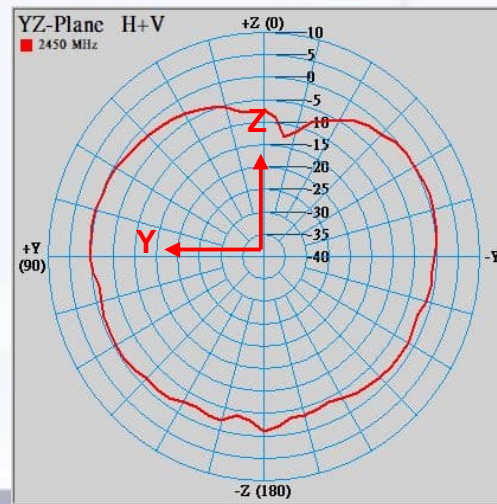
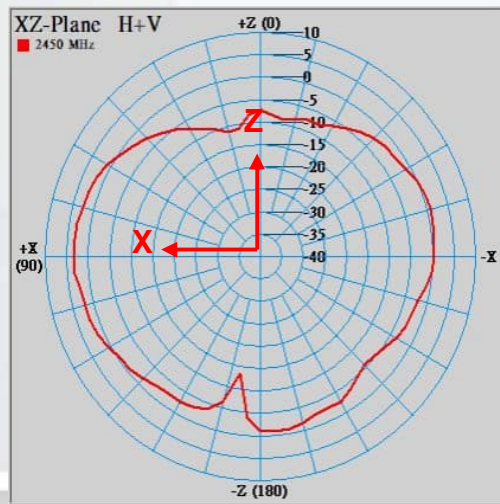
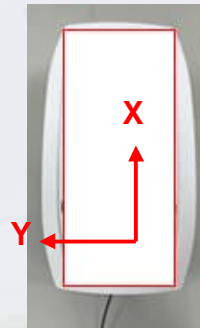
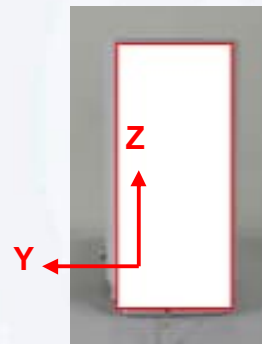
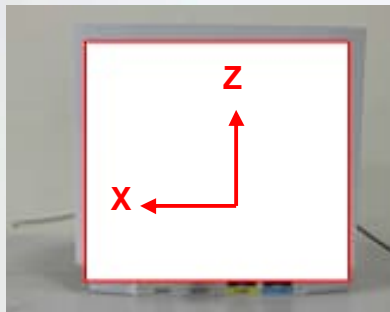

2D Radiation Pattern Results

(Dual Band)_ANT2 (5G)

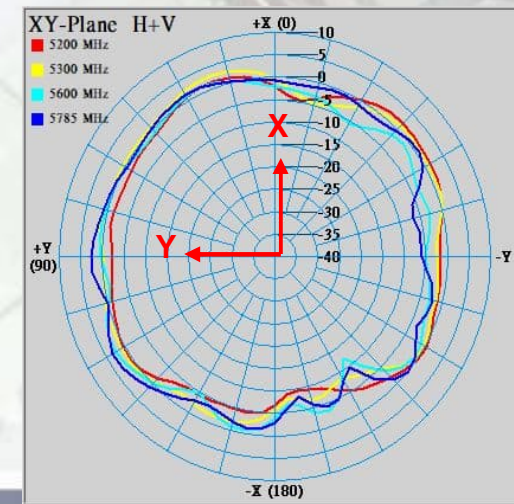
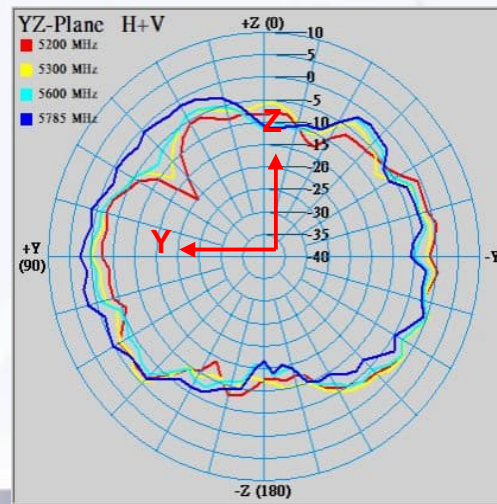
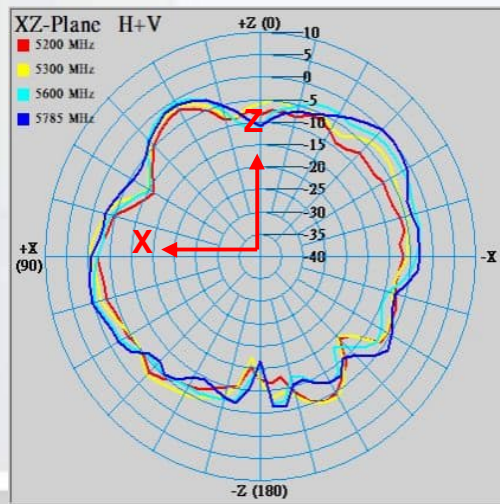
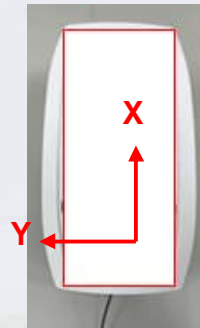
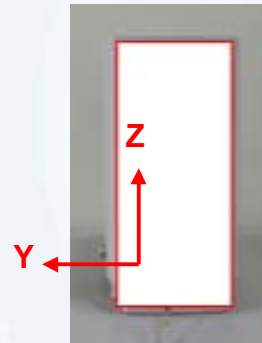
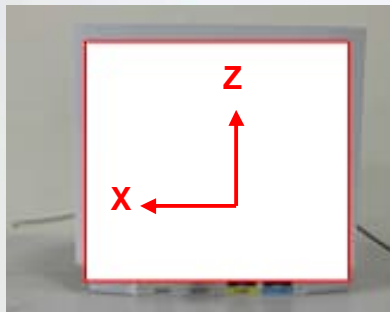

Results Summary

Freq(Hz)	2.45G	5.2G	5.3G	5.6G	5.785G
Ant.1 Max Gain(dBi)	2.01	2.51	2.39	2.78	3.09
Ant.2 Max Gain(dBi)	3.33	2.12	2.96	2.58	3.35
Ant. 1 Polarization/ Θ (°) / Φ (°)	Theta/82.5/105	Theta/52.5/150	Theta/75/150	Theta/45/150	Theta/75/120
Ant. 2 Polarization/ Θ (°) / Φ (°)	Theta/97.5/172.5	Theta/45/315	Theta/45/315	Theta/45/307.5	Theta/45/315

peak gain = reading value + factor