

# Quick Start Guide

**RT-AX92U**  
Wireless AX6100 Tri band Gigabit Router

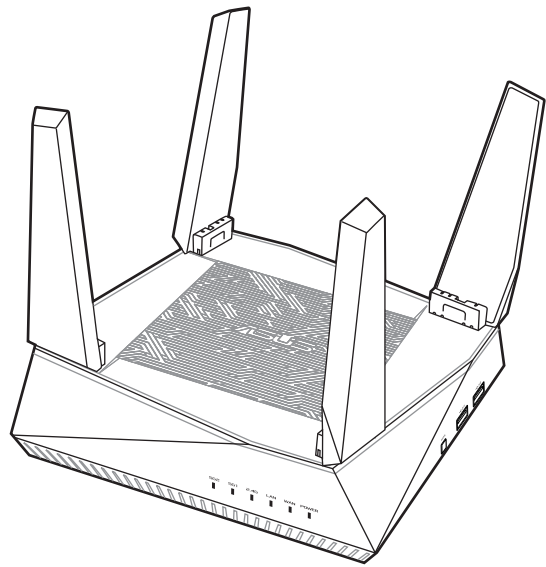

## Hardware Explanations

- 1 Plug the adapter into the DCIN port, and press the power button.
- 2 The Power, 2.4GHz and 5GHz LEDs will light up when your hardware is ready.

## Button Explanations

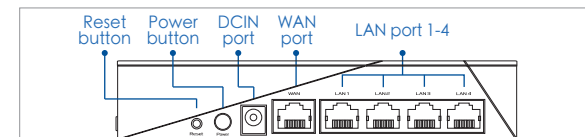

- **RESET BUTTON**  
Reset the system to its factory default settings.
- **WAN PORT**  
Connect your modem to this port with a network cable.
- **LAN PORT 1-4**  
Connect your PC to a LAN port with a network cable.

## USB Explanations

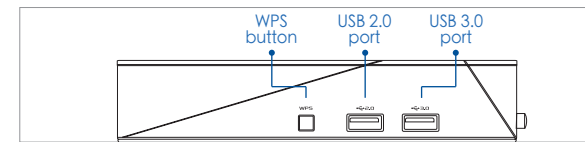

## BEFORE SETTING

### 01 Preparing to setup a standalone router

- 1 Go to **ONE ROUTER SETUP STEPS**.

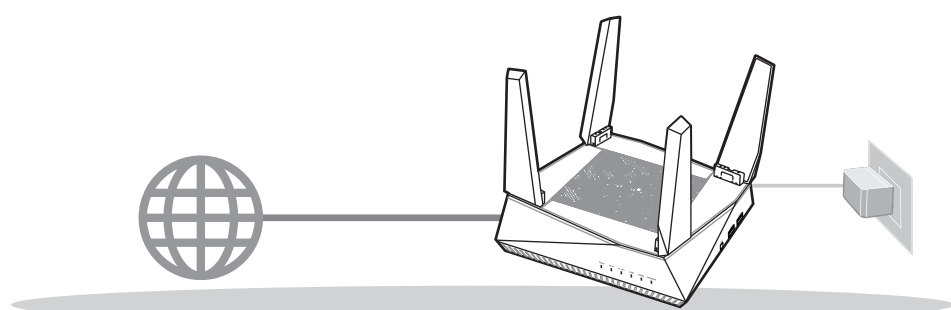

**ONE ROUTER SETUP**

### 02 Preparing to setup an AiMesh Wi-Fi system

- 1 Two (2) ASUS routers (models supporting AiMesh <https://www.asus.com/AiMesh/>)
- 2 Assign one as AiMesh router, and another one as AiMesh node.  
\*\* If you have multiple AiMesh routers, we recommend using the router with the highest specifications as your AiMesh router and the others as AiMesh nodes.
- 3 Go to **AiMesh SETUP STEPS**.

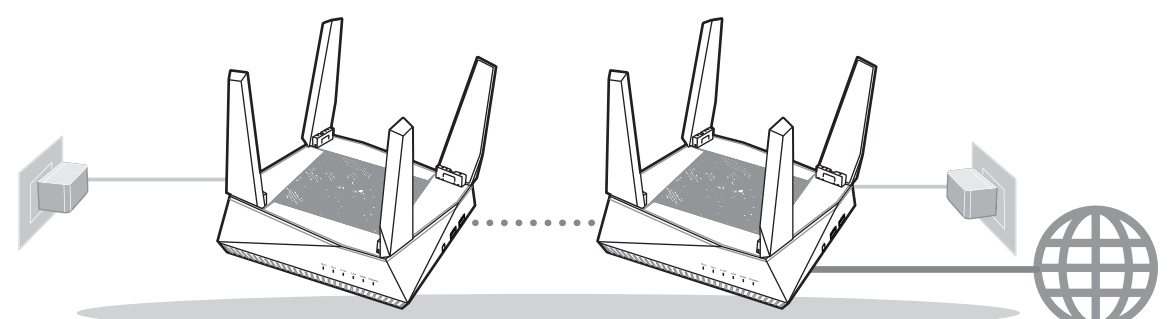

**AiMesh SETUP STEPS**

## ONE ROUTER SETUP STEPS WE SUGGEST...

### 01 Prepare your Modem

- 1 Unplug the power of cable / DSL modem. If it has a battery backup, remove the battery. 1

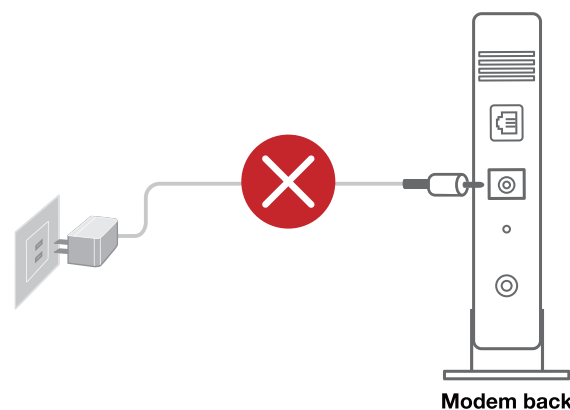

- 2 Connect your modem to the router with the network cable provided.

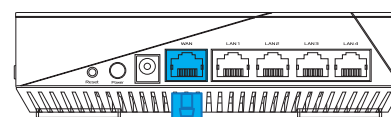

- 3 Power on the modem. Plug modem to the power outlet and power on.

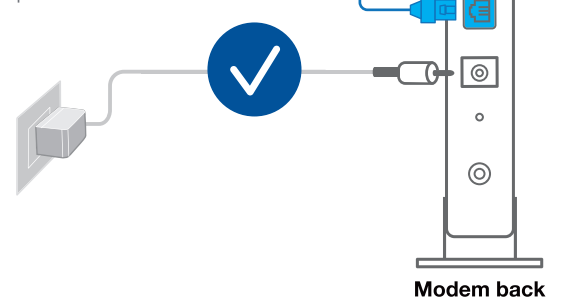

- 4 Check the modem LED lights to ensure the connection is active.

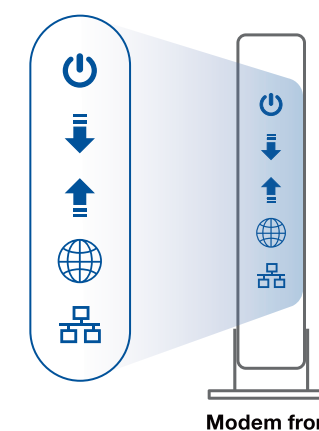

1 If you are using DSL for internet, you will need your username / password from your Internet service provider (ISP) to properly configure your router.

### 02 Connect your Device

- 1 Power on the router. Plug in and press the power button at the back of your router.

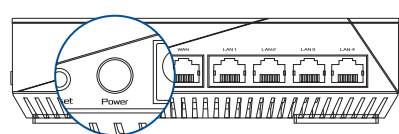

- 2 Check the WAN and 2.4GHz / 5GHz LED lights to ensure the hardware connection is ready.

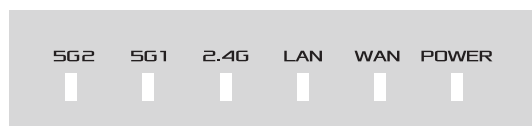

- 3 Connect your PC to the router using an additional network cable.

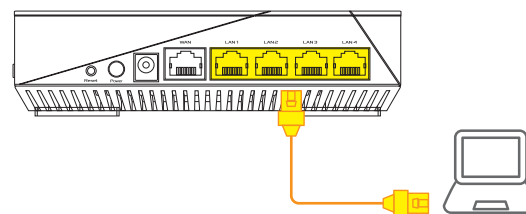

### 03 Login and Connect

- 1 Open a web browser. You will be redirected to the ASUS Setup Wizard. If not, navigate to <http://router.asus.com>.



## AiMesh SETUP STEPS

### 01 Prepare

Place your AiMesh router and node within 1-3 meters of each other during the setup process.

### 02 AiMesh node

Factory default status. Keep power on and standby for AiMesh system setting.

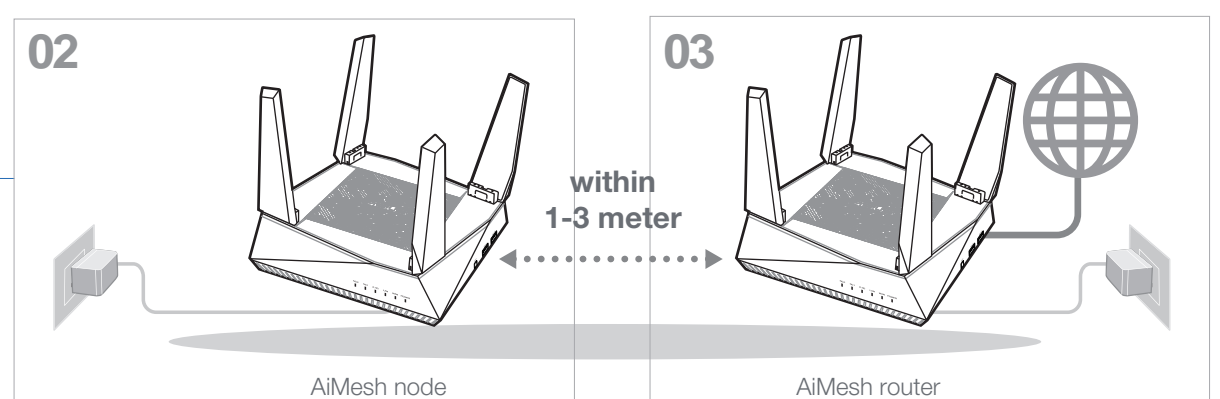

## 03 AiMesh router

1 Refer to **ONE ROUTER SETUP STEPS** to connect your AiMesh router to your PC and modem, and then log in into the web GUI.

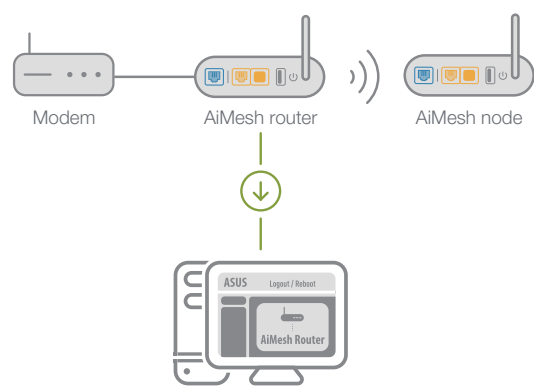

2 Go to Network Map page, click AiMesh icon and then Search for your extending AiMesh node.

\*\* If you cannot find the AiMesh icon here, click on firmware version and update the firmware.

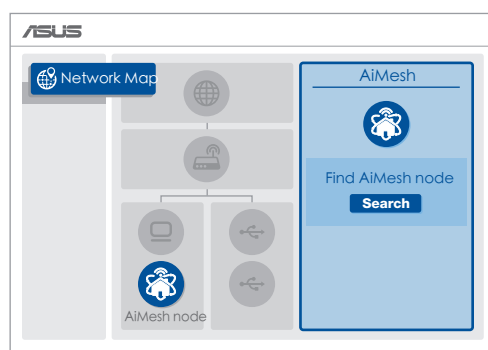

3 Click Search, it will automatically search for your AiMesh node. When the AiMesh node shows on this page, click it to add it into the AiMesh system.

\*\* If you cannot find any AiMesh node, please go to "TROUBLESHOOTING".

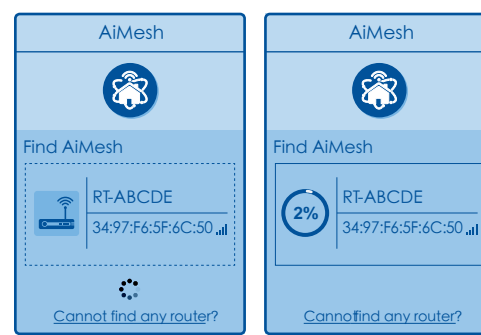

4 A message is displayed when synchronization is completed.

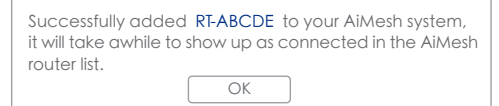

5 Congratulations! You will find the pages below show up when an AiMesh node has been successfully added to the AiMesh network.

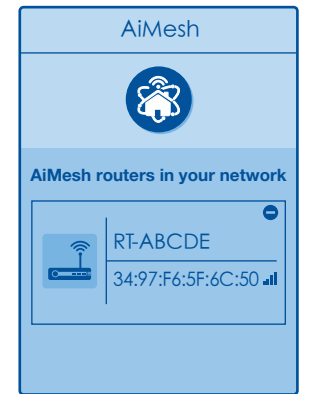

## TROUBLE SHOOTING

If your AiMesh router cannot find any AiMesh node nearby or synchronization fails, please check followings and try again.

- a Move your AiMesh node closer to the AiMesh router ideally. Ensure it is within 1-3 meters.
- b Your AiMesh node is powered on.

## RELOCATION THE BEST PERFORMANCE

Locate AiMesh router and node at best place.

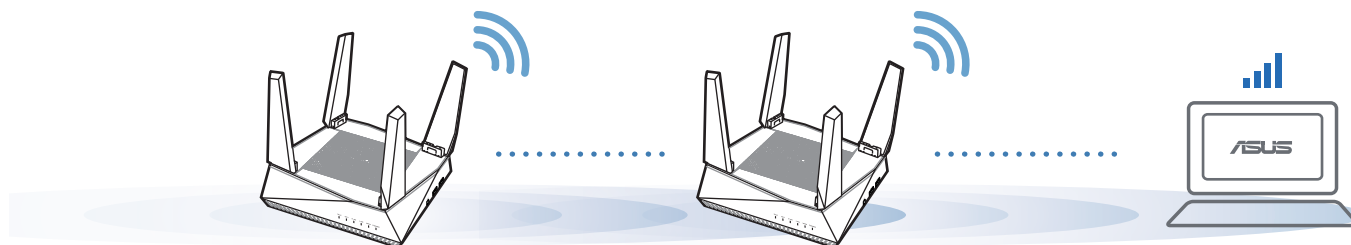

**NOTE** To minimize interference, keep the routers away from devices like cordless phones, Bluetooth devices and microwave ovens. We recommend that you place the routers in an open or spacious location.

## ASUS ROUTER APP

Download free ASUS Router APP to setup and manage your router(s).



## FAQ FREQUENTLY ASKED QUESTIONS

Q1 Does the AiMesh router support Access Point mode?

**A : Yes.** You can choose to set the AiMesh router as router mode or access point mode. Please go to web GUI (<http://router.asus.com>), and go to the page Administration → Operation Mode.

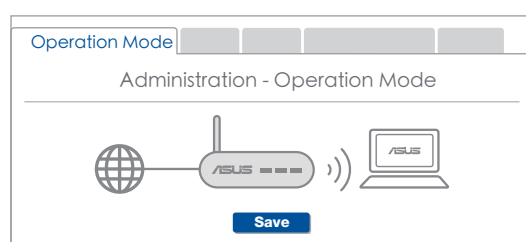

Q2 Could I setup wired connection between AiMesh routers (Ethernet backhaul)?

**A : Yes.** AiMesh system supports both wireless and wired connection between AiMesh router and node to maximize throughput and stability. AiMesh analyzes the wireless signal strength for each frequency band available, and then determines automatically whether a wireless or wired connection is best to serve as the inter-router connection backbone.

Follow the setup steps to establish a connection between the AiMesh router and node via Wi-Fi first.

Place the node in the ideal locations for best coverage. Run an Ethernet cable from the LAN port of the AiMesh router to the WAN port of AiMesh node.



AiMesh system will auto-select the best path for data transmission, whether wired or wireless.

### ASUS Recycling/Takeback Services

ASUS recycling and takeback programs come from our commitment to the highest standards for protecting our environment. We believe in providing solutions for you to be able to responsibly recycle our products, batteries, other components, as well as the packaging materials. Please go to <http://csr.asus.com/english/Takeback.htm> for the detailed recycling information in different regions.

### REACH

Complying with the REACH (Registration, Evaluation, Authorisation, and Restriction of Chemicals) regulatory framework, we published the chemical substances in our products at ASUS REACH website at <http://csr.asus.com/english/REACH.htm>

### Federal Communications Commission Statement

This device complies with Part 15 of the FCC Rules. Operation is subject to the following two conditions:  
 • This device may not cause harmful interference.  
 • This device must accept any interference received, including interference that may cause undesired operation.

This equipment has been tested and found to comply with the limits for a class B digital device, pursuant to part 15 of the FCC Rules. These limits are designed to provide reasonable protection against harmful interference in a residential installation. This equipment generates, uses and can radiate radio frequency energy and, if not installed and used in accordance with the instructions, may cause harmful interference to radio communications. However, there is no guarantee that interference will not occur in a particular installation. If this equipment does cause harmful interference to radio or television reception, which can be determined by turning the equipment off and on, the user is encouraged to try to correct the interference by one or more of the following measures:

- Reorient or relocate the receiving antenna.
- Increase the separation between the equipment and receiver.
- Connect the equipment into an outlet on a circuit different from that to which the receiver is connected.
- Consult the dealer or an experienced radio/TV technician for help.

**WARNING!** Any changes or modifications not expressly approved by the party responsible for compliance could void the user's authority to operate the equipment.

### Déclaration de conformité de Innovation, Sciences et Développement économique Canada (ISED)

Le présent appareil est conforme aux CNR d'Innovation, Sciences et Développement économique Canada applicables aux appareils radio exempts de licence. L'exploitation est autorisée aux deux conditions suivantes : (1) l'appareil ne doit pas produire de brouillage, et (2) l'utilisateur de l'appareil doit accepter tout brouillage radioélectrique subi, même si le brouillage est susceptible d'en compromettre le fonctionnement.

La bande 5150 - 5250 MHz est réservée uniquement pour une utilisation à l'intérieur afin de réduire les risques de brouillage préjudiciable aux systèmes de satellites mobiles utilisant les mêmes canaux.

CAN ICES-3(B)/NMB-3(B)

### Informations concernant l'exposition aux fréquences radio (RF)

La puissance de sortie émise par cet appareil sans fil est inférieure à la limite d'exposition aux fréquences radio d'Innovation, Sciences et Développement économique du Canada (ISED). Utilisez l'appareil sans fil de façon à minimiser les contacts humains lors d'un fonctionnement normal.

Cet équipement doit être installé et utilisé avec un minimum de 29 cm de distance entre la source de rayonnement et votre corps.

L'utilisation de cet appareil est autorisée au Canada. Pour consulter l'entrée correspondant à l'appareil dans la liste d'équipement radio (REL - Radio Equipment List) d'Innovation, Sciences et Développement économique du Canada, rendez-vous sur : [http://www.ic.gc.ca/eic/site/ceb-bhst.nsf/eng/h\\_tt00020.html](http://www.ic.gc.ca/eic/site/ceb-bhst.nsf/eng/h_tt00020.html)

Pour des informations supplémentaires concernant l'exposition aux fréquences radio au Canada, rendez-vous sur : <https://www.ic.gc.ca/eic/site/smt-gst.nsf/eng/sf08792.html>

### Prohibition of Co-location

This device and its antenna(s) must not be co-located or operating in conjunction with any other antenna or transmitter.

### IMPORTANT NOTE:

**Radiation Exposure Statement:** This equipment complies with FCC radiation exposure limits set forth for an uncontrolled environment. End users must follow the specific operating instructions for satisfying RF exposure compliance. To maintain compliance with FCC exposure compliance requirement, please follow operation instruction as documented in this manual.



**WARNING!** This equipment must be installed and operated in accordance with provided instructions and the antenna(s) used for this transmitter must be installed to provide a separation distance of at least 30 cm from all persons and must not be co-located or operating in conjunction with any other antenna or transmitter.

### Compliance Statement of Innovation, Science and Economic Development Canada (ISED)

This device complies with Innovation, Science and Economic Development Canada licence exempt RSS standard(s). Operation is subject to the following two conditions: (1) this device may not cause interference, and (2) this device must accept any interference, including interference that may cause undesired operation of the device.

The device for operation in the band 5150-5250 MHz is only for indoor use to reduce the potential for harmful interference to co-channel mobile satellite systems. Les dispositifs fonctionnant dans la bande 5150-5250 MHz sont réservés uniquement pour une utilisation à l'intérieur afin de réduire les risques de brouillage préjudiciable aux systèmes de satellites mobiles utilisant les mêmes canaux.

### Radio Frequency (RF) Exposure Information

The radiated output power of the ASUS Wireless Device is below the Innovation, Science and Economic Development Canada radio frequency exposure limits. The ASUS Wireless Device should be used in a manner such that the potential for human contact during normal operation is minimized.

IC Radiation Exposure Statement: This equipment complies with IC RSS-102 radiation exposure limits set forth for an uncontrolled environment. This equipment should be installed and operated with minimum distance 29cm between the radiator & your body. Cet équipement est conforme aux limites d'exposition aux rayonnements IC établies pour un environnement non contrôlé. Cet équipement doit être installé et utilisé avec un minimum de 29cm de distance entre la source de rayonnement et votre corps.

This device has been certified for use in Canada. Status of the listing in the Innovation, Science and Economic Development Canada's REL (Radio Equipment List) can be found at the following web address:

[http://www.ic.gc.ca/eic/site/ceb-bhst.nsf/eng/h\\_tt00020.html](http://www.ic.gc.ca/eic/site/ceb-bhst.nsf/eng/h_tt00020.html)

Additional Canadian information on RF exposure also can be found at the following web: <https://www.ic.gc.ca/eic/site/smt-gst.nsf/eng/sf08792.html>

For product available in the USA/Canada market, only channel 1-11 can be operated. Selection of other channels is not possible. This device is restricted for indoor use. Pour les produits disponibles aux États-Unis / Canada du marché, seul le canal 1 à 11 peuvent être exploités. Sélection d'autres canaux n'est pas possible.

### Specifications:

DC Power adapter	DC Output: +19V with max 1.75A current		
Operating Temperature	0-40°C	Storage	0-70°C
Operating Humidity	50-99%	Storage	20-90%

### Safety Notices:

- Use this product in environments with ambient temperatures between 0°C(32°F) and 40°C(104°F).
- Refer to the rating label on the bottom of your product and ensure your power adapter complies with this rating.
- DO NOT place on uneven or unstable work surfaces. Seek servicing if the casing has been damaged.
- DO NOT place or drop objects on top and do not shove any foreign objects into the product.
- DO NOT expose to or use near liquids, rain, or moisture. DO NOT use the modem during electrical storms.
- DO NOT cover the vents on the product to prevent the system from getting overheated.
- DO NOT use damaged power cords, accessories, or other peripherals.
- If the Adapter is broken, do not try to fix it by yourself. Contact a qualified service technician or your retailer.
- To prevent electrical shock hazard, disconnect the power cable from the electrical outlet before relocating the system.