

TAS Algorithm Validation Report for FCC

(Test Under Dynamic Transmission Condition)

Applicant Name : ASUSTeK COMPUTER INC.

Applicant Address : 1F., No. 15, Lide Rd., Beitou Dist., Taipei City 112, Taiwan

Product Name : 2TX 11be (WiFi7)BW160 + BT/BLE Combo Card

Brand Name : MediaTek

Model Number : MT7925B22M

FCC ID : MSQ-MT7925B22M

Report Number : USSC244178002

Compliant Standards : FCC 47 CFR §2.1093

Sample Received Date : Apr. 15, 2024

Date of Testing : May 27, 2024 ~ Jun. 03, 2024

Report Issue Date : Jun. 26, 2024

The above equipment have been tested by **Eurofins E&E Wireless Taiwan Co., Ltd.**, and found compliance with the requirement of the above standards. The test record, data evaluation & Device Under Test (DUT) configurations represented herein are true and accurate accounts of the measurements of the sample's characteristics under the conditions specified in this report.

Note:

1. The test results are valid only for samples provided by customers and under the test conditions described in this report.
2. This report shall not be reproduced except in full, without the written approval of Eurofins E&E Wireless Taiwan Co., Ltd.
3. The relevant information is provided by customers in this test report. According to the correctness, appropriateness or completeness of the information provided by the customer, if there is any doubt or error in the information which affects the validity of the test results, the laboratory does not take the responsibility.

Approved By :

Roy Wu / Technical Director

Table of Contents

Revision History	3
1. Information of Testing Laboratory	4
2. Device Under Test Information.....	5
3. Overview of Wi-Fi TA-SAR / TA-PD Test Proposal.....	7
4. Wi-Fi TA-SAR Test Scenarios and Test Procedures.....	8
4.1. Test Sequence for All Scenarios	8
4.2. Test Procedure for Scenario 1: TX Mode Change via Conducted Power Measurements	9
4.3. Test Procedure for Scenario 2: Band Handover via Conducted Power Measurements	11
4.4. Test Procedure for Scenario 3: Antenna Switching via Conducted Power Measurements.....	13
4.5. Test Procedure for Scenario 4: ECI Change via Conducted Power Measurements.....	14
4.6. Test Procedure for Scenario 5: Simultaneous SAR & PD via Conducted Power Measurements	15
4.7. Test Procedure for Scenario 1: TX Mode Change via SAR Measurements	17
5. Wi-Fi TA-PD Test Scenarios and Test Procedures	18
5.1. Test Sequence for All Scenarios	18
5.2. Test Procedure for Scenario 1: TX Mode Change via Conducted Power Measurements	19
5.3. Test Procedure for Scenario 1: TX Mode Change via Power Density Measurements.....	21
6. Wi-Fi TA-SAR Validation via Conducted Power Measurement.....	22
6.1. Measurement Setup.....	22
6.2. Conducted Power Measurement Results for Scenario 1: Tx Mode Change	25
6.3. Conducted Power Measurement Results for Scenario 2: Band Handover.....	27
6.4. Conducted Power Measurement Results for Scenario 3: Antenna Switching	29
6.5. Conducted Power Measurement Results for Scenario 4: ECI Change	31
6.6. Conducted Power Measurement Results for Scenario 5: Simultaneous SAR and PD.....	33
7. Wi-Fi TA-SAR Validation via SAR Measurement.....	35
7.1. Measurement Setup.....	35
7.2. DASY8 System Verification for SAR Measurement.....	35
7.3. TA-SAR Measurement Results for Scenario 1: TX Mode Change	36
8. Wi-Fi TA-PD Validation via Conducted Power Measurement	38
8.1. Conducted Power Measurement Results for Scenario 1: TX Mode Change.....	38
9. Wi-Fi TA-PD Validation via PD Measurement.....	39
9.1. DASY8 System Verification for PD Measurement	39
9.2. TA-PD Measurement Results for Scenario 1: TX Mode Change.....	40
10. Conclusions for Time-Averaging Feature Validation	41
11. Equipment List.....	42
12. Measurement Uncertainties	43

Appendix A – Test Setup Photographs

Appendix B – System Check Plots

Appendix C – Calibration Certificate for Probe

Appendix D – Calibration Certificate for Dipole

1. Information of Testing Laboratory

Test Facilities

Company Name: Eurofins E&E Wireless Taiwan Co., Ltd.
 Address No.: 140-1, Changan Street, Bade District, Taoyuan City 334025, Taiwan
 Website: <https://www.atl.com.tw>
 Telephone: +886-3-271-0188
 Fax: +886-3-271-0190
 E-mail: infoEETW@eurofins.com

Test Site Location

- No. 140-1, Changan Street, Bade District, Taoyuan City 334025, Taiwan
- No. 2, Wuquan 5th Rd. Wugu Dist., New Taipei City, Taiwan

Laboratory Accreditation

Location	TAF	FCC	ISED
No. 140-1, Changan Street, Bade District, Taoyuan City 334025, Taiwan	Accreditation No.: 1330	Designation No.: TW0010	Company No.: 7381A CAB ID: TW1330
No. 2, Wuquan 5th Rd. Wugu Dist., New Taipei City, Taiwan	Accreditation No.: 1330	Designation No.: TW0034	Company No.: 28922 CAB ID: TW1330

2. Device Under Test Information

Product Name	2TX 11be (WiFi7)BW160 + BT/BLE Combo Card	
Brand Name	MediaTek	
Model Name	MT7925B22M	
FCC ID	MSQ-MT7925B22M	
Host Information	Product Name: Notebook PC Trade Name: ASUS Model Name: HN7306W, JN7306W	
Supported Wireless Technologies	Tx Frequency (MHz)	Operating Mode
	WLAN 2.4G : 2412 ~ 2472 5G : 5180 ~ 5240, 5260 ~ 5320, 5500 ~ 5720, 5745 ~ 5825, 5815 ~ 5885 6G : 5955 ~ 7115	2.4G : 802.11b/g/n/ac/ax/be 5G : 802.11a/n/ac/ax/be 6G : 802.11a/ax/be
	Bluetooth 2402 ~ 2480	BR, EDR, LE

Note:

The above DUT information is declared by manufacturer and for more detailed features description please refers to the manufacturer's specifications or User's Manual.

Time-Averaging for SAR and Power Density

This device is enabled with *MediaTek's* TA-SAR and TA-PD algorithms to control and manage instantaneous transmitting power in real time for transmit frequencies less and larger than 6 GHz respectively and to ensure that the time-averaged RF exposure from WLAN is in compliance with FCC requirements.

FCC regulation allows time-averaged RF exposure to demonstrate compliance to safety limits. Because RF exposure is correlated to transmission power (TX power), the TX power can be controlled to meet FCC RF exposure limits defined as the Specific Absorption Rate (SAR) limit for transmit frequencies < 6 GHz and Power Density (PD) limit for transmit frequencies > 6 GHz. For SAR limit, the proposed Time-Averaged Specific Absorption Rate (TA-SAR) algorithm manages TX power to ensure that at all times the time-averaged RF exposure is compliant with the FCC regulation. For PD limit, the proposed Time-Averaged Power Density (TA-PD) algorithm controls TX power to ensure that at all times the time-averaged RF exposure is compliant with the FCC PD requirement. For Wi-Fi 6 GHz band, the proposed TA-SAR algorithm and the proposed TA-PD algorithm ensure that at all times the time-averaged RF exposure is compliant with the FCC SAR requirement, PD requirement, and Total Exposure Ratio (TER) limit.

The compliance test under the static transmission scenario and simultaneous transmission analysis are reported in *SAR / APD / IPD Evaluation Report*. The validation of the time-averaging algorithm and compliance under the dynamic (time-varying) transmission scenario for WLAN technologies are reported in this *TAS Algorithm Validation report*.

In addition, this device supports WLAN and Bluetooth technology, but the output power of **Bluetooth** modem is not controlled by the Wi-Fi TA-SAR algorithm and has no TAS function.

Operating Parameters for Wi-Fi TA-SAR and TA-PD Algorithm

Term	Description
<p><i>P_{WF_SAR_limit}</i> (<i>P_{WF_SAR_limit}</i>)</p>	<p>The time-averaged maximum power level limit corresponding to <i>WF_SAR_design_limit</i>.</p> <ul style="list-style-type: none"> For FCC, <i>SAR_REG_limit</i> : 1.6 W/kg (1g-SAR), 4.0 W/kg (10g-SAR). <i>WF_SAR_design_limit</i> is <i>SAR_REG_limit</i> with device total uncertainty for more conservative assessment. <i>P_{WF_SAR_limit}</i> has the unique value for each Wi-Fi band / antenna / exposure condition index.
<p><i>P_{WF_SAR_MAX_limit}</i> (<i>P_{WF_SAR_MAX_limit}</i>)</p>	<p>Wi-Fi TA-SAR maximum instantaneous TX power limit, which is less than or equal to maximum TX power <i>P_{WF_SAR_MAX}</i> that can be possibly transmitted in Wi-Fi. The power limit is dynamically adjusted based on Wi-Fi TA-SAR algorithm.</p>
<p><i>P_{WF_PD_limit}</i> (<i>P_{WF_PD_limit}</i>)</p>	<p>The time-averaged maximum power level limit corresponding to <i>WF_PD_design_limit</i>.</p> <ul style="list-style-type: none"> For FCC, <i>PD_REG_limit</i> : 10 W/m² (4 cm² PD). <i>WF_PD_design_limit</i> is <i>PD_REG_limit</i> with device total uncertainty for more conservative assessment. <i>P_{WF_PD_limit}</i> has the unique value for each Wi-Fi band / antenna / exposure condition index.
<p><i>P_{WF_PD_MAX_limit}</i> (<i>P_{WF_PD_MAX_limit}</i>)</p>	<p>Wi-Fi TA-PD maximum instantaneous PD TX power limit, which is less than or equal to maximum TX power <i>P_{WF_PD_MAX}</i> that can be possibly transmitted in Wi-Fi. The power limit is dynamically adjusted based on Wi-Fi TA-PD algorithm.</p>

3. Overview of Wi-Fi TA-SAR / TA-PD Test Proposal

For the completeness of verifying that the proposed TA-SAR algorithm can realize FCC compliance regarding RF exposure, several test scenarios are constructed as below:

- **Scenario 1:** Test TX mode change between normal mode and sleep mode to verify algorithm and SAR compliance.
- **Scenario 2:** Test band handover to ensure algorithm control continuity and correctness.
- **Scenario 3:** Test different transmission antennas to ensure algorithm control works correctly during antenna switch from one antenna to another.
- **Scenario 4:** Test different ECI (Exposure Condition Index) to ensure algorithm control behaves as expected during ECI switch from one ECI to another.
- **Scenario 5:** Test TER under 2.4 GHz band and 6 GHz band simultaneous transmission. Since both SAR and PD are required in Wi-Fi 6 GHz band, the maximum of normalized TA-SAR and normalized TA-PD in 6 GHz band should be used in TER calculation. The proposed algorithm can ensure TA-SAR / TA-PD control correctness and prove the normalized total RF exposure is less than or equal to 1.

The *Table 3-1* lists the applicable test scenarios for this DUT to validate Wi-Fi TA-SAR and TA-PD algorithms to demonstrate that the TAS algorithms performs as expected under various operating scenarios.

Table 3-1: Applicable Test Scenarios for Wi-Fi TA-SAR and TA-PD Validation

Test Scenario	Description	Device Requirement	Test Required for this DUT
1. TX Mode Change	Test normal mode and sleep mode switch		YES
2. Band Handover	Test 2.4 GHz / 5 GHz band change	Supports DBDC	YES
3. Antenna Switching	Change antenna index		YES
4. ECI (Exposure Condition Index) Change	Test under ECI transition	Supports Various ECI	YES
5. Simultaneous SAR and PD	TER of 2.4 GHz TA-SAR and 6 GHz TA-SAR / TA-PD	Supports DBDC or MLO	YES

Note:

Since *MediaTek's* TA-SAR / TA-PD feature operation is independent of bands and channels, selecting one band is sufficient to validate this feature. The frequency band selection for TA-SAR is based on the 2.4 GHz band among 2.4 GHz and 5 GHz bands, and the band selection for TA-PD is based on the 6 GHz band.

For Wi-Fi TA-SAR validation, description of the conducted power measurement test procedures is included in *sections 4.2 to 4.6*, and description of the SAR measurement test procedures is included in *section 4.7*. For Wi-Fi TA-PD validation, description of the conducted power measurement test procedures is included in *section 5.2*, and description of the PD measurement test procedures is included in *section 5.3*.

4. Wi-Fi TA-SAR Test Scenarios and Test Procedures

In order to demonstrate that Wi-Fi TA-SAR algorithm performs as expected under various operating scenarios, Table 4-1 lists the test scenarios to validate TA-SAR algorithm. The test sequences are defined in section 4.1. The details of each test procedures via conducted power and SAR measurements are described in sections 4.2 to 4.6 and section 4.7, respectively.

Table 4-1: Test Scenario List for Wi-Fi TA-SAR Validation

Test Scenario	Description	Device Requirement
1. TX Mode Change	Test normal mode and sleep mode switch	
2. Band Handover	Test 2.4 GHz / 5 GHz band change	Supports DBDC
3. Antenna Switching	Change antenna index	
4. ECI (Exposure Condition Index) Change	Test under ECI transition	Supports Various ECI
5. Simultaneous SAR and PD	TER of 2.4 GHz TA-SAR and 6 GHz TA-SAR / TA-PD	Supports DBDC or MLO

4.1. Test Sequence for All Scenarios

The test sequence is predefined for TA-SAR.

Test Sequence: Wi-Fi TX is requested to transmit static and maximum power with high duty.

The test sequence is illustrated in Figure 4-1. The waveform of the test sequence is listed in Table 4-2.

Figure 4-1: Test Sequence

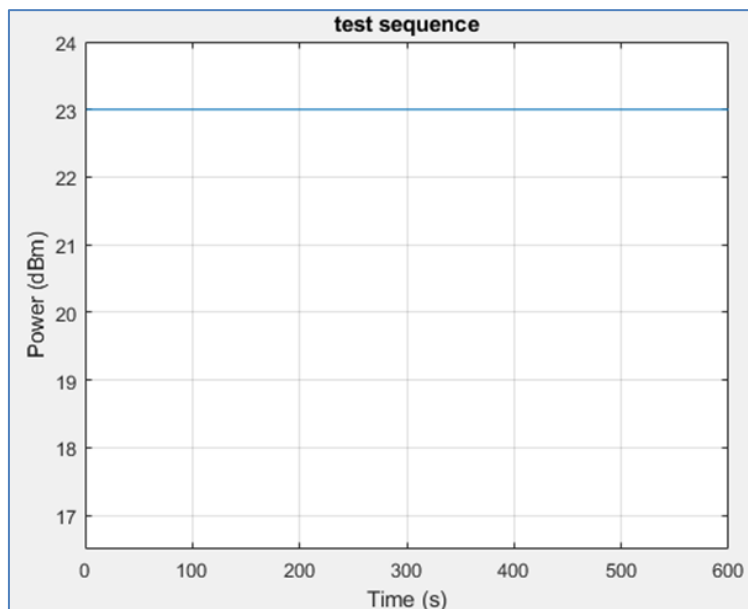

Table 4-2: Test Sequence

Start Time (s)	Duration (s)	Power (dBm)	Note
0	600	23.0	Wi-Fi TX maximum power (P_WF_SAR_MAX)

4.2. Test Procedure for Scenario 1: TX Mode Change via Conducted Power Measurements

4.2.1. Configuration

The scenario tests Wi-Fi TX mode switching from normal throughput mode to sleep mode. Since *MediaTek's* TA-SAR feature operation is independent of bands and channels, selecting one band is sufficient to validate this feature. The criteria for band selection are based on the $P_{WF_SAR_limit}$ values (corresponding to $WF_SAR_design_limit$) and are described as below:

- Select one band / channel with least $P_{WF_SAR_limit}$ among all supported bands and the $P_{WF_SAR_limit}$ value is below $P_{WF_SAR_MAX}$.
 - [1] Only one band / channel needs to be tested if all the bands have the same $P_{WF_SAR_limit}$.
 - [2] Only one band / channel needs to be tested if only one band has $P_{WF_SAR_limit}$ below $P_{WF_SAR_MAX}$.
 - [3] If the same least $P_{WF_SAR_limit}$ applies to multiple bands, select the band with the highest measured 1g-SAR at $P_{WF_SAR_limit}$.
 - [4] If $P_{WF_SAR_limit}$ values of all bands are over $P_{WF_SAR_MAX}$, there is no need to test these bands.

4.2.2 Procedure

The TX power is measured, recorded, and processed by the following steps. The Steps 1 to 4 is to measure and record TX power versus time for test scenario 1, and Step 5 is to convert the measured conducted TX power into SAR.

Step 1: Start $P_{WF_SAR_limit}$ calibration mode and measure $P_{WF_SAR_limit}$ for the selected band.

Step 2: Establish radio link with AP in the selected band and enable TA-SAR.

Step 3: Configure pre-defined TX power sequence to DUT and measure TX power versus time.

Step 4: Wi-Fi TX switches modes.

Initial Wi-Fi Normal Mode:

Configure pre-defined TX power sequence to DUT for selected band and then DUT transmits packets after 400s.

Switch to Wi-Fi Sleep Mode:

Wi-Fi switches to sleep mode about 10s and no packets are transmitted.

Wi-Fi Wakes Up to Normal Mode:

Wi-Fi wakes up from sleep mode and DUT re-transmits packets for at least the specified time duration.

Step 5: Convert the measured conducted TX power from Step 4 into 1g-SAR or 10g-SAR value using the following equation. Perform the running time average to power and 1g-SAR or 10g-SAR to determine time-averaged value versus time as follows.

Instantaneous 1g-SAR or 10g-SAR versus time:

$$SAR(t) = \frac{\text{conducted_inst_SAR_TX_power}(t)}{P_{WF_SAR_limit}} \times WF_SAR_design_limit$$

where $P_{WF_SAR_limit}$ is measured from step 1 and $WF_SAR_design_limit$ is measured worst-case SAR value at $P_{WF_SAR_limit}$.

Time average SAR versus time:

$$Time_avg_SAR(t) = \frac{1}{T_{SAR}} \int_{t-T_{SAR}}^t SAR(t) dt$$

Step 6: Plot results:

- A. Make one power perspective plot containing.
 - [1] Instantaneous TX power.
 - [2] Requested power (test sequence).
 - [3] Calculated time-averaged power.
 - [4] Calculated time-averaged power limits.
- B. Make one SAR perspective plot containing.
 - [1] Calculated time-averaged 1g-SAR or 10g-SAR.
 - [2] FCC limit of 1.6 W/kg (1g-SAR) or 4.0 W/kg (10g-SAR).

4.3. Test Procedure for Scenario 2: Band Handover via Conducted Power Measurements

4.3.1. Configuration

The scenario tests Wi-Fi 2.4 GHz and 5 GHz band handover and DBDC mode. The test configuration switches from Wi-Fi 2.4 GHz band to Wi-Fi 5 GHz band and then switches to 2.4 GHz / 5 GHz DBDC mode.

- For Wi-Fi 2.4 GHz band, select the channel with least $P_{WF_SAR_limit}$ value and below $P_{WF_SAR_MAX}$. If the same least $P_{WF_SAR_limit}$ applies to multiple bands, select the channel with the highest measured 1g-SAR at $P_{WF_SAR_limit}$.
- For Wi-Fi 5 GHz band, select the channel with least $P_{WF_SAR_limit}$ value and below $P_{WF_SAR_MAX}$. If the same least $P_{WF_SAR_limit}$ applies to multiple bands, select the channel with the highest measured 1g-SAR at $P_{WF_SAR_limit}$.

4.3.2 Procedure

The TX power is measured, recorded, and processed by the following steps. The Steps 1 to 4 is to measure and record TX power versus time for test scenario 2, and the Step 5 is to convert the measured conducted TX power into SAR.

Step 1: Start $P_{WF_SAR_limit}$ calibration mode and measure $P_{WF_SAR_limit}$ for both the selected bands / channels. (2.4 GHz and 5 GHz)

Step 2: Establish radio link with AP in the selected band and enable TA-SAR.

Step 3: Configure pre-defined TX power sequence to DUT and measure TX power versus time.

Step 4: Wi-Fi TX switches bands.

Initial 2.4 GHz Band Connection:

Configure pre-defined TX power sequence to DUT for 2.4 GHz band and then DUT transmits packets for 400s.

Band Switch to 5 GHz Band Connection:

Wi-Fi switches to the 5 GHz band for 400s.

Dual Band Mode (DBDC) Connection:

Wi-Fi connects to 2.4 GHz and 5 GHz bands simultaneously for 400s.

Step 5: Convert the measured conducted TX power from Step 4 into 1g-SAR or 10g-SAR value using the following equation. Perform the running time average to power and 1g-SAR or 10g-SAR to determine time-averaged value versus time as follows.

Instantaneous 1g-SAR or 10g-SAR versus time:

$$SAR_1(t) = \frac{conducted_inst_SAR_TX_power_1(t)}{P_{WF_SAR_limit_1}} \times WF_SAR_design_limit_1$$

$$SAR_2(t) = \frac{conducted_inst_SAR_TX_power_2(t)}{P_{WF_SAR_limit_2}} \times WF_SAR_design_limit_2$$

where $P_{WF_SAR_limit_1}$ and $P_{WF_SAR_limit_2}$ are measured from step 1, $WF_SAR_design_limit_1$ and $WF_SAR_design_limit_2$ are measured worst-case SAR values at $P_{WF_SAR_limit_1}$ and $P_{WF_SAR_limit_2}$, respectively.

Time average SAR versus time:

$$Time_avg_SAR(t) = \frac{1}{T_{SAR}} \left[\frac{\int_{t-T_{SAR}}^t SAR_1(t) dt}{WF_SAR_REG_limit_1} + \frac{\int_{t-T_{SAR}}^t SAR_2(t) dt}{WF_SAR_REG_limit_2} \right]$$

Step 6: Plot results:

- A. Make one power perspective plot containing.
 - [1] Instantaneous TX power.
 - [2] Requested power.
 - [3] Calculated time-averaged power.
 - [4] Calculated time-averaged power limits.
- B. Make one SAR perspective plot containing.
 - [1] Calculated time-averaged 1g-SAR or 10g-SAR.
 - [2] FCC limit of 1.6 W/kg (1g-SAR) or 4.0 W/kg (10-gSAR).
 - [3] Normalized time-averaged 1g-SAR / 1.6 or 10g-SAR / 4.0.

4.4. Test Procedure for Scenario 3: Antenna Switching via Conducted Power Measurements

4.4.1. Configuration

Wi-Fi first selects an antenna to transmit packets then switches to another antenna within the same band. For any band supporting multiple TX antennas, select the one with the highest difference in $P_{WF_SAR_limit}$ among all supported antennas.

- Select the band having the highest measured 1g-SAR at $P_{WF_SAR_limit}$ if multiple bands having the same $P_{WF_SAR_limit}$ among supported antennas.
- Antenna selection order:
 - [1] Select the configuration with 2 antennas having $P_{WF_SAR_limit}$ values less than $P_{WF_SAR_MAX}$.
 - [2] If the previous configuration does not exist, select the configuration with one antenna having $P_{WF_SAR_limit}$ value less than $P_{WF_SAR_MAX}$.
 - [3] If the above two cannot be found, select one configuration with the two antennas having the least difference between their $P_{WF_SAR_limit}$ and $P_{WF_SAR_MAX}$.

4.4.2 Procedure

The TX power is measured, recorded, and processed by the following steps. The Steps 1 to 4 is to measure and record TX power versus time for test scenario 3, and the Step 5 is to convert the measured conducted TX power into SAR.

Step 1: Start $P_{WF_SAR_limit}$ calibration mode and measure $P_{WF_SAR_limit}$ for both the selected antennas.

Step 2: Establish radio link with AP in the selected band and enable TA-SAR.

Step 3: Configure pre-defined TX power sequence to DUT and measure TX power versus time.

Step 4: Wi-Fi TX switches antennas.

Connect to One Selected Antenna:

Configure pre-defined TX power sequence to DUT for selected band and selected antenna and then DUT transmits packets for 400s.

Switch to Another Antenna:

Wi-Fi TX switches to another selected antenna and DUT transmits packets for 400s.

Step 5: Convert the measured conducted TX power into SAR based on the formulas for scenario 1.

Step 6: Plot results:

- A. Make one power perspective plot containing.
 - [1] Instantaneous TX power.
 - [2] Requested power.
 - [3] Calculated time-averaged power.
 - [4] Calculated time-averaged power limits.
- B. Make one SAR perspective plot containing
 - [1] Calculated time-averaged 1g-SAR or 10g-SAR.
 - [2] FCC limit of 1.6 W/kg (1g-SAR) or 4.0 W/kg (10g-SAR).
 - [3] Normalized time-averaged 1g-SAR / 1.6 or 10g-SAR / 4.0.

It is noted that the following operations are done as well for this scenario:

- The correct power control is realized by TA-SAR algorithm when antenna switches from one to another.
- The validation criteria are, at all times, the time-averaged 1g-SAR or 10g-SAR versus time shall not exceed FCC limit of 1.6 W/kg for 1g-SAR or 4.0 W/kg for 10g-SAR.

4.5. Test Procedure for Scenario 4: ECI Change via Conducted Power Measurements

4.5.1. Configuration

The scenario tests the time-averaged TX power is less than the predefined TX limit at all times when exposure condition index changes which means $P_{WF_SAR_limit}$ changes in the test. This scenario selects any one band having two different $P_{WF_SAR_limit}$ values less than $P_{WF_SAR_MAX}$ in the two ECI groups. One test is sufficient as the feature operation is independent of technology and band.

4.5.2 Procedure

The TX power is measured, recorded, and processed by the following steps. The Steps 1 to 4 is to measure and record TX power versus time for test scenario 4, and the Step 5 is to convert the measured conducted TX power into SAR.

Step 1: Start $P_{WF_SAR_limit}$ calibration mode and measure $P_{WF_SAR_limit}$ for the selected band / channel.

Step 2: Establish radio link with AP in the selected band and enable TA-SAR.

Step 3: Configure pre-defined TX power sequence to DUT and measure TX power versus time.

Step 4: Wi-Fi TX ECI changes.

Connect to Selected Band with Initial $P_{WF_SAR_limit}$ in One ECI Group Index:

Configure pre-defined TX power sequence to DUT for selected band and then DUT transmits packets for 400s.

Change $P_{WF_SAR_limit}$ value to Another ECI Group Index:

Set the command to change $P_{WF_SAR_limit}$ for 400s

Step 5: Convert the measured conducted TX power into SAR based on the formulas for scenario 1.

Step 6: Plot results:

A. Make one power perspective plot containing.

- [1] Instantaneous TX power.
- [2] Requested power.
- [3] Calculated time-averaged power.
- [4] Calculated time-averaged power limits.

B. Make one SAR perspective plot containing.

- [1] Calculated time-averaged 1g-SAR or 10g-SAR.
- [2] FCC limit of 1.6 W/kg (1g-SAR) or 4.0 W/kg (10g-SAR).
- [3] Normalized time-averaged 1g-SAR / 1.6 or 10g-SAR / 4.0.

It is noted that the following operations are done as well for this scenario:

- The correct power control is controlled by TA-SAR when ECI switches from one to another.
- The validation criteria are, at all times, the time-averaged 1g-SAR or 10g-SAR versus time shall not exceed FCC limit of 1.6 W/kg for 1g-SAR or 4.0 W/kg for 10g-SAR.

4.6. Test Procedure for Scenario 5: Simultaneous SAR & PD via Conducted Power Measurements

4.6.1. Configuration

The scenario is to test TER (Total Exposure Ratio) under 2.4 GHz band and 6 GHz band simultaneous transmission. Since Wi-Fi 6 GHz band needs to obey both SAR and PD exposure limits, the maximum of normalized TA-SAR and normalized TA-PD in 6 GHz band should be used in TER calculation. The proposed algorithms can ensure TA-SAR / TA-PD control correctness by demonstrating that TER is less than or equal to 1.

- Select one channel of Wi-Fi 2.4 GHz band with measured $P_{WF_SAR_limit}$ less than $P_{WF_SAR_MAX}$ and select one channel of Wi-Fi 6 GHz band with measured $P_{WF_SAR_limit}$ less than $P_{WF_SAR_MAX}$ and with measured $P_{WF_PD_limit}$ less than $P_{WF_PD_MAX}$.

4.6.2 Procedure

The Steps 1 to 4 is to measure and record TX power versus time for test scenario 5, and the Step 5 is to convert the measured conducted TX power into SAR, PD and calculate TER.

Step 1: Start $P_{WF_SAR_limit}$ and $P_{WF_PD_limit}$ calibration mode, measure $P_{WF_SAR_limit}$ for the selected 2.4 GHz band, and measure $P_{WF_SAR_limit}$ and $P_{WF_PD_limit}$ for the selected 6 GHz band channel.

Step 2: Establish link with AP for the selected band and enable TA-SAR and TA-PD.

Step 3: Configure pre-defined TX power sequence to DUT and measure TX power versus time.

Step 4: Wi-Fi transmits packets at 2.4 GHz band and 6 GHz band.

Step 5: Convert the measured conducted TX power into SAR, PD and calculate TER.

For TA-SAR of each 2.4 GHz, 5 GHz, or 6 GHz band:

$$SAR_{n,normalized} = \frac{SAR_{n,avg}}{SAR_{n,limit}} = \frac{\frac{1}{T_{SAR_n}} \int_{t-T_{SAR_n}}^t SAR_n(t) dt}{SAR_REG_limit_n}$$

For TA-PD of each band at 6 GHz band:

$$PD_{m,normalized} = \frac{PD_{m,avg}}{PD_{m,limit}} = \frac{\frac{1}{T_{APD_m}} \int_{t-T_{APD_m}}^t PD_m(t) dt}{PD_REG_limit_m}$$

Instantaneous 1g-SAR or 10g-SAR versus time:

$$SAR(t) = \frac{conducted_inst_SAR_TX_power(t)}{P_{WF_SAR_limit}} \times WF_SAR_design_limit$$

$$PD(t) = \frac{conducted_inst_PD_TX_power(t)}{P_{WF_PD_limit}} \times WF_PD_design_limit$$

where $P_{WF_SAR_limit}$ is measured from step 1 and $WF_SAR_design_limit$ is measured worst-case SAR value at $P_{WF_SAR_limit}$, and $P_{WF_PD_limit}$ is measured from step 1 and $WF_PD_design_limit$ is measured worst-case PD value at $P_{WF_PD_limit}$.

For simultaneous transmission, the sum of the normalized TA-SAR values in 2.4 GHz and 5 GHz bands together with the sum of the values of the maximum of normalized TA-SAR and normalized TA-PD in 6 GHz band should meet TER requirement, as shown below.

$$TER = \sum_{n=1}^M \frac{SAR_{n,avg}}{SAR_{n,limit}} (2GHz/5GHz) + \sum_{m=M+1}^N \max \left[\frac{SAR_{m,avg}}{SAR_{m,limit}}, \frac{PD_{m,avg}}{PD_{m,limit}} \right] (6GHz) \leq 1$$

Step 6: Plot results:

- A. Make one power perspective plot containing.
 - [1] Instantaneous Tx power.
 - [2] Requested power.
 - [3] Calculated time-averaged power.
 - [4] Calculated time-averaged power limits.
- B. Make one SAR / PD perspective plot containing.
 - [1] Calculated normalized time-averaged 1g-SAR or 10g-SAR for 2.4 GHz band.
 - [2] Calculated maximum of normalized time-averaged SAR (1g-SAR or 10g-SAR) and normalized time-averaged PD for 6 GHz band.
 - [3] Total Exposure Ratio (TER).
 - [4] FCC TER limit of 1.

4.7. Test Procedure for Scenario 1: TX Mode Change via SAR Measurements

4.7.1. Configuration

The test procedures in the previous sections (sections 4.2 to 4.6) mainly focus on measuring conducted TX power, in this section test via SAR measurement is performed. The validation can be provided by performing one test scenario from the previous section.

In this test via SAR measurement, the test configuration of test scenario 1 in section 4.2.1 is used.

4.7.2 Procedure

SAR is measured and recorded by the following steps. The Steps 1 to 3 is to measure and record TA-SAR versus time for test scenario 1, and the Step 4 is to convert the measured SAR into time-averaged SAR.

- Step 1:** Start $meas_SAR_{P_{WF_SAR_limit}}$ calibration mode for the selected band / channel. Measure $meas_SAR$ at peak location of the area scan where $meas_SAR_{P_{WF_SAR_limit}}$ corresponds to this $meas_SAR$ value at $P_{WF_SAR_limit}$.
- Step 2:** Establish radio link with AP in the selected band and enable TA-SAR.
- Step 3:** Configure pre-defined TX power sequence to DUT and measure instantaneous SAR versus time.
- Step 4:** Convert the instantaneous measured SAR from step 3 into 1g-SAR or 10g-SAR value. Perform the running time average to 1g-SAR or 10g-SAR to determine the time-averaged value versus time by the following equations.

Instantaneous 1g-SAR or 10g-SAR versus time:

$$SAR(t) = \frac{meas_SAR(t)}{meas_SAR_{P_{WF_SAR_limit}}} \times WF_SAR_design_limit$$

where $meas_SAR_{P_{WF_SAR_limit}}$ is measured from step 1, $meas_SAR(t)$ is the instantaneous SAR measured in step 3, and $WF_SAR_design_limit$ is the measured worst-case SAR value at $P_{WF_SAR_limit}$.

Time average SAR versus time:

$$Time_avg_SAR(t) = \frac{1}{T_{SAR}} \int_{t-T_{SAR}}^t SAR(t) dt$$

- Step 5:** Plot results:
 - A. Calculated time-averaged 1g-SAR or 10g-SAR.
 - B. FCC limit of 1.6 W/kg (1g-SAR) or 4.0 W/kg (10g-SAR).

5. Wi-Fi TA-PD Test Scenarios and Test Procedures

In order to demonstrate that TA-PD algorithm performs as expected under various operating scenarios, Table 5-1 lists the test scenario to validate TA-PD algorithm. The details of test procedures via conducted power and PD measurements are described in section 5.2 and 5.3.

Table 5-1: Test Scenario List for Wi-Fi TA-PD Validation

Test Scenario	Description	Device Requirement	Test Required for this DUT
1. TX Mode Change	Test normal mode and sleep mode switch	Supports 6 GHz band	YES

5.1. Test Sequence for All Scenarios

The test sequence is predefined for TA-PD.

Test Sequence: Wi-Fi TX is requested to transmit static and maximum power with high duty.

The test sequence is illustrated in Figure 5-1. The waveform of the test sequence is listed in Table 5-2.

Figure 5-1: Test Sequence

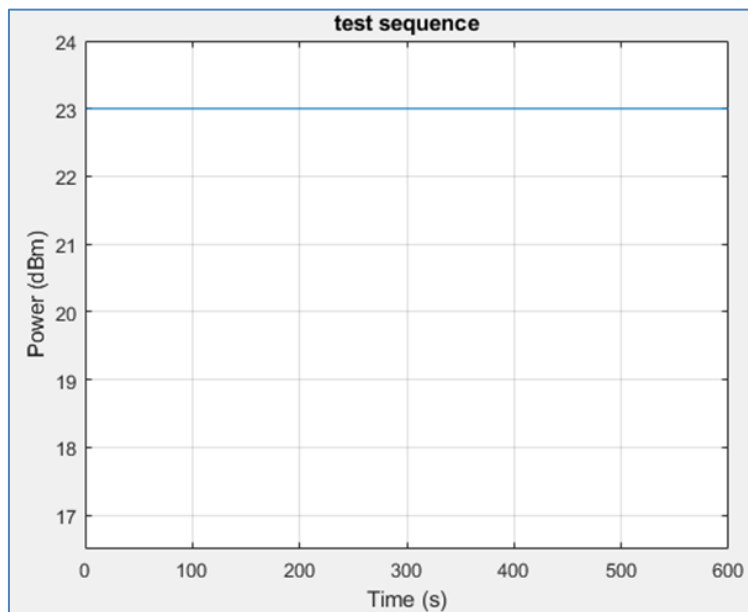

Table 5-2: Test Sequence

Start Time (s)	Duration (s)	Power (dBm)	Note
0	600	23.0	Wi-Fi TX maximum power (P_WF_PD_MAX)

5.2. Test Procedure for Scenario 1: TX Mode Change via Conducted Power Measurements

5.2.1. Configuration

The scenario tests Wi-Fi TX mode switching from normal throughput mode to sleep mode. Since *MediaTek's* TA-PD feature operation is independent of bands and channels, selecting one band is sufficient to validate this feature. The criteria for band selection are based on the $P_{WF_PD_limit}$ values (corresponding to $WF_PD_design_limit$) and are described as below:

- Select one band with least $P_{WF_PD_limit}$ among the ones whose $P_{WF_PD_limit}$ values are below $P_{WF_PD_MAX}$.
 - [1] Only one band needs to be tested if all the bands have same $P_{WF_PD_limit}$.
 - [2] Only one band needs to be tested if only one band has $P_{WF_PD_limit}$ below $P_{WF_PD_MAX}$.
 - [3] If the same least $P_{WF_PD_limit}$ applies to multiple bands, select the band with the highest measured PD at $P_{WF_PD_limit}$.
 - [4] If $P_{WF_PD_limit}$ values of all bands are over $P_{WF_PD_MAX}$, there is no need to test these bands.

5.2.2 Procedure

The TX power is measured, recorded, and processed by the following steps. The Steps 1 to 4 is to measure and record TX power versus time for test scenario 1, and the Step 5 is to convert the measured conducted TX power into PD.

Step 1: Start $P_{WF_PD_limit}$ calibration mode and measure $P_{WF_PD_limit}$ for the selected band.

Step 2: Establish radio link with AP in the selected band and enable TA-PD.

Step 3: Configure pre-defined TX power sequence to DUT and measure TX power versus time.

Step 4: Wi-Fi TX switches modes.

Initial Wi-Fi Normal Mode:

Configure pre-defined TX power sequence to DUT for selected band and then DUT transmits packets for 400s.

Switch to Wi-Fi Sleep Mode:

Wi-Fi switches to sleep mode about 10s and no packets are transmitted.

Wi-Fi Wakes Up to Normal Mode:

Wi-Fi wakes up from sleep mode and DUT re-transmits packets for at least the specified time duration.

Step 5: Convert the measured conducted TX power from Step 4 into spatial-averaged PD value using the following equation. Perform the running time average to power and spatial-averaged PD value to determine time-averaged value versus time as follows.

Instantaneous PD versus time:

$$PD(t) = \frac{\text{conducted_inst_PD_TX_power}(t)}{P_{WF_PD_limit}} \times WF_PD_design_limit$$

where $P_{WF_PD_limit}$ is measured from step 1 and $WF_PD_design_limit$ is measured worst-case PD value at $P_{WF_PD_limit}$.

Time-averaged PD versus time:

$$Time_avg_PD(t) = \frac{1}{T_{PD}} \int_{t-T_{PD}}^t PD(t) dt$$

Step 6: Plot results:

- A. Make one power perspective plot containing.
 - [1] Instantaneous Tx power.
 - [2] Requested power.
 - [3] Calculated time-averaged power.
 - [4] Calculated time-averaged power limits.
- B. Make one SAR perspective plot containing
 - [1] Calculated time-averaged PD.
 - [2] FCC limit of 10 W/m² (PD).

5.3. Test Procedure for Scenario 1: TX Mode Change via Power Density Measurements

5.3.1. Configuration

The test procedure in the previous section (section 5.2) mainly focuses on measuring conducted TX power, in this section test via PD measurement is performed. The validation can be provided by performing test scenario 1.

5.3.2 Procedure

PD is measured and recorded by the following steps. The Steps 1 to 3 is to measure and record TA-PD versus time for test scenario 1, and the Step 4 is to convert the measured PD into time-averaged PD.

- Step 1:** Start $meas_PD_P_{WF_PD_limit}$ calibration mode for the selected band/channel. Measure $meas_PD$ at peak location of the area scan and the $meas_PD_P_{WF_PD_limit}$ corresponds to this $meas_PD$ value at $P_{WF_PD_limit}$.
- Step 2:** Establish radio link with AP in the selected band and enable TA-PD.
- Step 3:** Configure pre-defined TX power sequence to DUT and measure instantaneous PD versus time.
- Step 4:** Convert the instantaneous measured PD from step 3 into spatial-averaged PD value. Perform the running time average to spatial-averaged PD value to determine time-averaged value versus time by following equations.

Instantaneous PD versus time:

$$PD(t) = \frac{meas_PD(t)}{meas_PD_P_{WF_PD_limit}} \times WF_PD_design_limit$$

where $meas_SAR_P_{WF_PD_limit}$ is measured from step 1, $meas_PD(t)$ is the instantaneous measured PD measured in step 3, and $WF_PD_design_limit$ is the measured worst-case PD value at $P_{WF_PD_limit}$.

Time-averaged PD versus time:

$$Time_avg_PD(t) = \frac{1}{T_{PD}} \int_{t-T_{PD}}^t PD(t) dt$$

Step 5: Plot results:

- A. Calculated time-averaged PD.
- B. FCC limit of 10 W/m² (PD).

6. Wi-Fi TA-SAR Validation via Conducted Power Measurement

6.1. Measurement Setup

The general measurement setup for Windows DUT is shown in *Figure 6-1*. The TA-SAR control program is executed in DUT which controls DUT and peer devices that act as soft-AP or STA. The WLAN traffic is established between peer devices and DUT, e.g., an engineering model of smartphone. The traffic from DUT TX is UDP and controlled by control PC.

The test sequence and scenarios are controlled by PC command. The transmitter power is measured with spectrum analyzers. There are two peer devices and two spectrum analyzers to support test scenarios with multiple operation frequencies. Furthermore, the moving average of each measured power is calculated to ensure the conductive time-averaging power is always below the power limit threshold.

The test measurement setup for test scenarios 1 and 4 is illustrated in *Figure 6-2*. The test measurement setup for test scenarios 2 and 5 is illustrated in *Figure 6-3*. The test measurement setup for test scenario 3 is illustrated in *Figure 6-4*. Note that for test scenario 3, an RF attenuator is added to the conductive path to provide proper attenuation from DUT to AP and DUT to spectrum analyzer.

Figure 6-1: General Setup for TA-SAR Conducted Power Measurement

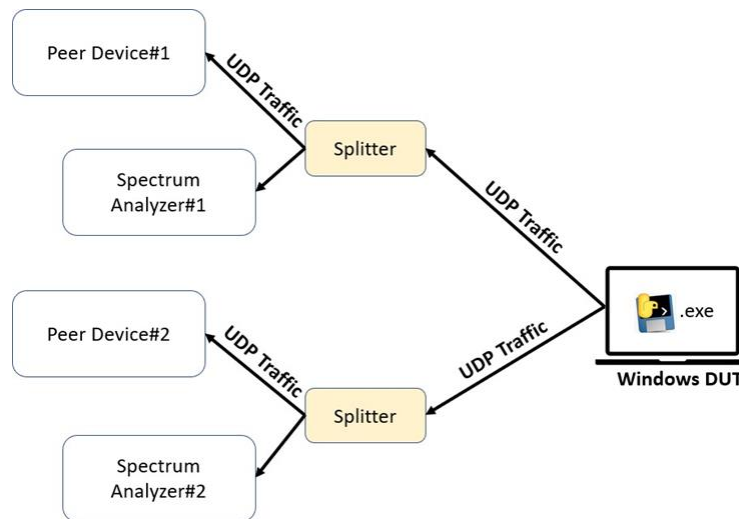

Figure 6-2: TA-SAR Conducted Power Test Setup for Test Scenarios 1 and 4

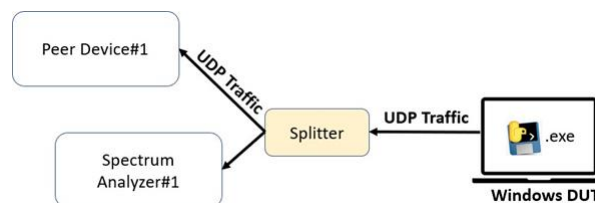

Figure 6-3: TA-SAR Conducted Power Test Setup for Test Scenarios 2 and 5

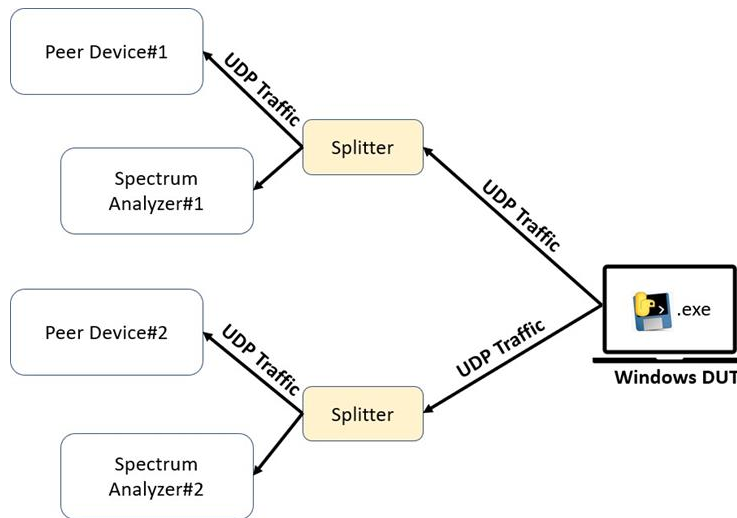
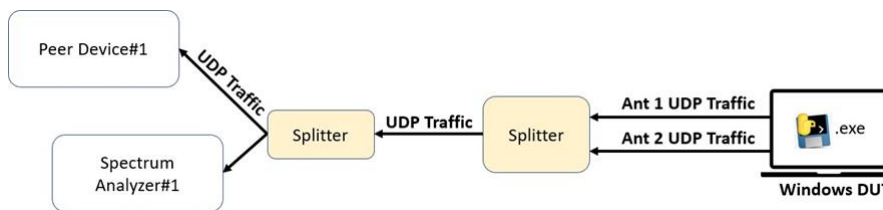

Figure 6-4: TA-SAR Conducted Power Test Setup for Test Scenario 3



Spectral analyzer utilizing zero-span mode is used for monitoring the time-domain conductive power of the DUT. This spectral analyzer may be replaced by a power probe or other time-domain power logging instrument as well. The detailed setup of the spectral analyzer is shown as follow:

- Center Frequency :** WLAN channel frequency
- Span :** Zero span
- RBW :** Spectral analyzer’s maximum capability
- VBW :** = RBW
- Sweep Time :** 1400s
- Sweep Point :** 10 times of sweep time + 1 = 14001
- Detector mode :** RMS
- Trace Mode :** Single hold (clear write)

Since the WLAN data bandwidth (ex. 20 MHz) is larger than the max resolution bandwidth of spectral analyzer, a power correlation method is essential to determine the actual conductive channel power (per data bandwidth occupied) from the readout of the spectral analyzer (in terms of power density dBm / RBW).

The correlation term that accounts for the conductive power to spectral analyzer readout and RF cable loss is obtained with the following steps:

- [1] Setup the TA-SAR conductive measurement as shown in *Figure 6-1* to *Figure 6-4*.
- [2] Configure DUT to MTK engineering mode and set DUT to continuous packet TX mode (duty cycle $\geq 98\%$) with TX information such as WLAN channel, rate, and TX power.
- [3] Determine the power correlation term as

$$\mathit{Corr.} = \mathit{DUT TX power} - \mathit{measured power of the spectral analyzer}$$

The readout of the spectral analyzer is thus correlated to the actual conductive channel power at the DUT output port by arithmetically adding *Corr.* to the raw data in mW domain.

In control PC, an executable file named *MTK_WiFi_TASAR.exe* controls the test of TA-SAR / TA-PD according to different test scenarios. It controls the connections between DUT and peer devices, controls test sequence according to the selected test scenario, starts the UDP traffic from DUT, and pulls the logs from DUT.

6.2. Conducted Power Measurement Results for Scenario 1: Tx Mode Change

This test is the conducted power measurement for Wi-Fi 2.4 GHz band and 6 GHz band TX mode change. The detailed setting is listed in Table 6-1 and Table 6-2. Figure 6-5 and Figure 6-6 demonstrates the DUT’s instantaneous conducted TX power, the time-averaged conducted TX power behavior over time, and the power limit for scenario 1-1 and 1-2. As seen in this figure, the time-averaged SAR does not exceed the FCC limit.

Table 6-1: TA-SAR Parameters Setting for Wi-Fi Test Scenario 1-1

Test Band	Max Power (dBm)	$P_{WF\ SAR\ limit}$ (dBm)	Validation Result
2.4 GHz	22.5	15.5	Pass

Figure 6-5: Time-Averaged Conducted TX Power Over Time for Wi-Fi Test Scenario 1-1

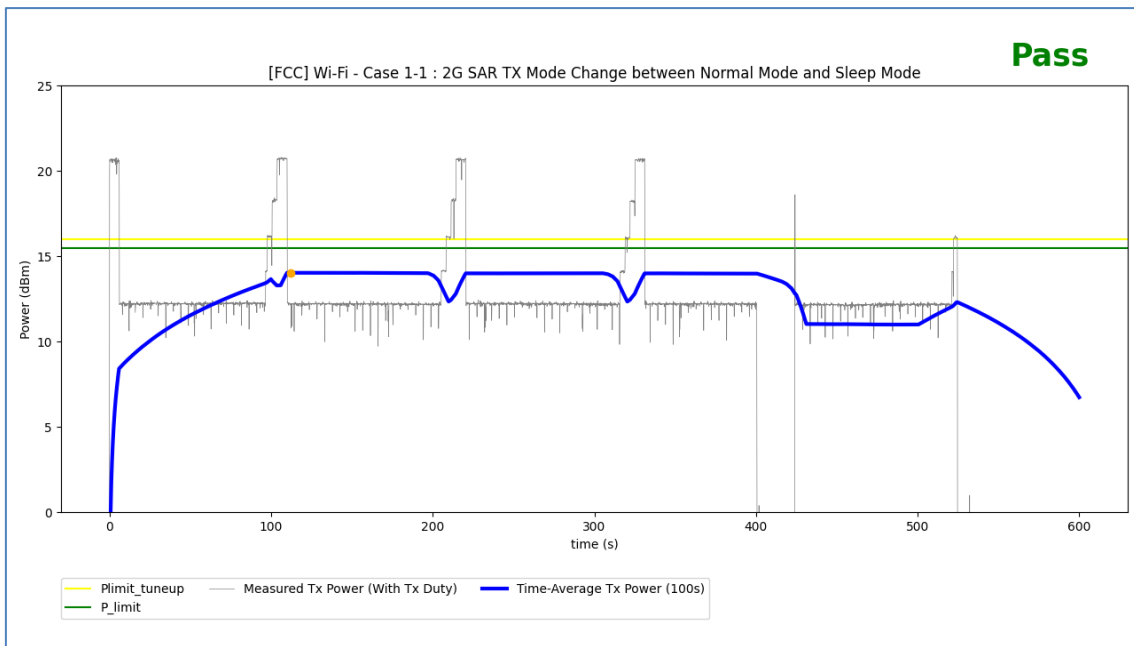
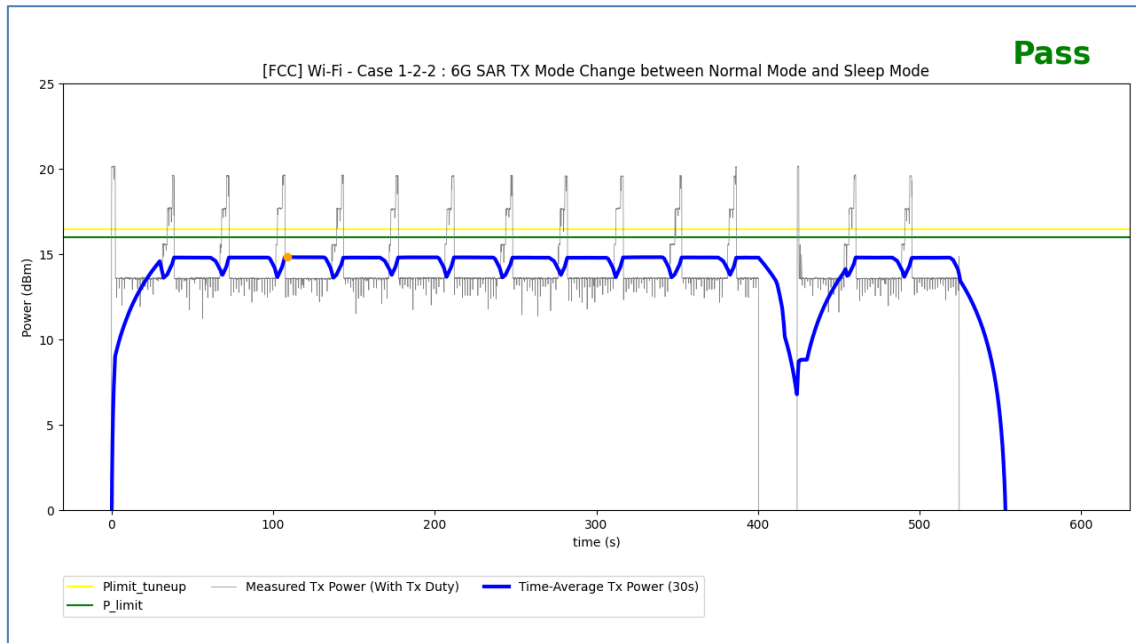

Table 6-2: TA-SAR Parameters Setting for Wi-Fi Test Scenario 1-2

Test Band	Max Power (dBm)	$P_{WF_SAR\ limit}$ (dBm)	Validation Result
6 GHz	21.5	16.0	Pass

Figure 6-6: Time-Averaged Conducted TX Power Over Time for Wi-Fi Test Scenario 1-2



6.3. Conducted Power Measurement Results for Scenario 2: Band Handover

This test is the conducted power measurement for Wi-Fi 2.4 GHz / 5 GHz band handover. The detailed setting is listed in Table 6-3. Figure 6-7 demonstrates the DUT's instantaneous conducted TX power, the time-averaged conducted TX power behavior over time, and the power limit. Figure 6-8 illustrates the corresponding time-averaged SAR over time converted from the TX time-averaged power by using the equation listed in section 4.3.2. As seen in this figure, the normalized time-averaged SAR does not exceed the FCC limit.

Table 6-3: TA-SAR Parameters Setting for Wi-Fi Test Scenario 2

Test Band	Switch Time (second)	Max Power (dBm)	$P_{WF\ SAR\ limit}$ (dBm)	Validation Result
2.4 GHz	0 to 400	22.5	15.5	Pass
5 GHz	400 to 800	22.5	14.0	
2.4 GHz + 5 GHz	800 to 1200	22.5 / 22.5	14.0	

Figure 6-7: Time-Averaged Conducted TX Power Over Time for Wi-Fi Test Scenario 2

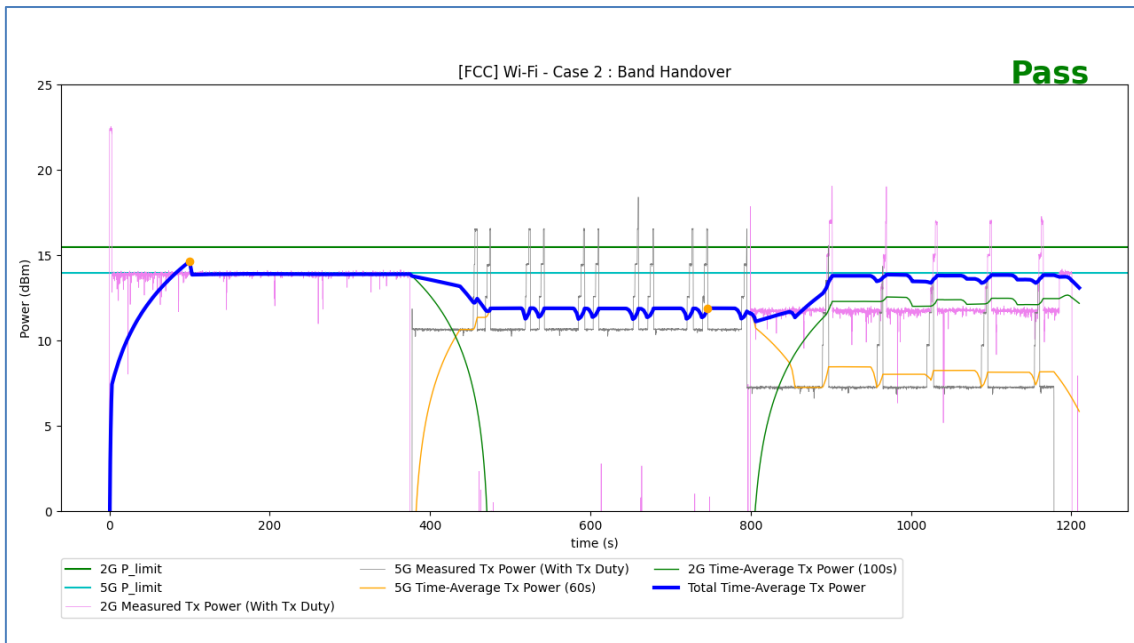
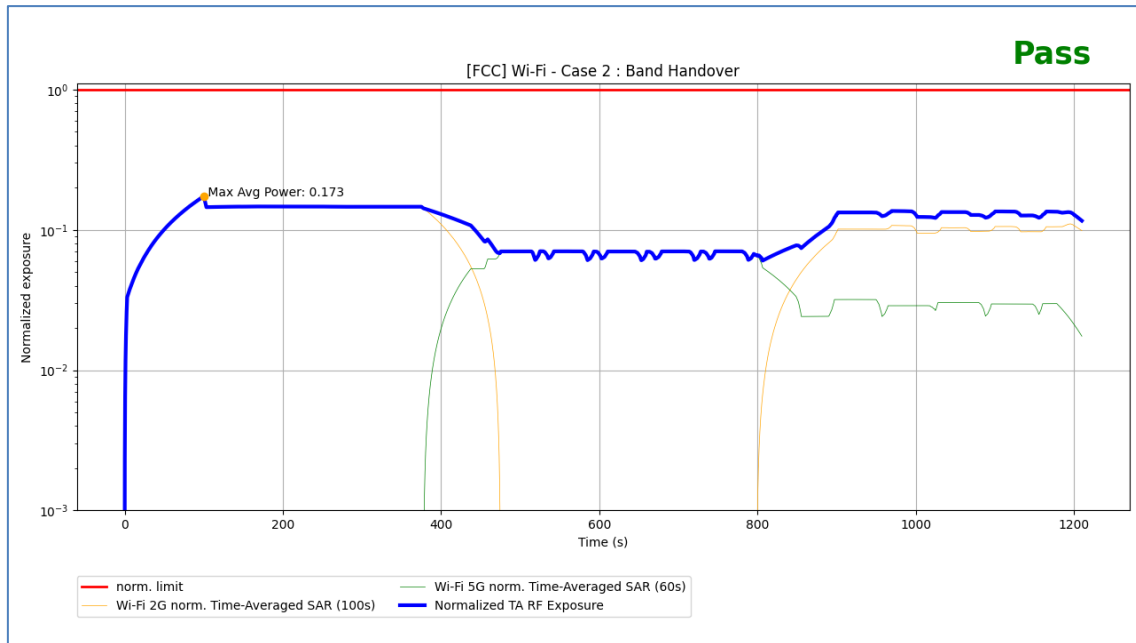

Figure 6-8: Normalized Time-Averaged SAR Over Time for Wi-Fi Test Scenario 2



6.4. Conducted Power Measurement Results for Scenario 3: Antenna Switching

This test is the conducted power measurement for Wi-Fi antenna switching. The detailed setting is listed in Table 6-4. Figure 6-9 demonstrates the DUT's instantaneous conducted TX power, the time-averaged conducted TX power behavior over time, and the power limit. Figure 6-10 illustrates the corresponding time-averaged SAR over time converted from the TX time-averaged power by using the equation listed in section 4.4.2. As seen in this figure, the normalized time-averaged SAR does not exceed the FCC limit.

Table 6-4: TA-SAR Parameters Setting for Wi-Fi Test Scenario 3

Antenna	Test Band	Switch Time (second)	Max Power (dBm)	$P_{WF\ SAR\ limit}$ (dBm)	Validation Result
0	2.4 GHz	0 to 400	22.5	15.5	Pass
1	2.4 GHz	400 to 800	22.5	15.5	

Figure 6-9: Time-Averaged Conducted TX Power Over Time for Wi-Fi Test Scenario 3

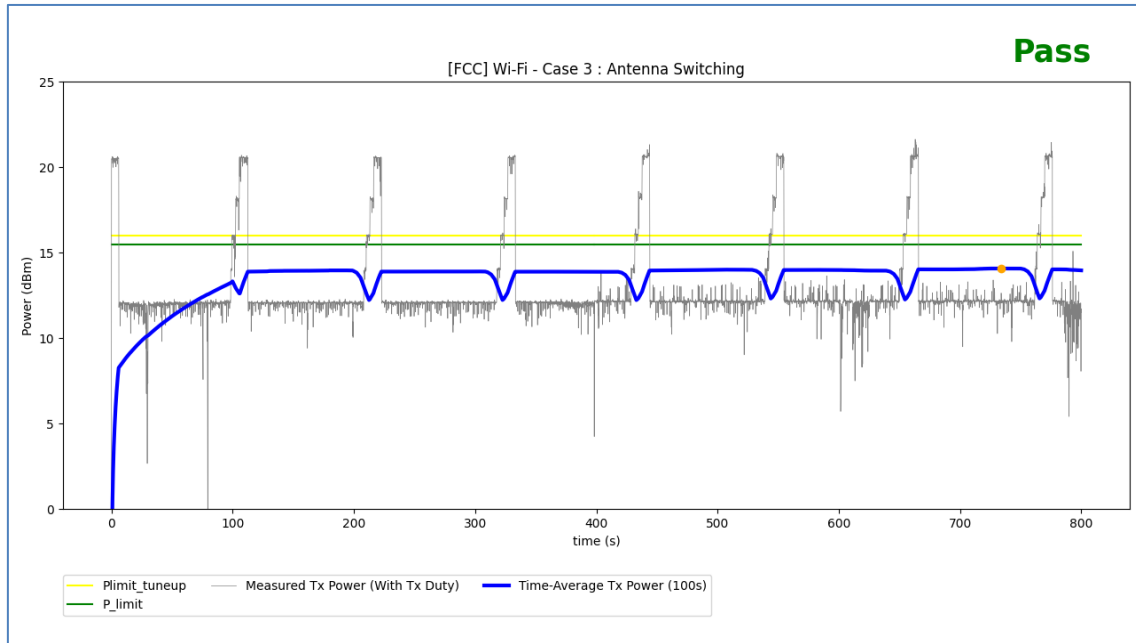
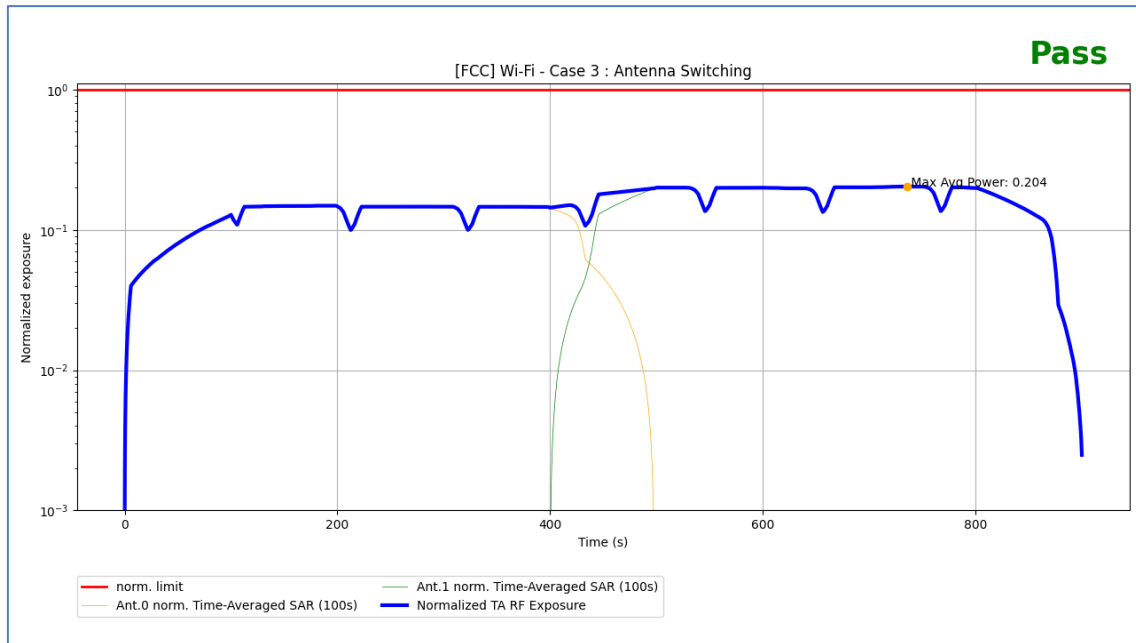

Figure 6-10: Normalized Time-Averaged SAR Over Time for Wi-Fi Test Scenario 3



6.5. Conducted Power Measurement Results for Scenario 4: ECI Change

This test is the conducted power measurement for Wi-Fi ECI change. The detailed setting is listed in Table 6-5. Figure 6-11 demonstrates the DUT's instantaneous conducted TX power, the time-averaged conducted TX power behavior over time, and the power limit. Figure 6-12 illustrates the corresponding time-averaged SAR over time converted from the TX time-averaged power by using the equation listed in section 4.5.2. As seen in this figure, the normalized time-averaged SAR does not exceed the FCC limit.

Table 6-5: TA-SAR Parameters Setting for Wi-Fi Test Scenario 4

ECI	Test Band	Switch Time (second)	Max Power (dBm)	$P_{WF\ SAR\ limit}$ (dBm)	Validation Result
1	2.4 GHz	0 to 400	22.5	15.5	Pass
2	2.4 GHz	400 to 800	22.5	13.5	

Figure 6-11: Time-Averaged Conducted TX Power Over Time for Wi-Fi Test Scenario 4

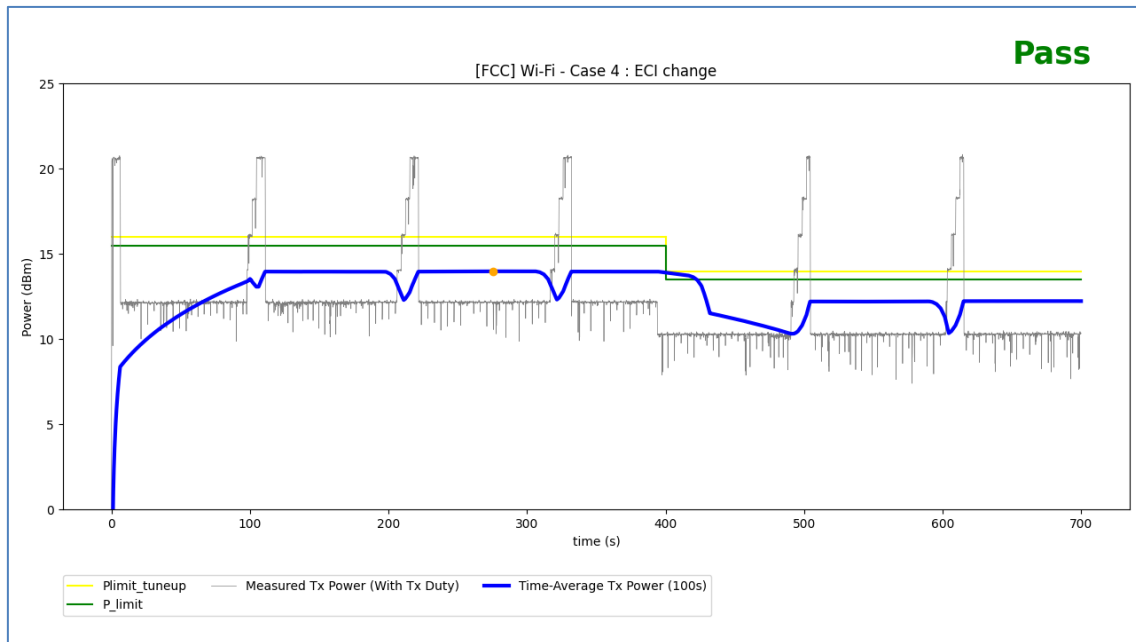
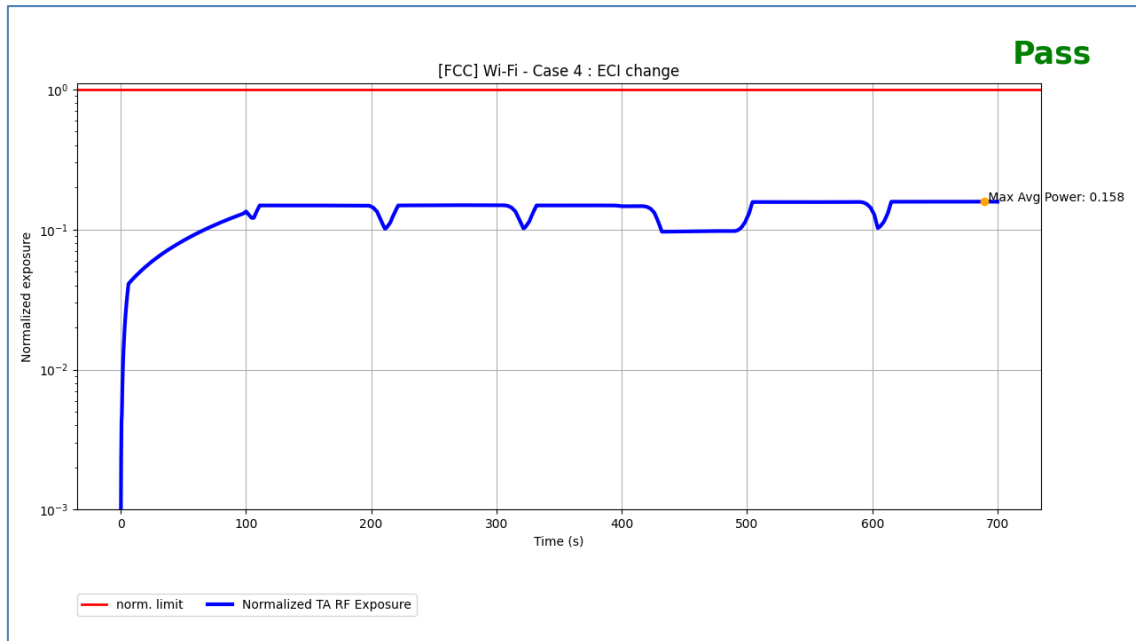

Figure 6-12: Normalized Time-Averaged SAR Over Time for Wi-Fi Test Scenario 4



NOTE:

The instantaneous TX power should be compared with $P_{WF_SAR_limit}$ of the corresponding configuration, i.e., 15.5 dBm for ECI 1 and 13.5 dBm for ECI 2, then transformed and averaged in SAR perspective to check compliance. Therefore, even though the time-averaged TX power seems to exceed $P_{WF_SAR_limit}$ after ECI changes at 400s, the time-averaged SAR meets regulation as a matter of fact.

6.6. Conducted Power Measurement Results for Scenario 5: Simultaneous SAR and PD

This test is the conducted power measurement for Wi-Fi SAR and PD TER. The detailed setting is listed in Table 6-6. As mentioned in Section 4.6, Wi-Fi 6 GHz band needs to obey both SAR and PD exposure limits, therefore the maximum of normalized TA-SAR and normalized TA-PD in 6 GHz band should be used in TER calculation. For our measurement in 6 GHz band, normalized TA-PD is larger than normalized TA-SAR, therefore normalized TA-PD is used in TER calculation. Figure 6-13 shows the conducted power measurement result for 2.4 GHz TA-SAR and 6 GHz TA-PD. The conducted power result of SAR / PD exposure is converted into normalized time-averaged SAR / PD. Figure 6-14 shows the total normalized time-averaged RF exposure is always below the normalized FCC requirement of 1.

Table 6-6: TA-SAR / TA-PD Parameters Setting for Wi-Fi Test Scenario 5

TER	Test Band	Switch Time (second)	Max Power (dBm)	P_{SAR_limit} or P_{PD_limit} (dBm)	Validation Result
SAR	2.4 GHz	0 to 800	22.5	15.5	Pass
SAR	6 GHz	0 to 800	21.5	16.0	
PD	6 GHz	0 to 800	21.5	16.0	

Figure 6-13: Time-Averaged Conducted TX Power Over Time for Wi-Fi Test Scenario 5

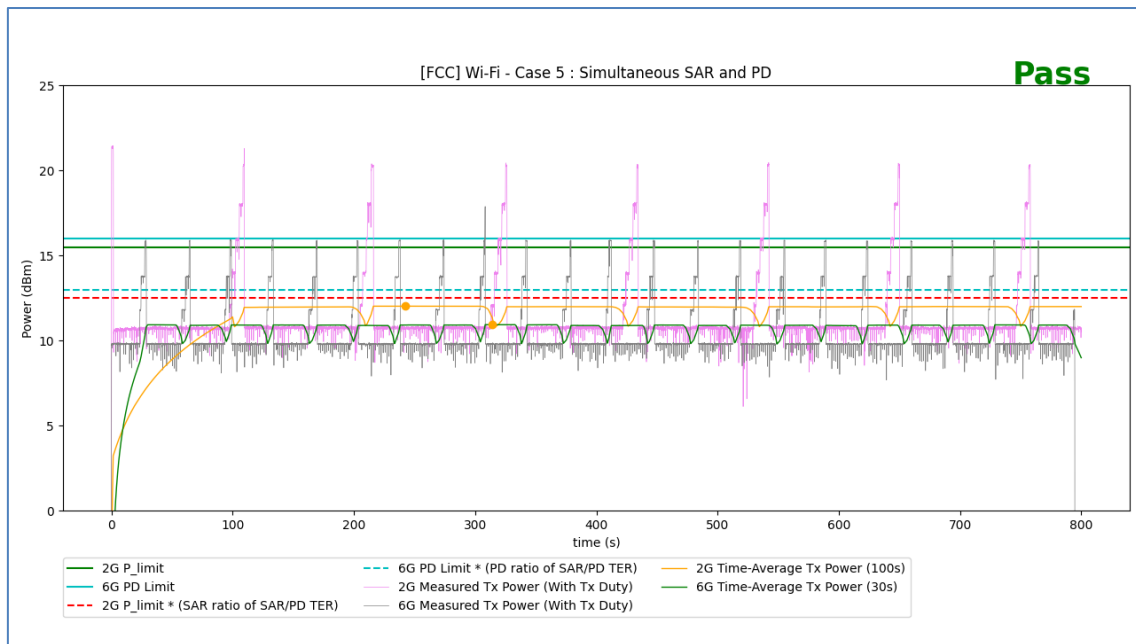
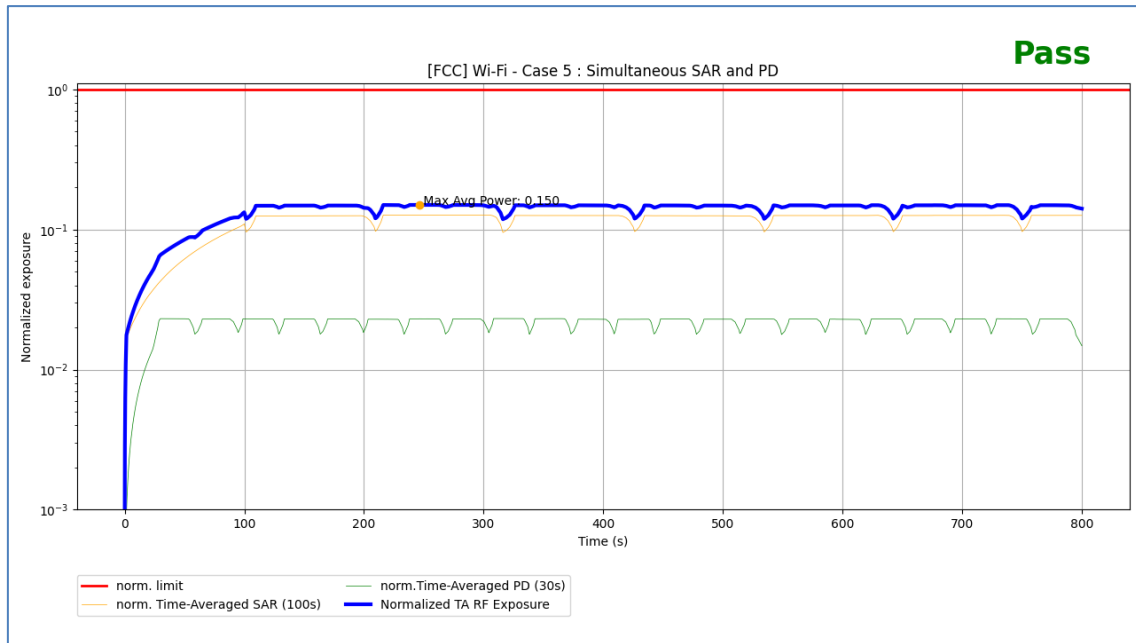

Figure 6-14: Total Normalized Time-Averaged RF exposure Over Time for Wi-Fi Test Scenario 5



7. Wi-Fi TA-SAR Validation via SAR Measurement

7.1. Measurement Setup

The SAR measurement photos are shown in Appendix A.

7.2. DASY8 System Verification for SAR Measurement

Tissue Verification

The dielectric properties of the tissue simulating liquid have been measured within 24 hours before the SAR testing and within $\pm 10\%$ of the target values. Liquid temperature during the SAR testing has kept within $\pm 2\text{ }^\circ\text{C}$.

Test Results for Tissue Simulating Liquid

Frequency (MHz)	Liquid Temp. ($^\circ\text{C}$)	Permittivity (ϵ_r)	Conductivity (σ)	Permittivity Target (ϵ_r)	Conductivity Target (σ)	Permittivity Deviation (%)	Conductivity Deviation (%)	Testing Date
2450	21.7	40.5	1.75	39.2	1.80	3.32	-2.78	Jun. 03, 2024
6500	21.7	33.5	6.17	34.5	6.07	-2.90	1.65	Jun. 03, 2024

Test System Verification

Before time-averaged SAR measurements, DASY8 system has been verified. The result normalized to 1W comparing to the reference SAR value provided by SPEAG in dipole calibration certificate, the deviation of system check results is within its specification of 10%. The below test results indicate the system check can meet the variation criterion.

Figure 7-1: System Verification Setup

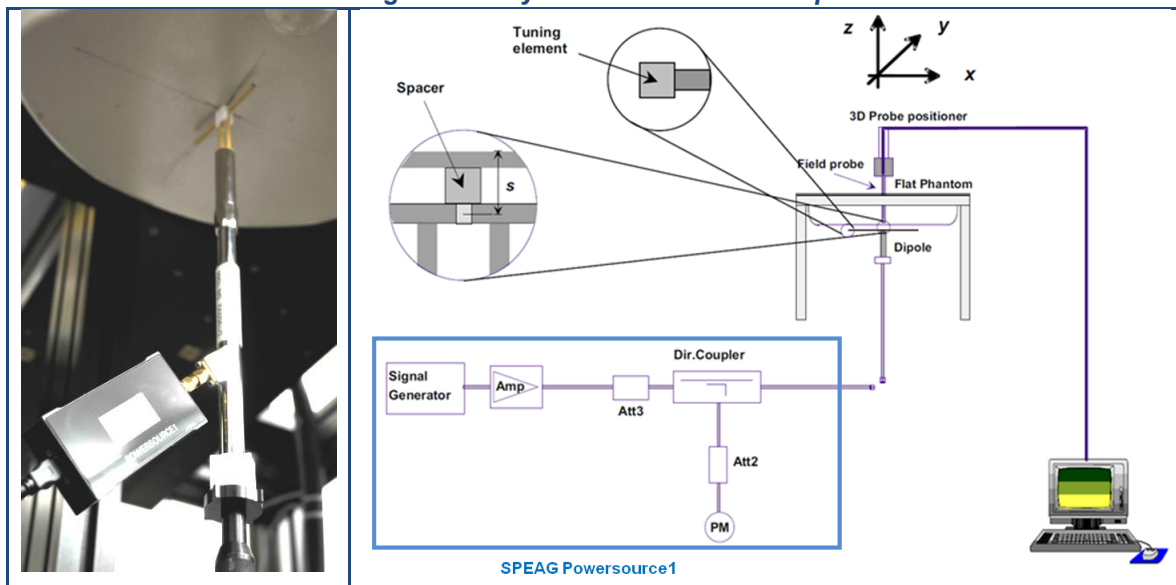

Test Results for SAR System Verification

Date	Frequency (MHz)	Targeted 1g SAR (W/kg)	Measured 1g SAR (W/kg)	Normalized 1g SAR (W/kg)	Deviation (%)	Dipole S/N	Probe S/N	DAE S/N
Jun. 03, 2024	2450	52.5	2.42	48.29	-8.03	1087	7757	1742
Jun. 03, 2024	6500	290	26.3	263	-9.31	1081	7757	1742

7.3. TA-SAR Measurement Results for Scenario 1: TX Mode Change

The MediaTek's TA-SAR algorithm is tested in Eurofins E&E Wireless Taiwan lab by using SPEAG DASY8 system. The detailed setting is listed in Table 7-1 and Table 7-2. Figure 7-2 demonstrates scenario 1-1 of 2.4 GHz band TA-SAR measurement result and Figure 7-3 demonstrates scenario 1-2 of 6 GHz band TA-SAR measurement result.

Table 7-1: TA-SAR Parameters Setting for Wi-Fi Test Scenario 1-1

Test Band	Max Power (dBm)	$P_{WF\ SAR\ limit}$ (dBm)
2.4 GHz	22.5	15.5

Figure 7-2: Time-Averaged SAR Measurement Result for Wi-Fi Test Scenario 1-1

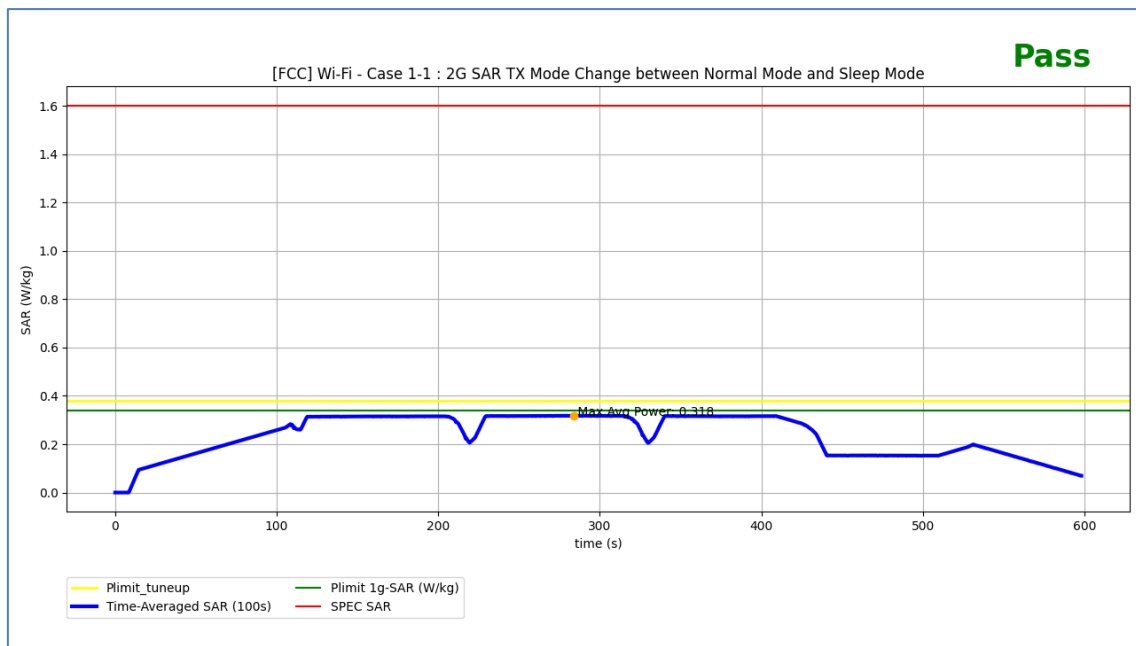

FCC Limit for 1g-SAR (W/kg)	1.6
Max. 100s Time-Averaged 1g-SAR (W/kg)	0.318
Validation Result : Pass	

Table 7-2: TA-SAR Parameters Setting for Wi-Fi Test Scenario 1-2

Test Band	Max Power (dBm)	P_{WF_SAR} limit (dBm)
6 GHz	21.5	16.0

Figure 7-3: Time-Averaged SAR Measurement Result for Wi-Fi Test Scenario 1-2

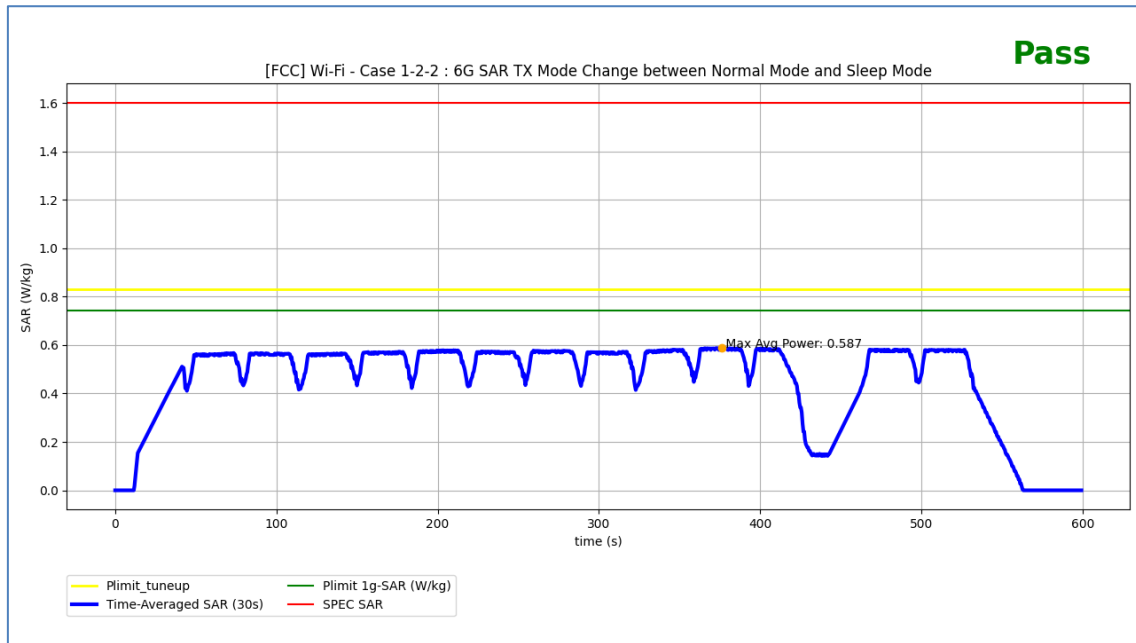

FCC Limit for 1g-SAR (W/kg)	1.6
Max. 30s Time-Averaged 1g-SAR (W/kg)	0.587
Validation Result : Pass	

8. Wi-Fi TA-PD Validation via Conducted Power Measurement

For conducted power measurements, TA-PD algorithm is implemented in firmware in the DUT. The exact setup diagrams are shown in Section 6.1.

8.1. Conducted Power Measurement Results for Scenario 1: TX Mode Change

This test is the conducted power measurement for Wi-Fi PD 6 GHz band TX mode change. The test measurement setup is illustrated in Section 6. The detailed setting is listed in Table 8-1. Figure 8-1 demonstrates the DUT's instantaneous conducted TX power, the time-averaged conducted TX power behavior over time, and the power limit. As seen in this figure, the time-averaged PD does not exceed the FCC limit.

Table 8-1: TA-PD Parameters Setting for Wi-Fi Test Scenario 1

Test Band	Max Power (dBm)	$P_{WF_PD_limit}$ (dBm)	Validation Result
6 GHz	21.5	16.0	Pass

Figure 8-1: Time-Averaged Conducted TX Power Over Time for Wi-Fi Test Scenario 1

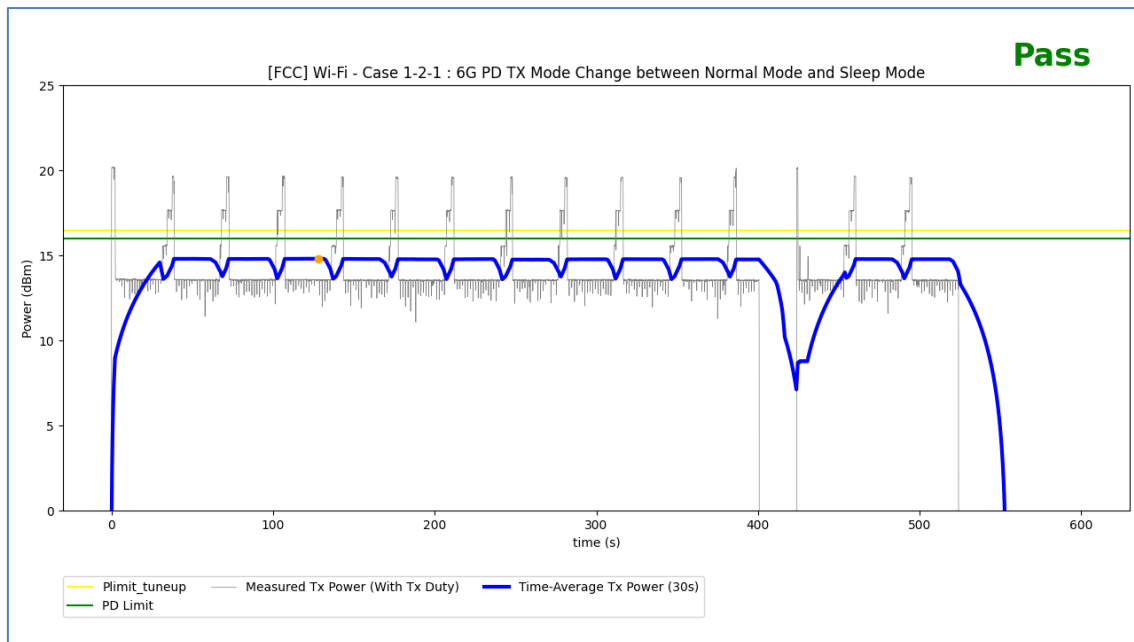

9. Wi-Fi TA-PD Validation via PD Measurement

For PD measurements, TA-PD algorithm is implemented in firmware in the DUT. The exact setup photographs are similar to the photographs shown in *Appendix A*.

9.1. DASY8 System Verification for PD Measurement

The system was verified to be within ± 0.66 dB of the power density targets on the calibration certificate according to the test system specification in the user’s manual and calibration facility recommendation. The 0.66 dB deviation threshold represents the expanded uncertainty for system performance checks using SPEAG’s mm-Wave verification sources. The same spatial resolution and measurement region used in the source calibration was applied during the system check.

The system check is a complete measurement using simple well-defined reference sources. Per the DASY8 specification in the user’s manual and SPEAG’s recommendation, the deviation threshold of ± 0.66 dB represents the expanded standard uncertainty for system performance check. The system check is successful if the measured results are within ± 0.66 dB tolerances to the target value shown in the calibration certificate of the verification source. The instrumentation and procedures used for system check should ensure the system is ready for performing compliance tests.

Figure 9-1: System Verification Setup

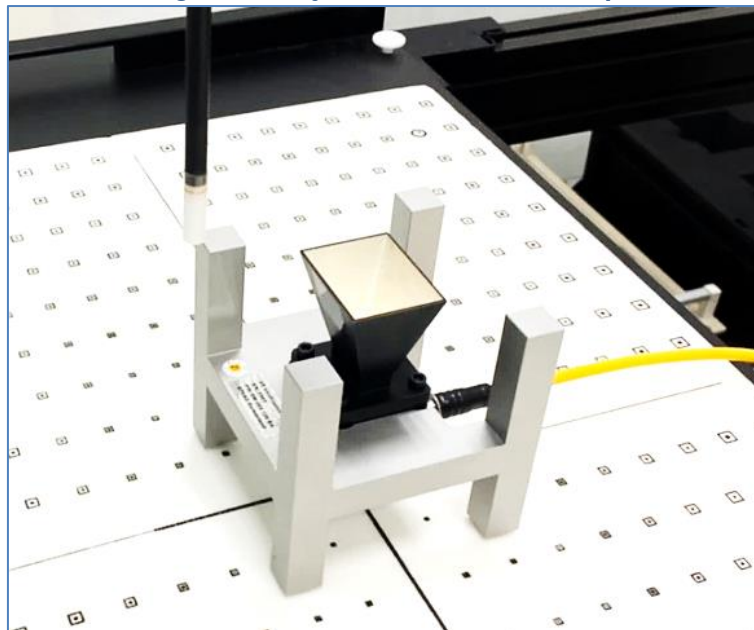

Test Results for PD System Verification

Test Date	Source S/N	Probe S/N	Frequency (GHz)	Normal psPD (4 cm ² , W/m ²)			Total psPD (4 cm ² , W/m ²)		
				Measured	Target	Delta (± 0.66 dB)	Measured	Target	Delta (± 0.66 dB)
Jun. 03, 2024	1060	9403	10	54.2	56.3	-0.17	54.6	56.7	-0.16

9.2. TA-PD Measurement Results for Scenario 1: TX Mode Change

The MediaTek's TA-PD algorithm is tested in Eurofins E&E Wireless Taiwan lab. The detailed setting is listed in Table 9-1. Figure 9-2 demonstrates scenario 1 of 6 GHz band TA-PD measurement result.

Table 9-1: TA-PD Parameters Setting for Wi-Fi Test Scenario 1

Test Band	Max Power (dBm)	$P_{WF, PD, limit}$ (dBm)
6 GHz	21.5	16.0

Figure 9-2: Time-Averaged PD Measurement Result for Wi-Fi Test Scenario 1

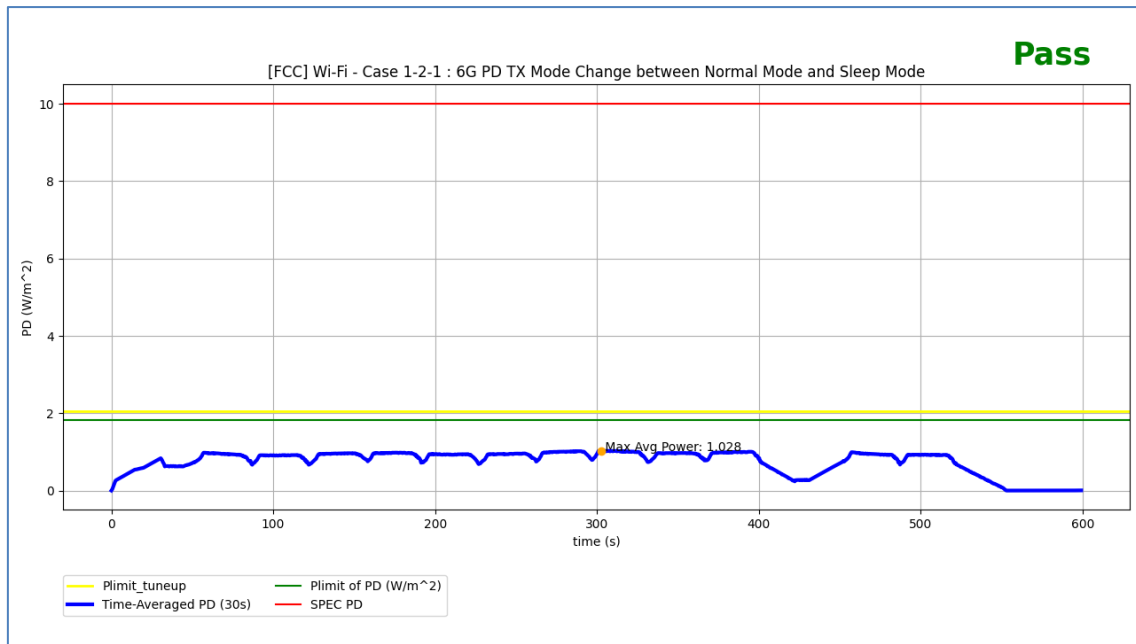

FCC Limit for PD (W/m ²)	10
Max. 30s Time-Averaged PD (W/m ²)	1.028
Validation Result : Pass	

10. Conclusions for Time-Averaging Feature Validation

This **TAS Algorithm Validation Report** proposes Wi-Fi TA-SAR and TA-PD test scenarios and procedures, and proves *MediaTek's* Wi-Fi TA-SAR and TA-PD algorithms can meet the FCC SAR and PD regulations with the proposed test scenarios and procedures.

As shown in **Chapters 6 and 8**, *MediaTek's* Wi-Fi TA-SAR and TA-PD algorithms are able to maintain SAR and PD over time below the FCC regulatory limits. Furthermore, the near-field measurements are also done in *Eurofins E&E Wireless Taiwan* lab to further validate the proposed test methodologies, and the results shown in **Chapters 7 and 9** demonstrate that *MediaTek's* Wi-Fi TA-SAR and TA-PD algorithms can maintain SAR and PD over time below the FCC regulatory limits with the proposed test procedures.

Based on the provided measurement results, it is concluded that *MediaTek's* Wi-Fi TA-SAR and TA-PD algorithms can be tested by using the proposed test methodology for FCC compliance.

11. Equipment List

<i>Manufacturer</i>	<i>Equipment</i>	<i>Model No.</i>	<i>Serial No.</i>	<i>Cal. Date</i>	<i>Cal. Interval</i>
SPEAG	2450 MHz System Validation Kit	D2450V2	1087	Aug. 18, 2023	1 year
SPEAG	6.5 GHz System Validation Kit	D6.5GHzV2	1081	Aug. 16, 2023	1 year
SPEAG	Isotropic E-Field Probe	EX3DV4	7757	Aug. 22, 2023	1 year
SPEAG	Data Acquisition Electronics	DAE4	1742	Aug. 17, 2023	1 year
SPEAG	Dielectric Probe Kit	DAK-3.5	1219	Mar. 18, 2024	1 year
SPEAG	5G Verification Source	10 GHz	1060	Aug. 21, 2023	1 year
SPEAG	E-Field mm-Wave Probe	EUmmWV3	9403	Dec. 05, 2023	1 year
SPEAG	Data Acquisition Electronics	DAE4	1741	Aug. 23, 2023	1 year
SPEAG	Powersource1	SE UMS 160 CA	4283	Aug. 16, 2023	1 year
R&S	Spectrum Analyzer	FSV3044	101255	Nov. 30, 2023	1 year
R&S	Spectrum Analyzer	FSV3044	101416	Oct. 31, 2023	1 year
Agilent	Signal Generator	E8257D	MY44320425	Jan. 26, 2024	1 year

Test Engineer : Raymond Wu

12. Measurement Uncertainties

SAR Uncertainty Budget for Frequency Range of 300 MHz to 3 GHz

Symbol	Error Description	Uncertainty (± %)	Probability Distribution	Divisor	C _i (1g)	C _i (10g)	Standard Uncertainty (± %, 1g)	Standard Uncertainty (± %, 10g)
Measurement System Errors								
CF	Probe Calibration	12.0	N	2	1	1	6.0	6.0
CF _{drift}	Probe Calibration Drift	1.7	R	√3	1	1	1.0	1.0
LIN	Probe Linearity	4.7	R	√3	1	1	2.7	2.7
BBS	Broadband Signal	2.8	R	√3	1	1	1.6	1.6
ISO	Probe Isotropy	7.6	R	√3	1	1	4.4	4.4
DAE	Other Probe+Electronic	0.8	N	1	1	1	0.8	0.8
AMB	RF Ambient	0.7	N	1	1	1	0.7	0.7
Δ _{sys}	Probe Positioning	0.006	N	1	0.14	0.14	0.0	0.0
DAT	Data Processing	1.2	N	1	1	1	1.2	1.2
Phantom and Device Errors								
LIQ(σ)	Conductivity (meas.)DAK	2.5	N	1	0.78	0.71	2.0	1.8
LIQ(T _σ)	Conductivity (temp)BB	3.3	R	√3	0.78	0.71	1.5	1.4
EPS	Phantom Permittivity	14.0	R	√3	0	0	0.0	0.0
DIS	Distance DUT-TSL	2.0	N	1	2	2	4.0	4.0
D _{xyz}	Device Positioning	1.0	N	1	1	1	1.0	1.0
H	Device Holder	2.5	N	1	1	1	2.5	2.5
MOD	DUT Modulation	2.4	R	√3	1	1	1.4	1.4
TAS	Time-average SAR	1.7	R	√3	1	1	1.0	1.0
RF _{drift}	DUT drift	2.5	N	1	1	1	2.5	2.5
Correction to the SAR Results								
C(ε, σ)	Deviation to Target	1.9	N	1	1	0.84	1.9	1.6
C(R)	SAR Scaling	0.0	R	√3	1	1	0.0	0.0
u(Δ SAR)	Combined Uncertainty					RSS	10.5	10.4
U	Expanded Uncertainty					k=2	21.0	20.8

SAR Uncertainty Budget for Frequency Range of 3 GHz to 6 GHz

Symbol	Error Description	Uncertainty (± %)	Probability Distribution	Divisor	C_i (1g)	C_i (10g)	Standard Uncertainty (± %, 1g)	Standard Uncertainty (± %, 10g)
Measurement System Errors								
CF	Probe Calibration	13.1	N	2	1	1	6.55	6.55
CF _{drift}	Probe Calibration Drift	1.7	R	$\sqrt{3}$	1	1	1.0	1.0
LIN	Probe Linearity	4.7	R	$\sqrt{3}$	1	1	2.7	2.7
BBS	Broadband Signal	2.6	R	$\sqrt{3}$	1	1	1.5	1.5
ISO	Probe Isotropy	7.6	R	$\sqrt{3}$	1	1	4.4	4.4
DAE	Other Probe+Electronic	1.2	N	1	1	1	1.2	1.2
AMB	RF Ambient	0.7	N	1	1	1	0.7	0.7
Δ_{sys}	Probe Positioning	0.005	N	1	0.29	0.29	0.0	0.0
DAT	Data Processing	2.3	N	1	1	1	2.3	2.3
Phantom and Device Errors								
LIQ(σ)	Conductivity (meas.)DAK	2.5	N	1	0.78	0.71	2.0	1.8
LIQ(T_σ)	Conductivity (temp)BB	3.4	R	$\sqrt{3}$	0.78	0.71	1.5	1.4
EPS	Phantom Permittivity	14.0	R	$\sqrt{3}$	0.25	0.25	2.0	2.0
DIS	Distance DUT-TSL	2.0	N	1	2	2	4.0	4.0
D _{xyz}	Device Positioning	1.0	N	1	1	1	1.0	1.0
H	Device Holder	2.5	N	1	1	1	2.5	2.5
MOD	DUT Modulation	2.4	R	$\sqrt{3}$	1	1	1.4	1.4
TAS	Time-average SAR	1.7	R	$\sqrt{3}$	1	1	1.0	1.0
RF _{drift}	DUT drift	2.5	N	1	1	1	2.5	2.5
Correction to the SAR Results								
C(ϵ, σ)	Deviation to Target	1.9	N	1	1	0.84	1.9	1.6
C(R)	SAR Scaling	0.0	R	$\sqrt{3}$	1	1	0.0	0.0
$u(\Delta SAR)$	Combined Uncertainty					RSS	11.2	11.1
U	Expanded Uncertainty					k=2	22.4	22.2

SAR Uncertainty Budget for Frequency Range of 6 GHz to 10 GHz

Symbol	Error Description	Uncertainty (± %)	Probability Distribution	Divisor	C _i (1g)	C _i (10g)	Standard Uncertainty (± %, 1g)	Standard Uncertainty (± %, 10g)
Measurement System Errors								
CF	Probe Calibration	18.6	N	2	1	1	9.3	9.3
CF _{drift}	Probe Calibration Drift	1.7	R	√3	1	1	1.0	1.0
LIN	Probe Linearity	4.7	R	√3	1	1	2.7	2.7
BBS	Broadband Signal	2.6	R	√3	1	1	1.5	1.5
ISO	Probe Isotropy	7.6	R	√3	1	1	4.4	4.4
DAE	Other Probe+Electronic	2.4	N	1	1	1	2.4	2.4
AMB	RF Ambient	0.7	N	1	1	1	0.7	0.7
Δ _{sys}	Probe Positioning	0.005	N	1	0.5	0.5	0.0	0.0
DAT	Data Processing	3.5	N	1	1	1	3.5	3.5
Phantom and Device Errors								
LIQ(σ)	Conductivity (meas.)DAK	2.5	N	1	0.78	0.71	2.0	1.8
LIQ(T _σ)	Conductivity (temp)BB	2.4	R	√3	0.78	0.71	1.1	1.0
EPS	Phantom Permittivity	14.0	R	√3	0.5	0.5	4.0	4.0
DIS	Distance DUT-TSL	2.0	N	1	2	2	4.0	4.0
D _{xyz}	Device Positioning	1.0	N	1	1	1	1.0	1.0
H	Device Holder	2.5	N	1	1	1	2.5	2.5
MOD	DUT Modulation	2.4	R	√3	1	1	1.4	1.4
TAS	Time-average SAR	1.7	R	√3	1	1	1.0	1.0
RF _{drift}	DUT drift	2.5	N	1	1	1	2.5	2.5
Correction to the SAR Results								
C(ε, σ)	Deviation to Target	1.9	N	1	1	0.84	1.9	1.6
C(R)	SAR Scaling	0.0	R	√3	1	1	0.0	0.0
u(Δ SAR)	Combined Uncertainty					RSS	13.9	13.8
U	Expanded Uncertainty					k=2	27.8	27.6

Uncertainty Budget for Power Density Measurement

Source of Uncertainty	Unc. ± dB	Probability Distribution	Div.	ci	Standard Uncertainty (± dB)	vi or v eff
Uncertainty Terms Dependent on the Measurement System						
Probe Calibration	0.49	Normal	1	1	0.49	∞
Hemispherical Isotropy	0.50	Rectangular	√3	1	0.29	∞
Linearity	0.20	Rectangular	√3	1	0.12	∞
System Detection Limits	0.04	Rectangular	√3	1	0.02	∞
Modulation Response	0.40	Rectangular	√3	1	0.23	∞
Readout Electronics	0.03	Normal	1	1	0.03	∞
Response Time	0.00	Rectangular	√3	1	0.00	∞
Integration Time	0.00	Rectangular	√3	1	0.00	∞
RF Ambient Conditions – Noise	0.20	Rectangular	√3	1	0.12	∞
RF Ambient Conditions – Reflections	0.20	Rectangular	√3	1	0.12	∞
Probe Positioner Mechanical Tolerance	0.04	Rectangular	√3	1	0.02	∞
Probe Positioning with Respect to Phantom	0.30	Rectangular	√3	1	0.17	∞
Savg Reconstruction	0.60	Rectangular	√3	1	0.35	∞
Uncertainty Terms Dependent on the DUT						
Power Drift of Measurement	0.20	Rectangular	√3	1	0.12	∞
Input Power	0.00	Normal	1	1	0.00	∞
Combined standard uncertainty				RSS	0.76	
Expanded Uncertainty (95 % conf. interval)				k=2	1.52	

***** End of Report *****