

## DFS Test Report

**Report No.:** RF200511E11A-1

**FCC ID:** MSQ-CMAXI800

**Test Model:** CMAX6000

**Series Model:** CMAX6000V

**Received Date:** May 11, 2020

**Test Date:** June 01 to 09, 2020

**Issued Date:** Oct. 07, 2020

**Applicant:** ASUSTeK Computer Inc.

**Address:** 1F., No. 15, Lide Rd., Beitou Dist., Taipei City 112, Taiwan

**Issued By:** Bureau Veritas Consumer Products Services (H.K.) Ltd., Taoyuan Branch  
Hsin Chu Laboratory

**Lab Address:** E-2, No.1, Li Hsin 1st Road, Hsinchu Science Park, Hsinchu City 300,  
Taiwan

**Test Location:** E-2, No.1, Li Hsin 1st Road, Hsinchu Science Park, Hsinchu City 300,  
Taiwan

**FCC Registration /  
Designation Number:** 723255 / TW2022



This report is for your exclusive use. Any copying or replication of this report to or for any other person or entity, or use of our name or trademark, is permitted only with our prior written permission. This report sets forth our findings solely with respect to the test samples identified herein. The results set forth in this report are not indicative or representative of the quality or characteristics of the lot from which a test sample was taken or any similar or identical product unless specifically and expressly noted. Our report includes all of the tests requested by you and the results thereof based upon the information that you provided to us. You have 60 days from date of issuance of this report to notify us of any material error or omission caused by our negligence, provided, however, that such notice shall be in writing and shall specifically address the issue you wish to raise. A failure to raise such issue within the prescribed time shall constitute your unqualified acceptance of the completeness of this report, the tests conducted and the correctness of the report contents. Unless specific mention, the uncertainty of measurement has been explicitly taken into account to declare the compliance or non-compliance to the specification. The report must not be used by the client to claim product certification, approval, or endorsement by TAF or any government agencies.

## Table of Contents

<b>Release Control Record</b> .....	<b>3</b>
<b>1 Certificate of Conformity</b> .....	<b>4</b>
<b>2 EUT Information</b> .....	<b>5</b>
2.1 Operating Frequency Bands and Mode of EUT .....	5
2.2 EUT Software and Firmware Version .....	5
2.3 Description of Available Antennas to the EUT .....	6
2.4 EUT Maximum and Minimum Conducted Power .....	7
2.5 EUT Maximum and Minimum EIRP Power .....	7
2.6 Transmit Power Control (TPC) .....	8
2.7 Statement of Manufacturer .....	8
<b>3. U-NII DFS Rule Requirements</b> .....	<b>9</b>
3.1 Working Modes and Required Test Items .....	9
3.2 Test Limits and Radar Signal Parameters .....	10
<b>4. Test &amp; Support Equipment List</b> .....	<b>13</b>
4.1 Test Instruments .....	13
4.2 Description of Support Units .....	13
<b>5. Test Procedure</b> .....	<b>14</b>
5.1 DFS Measurement System .....	14
5.2 Calibration of DFS Detection Threshold Level .....	15
5.3 Deviation from Test Standard .....	15
5.4 Radiated Test Setup Configuration .....	16
<b>6. Test Results</b> .....	<b>17</b>
6.1 Summary of Test Results .....	17
6.2 Test Results .....	18
6.2.1 Test Mode: Device Operating In Master Mode .....	18
6.2.2 U-NII Detection Bandwidth .....	23
6.2.3 Channel Availability Check Time .....	33
6.2.4 Channel Closing Transmission and Channel Move Time .....	35
6.2.5 Non- Occupancy Period .....	70
<b>7. Information of the Testing Laboratories</b> .....	<b>72</b>
<b>8. APPENDIX-A</b> .....	<b>73</b>

### Release Control Record

Issue No.	Description	Date Issued
RF200511E11A-1	Original release.	Oct. 07, 2020

## 1 Certificate of Conformity

**Product:** AX6000 Dual Band DOCSIS 3.1 Cable Modem Router,  
AX6000 Dual Band DOCSIS 3.1 Cable Modem Voice Router

**Brand:** ASUS

**Test Model:** CMAX6000

**Series Model:** CMAX6000V

**Sample Status:** ENGINEERING SAMPLE

**Applicant:** ASUSTeK Computer Inc.

**Test Date:** June 01 to 09, 2020

**Standards:** FCC Part 15, Subpart E (Section 15.407)

**References Test Guidance:** KDB 905462 D02 UNII DFS Compliance Procedures New Rules v02

The above equipment has been tested by **Bureau Veritas Consumer Products Services (H.K.) Ltd., Taoyuan Branch**, and found compliance with the requirement of the above standards. The test record, data evaluation & Equipment Under Test (EUT) configurations represented herein are true and accurate accounts of the measurements of the sample's EMC characteristics under the conditions specified in this report.

**Prepared by :** Joyce Kuo , **Date:** Oct. 07, 2020  
Joyce Kuo / Specialist

**Approved by :** Clark Lin , **Date:** Oct. 07, 2020  
Clark Lin / Technical Manager

## 2 EUT Information

### 2.1 Operating Frequency Bands and Mode of EUT

Table 1: Operating Frequency Bands and Mode of EUT

Operational Mode	Operating Frequency Range	
	5250~5350MHz	5470~5725MHz
Master	✓	✓

### 2.2 EUT Software and Firmware Version

Table 2: The EUT Software/Firmware Version

No.	Product	Model No.	Software/Firmware Version
1	AX6000 Dual Band DOCSIS 3.1 Cable Modem Router, AX6000 Dual Band DOCSIS 3.1 Cable Modem Voice Router	CMAX6000	v1.00.00

### 2.3 Description of Available Antennas to the EUT

Table 3: Antenna List

Antenna NO.	Chain No.	Antenna Net Gain(dBi)	Frequency range	Antenna Type	Connector Type	Cable Length (mm)
1	0	2.42	2.4~2.4835GHz	PIFA	i-pex(MHF)	227
		0.49	5.15~5.85GHz			
2	1	0.09	2.4~2.4835GHz	PIFA	i-pex(MHF)	171
		1.42	5.15~5.85GHz			
3	2	1.38	2.4~2.4835GHz	PIFA	i-pex(MHF)	145
		1.44	5.15~5.85GHz			
4	3	3.69	2.4~2.4835GHz	PIFA	i-pex(MHF)	73
		2.46	5.15~5.85GHz			

## 2.4 EUT Maximum and Minimum Conducted Power

Table 4: The Measured Conducted Output Power

### CDD Mode

Frequency Band (MHz)	MAX. Power		MIN. Power	
	Output Power (mW)	Output Power (dBm)	Output Power (mW)	Output Power (dBm)
5250~5350	249.327	23.97	62.661	17.97
5470~5725	250.403	23.99	62.951	17.99

### Beamforming Mode

Frequency Band (MHz)	MAX. Power		MIN. Power	
	Output Power (mW)	Output Power (dBm)	Output Power (mW)	Output Power (dBm)
5250~5350	177.607	22.49	44.566	16.49
5470~5725	177.371	22.49	44.566	16.49

## 2.5 EUT Maximum and Minimum EIRP Power

Table 5: The EIRP Output Power List

### CDD Mode

Frequency Band (MHz)	MAX. EIRP Power		MIN. EIRP Power	
	Output Power (mW)	Output Power (dBm)	Output Power (mW)	Output Power (dBm)
5250~5350	439.542	26.43	110.408	20.43
5470~5725	441.57	26.45	110.917	20.45

### Beamforming Mode

Frequency Band (MHz)	MAX. EIRP Power		MIN. EIRP Power	
	Output Power (mW)	Output Power (dBm)	Output Power (mW)	Output Power (dBm)
5250~5350	997.7	29.99	250.611	23.99
5470~5725	997.7	29.99	250.611	23.99

## 2.6 Transmit Power Control (TPC)

U-NII devices operating in the 5.25-5.35 GHz band and the 5.47-5.725 GHz band shall employ a TPC mechanism. The U-NII device is required to have the capability to operate at least 6 dB below the mean EIRP value of 30 dBm. A TPC mechanism is not required for systems with an e.i.r.p. of less than 500 mW.

Applicable	EIRP	FCC 15.407 (h)(1)
√	>500mW	The TPC mechanism is required for system with an EIRP of above 500mW
	<500mW	The TPC mechanism is not required for system with an EIRP of less 500mW

The UUT can adjust a transmitter's output power based on the signal level present at the receiver. TPC is auto controlled by software.

## 2.7 Statement of Manufacturer

Manufacturer statement confirming that information regarding the parameters of the detected Radar Waveforms is not available to the end user.



### 3. U-NII DFS Rule Requirements

#### 3.1 Working Modes and Required Test Items

The manufacturer shall state whether the UUT is capable of operating as a Master and/or a Client. If the UUT is capable of operating in more than one operating mode then each operating mode shall be tested separately. See tables 6 and 7 for the applicability of DFS requirements for each of the operational modes.

Table 6: Applicability of DFS Requirements Prior to Use a Channel

Requirement	Operational Mode		
	Master	Client without radar detection	Client with radar detection
Non-Occupancy Period	✓	✓ note	✓
DFS Detection Threshold	✓	Not required	✓
Channel Availability Check Time	✓	Not required	Not required
U-NII Detection Bandwidth	✓	Not required	✓

Note: Per KDB 905462 D03 UNII Clients Without Radar Detection New Rules v01r02 section (b)(5/6), If the client moves with the master, the device is considered compliant if nothing appears in the client non-occupancy period test. For devices that shut down (rather than moving channels), no beacons should appear. An analyzer plot that contains a single 30-minute sweep on the original channel.

Table 7: Applicability of DFS Requirements during Normal Operation

Requirement	Operational Mode	
	Master or Client with radar detection	Client without radar detection
DFS Detection Threshold	✓	Not required
Channel Closing Transmission Time	✓	✓
Channel Move Time	✓	✓
U-NII Detection Bandwidth	✓	Not required

Additional requirements for devices with multiple bandwidth modes	Master or Client with radar detection	Client without radar detection
U-NII Detection Bandwidth and Statistical Performance Check	All BW modes must be tested	Not required
Channel Move Time and Channel Closing Transmission Time	Test using widest BW mode available	Test using the widest BW mode available for the link
All other tests	Any single BW mode	Not required

Note: Frequencies selected for statistical performance check (Section 7.8.4) should include several frequencies within the radar detection bandwidth and frequencies near the edge of the radar detection bandwidth. For 802.11 devices it is suggested to select frequencies in each of the bonded 20 MHz channels and the channel center frequency.

### 3.2 Test Limits and Radar Signal Parameters

#### Detection Threshold Values

Table 8: DFS Detection Thresholds for Master Devices and Client Devices with Radar Detection

Maximum Transmit Power	Value (See Notes 1, 2, and 3)
EIRP $\geq$ 200 milliwatt	-64 dBm
EIRP < 200 milliwatt and power spectral density < 10 dBm/MHz	-62 dBm
EIRP < 200 milliwatt that do not meet the power spectral density requirement	-64 dBm

Note 1: This is the level at the input of the receiver assuming a 0 dBi receive antenna.

Note 2: Throughout these test procedures an additional 1 dB has been added to the amplitude of the test transmission waveforms to account for variations in measurement equipment. This will ensure that the test signal is at or above the detection threshold level to trigger a DFS response.

Note 3: EIRP is based on the highest antenna gain. For MIMO devices refer to KDB Publication 662911 D01.

Table 9: DFS Response Requirement Values

Parameter	Value
Non-occupancy period	Minimum 30 minutes
Channel Availability Check Time	60 seconds
Channel Move Time	10 seconds See Note 1.
Channel Closing Transmission Time	200 milliseconds + an aggregate of 60 milliseconds over remaining 10 second period. See Notes 1 and 2.
U-NII Detection Bandwidth	Minimum 100% of the U-NII 99% transmission power bandwidth. See Note 3

Note 1: Channel Move Time and the Channel Closing Transmission Time should be performed with Radar Type 0. The measurement timing begins at the end of the Radar Type 0 burst.

Note 2: The Channel Closing Transmission Time is comprised of 200 milliseconds starting at the beginning of the Channel Move Time plus any additional intermittent control signals required to facilitate a Channel move (an aggregate of 60 milliseconds) during the remainder of the 10 second period. The aggregate duration of control signals will not count quiet periods in between transmissions.

Note 3: During the U-NII Detection Bandwidth detection test, radar type 0 should be used. For each frequency step the minimum percentage of detection is 90 percent. Measurements are performed with no data traffic.

### Parameters of DFS Test Signals

Step intervals of 0.1 microsecond for Pulse Width, 1 microsecond for PRI, 1 MHz for chirp width and 1 for the number of pulses will be utilized for the random determination of specific test waveforms.

Table 10: Short Pulse Radar Test Waveforms

Radar Type	Pulse Width (μsec)	PRI (μsec)	Number of Pulses	Minimum Percentage of Successful Detection	Minimum Number of Trials
0	1	1428	18	See Note 1	See Note 1
1	1	Test A 15 unique PRI values randomly selected from the list of 23 PRI values	Roundup $\left\{ \left( \frac{1}{360} \right) \cdot \left( \frac{19 \cdot 10^6}{\text{PRI}_{\mu\text{sec}}} \right) \right\}$	60%	30
		15 unique PRI values randomly selected within the range of 518~3066 μsec with a minimum of 1 μsec, excluding PRI values selected in Test A			
2	1-5	150-230	23-29	60%	30
3	6-10	200-500	16-18	60%	30
4	11-20	200-500	12-16	60%	30
Aggregate (Radar Types 1-4)				80%	120
Note 1: Short Pulse Radar Type 0 should be used for the detection bandwidth test, channel move time, and channel closing time tests.					

Table 11: Long Pulse Radar Test Waveform

Radar Type	Pulse Width (µsec)	Chirp Width (MHz)	PRI (µsec)	Number of Pulses Per Burst	Number of Bursts	Minimum Percentage of Successful Detection	Minimum Number of Trials
5	50-100	5-20	1000-2000	1-3	8-20	80%	30

Three subsets of trials will be performed with a minimum of ten trials per subset. The subset of trials differ in where the Long Pulse Type 5 Signal is tuned in frequency.

- a) the Channel center frequency
- b) tuned frequencies such that 90% of the Long Pulse Type 5 frequency modulation is within the low edge of the UUT Occupied Bandwidth
- c) tuned frequencies such that 90% of the Long Pulse Type 5 frequency modulation is within the high edge of the UUT Occupied Bandwidth

It include 10 trails for every subset, the formula as below,

For subset case 1: the center frequency of the signal generator will remain fixed at the center of the UUT Channel.

For subset case 2: to retain 90% frequency overlap between the radar signal and the UUT Occupied Bandwidth, the center frequency of the signal generator will vary for each of the ten trials in subset case 2. The center frequency of the signal generator for each trial is calculated by:

$$FL+(0.4*Chirp\ Width\ [in\ MHz])$$

For subset case 3: to retain 90% frequency overlap between the radar signal and the UUT Occupied Bandwidth, the center frequency of the signal generator will vary for each of the ten trials in subset case 3. The center frequency of the signal generator for each trial is calculated by:

$$FH-(0.4*Chirp\ Width\ [in\ MHz])$$

Table 12: Frequency Hopping Radar Test Waveform

Radar Type	Pulse Width (µsec)	PRI (µsec)	Pulses per Hop	Hopping Rate (kHz)	Hopping Sequence Length (msec)	Minimum Percentage of Successful Detection	Minimum Number of Trials
6	1	333	9	0.333	300	70%	30

#### 4. Test & Support Equipment List

##### 4.1 Test Instruments

Table 13: Test Instruments List

DESCRIPTION & MANUFACTURER	MODEL NO.	SERIAL NO.	CALIBRATED DATE	CALIBRATED UNTIL
Spectrum Analyzer R&S	ESR	102026	Apr. 22, 2020	Apr. 21, 2021
Vector Signal Generator Agilent	N5182B	MY53052700	Jul. 17, 2019	Jul. 16, 2020
Horn_Antenna FT-RF	HA-07M18G-NF	0000220091110	Nov. 24, 2019	Nov. 23, 2020
DFS Control Box	BV-DFS-CB	002	Dec. 02, 2019	Dec. 01, 2020

##### 4.2 Description of Support Units

Table 14: Support Unit Information

No.	Product	Brand	Model No.	FCC ID	Spec
1	Wireless-AX6000 Dual Band Gigabit Router	ASUS	RT-AX88U	MSQ-RTAXHP00	The maximum EIRP is 29.97 dBm, Antenna Gain is 2.24dBi

**NOTE:** This device was functioned as a  Master  Slave device during the DFS test.

Table 15: Software/Firmware Information

No.	Product	Model No.	Software/Firmware Version
1	Wireless-AX6000 Dual Band Gigabit Router	RT-AX88U	3.0.0.4.384

## 5. Test Procedure

### 5.1 DFS Measurement System

A complete DFS Measurement System consists of two subsystems: (1) the Radar Signal Generating system and (2) the Traffic Monitoring system. The control PC is necessary for generating the Radar waveforms in Table 10, 11 and 12. The traffic monitoring subsystem is specified to the type of unit under test (UUT).

#### Radiated Setup Configuration of DFS Measurement System

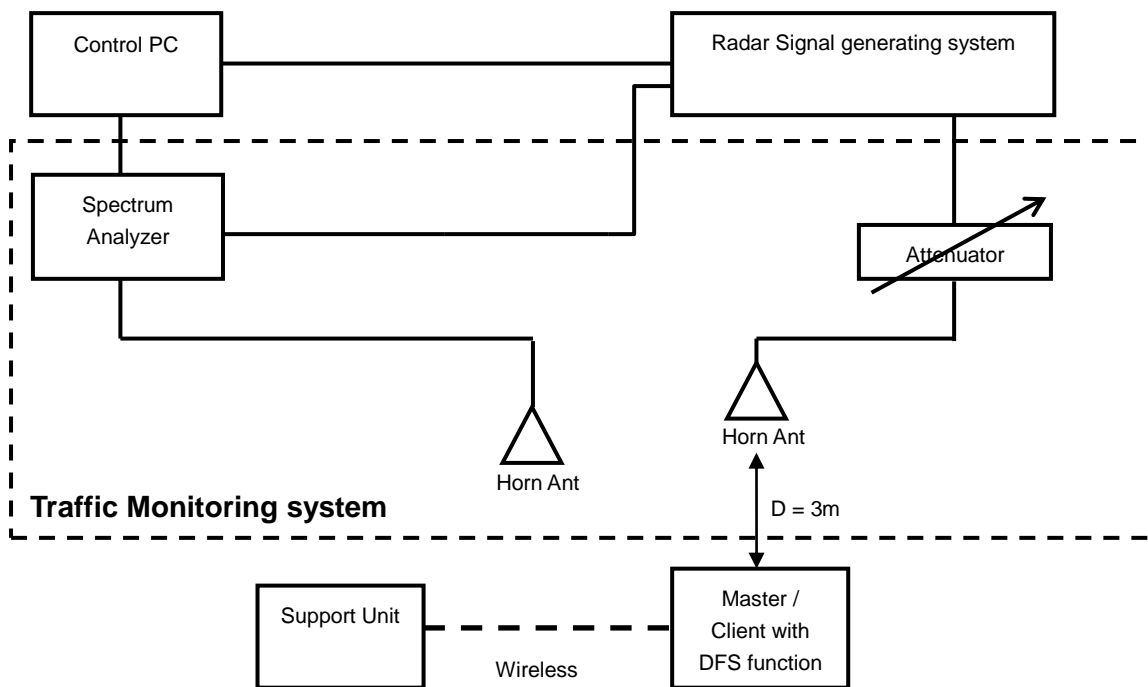

#### Channel Loading

System testing will be performed with channel-loading using means appropriate to the data types that are used by the unlicensed device. The following requirements apply:

a)	The data file must be of a type that is typical for the device (i.e., MPEG-2, MPEG-4, WAV, MP3, MP4, AVI, etc.) and must generally be transmitting in a streaming mode.	
b)	Software to ping the client is permitted to simulate data transfer but must have random ping intervals.	
c)	Timing plots are required with calculations demonstrating a minimum channel loading of approximately 17% or greater.	✓
d)	Unicast or Multicast protocols are preferable but other protocols may be used. The appropriate protocol used must be described in the test procedures.	

## 5.2 Calibration of DFS Detection Threshold Level

The measured channel is chosen from the operating channels of the UUT within the 5250-5350MHz or 5470-5725MHz and using the all bandwidth mode available for the link. The radar signal was the same as transmitted channels, and injected into the antenna of AP (master) or Client Device with Radar Detection, measured the channel closing transmission time and channel move time.

### Radiated setup configuration of Calibration of DFS Detection Threshold Level

The radar signal generate system is generating waveform pattern of radar types. The amplitude of the radar signal generator system is adjusted to yield a level of  $-64$  dBm as measured on the spectrum analyzer. The interference detection threshold level is lower than  $-64$ dBm hence it provides margin to the limit.

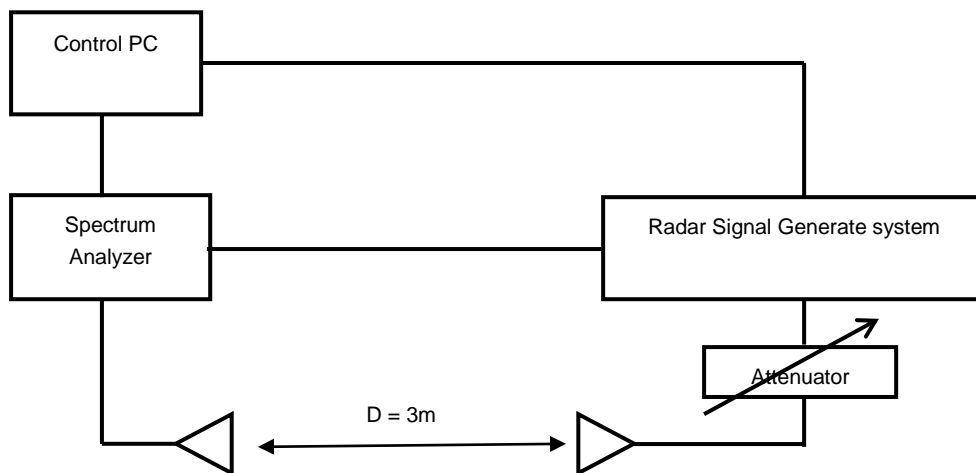

## 5.3 Deviation from Test Standard

No deviation.

## 5.4 Radiated Test Setup Configuration

### Master mode

The EUT is a U-NII Device operating in Master mode. The radar test signals are injected into the Master Device.

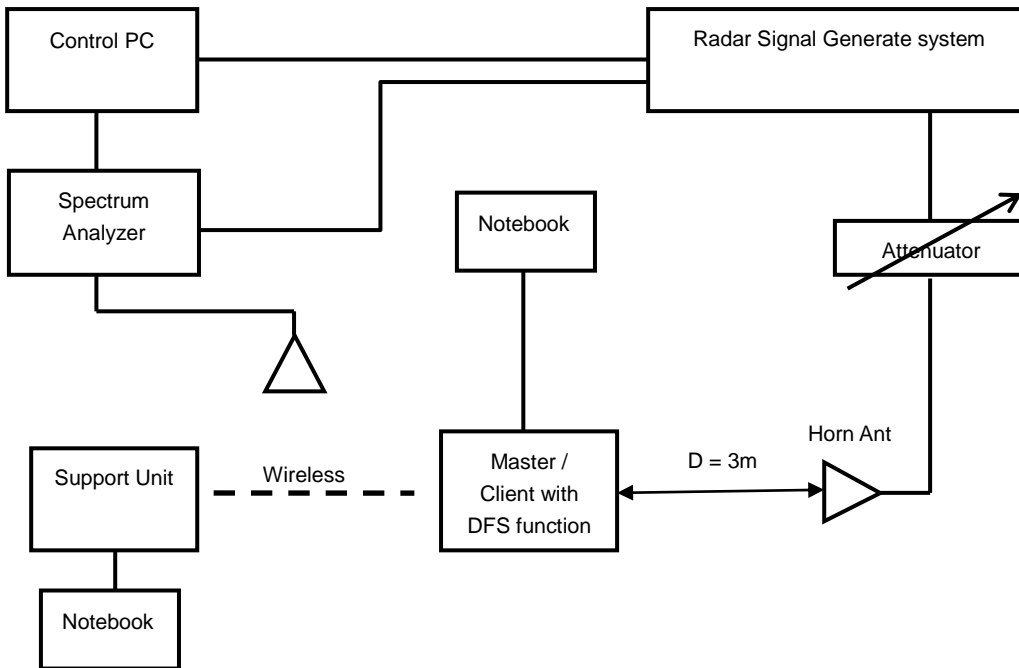

Note: The UUT main beam of the antenna is directly toward the radar emitter during testing.



## 6. Test Results

### 6.1 Summary of Test Results

Clause	Test Parameter	Remarks	Pass/Fail
15.407	DFS Detection Threshold	Applicable	Pass
15.407	Channel Availability Check Time	Applicable	Pass
15.407	Channel Move Time	Applicable	Pass
15.407	Channel Closing Transmission Time	Applicable	Pass
15.407	Non- Occupancy Period	Applicable	Pass
15.407	U-NII Detection Bandwidth and Statistical Performance Check	Applicable	Pass

Note: This device does not support "802.11ax Channel Puncturing" function.

## 6.2 Test Results

### 6.2.1 Test Mode: Device Operating In Master Mode.

The radar test waveforms are injected into the Master.  
 This test was investigated for different bandwidth (20MHz · 40MHz · 80MHz and 160MHz).  
 The following plots was done on 160MHz as a representative

### DFS Detection Threshold

For detection threshold level of -64dBm, the tested level is lower than required level for 1dB, hence it provides margin to the limit.

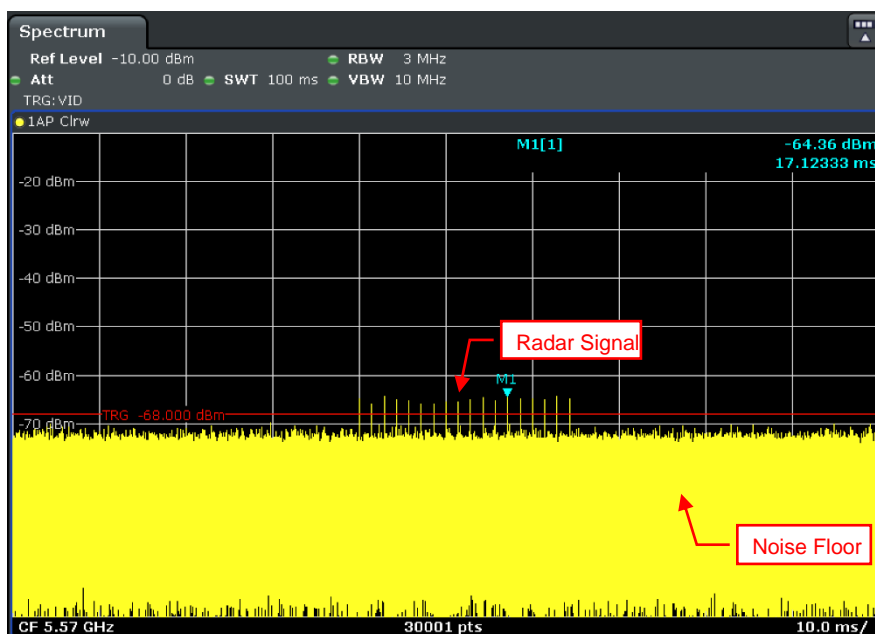

Radar Signal 0

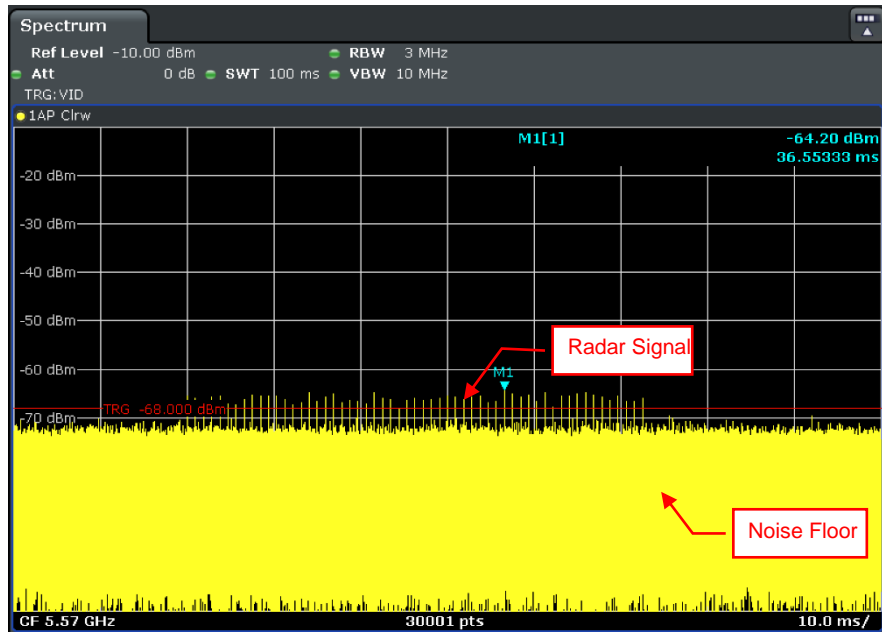

Radar Signal 1 (Test A)

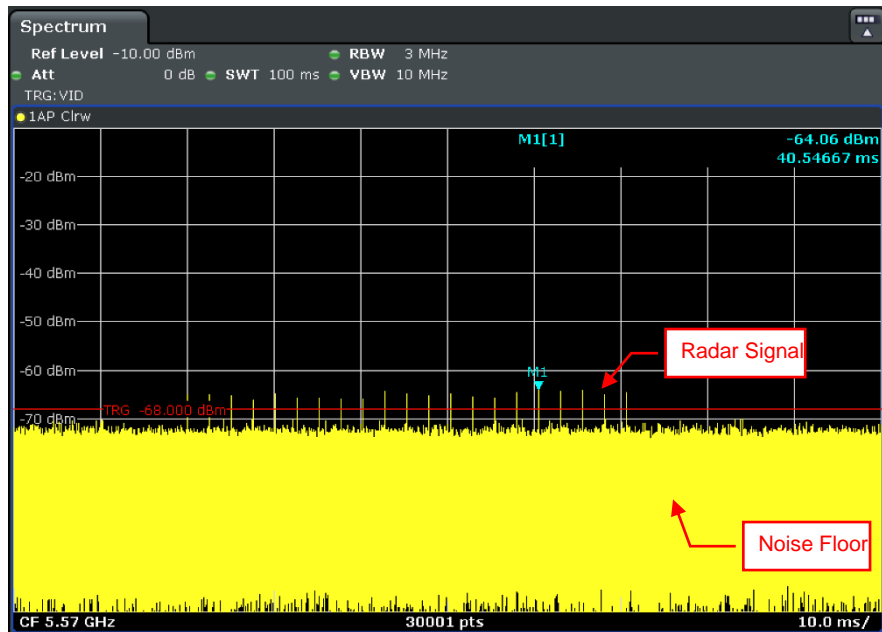

Radar Signal 1 (Test B)

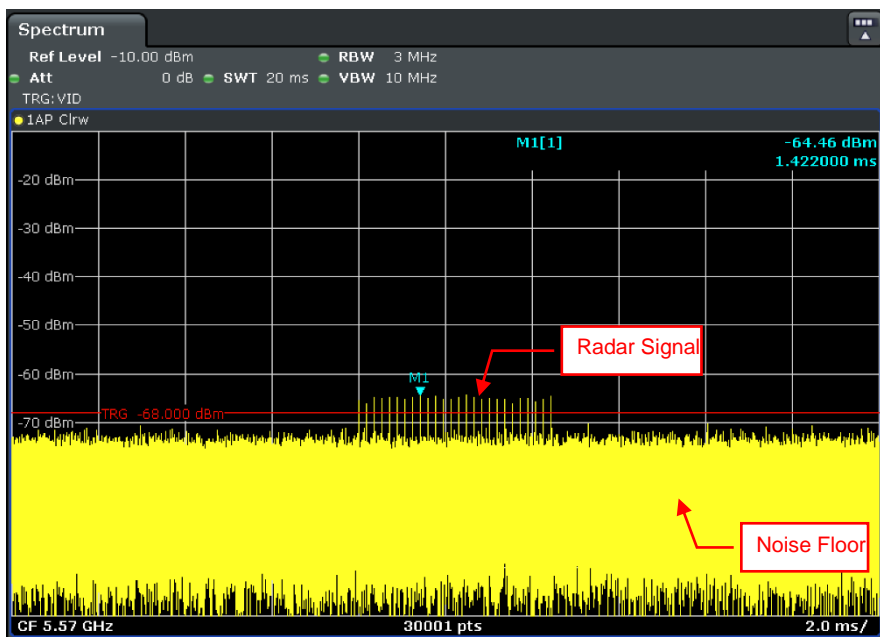

Radar Signal 2

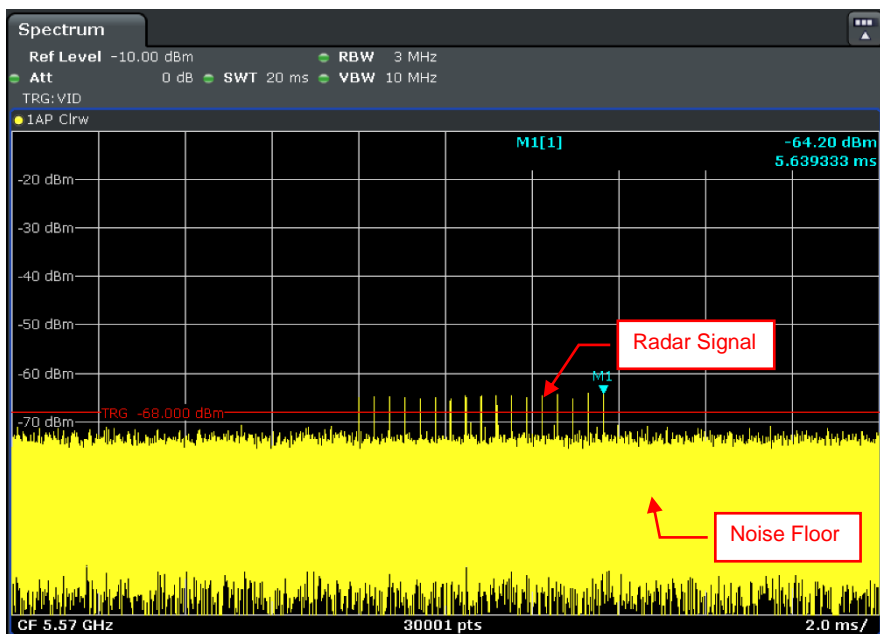

Radar Signal 3

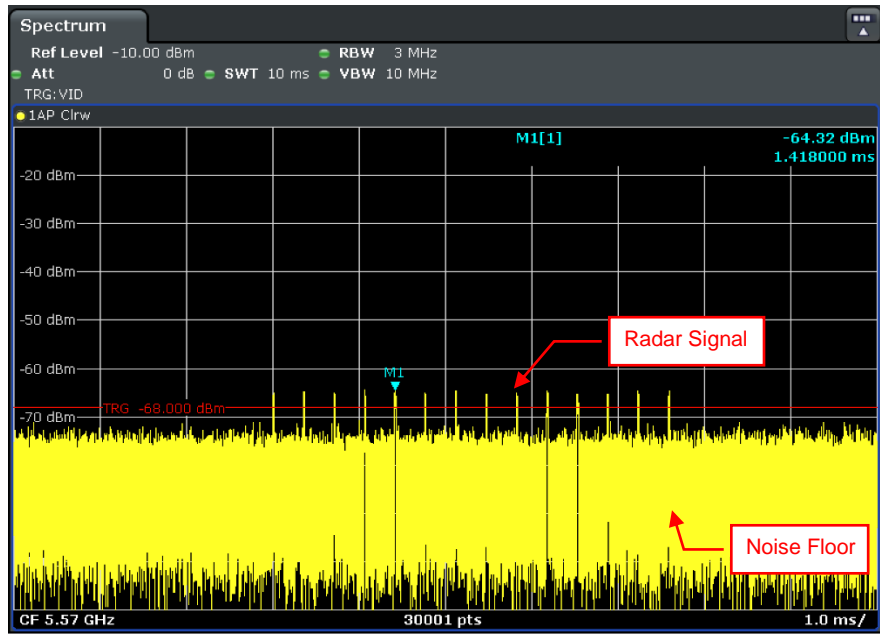

Single Burst of Radar Signal 4

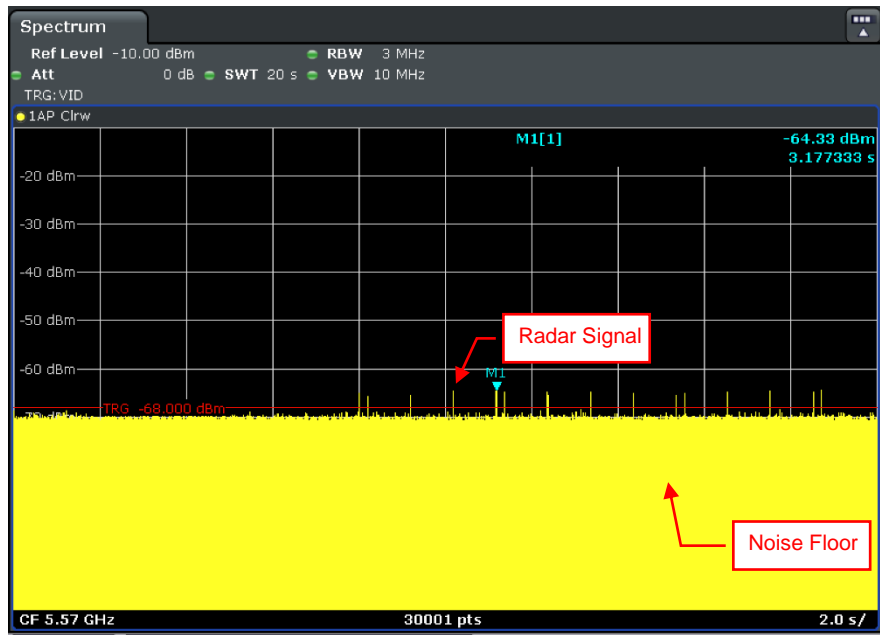

Radar Signal 5

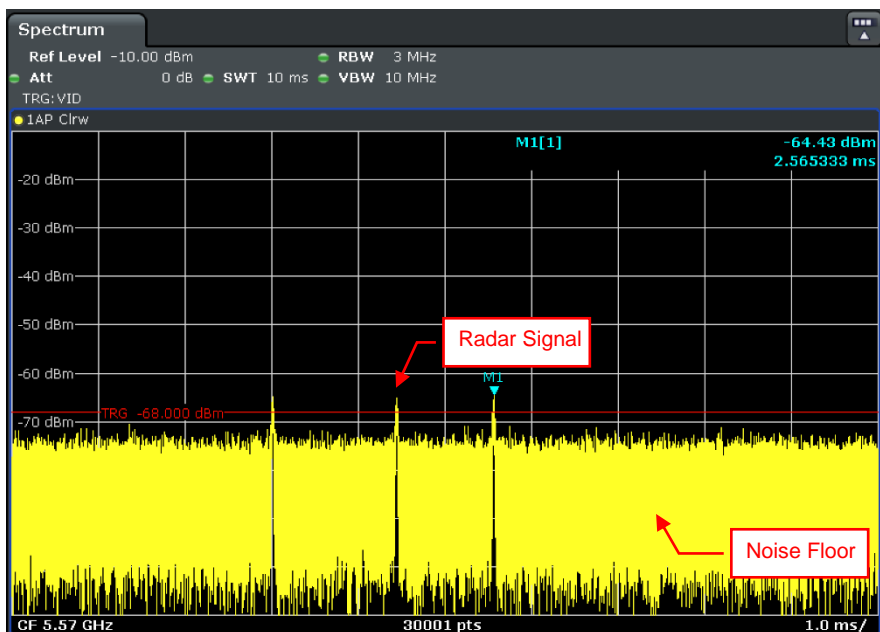

Single Burst of Radar Signal 5

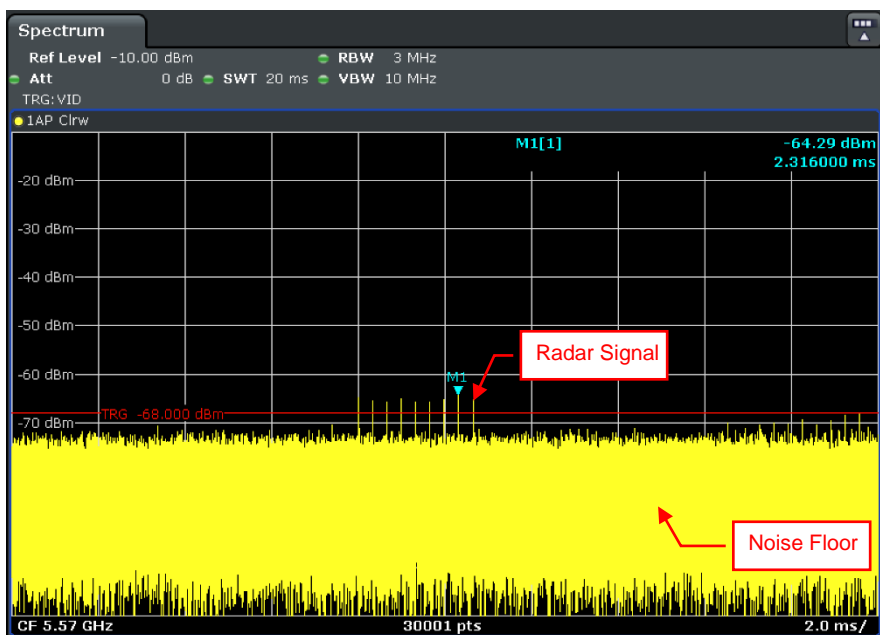

Radar Signal 6

## 6.2.2 U-NII Detection Bandwidth

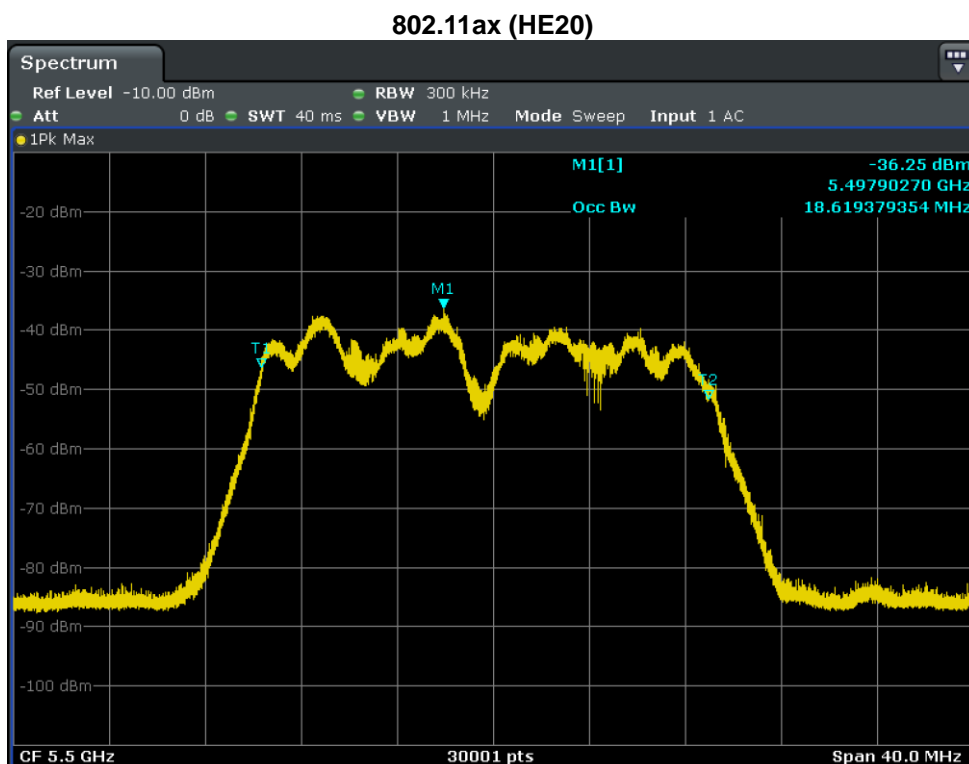

U-NII 99% Channel bandwidth

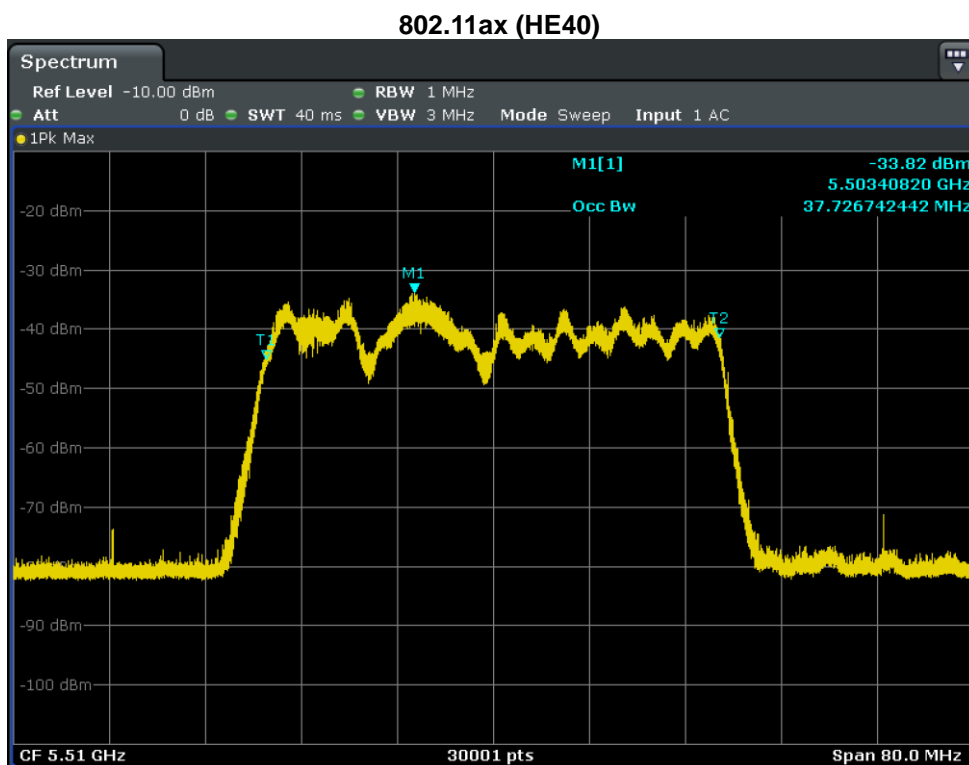

U-NII 99% Channel bandwidth

### 802.11ax (HE80)

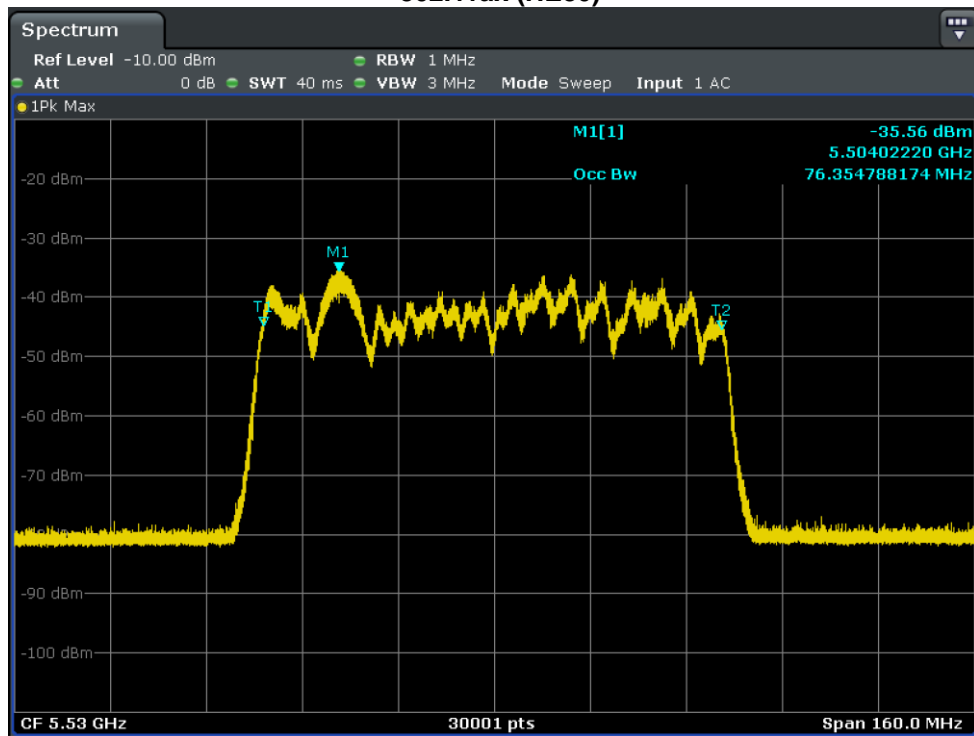

U-NII 99% Channel bandwidth

### 802.11ax (HE160)

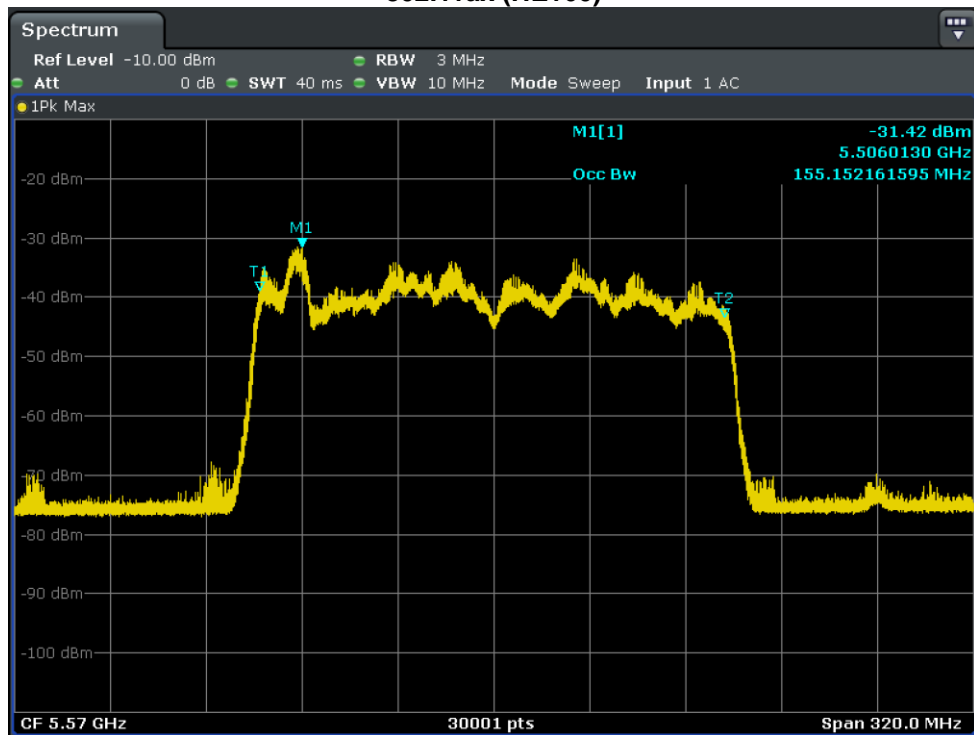

U-NII 99% Channel bandwidth



**Detection Bandwidth Test - 802.11ax (HE20)**

Radar Type 0

EUT Frequency: 5500MHz

EUT 99% Power bandwidth: 18.619MHz

Detection bandwidth limit (100% of EUT 99% Power bandwidth): 18.619MHz

Detection bandwidth (5510(FH) – 5490(FL)) : 20MHz

Test Result : PASS

Radar Frequency (MHz)	Trial Number / Detection										Detection Rate (%)
	1	2	3	4	5	6	7	8	9	10	
5490(FL)	Yes	Yes	Yes	Yes	Yes	Yes	Yes	Yes	Yes	Yes	100
5491	Yes	Yes	Yes	Yes	Yes	Yes	Yes	Yes	Yes	Yes	100
5492	Yes	Yes	Yes	Yes	Yes	Yes	Yes	Yes	Yes	Yes	100
5493	Yes	Yes	Yes	Yes	Yes	Yes	Yes	Yes	Yes	Yes	100
5494	Yes	Yes	Yes	Yes	Yes	Yes	Yes	Yes	Yes	Yes	100
5495	Yes	Yes	Yes	Yes	Yes	Yes	Yes	Yes	Yes	Yes	100
5496	Yes	Yes	Yes	Yes	Yes	Yes	Yes	Yes	Yes	Yes	100
5497	Yes	Yes	Yes	Yes	Yes	Yes	Yes	Yes	Yes	Yes	100
5498	Yes	Yes	Yes	Yes	Yes	Yes	Yes	Yes	Yes	Yes	100
5499	Yes	Yes	Yes	Yes	Yes	Yes	Yes	Yes	Yes	Yes	100
5500	Yes	Yes	Yes	Yes	Yes	Yes	Yes	Yes	Yes	Yes	100
5501	Yes	Yes	Yes	Yes	Yes	Yes	Yes	Yes	Yes	Yes	100
5502	Yes	Yes	Yes	Yes	Yes	Yes	Yes	Yes	Yes	Yes	100
5503	Yes	Yes	Yes	Yes	Yes	Yes	Yes	Yes	Yes	Yes	100
5504	Yes	Yes	Yes	Yes	Yes	Yes	Yes	Yes	Yes	Yes	100
5505	Yes	Yes	Yes	Yes	Yes	Yes	Yes	Yes	Yes	Yes	100
5506	Yes	Yes	Yes	Yes	Yes	Yes	Yes	Yes	Yes	Yes	100
5507	Yes	Yes	Yes	Yes	Yes	Yes	Yes	Yes	Yes	Yes	100
5508	Yes	Yes	Yes	Yes	Yes	Yes	Yes	Yes	Yes	Yes	100
5509	Yes	Yes	Yes	Yes	Yes	Yes	Yes	Yes	Yes	Yes	100
5510(FH)	Yes	Yes	Yes	Yes	Yes	Yes	Yes	Yes	Yes	Yes	100

Detection Bandwidth Test - <b>802.11ax (HE40)</b>											
Radar Type 0											
EUT Frequency: 5510MHz											
EUT 99% Power bandwidth: 37.726MHz											
Detection bandwidth limit (100% of EUT 99% Power bandwidth): 37.726MHz											
Detection bandwidth (5529(FH) – 5491(FL)) : 38MHz											
Test Result : PASS											
Radar Frequency (MHz)	Trial Number / Detection										Detection Rate (%)
	1	2	3	4	5	6	7	8	9	10	
5491(FL)	Yes	Yes	Yes	Yes	Yes	Yes	Yes	Yes	Yes	Yes	100
5492	Yes	Yes	Yes	Yes	Yes	Yes	Yes	Yes	Yes	Yes	100
5493	Yes	Yes	Yes	Yes	Yes	Yes	Yes	Yes	Yes	Yes	100
5494	Yes	Yes	Yes	Yes	Yes	Yes	Yes	Yes	Yes	Yes	100
5495	Yes	Yes	Yes	Yes	Yes	Yes	Yes	Yes	Yes	Yes	100
5496	Yes	Yes	Yes	Yes	Yes	Yes	Yes	Yes	Yes	Yes	100
5497	Yes	Yes	Yes	Yes	Yes	Yes	Yes	Yes	Yes	Yes	100
5498	Yes	Yes	Yes	Yes	Yes	Yes	Yes	Yes	Yes	Yes	100
5499	Yes	Yes	Yes	Yes	Yes	Yes	Yes	Yes	Yes	Yes	100
5500	Yes	Yes	Yes	Yes	Yes	Yes	Yes	Yes	Yes	Yes	100
5501	Yes	Yes	Yes	Yes	Yes	Yes	Yes	Yes	Yes	Yes	100
5502	Yes	Yes	Yes	Yes	Yes	Yes	Yes	Yes	Yes	Yes	100
5503	Yes	Yes	Yes	Yes	Yes	Yes	Yes	Yes	Yes	Yes	100
5504	Yes	Yes	Yes	Yes	Yes	Yes	Yes	Yes	Yes	Yes	100
5505	Yes	Yes	Yes	Yes	Yes	Yes	Yes	Yes	Yes	Yes	100
5506	Yes	Yes	Yes	Yes	Yes	Yes	Yes	Yes	Yes	Yes	100
5507	Yes	Yes	Yes	Yes	Yes	Yes	Yes	Yes	Yes	Yes	100
5508	Yes	Yes	Yes	Yes	Yes	Yes	Yes	Yes	Yes	Yes	100
5509	Yes	Yes	Yes	Yes	Yes	Yes	Yes	Yes	Yes	Yes	100
5510	Yes	Yes	Yes	Yes	Yes	Yes	Yes	Yes	Yes	Yes	100
5511	Yes	Yes	Yes	Yes	Yes	Yes	Yes	Yes	Yes	Yes	100
5512	Yes	Yes	Yes	Yes	Yes	Yes	Yes	Yes	Yes	Yes	100
5513	Yes	Yes	Yes	Yes	Yes	Yes	Yes	Yes	Yes	Yes	100
5514	Yes	Yes	Yes	Yes	Yes	Yes	Yes	Yes	Yes	Yes	100
5515	Yes	Yes	Yes	Yes	Yes	Yes	Yes	Yes	Yes	Yes	100
5516	Yes	Yes	Yes	Yes	Yes	Yes	Yes	Yes	Yes	Yes	100
5517	Yes	Yes	Yes	Yes	Yes	Yes	Yes	Yes	Yes	Yes	100
5518	Yes	Yes	Yes	Yes	Yes	Yes	Yes	Yes	Yes	Yes	100
5519	Yes	Yes	Yes	Yes	Yes	Yes	Yes	Yes	Yes	Yes	100
5520	Yes	Yes	Yes	Yes	Yes	Yes	Yes	Yes	Yes	Yes	100
5521	Yes	Yes	Yes	Yes	Yes	Yes	Yes	Yes	Yes	Yes	100
5522	Yes	Yes	Yes	Yes	Yes	Yes	Yes	Yes	Yes	Yes	100
5523	Yes	Yes	Yes	Yes	Yes	Yes	Yes	Yes	Yes	Yes	100
5524	Yes	Yes	Yes	Yes	Yes	Yes	Yes	Yes	Yes	Yes	100
5525	Yes	Yes	Yes	Yes	Yes	Yes	Yes	Yes	Yes	Yes	100
5526	Yes	Yes	Yes	Yes	Yes	Yes	Yes	Yes	Yes	Yes	100
5527	Yes	Yes	Yes	Yes	Yes	Yes	Yes	Yes	Yes	Yes	100
5528	Yes	Yes	Yes	Yes	Yes	Yes	Yes	Yes	Yes	Yes	100
5529(FH)	Yes	Yes	Yes	Yes	Yes	Yes	Yes	Yes	Yes	Yes	100

Detection Bandwidth Test - <b>802.11ax (HE80)</b>											
Radar Type 0											
EUT Frequency: 5530MHz											
EUT 99% Power bandwidth: 76.354MHz											
Detection bandwidth limit (100% of EUT 99% Power bandwidth): 76.354MHz											
Detection bandwidth (5569(FH) – 5491(FL)) : 78MHz											
Test Result : PASS											
Radar Frequency (MHz)	Trial Number / Detection										Detection Rate (%)
	1	2	3	4	5	6	7	8	9	10	
5491(FL)	Yes	Yes	Yes	Yes	Yes	Yes	Yes	Yes	Yes	Yes	100
5492	Yes	Yes	Yes	Yes	Yes	Yes	Yes	Yes	Yes	Yes	100
5493	Yes	Yes	Yes	Yes	Yes	Yes	Yes	Yes	Yes	Yes	100
5494	Yes	Yes	Yes	Yes	Yes	Yes	Yes	Yes	Yes	Yes	100
5495	Yes	Yes	Yes	Yes	Yes	Yes	Yes	Yes	Yes	Yes	100
5496	Yes	Yes	Yes	Yes	Yes	Yes	Yes	Yes	Yes	Yes	100
5497	Yes	Yes	Yes	Yes	Yes	Yes	Yes	Yes	Yes	Yes	100
5498	Yes	Yes	Yes	Yes	Yes	Yes	Yes	Yes	Yes	Yes	100
5499	Yes	Yes	Yes	Yes	Yes	Yes	Yes	Yes	Yes	Yes	100
5500	Yes	Yes	Yes	Yes	Yes	Yes	Yes	Yes	Yes	Yes	100
5501	Yes	Yes	Yes	Yes	Yes	Yes	Yes	Yes	Yes	Yes	100
5502	Yes	Yes	Yes	Yes	Yes	Yes	Yes	Yes	Yes	Yes	100
5503	Yes	Yes	Yes	Yes	Yes	Yes	Yes	Yes	Yes	Yes	100
5504	Yes	Yes	Yes	Yes	Yes	Yes	Yes	Yes	Yes	Yes	100
5505	Yes	Yes	Yes	Yes	Yes	Yes	Yes	Yes	Yes	Yes	100
5506	Yes	Yes	Yes	Yes	Yes	Yes	Yes	Yes	Yes	Yes	100
5507	Yes	Yes	Yes	Yes	Yes	Yes	Yes	Yes	Yes	Yes	100
5508	Yes	Yes	Yes	Yes	Yes	Yes	Yes	Yes	Yes	Yes	100
5509	Yes	Yes	Yes	Yes	Yes	Yes	Yes	Yes	Yes	Yes	100
5510	Yes	Yes	Yes	Yes	Yes	Yes	Yes	Yes	Yes	Yes	100
5511	Yes	Yes	Yes	Yes	Yes	Yes	Yes	Yes	Yes	Yes	100
5512	Yes	Yes	Yes	Yes	Yes	Yes	Yes	Yes	Yes	Yes	100
5513	Yes	Yes	Yes	Yes	Yes	Yes	Yes	Yes	Yes	Yes	100
5514	Yes	Yes	Yes	Yes	Yes	Yes	Yes	Yes	Yes	Yes	100
5515	Yes	Yes	Yes	Yes	Yes	Yes	Yes	Yes	Yes	Yes	100
5516	Yes	Yes	Yes	Yes	Yes	Yes	Yes	Yes	Yes	Yes	100
5517	Yes	Yes	Yes	Yes	Yes	Yes	Yes	Yes	Yes	Yes	100
5518	Yes	Yes	Yes	Yes	Yes	Yes	Yes	Yes	Yes	Yes	100
5519	Yes	Yes	Yes	Yes	Yes	Yes	Yes	Yes	Yes	Yes	100
5520	Yes	Yes	Yes	Yes	Yes	Yes	Yes	Yes	Yes	Yes	100
5521	Yes	Yes	Yes	Yes	Yes	Yes	Yes	Yes	Yes	Yes	100
5522	Yes	Yes	Yes	Yes	Yes	Yes	Yes	Yes	Yes	Yes	100
5523	Yes	Yes	Yes	Yes	Yes	Yes	Yes	Yes	Yes	Yes	100
5524	Yes	Yes	Yes	Yes	Yes	Yes	Yes	Yes	Yes	Yes	100
5525	Yes	Yes	Yes	Yes	Yes	Yes	Yes	Yes	Yes	Yes	100
5526	Yes	Yes	Yes	Yes	Yes	Yes	Yes	Yes	Yes	Yes	100
5527	Yes	Yes	Yes	Yes	Yes	Yes	Yes	Yes	Yes	Yes	100
5528	Yes	Yes	Yes	Yes	Yes	Yes	Yes	Yes	Yes	Yes	100
5529	Yes	Yes	Yes	Yes	Yes	Yes	Yes	Yes	Yes	Yes	100
5530	Yes	Yes	Yes	Yes	Yes	Yes	Yes	Yes	Yes	Yes	100
5531	Yes	Yes	Yes	Yes	Yes	Yes	Yes	Yes	Yes	Yes	100
5532	Yes	Yes	Yes	Yes	Yes	Yes	Yes	Yes	Yes	Yes	100
5533	Yes	Yes	Yes	Yes	Yes	Yes	Yes	Yes	Yes	Yes	100
5534	Yes	Yes	Yes	Yes	Yes	Yes	Yes	Yes	Yes	Yes	100
5535	Yes	Yes	Yes	Yes	Yes	Yes	Yes	Yes	Yes	Yes	100



5536	Yes	Yes	Yes	Yes	Yes	Yes	Yes	Yes	Yes	Yes	100
5537	Yes	Yes	Yes	Yes	Yes	Yes	Yes	Yes	Yes	Yes	100
5538	Yes	Yes	Yes	Yes	Yes	Yes	Yes	Yes	Yes	Yes	100
5539	Yes	Yes	Yes	Yes	Yes	Yes	Yes	Yes	Yes	Yes	100
5540	Yes	Yes	Yes	Yes	Yes	Yes	Yes	Yes	Yes	Yes	100
5541	Yes	Yes	Yes	Yes	Yes	Yes	Yes	Yes	Yes	Yes	100
5542	Yes	Yes	Yes	Yes	Yes	Yes	Yes	Yes	Yes	Yes	100
5543	Yes	Yes	Yes	Yes	Yes	Yes	Yes	Yes	Yes	Yes	100
5544	Yes	Yes	Yes	Yes	Yes	Yes	Yes	Yes	Yes	Yes	100
5545	Yes	Yes	Yes	Yes	Yes	Yes	Yes	Yes	Yes	Yes	100
5546	Yes	Yes	Yes	Yes	Yes	Yes	Yes	Yes	Yes	Yes	100
5547	Yes	Yes	Yes	Yes	Yes	Yes	Yes	Yes	Yes	Yes	100
5548	Yes	Yes	Yes	Yes	Yes	Yes	Yes	Yes	Yes	Yes	100
5549	Yes	Yes	Yes	Yes	Yes	Yes	Yes	Yes	Yes	Yes	100
5550	Yes	Yes	Yes	Yes	Yes	Yes	Yes	Yes	Yes	Yes	100
5551	Yes	Yes	Yes	Yes	Yes	Yes	Yes	Yes	Yes	Yes	100
5552	Yes	Yes	Yes	Yes	Yes	Yes	Yes	Yes	Yes	Yes	100
5553	Yes	Yes	Yes	Yes	Yes	Yes	Yes	Yes	Yes	Yes	100
5554	Yes	Yes	Yes	Yes	Yes	Yes	Yes	Yes	Yes	Yes	100
5555	Yes	Yes	Yes	Yes	Yes	Yes	Yes	Yes	Yes	Yes	100
5556	Yes	Yes	Yes	Yes	Yes	Yes	Yes	Yes	Yes	Yes	100
5557	Yes	Yes	Yes	Yes	Yes	Yes	Yes	Yes	Yes	Yes	100
5558	Yes	Yes	Yes	Yes	Yes	Yes	Yes	Yes	Yes	Yes	100
5559	Yes	Yes	Yes	Yes	Yes	Yes	Yes	Yes	Yes	Yes	100
5560	Yes	Yes	Yes	Yes	Yes	Yes	Yes	Yes	Yes	Yes	100
5561	Yes	Yes	Yes	Yes	Yes	Yes	Yes	Yes	Yes	Yes	100
5562	Yes	Yes	Yes	Yes	Yes	Yes	Yes	Yes	Yes	Yes	100
5563	Yes	Yes	Yes	Yes	Yes	Yes	Yes	Yes	Yes	Yes	100
5564	Yes	Yes	Yes	Yes	Yes	Yes	Yes	Yes	Yes	Yes	100
5565	Yes	Yes	Yes	Yes	Yes	Yes	Yes	Yes	Yes	Yes	100
5566	Yes	Yes	Yes	Yes	Yes	Yes	Yes	Yes	Yes	Yes	100
5567	Yes	Yes	Yes	Yes	Yes	Yes	Yes	Yes	Yes	Yes	100
5568	Yes	Yes	Yes	Yes	Yes	Yes	Yes	Yes	Yes	Yes	100
5569(FH)	Yes	Yes	Yes	Yes	Yes	Yes	Yes	Yes	Yes	Yes	100

Detection Bandwidth Test - <b>802.11ax (HE160)</b>											
Radar Type 0											
EUT Frequency: 5570MHz											
EUT 99% Power bandwidth: 155.152MHz											
Detection bandwidth limit (100% of EUT 99% Power bandwidth): 155.152MHz											
Detection bandwidth (5648(FH) – 5492(FL)) : 156MHz											
Test Result : PASS											
Radar Frequency (MHz)	Trial Number / Detection										Detection Rate (%)
	1	2	3	4	5	6	7	8	9	10	
5492(FL)	Yes	Yes	Yes	Yes	Yes	Yes	Yes	Yes	Yes	Yes	100
5493	Yes	Yes	Yes	Yes	Yes	Yes	Yes	Yes	Yes	Yes	100
5494	Yes	Yes	Yes	Yes	Yes	Yes	Yes	Yes	Yes	Yes	100
5495	Yes	Yes	Yes	Yes	Yes	Yes	Yes	Yes	Yes	Yes	100
5496	Yes	Yes	Yes	Yes	Yes	Yes	Yes	Yes	Yes	Yes	100
5497	Yes	Yes	Yes	Yes	Yes	Yes	Yes	Yes	Yes	Yes	100
5498	Yes	Yes	Yes	Yes	Yes	Yes	Yes	Yes	Yes	Yes	100
5499	Yes	Yes	Yes	Yes	Yes	Yes	Yes	Yes	Yes	Yes	100
5500	Yes	Yes	Yes	Yes	Yes	Yes	Yes	Yes	Yes	Yes	100
5501	Yes	Yes	Yes	Yes	Yes	Yes	Yes	Yes	Yes	Yes	100
5502	Yes	Yes	Yes	Yes	Yes	Yes	Yes	Yes	Yes	Yes	100
5503	Yes	Yes	Yes	Yes	Yes	Yes	Yes	Yes	Yes	Yes	100
5504	Yes	Yes	Yes	Yes	Yes	Yes	Yes	Yes	Yes	Yes	100
5505	Yes	Yes	Yes	Yes	Yes	Yes	Yes	Yes	Yes	Yes	100
5506	Yes	Yes	Yes	Yes	Yes	Yes	Yes	Yes	Yes	Yes	100
5507	Yes	Yes	Yes	Yes	Yes	Yes	Yes	Yes	Yes	Yes	100
5508	Yes	Yes	Yes	Yes	Yes	Yes	Yes	Yes	Yes	Yes	100
5509	Yes	Yes	Yes	Yes	Yes	Yes	Yes	Yes	Yes	Yes	100
5510	Yes	Yes	Yes	Yes	Yes	Yes	Yes	Yes	Yes	Yes	100
5511	Yes	Yes	Yes	Yes	Yes	Yes	Yes	Yes	Yes	Yes	100
5512	Yes	Yes	Yes	Yes	Yes	Yes	Yes	Yes	Yes	Yes	100
5513	Yes	Yes	Yes	Yes	Yes	Yes	Yes	Yes	Yes	Yes	100
5514	Yes	Yes	Yes	Yes	Yes	Yes	Yes	Yes	Yes	Yes	100
5515	Yes	Yes	Yes	Yes	Yes	Yes	Yes	Yes	Yes	Yes	100
5516	Yes	Yes	Yes	Yes	Yes	Yes	Yes	Yes	Yes	Yes	100
5517	Yes	Yes	Yes	Yes	Yes	Yes	Yes	Yes	Yes	Yes	100
5518	Yes	Yes	Yes	Yes	Yes	Yes	Yes	Yes	Yes	Yes	100
5519	Yes	Yes	Yes	Yes	Yes	Yes	Yes	Yes	Yes	Yes	100
5520	Yes	Yes	Yes	Yes	Yes	Yes	Yes	Yes	Yes	Yes	100
5521	Yes	Yes	Yes	Yes	Yes	Yes	Yes	Yes	Yes	Yes	100
5522	Yes	Yes	Yes	Yes	Yes	Yes	Yes	Yes	Yes	Yes	100
5523	Yes	Yes	Yes	Yes	Yes	Yes	Yes	Yes	Yes	Yes	100
5524	Yes	Yes	Yes	Yes	Yes	Yes	Yes	Yes	Yes	Yes	100
5525	Yes	Yes	Yes	Yes	Yes	Yes	Yes	Yes	Yes	Yes	100
5526	Yes	Yes	Yes	Yes	Yes	Yes	Yes	Yes	Yes	Yes	100
5527	Yes	Yes	Yes	Yes	Yes	Yes	Yes	Yes	Yes	Yes	100
5528	Yes	Yes	Yes	Yes	Yes	Yes	Yes	Yes	Yes	Yes	100
5529	Yes	Yes	Yes	Yes	Yes	Yes	Yes	Yes	Yes	Yes	100
5530	Yes	Yes	Yes	Yes	Yes	Yes	Yes	Yes	Yes	Yes	100
5531	Yes	Yes	Yes	Yes	Yes	Yes	Yes	Yes	Yes	Yes	100
5532	Yes	Yes	Yes	Yes	Yes	Yes	Yes	Yes	Yes	Yes	100
5533	Yes	Yes	Yes	Yes	Yes	Yes	Yes	Yes	Yes	Yes	100
5534	Yes	Yes	Yes	Yes	Yes	Yes	Yes	Yes	Yes	Yes	100
5535	Yes	Yes	Yes	Yes	Yes	Yes	Yes	Yes	Yes	Yes	100
5536	Yes	Yes	Yes	Yes	Yes	Yes	Yes	Yes	Yes	Yes	100







5647	Yes	Yes	Yes	Yes	Yes	Yes	Yes	Yes	Yes	Yes	100
5648(FH)	Yes	Yes	Yes	Yes	Yes	Yes	Yes	Yes	Yes	Yes	100



### 6.2.3 Channel Availability Check Time

If the EUT successfully detected the radar burst, it should be observed as the EUT has no transmissions occurred until the EUT starts transmitting on another channel.

Timing of Radar Signal	Observation	
	EUT	Spectrum Analyzer
Within 1 to 6 second	Detected	No transmissions
Within 54 to 60 second	Detected	No transmissions

### Initial Channel Availability Check Time

#### Channel Availability Check @ CH114 - 5570MHz

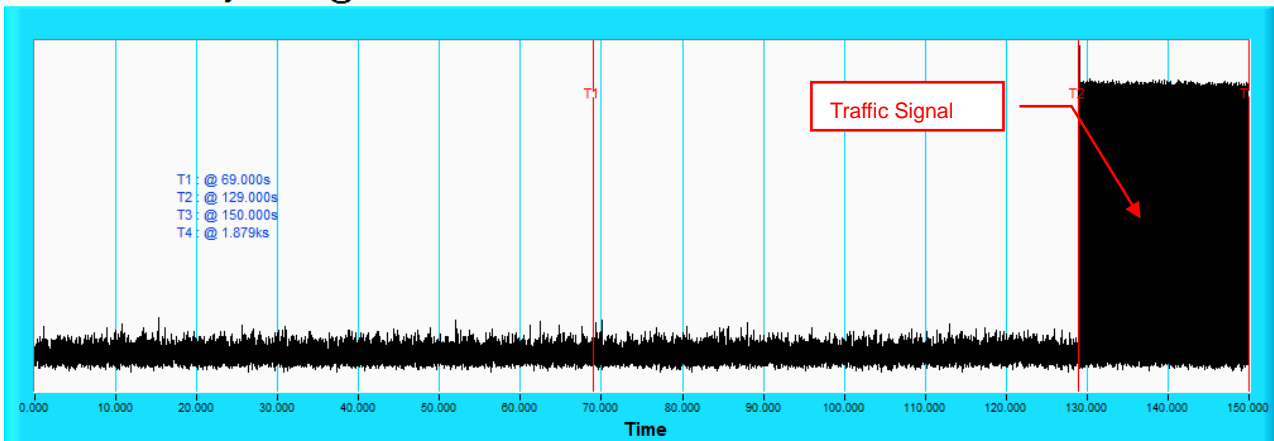

**NOTE:** T1 denotes the end of power-up time period is 69<sup>th</sup> second. T2 denotes the end of Channel Availability Check time is 129<sup>th</sup> second. Channel Availability Check time is equal to (T2 – T1) 60 seconds.

### Radar Burst at the Beginning of the Channel Availability Check Time

#### Channel Availability Check @ CH114 - 5570MHz

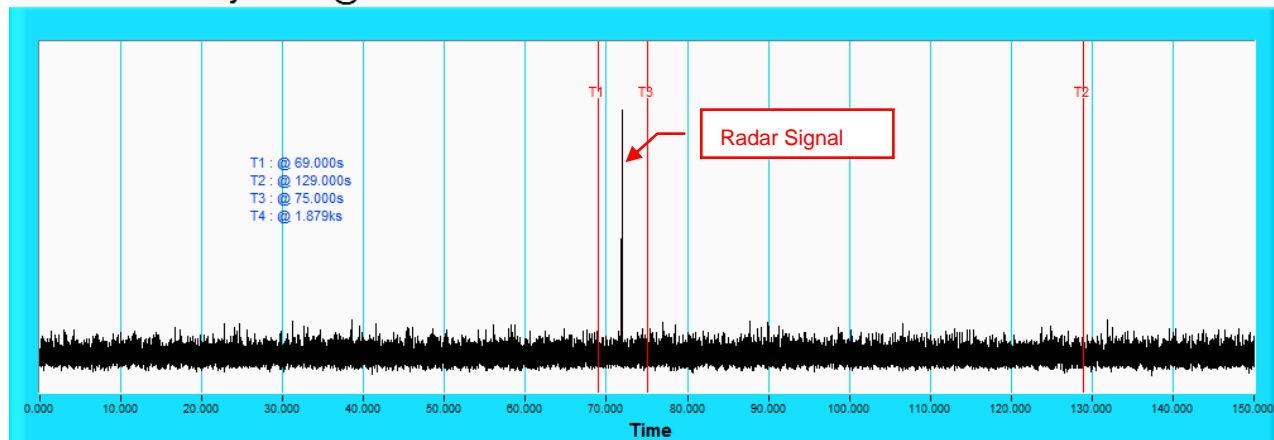

**NOTE:** T1 denotes the end of power up time period is 69<sup>th</sup> second. T3 denotes 75<sup>th</sup> second and the radar burst was commenced within a 6 second window starting from the end of power-up sequence. T2 denotes the 129<sup>th</sup> second.

### Radar Burst at the End of the Channel Availability Check Time

#### Channel Availability Check @ CH114 - 5570MHz

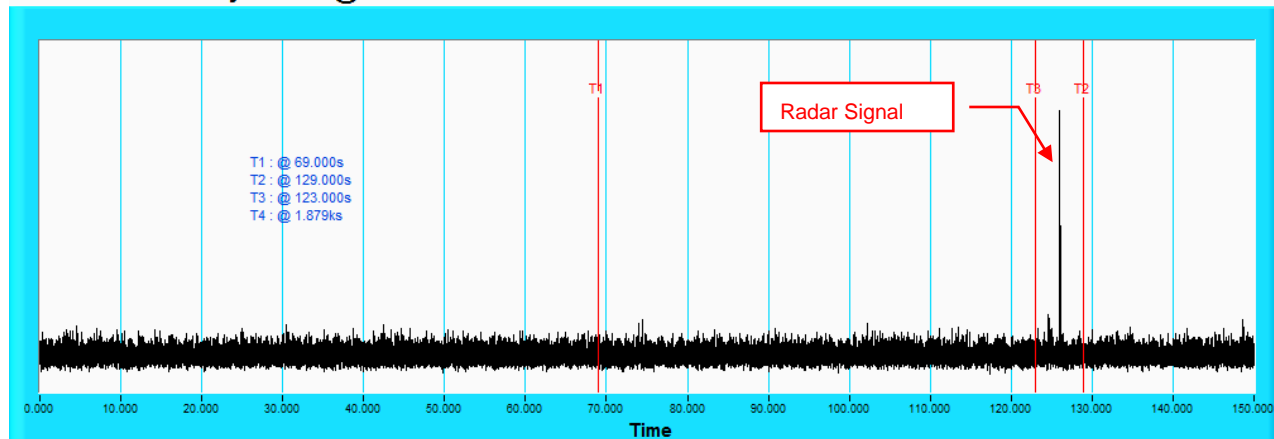

**NOTE:** T1 denotes the end of power up time period is 69<sup>th</sup> second. T3 denotes 123<sup>th</sup> second and the radar burst was commenced within 54<sup>th</sup> second to 60<sup>th</sup> second window starting from the end of power-up sequence. T2 denotes the 129<sup>th</sup> second.

## 6.2.4 Channel Closing Transmission and Channel Move Time

### Wireless Traffic Loading

#### 802.11ax (HE20)

##### Duty Cycle

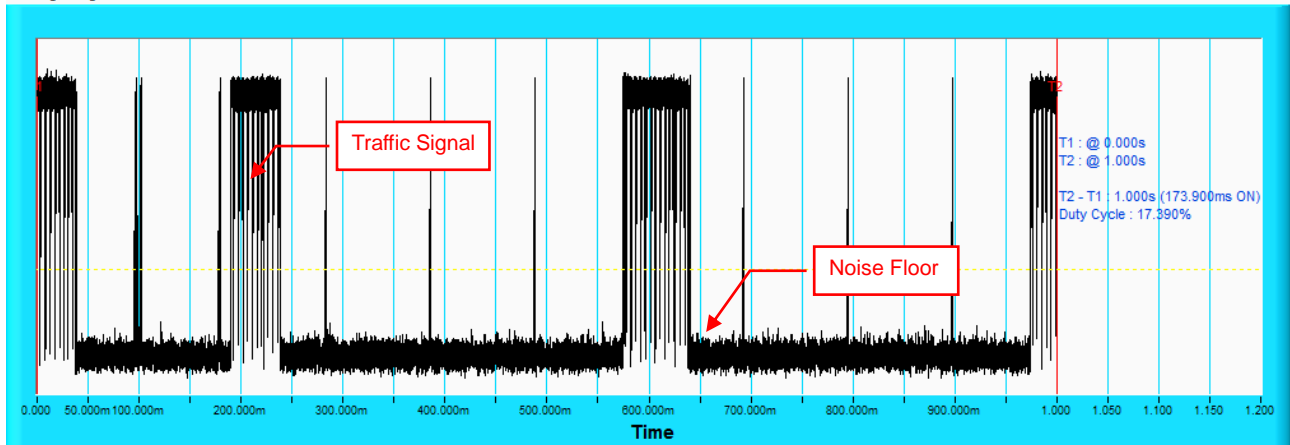

#### 802.11ax (HE40)

##### Duty Cycle

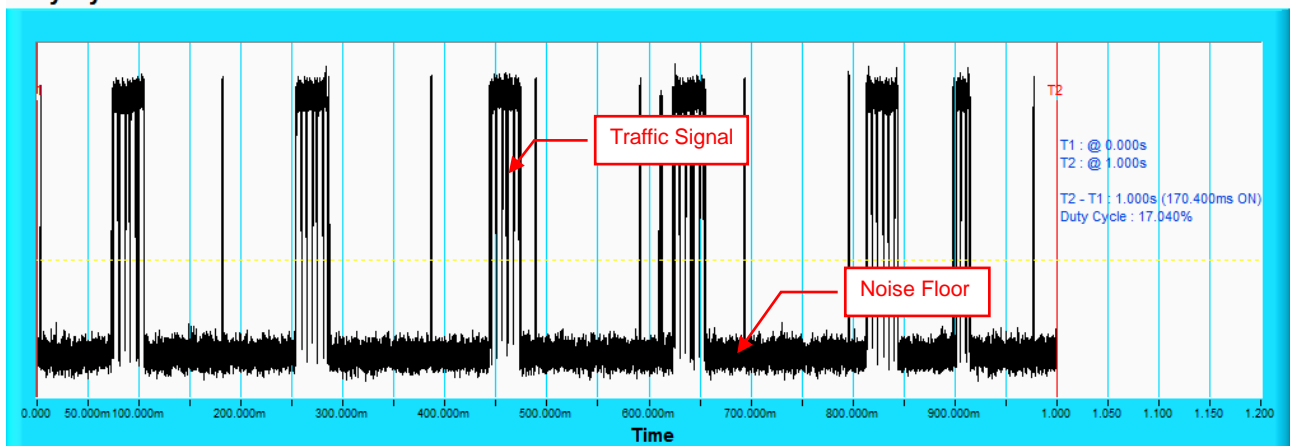

#### 802.11ax (HE80)

##### Duty Cycle

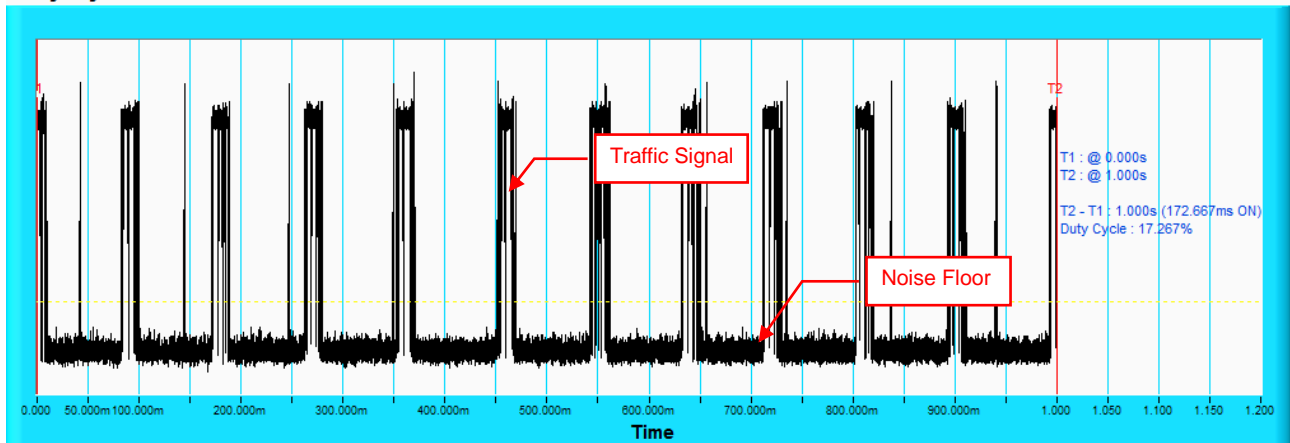



### 802.11ax (HE160)

#### Duty Cycle

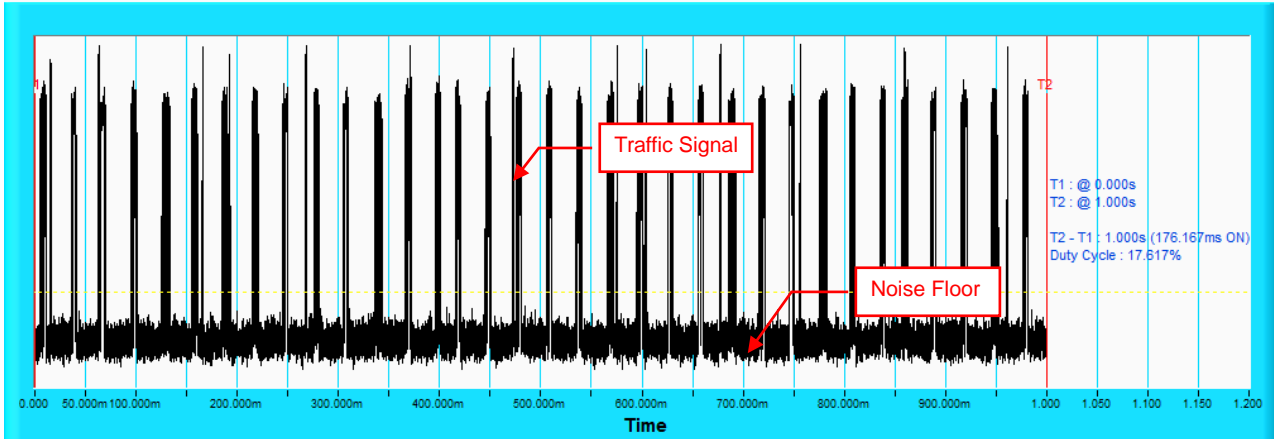

**802.11ax (HE20)**
**Table 1: Short Pulse Radar Test Waveforms**

Radar Type	Pulse Width (μsec)	PRI (μsec)	Number of Pulses	Number of Trials(Times)	Percentage of Successful Detection (%)
1	Test A 15 unique PRI values randomly selected from the list of 23 PRI values	Roundup $\left\{ \left( \frac{1}{360} \right) \cdot \left( \frac{19 \cdot 10^6}{\text{PRI}_{\mu\text{sec}}} \right) \right\}$	18	30	90
	15 unique PRI values randomly selected within the range of 518~3066 μ sec with a minimum of 1 μ sec, excluding PRI values selected in Test A				
2	1-5	150-230	23-29	30	90
3	6-10	200-500	16-18	30	80
4	11-20	200-500	12-16	30	73.3
Aggregate (Radar Types 1-4)				120	83.3

**Table 2: Long Pulse Radar Test Waveform**

Radar Type	Pulse Width (μsec)	Chirp Width (MHz)	PRI (μsec)	Number of Pulses per Burst	Number of Bursts	Number of Trials(Times)	Percentage of Successful Detection (%)
5	50-100	5-20	1000-2000	1-3	8-20	30	93.3

**Table 3: Frequency Hopping Radar Test Waveform**

Radar Type	Pulse Width (μsec)	PRI (μsec)	Pulses per Hop	Hopping Rate (kHz)	Hopping Sequence Length (msec)	Number of Trials(Times)	Percentage of Successful Detection (%)
6	1	333	9	0.333	300	30	90

**802.11ax (HE40)**
**Table 1: Short Pulse Radar Test Waveforms**

Radar Type	Pulse Width (μsec)	PRI (μsec)	Number of Pulses	Number of Trials(Times)	Percentage of Successful Detection (%)
1	Test A 15 unique PRI values randomly selected from the list of 23 PRI values	Roundup $\left\{ \left( \frac{1}{360} \right) \cdot \left( \frac{19 \cdot 10^6}{\text{PRI}_{\mu\text{sec}}} \right) \right\}$	18	30	93.3
	15 unique PRI values randomly selected within the range of 518~3066 μ sec with a minimum of 1 μ sec, excluding PRI values selected in Test A				
2	1-5	150-230	23-29	30	83.3
3	6-10	200-500	16-18	30	86.7
4	11-20	200-500	12-16	30	76.7
Aggregate (Radar Types 1-4)				120	85

**Table 2: Long Pulse Radar Test Waveform**

Radar Type	Pulse Width (μsec)	Chirp Width (MHz)	PRI (μsec)	Number of Pulses per Burst	Number of Bursts	Number of Trials(Times)	Percentage of Successful Detection (%)
5	50-100	5-20	1000-2000	1-3	8-20	30	86.7

**Table 3: Frequency Hopping Radar Test Waveform**

Radar Type	Pulse Width (μsec)	PRI (μsec)	Pulses per Hop	Hopping Rate (kHz)	Hopping Sequence Length (msec)	Number of Trials(Times)	Percentage of Successful Detection (%)
6	1	333	9	0.333	300	30	93.3

**802.11ax (HE80)**
**Table 1: Short Pulse Radar Test Waveforms**

Radar Type	Pulse Width (μsec)	PRI (μsec)	Number of Pulses	Number of Trials(Times)	Percentage of Successful Detection (%)
1	Test A 15 unique PRI values randomly selected from the list of 23 PRI values	Roundup $\left\{ \left( \frac{1}{360} \right) \cdot \left( \frac{19 \cdot 10^6}{\text{PRI}_{\mu\text{sec}}} \right) \right\}$	18	30	96.7
	15 unique PRI values randomly selected within the range of 518~3066 μ sec with a minimum of 1 μ sec, excluding PRI values selected in Test A				
2	1-5	150-230	23-29	30	76.7
3	6-10	200-500	16-18	30	86.7
4	11-20	200-500	12-16	30	70
Aggregate (Radar Types 1-4)				120	82.5

**Table 2: Long Pulse Radar Test Waveform**

Radar Type	Pulse Width (μsec)	Chirp Width (MHz)	PRI (μsec)	Number of Pulses per Burst	Number of Bursts	Number of Trials(Times)	Percentage of Successful Detection (%)
5	50-100	5-20	1000-2000	1-3	8-20	30	93.3

**Table 3: Frequency Hopping Radar Test Waveform**

Radar Type	Pulse Width (μsec)	PRI (μsec)	Pulses per Hop	Hopping Rate (kHz)	Hopping Sequence Length (msec)	Number of Trials(Times)	Percentage of Successful Detection (%)
6	1	333	9	0.333	300	30	93.3

**802.11ax (HE160)**
**Table 1: Short Pulse Radar Test Waveforms**

Radar Type	Pulse Width (μsec)	PRI (μsec)	Number of Pulses	Number of Trials(Times)	Percentage of Successful Detection (%)
1	Test A 15 unique PRI values randomly selected from the list of 23 PRI values	Roundup $\left\{ \left( \frac{1}{360} \right) \cdot \left( \frac{19 \cdot 10^6}{\text{PRI}_{\mu\text{sec}}} \right) \right\}$	18	30	93.3
	15 unique PRI values randomly selected within the range of 518~3066 μ sec with a minimum of 1 μ sec, excluding PRI values selected in Test A				
2	1-5	150-230	23-29	30	76.7
3	6-10	200-500	16-18	30	80
4	11-20	200-500	12-16	30	70
Aggregate (Radar Types 1-4)				120	80

**Table 2: Long Pulse Radar Test Waveform**

Radar Type	Pulse Width (μsec)	Chirp Width (MHz)	PRI (μsec)	Number of Pulses per Burst	Number of Bursts	Number of Trials(Times)	Percentage of Successful Detection (%)
5	50-100	5-20	1000-2000	1-3	8-20	30	93.3

**Table 3: Frequency Hopping Radar Test Waveform**

Radar Type	Pulse Width (μsec)	PRI (μsec)	Pulses per Hop	Hopping Rate (kHz)	Hopping Sequence Length (msec)	Number of Trials(Times)	Percentage of Successful Detection (%)
6	1	333	9	0.333	300	30	96.7



## 802.11ax (HE160)

### Radar signal 0

#### Channel Closing Transmission Time & Channel Move Time @ CH114 - 5570MHz

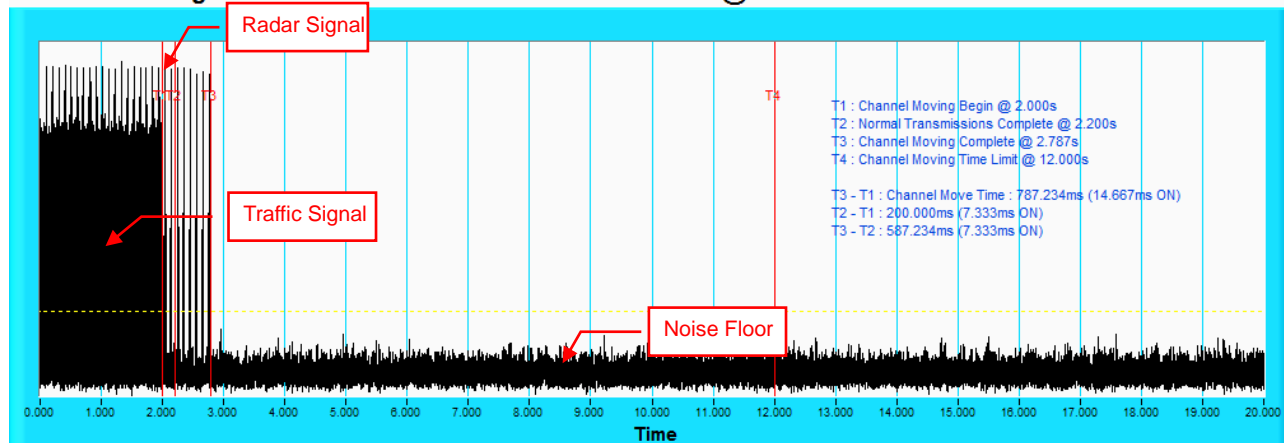

**NOTE:** T1 denotes the start of Channel Move Time upon the end of the last Radar burst. T2 denotes the data transmission time of 200ms from T1. T3 denotes the end of Channel Move Time. T4 denotes the 10 second from T1 to observe the aggregate duration of transmissions.

#### Channel Closing Transmission Time & Channel Move Time @ CH114 - 5570MHz

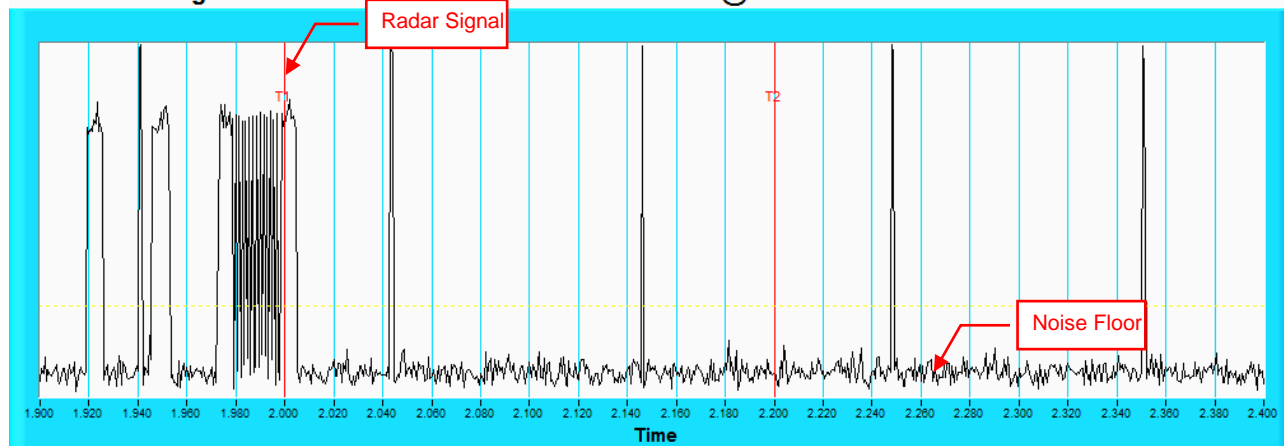

**NOTE:** Zoom in of the first 500ms after radar signal applied.

### Radar signal 1 Channel Closing Transmission Time & Channel Move Time @ CH114 - 5570MHz

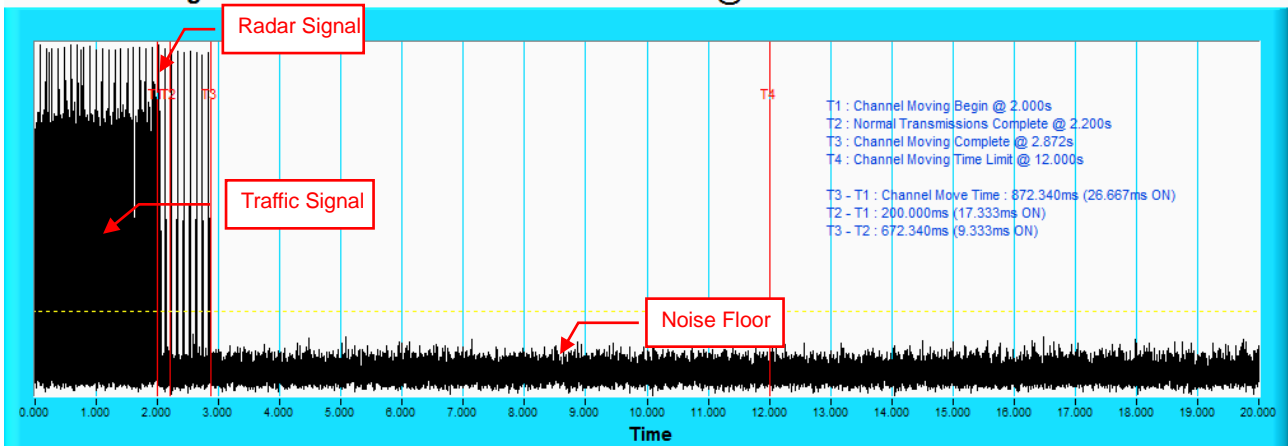

**NOTE:** T1 denotes the start of Channel Move Time upon the end of the last Radar burst. T2 denotes the data transmission time of 200ms from T1. T3 denotes the end of Channel Move Time. T4 denotes the 10 second from T1 to observe the aggregate duration of transmissions.

### Channel Closing Transmission Time & Channel Move Time @ CH114 - 5570MHz

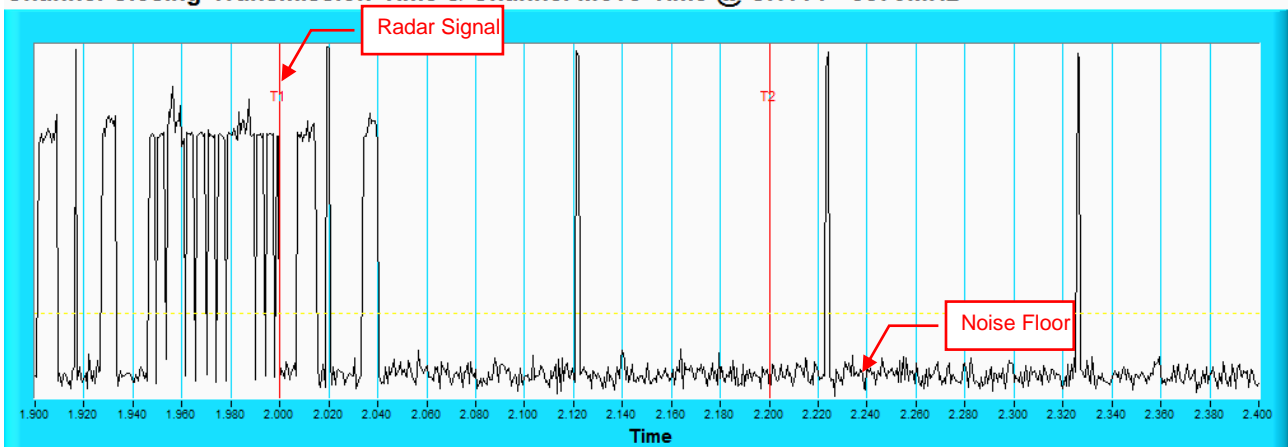

**NOTE:** Zoom in of the first 500ms after radar signal applied.

### Radar signal 2 Channel Closing Transmission Time & Channel Move Time @ CH114 - 5570MHz

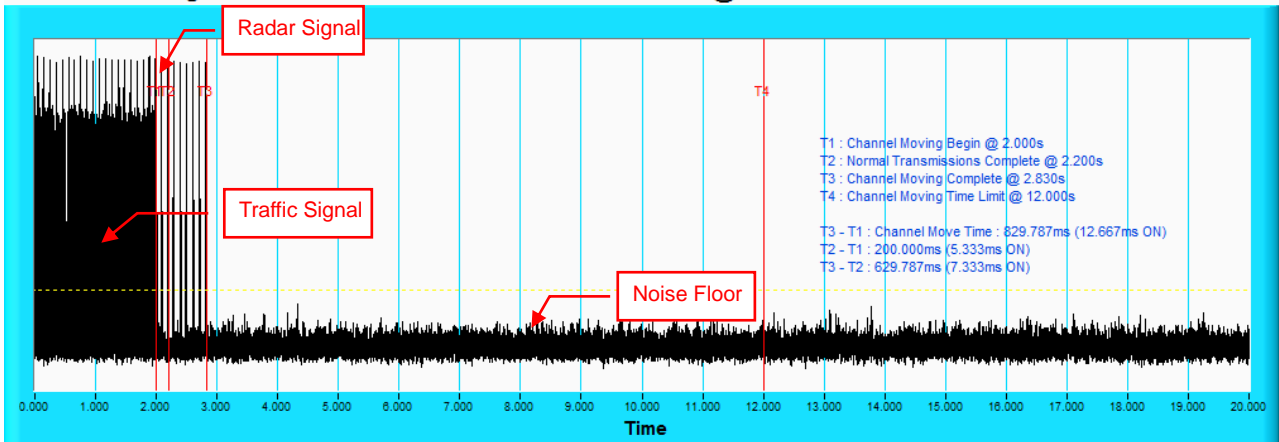

**NOTE:** T1 denotes the start of Channel Move Time upon the end of the last Radar burst. T2 denotes the data transmission time of 200ms from T1. T3 denotes the end of Channel Move Time. T4 denotes the 10 second from T1 to observe the aggregate duration of transmissions.

### Channel Closing Transmission Time & Channel Move Time @ CH114 - 5570MHz

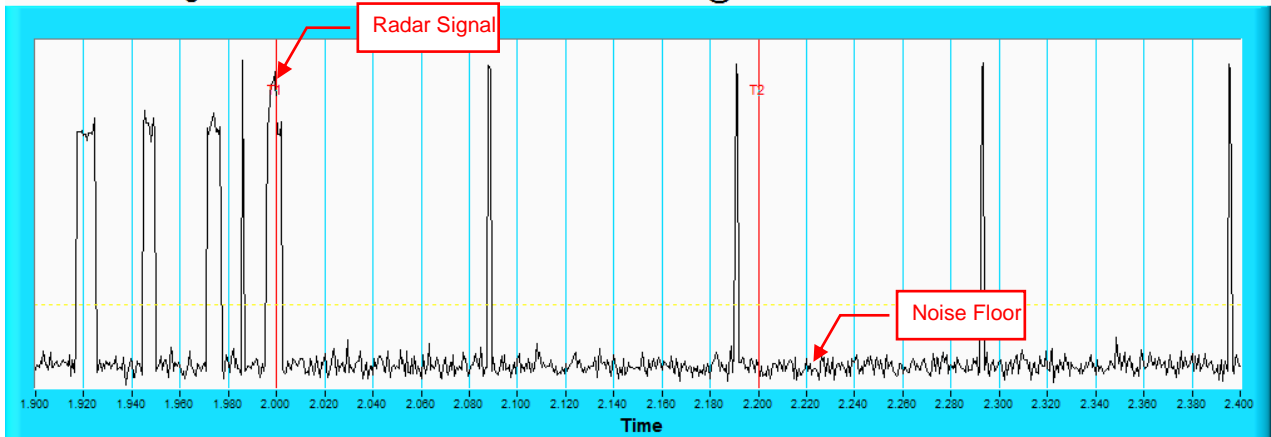

**NOTE:** Zoom in of the first 500ms after radar signal applied.

### Radar signal 3 Channel Closing Transmission Time & Channel Move Time @ CH114 - 5570MHz



**NOTE:** T1 denotes the start of Channel Move Time upon the end of the last Radar burst. T2 denotes the data transmission time of 200ms from T1. T3 denotes the end of Channel Move Time. T4 denotes the 10 second from T1 to observe the aggregate duration of transmissions.

### Channel Closing Transmission Time & Channel Move Time @ CH114 - 5570MHz

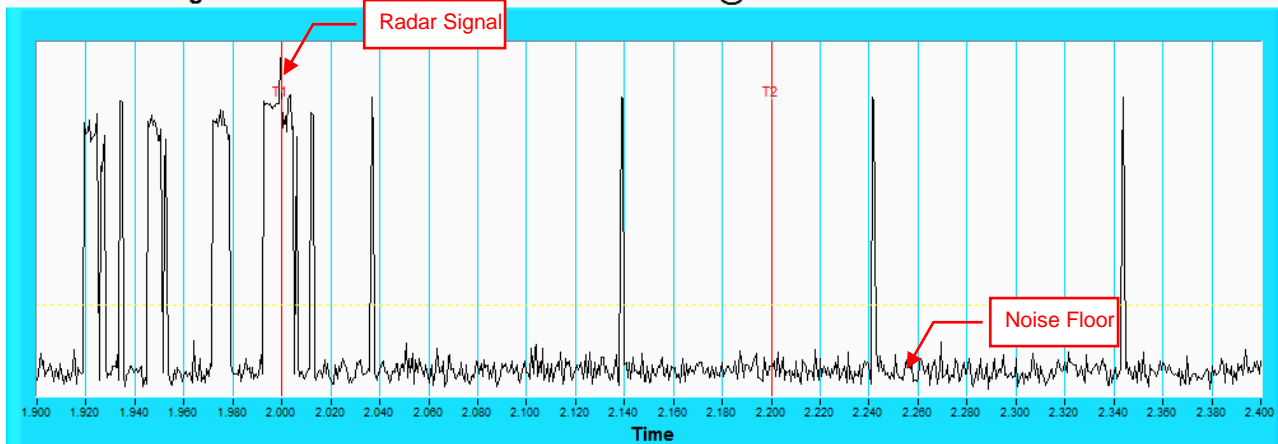

**NOTE:** Zoom in of the first 500ms after radar signal applied.

### Radar signal 4 Channel Closing Transmission Time & Channel Move Time @ CH114 - 5570MHz

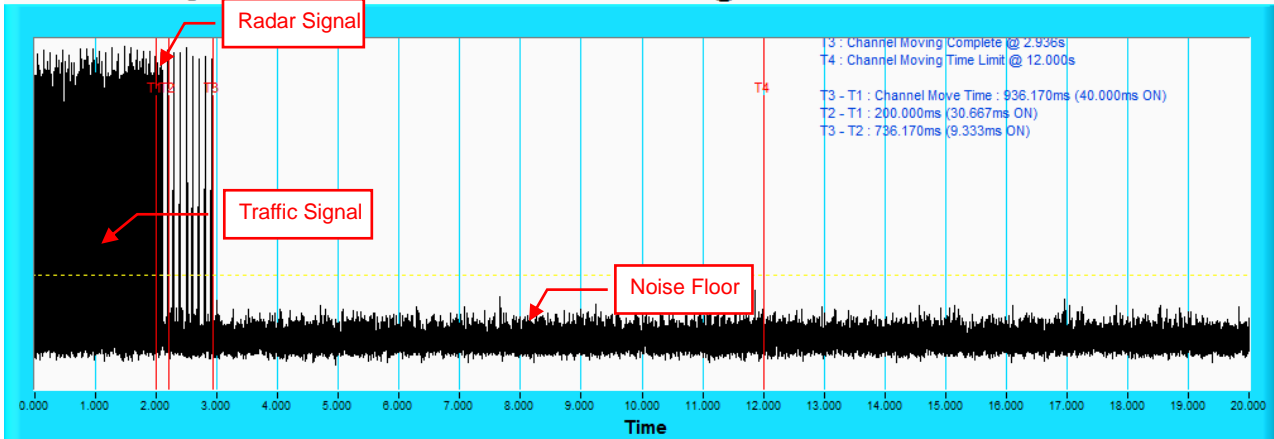

**NOTE:** T1 denotes the start of Channel Move Time upon the end of the last Radar burst. T2 denotes the data transmission time of 200ms from T1. T3 denotes the end of Channel Move Time. T4 denotes the 10 second from T1 to observe the aggregate duration of transmissions.

### Channel Closing Transmission Time & Channel Move Time @ CH114 - 5570MHz

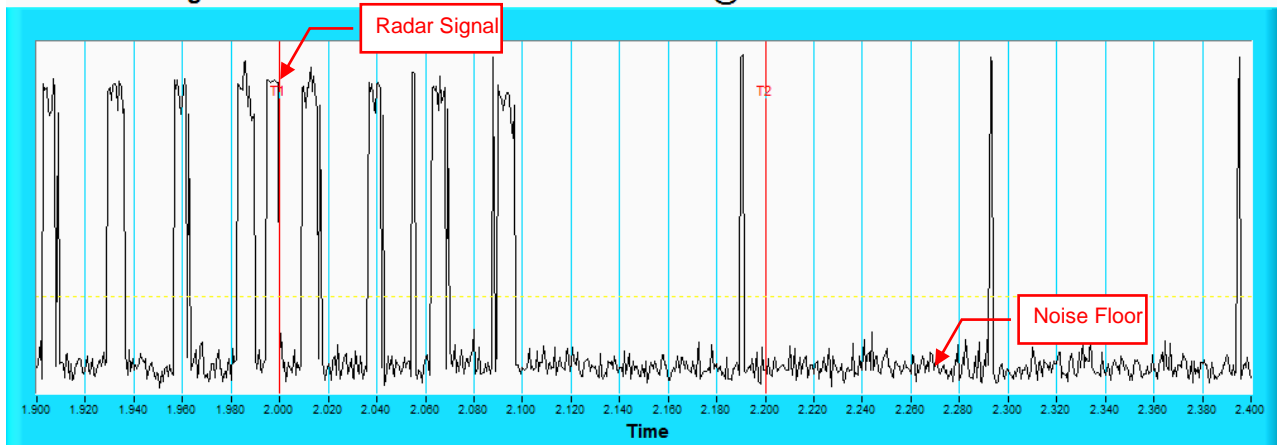

**NOTE:** Zoom in of the first 500ms after radar signal applied.



## 802.11ax (HE20)

### Type 1 Radar Statistical Performances

Trial #	Test Frequency (MHz)	Pulse Repetition Frequency Number (1 to 23)	Pulse Repetition Frequency (pps)	Pulses per Burst	Pulse Repetition Interval ( $\mu$ sec)	Detection
1	5500	5	1672	89	598	Yes
2	5503	23	326.2	18	918	Yes
3	5491	15	1253	67	778	Yes
4	5498	17	1193	63	3066	Yes
5	5503	9	1475	78	698	Yes
6	5499	7	1567	83	758	Yes
7	5500	4	1730	92	818	Yes
8	5494	16	1223	65	798	Yes
9	5504	8	1520	81	718	Yes
10	5500	22	1066	57	558	Yes
11	5501	6	1618	86	938	Yes
12	5495	18	1166	62	638	Yes
13	5509	14	1285	68	838	Yes
14	5506	10	1433	76	858	Yes
15	5491	2	1859	99	678	Yes
16	5504	-	416.1	22	656	Yes
17	5504	-	492.9	27	1334	Yes
18	5496	-	368.2	20	552	No
19	5501	-	386.2	21	1514	Yes
20	5494	-	394.5	21	2746	No
21	5495	-	360.1	20	1041	Yes
22	5501	-	494.1	27	2906	Yes
23	5498	-	897.7	48	2374	No
24	5497	-	962.5	51	1331	Yes
25	5491	-	380.2	21	1948	Yes
26	5492	-	452.7	24	974	Yes
27	5501	-	391.8	21	2443	Yes
28	5495	-	1083	58	1794	Yes
29	5498	-	329.7	18	1144	Yes
30	5494	-	502	27	2112	Yes

Detection Rate : 90%

Note. " - " : 15 unique PRI values randomly selected within the range of 518-3066  $\mu$ sec, with a minimum increment of 1 $\mu$ sec, excluding PRI values selected in Test A



## 802.11ax (HE20)

Type 2 Radar Statistical Performances					
Trial #	Test Frequency (MHz)	Pulses per Burst	Pulse Width(us)	PRI(us)	Detection
1	5500	24	2	224	Yes
2	5496	29	4.5	219	Yes
3	5504	26	3.2	167	Yes
4	5496	27	3.7	216	Yes
5	5495	23	1.1	179	No
6	5502	26	3.1	181	Yes
7	5504	27	3.7	188	Yes
8	5507	26	2.9	155	Yes
9	5491	29	4.8	214	Yes
10	5502	23	1.5	195	Yes
11	5500	29	4.9	201	Yes
12	5503	24	1.8	197	Yes
13	5497	23	1.5	158	Yes
14	5493	29	4.9	222	Yes
15	5494	28	4.2	185	Yes
16	5495	23	1	173	Yes
17	5508	29	4.8	190	Yes
18	5491	29	4.5	200	Yes
19	5508	25	2.3	165	Yes
20	5495	27	3.4	177	No
21	5507	23	1	183	No
22	5501	28	4	156	Yes
23	5508	23	1.1	213	Yes
24	5506	25	2.7	229	Yes
25	5502	23	1.2	206	Yes
26	5495	29	4.9	203	Yes
27	5502	26	3.3	163	Yes
28	5501	26	3.2	182	Yes
29	5491	24	1.7	166	Yes
30	5493	25	2.6	210	Yes

Detection Rate : 90%



### 802.11ax (HE20)

#### Type 3 Radar Statistical Performances

Trial #	Test Frequency (MHz)	Pulses per Burst	Pulse Width(us)	PRI(us)	Detection
1	5500	16	7	239	No
2	5509	18	9.5	335	Yes
3	5501	17	8.2	411	Yes
4	5496	18	8.7	224	Yes
5	5506	16	6.1	428	No
6	5502	17	8.1	332	Yes
7	5499	17	8.7	491	Yes
8	5509	17	7.9	348	No
9	5506	18	9.8	206	No
10	5509	16	6.5	204	Yes
11	5506	18	9.9	438	Yes
12	5491	16	6.8	484	Yes
13	5495	16	6.5	344	Yes
14	5493	18	9.9	465	No
15	5507	18	9.2	444	Yes
16	5498	16	6	357	Yes
17	5498	18	9.8	423	Yes
18	5503	18	9.5	225	Yes
19	5491	16	7.3	217	No
20	5497	17	8.4	242	Yes
21	5508	16	6	483	Yes
22	5506	18	9	470	Yes
23	5497	16	6.1	308	Yes
24	5505	17	7.7	498	Yes
25	5501	16	6.2	477	Yes
26	5508	18	9.9	375	Yes
27	5509	17	8.3	285	Yes
28	5495	17	8.2	433	Yes
29	5497	16	6.7	490	Yes
30	5497	17	7.6	202	Yes

Detection Rate : 80%





## 802.11ax (HE20)

Type 4 Radar Statistical Performances					
Trial #	Test Frequency (MHz)	Pulses per Burst	Pulse Width(us)	PRI(us)	Detection
1	5500	13	13.4	239	Yes
2	5505	16	18.8	335	Yes
3	5491	14	15.9	411	No
4	5509	15	17.1	224	Yes
5	5498	12	11.3	428	Yes
6	5508	14	15.8	332	No
7	5505	15	17	491	No
8	5491	14	15.3	348	Yes
9	5498	16	19.6	206	Yes
10	5497	12	12.1	204	No
11	5506	16	19.8	438	Yes
12	5497	13	12.8	484	Yes
13	5494	12	12.1	344	No
14	5509	16	19.6	465	Yes
15	5504	15	18.1	444	No
16	5491	12	11.1	357	Yes
17	5501	16	19.6	423	No
18	5508	16	18.9	225	Yes
19	5498	13	13.9	217	Yes
20	5494	15	16.5	242	Yes
21	5498	12	11	483	No
22	5509	15	17.6	470	Yes
23	5501	12	11.4	308	Yes
24	5506	14	14.7	498	Yes
25	5500	12	11.4	477	Yes
26	5505	16	19.7	375	Yes
27	5492	14	16.1	285	Yes
28	5493	14	16	433	Yes
29	5501	12	12.6	490	Yes
30	5505	14	14.7	202	Yes

Detection Rate : 73.3%



### 802.11ax (HE20)

#### Type 5 Radar Statistical Performances

Trial #	Minimum Chirp Width(MHz)	Chirp Center Frequency(MHz)	Test Signal Name	Detection
1	17	5500	LP_Signal_01	Yes
2	6	5500	LP_Signal_02	Yes
3	20	5500	LP_Signal_03	Yes
4	9	5500	LP_Signal_04	Yes
5	10	5500	LP_Signal_05	Yes
6	18	5500	LP_Signal_06	No
7	18	5500	LP_Signal_07	Yes
8	5	5500	LP_Signal_08	Yes
9	13	5500	LP_Signal_09	Yes
10	16	5500	LP_Signal_10	Yes
11	7	5493	LP_Signal_11	Yes
12	10	5494	LP_Signal_12	Yes
13	6	5492	LP_Signal_13	Yes
14	10	5494	LP_Signal_14	Yes
15	9	5494	LP_Signal_15	Yes
16	6	5492	LP_Signal_16	Yes
17	18	5497	LP_Signal_17	Yes
18	17	5497	LP_Signal_18	Yes
19	13	5495	LP_Signal_19	Yes
20	5	5492	LP_Signal_20	Yes
21	20	5502	LP_Signal_21	Yes
22	17	5503	LP_Signal_22	Yes
23	15	5504	LP_Signal_23	Yes
24	7	5507	LP_Signal_24	Yes
25	12	5505	LP_Signal_25	Yes
26	19	5502	LP_Signal_26	Yes
27	9	5506	LP_Signal_27	Yes
28	12	5505	LP_Signal_28	Yes
29	14	5504	LP_Signal_29	Yes
30	15	5504	LP_Signal_30	No

Detection Rate : 93.3%

Note: The Long Pulse Radar pattern shown in Appendix A.1



## 802.11ax (HE20)

Type 6 Radar Statistical Performances					
Trial #	Pulses per Burst	Pulse Width(us)	PRI(us)	Hopping Frequency Sequence Name	Detection
1	9	1	333.3	HOP_FREQ_SEQ_01	Yes
2	9	1	333.3	HOP_FREQ_SEQ_02	Yes
3	9	1	333.3	HOP_FREQ_SEQ_03	Yes
4	9	1	333.3	HOP_FREQ_SEQ_04	Yes
5	9	1	333.3	HOP_FREQ_SEQ_05	No
6	9	1	333.3	HOP_FREQ_SEQ_06	Yes
7	9	1	333.3	HOP_FREQ_SEQ_07	Yes
8	9	1	333.3	HOP_FREQ_SEQ_08	Yes
9	9	1	333.3	HOP_FREQ_SEQ_09	Yes
10	9	1	333.3	HOP_FREQ_SEQ_10	Yes
11	9	1	333.3	HOP_FREQ_SEQ_11	Yes
12	9	1	333.3	HOP_FREQ_SEQ_12	Yes
13	9	1	333.3	HOP_FREQ_SEQ_13	Yes
14	9	1	333.3	HOP_FREQ_SEQ_14	Yes
15	9	1	333.3	HOP_FREQ_SEQ_15	Yes
16	9	1	333.3	HOP_FREQ_SEQ_16	Yes
17	9	1	333.3	HOP_FREQ_SEQ_17	Yes
18	9	1	333.3	HOP_FREQ_SEQ_18	Yes
19	9	1	333.3	HOP_FREQ_SEQ_19	Yes
20	9	1	333.3	HOP_FREQ_SEQ_20	Yes
21	9	1	333.3	HOP_FREQ_SEQ_21	Yes
22	9	1	333.3	HOP_FREQ_SEQ_22	Yes
23	9	1	333.3	HOP_FREQ_SEQ_23	No
24	9	1	333.3	HOP_FREQ_SEQ_24	Yes
25	9	1	333.3	HOP_FREQ_SEQ_25	No
26	9	1	333.3	HOP_FREQ_SEQ_26	Yes
27	9	1	333.3	HOP_FREQ_SEQ_27	Yes
28	9	1	333.3	HOP_FREQ_SEQ_28	Yes
29	9	1	333.3	HOP_FREQ_SEQ_29	Yes
30	9	1	333.3	HOP_FREQ_SEQ_30	Yes

Detection Rate : 90%

Note: The Frequency Hopping Radar pattern shown in Appendix A.2



### 802.11ax (HE40)

#### Type 1 Radar Statistical Performances

Trial #	Test Frequency (MHz)	Pulse Repetition Frequency Number (1 to 23)	Pulse Repetition Frequency (pps)	Pulses per Burst	Pulse Repetition Interval (µsec)	Detection
1	5510	5	1672	89	598	Yes
2	5520	23	326.2	18	3066	Yes
3	5500	15	1253	67	798	Yes
4	5527	17	1193	63	838	Yes
5	5497	9	1475	78	678	Yes
6	5510	7	1567	83	638	Yes
7	5516	4	1730	92	578	Yes
8	5495	16	1223	65	818	Yes
9	5523	8	1520	81	658	Yes
10	5513	22	1066	57	938	Yes
11	5513	6	1618	86	618	Yes
12	5506	18	1166	62	858	Yes
13	5509	14	1285	68	778	Yes
14	5513	10	1433	76	698	Yes
15	5495	2	1859	99	538	Yes
16	5502	-	416.1	22	2403	Yes
17	5528	-	492.9	27	2029	Yes
18	5526	-	368.2	20	2716	Yes
19	5525	-	386.2	21	2589	No
20	5516	-	394.5	21	2535	Yes
21	5509	-	360.1	20	2777	Yes
22	5505	-	494.1	27	2024	Yes
23	5491	-	897.7	48	1114	Yes
24	5495	-	962.5	51	1039	Yes
25	5499	-	380.2	21	2630	Yes
26	5515	-	452.7	24	2209	Yes
27	5504	-	391.8	21	2552	Yes
28	5525	-	1083	58	923	Yes
29	5499	-	329.7	18	3033	No
30	5520	-	502	27	1992	Yes

Detection Rate : 93.3%

Note. " - " : 15 unique PRI values randomly selected within the range of 518-3066 µsec, with a minimum increment of 1µsec, excluding PRI values selected in Test A



## 802.11ax (HE40)

Type 2 Radar Statistical Performances					
Trial #	Test Frequency (MHz)	Pulses per Burst	Pulse Width(us)	PRI(us)	Detection
1	5510	24	2	224	Yes
2	5520	29	4.5	219	Yes
3	5500	26	3.2	167	Yes
4	5493	27	3.7	216	Yes
5	5517	23	1.1	179	Yes
6	5524	26	3.1	181	Yes
7	5517	27	3.7	188	Yes
8	5517	26	2.9	155	No
9	5517	29	4.8	214	Yes
10	5518	23	1.5	195	Yes
11	5521	29	4.9	201	Yes
12	5526	24	1.8	197	Yes
13	5525	23	1.5	158	Yes
14	5504	29	4.9	222	No
15	5498	28	4.2	185	Yes
16	5517	23	1	173	Yes
17	5494	29	4.8	190	Yes
18	5496	29	4.5	200	Yes
19	5493	25	2.3	165	Yes
20	5512	27	3.4	177	No
21	5521	23	1	183	No
22	5525	28	4	156	Yes
23	5509	23	1.1	213	Yes
24	5509	25	2.7	229	Yes
25	5526	23	1.2	206	No
26	5509	29	4.9	203	Yes
27	5494	26	3.3	163	Yes
28	5502	26	3.2	182	Yes
29	5520	24	1.7	166	Yes
30	5527	25	2.6	210	Yes

Detection Rate : 83.3%



### 802.11ax (HE40)

#### Type 3 Radar Statistical Performances

Trial #	Test Frequency (MHz)	Pulses per Burst	Pulse Width(us)	PRI(us)	Detection
1	5510	16	7	239	Yes
2	5520	18	9.5	335	Yes
3	5500	17	8.2	411	Yes
4	5521	18	8.7	224	Yes
5	5520	16	6.1	428	Yes
6	5514	17	8.1	332	Yes
7	5497	17	8.7	491	No
8	5510	17	7.9	348	Yes
9	5495	18	9.8	206	Yes
10	5521	16	6.5	204	Yes
11	5523	18	9.9	438	Yes
12	5527	16	6.8	484	Yes
13	5495	16	6.5	344	No
14	5492	18	9.9	465	Yes
15	5515	18	9.2	444	Yes
16	5522	16	6	357	Yes
17	5500	18	9.8	423	Yes
18	5494	18	9.5	225	No
19	5502	16	7.3	217	Yes
20	5529	17	8.4	242	Yes
21	5494	16	6	483	Yes
22	5508	18	9	470	No
23	5499	16	6.1	308	Yes
24	5505	17	7.7	498	Yes
25	5495	16	6.2	477	Yes
26	5498	18	9.9	375	Yes
27	5516	17	8.3	285	Yes
28	5509	17	8.2	433	Yes
29	5491	16	6.7	490	Yes
30	5508	17	7.6	202	Yes

Detection Rate : 86.7%



## 802.11ax (HE40)

Type 4 Radar Statistical Performances					
Trial #	Test Frequency (MHz)	Pulses per Burst	Pulse Width(us)	PRI(us)	Detection
1	5510	15	18.1	258	Yes
2	5520	12	12.3	493	No
3	5500	13	13.2	359	Yes
4	5504	16	19.1	397	Yes
5	5500	14	15.4	355	Yes
6	5499	14	14.6	428	No
7	5503	12	11.9	271	Yes
8	5495	16	19.9	371	Yes
9	5502	12	11.6	430	No
10	5510	14	15.4	272	Yes
11	5493	15	17.4	202	No
12	5491	16	19.9	264	Yes
13	5510	16	18.4	207	No
14	5504	14	15.3	456	Yes
15	5519	14	15.3	291	Yes
16	5519	15	16.8	411	Yes
17	5494	13	14.3	368	No
18	5497	14	15.5	241	Yes
19	5502	13	14.2	467	Yes
20	5514	16	20	339	Yes
21	5500	12	12.2	500	No
22	5522	16	19.9	358	Yes
23	5491	13	12.9	251	Yes
24	5499	15	17.9	230	Yes
25	5496	12	12.3	285	Yes
26	5511	15	16.5	426	Yes
27	5501	14	14.8	350	Yes
28	5521	12	12.6	434	Yes
29	5523	14	15.1	491	Yes
30	5523	13	12.9	438	Yes

Detection Rate : 76.7%



### 802.11ax (HE40)

#### Type 5 Radar Statistical Performances

Trial #	Minimum Chirp Width(MHz)	Chirp Center Frequency(MHz)	Test Signal Name	Detection
1	12	5510	LP_Signal_01	Yes
2	16	5510	LP_Signal_02	Yes
3	9	5510	LP_Signal_03	Yes
4	8	5510	LP_Signal_04	Yes
5	11	5510	LP_Signal_05	Yes
6	16	5510	LP_Signal_06	Yes
7	18	5510	LP_Signal_07	Yes
8	14	5510	LP_Signal_08	Yes
9	15	5510	LP_Signal_09	Yes
10	5	5510	LP_Signal_10	Yes
11	17	5498	LP_Signal_11	No
12	10	5495	LP_Signal_12	Yes
13	9	5495	LP_Signal_13	Yes
14	5	5493	LP_Signal_14	Yes
15	14	5497	LP_Signal_15	Yes
16	16	5497	LP_Signal_16	Yes
17	15	5497	LP_Signal_17	No
18	10	5495	LP_Signal_18	Yes
19	17	5498	LP_Signal_19	Yes
20	13	5496	LP_Signal_20	No
21	7	5526	LP_Signal_21	Yes
22	20	5521	LP_Signal_22	Yes
23	7	5526	LP_Signal_23	Yes
24	9	5525	LP_Signal_24	Yes
25	10	5525	LP_Signal_25	Yes
26	16	5523	LP_Signal_26	Yes
27	20	5521	LP_Signal_27	No
28	5	5527	LP_Signal_28	Yes
29	6	5527	LP_Signal_29	Yes
30	19	5521	LP_Signal_30	Yes

Detection Rate : 86.7%

Note: The Long Pulse Radar pattern shown in Appendix A.1





### 802.11ax (HE40)

Type 6 Radar Statistical Performances					
Trial #	Pulses per Burst	Pulse Width(us)	PRI(us)	Hopping Frequency Sequence Name	Detection
1	9	1	333.3	HOP_FREQ_SEQ_01	Yes
2	9	1	333.3	HOP_FREQ_SEQ_02	Yes
3	9	1	333.3	HOP_FREQ_SEQ_03	Yes
4	9	1	333.3	HOP_FREQ_SEQ_04	Yes
5	9	1	333.3	HOP_FREQ_SEQ_05	Yes
6	9	1	333.3	HOP_FREQ_SEQ_06	Yes
7	9	1	333.3	HOP_FREQ_SEQ_07	No
8	9	1	333.3	HOP_FREQ_SEQ_08	Yes
9	9	1	333.3	HOP_FREQ_SEQ_09	Yes
10	9	1	333.3	HOP_FREQ_SEQ_10	Yes
11	9	1	333.3	HOP_FREQ_SEQ_11	Yes
12	9	1	333.3	HOP_FREQ_SEQ_12	Yes
13	9	1	333.3	HOP_FREQ_SEQ_13	Yes
14	9	1	333.3	HOP_FREQ_SEQ_14	Yes
15	9	1	333.3	HOP_FREQ_SEQ_15	Yes
16	9	1	333.3	HOP_FREQ_SEQ_16	No
17	9	1	333.3	HOP_FREQ_SEQ_17	Yes
18	9	1	333.3	HOP_FREQ_SEQ_18	Yes
19	9	1	333.3	HOP_FREQ_SEQ_19	Yes
20	9	1	333.3	HOP_FREQ_SEQ_20	Yes
21	9	1	333.3	HOP_FREQ_SEQ_21	Yes
22	9	1	333.3	HOP_FREQ_SEQ_22	Yes
23	9	1	333.3	HOP_FREQ_SEQ_23	Yes
24	9	1	333.3	HOP_FREQ_SEQ_24	Yes
25	9	1	333.3	HOP_FREQ_SEQ_25	Yes
26	9	1	333.3	HOP_FREQ_SEQ_26	Yes
27	9	1	333.3	HOP_FREQ_SEQ_27	Yes
28	9	1	333.3	HOP_FREQ_SEQ_28	Yes
29	9	1	333.3	HOP_FREQ_SEQ_29	Yes
30	9	1	333.3	HOP_FREQ_SEQ_30	Yes

Detection Rate : 93.3%

Note: The Frequency Hopping Radar pattern shown in Appendix A.2



## 802.11ax (HE80)

### Type 1 Radar Statistical Performances

Trial #	Test Frequency (MHz)	Pulse Repetition Frequency Number (1 to 23)	Pulse Repetition Frequency (pps)	Pulses per Burst	Pulse Repetition Interval ( $\mu$ sec)	Detection
1	5530	5	1672	89	598	Yes
2	5540	23	326.2	18	3066	Yes
3	5560	15	1253	67	798	Yes
4	5520	17	1193	63	838	Yes
5	5500	9	1475	78	678	Yes
6	5527	7	1567	83	638	Yes
7	5501	4	1730	92	578	Yes
8	5497	16	1223	65	818	Yes
9	5502	8	1520	81	658	Yes
10	5562	22	1066	57	938	Yes
11	5536	6	1618	86	618	Yes
12	5543	18	1166	62	858	Yes
13	5545	14	1285	68	778	Yes
14	5509	10	1433	76	698	Yes
15	5549	2	1859	99	538	Yes
16	5492		416.1	22	2403	Yes
17	5564		492.9	27	2029	Yes
18	5529		368.2	20	2716	No
19	5559		386.2	21	2589	Yes
20	5553		394.5	21	2535	Yes
21	5565		360.1	20	2777	Yes
22	5542		494.1	27	2024	Yes
23	5515		897.7	48	1114	Yes
24	5533		962.5	51	1039	Yes
25	5504		380.2	21	2630	Yes
26	5541		452.7	24	2209	Yes
27	5517		391.8	21	2552	Yes
28	5557		1083	58	923	Yes
29	5552		329.7	18	3033	Yes
30	5564		502	27	1992	Yes

Detection Rate : 96.7%

Note. " - " : 15 unique PRI values randomly selected within the range of 518-3066  $\mu$ sec, with a minimum increment of 1 $\mu$ sec, excluding PRI values selected in Test A



### 802.11ax (HE80)

Type 2 Radar Statistical Performances					
Trial #	Test Frequency (MHz)	Pulses per Burst	Pulse Width(us)	PRI(us)	Detection
1	5530	24	2	224	Yes
2	5540	29	4.5	219	No
3	5560	26	3.2	167	Yes
4	5520	27	3.7	216	No
5	5500	23	1.1	179	Yes
6	5493	26	3.1	181	Yes
7	5511	27	3.7	188	Yes
8	5512	26	2.9	155	Yes
9	5562	29	4.8	214	Yes
10	5510	23	1.5	195	Yes
11	5550	29	4.9	201	Yes
12	5541	24	1.8	197	Yes
13	5493	23	1.5	158	No
14	5521	29	4.9	222	No
15	5509	28	4.2	185	Yes
16	5516	23	1	173	No
17	5536	29	4.8	190	Yes
18	5548	29	4.5	200	Yes
19	5544	25	2.3	165	Yes
20	5502	27	3.4	177	Yes
21	5558	23	1	183	Yes
22	5512	28	4	156	Yes
23	5523	23	1.1	213	No
24	5544	25	2.7	229	No
25	5500	23	1.2	206	Yes
26	5531	29	4.9	203	Yes
27	5560	26	3.3	163	Yes
28	5538	26	3.2	182	Yes
29	5493	24	1.7	166	Yes
30	5510	25	2.6	210	Yes

Detection Rate : 76.7%



### 802.11ax (HE80)

#### Type 3 Radar Statistical Performances

Trial #	Test Frequency (MHz)	Pulses per Burst	Pulse Width(us)	PRI(us)	Detection
1	5530	16	7	239	No
2	5540	18	9.5	335	Yes
3	5560	17	8.2	411	Yes
4	5520	18	8.7	224	Yes
5	5500	16	6.1	428	Yes
6	5562	17	8.1	332	Yes
7	5524	17	8.7	491	No
8	5565	17	7.9	348	Yes
9	5535	18	9.8	206	Yes
10	5499	16	6.5	204	Yes
11	5527	18	9.9	438	Yes
12	5513	16	6.8	484	Yes
13	5527	16	6.5	344	No
14	5535	18	9.9	465	Yes
15	5549	18	9.2	444	Yes
16	5568	16	6	357	Yes
17	5550	18	9.8	423	Yes
18	5537	18	9.5	225	Yes
19	5505	16	7.3	217	Yes
20	5560	17	8.4	242	Yes
21	5513	16	6	483	Yes
22	5514	18	9	470	Yes
23	5500	16	6.1	308	Yes
24	5539	17	7.7	498	Yes
25	5516	16	6.2	477	No
26	5494	18	9.9	375	Yes
27	5565	17	8.3	285	Yes
28	5554	17	8.2	433	Yes
29	5520	16	6.7	490	Yes
30	5533	17	7.6	202	Yes

Detection Rate : 86.7%



## 802.11ax (HE80)

### Type 4 Radar Statistical Performances

Trial #	Test Frequency (MHz)	Pulses per Burst	Pulse Width(us)	PRI(us)	Detection
1	5530	13	13.4	239	No
2	5540	16	18.8	335	Yes
3	5560	14	15.9	411	No
4	5520	15	17.1	224	Yes
5	5500	12	11.3	428	Yes
6	5524	14	15.8	332	No
7	5538	15	17	491	No
8	5507	14	15.3	348	No
9	5563	16	19.6	206	Yes
10	5546	12	12.1	204	Yes
11	5565	16	19.8	438	Yes
12	5532	13	12.8	484	Yes
13	5536	12	12.1	344	Yes
14	5536	16	19.6	465	Yes
15	5497	15	18.1	444	Yes
16	5550	12	11.1	357	No
17	5558	16	19.6	423	No
18	5546	16	18.9	225	Yes
19	5510	13	13.9	217	Yes
20	5534	15	16.5	242	Yes
21	5503	12	11	483	Yes
22	5527	15	17.6	470	No
23	5507	12	11.4	308	Yes
24	5537	14	14.7	498	No
25	5540	12	11.4	477	Yes
26	5508	16	19.7	375	Yes
27	5516	14	16.1	285	Yes
28	5515	14	16	433	Yes
29	5555	12	12.6	490	Yes
30	5562	14	14.7	202	Yes

Detection Rate : 70%



### 802.11ax (HE80)

#### Type 5 Radar Statistical Performances

Trial #	Minimum Chirp Width(MHz)	Chirp Center Frequency(MHz)	Test Signal Name	Detection
1	7	5530	LP_Signal_01	Yes
2	10	5530	LP_Signal_02	Yes
3	14	5530	LP_Signal_03	Yes
4	7	5530	LP_Signal_04	Yes
5	12	5530	LP_Signal_05	Yes
6	14	5530	LP_Signal_06	Yes
7	19	5530	LP_Signal_07	Yes
8	6	5530	LP_Signal_08	Yes
9	16	5530	LP_Signal_09	Yes
10	10	5530	LP_Signal_10	Yes
11	11	5495	LP_Signal_11	Yes
12	11	5495	LP_Signal_12	Yes
13	12	5496	LP_Signal_13	Yes
14	16	5497	LP_Signal_14	Yes
15	19	5499	LP_Signal_15	Yes
16	10	5495	LP_Signal_16	Yes
17	11	5495	LP_Signal_17	Yes
18	19	5499	LP_Signal_18	Yes
19	5	5493	LP_Signal_19	Yes
20	5	5493	LP_Signal_20	Yes
21	11	5565	LP_Signal_21	Yes
22	8	5566	LP_Signal_22	Yes
23	16	5563	LP_Signal_23	Yes
24	11	5565	LP_Signal_24	Yes
25	8	5566	LP_Signal_25	Yes
26	12	5564	LP_Signal_26	No
27	16	5563	LP_Signal_27	Yes
28	14	5563	LP_Signal_28	Yes
29	11	5565	LP_Signal_29	No
30	7	5566	LP_Signal_30	Yes

Detection Rate : 93.3%

Note: The Long Pulse Radar pattern shown in Appendix A.1



## 802.11ax (HE80)

Type 6 Radar Statistical Performances					
Trial #	Pulses per Burst	Pulse Width(us)	PRI(us)	Hopping Frequency Sequence Name	Detection
1	9	1	333.3	HOP_FREQ_SEQ_01	Yes
2	9	1	333.3	HOP_FREQ_SEQ_02	Yes
3	9	1	333.3	HOP_FREQ_SEQ_03	Yes
4	9	1	333.3	HOP_FREQ_SEQ_04	Yes
5	9	1	333.3	HOP_FREQ_SEQ_05	Yes
6	9	1	333.3	HOP_FREQ_SEQ_06	Yes
7	9	1	333.3	HOP_FREQ_SEQ_07	Yes
8	9	1	333.3	HOP_FREQ_SEQ_08	Yes
9	9	1	333.3	HOP_FREQ_SEQ_09	Yes
10	9	1	333.3	HOP_FREQ_SEQ_10	Yes
11	9	1	333.3	HOP_FREQ_SEQ_11	Yes
12	9	1	333.3	HOP_FREQ_SEQ_12	Yes
13	9	1	333.3	HOP_FREQ_SEQ_13	No
14	9	1	333.3	HOP_FREQ_SEQ_14	Yes
15	9	1	333.3	HOP_FREQ_SEQ_15	Yes
16	9	1	333.3	HOP_FREQ_SEQ_16	Yes
17	9	1	333.3	HOP_FREQ_SEQ_17	Yes
18	9	1	333.3	HOP_FREQ_SEQ_18	Yes
19	9	1	333.3	HOP_FREQ_SEQ_19	Yes
20	9	1	333.3	HOP_FREQ_SEQ_20	Yes
21	9	1	333.3	HOP_FREQ_SEQ_21	Yes
22	9	1	333.3	HOP_FREQ_SEQ_22	Yes
23	9	1	333.3	HOP_FREQ_SEQ_23	No
24	9	1	333.3	HOP_FREQ_SEQ_24	Yes
25	9	1	333.3	HOP_FREQ_SEQ_25	Yes
26	9	1	333.3	HOP_FREQ_SEQ_26	Yes
27	9	1	333.3	HOP_FREQ_SEQ_27	Yes
28	9	1	333.3	HOP_FREQ_SEQ_28	Yes
29	9	1	333.3	HOP_FREQ_SEQ_29	Yes
30	9	1	333.3	HOP_FREQ_SEQ_30	Yes

Detection Rate : 93.3%

Note: The Frequency Hopping Radar pattern shown in Appendix A.2



### 802.11ax (HE160)

#### Type 1 Radar Statistical Performances

Trial #	Test Frequency (MHz)	Pulse Repetition Frequency Number (1 to 23)	Pulse Repetition Frequency (pps)	Pulses per Burst	Pulse Repetition Interval ( $\mu$ sec)	Detection
1	5570	5	1672	89	598	Yes
2	5580	23	326.2	18	3066	No
3	5600	15	1253	67	798	Yes
4	5560	17	1193	63	838	Yes
5	5540	9	1475	78	678	Yes
6	5573	7	1567	83	638	Yes
7	5558	4	1730	92	578	Yes
8	5533	16	1223	65	818	Yes
9	5584	8	1520	81	658	Yes
10	5500	22	1066	57	938	Yes
11	5559	6	1618	86	618	Yes
12	5499	18	1166	62	858	Yes
13	5613	14	1285	68	778	Yes
14	5522	10	1433	76	698	Yes
15	5564	2	1859	99	538	Yes
16	5494		416.1	22	2403	Yes
17	5591		492.9	27	2029	Yes
18	5501		368.2	20	2716	Yes
19	5530		386.2	21	2589	Yes
20	5572		394.5	21	2535	Yes
21	5524		360.1	20	2777	Yes
22	5588		494.1	27	2024	Yes
23	5618		897.7	48	1114	Yes
24	5641		962.5	51	1039	Yes
25	5539		380.2	21	2630	Yes
26	5589		452.7	24	2209	Yes
27	5645		391.8	21	2552	Yes
28	5519		1083	58	923	Yes
29	5609		329.7	18	3033	Yes
30	5584		502	27	1992	No

Detection Rate : 93.3%

Note. " - " : 15 unique PRI values randomly selected within the range of 518-3066  $\mu$ sec, with a minimum increment of 1 $\mu$ sec, excluding PRI values selected in Test A





### 802.11ax (HE160)

Type 2 Radar Statistical Performances					
Trial #	Test Frequency (MHz)	Pulses per Burst	Pulse Width(us)	PRI(us)	Detection
1	5570	24	2	224	Yes
2	5580	29	4.5	219	Yes
3	5600	26	3.2	167	Yes
4	5560	27	3.7	216	Yes
5	5540	23	1.1	179	Yes
6	5498	26	3.1	181	No
7	5614	27	3.7	188	Yes
8	5637	26	2.9	155	Yes
9	5585	29	4.8	214	Yes
10	5538	23	1.5	195	Yes
11	5501	29	4.9	201	No
12	5559	24	1.8	197	Yes
13	5517	23	1.5	158	No
14	5596	29	4.9	222	Yes
15	5567	28	4.2	185	No
16	5618	23	1	173	Yes
17	5537	29	4.8	190	Yes
18	5611	29	4.5	200	Yes
19	5564	25	2.3	165	Yes
20	5606	27	3.4	177	Yes
21	5550	23	1	183	Yes
22	5609	28	4	156	Yes
23	5614	23	1.1	213	Yes
24	5633	25	2.7	229	Yes
25	5638	23	1.2	206	Yes
26	5504	29	4.9	203	No
27	5614	26	3.3	163	No
28	5586	26	3.2	182	Yes
29	5565	24	1.7	166	No
30	5583	25	2.6	210	Yes

Detection Rate : 76.7%



### 802.11ax (HE160)

#### Type 3 Radar Statistical Performances

Trial #	Test Frequency (MHz)	Pulses per Burst	Pulse Width(us)	PRI(us)	Detection
1	5570	16	7	239	Yes
2	5580	18	9.5	335	Yes
3	5600	17	8.2	411	No
4	5560	18	8.7	224	Yes
5	5540	16	6.1	428	Yes
6	5527	17	8.1	332	No
7	5562	17	8.7	491	Yes
8	5521	17	7.9	348	Yes
9	5500	18	9.8	206	Yes
10	5557	16	6.5	204	No
11	5571	18	9.9	438	Yes
12	5552	16	6.8	484	No
13	5566	16	6.5	344	No
14	5580	18	9.9	465	Yes
15	5582	18	9.2	444	Yes
16	5504	16	6	357	Yes
17	5570	18	9.8	423	Yes
18	5636	18	9.5	225	Yes
19	5507	16	7.3	217	Yes
20	5494	17	8.4	242	Yes
21	5530	16	6	483	Yes
22	5640	18	9	470	Yes
23	5572	16	6.1	308	Yes
24	5502	17	7.7	498	Yes
25	5527	16	6.2	477	Yes
26	5582	18	9.9	375	Yes
27	5540	17	8.3	285	Yes
28	5559	17	8.2	433	Yes
29	5519	16	6.7	490	Yes
30	5567	17	7.6	202	No

Detection Rate : 80%



## 802.11ax (HE160)

### Type 4 Radar Statistical Performances

Trial #	Test Frequency (MHz)	Pulses per Burst	Pulse Width(us)	PRI(us)	Detection
1	5570	13	13.4	239	No
2	5580	16	18.8	335	Yes
3	5600	14	15.9	411	No
4	5560	15	17.1	224	Yes
5	5540	12	11.3	428	Yes
6	5507	14	15.8	332	Yes
7	5610	15	17	491	Yes
8	5526	14	15.3	348	Yes
9	5594	16	19.6	206	Yes
10	5558	12	12.1	204	No
11	5542	16	19.8	438	Yes
12	5646	13	12.8	484	Yes
13	5572	12	12.1	344	Yes
14	5495	16	19.6	465	Yes
15	5603	15	18.1	444	Yes
16	5612	12	11.1	357	No
17	5587	16	19.6	423	No
18	5605	16	18.9	225	No
19	5633	13	13.9	217	Yes
20	5590	15	16.5	242	Yes
21	5577	12	11	483	Yes
22	5566	15	17.6	470	No
23	5593	12	11.4	308	No
24	5547	14	14.7	498	Yes
25	5548	12	11.4	477	Yes
26	5576	16	19.7	375	Yes
27	5510	14	16.1	285	Yes
28	5617	14	16	433	Yes
29	5639	12	12.6	490	Yes
30	5506	14	14.7	202	No

Detection Rate : 70%



### 802.11ax (HE160)

#### Type 5 Radar Statistical Performances

Trial #	Minimum Chirp Width(MHz)	Chirp Center Frequency(MHz)	Test Signal Name	Detection
1	9	5570	LP_Signal_01	Yes
2	18	5570	LP_Signal_02	Yes
3	13	5570	LP_Signal_03	Yes
4	15	5570	LP_Signal_04	Yes
5	5	5570	LP_Signal_05	Yes
6	13	5570	LP_Signal_06	Yes
7	15	5570	LP_Signal_07	Yes
8	12	5570	LP_Signal_08	No
9	20	5570	LP_Signal_09	Yes
10	6	5570	LP_Signal_10	Yes
11	20	5500	LP_Signal_11	Yes
12	8	5495	LP_Signal_12	Yes
13	7	5495	LP_Signal_13	Yes
14	20	5500	LP_Signal_14	Yes
15	17	5499	LP_Signal_15	Yes
16	5	5494	LP_Signal_16	Yes
17	20	5500	LP_Signal_17	Yes
18	19	5500	LP_Signal_18	Yes
19	10	5496	LP_Signal_19	Yes
20	14	5498	LP_Signal_20	Yes
21	5	5646	LP_Signal_21	Yes
22	16	5642	LP_Signal_22	Yes
23	5	5646	LP_Signal_23	No
24	11	5644	LP_Signal_24	Yes
25	5	5646	LP_Signal_25	Yes
26	20	5640	LP_Signal_26	Yes
27	14	5642	LP_Signal_27	Yes
28	13	5643	LP_Signal_28	Yes
29	7	5645	LP_Signal_29	Yes
30	11	5644	LP_Signal_30	Yes

Detection Rate : 93.3%

Note: The Long Pulse Radar pattern shown in Appendix A.1



### 802.11ax (HE160)

Type 6 Radar Statistical Performances					
Trial #	Pulses per Burst	Pulse Width(us)	PRI(us)	Hopping Frequency Sequence Name	Detection
1	9	1	333.3	HOP_FREQ_SEQ_01	No
2	9	1	333.3	HOP_FREQ_SEQ_02	Yes
3	9	1	333.3	HOP_FREQ_SEQ_03	Yes
4	9	1	333.3	HOP_FREQ_SEQ_04	Yes
5	9	1	333.3	HOP_FREQ_SEQ_05	Yes
6	9	1	333.3	HOP_FREQ_SEQ_06	Yes
7	9	1	333.3	HOP_FREQ_SEQ_07	Yes
8	9	1	333.3	HOP_FREQ_SEQ_08	Yes
9	9	1	333.3	HOP_FREQ_SEQ_09	Yes
10	9	1	333.3	HOP_FREQ_SEQ_10	Yes
11	9	1	333.3	HOP_FREQ_SEQ_11	Yes
12	9	1	333.3	HOP_FREQ_SEQ_12	Yes
13	9	1	333.3	HOP_FREQ_SEQ_13	Yes
14	9	1	333.3	HOP_FREQ_SEQ_14	Yes
15	9	1	333.3	HOP_FREQ_SEQ_15	Yes
16	9	1	333.3	HOP_FREQ_SEQ_16	Yes
17	9	1	333.3	HOP_FREQ_SEQ_17	Yes
18	9	1	333.3	HOP_FREQ_SEQ_18	Yes
19	9	1	333.3	HOP_FREQ_SEQ_19	Yes
20	9	1	333.3	HOP_FREQ_SEQ_20	Yes
21	9	1	333.3	HOP_FREQ_SEQ_21	Yes
22	9	1	333.3	HOP_FREQ_SEQ_22	Yes
23	9	1	333.3	HOP_FREQ_SEQ_23	Yes
24	9	1	333.3	HOP_FREQ_SEQ_24	Yes
25	9	1	333.3	HOP_FREQ_SEQ_25	Yes
26	9	1	333.3	HOP_FREQ_SEQ_26	Yes
27	9	1	333.3	HOP_FREQ_SEQ_27	Yes
28	9	1	333.3	HOP_FREQ_SEQ_28	Yes
29	9	1	333.3	HOP_FREQ_SEQ_29	Yes
30	9	1	333.3	HOP_FREQ_SEQ_30	Yes

Detection Rate : 96.7%

Note: The Frequency Hopping Radar pattern shown in Appendix A.2

## 6.2.5 Non- Occupancy Period

1) Test results demonstrating an associated client link is established with the master on a test frequency.

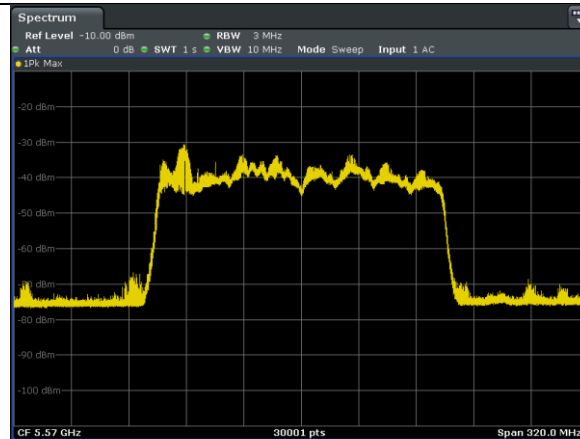

EUT (master) links with Client on 5530MHz

2) The master and DFS-certified client device are associated, and system testing will be performed with channel-loading for a non-occupancy period test.

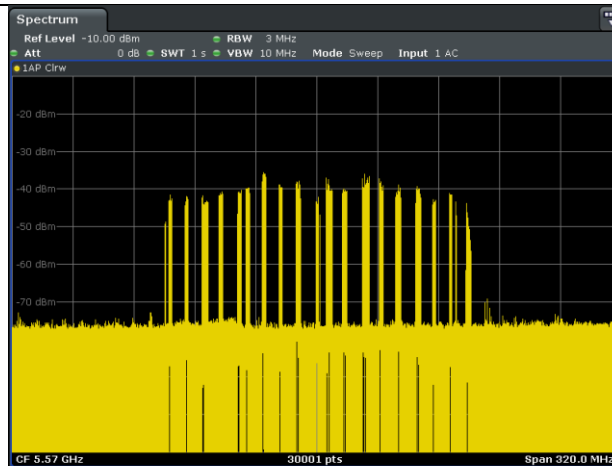

Client performed with channel-loading via master.

3). The device transmits one type of radar as specified in the DFS Order.

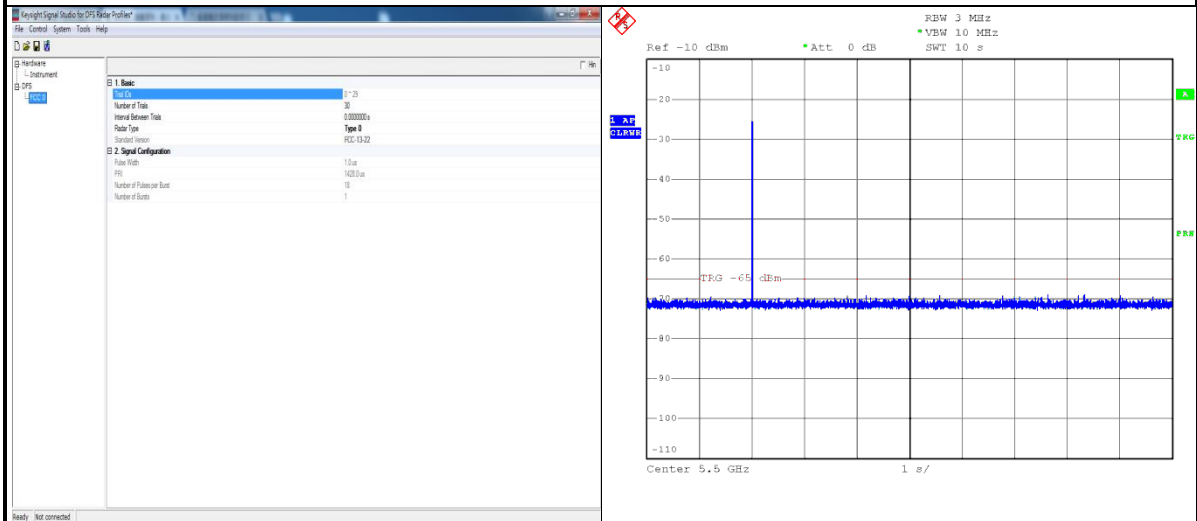

Radar 0 is used to test during DFS testing.

4) The test frequency has been monitored to ensure no transmission of any type has occurred for 30 minutes;

Note: If the client moves with the master, the device is considered compliant if nothing appears in the client non-occupancy period test. For devices that shut down (rather than moving channels), no beacons should appear;

5) An analyzer plot that contains a single 30-minute sweep on the original test frequency.

**Non - Occupancy Period**

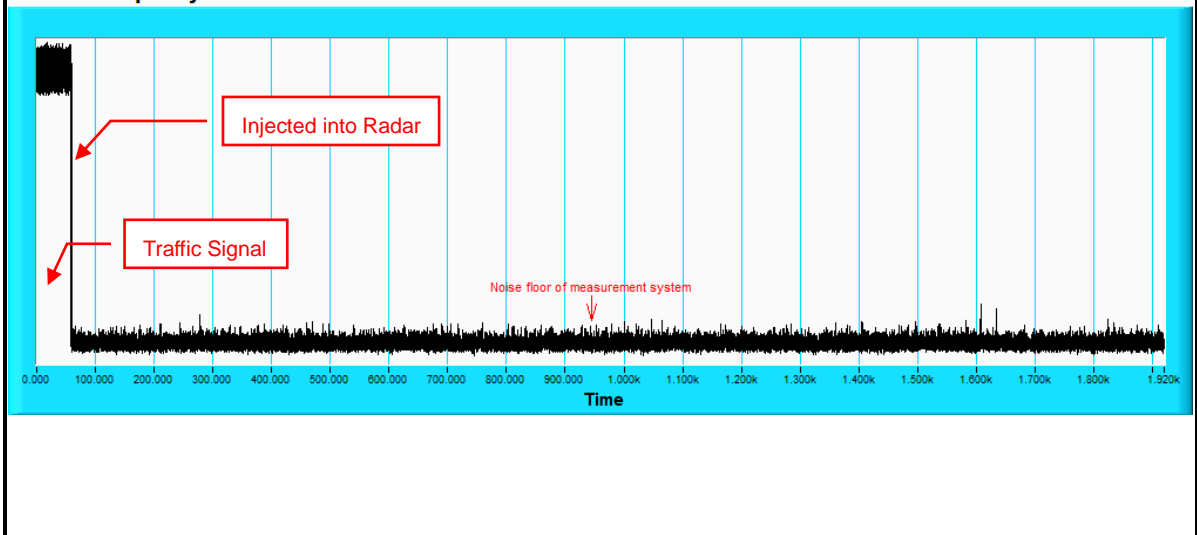

## 7. Information of the Testing Laboratories

We, Bureau Veritas Consumer Products Services (H.K.) Ltd., Taoyuan Branch, were founded in 1988 to provide our best service in EMC, Radio, Telecom and Safety consultation. Our laboratories are accredited and approved according to ISO/IEC 17025.

If you have any comments, please feel free to contact us at the following:

**Lin Kou EMC/RF Lab:**

Tel: 886-2-26052180

Fax: 886-2-26051924

**Hsin Chu EMC/RF/Telecom Lab:**

Tel: 886-3-6668565

Fax: 886-3-6668323

**Hwa Ya EMC/RF/Safety Lab:**

Tel: 886-3-3183232

Fax: 886-3-3270892

**Email:** [service.adt@tw.bureauveritas.com](mailto:service.adt@tw.bureauveritas.com)

**Web Site:** [www.bureauveritas-adt.com](http://www.bureauveritas-adt.com)

The address and road map of all our labs can be found in our web site also.



## 8. APPENDIX-A

### RADAR TEST SIGNAL

#### A.1 The Long Pulse Radar Pattern

#### BW20

Long Pulse Radar Test Signal

Test Signal Name: LP\_Signal\_01

Number of Bursts in Trial: 18

Burst	Pulses per Burst	Chrip (MHz)	Pulse Width(us)	PRI-1 (us)	PRI-2 (us)	PRI-3 (us)
1	3	17	88.7	1855	1442	1709
2	1	17	53.1	1611	-	-
3	3	17	100	1657	1306	1836
4	1	17	64.3	1294	-	-
5	2	17	67.9	1851	1744	-
6	3	17	92.9	1059	1667	1286
7	3	17	91.1	1272	1277	1961
8	1	17	52.9	1913	-	-
9	2	17	75.7	1219	1532	-
10	3	17	85.9	1819	1814	1553
11	1	17	56.3	1083	-	-
12	2	17	66.8	1704	1821	-
13	1	17	53.3	1740	-	-
14	2	17	68.3	1346	1996	-
15	1	17	64	1619	-	-
16	1	17	56.1	1349	-	-
17	3	17	93.4	1678	1480	1916
18	3	17	88.8	1399	1062	1613
19	-	-	-	-	-	-
20	-	-	-	-	-	-

Long Pulse Radar Test Signal

Test Signal Name: LP\_Signal\_02

Number of Bursts in Trial: 8

Burst	Pulses per Burst	Chrip (MHz)	Pulse Width(us)	PRI-1 (us)	PRI-2 (us)	PRI-3 (us)
1	2	6	77.3	1146	1462	-
2	1	6	51.5	1043	-	-
3	3	6	99.3	1210	1076	1956
4	3	6	88.8	1697	1371	1918
5	2	6	82.7	1459	1866	-
6	1	6	56.8	1142	-	-
7	2	6	73.1	1566	1826	-
8	3	6	95.3	1896	1363	1201
9	-	-	-	-	-	-
10	-	-	-	-	-	-
11	-	-	-	-	-	-
12	-	-	-	-	-	-
13	-	-	-	-	-	-
14	-	-	-	-	-	-
15	-	-	-	-	-	-
16	-	-	-	-	-	-
17	-	-	-	-	-	-
18	-	-	-	-	-	-
19	-	-	-	-	-	-
20	-	-	-	-	-	-

Long Pulse Radar Test Signal

Test Signal Name: LP\_Signal\_03

Number of Bursts in Trial: 20

Burst	Pulses per Burst	Chrip (MHz)	Pulse Width(us)	PRI-1 (us)	PRI-2 (us)	PRI-3 (us)
1	1	20	62.9	1555	-	-
2	2	20	72	1612	1650	-
3	2	20	80.3	1160	1089	-
4	2	20	82.6	1568	1490	-
5	2	20	83	1485	1395	-
6	2	20	81.4	1636	1187	-
7	1	20	52.1	1625	-	-
8	3	20	85.9	1126	1468	1601
9	3	20	86.8	1767	1759	1489
10	3	20	87.7	1862	1595	1477
11	1	20	59.3	1129	-	-
12	2	20	70.2	1617	1586	-
13	1	20	57.9	1905	-	-
14	1	20	56.8	1534	-	-
15	2	20	73.8	1735	1854	-
16	3	20	94.3	1053	1778	1035
17	2	20	79.9	1370	1715	-
18	1	20	54	1097	-	-
19	1	20	64.3	1452	-	-
20	2	20	78	1216	1239	-

Long Pulse Radar Test Signal

Test Signal Name: LP\_Signal\_04

Number of Bursts in Trial: 11

Burst	Pulses per Burst	Chrip (MHz)	Pulse Width(us)	PRI-1 (us)	PRI-2 (us)	PRI-3 (us)
1	3	9	90.7	1626	1730	1722
2	2	9	76.9	1668	1846	-
3	3	9	94.4	1561	1314	1184
4	2	9	67	1293	1398	-
5	2	9	71.3	1796	1052	-
6	3	9	90.9	1067	1407	1756
7	3	9	88.3	1861	1078	1736
8	2	9	77.3	1033	1829	-
9	1	9	50.5	1186	-	-
10	3	9	99.9	1287	1008	1701
11	2	9	70.5	1432	1872	-
12	-	-	-	-	-	-
13	-	-	-	-	-	-
14	-	-	-	-	-	-
15	-	-	-	-	-	-
16	-	-	-	-	-	-
17	-	-	-	-	-	-
18	-	-	-	-	-	-
19	-	-	-	-	-	-
20	-	-	-	-	-	-

Long Pulse Radar Test Signal

Test Signal Name: LP\_Signal\_05

Number of Bursts in Trial: 12

Burst	Pulses per Burst	Chrip (MHz)	Pulse Width(us)	PRI-1 (us)	PRI-2 (us)	PRI-3 (us)
1	3	10	93.1	1070	1163	1282
2	3	10	91.2	1016	1385	1781
3	2	10	72.6	1386	1012	-
4	2	10	80	1140	1180	-
5	2	10	69.1	1886	1570	-
6	2	10	72.6	1303	1402	-
7	3	10	93.2	1865	1337	1311
8	1	10	52.8	1254	-	-
9	2	10	74.9	1711	1630	-
10	1	10	64.6	1869	-	-
11	2	10	67.4	1107	1971	-
12	2	10	81.6	1183	1665	-
13	-	-	-	-	-	-
14	-	-	-	-	-	-
15	-	-	-	-	-	-
16	-	-	-	-	-	-
17	-	-	-	-	-	-
18	-	-	-	-	-	-
19	-	-	-	-	-	-
20	-	-	-	-	-	-

Long Pulse Radar Test Signal

Test Signal Name: LP\_Signal\_06

Number of Bursts in Trial: 19

Burst	Pulses per Burst	Chrip (MHz)	Pulse Width(us)	PRI-1 (us)	PRI-2 (us)	PRI-3 (us)
1	2	18	76.3	1440	1696	-
2	3	18	96.8	1967	1969	1414
3	2	18	73.1	1944	1367	-
4	2	18	80.8	1383	1304	-
5	2	18	70.4	1382	1664	-
6	2	18	77.8	1273	1936	-
7	1	18	54.9	1648	-	-
8	1	18	58.9	1616	-	-
9	2	18	78.6	1681	1194	-
10	3	18	92.6	1166	1985	1427
11	3	18	95.2	1576	1086	1673
12	1	18	54.6	1643	-	-
13	3	18	86	1178	1224	1203
14	2	18	77.6	1309	1263	-
15	1	18	63.2	1300	-	-
16	1	18	61.2	1202	-	-
17	3	18	92.2	1116	1948	1318
18	3	18	93.2	1175	1213	1472
19	2	18	74.9	1881	1094	-
20	-	-	-	-	-	-

Long Pulse Radar Test Signal

Test Signal Name: LP\_Signal\_07

Number of Bursts in Trial: 18

Burst	Pulses per Burst	Chrip (MHz)	Pulse Width(us)	PRI-1 (us)	PRI-2 (us)	PRI-3 (us)
1	3	18	85.4	1899	1957	1649
2	3	18	87	1983	1777	1984
3	2	18	67.2	1506	1428	-
4	1	18	66.3	1805	-	-
5	2	18	79.1	1453	1238	-
6	3	18	85.4	1117	1610	1547
7	2	18	76.8	1579	1530	-
8	1	18	54.7	1164	-	-
9	2	18	71.6	1327	1335	-
10	3	18	86.7	1410	1241	1330
11	1	18	51.2	1441	-	-
12	3	18	89.5	1721	1724	1540
13	1	18	63.3	1891	-	-
14	2	18	73.2	1392	1718	-
15	3	18	95.4	1197	1639	1242
16	2	18	68	1952	1883	-
17	2	18	70.2	1185	1497	-
18	3	18	98.2	1002	1131	1082
19	-	-	-	-	-	-
20	-	-	-	-	-	-

Long Pulse Radar Test Signal

Test Signal Name: LP\_Signal\_08

Number of Bursts in Trial: 8

Burst	Pulses per Burst	Chrip (MHz)	Pulse Width(us)	PRI-1 (us)	PRI-2 (us)	PRI-3 (us)
1	1	5	60	1963	-	-
2	2	5	67.8	1889	1236	-
3	3	5	99.5	1351	1858	1124
4	3	5	95.6	1661	1605	1875
5	3	5	90.9	1789	1907	1065
6	3	5	92	1962	1356	1518
7	1	5	50.4	1564	-	-
8	3	5	96	1848	1276	1168
9	-	-	-	-	-	-
10	-	-	-	-	-	-
11	-	-	-	-	-	-
12	-	-	-	-	-	-
13	-	-	-	-	-	-
14	-	-	-	-	-	-
15	-	-	-	-	-	-
16	-	-	-	-	-	-
17	-	-	-	-	-	-
18	-	-	-	-	-	-
19	-	-	-	-	-	-
20	-	-	-	-	-	-



Long Pulse Radar Test Signal

Test Signal Name: LP\_Signal\_09

Number of Bursts in Trial: 14

Burst	Pulses per Burst	Chrip (MHz)	Pulse Width(us)	PRI-1 (us)	PRI-2 (us)	PRI-3 (us)
1	2	13	67.9	1831	1585	-
2	3	13	94.1	1292	1893	1249
3	3	13	91.5	1467	1446	1362
4	1	13	59.4	1840	-	-
5	2	13	81.9	1713	1279	-
6	1	13	60.7	1412	-	-
7	2	13	81.8	1622	1813	-
8	3	13	89.7	1834	1741	1189
9	2	13	82	1521	1435	-
10	3	13	94.7	1090	1845	1809
11	1	13	59.1	1103	-	-
12	2	13	80.5	1590	1138	-
13	3	13	94.1	1174	1232	1285
14	3	13	95.5	1808	1795	1557
15	-	-	-	-	-	-
16	-	-	-	-	-	-
17	-	-	-	-	-	-
18	-	-	-	-	-	-
19	-	-	-	-	-	-
20	-	-	-	-	-	-

Long Pulse Radar Test Signal

Test Signal Name: LP\_Signal\_10

Number of Bursts in Trial: 17

Burst	Pulses per Burst	Chrip (MHz)	Pulse Width(us)	PRI-1 (us)	PRI-2 (us)	PRI-3 (us)
1	3	16	93.7	1946	1460	1659
2	2	16	73	1215	1243	-
3	2	16	83.3	1982	1507	-
4	2	16	72.3	1128	1329	-
5	2	16	77.3	1278	1843	-
6	1	16	53.1	1331	-	-
7	2	16	81.9	1029	1921	-
8	2	16	81.5	1041	1533	-
9	3	16	90.7	1526	1247	1606
10	1	16	59.6	1761	-	-
11	3	16	93	1797	1679	1864
12	1	16	63	1473	-	-
13	2	16	82.1	1849	1061	-
14	2	16	75.3	1080	1079	-
15	2	16	75.5	1728	1305	-
16	3	16	89.8	1046	1162	1960
17	3	16	96.1	1218	1717	1066
18	-	-	-	-	-	-
19	-	-	-	-	-	-
20	-	-	-	-	-	-

Long Pulse Radar Test Signal

Test Signal Name: LP\_Signal\_11

Number of Bursts in Trial: 9

Burst	Pulses per Burst	Chrip (MHz)	Pulse Width(us)	PRI-1 (us)	PRI-2 (us)	PRI-3 (us)
1	2	7	75.2	1419	1583	-
2	1	7	65.8	1945	-	-
3	2	7	83.1	1965	1176	-
4	2	7	67.4	1456	1024	-
5	2	7	82.8	1748	1853	-
6	1	7	63.3	1073	-	-
7	1	7	62.2	1347	-	-
8	1	7	54.7	1465	-	-
9	3	7	90.6	1623	1484	1951
10	-	-	-	-	-	-
11	-	-	-	-	-	-
12	-	-	-	-	-	-
13	-	-	-	-	-	-
14	-	-	-	-	-	-
15	-	-	-	-	-	-
16	-	-	-	-	-	-
17	-	-	-	-	-	-
18	-	-	-	-	-	-
19	-	-	-	-	-	-
20	-	-	-	-	-	-

Long Pulse Radar Test Signal

Test Signal Name: LP\_Signal\_12

Number of Bursts in Trial: 12

Burst	Pulses per Burst	Chrip (MHz)	Pulse Width(us)	PRI-1 (us)	PRI-2 (us)	PRI-3 (us)
1	1	10	57.6	1842	-	-
2	2	10	73.6	1698	1479	-
3	3	10	91.2	1319	1958	1364
4	1	10	50.7	1542	-	-
5	1	10	58.8	1641	-	-
6	3	10	89.8	1365	1772	1565
7	1	10	54.1	1731	-	-
8	1	10	64.6	1137	-	-
9	2	10	74.2	1887	1448	-
10	2	10	76.4	1647	1558	-
11	1	10	62.2	1563	-	-
12	2	10	68.6	1495	1597	-
13	-	-	-	-	-	-
14	-	-	-	-	-	-
15	-	-	-	-	-	-
16	-	-	-	-	-	-
17	-	-	-	-	-	-
18	-	-	-	-	-	-
19	-	-	-	-	-	-
20	-	-	-	-	-	-

Long Pulse Radar Test Signal

Test Signal Name: LP\_Signal\_13

Number of Bursts in Trial: 8

Burst	Pulses per Burst	Chrip (MHz)	Pulse Width(us)	PRI-1 (us)	PRI-2 (us)	PRI-3 (us)
1	1	6	64.6	1233	-	-
2	3	6	97.4	1890	1832	1438
3	1	6	64.1	1104	-	-
4	3	6	86.5	1847	1719	1220
5	1	6	53.3	1345	-	-
6	2	6	81.8	1264	1638	-
7	1	6	66.4	1599	-	-
8	2	6	68.9	1802	1123	-
9	-	-	-	-	-	-
10	-	-	-	-	-	-
11	-	-	-	-	-	-
12	-	-	-	-	-	-
13	-	-	-	-	-	-
14	-	-	-	-	-	-
15	-	-	-	-	-	-
16	-	-	-	-	-	-
17	-	-	-	-	-	-
18	-	-	-	-	-	-
19	-	-	-	-	-	-
20	-	-	-	-	-	-

Long Pulse Radar Test Signal

Test Signal Name: LP\_Signal\_14

Number of Bursts in Trial: 12

Burst	Pulses per Burst	Chrip (MHz)	Pulse Width(us)	PRI-1 (us)	PRI-2 (us)	PRI-3 (us)
1	2	10	78.6	1600	1546	-
2	1	10	56.5	1578	-	-
3	1	10	64.2	1762	-	-
4	3	10	92.3	1560	1031	1674
5	3	10	98.6	1653	1803	1047
6	3	10	84	1044	1132	1058
7	1	10	64.7	1425	-	-
8	1	10	61	1334	-	-
9	2	10	78.1	1461	1902	-
10	1	10	60.9	1240	-	-
11	1	10	59.7	1281	-	-
12	2	10	71.1	1770	1503	-
13	-	-	-	-	-	-
14	-	-	-	-	-	-
15	-	-	-	-	-	-
16	-	-	-	-	-	-
17	-	-	-	-	-	-
18	-	-	-	-	-	-
19	-	-	-	-	-	-
20	-	-	-	-	-	-

Long Pulse Radar Test Signal

Test Signal Name: LP\_Signal\_15

Number of Bursts in Trial: 11

Burst	Pulses per Burst	Chrip (MHz)	Pulse Width(us)	PRI-1 (us)	PRI-2 (us)	PRI-3 (us)
1	2	9	67.5	1338	1852	-
2	3	9	86.8	1344	1776	1504
3	3	9	95.5	1888	1941	1225
4	1	9	58.2	1822	-	-
5	3	9	90.3	1544	1217	1997
6	3	9	89.9	1222	1492	1284
7	1	9	50.7	1788	-	-
8	1	9	53.2	1297	-	-
9	1	9	58.9	1799	-	-
10	2	9	67.5	1800	1259	-
11	1	9	51	1434	-	-
12	-	-	-	-	-	-
13	-	-	-	-	-	-
14	-	-	-	-	-	-
15	-	-	-	-	-	-
16	-	-	-	-	-	-
17	-	-	-	-	-	-
18	-	-	-	-	-	-
19	-	-	-	-	-	-
20	-	-	-	-	-	-

Long Pulse Radar Test Signal

Test Signal Name: LP\_Signal\_16

Number of Bursts in Trial: 9

Burst	Pulses per Burst	Chrip (MHz)	Pulse Width(us)	PRI-1 (us)	PRI-2 (us)	PRI-3 (us)
1	3	6	99.1	1879	1246	1716
2	2	6	77.5	1171	1474	-
3	2	6	77.4	1548	1575	-
4	1	6	60.6	1874	-	-
5	2	6	68.4	1015	1098	-
6	2	6	68.9	1739	1036	-
7	2	6	80.9	1596	1173	-
8	2	6	79.4	1122	1200	-
9	2	6	81.5	1280	1528	-
10	-	-	-	-	-	-
11	-	-	-	-	-	-
12	-	-	-	-	-	-
13	-	-	-	-	-	-
14	-	-	-	-	-	-
15	-	-	-	-	-	-
16	-	-	-	-	-	-
17	-	-	-	-	-	-
18	-	-	-	-	-	-
19	-	-	-	-	-	-
20	-	-	-	-	-	-



Long Pulse Radar Test Signal

Test Signal Name: LP\_Signal\_17

Number of Bursts in Trial: 19

Burst	Pulses per Burst	Chrip (MHz)	Pulse Width(us)	PRI-1 (us)	PRI-2 (us)	PRI-3 (us)
1	3	18	95.8	1580	1332	1358
2	3	18	85.9	1760	1644	1181
3	1	18	61.9	1734	-	-
4	1	18	51.1	1221	-	-
5	1	18	59.3	1355	-	-
6	3	18	99	1964	1598	1783
7	1	18	52.1	1499	-	-
8	2	18	74.9	1223	1628	-
9	2	18	75.1	1261	1932	-
10	3	18	93.1	1415	1458	1573
11	3	18	86.6	1973	1747	1214
12	1	18	63.3	1885	-	-
13	2	18	66.7	1032	1469	-
14	3	18	91.2	1470	1114	1155
15	1	18	51.1	1811	-	-
16	2	18	77.8	1169	1817	-
17	1	18	51.8	1257	-	-
18	1	18	55.8	1571	-	-
19	3	18	96.2	1055	1188	1652
20	-	-	-	-	-	-

Long Pulse Radar Test Signal

Test Signal Name: LP\_Signal\_18

Number of Bursts in Trial: 18

Burst	Pulses per Burst	Chrip (MHz)	Pulse Width(us)	PRI-1 (us)	PRI-2 (us)	PRI-3 (us)
1	1	17	63.5	1109	-	-
2	2	17	81.1	1732	1752	-
3	1	17	63.2	1266	-	-
4	1	17	59.9	1019	-	-
5	1	17	61.1	1529	-	-
6	1	17	55.4	1987	-	-
7	1	17	65.2	1536	-	-
8	1	17	64.7	1974	-	-
9	2	17	71.2	1680	1663	-
10	2	17	73.3	1408	1313	-
11	3	17	96.3	1411	1812	1804
12	3	17	92.1	1360	1443	1437
13	3	17	97.2	1567	1120	1077
14	2	17	81.5	1255	1211	-
15	2	17	78.2	1562	1656	-
16	2	17	75.3	1708	1703	-
17	2	17	81.6	1156	1085	-
18	2	17	74.8	1642	1979	-
19	-	-	-	-	-	-
20	-	-	-	-	-	-

Long Pulse Radar Test Signal

Test Signal Name: LP\_Signal\_19

Number of Bursts in Trial: 15

Burst	Pulses per Burst	Chrip (MHz)	Pulse Width(us)	PRI-1 (us)	PRI-2 (us)	PRI-3 (us)
1	3	13	94.4	1833	1007	1784
2	3	13	99	1992	1212	1388
3	3	13	91.4	1226	1729	1310
4	3	13	87.8	1884	1063	1167
5	2	13	75.8	1148	1463	-
6	2	13	78.1	1912	1574	-
7	1	13	65.8	1714	-	-
8	2	13	80.9	1710	1970	-
9	3	13	87.8	1105	1403	1159
10	2	13	82.3	1429	1572	-
11	3	13	86.4	1691	1268	1482
12	2	13	76.2	1377	1981	-
13	2	13	82.9	1206	1632	-
14	1	13	66.6	1069	-	-
15	1	13	63.1	1685	-	-
16	-	-	-	-	-	-
17	-	-	-	-	-	-
18	-	-	-	-	-	-
19	-	-	-	-	-	-
20	-	-	-	-	-	-

Long Pulse Radar Test Signal

Test Signal Name: LP\_Signal\_20

Number of Bursts in Trial: 8

Burst	Pulses per Burst	Chrip (MHz)	Pulse Width(us)	PRI-1 (us)	PRI-2 (us)	PRI-3 (us)
1	3	5	84.7	1688	1426	1535
2	1	5	65.9	1030	-	-
3	1	5	50.4	1738	-	-
4	2	5	82.5	1511	1991	-
5	2	5	75.9	1193	1725	-
6	1	5	50.8	1933	-	-
7	3	5	95.7	1478	1882	1234
8	3	5	94.1	1050	1689	1333
9	-	-	-	-	-	-
10	-	-	-	-	-	-
11	-	-	-	-	-	-
12	-	-	-	-	-	-
13	-	-	-	-	-	-
14	-	-	-	-	-	-
15	-	-	-	-	-	-
16	-	-	-	-	-	-
17	-	-	-	-	-	-
18	-	-	-	-	-	-
19	-	-	-	-	-	-
20	-	-	-	-	-	-

Long Pulse Radar Test Signal

Test Signal Name: LP\_Signal\_21

Number of Bursts in Trial: 20

Burst	Pulses per Burst	Chrip (MHz)	Pulse Width(us)	PRI-1 (us)	PRI-2 (us)	PRI-3 (us)
1	3	20	84.3	1475	1581	1068
2	2	20	81	1720	1637	-
3	1	20	51.6	1256	-	-
4	2	20	78.8	1290	1785	-
5	1	20	50.9	1839	-	-
6	3	20	89.4	1750	1229	1798
7	2	20	81.8	1593	1056	-
8	3	20	88.5	1252	1694	1496
9	1	20	65.9	1516	-	-
10	2	20	69.5	1151	1502	-
11	1	20	52.9	1769	-	-
12	1	20	57.5	1100	-	-
13	1	20	56.9	1350	-	-
14	1	20	54.8	1179	-	-
15	2	20	75.7	1028	1149	-
16	1	20	55.2	1917	-	-
17	3	20	85.1	1787	1654	1726
18	3	20	94.1	1088	1510	1315
19	2	20	80.2	1501	1670	-
20	2	20	67.6	1228	1915	-

Long Pulse Radar Test Signal

Test Signal Name: LP\_Signal\_22

Number of Bursts in Trial: 18

Burst	Pulses per Burst	Chrip (MHz)	Pulse Width(us)	PRI-1 (us)	PRI-2 (us)	PRI-3 (us)
1	2	17	83	1955	1990	-
2	2	17	78.4	1133	1629	-
3	3	17	95	1270	1368	1587
4	3	17	90.4	1559	1745	1929
5	2	17	79.6	1483	1773	-
6	2	17	79	1481	1514	-
7	1	17	62.4	1923	-	-
8	1	17	65.6	1134	-	-
9	2	17	77.8	1209	1763	-
10	3	17	92.8	1742	1904	1042
11	1	17	55.7	1420	-	-
12	2	17	74	1706	1366	-
13	3	17	98.7	1235	1827	1901
14	1	17	54.8	1602	-	-
15	1	17	57.1	1487	-	-
16	1	17	56.8	1631	-	-
17	2	17	74.2	1049	1336	-
18	3	17	99.3	1231	1378	1512
19	-	-	-	-	-	-
20	-	-	-	-	-	-

Long Pulse Radar Test Signal

Test Signal Name: LP\_Signal\_23

Number of Bursts in Trial: 16

Burst	Pulses per Burst	Chrip (MHz)	Pulse Width(us)	PRI-1 (us)	PRI-2 (us)	PRI-3 (us)
1	1	15	64.9	1914	-	-
2	3	15	91.6	1733	1343	1633
3	1	15	56	1556	-	-
4	3	15	93.9	1525	1244	1161
5	2	15	70.5	1418	1190	-
6	1	15	56.7	1627	-	-
7	2	15	80	1328	1248	-
8	1	15	59.1	2000	-	-
9	1	15	56.1	1676	-	-
10	2	15	79.9	1658	1702	-
11	3	15	90.2	1940	1251	1727
12	3	15	95.2	1816	1975	1954
13	3	15	97.5	1205	1191	1322
14	2	15	81.8	1895	1298	-
15	2	15	70.7	1445	1635	-
16	2	15	78.1	1755	1323	-
17	-	-	-	-	-	-
18	-	-	-	-	-	-
19	-	-	-	-	-	-
20	-	-	-	-	-	-

Long Pulse Radar Test Signal

Test Signal Name: LP\_Signal\_24

Number of Bursts in Trial: 9

Burst	Pulses per Burst	Chrip (MHz)	Pulse Width(us)	PRI-1 (us)	PRI-2 (us)	PRI-3 (us)
1	1	7	61.1	1387	-	-
2	1	7	55.8	1592	-	-
3	3	7	86	1764	1299	1928
4	1	7	61.2	1295	-	-
5	3	7	99.3	1655	1589	1045
6	2	7	71.9	1471	1204	-
7	2	7	77	1863	1906	-
8	1	7	66.1	1758	-	-
9	1	7	60.6	1820	-	-
10	-	-	-	-	-	-
11	-	-	-	-	-	-
12	-	-	-	-	-	-
13	-	-	-	-	-	-
14	-	-	-	-	-	-
15	-	-	-	-	-	-
16	-	-	-	-	-	-
17	-	-	-	-	-	-
18	-	-	-	-	-	-
19	-	-	-	-	-	-
20	-	-	-	-	-	-



Long Pulse Radar Test Signal

Test Signal Name: LP\_Signal\_25

Number of Bursts in Trial: 14

Burst	Pulses per Burst	Chrip (MHz)	Pulse Width(us)	PRI-1 (us)	PRI-2 (us)	PRI-3 (us)
1	2	12	73.1	1106	1953	-
2	1	12	63.8	1524	-	-
3	2	12	78.9	1005	1324	-
4	1	12	58.8	1144	-	-
5	1	12	52	1121	-	-
6	3	12	97.7	1450	1624	1977
7	2	12	68.9	1026	1039	-
8	2	12	81.1	1198	1949	-
9	3	12	85.8	1792	1373	1125
10	2	12	79.2	1552	1040	-
11	3	12	88.7	1354	1369	1372
12	1	12	61.6	2000	-	-
13	3	12	89.1	1522	1004	1172
14	1	12	57.8	1325	-	-
15	-	-	-	-	-	-
16	-	-	-	-	-	-
17	-	-	-	-	-	-
18	-	-	-	-	-	-
19	-	-	-	-	-	-
20	-	-	-	-	-	-

Long Pulse Radar Test Signal

Test Signal Name: LP\_Signal\_26

Number of Bursts in Trial: 19

Burst	Pulses per Burst	Chrip (MHz)	Pulse Width(us)	PRI-1 (us)	PRI-2 (us)	PRI-3 (us)
1	3	19	88.3	1577	1707	1006
2	1	19	60.4	1520	-	-
3	2	19	70.5	1699	1352	-
4	2	19	72.8	1690	1422	-
5	2	19	82.6	1143	1341	-
6	2	19	75.5	1152	1660	-
7	2	19	82.6	1011	1993	-
8	3	19	95.4	1591	1230	1447
9	2	19	73.9	1018	1307	-
10	1	19	53.3	1994	-	-
11	2	19	70.6	1621	1880	-
12	3	19	93.8	1196	1416	1009
13	1	19	51.2	1790	-	-
14	2	19	70.8	1972	1531	-
15	1	19	62.9	1541	-	-
16	1	19	50	1774	-	-
17	3	19	93	1340	1227	1101
18	1	19	64.5	1545	-	-
19	3	19	89.9	1857	1810	1908
20	-	-	-	-	-	-

Long Pulse Radar Test Signal

Test Signal Name: LP\_Signal\_27

Number of Bursts in Trial: 11

Burst	Pulses per Burst	Chrip (MHz)	Pulse Width(us)	PRI-1 (us)	PRI-2 (us)	PRI-3 (us)
1	2	9	83.2	1081	1275	-
2	3	9	97.4	1868	1118	1154
3	3	9	92.9	1607	1207	1723
4	1	9	51	1897	-	-
5	1	9	50.2	1523	-	-
6	1	9	54.1	1768	-	-
7	2	9	82.2	1271	1828	-
8	2	9	71.2	1920	1640	-
9	1	9	64.1	1910	-	-
10	1	9	61.6	1115	-	-
11	1	9	52.6	1995	-	-
12	-	-	-	-	-	-
13	-	-	-	-	-	-
14	-	-	-	-	-	-
15	-	-	-	-	-	-
16	-	-	-	-	-	-
17	-	-	-	-	-	-
18	-	-	-	-	-	-
19	-	-	-	-	-	-
20	-	-	-	-	-	-

Long Pulse Radar Test Signal

Test Signal Name: LP\_Signal\_28

Number of Bursts in Trial: 13

Burst	Pulses per Burst	Chrip (MHz)	Pulse Width(us)	PRI-1 (us)	PRI-2 (us)	PRI-3 (us)
1	2	12	82	1135	1361	-
2	1	12	66.5	1265	-	-
3	2	12	72	1396	1342	-
4	3	12	98.1	1986	1182	1684
5	3	12	97.7	1136	1894	1876
6	1	12	50.8	1308	-	-
7	2	12	78.7	1348	1927	-
8	3	12	99.1	1150	1669	1830
9	3	12	94.4	1357	1048	1537
10	3	12	90.7	1102	1466	1147
11	2	12	78.1	1543	1645	-
12	2	12	77.7	1302	1359	-
13	3	12	90	1998	1794	1153
14	-	-	-	-	-	-
15	-	-	-	-	-	-
16	-	-	-	-	-	-
17	-	-	-	-	-	-
18	-	-	-	-	-	-
19	-	-	-	-	-	-
20	-	-	-	-	-	-

Long Pulse Radar Test Signal

Test Signal Name: LP\_Signal\_29

Number of Bursts in Trial: 15

Burst	Pulses per Burst	Chrip (MHz)	Pulse Width(us)	PRI-1 (us)	PRI-2 (us)	PRI-3 (us)
1	2	14	75.6	1837	1551	-
2	3	14	88.3	1925	1339	1687
3	1	14	58.2	1258	-	-
4	3	14	96.5	1013	1253	1978
5	3	14	98.1	1075	1430	1947
6	2	14	68.1	1208	1051	-
7	3	14	85.7	1245	1455	1870
8	3	14	86.2	1931	1262	1498
9	2	14	74.1	1413	1517	-
10	2	14	71.7	1841	1027	-
11	1	14	55.9	1269	-	-
12	1	14	60.5	1943	-	-
13	3	14	95.5	1815	1749	1775
14	1	14	59.4	1119	-	-
15	2	14	70.2	1037	1999	-
16	-	-	-	-	-	-
17	-	-	-	-	-	-
18	-	-	-	-	-	-
19	-	-	-	-	-	-
20	-	-	-	-	-	-

Long Pulse Radar Test Signal

Test Signal Name: LP\_Signal\_30

Number of Bursts in Trial: 16

Burst	Pulses per Burst	Chrip (MHz)	Pulse Width(us)	PRI-1 (us)	PRI-2 (us)	PRI-3 (us)
1	2	15	68.7	1515	1939	-
2	1	15	50.3	1753	-	-
3	1	15	54.2	1892	-	-
4	2	15	68.5	1326	1404	-
5	3	15	83.8	1449	1296	1871
6	2	15	71.2	1609	1064	-
7	2	15	71.3	1431	1406	-
8	1	15	54	1165	-	-
9	2	15	71.7	1439	1353	-
10	1	15	53.2	1424	-	-
11	2	15	73.1	1818	1807	-
12	1	15	62.1	1671	-	-
13	2	15	71.4	1824	1686	-
14	3	15	93.9	1867	1603	1108
15	2	15	70.1	1539	1112	-
16	3	15	99.2	1423	1988	1751
17	-	-	-	-	-	-
18	-	-	-	-	-	-
19	-	-	-	-	-	-
20	-	-	-	-	-	-



**BW40**

Long Pulse Radar Test Signal

Test Signal Name: LP\_Signal\_01

Number of Bursts in Trial: 14

Burst	Pulses per Burst	Chrip (MHz)	Pulse Width(us)	PRI-1 (us)	PRI-2 (us)	PRI-3 (us)
1	2	12	73.8	1073	1713	-
2	3	12	85.2	1207	1828	1620
3	1	12	64.4	1691	-	-
4	1	12	60.3	1775	-	-
5	2	12	71.1	1989	1229	-
6	3	12	86.2	1788	1134	1384
7	3	12	92.8	1757	1984	1778
8	2	12	78.7	1920	1540	-
9	2	12	81.4	1393	1130	-
10	1	12	51.8	1021	-	-
11	3	12	87.9	1260	1473	1243
12	2	12	68.1	1461	1634	-
13	1	12	62.7	1854	-	-
14	1	12	52.4	1145	-	-
15	-	-	-	-	-	-
16	-	-	-	-	-	-
17	-	-	-	-	-	-
18	-	-	-	-	-	-
19	-	-	-	-	-	-
20	-	-	-	-	-	-

Long Pulse Radar Test Signal

Test Signal Name: LP\_Signal\_02

Number of Bursts in Trial: 17

Burst	Pulses per Burst	Chrip (MHz)	Pulse Width(us)	PRI-1 (us)	PRI-2 (us)	PRI-3 (us)
1	2	16	79	1523	1645	-
2	3	16	87.2	1009	1085	1169
3	2	16	82.5	1543	1538	-
4	2	16	67.8	1642	1459	-
5	3	16	89.5	1179	1797	1764
6	2	16	75.8	1014	1030	-
7	1	16	59	1908	-	-
8	3	16	99.3	1682	1722	1177
9	1	16	58.7	1616	-	-
10	1	16	64.1	1186	-	-
11	2	16	67.2	1007	1591	-
12	3	16	84.7	1481	1923	1855
13	3	16	99.8	1470	1748	1447
14	1	16	50.8	1019	-	-
15	1	16	54.5	1799	-	-
16	3	16	95	1252	1344	1956
17	3	16	99.2	1218	1094	1472
18	-	-	-	-	-	-
19	-	-	-	-	-	-
20	-	-	-	-	-	-



Long Pulse Radar Test Signal

Test Signal Name: LP\_Signal\_03

Number of Bursts in Trial: 11

Burst	Pulses per Burst	Chrip (MHz)	Pulse Width(us)	PRI-1 (us)	PRI-2 (us)	PRI-3 (us)
1	3	9	100	1595	1705	1361
2	2	9	83.2	1851	1368	-
3	3	9	97.2	1483	1567	1563
4	3	9	94	1741	1710	1084
5	1	9	57.1	1763	-	-
6	2	9	82.1	1160	1712	-
7	2	9	76.9	1002	1496	-
8	3	9	85.1	1396	1062	1617
9	1	9	62.3	1789	-	-
10	2	9	69.3	1858	1987	-
11	2	9	69.3	1029	1015	-
12	-	-	-	-	-	-
13	-	-	-	-	-	-
14	-	-	-	-	-	-
15	-	-	-	-	-	-
16	-	-	-	-	-	-
17	-	-	-	-	-	-
18	-	-	-	-	-	-
19	-	-	-	-	-	-
20	-	-	-	-	-	-

Long Pulse Radar Test Signal

Test Signal Name: LP\_Signal\_04

Number of Bursts in Trial: 10

Burst	Pulses per Burst	Chrip (MHz)	Pulse Width(us)	PRI-1 (us)	PRI-2 (us)	PRI-3 (us)
1	3	8	87.3	1941	1435	1728
2	1	8	55	1336	-	-
3	1	8	51.5	1551	-	-
4	2	8	74.2	1791	1913	-
5	3	8	93.8	1727	1648	1742
6	3	8	84	1660	1474	1440
7	3	8	88.4	1288	1909	1739
8	2	8	76.5	1188	1036	-
9	2	8	73.6	1092	1887	-
10	3	8	93.7	1471	1824	1032
11	-	-	-	-	-	-
12	-	-	-	-	-	-
13	-	-	-	-	-	-
14	-	-	-	-	-	-
15	-	-	-	-	-	-
16	-	-	-	-	-	-
17	-	-	-	-	-	-
18	-	-	-	-	-	-
19	-	-	-	-	-	-
20	-	-	-	-	-	-

Long Pulse Radar Test Signal

Test Signal Name: LP\_Signal\_05

Number of Bursts in Trial: 13

Burst	Pulses per Burst	Chrip (MHz)	Pulse Width(us)	PRI-1 (us)	PRI-2 (us)	PRI-3 (us)
1	1	11	65.3	1857	-	-
2	2	11	68.9	1059	1100	-
3	3	11	90.7	1001	1629	1150
4	2	11	74.6	1245	1132	-
5	2	11	76.5	1837	1237	-
6	1	11	50.3	1374	-	-
7	3	11	93.2	1535	1225	1502
8	3	11	86.4	1356	1991	1590
9	3	11	86.4	1501	1951	1706
10	3	11	91.9	1248	1843	1182
11	2	11	74.1	1176	1307	-
12	3	11	86.4	1217	1268	1935
13	1	11	52.6	1304	-	-
14	-	-	-	-	-	-
15	-	-	-	-	-	-
16	-	-	-	-	-	-
17	-	-	-	-	-	-
18	-	-	-	-	-	-
19	-	-	-	-	-	-
20	-	-	-	-	-	-

Long Pulse Radar Test Signal

Test Signal Name: LP\_Signal\_06

Number of Bursts in Trial: 17

Burst	Pulses per Burst	Chrip (MHz)	Pulse Width(us)	PRI-1 (us)	PRI-2 (us)	PRI-3 (us)
1	3	16	87.9	1696	1985	1064
2	3	16	85	1979	1272	1922
3	1	16	65.5	1510	-	-
4	1	16	58.5	1482	-	-
5	2	16	71.8	1898	1156	-
6	1	16	55	1072	-	-
7	1	16	55.6	1276	-	-
8	2	16	82.7	1618	1655	-
9	2	16	77.1	1845	1902	-
10	1	16	56.5	1115	-	-
11	3	16	89.8	1086	1444	1680
12	1	16	61.9	1560	-	-
13	1	16	53.7	1151	-	-
14	1	16	62.5	1550	-	-
15	3	16	93	1232	1221	1322
16	3	16	91	1743	1168	1822
17	1	16	65.8	1323	-	-
18	-	-	-	-	-	-
19	-	-	-	-	-	-
20	-	-	-	-	-	-

Long Pulse Radar Test Signal

Test Signal Name: LP\_Signal\_07

Number of Bursts in Trial: 19

Burst	Pulses per Burst	Chrip (MHz)	Pulse Width(us)	PRI-1 (us)	PRI-2 (us)	PRI-3 (us)
1	1	18	62.5	1242	-	-
2	2	18	78.1	1438	1261	-
3	2	18	71.3	1337	1087	-
4	1	18	55.4	1534	-	-
5	3	18	84.6	1345	1430	1885
6	1	18	64.2	1441	-	-
7	1	18	56.5	1371	-	-
8	2	18	69.4	1333	1407	-
9	2	18	80.7	1102	1564	-
10	2	18	81.7	1849	1113	-
11	3	18	83.8	1016	1425	1166
12	3	18	98.7	1429	1640	1943
13	2	18	75.9	1542	1408	-
14	2	18	77.4	1241	1505	-
15	3	18	95.2	1974	1295	1816
16	1	18	50.9	1641	-	-
17	1	18	52.3	1780	-	-
18	1	18	63.7	1872	-	-
19	3	18	89.3	1860	1083	1399
20	-	-	-	-	-	-

Long Pulse Radar Test Signal

Test Signal Name: LP\_Signal\_08

Number of Bursts in Trial: 15

Burst	Pulses per Burst	Chrip (MHz)	Pulse Width(us)	PRI-1 (us)	PRI-2 (us)	PRI-3 (us)
1	2	14	78.2	1215	1274	-
2	2	14	75.4	1120	1751	-
3	1	14	66.5	1793	-	-
4	2	14	71.5	1852	1066	-
5	2	14	68	1258	1457	-
6	1	14	60.9	1463	-	-
7	3	14	88.2	1076	1819	1525
8	1	14	62.4	1952	-	-
9	1	14	50.9	1192	-	-
10	1	14	62.6	1201	-	-
11	2	14	72.8	1126	1357	-
12	3	14	87.9	1627	1458	1880
13	1	14	50.1	1802	-	-
14	3	14	95.4	1928	1324	1947
15	2	14	70.5	1619	1562	-
16	-	-	-	-	-	-
17	-	-	-	-	-	-
18	-	-	-	-	-	-
19	-	-	-	-	-	-
20	-	-	-	-	-	-

Long Pulse Radar Test Signal

Test Signal Name: LP\_Signal\_09

Number of Bursts in Trial: 16

Burst	Pulses per Burst	Chrip (MHz)	Pulse Width(us)	PRI-1 (us)	PRI-2 (us)	PRI-3 (us)
1	2	15	79.4	1891	1692	-
2	3	15	96.1	1424	1325	1175
3	1	15	65	1500	-	-
4	3	15	97.2	1770	1740	1005
5	1	15	53.2	1135	-	-
6	2	15	70.8	1809	1081	-
7	1	15	58.9	1668	-	-
8	3	15	89.2	1526	1111	1649
9	3	15	91.2	1664	1414	1303
10	2	15	73.4	1063	1317	-
11	2	15	71.8	1997	1313	-
12	3	15	84.1	1686	1609	1633
13	1	15	51.1	1061	-	-
14	2	15	79.2	1755	1803	-
15	3	15	94.6	1380	1140	1044
16	1	15	61	1465	-	-
17	-	-	-	-	-	-
18	-	-	-	-	-	-
19	-	-	-	-	-	-
20	-	-	-	-	-	-

Long Pulse Radar Test Signal

Test Signal Name: LP\_Signal\_10

Number of Bursts in Trial: 8

Burst	Pulses per Burst	Chrip (MHz)	Pulse Width(us)	PRI-1 (us)	PRI-2 (us)	PRI-3 (us)
1	1	5	51.3	1829	-	-
2	3	5	98.9	1897	1346	1605
3	1	5	53.7	1498	-	-
4	1	5	62.8	1900	-	-
5	3	5	90.4	1730	1986	1008
6	3	5	96	1433	1187	1808
7	1	5	56.5	1654	-	-
8	1	5	53.3	1398	-	-
9	-	-	-	-	-	-
10	-	-	-	-	-	-
11	-	-	-	-	-	-
12	-	-	-	-	-	-
13	-	-	-	-	-	-
14	-	-	-	-	-	-
15	-	-	-	-	-	-
16	-	-	-	-	-	-
17	-	-	-	-	-	-
18	-	-	-	-	-	-
19	-	-	-	-	-	-
20	-	-	-	-	-	-



Long Pulse Radar Test Signal

Test Signal Name: LP\_Signal\_11

Number of Bursts in Trial: 17

Burst	Pulses per Burst	Chrip (MHz)	Pulse Width(us)	PRI-1 (us)	PRI-2 (us)	PRI-3 (us)
1	3	17	94.6	1504	1284	1273
2	3	17	96.4	1224	1105	1725
3	1	17	51.8	1931	-	-
4	1	17	55.6	1269	-	-
5	1	17	56.7	1976	-	-
6	1	17	57.9	1911	-	-
7	3	17	93.9	1026	1761	1754
8	3	17	83.7	1841	1388	1366
9	1	17	53.3	1257	-	-
10	1	17	55.4	1518	-	-
11	3	17	98.1	1671	1046	1193
12	3	17	99.2	1104	1861	1434
13	3	17	85.9	1972	1503	1916
14	1	17	55.1	1792	-	-
15	1	17	60.4	1623	-	-
16	2	17	68.4	1929	1821	-
17	2	17	69.3	1211	1883	-
18	-	-	-	-	-	-
19	-	-	-	-	-	-
20	-	-	-	-	-	-

Long Pulse Radar Test Signal

Test Signal Name: LP\_Signal\_12

Number of Bursts in Trial: 12

Burst	Pulses per Burst	Chrip (MHz)	Pulse Width(us)	PRI-1 (us)	PRI-2 (us)	PRI-3 (us)
1	3	10	86.3	1342	1681	1601
2	2	10	75.4	1420	1865	-
3	3	10	98.1	1394	1622	1406
4	3	10	96.2	1942	1708	1053
5	2	10	76.9	1689	1932	-
6	3	10	87.1	1329	1807	1362
7	2	10	83.2	1732	1926	-
8	1	10	56.4	1784	-	-
9	1	10	51.6	2000	-	-
10	2	10	71.4	1998	1330	-
11	3	10	89.1	1514	1485	1582
12	3	10	96.4	1143	1576	1847
13	-	-	-	-	-	-
14	-	-	-	-	-	-
15	-	-	-	-	-	-
16	-	-	-	-	-	-
17	-	-	-	-	-	-
18	-	-	-	-	-	-
19	-	-	-	-	-	-
20	-	-	-	-	-	-

Long Pulse Radar Test Signal

Test Signal Name: LP\_Signal\_13

Number of Bursts in Trial: 11

Burst	Pulses per Burst	Chrip (MHz)	Pulse Width(us)	PRI-1 (us)	PRI-2 (us)	PRI-3 (us)
1	2	9	82.6	1970	1494	-
2	2	9	80.1	1946	1173	-
3	3	9	83.4	1028	1283	1863
4	3	9	89.5	1693	1253	1153
5	1	9	61.7	1338	-	-
6	1	9	52.6	1267	-	-
7	1	9	56.9	1774	-	-
8	2	9	69	1899	1263	-
9	1	9	53.2	1695	-	-
10	2	9	82.5	1866	1172	-
11	2	9	83.3	1716	1428	-
12	-	-	-	-	-	-
13	-	-	-	-	-	-
14	-	-	-	-	-	-
15	-	-	-	-	-	-
16	-	-	-	-	-	-
17	-	-	-	-	-	-
18	-	-	-	-	-	-
19	-	-	-	-	-	-
20	-	-	-	-	-	-

Long Pulse Radar Test Signal

Test Signal Name: LP\_Signal\_14

Number of Bursts in Trial: 8

Burst	Pulses per Burst	Chrip (MHz)	Pulse Width(us)	PRI-1 (us)	PRI-2 (us)	PRI-3 (us)
1	2	5	79.5	1401	1823	-
2	3	5	88.2	1107	1040	1353
3	2	5	80.8	1737	1873	-
4	3	5	95.8	1566	1729	1812
5	2	5	81.1	1796	1117	-
6	3	5	95.4	1558	1006	1769
7	2	5	75.1	1679	1584	-
8	3	5	96.2	1528	1630	1578
9	-	-	-	-	-	-
10	-	-	-	-	-	-
11	-	-	-	-	-	-
12	-	-	-	-	-	-
13	-	-	-	-	-	-
14	-	-	-	-	-	-
15	-	-	-	-	-	-
16	-	-	-	-	-	-
17	-	-	-	-	-	-
18	-	-	-	-	-	-
19	-	-	-	-	-	-
20	-	-	-	-	-	-

Long Pulse Radar Test Signal

Test Signal Name: LP\_Signal\_15

Number of Bursts in Trial: 15

Burst	Pulses per Burst	Chrip (MHz)	Pulse Width(us)	PRI-1 (us)	PRI-2 (us)	PRI-3 (us)
1	3	14	88.4	1293	1249	1653
2	3	14	85.4	1720	1703	1417
3	3	14	93.5	1469	1831	1869
4	1	14	54.1	1963	-	-
5	2	14	70.6	1181	1110	-
6	1	14	58.5	1390	-	-
7	1	14	57.2	1382	-	-
8	2	14	67.6	1598	1189	-
9	1	14	59.3	1208	-	-
10	2	14	68.6	1669	1573	-
11	3	14	99.3	1400	1826	1907
12	1	14	55	1683	-	-
13	3	14	86.5	1050	1296	1919
14	1	14	54.8	1577	-	-
15	3	14	87.3	1699	1409	1491
16	-	-	-	-	-	-
17	-	-	-	-	-	-
18	-	-	-	-	-	-
19	-	-	-	-	-	-
20	-	-	-	-	-	-

Long Pulse Radar Test Signal

Test Signal Name: LP\_Signal\_16

Number of Bursts in Trial: 17

Burst	Pulses per Burst	Chrip (MHz)	Pulse Width(us)	PRI-1 (us)	PRI-2 (us)	PRI-3 (us)
1	2	16	70.7	1183	1112	-
2	2	16	75.3	1524	1975	-
3	1	16	64.6	1771	-	-
4	1	16	59.6	1122	-	-
5	2	16	74.2	1955	1827	-
6	1	16	52.5	1559	-	-
7	1	16	53.5	1879	-	-
8	3	16	99.5	1131	1726	1395
9	1	16	66	1038	-	-
10	1	16	53.8	1901	-	-
11	3	16	92.2	1782	1715	1108
12	2	16	68.6	1082	1476	-
13	1	16	57.9	1638	-	-
14	3	16	96.2	1643	1790	1636
15	3	16	91.3	1282	1343	1548
16	1	16	52	1814	-	-
17	1	16	61	1539	-	-
18	-	-	-	-	-	-
19	-	-	-	-	-	-
20	-	-	-	-	-	-

Long Pulse Radar Test Signal

Test Signal Name: LP\_Signal\_17

Number of Bursts in Trial: 16

Burst	Pulses per Burst	Chrip (MHz)	Pulse Width(us)	PRI-1 (us)	PRI-2 (us)	PRI-3 (us)
1	2	15	76.5	1299	1694	-
2	2	15	75.2	1945	1650	-
3	1	15	50.6	1874	-	-
4	1	15	61	1555	-	-
5	3	15	89.1	1798	1835	1719
6	2	15	76	1833	1223	-
7	1	15	62.7	1734	-	-
8	2	15	81	1098	1936	-
9	1	15	54.4	1037	-	-
10	3	15	85	1581	1058	1762
11	3	15	97.6	1995	1109	1460
12	1	15	50.3	1198	-	-
13	1	15	54	1613	-	-
14	2	15	77.4	1065	1236	-
15	3	15	96.8	1529	1056	1402
16	2	15	74.7	1088	1806	-
17	-	-	-	-	-	-
18	-	-	-	-	-	-
19	-	-	-	-	-	-
20	-	-	-	-	-	-

Long Pulse Radar Test Signal

Test Signal Name: LP\_Signal\_18

Number of Bursts in Trial: 12

Burst	Pulses per Burst	Chrip (MHz)	Pulse Width(us)	PRI-1 (us)	PRI-2 (us)	PRI-3 (us)
1	1	10	50.9	1537	-	-
2	1	10	60	1372	-	-
3	2	10	70.5	1767	1615	-
4	1	10	66.4	1800	-	-
5	3	10	85.7	1364	1801	1067
6	1	10	50.9	1203	-	-
7	3	10	93.7	1996	1354	1881
8	3	10	84.9	1724	1448	1864
9	3	10	85.9	1596	1890	1917
10	2	10	77.5	1101	1557	-
11	1	10	50.3	1597	-	-
12	2	10	78.5	1379	1519	-
13	-	-	-	-	-	-
14	-	-	-	-	-	-
15	-	-	-	-	-	-
16	-	-	-	-	-	-
17	-	-	-	-	-	-
18	-	-	-	-	-	-
19	-	-	-	-	-	-
20	-	-	-	-	-	-



Long Pulse Radar Test Signal

Test Signal Name: LP\_Signal\_19

Number of Bursts in Trial: 18

Burst	Pulses per Burst	Chrip (MHz)	Pulse Width(us)	PRI-1 (us)	PRI-2 (us)	PRI-3 (us)
1	3	17	89.9	1422	1776	1096
2	3	17	99.3	1043	1270	1089
3	2	17	71.5	1673	1163	-
4	2	17	68.1	1702	1080	-
5	1	17	66.5	1097	-	-
6	3	17	88.3	1238	1119	1139
7	2	17	78.5	1389	1199	-
8	1	17	61.2	1959	-	-
9	1	17	54.1	1442	-	-
10	2	17	76.3	1676	1114	-
11	2	17	81.6	1977	1127	-
12	3	17	99.4	1468	1133	1644
13	1	17	51.9	1490	-	-
14	2	17	78.7	1439	1589	-
15	2	17	69.7	1316	1331	-
16	2	17	67.5	1281	1157	-
17	1	17	55.9	1068	-	-
18	3	17	99.2	1453	1054	1049
19	-	-	-	-	-	-
20	-	-	-	-	-	-

Long Pulse Radar Test Signal

Test Signal Name: LP\_Signal\_20

Number of Bursts in Trial: 14

Burst	Pulses per Burst	Chrip (MHz)	Pulse Width(us)	PRI-1 (us)	PRI-2 (us)	PRI-3 (us)
1	1	13	62	1895	-	-
2	2	13	76.4	1477	1375	-
3	3	13	95.4	1358	1456	1745
4	3	13	93.9	1773	1190	1556
5	1	13	57	1646	-	-
6	3	13	86.1	1154	1144	1123
7	2	13	70.8	1328	1423	-
8	3	13	85.7	1148	1707	1078
9	2	13	75.3	1667	1746	-
10	2	13	75.5	1204	1466	-
11	2	13	81.6	1334	1588	-
12	1	13	65.7	1231	-	-
13	2	13	75.1	1499	1662	-
14	1	13	61.6	1071	-	-
15	-	-	-	-	-	-
16	-	-	-	-	-	-
17	-	-	-	-	-	-
18	-	-	-	-	-	-
19	-	-	-	-	-	-
20	-	-	-	-	-	-

Long Pulse Radar Test Signal

Test Signal Name: LP\_Signal\_21

Number of Bursts in Trial: 10

Burst	Pulses per Burst	Chrip (MHz)	Pulse Width(us)	PRI-1 (us)	PRI-2 (us)	PRI-3 (us)
1	2	7	75.6	1511	1966	-
2	3	7	84.3	1162	1834	1625
3	3	7	91.1	1704	1039	1674
4	1	7	55.1	1747	-	-
5	1	7	63.5	1259	-	-
6	2	7	79.4	1675	1948	-
7	3	7	83.8	1914	1052	1099
8	1	7	65.7	1842	-	-
9	3	7	98.9	1484	1921	1219
10	3	7	85.6	1894	1159	1195
11	-	-	-	-	-	-
12	-	-	-	-	-	-
13	-	-	-	-	-	-
14	-	-	-	-	-	-
15	-	-	-	-	-	-
16	-	-	-	-	-	-
17	-	-	-	-	-	-
18	-	-	-	-	-	-
19	-	-	-	-	-	-
20	-	-	-	-	-	-

Long Pulse Radar Test Signal

Test Signal Name: LP\_Signal\_22

Number of Bursts in Trial: 20

Burst	Pulses per Burst	Chrip (MHz)	Pulse Width(us)	PRI-1 (us)	PRI-2 (us)	PRI-3 (us)
1	2	20	70.6	1415	1214	-
2	2	20	74.7	1234	1290	-
3	2	20	78.4	1777	1405	-
4	2	20	71.2	1048	1455	-
5	1	20	64.5	1161	-	-
6	1	20	57	1536	-	-
7	2	20	81.3	1264	1093	-
8	2	20	76.2	1452	1128	-
9	2	20	79	1497	1103	-
10	3	20	86.8	1205	1608	1522
11	1	20	65.4	1352	-	-
12	2	20	73.9	1749	1319	-
13	2	20	83.2	1836	1632	-
14	3	20	96.1	1546	1840	1973
15	3	20	92.3	1626	1121	1930
16	3	20	85.4	1532	1486	1635
17	3	20	97.4	1868	1419	1348
18	2	20	80.9	1347	1572	-
19	1	20	62.9	1381	-	-
20	1	20	52.9	1786	-	-

Long Pulse Radar Test Signal

Test Signal Name: LP\_Signal\_23

Number of Bursts in Trial: 10

Burst	Pulses per Burst	Chrip (MHz)	Pulse Width(us)	PRI-1 (us)	PRI-2 (us)	PRI-3 (us)
1	2	7	79.7	1045	1312	-
2	3	7	88.5	1871	1999	1804
3	1	7	51.1	1606	-	-
4	2	7	69.9	1516	1280	-
5	2	7	73.7	1670	1289	-
6	2	7	67.6	1180	1051	-
7	3	7	87.6	1886	1967	1521
8	1	7	64.5	1418	-	-
9	1	7	54	1602	-	-
10	2	7	76.5	1637	1018	-
11	-	-	-	-	-	-
12	-	-	-	-	-	-
13	-	-	-	-	-	-
14	-	-	-	-	-	-
15	-	-	-	-	-	-
16	-	-	-	-	-	-
17	-	-	-	-	-	-
18	-	-	-	-	-	-
19	-	-	-	-	-	-
20	-	-	-	-	-	-

Long Pulse Radar Test Signal

Test Signal Name: LP\_Signal\_24

Number of Bursts in Trial: 11

Burst	Pulses per Burst	Chrip (MHz)	Pulse Width(us)	PRI-1 (us)	PRI-2 (us)	PRI-3 (us)
1	1	9	65.3	1202	-	-
2	3	9	96.3	1666	1118	1271
3	2	9	77.5	1250	1285	-
4	1	9	59.8	1750	-	-
5	2	9	73.3	1210	1934	-
6	2	9	82.4	1758	1138	-
7	1	9	57.7	1527	-	-
8	3	9	99.6	1403	1146	1574
9	2	9	71.1	1171	1867	-
10	2	9	68.3	1239	1206	-
11	3	9	94.3	1152	1933	1892
12	-	-	-	-	-	-
13	-	-	-	-	-	-
14	-	-	-	-	-	-
15	-	-	-	-	-	-
16	-	-	-	-	-	-
17	-	-	-	-	-	-
18	-	-	-	-	-	-
19	-	-	-	-	-	-
20	-	-	-	-	-	-

Long Pulse Radar Test Signal

Test Signal Name: LP\_Signal\_25

Number of Bursts in Trial: 12

Burst	Pulses per Burst	Chrip (MHz)	Pulse Width(us)	PRI-1 (us)	PRI-2 (us)	PRI-3 (us)
1	1	10	55.4	1981	-	-
2	3	10	86.8	1968	1547	1363
3	3	10	88.4	1017	1656	1862
4	3	10	96.3	1025	1954	1158
5	1	10	51.6	1718	-	-
6	1	10	51	1944	-	-
7	3	10	95.1	1611	1075	1940
8	1	10	62.9	1612	-	-
9	2	10	78.1	1815	1013	-
10	2	10	82.1	1450	1969	-
11	1	10	52.9	1698	-	-
12	1	10	52.8	1034	-	-
13	-	-	-	-	-	-
14	-	-	-	-	-	-
15	-	-	-	-	-	-
16	-	-	-	-	-	-
17	-	-	-	-	-	-
18	-	-	-	-	-	-
19	-	-	-	-	-	-
20	-	-	-	-	-	-

Long Pulse Radar Test Signal

Test Signal Name: LP\_Signal\_26

Number of Bursts in Trial: 17

Burst	Pulses per Burst	Chrip (MHz)	Pulse Width(us)	PRI-1 (us)	PRI-2 (us)	PRI-3 (us)
1	3	16	95.9	1359	1090	1965
2	1	16	55.8	1980	-	-
3	2	16	82.1	1768	1004	-
4	2	16	73.6	1594	1487	-
5	1	16	58.4	1467	-	-
6	3	16	97.5	1723	1391	1684
7	3	16	96.9	1554	1185	1988
8	2	16	69.4	1125	1607	-
9	2	16	66.7	1549	1805	-
10	2	16	72.1	1783	1672	-
11	1	16	52.4	1256	-	-
12	2	16	71.5	1478	1575	-
13	2	16	69.2	1579	1091	-
14	3	16	96.4	1663	1194	1174
15	2	16	73.4	1265	1553	-
16	2	16	72.8	1665	1903	-
17	1	16	59.9	1604	-	-
18	-	-	-	-	-	-
19	-	-	-	-	-	-
20	-	-	-	-	-	-



Long Pulse Radar Test Signal

Test Signal Name: LP\_Signal\_27

Number of Bursts in Trial: 20

Burst	Pulses per Burst	Chrip (MHz)	Pulse Width(us)	PRI-1 (us)	PRI-2 (us)	PRI-3 (us)
1	2	20	77.7	1308	1315	-
2	3	20	97.8	1136	1688	1446
3	1	20	59.8	1844	-	-
4	3	20	94.7	1142	1129	1291
5	1	20	58.7	1810	-	-
6	2	20	74.3	1012	1427	-
7	1	20	51.6	1918	-	-
8	1	20	62.7	1209	-	-
9	2	20	73.7	1294	1568	-
10	2	20	72	1454	1677	-
11	1	20	66.6	1585	-	-
12	3	20	92.6	1226	1200	1832
13	1	20	51.6	1367	-	-
14	2	20	75.9	1397	1785	-
15	3	20	94.5	1830	1155	1949
16	1	20	62.3	1287	-	-
17	3	20	93.5	1517	1254	1279
18	2	20	81.7	1910	1011	-
19	1	20	53.9	1462	-	-
20	3	20	91.2	1794	1531	1870

Long Pulse Radar Test Signal

Test Signal Name: LP\_Signal\_28

Number of Bursts in Trial: 8

Burst	Pulses per Burst	Chrip (MHz)	Pulse Width(us)	PRI-1 (us)	PRI-2 (us)	PRI-3 (us)
1	1	5	58.8	1306	-	-
2	3	5	99.3	1978	1027	1350
3	1	5	52	1386	-	-
4	2	5	74.2	1278	1222	-
5	3	5	98.9	1915	1760	1652
6	2	5	77.6	1042	1733	-
7	2	5	83.3	1255	1766	-
8	3	5	84.4	1912	1326	1493
9	-	-	-	-	-	-
10	-	-	-	-	-	-
11	-	-	-	-	-	-
12	-	-	-	-	-	-
13	-	-	-	-	-	-
14	-	-	-	-	-	-
15	-	-	-	-	-	-
16	-	-	-	-	-	-
17	-	-	-	-	-	-
18	-	-	-	-	-	-
19	-	-	-	-	-	-
20	-	-	-	-	-	-

Long Pulse Radar Test Signal

Test Signal Name: LP\_Signal\_29

Number of Bursts in Trial: 9

Burst	Pulses per Burst	Chrip (MHz)	Pulse Width(us)	PRI-1 (us)	PRI-2 (us)	PRI-3 (us)
1	2	6	66.8	1982	1878	-
2	2	6	77	2000	1247	-
3	1	6	55.2	1925	-	-
4	2	6	77.7	1896	1003	-
5	2	6	72.2	1850	1983	-
6	1	6	52.9	1765	-	-
7	1	6	50.4	1994	-	-
8	3	6	84.3	1302	1369	1600
9	3	6	93.2	1492	1779	1332
10	-	-	-	-	-	-
11	-	-	-	-	-	-
12	-	-	-	-	-	-
13	-	-	-	-	-	-
14	-	-	-	-	-	-
15	-	-	-	-	-	-
16	-	-	-	-	-	-
17	-	-	-	-	-	-
18	-	-	-	-	-	-
19	-	-	-	-	-	-
20	-	-	-	-	-	-

Long Pulse Radar Test Signal

Test Signal Name: LP\_Signal\_30

Number of Bursts in Trial: 19

Burst	Pulses per Burst	Chrip (MHz)	Pulse Width(us)	PRI-1 (us)	PRI-2 (us)	PRI-3 (us)
1	1	19	58.1	1376	-	-
2	3	19	87.2	1587	1277	1811
3	2	19	81.6	1164	1530	-
4	2	19	80.4	1413	1884	-
5	1	19	60.8	1055	-	-
6	3	19	84.8	1960	1731	1700
7	2	19	75.5	1958	1544	-
8	2	19	80.3	1022	1106	-
9	2	19	76.8	1533	1661	-
10	1	19	65	1141	-	-
11	3	19	96.3	1124	1856	1033
12	1	19	57.9	1443	-	-
13	1	19	59.2	1305	-	-
14	2	19	75.8	1927	1772	-
15	1	19	64.7	1541	-	-
16	2	19	69.4	1246	1825	-
17	2	19	81.6	1230	1571	-
18	1	19	51.1	1320	-	-
19	2	19	78.4	1950	1651	-
20	-	-	-	-	-	-

**BW80**

Long Pulse Radar Test Signal

Test Signal Name: LP\_Signal\_01

Number of Bursts in Trial: 10

Burst	Pulses per Burst	Chrip (MHz)	Pulse Width(us)	PRI-1 (us)	PRI-2 (us)	PRI-3 (us)
1	1	7	58.8	1293	-	-
2	2	7	67.2	1731	1960	-
3	2	7	79	1043	1583	-
4	1	7	56.3	1074	-	-
5	2	7	74.3	1714	1429	-
6	2	7	79.4	1609	1083	-
7	3	7	94.4	1958	1101	1226
8	1	7	54.4	1947	-	-
9	3	7	87.1	1277	1626	1167
10	2	7	67.7	1820	1477	-
11	-	-	-	-	-	-
12						
13						
14	-	-	-	-	-	-
15	-	-	-	-	-	-
16	-	-	-	-	-	-
17	-	-	-	-	-	-
18	-	-	-	-	-	-
19	-	-	-	-	-	-
20	-	-	-	-	-	-

Long Pulse Radar Test Signal

Test Signal Name: LP\_Signal\_02

Number of Bursts in Trial: 12

Burst	Pulses per Burst	Chrip (MHz)	Pulse Width(us)	PRI-1 (us)	PRI-2 (us)	PRI-3 (us)
1	2	10	69.4	1974	1961	-
2	2	10	69.5	1140	1656	-
3	2	10	72	1863	1564	-
4	3	10	86.6	1887	1299	1953
5	3	10	94	1547	1148	1570
6	2	10	68.2	1409	1353	-
7	2	10	71.7	1909	1632	-
8	3	10	96.8	1337	1052	1212
9	1	10	51.6	1879	-	-
10	1	10	50	1483	-	-
11	2	10	68.8	1094	1738	-
12	1	10	59.6	1408	-	-
13	-	-	-	-	-	-
14	-	-	-	-	-	-
15	-	-	-	-	-	-
16	-	-	-	-	-	-
17	-	-	-	-	-	-
18	-	-	-	-	-	-
19	-	-	-	-	-	-
20	-	-	-	-	-	-

Long Pulse Radar Test Signal

Test Signal Name: LP\_Signal\_03

Number of Bursts in Trial: 15

Burst	Pulses per Burst	Chrip (MHz)	Pulse Width(us)	PRI-1 (us)	PRI-2 (us)	PRI-3 (us)
1	3	14	84.8	2000	1985	1126
2	2	14	71.3	1309	1366	-
3	1	14	61.3	1230	-	-
4	2	14	74.2	1450	1356	-
5	3	14	86.7	1907	1599	1390
6	2	14	79.7	1406	1328	-
7	2	14	78.9	1097	1734	-
8	1	14	57.3	1698	-	-
9	1	14	65.3	1028	-	-
10	2	14	68.5	1763	1135	-
11	1	14	64.1	1461	-	-
12	1	14	58.5	1515	-	-
13	1	14	51	1549	-	-
14	2	14	76.7	1750	1319	-
15	1	14	54.8	1315	-	-
16	-	-	-	-	-	-
17	-	-	-	-	-	-
18	-	-	-	-	-	-
19	-	-	-	-	-	-
20	-	-	-	-	-	-

Long Pulse Radar Test Signal

Test Signal Name: LP\_Signal\_04

Number of Bursts in Trial: 9

Burst	Pulses per Burst	Chrip (MHz)	Pulse Width(us)	PRI-1 (us)	PRI-2 (us)	PRI-3 (us)
1	3	7	83.6	1942	1574	1208
2	1	7	62.1	1943	-	-
3	2	7	67.8	1247	1407	-
4	1	7	64.7	1118	-	-
5	3	7	94.4	1657	1248	1116
6	3	7	94.8	1834	1012	1243
7	1	7	55.9	1840	-	-
8	3	7	88.9	1467	1757	1756
9	2	7	70.5	1772	1479	-
10	-	-	-	-	-	-
11	-	-	-	-	-	-
12	-	-	-	-	-	-
13	-	-	-	-	-	-
14	-	-	-	-	-	-
15	-	-	-	-	-	-
16	-	-	-	-	-	-
17	-	-	-	-	-	-
18	-	-	-	-	-	-
19	-	-	-	-	-	-
20	-	-	-	-	-	-



Long Pulse Radar Test Signal

Test Signal Name: LP\_Signal\_05

Number of Bursts in Trial: 12

Burst	Pulses per Burst	Chrip (MHz)	Pulse Width(us)	PRI-1 (us)	PRI-2 (us)	PRI-3 (us)
1	2	12	82.3	1451	1235	-
2	3	12	86	1809	1996	1426
3	2	12	75.9	1658	1495	-
4	3	12	96.5	1415	1660	1445
5	3	12	92.4	1272	1751	1080
6	1	12	60.6	1234	-	-
7	2	12	80.8	1902	1939	-
8	3	12	99.3	1038	1176	1301
9	2	12	82.5	1045	1802	-
10	1	12	57.7	1838	-	-
11	3	12	95.1	1933	1619	1730
12	1	12	50.1	1762	-	-
13	-	-	-	-	-	-
14	-	-	-	-	-	-
15	-	-	-	-	-	-
16	-	-	-	-	-	-
17	-	-	-	-	-	-
18	-	-	-	-	-	-
19	-	-	-	-	-	-
20	-	-	-	-	-	-

Long Pulse Radar Test Signal

Test Signal Name: LP\_Signal\_06

Number of Bursts in Trial: 15

Burst	Pulses per Burst	Chrip (MHz)	Pulse Width(us)	PRI-1 (us)	PRI-2 (us)	PRI-3 (us)
1	3	14	92.8	1541	1350	1159
2	1	14	64.7	1633	-	-
3	2	14	75.6	1355	1920	-
4	2	14	79.7	1458	1249	-
5	1	14	52.4	1414	-	-
6	1	14	50.8	1914	-	-
7	1	14	55.3	1711	-	-
8	1	14	63.5	1500	-	-
9	3	14	85.5	1983	1182	1976
10	2	14	67.3	1833	1497	-
11	1	14	63.3	1923	-	-
12	3	14	88.1	1134	1394	1769
13	3	14	84.7	1847	1241	1260
14	3	14	83.8	1411	1748	1039
15	3	14	85.4	1018	1908	1372
16	-	-	-	-	-	-
17	-	-	-	-	-	-
18	-	-	-	-	-	-
19	-	-	-	-	-	-
20	-	-	-	-	-	-

Long Pulse Radar Test Signal

Test Signal Name: LP\_Signal\_07

Number of Bursts in Trial: 19

Burst	Pulses per Burst	Chrip (MHz)	Pulse Width(us)	PRI-1 (us)	PRI-2 (us)	PRI-3 (us)
1	2	19	74.5	1348	1113	-
2	1	19	64.8	1371	-	-
3	2	19	78.8	1980	1569	-
4	2	19	82.5	1556	1791	-
5	3	19	90.8	1015	1950	1685
6	2	19	77.3	1302	1857	-
7	3	19	95.7	1002	1898	1899
8	3	19	97.4	1518	1873	1216
9	3	19	92.9	1866	1510	1514
10	2	19	81.5	1358	1921	-
11	2	19	68.8	1875	1693	-
12	2	19	76.1	1399	1469	-
13	1	19	53.4	1387	-	-
14	2	19	77.7	1865	1204	-
15	1	19	51.8	1765	-	-
16	3	19	94.2	1132	1488	1717
17	3	19	97.2	1851	1811	1746
18	3	19	88.5	1396	1121	1501
19	1	19	62	1507	-	-
20	-	-	-	-	-	-

Long Pulse Radar Test Signal

Test Signal Name: LP\_Signal\_08

Number of Bursts in Trial: 9

Burst	Pulses per Burst	Chrip (MHz)	Pulse Width(us)	PRI-1 (us)	PRI-2 (us)	PRI-3 (us)
1	2	6	75.1	1470	1308	-
2	1	6	50	1198	-	-
3	2	6	68.8	1536	1349	-
4	1	6	65.1	1286	-	-
5	1	6	53.4	1614	-	-
6	3	6	88	1852	1223	1168
7	1	6	65.1	1245	-	-
8	2	6	83.3	1800	1238	-
9	1	6	55.4	1622	-	-
10	-	-	-	-	-	-
11	-	-	-	-	-	-
12	-	-	-	-	-	-
13	-	-	-	-	-	-
14	-	-	-	-	-	-
15	-	-	-	-	-	-
16	-	-	-	-	-	-
17	-	-	-	-	-	-
18	-	-	-	-	-	-
19	-	-	-	-	-	-
20	-	-	-	-	-	-

Long Pulse Radar Test Signal

Test Signal Name: LP\_Signal\_09

Number of Bursts in Trial: 17

Burst	Pulses per Burst	Chrip (MHz)	Pulse Width(us)	PRI-1 (us)	PRI-2 (us)	PRI-3 (us)
1	1	16	65	1755	-	-
2	2	16	72.7	1741	1785	-
3	3	16	87.8	1149	1056	1493
4	1	16	61.8	1284	-	-
5	1	16	58.6	1175	-	-
6	2	16	75.3	1825	1009	-
7	1	16	56.2	1732	-	-
8	3	16	84.4	1292	1989	1605
9	1	16	53.6	1332	-	-
10	2	16	75.3	1482	1023	-
11	1	16	54.2	1455	-	-
12	2	16	72.8	2000	1342	-
13	3	16	97.1	1199	1158	1890
14	2	16	67.3	1035	1818	-
15	2	16	82.7	1611	1558	-
16	3	16	98.2	1252	1651	1922
17	3	16	83.7	1174	1878	1889
18	-	-	-	-	-	-
19	-	-	-	-	-	-
20	-	-	-	-	-	-

Long Pulse Radar Test Signal

Test Signal Name: LP\_Signal\_10

Number of Bursts in Trial: 12

Burst	Pulses per Burst	Chrip (MHz)	Pulse Width(us)	PRI-1 (us)	PRI-2 (us)	PRI-3 (us)
1	2	10	74.8	1064	1888	-
2	1	10	51.8	1543	-	-
3	3	10	85.8	1526	1813	1330
4	3	10	83.7	1795	1166	1460
5	2	10	73.1	1703	1975	-
6	1	10	66.2	1229	-	-
7	3	10	99.7	1324	1374	1972
8	2	10	72.7	1555	1476	-
9	1	10	58.7	1000	-	-
10	3	10	85.3	1431	1936	1439
11	1	10	55.7	1261	-	-
12	3	10	99.8	1102	1901	1997
13	-	-	-	-	-	-
14	-	-	-	-	-	-
15	-	-	-	-	-	-
16	-	-	-	-	-	-
17	-	-	-	-	-	-
18	-	-	-	-	-	-
19	-	-	-	-	-	-
20	-	-	-	-	-	-

Long Pulse Radar Test Signal

Test Signal Name: LP\_Signal\_11

Number of Bursts in Trial: 13

Burst	Pulses per Burst	Chrip (MHz)	Pulse Width(us)	PRI-1 (us)	PRI-2 (us)	PRI-3 (us)
1	2	11	75.4	1463	1677	-
2	3	11	94.5	1525	1211	1617
3	2	11	75.7	1202	1963	-
4	3	11	94.1	1645	1684	1191
5	3	11	90.2	1595	1200	1720
6	2	11	82.4	1722	1776	-
7	2	11	70.2	1579	1655	-
8	3	11	93.7	1635	1788	1862
9	1	11	56.9	1087	-	-
10	2	11	67.5	1552	1225	-
11	2	11	78.2	1228	1828	-
12	2	11	71.5	1250	1789	-
13	2	11	67.4	1298	1010	-
14	-	-	-	-	-	-
15	-	-	-	-	-	-
16	-	-	-	-	-	-
17	-	-	-	-	-	-
18	-	-	-	-	-	-
19	-	-	-	-	-	-
20	-	-	-	-	-	-

Long Pulse Radar Test Signal

Test Signal Name: LP\_Signal\_12

Number of Bursts in Trial: 13

Burst	Pulses per Burst	Chrip (MHz)	Pulse Width(us)	PRI-1 (us)	PRI-2 (us)	PRI-3 (us)
1	3	11	90.6	1770	1184	1671
2	2	11	71.9	1745	1314	-
3	3	11	84.3	1906	1666	1100
4	3	11	89.3	1438	1221	1886
5	2	11	78.1	1767	1537	-
6	2	11	82.8	1502	1739	-
7	3	11	86.1	1351	1530	1652
8	2	11	66.9	1590	1637	-
9	2	11	69.8	1109	1194	-
10	1	11	63.1	1808	-	-
11	1	11	63.2	1904	-	-
12	3	11	97.5	1357	1186	1354
13	2	11	71.8	1965	1259	-
14	-	-	-	-	-	-
15	-	-	-	-	-	-
16	-	-	-	-	-	-
17	-	-	-	-	-	-
18	-	-	-	-	-	-
19	-	-	-	-	-	-
20	-	-	-	-	-	-



Long Pulse Radar Test Signal

Test Signal Name: LP\_Signal\_13

Number of Bursts in Trial: 13

Burst	Pulses per Burst	Chrip (MHz)	Pulse Width(us)	PRI-1 (us)	PRI-2 (us)	PRI-3 (us)
1	3	12	91.9	1987	1209	1849
2	1	12	56.4	1117	-	-
3	3	12	88.2	1992	1491	1128
4	3	12	89.2	1607	1275	1594
5	3	12	99.9	1565	1596	1404
6	3	12	90	1815	1804	1291
7	1	12	50.5	1412	-	-
8	3	12	84.7	1480	1728	1215
9	2	12	78.3	1152	1581	-
10	2	12	80.8	1793	1417	-
11	2	12	78.6	1462	1814	-
12	2	12	78.7	1504	1081	-
13	1	12	56.8	1786	-	-
14	-	-	-	-	-	-
15	-	-	-	-	-	-
16	-	-	-	-	-	-
17	-	-	-	-	-	-
18	-	-	-	-	-	-
19	-	-	-	-	-	-
20	-	-	-	-	-	-

Long Pulse Radar Test Signal

Test Signal Name: LP\_Signal\_14

Number of Bursts in Trial: 17

Burst	Pulses per Burst	Chrip (MHz)	Pulse Width(us)	PRI-1 (us)	PRI-2 (us)	PRI-3 (us)
1	3	16	85	1141	1876	1339
2	1	16	62.5	1736	-	-
3	1	16	54.4	1615	-	-
4	2	16	76.7	1304	1568	-
5	1	16	57.2	1701	-	-
6	2	16	73.7	1079	1774	-
7	1	16	64.3	1540	-	-
8	1	16	66.3	1382	-	-
9	2	16	82.6	1214	1924	-
10	3	16	94.4	1435	1941	1692
11	1	16	65.3	1034	-	-
12	3	16	83.4	1691	1959	1145
13	2	16	80.7	1845	1311	-
14	1	16	52.5	1723	-	-
15	2	16	69.7	1760	1271	-
16	2	16	82.8	1037	1859	-
17	1	16	55.5	1662	-	-
18	-	-	-	-	-	-
19	-	-	-	-	-	-
20	-	-	-	-	-	-

Long Pulse Radar Test Signal

Test Signal Name: LP\_Signal\_15

Number of Bursts in Trial: 19

Burst	Pulses per Burst	Chrip (MHz)	Pulse Width(us)	PRI-1 (us)	PRI-2 (us)	PRI-3 (us)
1	2	19	81.4	1994	1327	-
2	1	19	62.4	1276	-	-
3	3	19	96.7	1123	1968	1210
4	2	19	68.4	1824	1668	-
5	3	19	90.5	1092	1588	1754
6	1	19	63.7	1333	-	-
7	1	19	55.5	1112	-	-
8	2	19	67.8	1869	1115	-
9	2	19	67.6	1077	1437	-
10	3	19	88.2	1338	1481	1855
11	2	19	71	1995	1098	-
12	2	19	82.7	1810	1990	-
13	1	19	62.3	1318	-	-
14	3	19	91.2	1940	1368	1624
15	1	19	55.6	1646	-	-
16	1	19	60.5	1054	-	-
17	2	19	71.2	1381	1452	-
18	3	19	97.9	1856	1213	1422
19	2	19	73.6	1104	1345	-
20	-	-	-	-	-	-

Long Pulse Radar Test Signal

Test Signal Name: LP\_Signal\_16

Number of Bursts in Trial: 12

Burst	Pulses per Burst	Chrip (MHz)	Pulse Width(us)	PRI-1 (us)	PRI-2 (us)	PRI-3 (us)
1	1	10	62.4	1787	-	-
2	3	10	93.1	1487	1610	1831
3	1	10	55.8	1823	-	-
4	3	10	89.6	1900	1031	1910
5	2	10	83.1	1613	1359	-
6	1	10	55.4	1796	-	-
7	1	10	59.3	1063	-	-
8	1	10	62.1	1492	-	-
9	2	10	72.8	1316	1443	-
10	1	10	55.7	1195	-	-
11	2	10	69.2	1884	1680	-
12	3	10	87.5	1727	1244	1551
13	-	-	-	-	-	-
14	-	-	-	-	-	-
15	-	-	-	-	-	-
16	-	-	-	-	-	-
17	-	-	-	-	-	-
18	-	-	-	-	-	-
19	-	-	-	-	-	-
20	-	-	-	-	-	-

Long Pulse Radar Test Signal

Test Signal Name: LP\_Signal\_17

Number of Bursts in Trial: 13

Burst	Pulses per Burst	Chrip (MHz)	Pulse Width(us)	PRI-1 (us)	PRI-2 (us)	PRI-3 (us)
1	2	11	80.8	1777	1618	-
2	1	11	51.8	1848	-	-
3	2	11	72.7	1520	1984	-
4	3	11	99.4	1954	1846	1647
5	1	11	66.2	1022	-	-
6	2	11	82.1	1927	1835	-
7	3	11	88.5	1326	1867	1106
8	3	11	94.5	1916	1005	1842
9	3	11	98.8	1060	1885	1288
10	3	11	99	1832	1133	1306
11	1	11	58.9	1201	-	-
12	3	11	89.7	1874	1336	1545
13	3	11	85.5	1227	1024	1496
14	-	-	-	-	-	-
15	-	-	-	-	-	-
16	-	-	-	-	-	-
17	-	-	-	-	-	-
18	-	-	-	-	-	-
19	-	-	-	-	-	-
20	-	-	-	-	-	-

Long Pulse Radar Test Signal

Test Signal Name: LP\_Signal\_18

Number of Bursts in Trial: 20

Burst	Pulses per Burst	Chrip (MHz)	Pulse Width(us)	PRI-1 (us)	PRI-2 (us)	PRI-3 (us)
1	3	19	93.4	1222	1490	1119
2	3	19	83.6	1237	1138	1971
3	2	19	70.3	1172	1163	-
4	1	19	53.2	1661	-	-
5	1	19	59.7	1957	-	-
6	2	19	72.9	1153	1385	-
7	1	19	59.4	1744	-	-
8	1	19	54.7	1257	-	-
9	3	19	96.2	1970	1058	1026
10	2	19	70.3	1591	1290	-
11	1	19	62.5	1893	-	-
12	2	19	75.5	1082	1764	-
13	2	19	72.8	1076	1180	-
14	1	19	63.5	1150	-	-
15	1	19	62.9	1513	-	-
16	2	19	81.2	1616	1048	-
17	1	19	51.6	1280	-	-
18	2	19	82.7	1485	1020	-
19	1	19	62.1	1164	-	-
20	3	19	98.5	1346	1681	1644

Long Pulse Radar Test Signal

Test Signal Name: LP\_Signal\_19

Number of Bursts in Trial: 8

Burst	Pulses per Burst	Chrip (MHz)	Pulse Width(us)	PRI-1 (us)	PRI-2 (us)	PRI-3 (us)
1	1	5	50.7	1233	-	-
2	3	5	90.2	1665	1706	1099
3	2	5	80.8	1817	1107	-
4	3	5	89.6	1710	1444	1544
5	3	5	91.8	1775	1640	1090
6	3	5	89.5	1124	1999	1883
7	2	5	78.5	1532	1321	-
8	2	5	82.8	1659	1300	-
9	-	-	-	-	-	-
10	-	-	-	-	-	-
11	-	-	-	-	-	-
12	-	-	-	-	-	-
13	-	-	-	-	-	-
14	-	-	-	-	-	-
15	-	-	-	-	-	-
16	-	-	-	-	-	-
17	-	-	-	-	-	-
18	-	-	-	-	-	-
19	-	-	-	-	-	-
20	-	-	-	-	-	-

Long Pulse Radar Test Signal

Test Signal Name: LP\_Signal\_20

Number of Bursts in Trial: 8

Burst	Pulses per Burst	Chrip (MHz)	Pulse Width(us)	PRI-1 (us)	PRI-2 (us)	PRI-3 (us)
1	1	5	53.4	1794	-	-
2	2	5	74.8	1489	1915	-
3	1	5	63.5	1473	-	-
4	3	5	84.2	1687	1218	1383
5	1	5	66.2	1344	-	-
6	1	5	54.1	1343	-	-
7	3	5	89.8	1509	1264	1178
8	2	5	71.9	1273	1593	-
9	-	-	-	-	-	-
10	-	-	-	-	-	-
11	-	-	-	-	-	-
12	-	-	-	-	-	-
13	-	-	-	-	-	-
14	-	-	-	-	-	-
15	-	-	-	-	-	-
16	-	-	-	-	-	-
17	-	-	-	-	-	-
18	-	-	-	-	-	-
19	-	-	-	-	-	-
20	-	-	-	-	-	-



Long Pulse Radar Test Signal

Test Signal Name: LP\_Signal\_21

Number of Bursts in Trial: 12

Burst	Pulses per Burst	Chrip (MHz)	Pulse Width(us)	PRI-1 (us)	PRI-2 (us)	PRI-3 (us)
1	3	11	89.1	1712	1011	1872
2	1	11	58.8	1205	-	-
3	1	11	63.1	1312	-	-
4	2	11	82.9	1918	1410	-
5	1	11	59.7	1442	-	-
6	2	11	82.8	1340	1310	-
7	3	11	84.7	1013	1139	1930
8	2	11	81.6	1548	1347	-
9	1	11	60.2	1584	-	-
10	2	11	73.9	1499	1634	-
11	3	11	93.4	1881	1379	1864
12	2	11	68.5	1160	1991	-
13	-	-	-	-	-	-
14	-	-	-	-	-	-
15	-	-	-	-	-	-
16	-	-	-	-	-	-
17	-	-	-	-	-	-
18	-	-	-	-	-	-
19	-	-	-	-	-	-
20	-	-	-	-	-	-

Long Pulse Radar Test Signal

Test Signal Name: LP\_Signal\_22

Number of Bursts in Trial: 10

Burst	Pulses per Burst	Chrip (MHz)	Pulse Width(us)	PRI-1 (us)	PRI-2 (us)	PRI-3 (us)
1	2	8	75.5	1830	1546	-
2	1	8	63.2	1506	-	-
3	3	8	97.1	1752	1979	1559
4	1	8	66.2	1192	-	-
5	3	8	96.8	1949	1826	1219
6	3	8	91.3	1317	1008	1812
7	3	8	84.7	1071	1498	1522
8	1	8	53.1	1524	-	-
9	1	8	52.7	1582	-	-
10	2	8	80.7	1562	1612	-
11	-	-	-	-	-	-
12	-	-	-	-	-	-
13	-	-	-	-	-	-
14	-	-	-	-	-	-
15	-	-	-	-	-	-
16	-	-	-	-	-	-
17	-	-	-	-	-	-
18	-	-	-	-	-	-
19	-	-	-	-	-	-
20	-	-	-	-	-	-

Long Pulse Radar Test Signal

Test Signal Name: LP\_Signal\_23

Number of Bursts in Trial: 17

Burst	Pulses per Burst	Chrip (MHz)	Pulse Width(us)	PRI-1 (us)	PRI-2 (us)	PRI-3 (us)
1	1	16	61.5	1391	-	-
2	2	16	70.3	1402	1578	-
3	3	16	94.4	1154	1523	1044
4	2	16	76.7	1203	1740	-
5	1	16	51.3	1792	-	-
6	2	16	71.3	1352	1919	-
7	1	16	56.8	1676	-	-
8	2	16	78.3	1367	1068	-
9	1	16	59.2	1535	-	-
10	2	16	68.7	1768	1190	-
11	2	16	73.8	1713	1036	-
12	3	16	91.1	1369	1716	1095
13	3	16	92.2	1274	1267	1050
14	3	16	92.9	1042	1623	1335
15	2	16	69.6	1627	1571	-
16	2	16	79.2	1575	1753	-
17	3	16	88.7	1550	1147	1363
18	-	-	-	-	-	-
19	-	-	-	-	-	-
20	-	-	-	-	-	-

Long Pulse Radar Test Signal

Test Signal Name: LP\_Signal\_24

Number of Bursts in Trial: 13

Burst	Pulses per Burst	Chrip (MHz)	Pulse Width(us)	PRI-1 (us)	PRI-2 (us)	PRI-3 (us)
1	2	11	67.9	1946	1179	-
2	1	11	55.4	1853	-	-
3	3	11	99.3	1398	1423	1631
4	2	11	79.4	1177	1690	-
5	2	11	67.8	1003	1892	-
6	3	11	96.1	1648	1694	1055
7	1	11	60	1689	-	-
8	1	11	57.2	1521	-	-
9	3	11	90.2	1905	1678	1183
10	2	11	77.8	1707	1860	-
11	3	11	97.3	1600	1232	1322
12	3	11	87.4	1683	1870	1130
13	2	11	75	1446	1131	-
14	-	-	-	-	-	-
15	-	-	-	-	-	-
16	-	-	-	-	-	-
17	-	-	-	-	-	-
18	-	-	-	-	-	-
19	-	-	-	-	-	-
20	-	-	-	-	-	-

Long Pulse Radar Test Signal

Test Signal Name: LP\_Signal\_25

Number of Bursts in Trial: 10

Burst	Pulses per Burst	Chrip (MHz)	Pulse Width(us)	PRI-1 (us)	PRI-2 (us)	PRI-3 (us)
1	2	8	69.4	1512	1305	-
2	3	8	86.6	1170	1236	1169
3	2	8	69.1	1395	1165	-
4	1	8	58.3	1806	-	-
5	3	8	97.4	1977	1161	1726
6	3	8	92.8	1951	1682	1088
7	3	8	88.5	1718	1780	1389
8	2	8	83	1926	1586	-
9	2	8	81.5	1265	1533	-
10	1	8	63.4	1880	-	-
11	-	-	-	-	-	-
12	-	-	-	-	-	-
13	-	-	-	-	-	-
14	-	-	-	-	-	-
15	-	-	-	-	-	-
16	-	-	-	-	-	-
17	-	-	-	-	-	-
18	-	-	-	-	-	-
19	-	-	-	-	-	-
20	-	-	-	-	-	-

Long Pulse Radar Test Signal

Test Signal Name: LP\_Signal\_26

Number of Bursts in Trial: 14

Burst	Pulses per Burst	Chrip (MHz)	Pulse Width(us)	PRI-1 (us)	PRI-2 (us)	PRI-3 (us)
1	2	12	74.7	1294	1401	-
2	2	12	81.9	1122	1146	-
3	1	12	64.7	1508	-	-
4	2	12	74.7	1638	1400	-
5	3	12	94.8	1016	1801	1969
6	3	12	84.5	1773	1091	1868
7	2	12	71.1	1955	1877	-
8	1	12	54.2	1188	-	-
9	3	12	96.6	1295	1424	1440
10	2	12	67.5	1453	1025	-
11	1	12	52.5	1925	-	-
12	2	12	66.8	1142	1580	-
13	3	12	97.8	1850	1729	1807
14	1	12	53.5	1105	-	-
15	-	-	-	-	-	-
16	-	-	-	-	-	-
17	-	-	-	-	-	-
18	-	-	-	-	-	-
19	-	-	-	-	-	-
20	-	-	-	-	-	-

Long Pulse Radar Test Signal

Test Signal Name: LP\_Signal\_27

Number of Bursts in Trial: 17

Burst	Pulses per Burst	Chrip (MHz)	Pulse Width(us)	PRI-1 (us)	PRI-2 (us)	PRI-3 (us)
1	1	16	51.2	1278	-	-
2	3	16	93.7	1432	1231	1436
3	2	16	74.3	1111	1621	-
4	3	16	84.4	1066	1030	1871
5	2	16	69.5	1224	1484	-
6	1	16	61.1	1220	-	-
7	3	16	93.5	1428	1093	1061
8	1	16	59.5	1047	-	-
9	3	16	90.9	1254	1242	1903
10	3	16	84.3	1628	1993	1185
11	3	16	99.3	1421	1799	1468
12	3	16	87.2	1531	1127	1572
13	2	16	72	1816	1173	-
14	3	16	83.8	1937	1303	1778
15	3	16	95.5	1197	1256	1944
16	2	16	76.9	1511	1829	-
17	3	16	90.8	1858	1296	1843
18	-	-	-	-	-	-
19	-	-	-	-	-	-
20	-	-	-	-	-	-

Long Pulse Radar Test Signal

Test Signal Name: LP\_Signal\_28

Number of Bursts in Trial: 15

Burst	Pulses per Burst	Chrip (MHz)	Pulse Width(us)	PRI-1 (us)	PRI-2 (us)	PRI-3 (us)
1	1	14	55.6	1329	-	-
2	3	14	86.5	1986	1360	1759
3	3	14	92	1679	1447	1672
4	2	14	74.6	1125	1705	-
5	3	14	97.6	1403	1654	1563
6	1	14	53.1	1696	-	-
7	2	14	71.3	1454	1266	-
8	1	14	65.2	1313	-	-
9	2	14	72.8	1567	1053	-
10	2	14	69	1931	1253	-
11	2	14	73.6	1474	1601	-
12	1	14	50.7	1239	-	-
13	2	14	69.8	1597	1196	-
14	2	14	72.4	1650	1006	-
15	1	14	52.6	1466	-	-
16	-	-	-	-	-	-
17	-	-	-	-	-	-
18	-	-	-	-	-	-
19	-	-	-	-	-	-
20	-	-	-	-	-	-



Long Pulse Radar Test Signal

Test Signal Name: LP\_Signal\_29

Number of Bursts in Trial: 15

Burst	Pulses per Burst	Chrip (MHz)	Pulse Width(us)	PRI-1 (us)	PRI-2 (us)	PRI-3 (us)
1	3	14	88.9	1620	1425	1069
2	1	14	65.6	1459	-	-
3	1	14	57.1	1246	-	-
4	1	14	53.6	1988	-	-
5	2	14	68.5	1630	1392	-
6	1	14	54	1688	-	-
7	1	14	63.5	1472	-	-
8	2	14	70.3	1070	1441	-
9	2	14	69.9	1803	1001	-
10	1	14	65.1	1376	-	-
11	3	14	91	1932	1004	1598
12	2	14	80.4	1790	1641	-
13	2	14	75.4	1604	1323	-
14	1	14	57.6	1418	-	-
15	1	14	62.5	1240	-	-
16	-	-	-	-	-	-
17	-	-	-	-	-	-
18	-	-	-	-	-	-
19	-	-	-	-	-	-
20	-	-	-	-	-	-

Long Pulse Radar Test Signal

Test Signal Name: LP\_Signal\_30

Number of Bursts in Trial: 9

Burst	Pulses per Burst	Chrip (MHz)	Pulse Width(us)	PRI-1 (us)	PRI-2 (us)	PRI-3 (us)
1	3	7	87.3	1917	1784	1702
2	1	7	58.7	1370	-	-
3	2	7	69.7	1649	1320	-
4	2	7	76.8	1700	1285	-
5	3	7	97	1837	1089	1576
6	2	7	80.3	1078	1341	-
7	1	7	55.7	1695	-	-
8	2	7	78.9	1021	1821	-
9	1	7	53.7	1602	-	-
10	-	-	-	-	-	-
11	-	-	-	-	-	-
12	-	-	-	-	-	-
13	-	-	-	-	-	-
14	-	-	-	-	-	-
15	-	-	-	-	-	-
16	-	-	-	-	-	-
17	-	-	-	-	-	-
18	-	-	-	-	-	-
19	-	-	-	-	-	-
20	-	-	-	-	-	-

**BW160**

Long Pulse Radar Test Signal

Test Signal Name: LP\_Signal\_01

Number of Bursts in Trial: 11

Burst	Pulses per Burst	Chrip (MHz)	Pulse Width(us)	PRI-1 (us)	PRI-2 (us)	PRI-3 (us)
1	1	9	63.2	1251	-	-
2	3	9	93	1099	1203	1528
3	2	9	77.2	1842	1132	-
4	3	9	84.1	1139	1584	1206
5	1	9	52	1514	-	-
6	2	9	76.6	1696	1078	-
7	2	9	83	1188	1467	-
8	2	9	74.1	1282	1923	-
9	3	9	97.4	1521	1847	1791
10	1	9	56.1	1558	-	-
11	3	9	98.7	1315	1204	1306
12						
13						
14						
15						
16						
17						
18						
19						
20						

Long Pulse Radar Test Signal

Test Signal Name: LP\_Signal\_02

Number of Bursts in Trial: 19

Burst	Pulses per Burst	Chrip (MHz)	Pulse Width(us)	PRI-1 (us)	PRI-2 (us)	PRI-3 (us)
1	1	18	60.2	1801	-	-
2	1	18	56.5	1403	-	-
3	3	18	97.8	1719	1959	1990
4	3	18	89.1	1916	1920	1723
5	1	18	50.9	1175	-	-
6	3	18	97.6	1053	1186	1250
7	3	18	93.8	1138	1234	1548
8	1	18	66.3	1699	-	-
9	2	18	80.4	1405	1177	-
10	1	18	50.2	1575	-	-
11	3	18	86.8	1319	1339	1393
12	1	18	52.4	1085	-	-
13	2	18	70.8	1861	1355	-
14	1	18	52.6	1999	-	-
15	3	18	98.2	1742	1522	1609
16	2	18	78.4	1300	1573	-
17	2	18	77.9	1899	1729	-
18	1	18	58.8	1692	-	-
19	2	18	70.5	1668	1182	-
20						

Long Pulse Radar Test Signal

Test Signal Name: LP\_Signal\_03

Number of Bursts in Trial: 15

Burst	Pulses per Burst	Chrip (MHz)	Pulse Width(us)	PRI-1 (us)	PRI-2 (us)	PRI-3 (us)
1	1	13	52.3	1596	-	-
2	3	13	88.8	1292	1975	1156
3	3	13	97.5	1388	1281	1285
4	2	13	79.5	1036	1287	-
5	1	13	51.1	1299	-	-
6	3	13	90.2	1345	1623	1163
7	3	13	95.6	1280	1240	1715
8	3	13	86.9	1010	1887	1098
9	2	13	72.7	1066	1561	-
10	2	13	79.2	1174	1983	-
11	3	13	96.5	1655	1446	1932
12	2	13	69.2	1241	1507	-
13	3	13	92.6	1858	1284	1006
14	3	13	99.5	1811	1981	1346
15	2	13	78	1183	1258	-
16						
17						
18						
19						
20						

Long Pulse Radar Test Signal

Test Signal Name: LP\_Signal\_04

Number of Bursts in Trial: 16

Burst	Pulses per Burst	Chrip (MHz)	Pulse Width(us)	PRI-1 (us)	PRI-2 (us)	PRI-3 (us)
1	3	15	96.5	1057	1829	1321
2	2	15	75.1	1700	1650	-
3	3	15	91.7	1152	1273	1367
4	2	15	74.6	1912	1014	-
5	2	15	69.7	1935	1783	-
6	1	15	59.9	1084	-	-
7	2	15	76.8	1733	1675	-
8	1	15	53.1	1245	-	-
9	2	15	68.9	1756	1195	-
10	1	15	50	1142	-	-
11	2	15	76.4	1608	1048	-
12	3	15	90.6	1782	1443	1061
13	1	15	56.3	1870	-	-
14	2	15	81.4	1354	1395	-
15	1	15	53.9	1480	-	-
16	3	15	98.2	1896	1785	1005
17						
18						
19						
20						

Long Pulse Radar Test Signal

Test Signal Name: LP\_Signal\_05

Number of Bursts in Trial: 8

Burst	Pulses per Burst	Chrip (MHz)	Pulse Width(us)	PRI-1 (us)	PRI-2 (us)	PRI-3 (us)
1	1	5	55	1081	-	-
2	1	5	65.3	1524	-	-
3	2	5	76.9	1929	1493	-
4	1	5	53.8	1476	-	-
5	1	5	59.9	1333	-	-
6	1	5	62.8	1749	-	-
7	2	5	77.1	1119	1565	-
8	3	5	96.7	1331	1746	1176
9						
10						
11						
12						
13						
14						
15						
16						
17						
18						
19						
20						

Long Pulse Radar Test Signal

Test Signal Name: LP\_Signal\_06

Number of Bursts in Trial: 14

Burst	Pulses per Burst	Chrip (MHz)	Pulse Width(us)	PRI-1 (us)	PRI-2 (us)	PRI-3 (us)
1	3	13	99	1503	1924	1407
2	1	13	55.4	1682	-	-
3	1	13	60.7	1063	-	-
4	2	13	71.1	1917	1474	-
5	3	13	87.1	1344	1541	1257
6	3	13	83.9	1589	1537	1598
7	2	13	81.1	1880	1889	-
8	3	13	94.3	1269	1231	1930
9	1	13	52.9	1955	-	-
10	3	13	92.8	1815	1856	1199
11	1	13	56.1	1914	-	-
12	2	13	73	1253	1448	-
13	3	13	86.8	1276	1043	1972
14	1	13	53.3	1289	-	-
15						
16						
17						
18						
19						
20						



Long Pulse Radar Test Signal

Test Signal Name: LP\_Signal\_07

Number of Bursts in Trial: 16

Burst	Pulses per Burst	Chrip (MHz)	Pulse Width(us)	PRI-1 (us)	PRI-2 (us)	PRI-3 (us)
1	3	15	89.2	1520	1813	1948
2	1	15	60.5	1326	-	-
3	2	15	75.6	1427	1795	-
4	3	15	85.7	1356	1944	1166
5	2	15	78.5	1050	1838	-
6	2	15	79.5	1205	1219	-
7	2	15	74.7	1404	1931	-
8	3	15	99.6	1515	1248	1803
9	3	15	89.2	1109	1167	1107
10	1	15	55.4	1442	-	-
11	2	15	68.7	1429	1894	-
12	2	15	81	1684	1374	-
13	3	15	91.5	1252	1992	1029
14	1	15	53.8	1591	-	-
15	1	15	65.7	1525	-	-
16	3	15	95.7	1892	1128	1239
17						
18						
19						
20						

Long Pulse Radar Test Signal

Test Signal Name: LP\_Signal\_08

Number of Bursts in Trial: 14

Burst	Pulses per Burst	Chrip (MHz)	Pulse Width(us)	PRI-1 (us)	PRI-2 (us)	PRI-3 (us)
1	2	12	68.1	1789	1765	-
2	3	12	83.7	1271	1288	1233
3	3	12	98.1	1421	1034	1044
4	3	12	95.1	1114	1657	1027
5	2	12	75.7	1263	1090	-
6	1	12	64.2	1901	-	-
7	3	12	99.3	1327	1320	1606
8	1	12	55.6	1074	-	-
9	1	12	66	1527	-	-
10	3	12	85	1621	1464	1482
11	2	12	68.9	1970	1883	-
12	2	12	82.1	1351	1469	-
13	3	12	87.7	1841	1640	1009
14	1	12	63.5	1599	-	-
15						
16						
17						
18						
19						
20						

Long Pulse Radar Test Signal

Test Signal Name: LP\_Signal\_09

Number of Bursts in Trial: 20

Burst	Pulses per Burst	Chrip (MHz)	Pulse Width(us)	PRI-1 (us)	PRI-2 (us)	PRI-3 (us)
1	2	20	75.3	1881	1127	-
2	2	20	81	1274	1648	-
3	1	20	61.4	1077	-	-
4	1	20	51.7	1570	-	-
5	2	20	76.2	1478	1019	-
6	1	20	66.3	1501	-	-
7	2	20	78.2	1626	1818	-
8	2	20	74.3	1123	1201	-
9	3	20	84.3	1165	1144	1809
10	3	20	97.6	1335	1753	1453
11	2	20	71.9	1153	1939	-
12	3	20	99.4	1900	1069	1389
13	1	20	66.2	1516	-	-
14	1	20	55.2	1502	-	-
15	1	20	52.4	1745	-	-
16	1	20	56	1193	-	-
17	3	20	92.5	1585	1534	1304
18	2	20	77.3	1747	1730	-
19	2	20	78.6	1015	1202	-
20	1	20	57.2	1382	-	-

Long Pulse Radar Test Signal

Test Signal Name: LP\_Signal\_10

Number of Bursts in Trial: 9

Burst	Pulses per Burst	Chrip (MHz)	Pulse Width(us)	PRI-1 (us)	PRI-2 (us)	PRI-3 (us)
1	2	6	74.7	1508	1788	-
2	2	6	72.4	1718	1439	-
3	2	6	74.9	1097	1455	-
4	3	6	91.8	1602	1799	1376
5	2	6	77.7	1823	1748	-
6	2	6	74.9	1922	1672	-
7	1	6	61.3	1903	-	-
8	2	6	69.9	1089	1772	-
9	2	6	69.6	1008	1134	-
10						
11						
12						
13						
14						
15						
16						
17						
18						
19						
20						

Long Pulse Radar Test Signal

Test Signal Name: LP\_Signal\_11

Number of Bursts in Trial: 20

Burst	Pulses per Burst	Chrip (MHz)	Pulse Width(us)	PRI-1 (us)	PRI-2 (us)	PRI-3 (us)
1	3	20	93.6	1370	1793	1594
2	1	20	60.5	1093	-	-
3	3	20	92.6	1607	1991	1504
4	1	20	61.9	1773	-	-
5	2	20	75.7	1659	1151	-
6	2	20	80.1	1353	1419	-
7	3	20	87.8	1001	1291	1396
8	2	20	69.6	1651	1819	-
9	3	20	89.7	1764	1338	1254
10	2	20	77.7	1634	1641	-
11	3	20	99.4	1064	1432	1627
12	2	20	67.4	1418	1874	-
13	3	20	93.9	1178	1519	1909
14	3	20	99.5	1362	1192	1977
15	1	20	50.4	1771	-	-
16	2	20	73.1	1848	1550	-
17	2	20	76.3	1888	1787	-
18	3	20	98.1	1740	1721	1638
19	3	20	94	1832	1593	1461
20	1	20	53.2	1218	-	-

Long Pulse Radar Test Signal

Test Signal Name: LP\_Signal\_12

Number of Bursts in Trial: 10

Burst	Pulses per Burst	Chrip (MHz)	Pulse Width(us)	PRI-1 (us)	PRI-2 (us)	PRI-3 (us)
1	1	8	59.9	1968	-	-
2	3	8	92.6	1072	1399	1032
3	3	8	91.7	1988	1458	1428
4	1	8	53.5	1686	-	-
5	2	8	80.4	1490	1347	-
6	3	8	88.9	1459	1698	1083
7	1	8	52.9	1485	-	-
8	1	8	56	1039	-	-
9	2	8	69.7	1549	1755	-
10	2	8	74	1279	1140	-
11						
12						
13						
14						
15						
16						
17						
18						
19						
20						

Long Pulse Radar Test Signal

Test Signal Name: LP\_Signal\_13

Number of Bursts in Trial: 9

Burst	Pulses per Burst	Chrip (MHz)	Pulse Width(us)	PRI-1 (us)	PRI-2 (us)	PRI-3 (us)
1	1	7	51.3	1489	-	-
2	1	7	54.9	1149	-	-
3	1	7	58.3	1605	-	-
4	1	7	54.6	1316	-	-
5	3	7	90.8	1154	1226	1247
6	3	7	87	1578	1643	1375
7	2	7	79.3	1677	1041	-
8	3	7	87.4	1631	1586	1323
9	3	7	90.6	1361	1466	1411
10						
11						
12						
13						
14						
15						
16						
17						
18						
19						
20						

Long Pulse Radar Test Signal

Test Signal Name: LP\_Signal\_14

Number of Bursts in Trial: 20

Burst	Pulses per Burst	Chrip (MHz)	Pulse Width(us)	PRI-1 (us)	PRI-2 (us)	PRI-3 (us)
1	2	20	75.2	1744	1145	-
2	1	20	64.6	1971	-	-
3	3	20	86.5	1532	1301	1031
4	1	20	52.7	1028	-	-
5	3	20	99.7	1040	1486	1451
6	2	20	79.2	1488	1702	-
7	3	20	89.9	1553	1984	1492
8	2	20	80.8	1869	1511	-
9	2	20	73	1437	1030	-
10	2	20	74.5	1208	1734	-
11	2	20	68.6	1400	1013	-
12	1	20	51.3	1816	-	-
13	2	20	76.8	1087	1674	-
14	2	20	67.4	1845	1665	-
15	1	20	66.6	1844	-	-
16	1	20	59.7	1135	-	-
17	1	20	51	1088	-	-
18	2	20	68.9	1661	1024	-
19	3	20	89.1	1497	1915	1170
20	2	20	81.6	1921	1877	-



Long Pulse Radar Test Signal

Test Signal Name: LP\_Signal\_15

Number of Bursts in Trial: 18

Burst	Pulses per Burst	Chrip (MHz)	Pulse Width(us)	PRI-1 (us)	PRI-2 (us)	PRI-3 (us)
1	3	17	86.8	1854	1969	1825
2	2	17	77.1	1895	1473	-
3	2	17	81.8	1905	1615	-
4	3	17	99.9	1401	1025	1979
5	1	17	65.7	1652	-	-
6	2	17	76.3	1572	1408	-
7	3	17	94.5	1543	1430	1465
8	1	17	59.1	1802	-	-
9	3	17	89.3	1710	1212	1950
10	1	17	58.6	1897	-	-
11	1	17	63.5	1735	-	-
12	3	17	93.9	1129	1168	1383
13	3	17	89	1775	1689	1708
14	1	17	57.5	1047	-	-
15	2	17	68.7	1853	1904	-
16	3	17	88.7	1539	1761	1120
17	2	17	73.4	1259	1445	-
18	3	17	89.8	1058	1484	1189
19						
20						

Long Pulse Radar Test Signal

Test Signal Name: LP\_Signal\_16

Number of Bursts in Trial: 8

Burst	Pulses per Burst	Chrip (MHz)	Pulse Width(us)	PRI-1 (us)	PRI-2 (us)	PRI-3 (us)
1	3	5	92.1	1774	1390	1720
2	2	5	74.3	1852	1910	-
3	3	5	90.5	1094	1663	1191
4	1	5	58	1704	-	-
5	2	5	79.9	1592	1409	-
6	2	5	81.5	1566	1051	-
7	1	5	51.1	1691	-	-
8	2	5	72.7	1833	1583	-
9						
10						
11						
12						
13						
14						
15						
16						
17						
18						
19						
20						

Long Pulse Radar Test Signal

Test Signal Name: LP\_Signal\_17

Number of Bursts in Trial: 20

Burst	Pulses per Burst	Chrip (MHz)	Pulse Width(us)	PRI-1 (us)	PRI-2 (us)	PRI-3 (us)
1	2	20	74.5	1544	1805	-
2	3	20	87.5	1460	1664	1807
3	3	20	91.7	1886	1249	1849
4	3	20	94.9	1884	1717	1431
5	3	20	89.7	1000	1283	1213
6	2	20	68.1	1601	1349	-
7	3	20	90.3	1666	1369	1328
8	1	20	55.8	1878	-	-
9	1	20	53.7	1512	-	-
10	3	20	98.1	1161	1875	1580
11	2	20	82.9	1555	1111	-
12	3	20	86.6	1311	1637	1307
13	3	20	87.1	1857	1963	1947
14	2	20	73.3	1122	1873	-
15	3	20	84.8	1998	1743	1941
16	2	20	80.7	1831	1557	-
17	3	20	91.6	1420	1738	1470
18	1	20	64.3	1225	-	-
19	1	20	60.9	1309	-	-
20	2	20	74.8	1197	1617	-

Long Pulse Radar Test Signal

Test Signal Name: LP\_Signal\_18

Number of Bursts in Trial: 19

Burst	Pulses per Burst	Chrip (MHz)	Pulse Width(us)	PRI-1 (us)	PRI-2 (us)	PRI-3 (us)
1	1	19	62.4	1636	-	-
2	2	19	69.3	1002	1054	-
3	3	19	98.7	1360	1974	1441
4	2	19	78	1851	1244	-
5	3	19	86.3	1918	1310	1406
6	1	19	61.2	1426	-	-
7	2	19	76.8	1386	1997	-
8	1	19	64.8	1436	-	-
9	3	19	91.1	1928	1938	1576
10	2	19	78.8	1007	1817	-
11	3	19	97.3	1447	1117	1313
12	1	19	50.2	1982	-	-
13	3	19	98.8	1101	1517	1976
14	3	19	93	1255	1112	1468
15	1	19	51.7	1936	-	-
16	1	19	56.9	1554	-	-
17	2	19	67.5	1456	1925	-
18	3	19	94.4	1866	1758	1978
19	2	19	69	1371	1732	-
20						

Long Pulse Radar Test Signal

Test Signal Name: LP\_Signal\_19

Number of Bursts in Trial: 12

Burst	Pulses per Burst	Chrip (MHz)	Pulse Width(us)	PRI-1 (us)	PRI-2 (us)	PRI-3 (us)
1	2	10	70.9	1736	1367	-
2	1	10	62.4	1193	-	-
3	1	10	61.8	1596	-	-
4	1	10	52.6	1646	-	-
5	2	10	78.9	1049	1639	-
6	1	10	63.9	1679	-	-
7	3	10	98.5	1627	1731	1442
8	3	10	92	1294	1547	1119
9	1	10	65.8	1386	-	-
10	2	10	77.7	1987	1964	-
11	1	10	54.6	1553	-	-
12	2	10	77.7	1171	1413	-
13						
14						
15						
16						
17						
18						
19						
20						

Long Pulse Radar Test Signal

Test Signal Name: LP\_Signal\_20

Number of Bursts in Trial: 15

Burst	Pulses per Burst	Chrip (MHz)	Pulse Width(us)	PRI-1 (us)	PRI-2 (us)	PRI-3 (us)
1	1	14	65.6	1479	-	-
2	2	14	70.6	1075	1317	-
3	2	14	76.3	1949	1961	-
4	1	14	60.2	1653	-	-
5	1	14	55.2	1359	-	-
6	3	14	88.8	1110	1158	1076
7	1	14	63.6	1046	-	-
8	1	14	58.5	1229	-	-
9	2	14	78.5	1391	1590	-
10	3	14	91.3	1126	1108	1872
11	2	14	75.5	1697	1893	-
12	1	14	64.7	1221	-	-
13	2	14	74.9	1444	1911	-
14	1	14	50.8	1506	-	-
15	2	14	82.6	1582	1185	-
16						
17						
18						
19						
20						

Long Pulse Radar Test Signal

Test Signal Name: LP\_Signal\_21

Number of Bursts in Trial: 08

Burst	Pulses per Burst	Chrip (MHz)	Pulse Width(us)	PRI-1 (us)	PRI-2 (us)	PRI-3 (us)
1	3	5	87.9	1834	1951	1104
2	3	5	94.1	1762	1716	1410
3	2	5	71.5	1294	1750	-
4	2	5	77.8	1706	1337	-
5	1	5	63.2	1784	-	-
6	3	5	97.2	1552	1564	1216
7	3	5	95.4	1402	1336	1017
8	1	5	65.6	1068	-	-
9						
10						
11						
12						
13						
14						
15						
16						
17						
18						
19						
20						

Long Pulse Radar Test Signal

Test Signal Name: LP\_Signal\_22

Number of Bursts in Trial: 17

Burst	Pulses per Burst	Chrip (MHz)	Pulse Width(us)	PRI-1 (us)	PRI-2 (us)	PRI-3 (us)
1	2	16	71.2	1358	1100	-
2	2	16	79.3	1224	1475	-
3	1	16	65.5	1681	-	-
4	2	16	78.1	1827	1322	-
5	2	16	72.2	1164	1821	-
6	3	16	99.5	1115	1752	1800
7	1	16	58.5	1806	-	-
8	1	16	58	1065	-	-
9	2	16	75.2	1846	1246	-
10	2	16	81.3	1171	1956	-
11	1	16	62.3	1646	-	-
12	2	16	81.6	1342	1628	-
13	2	16	79.7	1020	1937	-
14	2	16	72.4	1797	1669	-
15	2	16	82.8	1341	1116	-
16	3	16	96.6	1049	1890	1533
17	2	16	68.1	1481	1070	-
18						
19						
20						



Long Pulse Radar Test Signal

Test Signal Name: LP\_Signal\_23

Number of Bursts in Trial: 08

Burst	Pulses per Burst	Chrip (MHz)	Pulse Width(us)	PRI-1 (us)	PRI-2 (us)	PRI-3 (us)
1	1	5	53.8	1709	-	-
2	3	5	85.9	1768	1645	1563
3	3	5	90.5	1676	1055	1597
4	1	5	54.1	1425	-	-
5	2	5	78.2	1348	1952	-
6	2	5	68.4	1169	1760	-
7	2	5	78.9	1776	1620	-
8	2	5	69.8	1662	1381	-
9						
10						
11						-
12						-
13						
14						
15						
16						
17						
18						
19						
20						

Long Pulse Radar Test Signal

Test Signal Name: LP\_Signal\_24

Number of Bursts in Trial: 13

Burst	Pulses per Burst	Chrip (MHz)	Pulse Width(us)	PRI-1 (us)	PRI-2 (us)	PRI-3 (us)
1	2	11	73.2	1690	1966	-
2	3	11	99.1	1707	1220	1763
3	1	11	58.6	1647	-	-
4	3	11	97.3	1926	1499	1529
5	1	11	61.7	1434	-	-
6	3	11	96.6	1727	1600	1804
7	2	11	69.2	1042	1023	-
8	2	11	70.3	1898	1701	-
9	1	11	54.9	1256	-	-
10	1	11	55.1	1986	-	-
11	2	11	81	1736	1477	-
12	3	11	89.8	1372	1724	1571
13	1	11	60.7	1958	-	-
14						
15						
16						
17						
18						
19						
20						

Long Pulse Radar Test Signal

Test Signal Name: LP\_Signal\_25

Number of Bursts in Trial: 08

Burst	Pulses per Burst	Chrip (MHz)	Pulse Width(us)	PRI-1 (us)	PRI-2 (us)	PRI-3 (us)
1	3	5	91.4	1673	1060	1196
2	1	5	59.1	1639	-	-
3	2	5	70	1303	1822	-
4	2	5	83.2	1778	1215	-
5	1	5	50.2	1433	-	-
6	3	5	83.4	1695	1106	1885
7	1	5	62.5	1946	-	-
8	2	5	69.3	1622	1731	-
9						
10						
11						
12						
13						
14						
15						
16						
17						
18						
19						
20						

Long Pulse Radar Test Signal

Test Signal Name: LP\_Signal\_26

Number of Bursts in Trial: 20

Burst	Pulses per Burst	Chrip (MHz)	Pulse Width(us)	PRI-1 (us)	PRI-2 (us)	PRI-3 (us)
1	1	20	52.9	1509	-	-
2	1	20	65.4	1714	-	-
3	1	20	61.3	1907	-	-
4	2	20	75	1136	1618	-
5	1	20	59.7	1919	-	-
6	1	20	59.4	1942	-	-
7	1	20	61.3	1850	-	-
8	1	20	54.8	1859	-	-
9	1	20	61.4	1624	-	-
10	3	20	93.1	1162	1649	1368
11	1	20	60.8	1312	-	-
12	3	20	86.6	1180	1828	1397
13	1	20	58.2	1860	-	-
14	3	20	99.1	1394	1275	1722
15	1	20	50.4	1423	-	-
16	3	20	99.9	1227	1343	1867
17	1	20	60.8	1879	-	-
18	1	20	63.5	1003	-	-
19	3	20	84.8	1613	1703	1685
20	3	20	93.2	1222	1194	1567

Long Pulse Radar Test Signal

Test Signal Name: LP\_Signal\_27

Number of Bursts in Trial: 15

Burst	Pulses per Burst	Chrip (MHz)	Pulse Width(us)	PRI-1 (us)	PRI-2 (us)	PRI-3 (us)
1	1	14	61.3	1190	-	-
2	2	14	74.7	1633	1062	-
3	2	14	67.3	1022	1147	-
4	1	14	51.7	1352	-	-
5	1	14	56.7	1413	-	-
6	1	14	57.3	1642	-	-
7	1	14	62.4	1658	-	-
8	2	14	76.7	1902	1121	-
9	2	14	70.5	1546	1513	-
10	2	14	70.9	1644	1505	-
11	2	14	77.9	1518	1004	-
12	3	14	85.1	1155	2000	1330
13	1	14	66.3	1876	-	-
14	1	14	50.5	1018	-	-
15	2	14	70.2	1814	1035	-
16						
17						
18						
19						
20						

Long Pulse Radar Test Signal

Test Signal Name: LP\_Signal\_28

Number of Bursts in Trial: 15

Burst	Pulses per Burst	Chrip (MHz)	Pulse Width(us)	PRI-1 (us)	PRI-2 (us)	PRI-3 (us)
1	3	13	83.6	1207	1133	1542
2	3	13	97.4	1540	1026	1906
3	2	13	72.2	1688	1933	-
4	1	13	52	1610	-	-
5	3	13	87.1	1863	1210	1236
6	1	13	57.9	1272	-	-
7	1	13	65.4	1577	-	-
8	3	13	93.6	1214	1412	1835
9	1	13	62.1	1463	-	-
10	2	13	70.1	1705	1989	-
11	1	13	53.1	1262	-	-
12	1	13	52.5	1318	-	-
13	3	13	92.4	1340	1364	1780
14	1	13	58.6	1293	-	-
15	2	13	70.2	1332	1993	-
16						
17						
18						
19						
20						

Long Pulse Radar Test Signal

Test Signal Name: LP\_Signal\_29

Number of Bursts in Trial: 10

Burst	Pulses per Burst	Chrip (MHz)	Pulse Width(us)	PRI-1 (us)	PRI-2 (us)	PRI-3 (us)
1	2	7	72.4	1495	1679	-
2	3	7	86.8	1296	1683	1836
3	3	7	98.7	1667	1767	1305
4	2	7	69.4	1855	1611	-
5	1	7	57.9	1157	-	-
6	2	7	78.2	1927	1759	-
7	3	7	98.1	1105	1995	1547
8	1	7	59.5	1726	-	-
9	2	7	68.3	1741	1325	-
10	1	7	52.3	1500	-	-
11						
12						
13						
14						
15						
16						
17						
18						
19						

Long Pulse Radar Test Signal

Test Signal Name: LP\_Signal\_30

Number of Bursts in Trial: 13

Burst	Pulses per Burst	Chrip (MHz)	Pulse Width(us)	PRI-1 (us)	PRI-2 (us)	PRI-3 (us)
1	3	11	97	1181	1440	1980
2	3	11	84.6	1562	1184	1779
3	3	11	84.4	1452	1350	1868
4	3	11	90.5	1678	1228	1223
5	1	11	65.1	1943	-	-
6	2	11	75.8	1130	1498	-
7	2	11	70.2	1994	1712	-
8	1	11	57.7	1960	-	-
9	2	11	78.8	1953	1379	-
10	2	11	66.8	1131	1366	-
11	1	11	52.5	1560	-	-
12	3	11	88.7	1278	1957	1934
13	1	11	61.4	1016	-	-
14						
15						
16						
17						
18						
19						
20						



## A.2 The Frequency Hopping Radar pattern

Hopping Frequency Sequence Name: HOP_FREQ_SEQ_01					
Frequency (MHz)	0	1	2	3	4
0	5691	5382	5438	5668	5419
5	5471	5385	5437	5502	5347
10	5363	5555	5607	5409	5421
15	5649	5404	5284	5310	5305
20	5554	5508	5370	5441	5531
25	5488	5496	5582	5522	5602
30	5317	5307	5299	5281	5325
35	5390	5504	5563	5577	5714
40	5435	5613	5679	5513	5642
45	5587	5417	5336	5505	5681
50	5648	5594	5391	5256	5530
55	5262	5722	5387	5278	5614
60	5580	5705	5470	5296	5595
65	5655	5378	5443	5606	5625
70	5446	5413	5466	5717	5275
75	5711	5626	5339	5410	5424
80	5566	5301	5448	5641	5293
85	5573	5393	5367	5535	5515
90	5350	5633	5459	5467	5297
95	5279	5386	5715	5624	5403

Hopping Frequency Sequence Name: HOP_FREQ_SEQ_02					
Frequency (MHz)	0	1	2	3	4
0	5471	5621	5374	5354	5261
5	5513	5310	5512	5568	5651
10	5672	5344	5648	5507	5442
15	5262	5434	5290	5355	5497
20	5562	5577	5408	5530	5504
25	5279	5699	5308	5556	5266
30	5681	5264	5514	5523	5432
35	5595	5359	5255	5628	5274
40	5696	5520	5278	5639	5516
45	5397	5419	5563	5259	5438
50	5470	5567	5307	5619	5463
55	5666	5575	5707	5502	5433
60	5551	5635	5338	5427	5481
65	5324	5644	5555	5661	5350
70	5691	5538	5703	5613	5687
75	5585	5686	5547	5553	5461
80	5422	5457	5636	5588	5367
85	5377	5478	5445	5545	5684
90	5610	5287	5462	5285	5323
95	5597	5258	5420	5467	5698

Hopping Frequency Sequence Name: HOP\_FREQ\_SEQ\_03

Frequency (MHz)	0	1	2	3	4
0	5251	5385	5310	5515	5481
5	5555	5332	5587	5256	5383
10	5603	5705	5311	5702	5463
15	5350	5561	5393	5400	5689
20	5570	5268	5349	5522	5477
25	5642	5685	5427	5412	5590
30	5308	5696	5632	5682	5343
35	5571	5686	5252	5505	5542
40	5304	5458	5421	5636	5348
45	5280	5502	5524	5312	5325
50	5346	5358	5708	5286	5513
55	5288	5661	5692	5488	5283
60	5356	5404	5270	5370	5504
65	5697	5717	5397	5707	5616
70	5351	5663	5544	5655	5650
75	5613	5625	5330	5678	5321
80	5307	5316	5538	5637	5413
85	5638	5485	5627	5291	5357
90	5382	5437	5562	5451	5596
95	5473	5366	5395	5509	5464

Hopping Frequency Sequence Name: HOP\_FREQ\_SEQ\_04

Frequency (MHz)	0	1	2	3	4
0	5506	5624	5721	5579	5323
5	5694	5257	5662	5419	5590
10	5437	5494	5352	5422	5484
15	5438	5688	5496	5348	5406
20	5578	5337	5290	5611	5547
25	5433	5537	5533	5516	5350
30	5556	5372	5456	5541	5710
35	5302	5523	5658	5553	5524
40	5387	5396	5661	5633	5277
45	5260	5585	5582	5365	5697
50	5444	5409	5584	5457	5379
55	5615	5407	5546	5520	5490
60	5703	5663	5705	5691	5668
65	5550	5636	5320	5512	5675
70	5304	5716	5639	5503	5527
75	5295	5659	5606	5485	5681
80	5459	5384	5648	5501	5378
85	5689	5631	5305	5317	5297
90	5294	5264	5454	5617	5435
95	5452	5469	5690	5507	5562

Hopping Frequency Sequence Name: HOP\_FREQ\_SEQ\_05

Frequency (MHz)	0	1	2	3	4
0	5664	5388	5657	5265	5543
5	5261	5279	5262	5582	5419
10	5368	5283	5393	5617	5505
15	5526	5340	5599	5598	5489
20	5503	5328	5603	5520	5321
25	5486	5620	5658	5445	5513
30	5587	5705	5361	5277	5490
35	5319	5336	5467	5363	5567
40	5334	5426	5630	5584	5715
45	5668	5640	5418	5477	5476
50	5460	5508	5407	5304	5569
55	5597	5268	5367	5649	5655
60	5648	5495	5531	5259	5394
65	5499	5672	5530	5307	5478
70	5473	5719	5524	5615	5462
75	5496	5415	5327	5694	5377
80	5447	5301	5320	5572	5561
85	5449	5721	5643	5404	5482
90	5303	5488	5471	5392	5413
95	5602	5299	5454	5351	5675

Hopping Frequency Sequence Name: HOP\_FREQ\_SEQ\_06

Frequency (MHz)	0	1	2	3	4
0	5444	5627	5593	5426	5385
5	5303	5679	5337	5648	5626
10	5299	5547	5434	5526	5517
15	5467	5702	5438	5412	5497
20	5572	5269	5692	5493	5587
25	5338	5464	5346	5531	5431
30	5470	5327	5382	5656	5416
35	5581	5590	5586	5381	5677
40	5650	5272	5666	5724	5513
45	5695	5276	5601	5374	5267
50	5352	5321	5511	5597	5608
55	5723	5280	5523	5312	5562
60	5345	5690	5454	5680	5448
65	5611	5362	5674	5281	5545
70	5344	5373	5591	5421	5465
75	5568	5514	5329	5496	5541
80	5510	5298	5515	5551	5414
85	5524	5641	5686	5652	5701
90	5647	5406	5265	5500	5585
95	5252	5387	5313	5675	5697

Hopping Frequency Sequence Name: HOP\_FREQ\_SEQ\_07

Frequency (MHz)	0	1	2	3	4
0	5699	5391	5529	5587	5605
5	5442	5701	5412	5336	5358
10	5608	5475	5435	5547	5497
15	5708	5483	5604	5505	5263
20	5685	5684	5466	5665	5667
25	5450	5251	5573	5320	5427
30	5445	5631	5379	5555	5672
35	5264	5392	5516	5258	5334
40	5721	5675	5359	5659	5629
45	5703	5562	5686	5431	5570
50	5468	5477	5502	5381	5309
55	5432	5510	5635	5256	5280
60	5626	5418	5397	5647	5572
65	5469	5559	5714	5255	5347
70	5600	5470	5380	5337	5558
75	5549	5291	5439	5277	5670
80	5673	5710	5454	5584	5261
85	5554	5648	5425	5521	5299
90	5288	5609	5602	5307	5484
95	5285	5303	5317	5723	5444

Hopping Frequency Sequence Name: HOP\_FREQ\_SEQ\_08

Frequency (MHz)	0	1	2	3	4
0	5479	5630	5465	5273	5447
5	5484	5626	5487	5499	5662
10	5539	5697	5516	5568	5693
15	5624	5336	5431	5321	5416
20	5429	5723	5298	5439	5363
25	5614	5395	5554	5285	5712
30	5684	5384	5660	5308	5674
35	5694	5288	5279	5417	5306
40	5452	5438	5623	5574	5718
45	5274	5655	5442	5717	5480
50	5419	5579	5673	5613	5397
55	5254	5514	5656	5692	5578
60	5658	5561	5675	5580	5563
65	5678	5669	5716	5346	5683
70	5404	5361	5265	5311	5449
75	5446	5339	5659	5530	5543
80	5533	5297	5258	5670	5430
85	5454	5547	5453	5519	5602
90	5719	5502	5418	5711	5548
95	5619	5362	5468	5649	5406

Hopping Frequency Sequence Name: HOP\_FREQ\_SEQ\_09

Frequency (MHz)	0	1	2	3	4
0	5637	5394	5401	5434	5667
5	5526	5648	5562	5662	5470
10	5486	5557	5350	5589	5306
15	5276	5439	5476	5513	5424
20	5498	5664	5290	5412	5629
25	5466	5501	5658	5319	5279
30	5670	5341	5400	5397	5261
35	5379	5550	5570	5695	5291
40	5521	5464	5339	5715	5678
45	5538	5525	5300	5533	5358
50	5374	5552	5361	5369	5385
55	5310	5593	5365	5395	5504
60	5615	5442	5295	5622	5614
65	5631	5543	5383	5324	5450
70	5298	5422	5653	5323	5705
75	5511	5320	5314	5461	5321
80	5625	5357	5512	5607	5645
85	5387	5349	5539	5270	5430
90	5255	5636	5417	5549	5556
95	5628	5509	5352	5410	5672

Hopping Frequency Sequence Name: HOP\_FREQ\_SEQ\_10

Frequency (MHz)	0	1	2	3	4
0	5417	5633	5337	5595	5509
5	5568	5670	5637	5253	5601
10	5304	5275	5598	5545	5610
15	5297	5403	5542	5521	5705
20	5432	5664	5605	5379	5385
25	5517	5415	5704	5287	5353
30	5321	5559	5298	5615	5709
35	5692	5400	5470	5443	5345
40	5609	5604	5402	5482	5712
45	5510	5518	5608	5261	5586
50	5571	5550	5715	5575	5278
55	5305	5460	5339	5500	5691
60	5600	5722	5530	5567	5702
65	5330	5561	5643	5719	5658
70	5446	5426	5346	5552	5310
75	5453	5622	5398	5257	5373
80	5492	5475	5570	5625	5481
85	5442	5260	5354	5265	5352
90	5607	5597	5262	5357	5527
95	5690	5364	5472	5533	5454

Hopping Frequency Sequence Name: HOP\_FREQ\_SEQ\_11

Frequency (MHz)	0	1	2	3	4
0	5672	5397	5273	5659	5254
5	5707	5595	5712	5416	5430
10	5710	5539	5261	5265	5631
15	5385	5530	5645	5469	5422
20	5343	5258	5643	5371	5358
25	5308	5267	5432	5488	5387
30	5460	5448	5255	5483	5415
35	5658	5714	5498	5620	5444
40	5687	5340	5722	5331	5439
45	5691	5319	5639	5458	5585
50	5251	5291	5664	5576	5627
55	5648	5293	5690	5510	5571
60	5376	5695	5512	5534	5253
65	5507	5466	5668	5597	5656
70	5318	5624	5296	5553	5374
75	5494	5419	5473	5252	5685
80	5351	5692	5544	5661	5637
85	5260	5630	5457	5370	5557
90	5522	5533	5716	5572	5292
95	5527	5517	5352	5489	5618

Hopping Frequency Sequence Name: HOP\_FREQ\_SEQ\_12

Frequency (MHz)	0	1	2	3	4
0	5452	5636	5684	5345	5571
5	5274	5617	5312	5579	5637
10	5544	5328	5302	5363	5652
15	5473	5560	5651	5514	5614
20	5351	5424	5584	5460	5331
25	5671	5594	5635	5592	5421
30	5502	5434	5687	5710	5581
35	5510	5534	5380	5392	5278
40	5487	5368	5478	5299	5377
45	5692	5723	5364	5427	5342
50	5399	5361	5722	5405	5707
55	5445	5505	5385	5457	5463
60	5554	5550	5667	5633	5488
65	5588	5318	5379	5556	5698
70	5253	5650	5586	5562	5454
75	5504	5320	5607	5381	5561
80	5357	5638	5610	5593	5552
85	5660	5612	5618	5280	5539
90	5275	5485	5309	5582	5598
95	5347	5371	5721	5568	5358

Hopping Frequency Sequence Name: HOP\_FREQ\_SEQ\_13

Frequency (MHz)	0	1	2	3	4
0	5707	5400	5620	5506	5316
5	5542	5387	5267	5369	5475
10	5689	5343	5558	5673	5561
15	5687	5279	5559	5331	5359
20	5493	5525	5452	5304	5462
25	5543	5363	5696	5358	5544
30	5323	5644	5688	5409	5433
35	5720	5365	5306	5426	5448
40	5694	5691	5252	5325	5675
45	5458	5382	5338	5648	5610
50	5715	5603	5393	5464	5697
55	5418	5549	5579	5595	5526
60	5416	5634	5550	5499	5295
65	5380	5496	5490	5566	5669
70	5698	5480	5608	5390	5656
75	5547	5704	5609	5335	5706
80	5532	5281	5333	5388	5545
85	5670	5552	5541	5556	5269
90	5528	5663	5391	5575	5377
95	5714	5594	5326	5637	5582

Hopping Frequency Sequence Name: HOP\_FREQ\_SEQ\_14

Frequency (MHz)	0	1	2	3	4
0	5390	5639	5556	5667	5633
5	5358	5564	5462	5333	5576
10	5406	5478	5384	5278	5694
15	5552	5339	5382	5604	5620
20	5270	5659	5466	5541	5277
25	5350	5395	5469	5325	5392
30	5586	5687	5601	5428	5561
35	5253	5456	5674	5579	5459
40	5533	5558	5629	5322	5438
45	5465	5396	5701	5400	5591
50	5304	5444	5553	5520	5362
55	5262	5310	5345	5387	5288
60	5715	5602	5303	5442	5691
65	5515	5608	5530	5275	5411
70	5559	5351	5680	5568	5276
75	5513	5443	5644	5709	5355
80	5555	5272	5391	5616	5461
85	5493	5617	5298	5542	5551
90	5721	5596	5703	5343	5692
95	5566	5618	5707	5452	5313

Hopping Frequency Sequence Name: HOP\_FREQ\_SEQ\_15

Frequency (MHz)	0	1	2	3	4
0	5645	5500	5492	5353	5378
5	5497	5489	5537	5496	5405
10	5715	5267	5425	5473	5640
15	5466	5485	5552	5337	5278
20	5253	5504	5533	5250	5616
25	5344	5672	5526	5426	5673
30	5558	5546	5335	5548	5523
35	5547	5470	5257	5373	5372
40	5263	5567	5635	5319	5436
45	5321	5454	5279	5287	5467
50	5480	5495	5642	5721	5684
55	5450	5487	5542	5358	5320
60	5389	5434	5604	5514	5464
65	5644	5265	5545	5689	5631
70	5284	5720	5656	5527	5273
75	5374	5419	5494	5688	5553
80	5301	5418	5564	5444	5708
85	5579	5556	5361	5668	5412
90	5593	5707	5654	5658	5381
95	5457	5272	5647	5516	5686

Hopping Frequency Sequence Name: HOP\_FREQ\_SEQ\_16

Frequency (MHz)	0	1	2	3	4
0	5425	5264	5428	5514	5695
5	5539	5511	5612	5659	5646
10	5531	5466	5668	5261	5253
15	5496	5588	5597	5529	5286
20	5419	5445	5622	5698	5504
25	5671	5400	5630	5460	5292
30	5562	5515	5487	5271	5565
35	5260	5266	5507	5287	5686
40	5346	5505	5316	5365	5301
45	5631	5415	5332	5552	5721
50	5656	5546	5256	5544	5628
55	5638	5441	5593	5361	5707
60	5449	5570	5334	5527	5431
65	5715	5413	5583	5572	5437
70	5492	5325	5420	5472	5632
75	5486	5620	5494	5465	5475
80	5566	5681	5481	5549	5284
85	5347	5647	5639	5273	5326
90	5660	5397	5692	5263	5349
95	5474	5327	5414	5568	5658



Hopping Frequency Sequence Name: HOP\_FREQ\_SEQ\_17

Frequency (MHz)	0	1	2	3	4
0	5680	5503	5364	5675	5440
5	5581	5436	5687	5347	5344
10	5577	5320	5507	5291	5282
15	5341	5623	5594	5642	5721
20	5672	5585	5386	5614	5671
25	5392	5523	5603	5259	5494
30	5334	5548	5472	5501	5261
35	5566	5704	5351	5634	5660
40	5298	5622	5429	5346	5640
45	5410	5294	5281	5714	5473
50	5385	5439	5597	5357	5442
55	5367	5475	5254	5395	5308
60	5655	5678	5578	5260	5376
65	5670	5353	5377	5441	5362
70	5619	5307	5707	5295	5397
75	5406	5387	5321	5608	5445
80	5589	5456	5717	5676	5462
85	5629	5544	5449	5479	5489
90	5602	5368	5669	5673	5336
95	5611	5465	5666	5361	5491

Hopping Frequency Sequence Name: HOP\_FREQ\_SEQ\_18

Frequency (MHz)	0	1	2	3	4
0	5363	5267	5300	5361	5282
5	5623	5458	5287	5510	5648
10	5411	5681	5645	5486	5303
15	5332	5275	5697	5687	5438
20	5680	5654	5424	5703	5644
25	5658	5472	5331	5528	5473
30	5437	5429	5716	5413	5289
35	5368	5442	5430	5338	5461
40	5512	5284	5308	5407	5601
45	5261	5322	5531	5704	5436
50	5665	5419	5349	5498	5474
55	5649	5707	5425	5321	5502
60	5323	5264	5311	5655	5614
65	5599	5573	5566	5392	5390
70	5487	5404	5259	5494	5718
75	5318	5446	5674	5250	5662
80	5560	5634	5627	5584	5334
85	5630	5672	5663	5405	5470
90	5508	5696	5685	5389	5525
95	5596	5292	5465	5720	5520

Hopping Frequency Sequence Name: HOP\_FREQ\_SEQ\_19

Frequency (MHz)	0	1	2	3	4
0	5618	5506	5711	5425	5502
5	5287	5383	5362	5576	5380
10	5342	5470	5686	5681	5324
15	5420	5402	5325	5635	5630
20	5688	5345	5365	5695	5617
25	5546	5437	5564	5562	5515
30	5326	5386	5359	5662	5584
35	5410	5533	5701	5588	5601
40	5300	5692	5697	5548	5404
45	5530	5716	5405	5492	5394
50	5591	5349	5612	5699	5620
55	5391	5266	5303	5671	5361
60	5687	5334	5577	5366	5465
65	5260	5594	5279	5638	5378
70	5393	5494	5463	5363	5430
75	5282	5322	5418	5271	5499
80	5385	5292	5443	5491	5250
85	5270	5625	5277	5678	5357
90	5532	5320	5579	5622	5680
95	5408	5723	5417	5605	5639

Hopping Frequency Sequence Name: HOP\_FREQ\_SEQ\_20

Frequency (MHz)	0	1	2	3	4
0	5398	5270	5647	5586	5344
5	5329	5405	5437	5264	5587
10	5273	5259	5252	5401	5345
15	5508	5529	5428	5680	5347
20	5599	5414	5306	5309	5590
25	5337	5640	5668	5596	5557
30	5312	5343	5574	5339	5307
35	5549	5624	5594	5266	5612
40	5614	5300	5635	5313	5362
45	5696	5488	5550	5447	5381
50	5603	5275	5709	5689	5685
55	5257	5403	5490	5494	5393
60	5377	5686	5641	5288	5684
65	5630	5656	5664	5710	5461
70	5493	5721	5439	5700	5302
75	5402	5368	5399	5426	5434
80	5280	5355	5440	5628	5372
85	5370	5632	5605	5352	5485
90	5634	5547	5591	5639	5578
95	5387	5595	5543	5629	5282

Hopping Frequency Sequence Name: HOP\_FREQ\_SEQ\_21

Frequency (MHz)	0	1	2	3	4
0	5653	5509	5583	5272	5564
5	5371	5330	5512	5427	5416
10	5582	5523	5293	5499	5366
15	5596	5559	5531	5250	5539
20	5607	5580	5344	5301	5563
25	5700	5600	5368	5297	5630
30	5696	5676	5300	5314	5588
35	5602	5688	5715	5390	5419
40	5526	5550	5383	5573	5456
45	5398	5291	5571	5608	5500
50	5268	5479	5489	5326	5420
55	5532	5686	5593	5309	5465
60	5522	5542	5253	5570	5704
65	5258	5633	5666	5391	5556
70	5360	5404	5447	5496	5415
75	5659	5271	5511	5380	5678
80	5536	5713	5515	5437	5406
85	5648	5335	5586	5378	5650
90	5312	5668	5429	5656	5270
95	5476	5269	5698	5266	5277

Hopping Frequency Sequence Name: HOP\_FREQ\_SEQ\_22

Frequency (MHz)	0	1	2	3	4
0	5433	5273	5519	5406	5413
5	5352	5587	5590	5623	5513
10	5312	5334	5694	5387	5686
15	5537	5673	5353	5615	5649
20	5285	5390	5536	5491	5452
25	5571	5401	5664	5263	5565
30	5257	5529	5265	5422	5428
35	5661	5669	5440	5389	5466
40	5511	5696	5492	5695	5559
45	5654	5569	5553	5533	5355
50	5665	5377	5509	5335	5476
55	5719	5640	5308	5506	5436
60	5651	5707	5402	5627	5301
65	5582	5605	5698	5351	5638
70	5596	5419	5391	5618	5715
75	5642	5557	5458	5455	5317
80	5578	5434	5601	5531	5368
85	5708	5659	5678	5637	5626
90	5370	5340	5318	5689	5657
95	5254	5374	5723	5326	5464

Hopping Frequency Sequence Name: HOP\_FREQ\_SEQ\_23

Frequency (MHz)	0	1	2	3	4
0	5591	5512	5455	5594	5626
5	5552	5277	5662	5656	5355
10	5347	5673	5375	5414	5408
15	5675	5338	5640	5718	5545
20	5526	5340	5701	5382	5509
25	5379	5401	5299	5602	5698
30	5305	5551	5689	5647	5514
35	5620	5394	5519	5457	5451
40	5703	5646	5449	5461	5489
45	5527	5539	5359	5627	5606
50	5420	5706	5366	5428	5598
55	5536	5323	5335	5325	5407
60	5397	5618	5709	5453	5722
65	5513	5531	5641	5433	5441
70	5645	5516	5599	5268	5367
75	5577	5587	5287	5700	5439
80	5707	5667	5573	5469	5334
85	5321	5434	5685	5671	5376
90	5643	5399	5568	5505	5324
95	5639	5571	5346	5312	5712

Hopping Frequency Sequence Name: HOP\_FREQ\_SEQ\_24

Frequency (MHz)	0	1	2	3	4
0	5371	5276	5391	5280	5468
5	5594	5299	5262	5344	5659
10	5278	5462	5416	5609	5429
15	5288	5465	5268	5534	5409
20	5264	5471	5482	5267	5253
25	5405	5706	5257	5444	5440
30	5646	5387	5666	5533	5610
35	5350	5500	5365	5542	5254
40	5290	5701	5486	5456	5519
45	5442	5685	5485	5479	5687
50	5359	5523	5548	5591	5619
55	5281	5434	5562	5563	5541
60	5376	5668	5714	5480	5580
65	5265	5513	5622	5717	5502
70	5699	5592	5721	5536	5556
75	5310	5368	5420	5484	5680
80	5354	5633	5704	5331	5613
85	5337	5624	5256	5568	5511
90	5642	5550	5388	5670	5427
95	5576	5453	5455	5329	5292

Hopping Frequency Sequence Name: HOP\_FREQ\_SEQ\_25

Frequency (MHz)	0	1	2	3	4
0	5626	5515	5327	5441	5688
5	5636	5699	5337	5507	5391
10	5684	5251	5457	5329	5450
15	5376	5592	5371	5333	5454
20	5542	5575	5680	5463	5455
25	5533	5677	5608	5335	5291
30	5486	5426	5603	5602	5440
35	5638	5672	5701	5621	5275
40	5279	5381	5703	5369	5483
45	5288	5499	5525	5646	5615
50	5572	5361	5718	5530	5301
55	5657	5589	5711	5405	5306
60	5438	5252	5563	5605	5373
65	5537	5429	5616	5475	5425
70	5411	5488	5702	5344	5697
75	5495	5428	5430	5414	5401
80	5261	5315	5610	5322	5389
85	5328	5466	5694	5663	5476
90	5596	5323	5586	5360	5433
95	5713	5564	5346	5347	5303

Hopping Frequency Sequence Name: HOP\_FREQ\_SEQ\_26

Frequency (MHz)	0	1	2	3	4
0	5406	5279	5263	5505	5530
5	5678	5721	5412	5670	5598
10	5518	5515	5595	5427	5471
15	5367	5622	5474	5281	5646
20	5453	5644	5621	5552	5428
25	5421	5529	5336	5439	5325
30	5528	5315	5560	5342	5592
35	5458	5317	5417	5290	5517
40	5641	5609	5480	5692	5479
45	5608	5704	5668	5362	5712
50	5419	5581	5487	5533	5424
55	5359	5496	5635	5698	5550
60	5302	5503	5657	5378	5652
65	5307	5675	5703	5483	5705
70	5673	5454	5397	5557	5382
75	5416	5425	5391	5486	5452
80	5715	5308	5380	5344	5647
85	5571	5525	5547	5576	5363
90	5402	5287	5538	5445	5500
95	5590	5476	5252	5446	5432

Hopping Frequency Sequence Name: HOP\_FREQ\_SEQ\_27

Frequency (MHz)	0	1	2	3	4
0	5564	5518	5674	5666	5275
5	5342	5646	5487	5261	5427
10	5449	5304	5636	5622	5492
15	5455	5274	5480	5326	5363
20	5461	5335	5659	5544	5401
25	5687	5381	5539	5640	5359
30	5570	5679	5517	5460	5366
35	5656	5378	5505	5310	5581
40	5631	5600	5579	5374	5574
45	5621	5459	5691	5287	5721
50	5724	5491	5595	5632	5576
55	5681	5380	5612	5313	5686
60	5454	5669	5582	5495	5609
65	5426	5603	5561	5327	5591
70	5470	5506	5652	5557	5330
75	5649	5413	5269	5670	5668
80	5438	5647	5553	5515	5322
85	5723	5618	5722	5717	5475
90	5309	5601	5344	5604	5690
95	5445	5685	5457	5368	5436

Hopping Frequency Sequence Name: HOP\_FREQ\_SEQ\_28

Frequency (MHz)	0	1	2	3	4
0	5344	5282	5610	5352	5592
5	5384	5668	5562	5424	5634
10	5380	5665	5677	5342	5513
15	5543	5401	5583	5371	5555
20	5469	5501	5600	5633	5374
25	5575	5330	5267	5269	5393
30	5709	5474	5675	5518	5476
35	5517	5596	5581	5356	5593
40	5470	5683	5614	5571	5453
45	5299	5723	5514	5367	5296
50	5504	5324	5325	5273	5378
55	5272	5537	5441	5252	5549
60	5287	5276	5627	5349	5362
65	5309	5724	5333	5366	5625
70	5372	5713	5315	5271	5445
75	5548	5428	5717	5697	5443
80	5618	5564	5680	5667	5652
85	5615	5262	5494	5512	5334
90	5306	5421	5305	5522	5620
95	5413	5619	5284	5552	5714

Hopping Frequency Sequence Name: HOP\_FREQ\_SEQ\_29

Frequency (MHz)	0	1	2	3	4
0	5599	5521	5546	5513	5337
5	5426	5593	5637	5587	5366
10	5689	5454	5718	5537	5534
15	5631	5528	5686	5416	5272
20	5380	5570	5541	5625	5347
25	5657	5373	5427	5276	5554
30	5431	5415	5292	5296	5656
35	5687	5377	5509	5604	5309
40	5291	5455	5282	5568	5382
45	5322	5306	5352	5401	5472
50	5259	5279	5327	5646	5696
55	5591	5470	5514	5507	5437
60	5482	5273	5553	5592	5585
65	5700	5566	5559	5632	5490
70	5321	5529	5433	5601	5331
75	5338	5317	5325	5697	5658
80	5684	5406	5263	5694	5260
85	5503	5265	5384	5617	5606
90	5365	5622	5545	5552	5522
95	5511	5567	5336	5707	5663

Hopping Frequency Sequence Name: HOP\_FREQ\_SEQ\_30

Frequency (MHz)	0	1	2	3	4
0	5379	5382	5482	5674	5654
5	5565	5615	5712	5275	5573
10	5620	5718	5284	5257	5555
15	5622	5655	5314	5364	5561
20	5388	5261	5714	5320	5254
25	5606	5576	5477	5461	5318
30	5443	5630	5444	5494	5698
35	5303	5648	5662	5518	5720
40	5471	5393	5522	5689	5302
45	5465	5405	5666	5594	5310
50	5625	5590	5604	5650	5684
55	5289	5485	5636	5602	5427
60	5580	5476	5538	5311	5271
65	5391	5524	5293	5490	5515
70	5436	5442	5480	5290	5554
75	5458	5460	5306	5474	5671
80	5570	5326	5691	5455	5424
85	5345	5703	5479	5657	5613
90	5710	5560	5586	5404	5440
95	5528	5417	5605	5642	5675

--- END ---