

FCC Test Report

Report No.: RF160728C11-1

FCC ID: MSQ-BAPAC1750

Test Model: BAP-AC1750

Received Date: July 28, 2016

Test Date: Oct. 02 to Nov. 09, 2016

Issued Date: Dec. 07, 2016

Applicant: ASUSTek COMPUTER INC.

Address: 4F, No. 150, Li-Te Rd., Peitou, Taipei 112, Taiwan

Issued By: Bureau Veritas Consumer Products Services (H.K.) Ltd., Taoyuan Branch
Hsin Chu Laboratory

Lab Address: E-2, No.1, Li Hsin 1st Road, Hsinchu Science Park, Hsinchu City 300,
Taiwan R.O.C.

Test Location (1): E-2, No.1, Li Hsin 1st Road, Hsinchu Science Park, Hsinchu City 300,
Taiwan R.O.C.

Test Location (2): No. 49, Ln. 206, Wende Rd., Shangshan Tsuen, Chiung Lin Hsiang, Hsin
Chu Hsien 307, Taiwan R.O.C.



This report is for your exclusive use. Any copying or replication of this report to or for any other person or entity, or use of our name or trademark, is permitted only with our prior written permission. This report sets forth our findings solely with respect to the test samples identified herein. The results set forth in this report are not indicative or representative of the quality or characteristics of the lot from which a test sample was taken or any similar or identical product unless specifically and expressly noted. Our report includes all of the tests requested by you and the results thereof based upon the information that you provided to us. You have 60 days from date of issuance of this report to notify us of any material error or omission caused by our negligence, provided, however, that such notice shall be in writing and shall specifically address the issue you wish to raise. A failure to raise such issue within the prescribed time shall constitute your unqualified acceptance of the completeness of this report, the tests conducted and the correctness of the report contents. Unless specific mention, the uncertainty of measurement has been explicitly taken into account to declare the compliance or non-compliance to the specification. The report must not be used by the client to claim product certification, approval, or endorsement by TAF or any government agencies.

Table of Contents

Release Control Record	4
1 Certificate of Conformity	5
2 Summary of Test Results	6
2.1 Measurement Uncertainty	6
2.2 Modification Record	6
3 General Information	7
3.1 General Description of EUT	7
3.2 Description of Test Modes	10
3.2.1 Test Mode Applicability and Tested Channel Detail	11
3.3 Duty Cycle of Test Signal	13
3.4 Description of Support Units	14
3.4.1 Configuration of System under Test	15
3.5 General Description of Applied Standard	18
4 Test Types and Results	19
4.1 Radiated Emission and Bandedge Measurement	19
4.1.1 Limits of Radiated Emission and Bandedge Measurement	19
4.1.2 Test Instruments	20
4.1.3 Test Procedure	21
4.1.4 Deviation from Test Standard	21
4.1.5 Test Setup	22
4.1.6 EUT Operating Condition	23
4.1.7 Test Results	24
4.2 Conducted Emission Measurement	43
4.2.1 Limits of Conducted Emission Measurement	43
4.2.2 Test Instruments	43
4.2.3 Test Procedure	44
4.2.4 Deviation from Test Standard	44
4.2.5 Test Setup	44
4.2.6 EUT Operating Condition	44
4.2.7 Test Results (Mode 1)	45
4.2.8 Test Results (Mode 2)	47
4.3 Transmit Power Measurement	49
4.3.1 Limits of Transmit Power Measurement	49
4.3.2 Test Setup	49
4.3.3 Test Instruments	49
4.3.4 Test Procedure	49
4.3.5 Deviation from Test Standard	50
4.3.6 EUT Operating Condition	50
4.3.7 Test Result	51
4.4 Occupied Bandwidth Measurement	53
4.4.1 Test Setup	53
4.4.2 Test Instruments	53
4.4.3 Test Procedure	53
4.4.4 Test Results	54
4.5 Peak Power Spectral Density Measurement	60
4.5.1 Limits of Peak Power Spectral Density Measurement	60
4.5.2 Test Setup	60
4.5.3 Test Instruments	60
4.5.4 Test Procedure	61
4.5.5 Deviation from Test Standard	61
4.5.6 EUT Operating Condition	61
4.5.7 Test Results	62
4.6 Frequency Stability Measurement	68

4.6.1	Limits of Frequency Stability Measurement	68
4.6.2	Test Setup.....	68
4.6.3	Test Instruments	68
4.6.4	Test Procedure	68
4.6.5	Deviation from Test Standard	69
4.6.6	EUT Operating Condition	69
4.6.7	Test Results	70
4.7	6dB Bandwidth Measurement	71
4.7.1	Limits of 6dB Bandwidth Measurement.....	71
4.7.2	Test Setup.....	71
4.7.3	Test Instruments	71
4.7.4	Test Procedure	71
4.7.5	Deviation from Test Standard	71
4.7.6	EUT Operating Condition	71
4.7.7	Test Results	72
5	Pictures of Test Arrangements.....	74
	Annex A- Radiated Out of Band Emission (OOBE) Measurement (For U-NII-3 band)	75
	Appendix – Information on the Testing Laboratories	79

Release Control Record

Issue No.	Description	Date Issued
RF160728C11-1	Original release.	Dec. 07, 2016

1 Certificate of Conformity

Product: Business Dual-band Wireless-AC Access Point

Brand: ASUS

Test Model: BAP-AC1750

Sample Status: ENGINEERING SAMPLE

Applicant: ASUSTek COMPUTER INC.

Test Date: Oct. 02 to Nov. 09, 2016

Standard: 47 CFR FCC Part 15, Subpart E (Section 15.407)
ANSI C63.10: 2013

The above equipment has been tested by **Bureau Veritas Consumer Products Services (H.K.) Ltd., Taoyuan Branch**, and found compliance with the requirement of the above standards. The test record, data evaluation & Equipment Under Test (EUT) configurations represented herein are true and accurate accounts of the measurements of the sample's EMC characteristics under the conditions specified in this report.

Prepared by : Wendy Wu , **Date:** Dec. 07, 2016
Wendy Wu / Specialist

Approved by : May Chen , **Date:** Dec. 07, 2016
May Chen / Manager

2 Summary of Test Results

47 CFR FCC Part 15, Subpart E (Section 15.407)			
FCC Clause	Test Item	Result	Remarks
15.407(b)(6)	AC Power Conducted Emissions	Pass	Meet the requirement of limit. Minimum passing margin is -6.01dB at 0.42344MHz.
15.407(b) (1/2/3/4(i/ii)/6)	Radiated Emissions & Band Edge Measurement*	Pass	Meet the requirement of limit. Minimum passing margin is -1.1dB at 5150.00MHz, 5649.80MHz.
15.407(a)(1/2/3)	Max Average Transmit Power	Pass	Meet the requirement of limit.
---	Occupied Bandwidth Measurement	-	Reference only.
15.407(a)(1/2/3)	Peak Power Spectral Density	Pass	Meet the requirement of limit.
15.407(e)	6dB bandwidth	Pass	Meet the requirement of limit. (U-NII-3 Band only)
15.407(g)	Frequency Stability	Pass	Meet the requirement of limit.
15.203	Antenna Requirement	Pass	Antenna connector is i-pex(MHF)not a standard connector.

*For U-NII-3 band compliance with rule part 15.407(b)(4)(i), the OOB test plots were recorded in Annex A.

2.1 Measurement Uncertainty

Where relevant, the following measurement uncertainty levels have been estimated for tests performed on the EUT as specified in CISPR 16-4-2:

Measurement	Frequency	Expanded Uncertainty (k=2) (±)
Conducted Emissions at mains ports	150kHz ~ 30MHz	1.83 dB
Radiated Emissions up to 1 GHz	30MHz ~ 1GHz	5.36 dB
Radiated Emissions above 1 GHz	1GHz ~ 6GHz	3.47 dB
	6GHz ~ 18GHz	3.75 dB
	18GHz ~ 40GHz	3.30 dB

2.2 Modification Record

There were no modifications required for compliance.

3 General Information

3.1 General Description of EUT

Product	Business Dual-band Wireless-AC Access Point
Brand	ASUS
Test Model	BAP-AC1750
Status of EUT	ENGINEERING SAMPLE
Power Supply Rating	DC 12V from power adapter or DC 56V from POE
Modulation Type	CCK, DQPSK, DBPSK for DSSS 64QAM, 16QAM, QPSK, BPSK for OFDM 256QAM for OFDM in 11ac mode only
Modulation Technology	DSSS, OFDM
Transfer Rate	802.11b: up to 11Mbps 802.11a/g: up to 54Mbps 802.11n: up to 450Mbps 802.11ac: up to 1300Mbps
Operating Frequency	2.4GHz: 2.412 ~ 2.462GHz 5GHz: 5.18 ~ 5.24GHz, 5.745 ~ 5.825GHz
Number of Channel	2.4GHz: 802.11b, 802.11g, 802.11n (HT20), VHT20: 11 802.11n (HT40), VHT40: 7 5GHz: 802.11a, 802.11n (HT20), 802.11ac (VHT20): 9 802.11n (HT40), 802.11ac (VHT40): 4 802.11ac (VHT80): 2
Output Power	2.4GHz: 993.877mW 5GHz: 5.18GHz ~ 5.24GHz: 657.486mW 5.745GHz ~ 5.825GHz: 637.99mW
Antenna Type	Refer to Note
Antenna Connector	Refer to Note
Accessory Device	Adapter x 1
Data Cable Supplied	NA

Note:

1. Simultaneously transmission condition.

Condition	Technology	
	1	WLAN (2.4GHz)

Note: The emission of the simultaneous operation has been evaluated and no non-compliance was found.

2. The antenna provided to the EUT, please refer to the following table:

2.4GHz Band						
Antenna No	Brand	Model	Antenna Gain (dBi) <Including cable loss>	Frequency range (GHz)	Antenna Type	Connector Type
Chain (0)	Adant	STAR-X3	4	2.4~2.4835	monopole	i-pex(MHF)
Chain (1)	Adant	STAR-X3	4	2.4~2.4835	monopole	i-pex(MHF)
Chain (2)	Adant	STAR-X3	4	2.4~2.4835	monopole	i-pex(MHF)
5GHz Band						
Antenna No	Brand	Model	Antenna Gain (dBi) <Including cable loss>	Frequency range (GHz)	Antenna Type	Connector Type
Chain (0)	Adant	STAR-X3	6	5.15~5.85	monopole	i-pex(MHF)
Chain (1)	Adant	STAR-X3	6	5.15~5.85	monopole	i-pex(MHF)
Chain (2)	Adant	STAR-X3	6	5.15~5.85	monopole	i-pex(MHF)

3. The EUT must be supplied with a PoE or power adapter and following below table:

Adapter		
Brand	Model No.	Spec.
Asian Power Devices Inc.	WA-24Q12R	Input: 100-240V~ 50-60Hz, 0.7A Max Output: 12V/ 2A DC output cable (unshielded, 1.5m)
POE (test only not sale together)		
Brand	Model No.	Spec.
CARRIER	G0545-560-060-PSE1000	Input: 100-240V~1A MAX 50/60Hz Output: 56V/ 0.6A +(4,5)pins,-(7,8)pins

4. The EUT has been pre-tested under following test modes:

Pre-test Mode	Power
Mode A	Power from POE
Mode B	Power from adapter

From the above modes, the worst spurious emission was found in **Mode A**. Therefore only the test data of the modes were recorded in this report.

5. The EUT incorporates a MIMO function.

2.4GHz Band			
MODULATION MODE	DATA RATE (MCS)	TX & RX CONFIGURATION	
802.11b	1 ~ 11Mbps	3TX	3RX
802.11g	6 ~ 54Mbps	3TX	3RX
802.11n (HT20)	MCS 0~7	3TX	3RX
	MCS 8~15	3TX	3RX
	MCS 16~23	3TX	3RX
802.11n (HT40)	MCS 0~7	3TX	3RX
	MCS 8~15	3TX	3RX
	MCS 16~23	3TX	3RX
5GHz Band			
MODULATION MODE	DATA RATE (MCS)	TX & RX CONFIGURATION	
802.11a	6 ~ 54Mbps	3TX	3RX
802.11n (HT20)	MCS 0~7	3TX	3RX
	MCS 8~15	3TX	3RX
	MCS 16~23	3TX	3RX
802.11n (HT40)	MCS 0~7	3TX	3RX
	MCS 8~15	3TX	3RX
	MCS 16~23	3TX	3RX
802.11ac (VHT20)	MCS 0~8, Nss=1	3TX	3RX
	MCS 0~8, Nss=2	3TX	3RX
	MCS0~9 Nss=3	3TX	3RX
802.11ac (VHT40)	MCS 0~9, Nss=1	3TX	3RX
	MCS 0~9, Nss=2	3TX	3RX
	MCS0~9 Nss=3	3TX	3RX
802.11ac (VHT80)	MCS 0~9, Nss=1	3TX	3RX
	MCS 0~9, Nss=2	3TX	3RX
	MCS0~9 Nss=3	3TX	3RX

Note:

1. The modulation and bandwidth are similar for 802.11n mode for 20MHz (40MHz) and 802.11ac mode for 20MHz (40MHz), therefore investigated worst case to representative mode in test report. (Final test mode refer section 3.2.1)

6. The above EUT information is declared by manufacturer and for more detailed features description, please refer to the manufacturer's specifications or user's manual.

3.2 Description of Test Modes

FOR 5180 ~ 5240MHz

4 channels are provided for 802.11a, 802.11n (HT20), 802.11ac (VHT20):

Channel	Frequency	Channel	Frequency
36	5180MHz	44	5220MHz
40	5200MHz	48	5240MHz

2 channels are provided for 802.11n (HT40), 802.11ac (VHT40):

Channel	Frequency	Channel	Frequency
38	5190MHz	46	5230MHz

1 channel is provided for 802.11ac (VHT80):

Channel	Frequency
42	5210MHz

FOR 5745 ~ 5825MHz:

5 channels are provided for 802.11a, 802.11n (HT20), 802.11ac (VHT20):

Channel	Frequency	Channel	Frequency
149	5745MHz	161	5805MHz
153	5765MHz	165	5825MHz
157	5785MHz		

2 channels are provided for 802.11n (HT40), 802.11ac (VHT40):

Channel	Frequency	Channel	Frequency
151	5755MHz	159	5795MHz

1 channel is provided for 802.11ac (VHT80):

Channel	Frequency
155	5775MHz

3.2.1 Test Mode Applicability and Tested Channel Detail

EUT Configure Mode	Applicable To				Description
	RE \geq 1G	RE<1G	PLC	APCM	
1	√	√	√	√	Power from POE
2	-	-	√	-	Power from adapter

Where **RE \geq 1G**: Radiated Emission above 1GHz **RE<1G**: Radiated Emission below 1GHz
PLC: Power Line Conducted Emission **APCM**: Antenna Port Conducted Measurement

NOTE:

1. The EUT had been pre-tested on the positioned of each 2 axis. The worst case was found when positioned on **X-plane**.
2. "-" means no effect.

Radiated Emission Test (Above 1GHz):

- Pre-Scan has been conducted to determine the worst-case mode from all possible combinations between available modulations, data rates and antenna ports (if EUT with antenna diversity architecture).
- Following channel(s) was (were) selected for the final test as listed below.

Mode	FREQ. Band (MHz)	Available Channel	Tested Channel	Modulation Technology	Modulation Type	Data Rate (Mbps)
802.11a	5180-5240	36 to 48	36, 40, 48	OFDM	BPSK	6
802.11ac (VHT20)		36 to 48	36, 40, 48	OFDM	BPSK	6.5
802.11ac (VHT40)		38 to 46	38, 46	OFDM	BPSK	13.5
802.11ac (VHT80)		42	42	OFDM	BPSK	29.3
802.11a	5745-5825	149 to 165	149, 157, 165	OFDM	BPSK	6
802.11ac (VHT20)		149 to 165	149, 157, 165	OFDM	BPSK	6.5
802.11ac (VHT40)		151 to 159	151, 159	OFDM	BPSK	13.5
802.11ac (VHT80)		155	155	OFDM	BPSK	29.3

Radiated Emission Test (Below 1GHz):

- Pre-Scan has been conducted to determine the worst-case mode from all possible combinations between available modulations, data rates and antenna ports (if EUT with antenna diversity architecture).
- Following channel(s) was (were) selected for the final test as listed below.

Mode	FREQ. Band (MHz)	Available Channel	Tested Channel	Modulation Technology	Modulation Type	Data Rate (Mbps)
802.11ac (VHT40)	5180-5240	38 to 46	46	OFDM	BPSK	13.5

Power Line Conducted Emission Test:

- Pre-Scan has been conducted to determine the worst-case mode from all possible combinations between available modulations, data rates and antenna ports (if EUT with antenna diversity architecture).
- Following channel(s) was (were) selected for the final test as listed below.

Mode	FREQ. Band (MHz)	Available Channel	Tested Channel	Modulation Technology	Modulation Type	Data Rate (Mbps)
802.11ac (VHT40)	5180-5240	38 to 46	46	OFDM	BPSK	13.5

Antenna Port Conducted Measurement:

- This item includes all test value of each mode, but only includes spectrum plot of worst value of each mode.
- Pre-Scan has been conducted to determine the worst-case mode from all possible combinations between available modulations, data rates and antenna ports (if EUT with antenna diversity architecture).
- Following channel(s) was (were) selected for the final test as listed below.

Mode	FREQ. Band (MHz)	Available Channel	Tested Channel	Modulation Technology	Modulation Type	Data Rate (Mbps)
802.11a	5180-5240	36 to 48	36, 40, 48	OFDM	BPSK	6
802.11ac (VHT20)		36 to 48	36, 40, 48	OFDM	BPSK	6.5
802.11ac (VHT40)		38 to 46	38, 46	OFDM	BPSK	13.5
802.11ac (VHT80)		42	42	OFDM	BPSK	29.3
802.11a	5745-5825	149 to 165	149, 157, 165	OFDM	BPSK	6
802.11ac (VHT20)		149 to 165	149, 157, 165	OFDM	BPSK	6.5
802.11ac (VHT40)		151 to 159	151, 159	OFDM	BPSK	13.5
802.11ac (VHT80)		155	155	OFDM	BPSK	29.3

Test Condition:

Applicable To	Environmental Conditions	Input Power	Tested By
RE \geq 1G	22deg. C, 65%RH	120Vac, 60Hz	Robert Cheng
RE<1G	22deg. C, 65%RH	120Vac, 60Hz	Robert Cheng
PLC	26deg. C, 62%RH	120Vac, 60Hz	Eagle Chen
APCM	25deg. C, 60%RH	120Vac, 60Hz	Gary Cheng

3.3 Duty Cycle of Test Signal

Duty cycle of test signal is < 98 %, duty factor shall be considered.

802.11a: Duty cycle = 2.027 ms/2.105 ms = 0.963, Duty factor = $10 * \log(1/0.963) = 0.16$

802.11ac (VHT20): Duty cycle = 1.899 ms/1.975 ms = 0.962, Duty factor = $10 * \log(1/0.962) = 0.17$

802.11ac (VHT40): Duty cycle = 0.935 ms/1.009 ms = 0.927, Duty factor = $10 * \log(1/0.927) = 0.33$

802.11ac (VHT80): Duty cycle = 1.135 ms/1.208 ms = 0.94, Duty factor = $10 * \log(1/0.94) = 0.27$

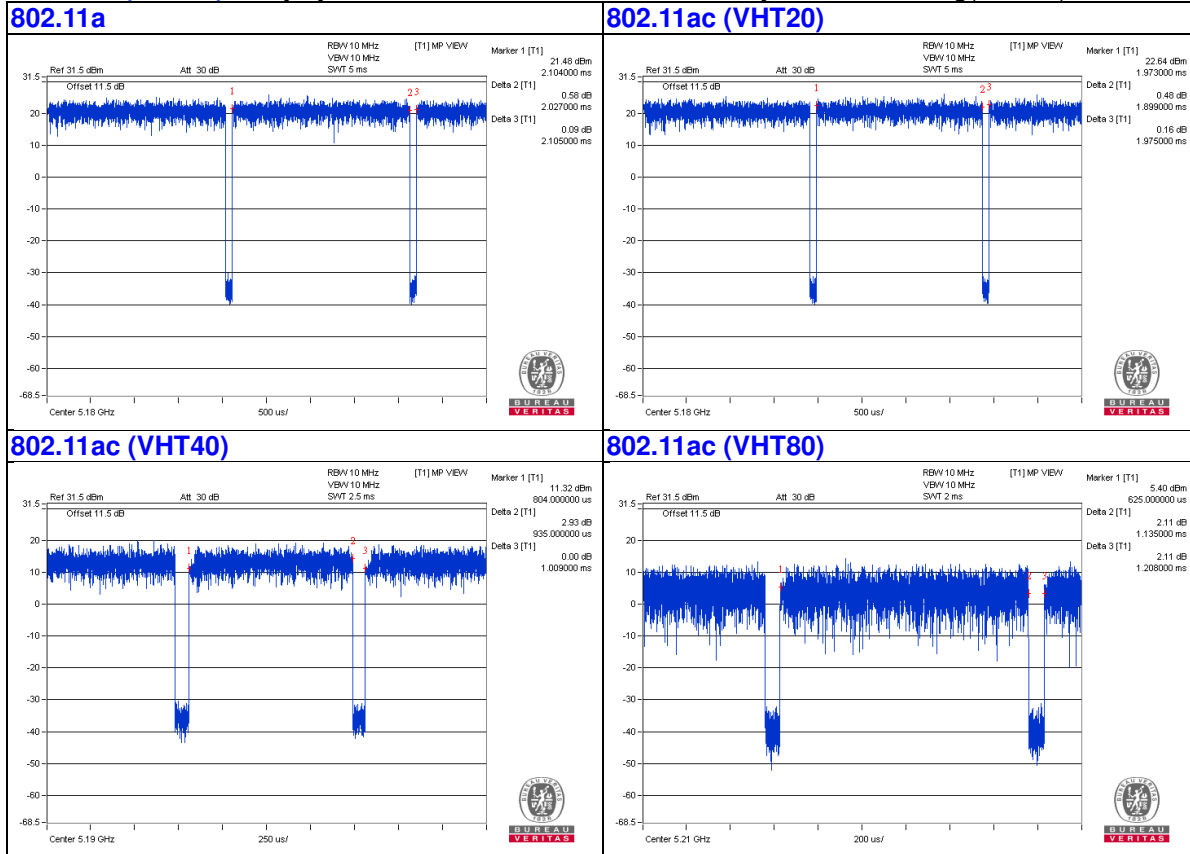

3.4 Description of Support Units

The EUT has been tested as an independent unit together with other necessary accessories or support units. The following support units or accessories were used to form a representative test configuration during the tests.

ID	Product	Brand	Model No.	Serial No.	FCC ID	Remarks
A.	Laptop	DELL	E5430	HYV4VY1	FCC DoC	Provided by Lab
B.	POE	CARRIER	G0845-560-060-PSE1000	NA	NA	Supplied by client
C.	HUB	ZyXEL	ES-116P	S060H02000215	FCC DoC	Provided by Lab
D.	iPod	Apple	MC749TA/A	CC4DMFJUDFDM	NA	Provided by Lab

Note:

1. All power cords of the above support units are non-shielded (1.8m).

ID	Descriptions	Qty.	Length (m)	Shielding (Yes/No)	Cores (Qty.)	Remarks
1.	RJ-45 Cable	1	10	No	0	Provided by Lab
2.	DC Cable	1	1.5	No	0	Supplied by client
3.	RJ-45 Cable	1	1	No	0	Provided by Lab
4.	RJ-45 Cable	1	10	No	0	Provided by Lab
5.	USB Cable	1	0.1	Yes	0	Provided by Lab

3.4.1 Configuration of System under Test

POE Mode (for Conducted Emission test):

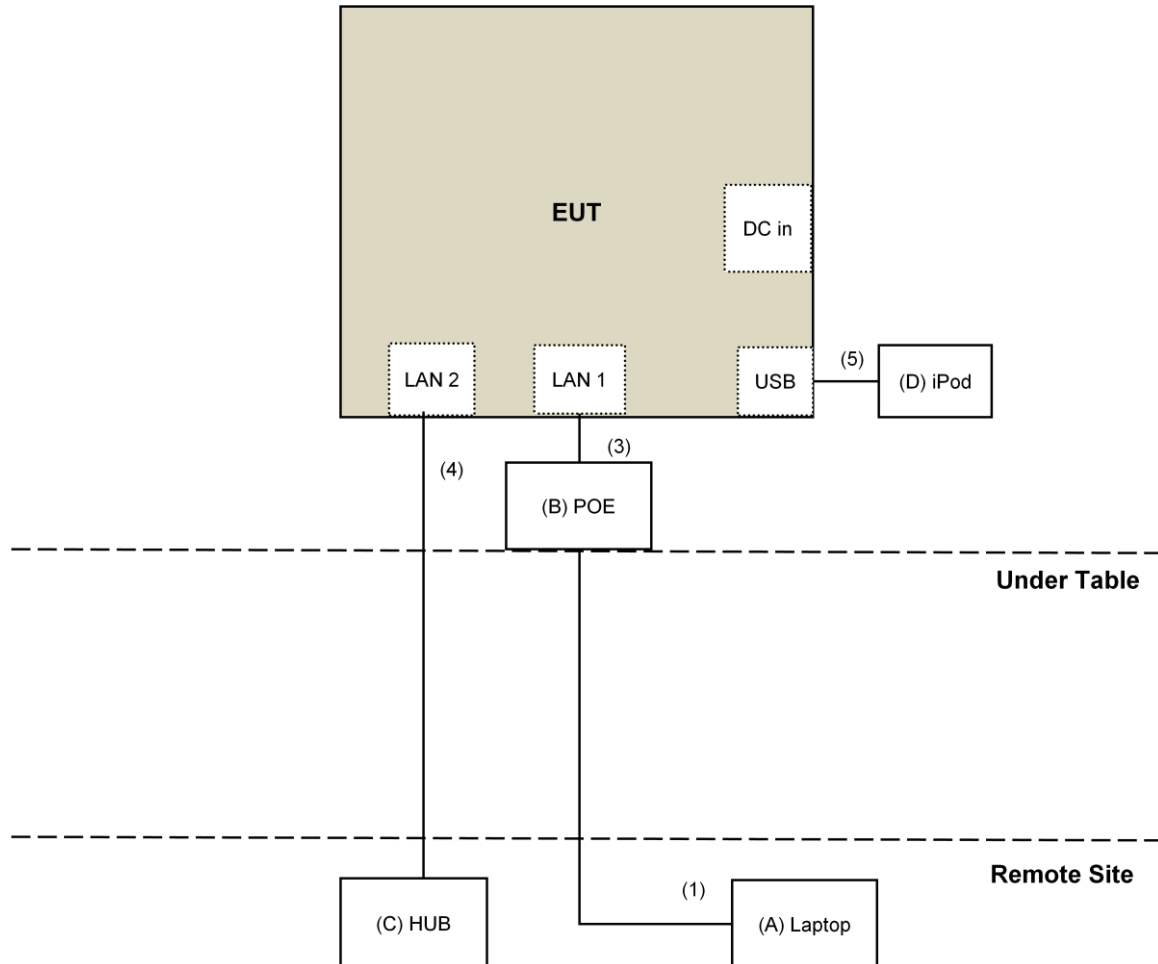

POE Mode (for other test):

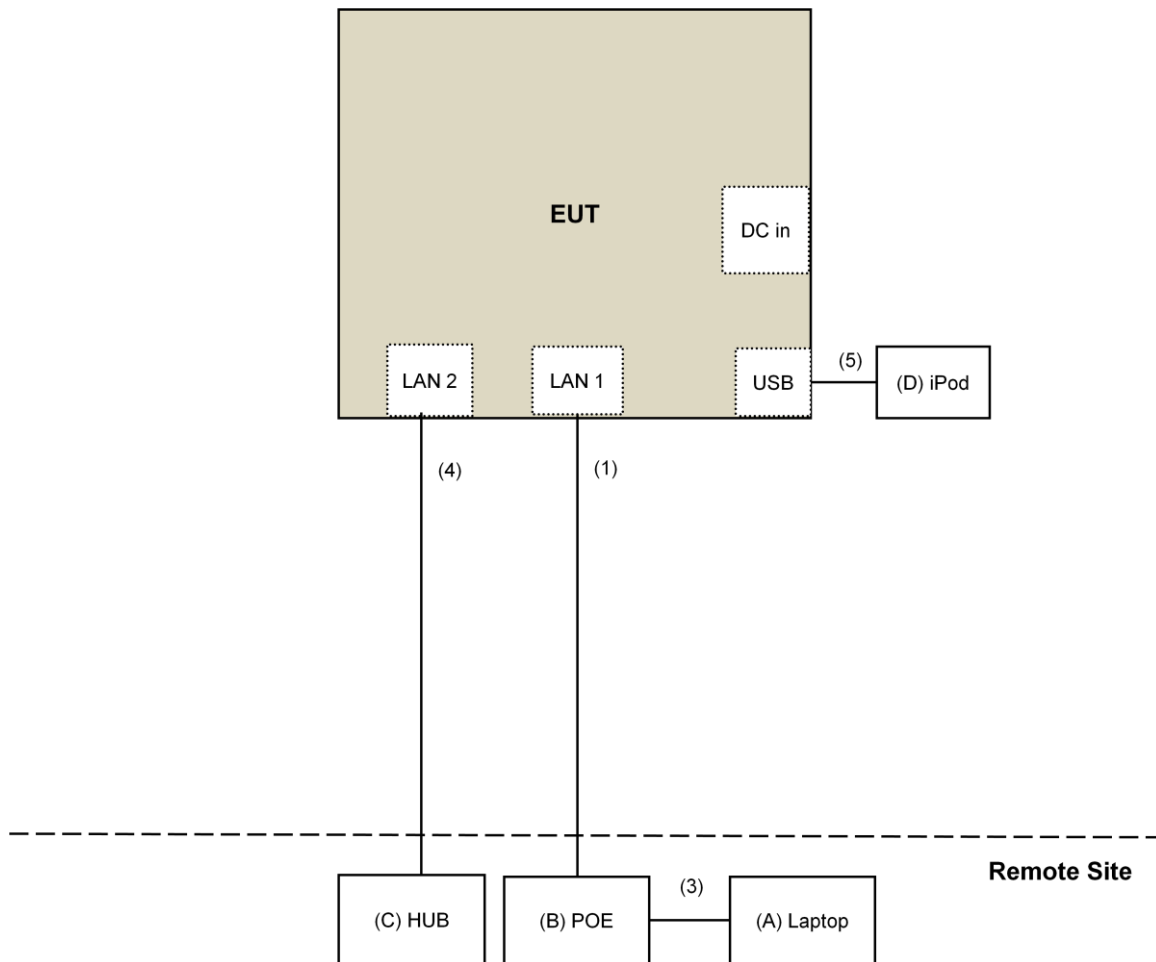

Adapter Mode:

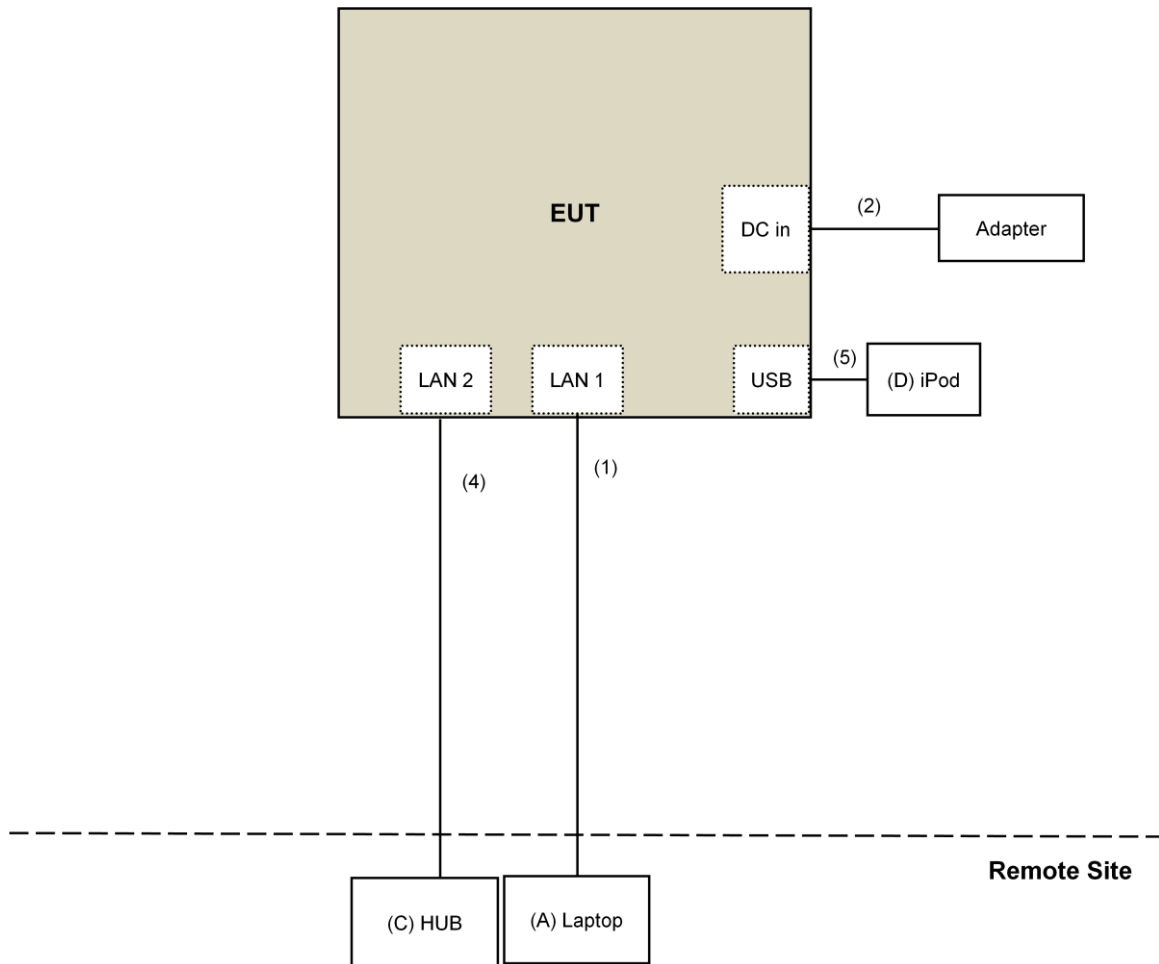

3.5 General Description of Applied Standard

The EUT is a RF Product. According to the specifications of the manufacturer, it must comply with the requirements of the following standards:

FCC Part 15, Subpart E (15.407)
KDB 789033 D02 General UNII Test Procedure New Rules v01r03
KDB 662911 D01 Multiple Transmitter Output v02r01
ANSI C63.10-2013

All test items have been performed and recorded as per the above standards.

NOTE: The EUT has been verified to comply with the requirements of FCC Part 15, Subpart B, Class B (DoC). The test report has been issued separately.

4 Test Types and Results

4.1 Radiated Emission and Bandedge Measurement

4.1.1 Limits of Radiated Emission and Bandedge Measurement

Radiated emissions which fall in the restricted bands must comply with the radiated emission limits specified as below table.

Frequencies (MHz)	Field Strength (microvolts/meter)	Measurement Distance (meters)
0.009 ~ 0.490	2400/F(kHz)	300
0.490 ~ 1.705	24000/F(kHz)	30
1.705 ~ 30.0	30	30
30 ~ 88	100	3
88 ~ 216	150	3
216 ~ 960	200	3
Above 960	500	3

NOTE:

1. The lower limit shall apply at the transition frequencies.
2. Emission level (dBuV/m) = 20 log Emission level (uV/m).
3. For frequencies above 1000MHz, the field strength limits are based on average detector, however, the peak field strength of any emission shall not exceed the maximum permitted average limits, specified above by more than 20dB under any condition of modulation.

Limits of unwanted emission out of the restricted bands

Applicable To		Limit	
789033 D02 General UNII Test Procedure New Rules v01r03		Field Strength at 3m	
		PK:74 (dBμV/m)	AV:54 (dBμV/m)
Frequency Band	Applicable To	EIRP Limit	Equivalent Field Strength at 3m
5150~5250 MHz	15.407(b)(1)	PK:-27 (dBm/MHz)	PK:68.2(dBμV/m)
5250~5350 MHz	15.407(b)(2)		
5470~5725 MHz	15.407(b)(3)		
5725~5850 MHz	<input checked="" type="checkbox"/> 15.407(b)(4)(i)	PK:-27 (dBm/MHz) ^{*1} PK:10 (dBm/MHz) ^{*2} PK:15.6 (dBm/MHz) ^{*3} PK:27 (dBm/MHz) ^{*4}	PK: 68.2(dBμV/m) ^{*1} PK:105.2 (dBμV/m) ^{*2} PK: 110.8(dBμV/m) ^{*3} PK:122.2 (dBμV/m) ^{*4}
	<input type="checkbox"/> 15.407(b)(4)(ii)	Emission limits in section 15.247(d)	
^{*1} beyond 75 MHz or more above of the band edge.		^{*2} below the band edge increasing linearly to 10 dBm/MHz at 25 MHz above.	
^{*3} below the band edge increasing linearly to a level of 15.6 dBm/MHz at 5 MHz above.		^{*4} from 5 MHz above or below the band edge increasing linearly to a level of 27 dBm/MHz at the band edge.	

Note:

The following formula is used to convert the equipment isotropic radiated power (eirp) to field strength:

$$E = \frac{1000000\sqrt{30P}}{3} \mu\text{V/m, where P is the eirp (Watts).}$$

4.1.2 Test Instruments

DESCRIPTION & MANUFACTURER	MODEL NO.	SERIAL NO.	CALIBRATED DATE	CALIBRATED UNTIL
Test Receiver Agilent	N9038A	MY50010156	Aug. 18, 2016	Aug. 17, 2017
Pre-Amplifier ^(*) EMCI	EMC001340	980142	Jan. 20, 2016	Jan. 19, 2018
Loop Antenna ^(*) Electro-Metrics	EM-6879	264	Dec. 16, 2014	Dec. 15, 2016
RF Cable	NA	LOOPCAB-001 LOOPCAB-002	Jan. 18, 2016	Jan. 17, 2017
Pre-Amplifier Mini-Circuits	ZFL-1000VH2B	AMP-ZFL-05	May 07, 2016	May 06, 2017
Trilog Broadband Antenna SCHWARZBECK	VULB 9168	9168-156	Jan. 04, 2016	Jan. 03, 2017
RF Cable	8D	966-3-1 966-3-2 966-3-3	Apr. 02, 2016	Apr. 01, 2017
Horn_Antenna SCHWARZBECK	BBHA9120-D	9120D-406	Jan. 20, 2016	Jan. 19, 2017
Pre-Amplifier Agilent	8449B	3008A02465	Apr. 05, 2016	Apr. 04, 2017
RF Cable	EMC104-SM-SM-2000 EMC104-SM-SM-5000 EMC104-SM-SM-5000	150317 150321 150322	Mar. 30, 2016	Mar. 29, 2017
Spectrum Analyzer Keysight	N9030A	MY54490520	July 29, 2016	July 28, 2017
Pre-Amplifier EMCI	EMC184045	980143	Jan. 15, 2016	Jan. 14, 2017
Horn_Antenna SCHWARZBECK	BBHA 9170	BBHA9170608	Jan. 08, 2016	Jan. 07, 2017
RF Cable	SUCOFLEX 102	36432/2 36441/2	Jan. 16, 2016	Jan. 15, 2017
Software	ADT_Radiated_V8.7.08	NA	NA	NA
Antenna Tower & Turn Table Max-Full	MF-7802	MF780208406	NA	NA
Boresight Antenna Fixture	FBA-01	FBA-SIP01	NA	NA

Note:

1. The calibration interval of the above test instruments is 12 months and the calibrations are traceable to NML/ROC and NIST/USA.
2. *The calibration interval of the above test instruments is 24 months and the calibrations are traceable to NML/ROC and NIST/USA.
3. The test was performed in 966 Chamber No. 3.
4. The FCC Site Registration No. is 147459
5. Loop antenna was used for all emissions below 30 MHz.
6. The CANADA Site Registration No. is 20331-1
7. Tested Date: Oct. 02, 2016

4.1.3 Test Procedure

For Radiated emission below 30MHz

- a. The EUT was placed on the top of a rotating table 0.8 meters above the ground at a 3 meter chamber room. The table was rotated 360 degrees to determine the position of the highest radiation.
- b. The EUT was set 3 meters away from the interference-receiving antenna, which was mounted on the top of a variable-height antenna tower.
- c. Both X and Y axes of the antenna are set to make the measurement.
- d. For each suspected emission, the EUT was arranged to its worst case and the rotatable table was turned from 0 degrees to 360 degrees to find the maximum reading.
- e. The test-receiver system was set to Quasi-Peak Detect Function and Specified Bandwidth with Maximum Hold Mode.

NOTE:

1. The resolution bandwidth and video bandwidth of test receiver/spectrum analyzer is 9kHz at frequency below 30MHz.

For Radiated emission above 30MHz

- a. The EUT was placed on the top of a rotating table 0.8 meters (for 30MHz ~ 1GHz) / 1.5 meters (for above 1GHz) above the ground at 3 meter chamber room for test. The table was rotated 360 degrees to determine the position of the highest radiation.
- b. The EUT was set 3 meters away from the interference-receiving antenna, which was mounted on the top of a variable-height antenna tower.
- c. The height of antenna is varied from one meter to four meters above the ground to determine the maximum value of the field strength. Both horizontal and vertical polarizations of the antenna are set to make the measurement.
- d. For each suspected emission, the EUT was arranged to its worst case and then the antenna was tuned to heights from 1 meter to 4 meters and the rotatable table was turned from 0 degrees to 360 degrees to find the maximum reading.
- e. The test-receiver system was set to quasi-peak detect function and specified bandwidth with maximum hold mode when the test frequency is below 1 GHz.
- f. The test-receiver system was set to peak and average detect function and specified bandwidth with maximum hold mode when the test frequency is above 1 GHz. If the peak reading value also meets average limit, measurement with the average detector is unnecessary.

Note:

1. The resolution bandwidth and video bandwidth of test receiver/spectrum analyzer is 120kHz for Quasi-peak detection (QP) at frequency below 1GHz.
2. The resolution bandwidth of test receiver/spectrum analyzer is 1 MHz and the video bandwidth is 3 MHz for Peak detection (PK) at frequency above 1GHz.
3. The resolution bandwidth of test receiver/spectrum analyzer is 1MHz and the video bandwidth is $\geq 1/T$ (Duty cycle < 98%) or 10Hz (Duty cycle $\geq 98\%$) for Average detection (AV) at frequency above 1GHz.
4. All modes of operation were investigated and the worst-case emissions are reported.

4.1.4 Deviation from Test Standard

No deviation.

4.1.5 Test Setup

For Radiated emission below 30MHz

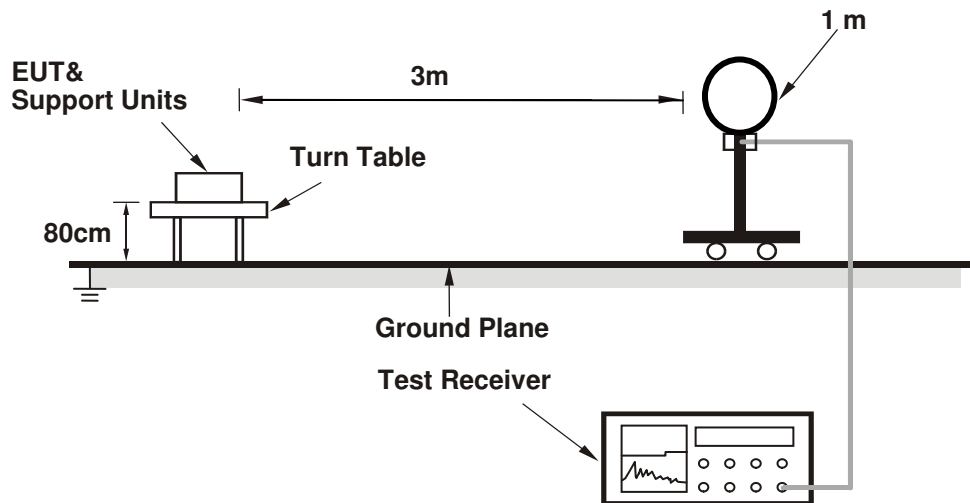

For Radiated emission 30MHz to 1GHz

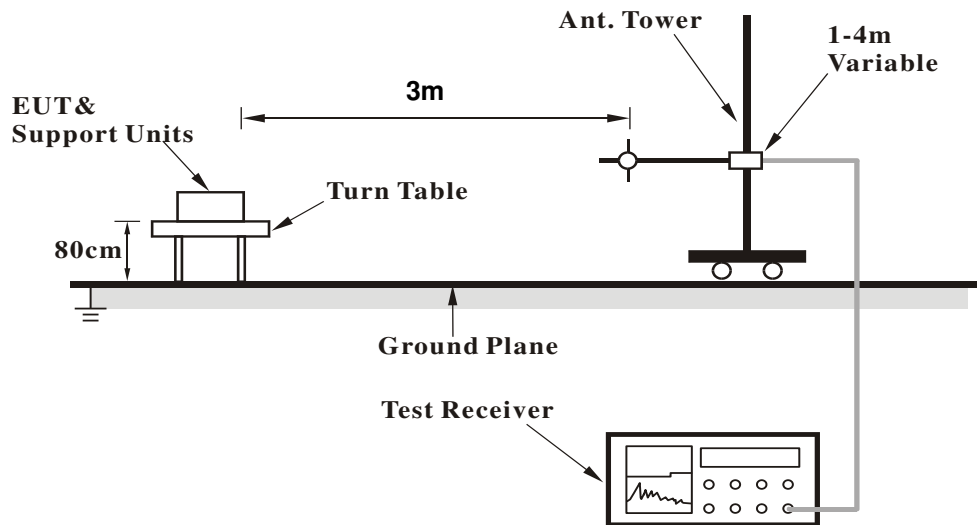

For Radiated emission above 1GHz

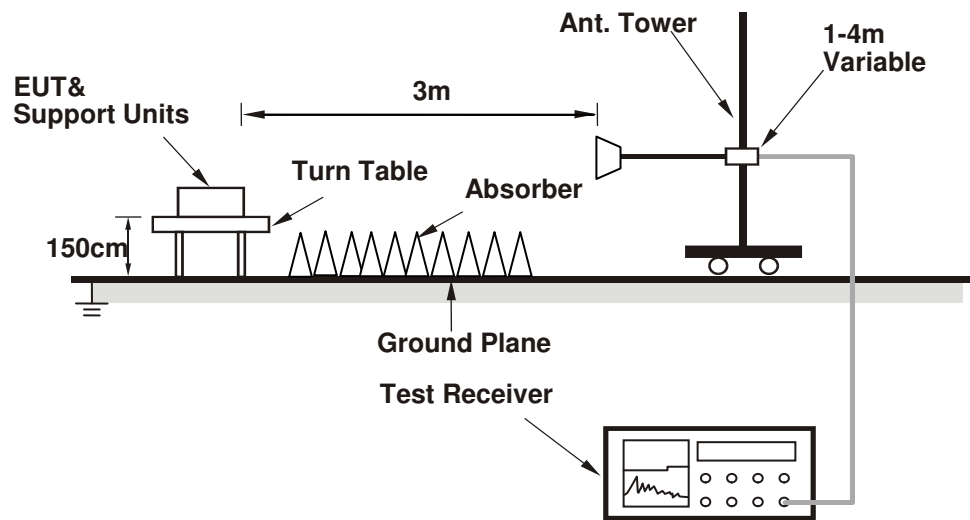

For the actual test configuration, please refer to the attached file (Test Setup Photo).

4.1.6 EUT Operating Condition

- a. Connected the EUT with the Laptop which is placed on remote site.
- b. Controlling software (artgui.exe[Ver 2.3]) has been activated to set the EUT on specific status.

4.1.7 Test Results

Above 1GHz Data:

802.11a

CHANNEL	TX Channel 36	DETECTOR FUNCTION	Peak (PK)
FREQUENCY RANGE	1GHz ~ 40GHz		Average (AV)

ANTENNA POLARITY & TEST DISTANCE: HORIZONTAL AT 3 M

NO.	FREQ. (MHz)	EMISSION LEVEL (dBuV/m)	LIMIT (dBuV/m)	MARGIN (dB)	ANTENNA HEIGHT (m)	TABLE ANGLE (Degree)	RAW VALUE (dBuV)	CORRECTION FACTOR (dB/m)
1	5150.00	48.1 PK	74.0	-25.9	3.73 H	308	45.1	3.0
2	5150.00	41.1 AV	54.0	-12.9	3.73 H	308	38.1	3.0
3	*5180.00	106.1 PK			3.73 H	308	103.0	3.1
4	*5180.00	94.3 AV			3.73 H	308	91.2	3.1
5	#10360.00	48.1 PK	74.0	-25.9	1.50 H	184	34.5	13.6
6	#10360.00	37.7 AV	54.0	-16.3	1.50 H	184	24.1	13.6
7	15540.00	50.2 PK	74.0	-23.8	1.70 H	128	34.5	15.7
8	15540.00	39.3 AV	54.0	-14.7	1.70 H	128	23.6	15.7

ANTENNA POLARITY & TEST DISTANCE: VERTICAL AT 3 M

NO.	FREQ. (MHz)	EMISSION LEVEL (dBuV/m)	LIMIT (dBuV/m)	MARGIN (dB)	ANTENNA HEIGHT (m)	TABLE ANGLE (Degree)	RAW VALUE (dBuV)	CORRECTION FACTOR (dB/m)
1	5150.00	64.6 PK	74.0	-9.4	2.26 V	318	61.6	3.0
2	5150.00	50.1 AV	54.0	-3.9	2.26 V	318	47.1	3.0
3	*5180.00	117.0 PK			2.26 V	318	113.9	3.1
4	*5180.00	104.9 AV			2.26 V	318	101.8	3.1
5	#10360.00	46.3 PK	74.0	-27.7	3.67 V	139	32.7	13.6
6	#10360.00	37.7 AV	54.0	-16.3	3.67 V	139	24.1	13.6
7	15540.00	59.3 PK	74.0	-14.7	3.50 V	266	43.6	15.7
8	15540.00	48.7 AV	54.0	-5.3	3.50 V	266	33.0	15.7

REMARKS:

1. Emission Level(dBuV/m) = Raw Value(dBuV) + Correction Factor(dB/m)
2. Correction Factor(dB/m) = Antenna Factor(dB/m) + Cable Factor(dB) – Pre-Amplifier Factor(dB)
3. The other emission levels were very low against the limit.
4. Margin value = Emission Level – Limit value
5. " * ": Fundamental frequency.
6. " # ": The radiated frequency is out of the restricted band.

CHANNEL	TX Channel 40	DETECTOR FUNCTION	Peak (PK)
FREQUENCY RANGE	1GHz ~ 40GHz		Average (AV)

ANTENNA POLARITY & TEST DISTANCE: HORIZONTAL AT 3 M

NO.	FREQ. (MHz)	EMISSION LEVEL (dBuV/m)	LIMIT (dBuV/m)	MARGIN (dB)	ANTENNA HEIGHT (m)	TABLE ANGLE (Degree)	RAW VALUE (dBuV)	CORRECTION FACTOR (dB/m)
1	5150.00	46.3 PK	74.0	-27.7	3.74 H	323	43.3	3.0
2	5150.00	40.1 AV	54.0	-13.9	3.74 H	323	37.1	3.0
3	*5200.00	105.7 PK			3.74 H	323	102.6	3.1
4	*5200.00	94.0 AV			3.74 H	323	90.9	3.1
5	#10400.00	48.2 PK	74.0	-25.8	1.55 H	174	34.6	13.6
6	#10400.00	38.0 AV	54.0	-16.0	1.55 H	174	24.4	13.6
7	15600.00	50.0 PK	74.0	-24.0	1.65 H	131	34.3	15.7
8	15600.00	39.3 AV	54.0	-14.7	1.65 H	131	23.6	15.7

ANTENNA POLARITY & TEST DISTANCE: VERTICAL AT 3 M

NO.	FREQ. (MHz)	EMISSION LEVEL (dBuV/m)	LIMIT (dBuV/m)	MARGIN (dB)	ANTENNA HEIGHT (m)	TABLE ANGLE (Degree)	RAW VALUE (dBuV)	CORRECTION FACTOR (dB/m)
1	5150.00	64.2 PK	74.0	-9.8	2.75 V	322	61.2	3.0
2	5150.00	47.4 AV	54.0	-6.6	2.75 V	322	44.4	3.0
3	*5200.00	117.2 PK			2.75 V	322	114.1	3.1
4	*5200.00	105.1 AV			2.75 V	322	102.0	3.1
5	#10400.00	46.0 PK	74.0	-28.0	3.68 V	150	32.4	13.6
6	#10400.00	37.6 AV	54.0	-16.4	3.68 V	150	24.0	13.6
7	15600.00	59.6 PK	74.0	-14.4	3.54 V	258	43.9	15.7
8	15600.00	49.0 AV	54.0	-5.0	3.54 V	258	33.3	15.7

REMARKS:

1. Emission Level(dBuV/m) = Raw Value(dBuV) + Correction Factor(dB/m)
2. Correction Factor(dB/m) = Antenna Factor(dB/m) + Cable Factor(dB) – Pre-Amplifier Factor(dB)
3. The other emission levels were very low against the limit.
4. Margin value = Emission Level – Limit value
5. " * ": Fundamental frequency.
6. " # ": The radiated frequency is out of the restricted band.

CHANNEL	TX Channel 48	DETECTOR FUNCTION	Peak (PK)
FREQUENCY RANGE	1GHz ~ 40GHz		Average (AV)

ANTENNA POLARITY & TEST DISTANCE: HORIZONTAL AT 3 M

NO.	FREQ. (MHz)	EMISSION LEVEL (dBuV/m)	LIMIT (dBuV/m)	MARGIN (dB)	ANTENNA HEIGHT (m)	TABLE ANGLE (Degree)	RAW VALUE (dBuV)	CORRECTION FACTOR (dB/m)
1	*5240.00	106.0 PK			3.75 H	314	102.8	3.2
2	*5240.00	94.4 AV			3.75 H	314	91.2	3.2
3	5350.00	51.2 PK	74.0	-22.8	3.75 H	314	47.7	3.5
4	5350.00	39.4 AV	54.0	-14.6	3.75 H	314	35.9	3.5
5	#10480.00	47.9 PK	74.0	-26.1	1.60 H	170	33.9	14.0
6	#10480.00	37.8 AV	54.0	-16.2	1.60 H	170	23.8	14.0
7	15720.00	50.4 PK	74.0	-23.6	1.68 H	144	35.0	15.4
8	15720.00	39.7 AV	54.0	-14.3	1.68 H	144	24.3	15.4

ANTENNA POLARITY & TEST DISTANCE: VERTICAL AT 3 M

NO.	FREQ. (MHz)	EMISSION LEVEL (dBuV/m)	LIMIT (dBuV/m)	MARGIN (dB)	ANTENNA HEIGHT (m)	TABLE ANGLE (Degree)	RAW VALUE (dBuV)	CORRECTION FACTOR (dB/m)
1	*5240.00	117.4 PK			3.81 V	309	114.2	3.2
2	*5240.00	105.1 AV			3.81 V	309	101.9	3.2
3	5350.00	59.1 PK	74.0	-14.9	3.81 V	309	55.6	3.5
4	5350.00	46.0 AV	54.0	-8.0	3.81 V	309	42.5	3.5
5	#10480.00	46.4 PK	74.0	-27.6	3.74 V	141	32.4	14.0
6	#10480.00	37.5 AV	54.0	-16.5	3.74 V	141	23.5	14.0
7	15720.00	59.7 PK	74.0	-14.3	2.97 V	265	44.3	15.4
8	15720.00	49.1 AV	54.0	-4.9	2.97 V	265	33.7	15.4

REMARKS:

1. Emission Level(dBuV/m) = Raw Value(dBuV) + Correction Factor(dB/m)
2. Correction Factor(dB/m) = Antenna Factor(dB/m) + Cable Factor(dB) – Pre-Amplifier Factor(dB)
3. The other emission levels were very low against the limit.
4. Margin value = Emission Level – Limit value
5. " * ": Fundamental frequency.
6. " # ": The radiated frequency is out of the restricted band.

CHANNEL	TX Channel 149	DETECTOR FUNCTION	Peak (PK)
FREQUENCY RANGE	1GHz ~ 40GHz		Average (AV)

ANTENNA POLARITY & TEST DISTANCE: HORIZONTAL AT 3 M

NO.	FREQ. (MHz)	EMISSION LEVEL (dBuV/m)	LIMIT (dBuV/m)	MARGIN (dB)	ANTENNA HEIGHT (m)	TABLE ANGLE (Degree)	RAW VALUE (dBuV)	CORRECTION FACTOR (dB/m)
1	#5559.02	59.6 PK	68.2	-8.6	3.45 H	299	55.7	3.9
2	*5745.00	112.9 PK			3.45 H	299	108.7	4.2
3	*5745.00	102.8 AV			3.45 H	299	98.6	4.2
4	#5999.82	58.8 PK	68.2	-9.4	3.45 H	299	54.3	4.5
5	11490.00	62.4 PK	74.0	-11.6	3.64 H	137	47.2	15.2
6	11490.00	50.0 AV	54.0	-4.0	3.64 H	137	34.8	15.2
7	#17235.00	56.1 PK	74.0	-17.9	1.61 H	149	36.1	20.0
8	#17235.00	44.0 AV	54.0	-10.0	1.61 H	149	24.0	20.0

ANTENNA POLARITY & TEST DISTANCE: VERTICAL AT 3 M

NO.	FREQ. (MHz)	EMISSION LEVEL (dBuV/m)	LIMIT (dBuV/m)	MARGIN (dB)	ANTENNA HEIGHT (m)	TABLE ANGLE (Degree)	RAW VALUE (dBuV)	CORRECTION FACTOR (dB/m)
1	#5580.87	61.9 PK	68.2	-6.3	2.85 V	102	58.0	3.9
2	*5745.00	119.7 PK			2.85 V	102	115.5	4.2
3	*5745.00	109.7 AV			2.85 V	102	105.5	4.2
4	#5930.48	59.6 PK	68.2	-8.6	2.85 V	102	55.2	4.4
5	11490.00	65.2 PK	74.0	-8.8	3.01 V	185	50.0	15.2
6	11490.00	51.9 AV	54.0	-2.1	3.01 V	185	36.7	15.2
7	#17235.00	58.3 PK	74.0	-15.7	2.77 V	140	38.3	20.0
8	#17235.00	46.0 AV	54.0	-8.0	2.77 V	140	26.0	20.0

REMARKS:

1. Emission Level(dBuV/m) = Raw Value(dBuV) + Correction Factor(dB/m)
2. Correction Factor(dB/m) = Antenna Factor(dB/m) + Cable Factor(dB) – Pre-Amplifier Factor(dB)
3. The other emission levels were very low against the limit.
4. Margin value = Emission Level – Limit value
5. " * ": Fundamental frequency.
6. " # ": The radiated frequency is out of the restricted band.

CHANNEL	TX Channel 157	DETECTOR FUNCTION	Peak (PK)
FREQUENCY RANGE	1GHz ~ 40GHz		Average (AV)

ANTENNA POLARITY & TEST DISTANCE: HORIZONTAL AT 3 M

NO.	FREQ. (MHz)	EMISSION LEVEL (dBuV/m)	LIMIT (dBuV/m)	MARGIN (dB)	ANTENNA HEIGHT (m)	TABLE ANGLE (Degree)	RAW VALUE (dBuV)	CORRECTION FACTOR (dB/m)
1	#5620.77	59.3 PK	68.2	-8.9	3.77 H	294	55.3	4.0
2	*5785.00	110.7 PK			3.77 H	294	106.6	4.1
3	*5785.00	100.5 AV			3.77 H	294	96.4	4.1
4	#5987.48	60.2 PK	68.2	-8.0	3.77 H	294	55.7	4.5
5	11570.00	62.3 PK	74.0	-11.7	3.68 H	137	47.2	15.1
6	11570.00	49.9 AV	54.0	-4.1	3.68 H	137	34.8	15.1
7	#17355.00	56.4 PK	74.0	-17.6	1.65 H	137	35.9	20.5
8	#17355.00	44.1 AV	54.0	-9.9	1.65 H	137	23.6	20.5

ANTENNA POLARITY & TEST DISTANCE: VERTICAL AT 3 M

NO.	FREQ. (MHz)	EMISSION LEVEL (dBuV/m)	LIMIT (dBuV/m)	MARGIN (dB)	ANTENNA HEIGHT (m)	TABLE ANGLE (Degree)	RAW VALUE (dBuV)	CORRECTION FACTOR (dB/m)
1	#5623.62	60.5 PK	68.2	-7.7	2.64 V	103	56.5	4.0
2	*5785.00	120.4 PK			2.64 V	103	116.3	4.1
3	*5785.00	109.0 AV			2.64 V	103	104.9	4.1
4	#5936.18	59.5 PK	68.2	-8.7	2.64 V	103	55.1	4.4
5	11570.00	66.2 PK	74.0	-7.8	2.93 V	170	51.1	15.1
6	11570.00	51.8 AV	54.0	-2.2	2.93 V	170	36.7	15.1
7	#17355.00	58.6 PK	74.0	-15.4	2.74 V	145	38.1	20.5
8	#17355.00	46.4 AV	54.0	-7.6	2.74 V	145	25.9	20.5

REMARKS:

1. Emission Level(dBuV/m) = Raw Value(dBuV) + Correction Factor(dB/m)
2. Correction Factor(dB/m) = Antenna Factor(dB/m) + Cable Factor(dB) – Pre-Amplifier Factor(dB)
3. The other emission levels were very low against the limit.
4. Margin value = Emission Level – Limit value
5. " * ": Fundamental frequency.
6. " # ": The radiated frequency is out of the restricted band.

CHANNEL	TX Channel 165	DETECTOR FUNCTION	Peak (PK)
FREQUENCY RANGE	1GHz ~ 40GHz		Average (AV)

ANTENNA POLARITY & TEST DISTANCE: HORIZONTAL AT 3 M

NO.	FREQ. (MHz)	EMISSION LEVEL (dBuV/m)	LIMIT (dBuV/m)	MARGIN (dB)	ANTENNA HEIGHT (m)	TABLE ANGLE (Degree)	RAW VALUE (dBuV)	CORRECTION FACTOR (dB/m)
1	#5596.07	59.5 PK	68.2	-8.7	3.67 H	295	55.6	3.9
2	*5825.00	110.6 PK			3.67 H	295	106.4	4.2
3	*5825.00	100.0 AV			3.67 H	295	95.8	4.2
4	#5971.32	59.1 PK	68.2	-9.1	3.67 H	295	54.6	4.5
5	11650.00	62.4 PK	74.0	-11.6	3.71 H	128	47.4	15.0
6	11650.00	49.8 AV	54.0	-4.2	3.71 H	128	34.8	15.0
7	#17475.00	56.4 PK	74.0	-17.6	1.61 H	152	35.3	21.1
8	#17475.00	44.3 AV	54.0	-9.7	1.61 H	152	23.2	21.1

ANTENNA POLARITY & TEST DISTANCE: VERTICAL AT 3 M

NO.	FREQ. (MHz)	EMISSION LEVEL (dBuV/m)	LIMIT (dBuV/m)	MARGIN (dB)	ANTENNA HEIGHT (m)	TABLE ANGLE (Degree)	RAW VALUE (dBuV)	CORRECTION FACTOR (dB/m)
1	#5619.35	59.9 PK	68.2	-8.3	2.54 V	110	55.9	4.0
2	*5825.00	119.1 PK			2.54 V	110	114.9	4.2
3	*5825.00	108.4 AV			2.54 V	110	104.2	4.2
4	#5976.07	59.6 PK	68.2	-8.6	2.54 V	110	55.1	4.5
5	11650.00	64.5 PK	74.0	-9.5	3.03 V	168	49.5	15.0
6	11650.00	51.6 AV	54.0	-2.4	3.03 V	168	36.6	15.0
7	#17475.00	58.1 PK	74.0	-15.9	2.72 V	132	37.0	21.1
8	#17475.00	46.0 AV	54.0	-8.0	2.72 V	132	24.9	21.1

REMARKS:

1. Emission Level(dBuV/m) = Raw Value(dBuV) + Correction Factor(dB/m)
2. Correction Factor(dB/m) = Antenna Factor(dB/m) + Cable Factor(dB) – Pre-Amplifier Factor(dB)
3. The other emission levels were very low against the limit.
4. Margin value = Emission Level – Limit value
5. " * ": Fundamental frequency.
6. " # ": The radiated frequency is out of the restricted band.

802.11ac (VHT20)

CHANNEL	TX Channel 36	DETECTOR FUNCTION	Peak (PK)
FREQUENCY RANGE	1GHz ~ 40GHz		Average (AV)

ANTENNA POLARITY & TEST DISTANCE: HORIZONTAL AT 3 M

NO.	FREQ. (MHz)	EMISSION LEVEL (dBuV/m)	LIMIT (dBuV/m)	MARGIN (dB)	ANTENNA HEIGHT (m)	TABLE ANGLE (Degree)	RAW VALUE (dBuV)	CORRECTION FACTOR (dB/m)
1	5150.00	50.7 PK	74.0	-23.3	3.78 H	318	47.7	3.0
2	5150.00	43.8 AV	54.0	-10.2	3.78 H	318	40.8	3.0
3	*5180.00	106.2 PK			3.78 H	318	103.1	3.1
4	*5180.00	94.8 AV			3.78 H	318	91.7	3.1
5	#10360.00	50.5 PK	74.0	-23.5	1.52 H	196	36.9	13.6
6	#10360.00	39.6 AV	54.0	-14.4	1.52 H	196	26.0	13.6
7	15540.00	48.8 PK	74.0	-25.2	1.64 H	133	33.1	15.7
8	15540.00	41.5 AV	54.0	-12.5	1.64 H	133	25.8	15.7

ANTENNA POLARITY & TEST DISTANCE: VERTICAL AT 3 M

NO.	FREQ. (MHz)	EMISSION LEVEL (dBuV/m)	LIMIT (dBuV/m)	MARGIN (dB)	ANTENNA HEIGHT (m)	TABLE ANGLE (Degree)	RAW VALUE (dBuV)	CORRECTION FACTOR (dB/m)
1	5150.00	64.5 PK	74.0	-9.5	2.22 V	105	61.5	3.0
2	5150.00	49.9 AV	54.0	-4.1	2.22 V	105	46.9	3.0
3	*5180.00	119.7 PK			2.22 V	105	116.6	3.1
4	*5180.00	109.0 AV			2.22 V	105	105.9	3.1
5	#10360.00	46.9 PK	74.0	-27.1	2.31 V	127	33.3	13.6
6	#10360.00	38.1 AV	54.0	-15.9	2.31 V	127	24.5	13.6
7	15540.00	59.0 PK	74.0	-15.0	2.93 V	271	43.3	15.7
8	15540.00	48.5 AV	54.0	-5.5	2.93 V	271	32.8	15.7

REMARKS:

- Emission Level(dBuV/m) = Raw Value(dBuV) + Correction Factor(dB/m)
- Correction Factor(dB/m) = Antenna Factor(dB/m) + Cable Factor(dB) – Pre-Amplifier Factor(dB)
- The other emission levels were very low against the limit.
- Margin value = Emission Level – Limit value
- " * ": Fundamental frequency.
- " # ": The radiated frequency is out of the restricted band.

CHANNEL	TX Channel 40	DETECTOR FUNCTION	Peak (PK)
FREQUENCY RANGE	1GHz ~ 40GHz		Average (AV)

ANTENNA POLARITY & TEST DISTANCE: HORIZONTAL AT 3 M

NO.	FREQ. (MHz)	EMISSION LEVEL (dBuV/m)	LIMIT (dBuV/m)	MARGIN (dB)	ANTENNA HEIGHT (m)	TABLE ANGLE (Degree)	RAW VALUE (dBuV)	CORRECTION FACTOR (dB/m)
1	5150.00	50.8 PK	74.0	-23.2	3.72 H	295	47.8	3.0
2	5150.00	43.8 AV	54.0	-10.2	3.72 H	295	40.8	3.0
3	*5200.00	106.4 PK			3.72 H	295	103.3	3.1
4	*5200.00	94.1 AV			3.72 H	295	91.0	3.1
5	#10400.00	50.7 PK	74.0	-23.3	1.52 H	186	37.1	13.6
6	#10400.00	39.8 AV	54.0	-14.2	1.52 H	186	26.2	13.6
7	15600.00	48.0 PK	74.0	-26.0	1.60 H	121	32.3	15.7
8	15600.00	41.3 AV	54.0	-12.7	1.60 H	121	25.6	15.7

ANTENNA POLARITY & TEST DISTANCE: VERTICAL AT 3 M

NO.	FREQ. (MHz)	EMISSION LEVEL (dBuV/m)	LIMIT (dBuV/m)	MARGIN (dB)	ANTENNA HEIGHT (m)	TABLE ANGLE (Degree)	RAW VALUE (dBuV)	CORRECTION FACTOR (dB/m)
1	5150.00	63.5 PK	74.0	-10.5	2.20 V	92	60.5	3.0
2	5150.00	46.9 AV	54.0	-7.1	2.20 V	92	43.9	3.0
3	*5200.00	117.3 PK			2.20 V	92	114.2	3.1
4	*5200.00	107.1 AV			2.20 V	92	104.0	3.1
5	#10400.00	46.3 PK	74.0	-27.7	3.62 V	162	32.7	13.6
6	#10400.00	37.6 AV	54.0	-16.4	3.62 V	162	24.0	13.6
7	15600.00	58.3 PK	74.0	-15.7	2.99 V	238	42.6	15.7
8	15600.00	48.1 AV	54.0	-5.9	2.99 V	238	32.4	15.7

REMARKS:

1. Emission Level(dBuV/m) = Raw Value(dBuV) + Correction Factor(dB/m)
2. Correction Factor(dB/m) = Antenna Factor(dB/m) + Cable Factor(dB) – Pre-Amplifier Factor(dB)
3. The other emission levels were very low against the limit.
4. Margin value = Emission Level – Limit value
5. " * ": Fundamental frequency.
6. " # ": The radiated frequency is out of the restricted band.

CHANNEL	TX Channel 48	DETECTOR FUNCTION	Peak (PK)
FREQUENCY RANGE	1GHz ~ 40GHz		Average (AV)

ANTENNA POLARITY & TEST DISTANCE: HORIZONTAL AT 3 M

NO.	FREQ. (MHz)	EMISSION LEVEL (dBuV/m)	LIMIT (dBuV/m)	MARGIN (dB)	ANTENNA HEIGHT (m)	TABLE ANGLE (Degree)	RAW VALUE (dBuV)	CORRECTION FACTOR (dB/m)
1	*5240.00	106.6 PK			3.67 H	313	103.4	3.2
2	*5240.00	94.8 AV			3.67 H	313	91.6	3.2
3	5350.00	51.2 PK	74.0	-22.8	3.67 H	313	47.7	3.5
4	5350.00	39.3 AV	54.0	-14.7	3.67 H	313	35.8	3.5
5	#10480.00	49.8 PK	74.0	-24.2	1.57 H	187	35.8	14.0
6	#10480.00	39.1 AV	54.0	-14.9	1.57 H	187	25.1	14.0
7	15720.00	47.3 PK	74.0	-26.7	1.66 H	129	31.9	15.4
8	15720.00	40.6 AV	54.0	-13.4	1.66 H	129	25.2	15.4

ANTENNA POLARITY & TEST DISTANCE: VERTICAL AT 3 M

NO.	FREQ. (MHz)	EMISSION LEVEL (dBuV/m)	LIMIT (dBuV/m)	MARGIN (dB)	ANTENNA HEIGHT (m)	TABLE ANGLE (Degree)	RAW VALUE (dBuV)	CORRECTION FACTOR (dB/m)
1	*5240.00	116.8 PK			2.20 V	121	113.6	3.2
2	*5240.00	106.6 AV			2.20 V	121	103.4	3.2
3	5350.00	59.1 PK	74.0	-14.9	2.20 V	121	55.6	3.5
4	5350.00	46.4 AV	54.0	-7.6	2.20 V	121	42.9	3.5
5	#10480.00	46.7 PK	74.0	-27.3	3.72 V	142	32.7	14.0
6	#10480.00	37.9 AV	54.0	-16.1	3.72 V	142	23.9	14.0
7	15720.00	58.8 PK	74.0	-15.2	3.02 V	239	43.4	15.4
8	15720.00	48.3 AV	54.0	-5.7	3.02 V	239	32.9	15.4

REMARKS:

1. Emission Level(dBuV/m) = Raw Value(dBuV) + Correction Factor(dB/m)
2. Correction Factor(dB/m) = Antenna Factor(dB/m) + Cable Factor(dB) – Pre-Amplifier Factor(dB)
3. The other emission levels were very low against the limit.
4. Margin value = Emission Level – Limit value
5. " * ": Fundamental frequency.
6. " # ": The radiated frequency is out of the restricted band.

CHANNEL	TX Channel 149	DETECTOR FUNCTION	Peak (PK)
FREQUENCY RANGE	1GHz ~ 40GHz		Average (AV)

ANTENNA POLARITY & TEST DISTANCE: HORIZONTAL AT 3 M

NO.	FREQ. (MHz)	EMISSION LEVEL (dBuV/m)	LIMIT (dBuV/m)	MARGIN (dB)	ANTENNA HEIGHT (m)	TABLE ANGLE (Degree)	RAW VALUE (dBuV)	CORRECTION FACTOR (dB/m)
1	#5617.45	59.6 PK	68.2	-8.6	3.77 H	319	55.7	3.9
2	*5745.00	112.9 PK			3.71 H	319	108.7	4.2
3	*5745.00	102.3 AV			3.71 H	319	98.1	4.2
4	#5955.65	58.1 PK	68.2	-10.1	3.77 H	319	53.7	4.4
5	11490.00	62.2 PK	74.0	-11.8	3.64 H	127	47.0	15.2
6	11490.00	49.7 AV	54.0	-4.3	3.64 H	127	34.5	15.2
7	#17235.00	56.5 PK	74.0	-17.5	1.62 H	129	36.5	20.0
8	#17235.00	43.9 AV	54.0	-10.1	1.62 H	129	23.9	20.0

ANTENNA POLARITY & TEST DISTANCE: VERTICAL AT 3 M

NO.	FREQ. (MHz)	EMISSION LEVEL (dBuV/m)	LIMIT (dBuV/m)	MARGIN (dB)	ANTENNA HEIGHT (m)	TABLE ANGLE (Degree)	RAW VALUE (dBuV)	CORRECTION FACTOR (dB/m)
1	#5620.77	61.7 PK	68.2	-6.5	2.91 V	103	57.7	4.0
2	*5745.00	120.7 PK			2.91 V	103	116.5	4.2
3	*5745.00	109.2 AV			2.91 V	103	105.0	4.2
4	#5970.37	59.0 PK	68.2	-9.2	2.91 V	103	54.5	4.5
5	11490.00	65.2 PK	74.0	-8.8	3.32 V	188	50.0	15.2
6	11490.00	51.8 AV	54.0	-2.2	3.32 V	188	36.6	15.2
7	#17235.00	58.0 PK	74.0	-16.0	2.67 V	135	38.0	20.0
8	#17235.00	46.2 AV	54.0	-7.8	2.67 V	135	26.2	20.0

REMARKS:

1. Emission Level(dBuV/m) = Raw Value(dBuV) + Correction Factor(dB/m)
2. Correction Factor(dB/m) = Antenna Factor(dB/m) + Cable Factor(dB) – Pre-Amplifier Factor(dB)
3. The other emission levels were very low against the limit.
4. Margin value = Emission Level – Limit value
5. " * ": Fundamental frequency.
6. " # ": The radiated frequency is out of the restricted band.

CHANNEL	TX Channel 157	DETECTOR FUNCTION	Peak (PK)
FREQUENCY RANGE	1GHz ~ 40GHz		Average (AV)

ANTENNA POLARITY & TEST DISTANCE: HORIZONTAL AT 3 M

NO.	FREQ. (MHz)	EMISSION LEVEL (dBuV/m)	LIMIT (dBuV/m)	MARGIN (dB)	ANTENNA HEIGHT (m)	TABLE ANGLE (Degree)	RAW VALUE (dBuV)	CORRECTION FACTOR (dB/m)
1	#5596.55	59.9 PK	68.2	-8.3	3.78 H	308	56.0	3.9
2	*5785.00	111.8 PK			3.78 H	308	107.7	4.1
3	*5785.00	101.5 AV			3.78 H	308	97.4	4.1
4	#5955.18	59.1 PK	68.2	-9.1	3.78 H	308	54.7	4.4
5	11570.00	62.1 PK	74.0	-11.9	3.68 H	129	47.0	15.1
6	11570.00	49.8 AV	54.0	-4.2	3.68 H	129	34.7	15.1
7	#17355.00	56.9 PK	74.0	-17.1	1.63 H	137	36.4	20.5
8	#17355.00	44.4 AV	54.0	-9.6	1.63 H	137	23.9	20.5

ANTENNA POLARITY & TEST DISTANCE: VERTICAL AT 3 M

NO.	FREQ. (MHz)	EMISSION LEVEL (dBuV/m)	LIMIT (dBuV/m)	MARGIN (dB)	ANTENNA HEIGHT (m)	TABLE ANGLE (Degree)	RAW VALUE (dBuV)	CORRECTION FACTOR (dB/m)
1	#5623.15	60.9 PK	68.2	-7.3	2.86 V	106	56.9	4.0
2	*5785.00	119.0 PK			2.86 V	106	114.9	4.1
3	*5785.00	108.9 AV			2.86 V	106	104.8	4.1
4	#5939.50	59.5 PK	68.2	-8.7	2.86 V	106	55.1	4.4
5	11570.00	67.3 PK	74.0	-6.7	3.18 V	170	52.2	15.1
6	11570.00	51.9 AV	54.0	-2.1	3.18 V	170	36.8	15.1
7	#17355.00	58.0 PK	74.0	-16.0	2.77 V	138	37.5	20.5
8	#17355.00	45.8 AV	54.0	-8.2	2.77 V	138	25.3	20.5

REMARKS:

1. Emission Level(dBuV/m) = Raw Value(dBuV) + Correction Factor(dB/m)
2. Correction Factor(dB/m) = Antenna Factor(dB/m) + Cable Factor(dB) – Pre-Amplifier Factor(dB)
3. The other emission levels were very low against the limit.
4. Margin value = Emission Level – Limit value
5. " * ": Fundamental frequency.
6. " # ": The radiated frequency is out of the restricted band.

CHANNEL	TX Channel 165	DETECTOR FUNCTION	Peak (PK)
FREQUENCY RANGE	1GHz ~ 40GHz		Average (AV)

ANTENNA POLARITY & TEST DISTANCE: HORIZONTAL AT 3 M

NO.	FREQ. (MHz)	EMISSION LEVEL (dBuV/m)	LIMIT (dBuV/m)	MARGIN (dB)	ANTENNA HEIGHT (m)	TABLE ANGLE (Degree)	RAW VALUE (dBuV)	CORRECTION FACTOR (dB/m)
1	#5578.98	59.2 PK	68.2	-9.0	3.73 H	301	55.3	3.9
2	*5825.00	110.5 PK			3.73 H	301	106.3	4.2
3	*5825.00	100.7 AV			3.73 H	301	96.5	4.2
4	#5949.48	59.1 PK	68.2	-9.1	3.73 H	301	54.7	4.4
5	11650.00	62.7 PK	74.0	-11.3	3.62 H	137	47.7	15.0
6	11650.00	50.2 AV	54.0	-3.8	3.62 H	137	35.2	15.0
7	#17475.00	56.6 PK	74.0	-17.4	1.66 H	131	35.5	21.1
8	#17475.00	44.4 AV	54.0	-9.6	1.66 H	131	23.3	21.1

ANTENNA POLARITY & TEST DISTANCE: VERTICAL AT 3 M

NO.	FREQ. (MHz)	EMISSION LEVEL (dBuV/m)	LIMIT (dBuV/m)	MARGIN (dB)	ANTENNA HEIGHT (m)	TABLE ANGLE (Degree)	RAW VALUE (dBuV)	CORRECTION FACTOR (dB/m)
1	#5642.62	59.9 PK	68.2	-8.3	2.73 V	105	55.9	4.0
2	*5825.00	118.9 PK			2.73 V	105	114.7	4.2
3	*5825.00	108.6 AV			2.73 V	105	104.4	4.2
4	#5934.27	58.8 PK	68.2	-9.4	2.73 V	105	54.4	4.4
5	11650.00	66.2 PK	74.0	-7.8	3.03 V	169	51.2	15.0
6	11650.00	51.9 AV	54.0	-2.1	3.03 V	169	36.9	15.0
7	#17475.00	57.9 PK	74.0	-16.1	2.73 V	132	36.8	21.1
8	#17475.00	46.0 AV	54.0	-8.0	2.73 V	132	24.9	21.1

REMARKS:

1. Emission Level(dBuV/m) = Raw Value(dBuV) + Correction Factor(dB/m)
2. Correction Factor(dB/m) = Antenna Factor(dB/m) + Cable Factor(dB) – Pre-Amplifier Factor(dB)
3. The other emission levels were very low against the limit.
4. Margin value = Emission Level – Limit value
5. " * ": Fundamental frequency.
6. " # ": The radiated frequency is out of the restricted band.

802.11ac (VHT40)

CHANNEL	TX Channel 38	DETECTOR FUNCTION	Peak (PK)
FREQUENCY RANGE	1GHz ~ 40GHz		Average (AV)

ANTENNA POLARITY & TEST DISTANCE: HORIZONTAL AT 3 M

NO.	FREQ. (MHz)	EMISSION LEVEL (dBuV/m)	LIMIT (dBuV/m)	MARGIN (dB)	ANTENNA HEIGHT (m)	TABLE ANGLE (Degree)	RAW VALUE (dBuV)	CORRECTION FACTOR (dB/m)
1	5150.00	50.7 PK	74.0	-23.3	3.77 H	292	47.7	3.0
2	5150.00	43.8 AV	54.0	-10.2	3.77 H	292	40.8	3.0
3	*5190.00	100.9 PK			3.77 H	292	97.8	3.1
4	*5190.00	89.1 AV			3.77 H	292	86.0	3.1
5	#10380.00	47.5 PK	74.0	-26.5	1.50 H	198	33.8	13.7
6	#10380.00	37.2 AV	54.0	-16.8	1.50 H	198	23.5	13.7
7	15570.00	49.9 PK	74.0	-24.1	1.75 H	124	34.3	15.6
8	15570.00	38.9 AV	54.0	-15.1	1.75 H	124	23.3	15.6

ANTENNA POLARITY & TEST DISTANCE: VERTICAL AT 3 M

NO.	FREQ. (MHz)	EMISSION LEVEL (dBuV/m)	LIMIT (dBuV/m)	MARGIN (dB)	ANTENNA HEIGHT (m)	TABLE ANGLE (Degree)	RAW VALUE (dBuV)	CORRECTION FACTOR (dB/m)
1	5150.00	67.2 PK	74.0	-6.8	2.28 V	107	64.2	3.0
2	5150.00	52.9 AV	54.0	-1.1	2.28 V	107	49.9	3.0
3	*5190.00	111.5 PK			2.28 V	107	108.4	3.1
4	*5190.00	99.9 AV			2.28 V	107	96.8	3.1
5	#10380.00	52.1 PK	74.0	-21.9	2.08 V	90	38.4	13.7
6	#10380.00	39.8 AV	54.0	-14.2	2.08 V	90	26.1	13.7
7	15570.00	52.3 PK	74.0	-21.7	2.91 V	245	36.7	15.6
8	15570.00	40.1 AV	54.0	-13.9	2.91 V	245	24.5	15.6

REMARKS:

- Emission Level(dBuV/m) = Raw Value(dBuV) + Correction Factor(dB/m)
- Correction Factor(dB/m) = Antenna Factor(dB/m) + Cable Factor(dB) – Pre-Amplifier Factor(dB)
- The other emission levels were very low against the limit.
- Margin value = Emission Level – Limit value
- " * ": Fundamental frequency.
- " # ": The radiated frequency is out of the restricted band.

CHANNEL	TX Channel 46	DETECTOR FUNCTION	Peak (PK)
FREQUENCY RANGE	1GHz ~ 40GHz		Average (AV)

ANTENNA POLARITY & TEST DISTANCE: HORIZONTAL AT 3 M

NO.	FREQ. (MHz)	EMISSION LEVEL (dBuV/m)	LIMIT (dBuV/m)	MARGIN (dB)	ANTENNA HEIGHT (m)	TABLE ANGLE (Degree)	RAW VALUE (dBuV)	CORRECTION FACTOR (dB/m)
1	5150.00	50.4 PK	74.0	-23.6	3.67 H	318	47.4	3.0
2	5150.00	43.4 AV	54.0	-10.6	3.67 H	318	40.4	3.0
3	*5230.00	107.8 PK			3.67 H	318	104.6	3.2
4	*5230.00	96.1 AV			3.67 H	318	92.9	3.2
5	5350.00	51.6 PK	74.0	-22.4	3.67 H	318	48.1	3.5
6	5350.00	39.7 AV	54.0	-14.3	3.67 H	318	36.2	3.5
7	#10460.00	47.9 PK	74.0	-26.1	1.49 H	198	34.0	13.9
8	#10460.00	37.4 AV	54.0	-16.6	1.49 H	198	23.5	13.9
9	15690.00	50.1 PK	74.0	-23.9	1.75 H	122	34.5	15.6
10	15690.00	39.0 AV	54.0	-15.0	1.75 H	122	23.4	15.6

ANTENNA POLARITY & TEST DISTANCE: VERTICAL AT 3 M

NO.	FREQ. (MHz)	EMISSION LEVEL (dBuV/m)	LIMIT (dBuV/m)	MARGIN (dB)	ANTENNA HEIGHT (m)	TABLE ANGLE (Degree)	RAW VALUE (dBuV)	CORRECTION FACTOR (dB/m)
1	5150.00	67.3 PK	74.0	-6.7	2.35 V	106	64.3	3.0
2	5150.00	52.5 AV	54.0	-1.5	2.35 V	106	49.5	3.0
3	*5230.00	118.2 PK			2.35 V	106	115.0	3.2
4	*5230.00	106.9 AV			2.35 V	106	103.7	3.2
5	5350.00	59.5 PK	74.0	-14.5	2.35 V	106	56.0	3.5
6	5350.00	45.0 AV	54.0	-9.0	2.35 V	106	41.5	3.5
7	#10460.00	54.3 PK	74.0	-19.7	2.06 V	95	40.4	13.9
8	#10460.00	41.7 AV	54.0	-12.3	2.06 V	95	27.8	13.9
9	15690.00	57.6 PK	74.0	-16.4	2.89 V	233	42.0	15.6
10	15690.00	45.2 AV	54.0	-8.8	2.89 V	233	29.6	15.6

REMARKS:

1. Emission Level(dBuV/m) = Raw Value(dBuV) + Correction Factor(dB/m)
2. Correction Factor(dB/m) = Antenna Factor(dB/m) + Cable Factor(dB) – Pre-Amplifier Factor(dB)
3. The other emission levels were very low against the limit.
4. Margin value = Emission Level – Limit value
5. " * ": Fundamental frequency.
6. " # ": The radiated frequency is out of the restricted band.

CHANNEL	TX Channel 151	DETECTOR FUNCTION	Peak (PK)
FREQUENCY RANGE	1GHz ~ 40GHz		Average (AV)

ANTENNA POLARITY & TEST DISTANCE: HORIZONTAL AT 3 M

NO.	FREQ. (MHz)	EMISSION LEVEL (dBuV/m)	LIMIT (dBuV/m)	MARGIN (dB)	ANTENNA HEIGHT (m)	TABLE ANGLE (Degree)	RAW VALUE (dBuV)	CORRECTION FACTOR (dB/m)
1	#5623.62	59.2 PK	68.2	-9.0	3.39 H	299	55.2	4.0
2	*5755.00	110.7 PK			3.39 H	299	106.5	4.2
3	*5755.00	99.9 AV			3.39 H	299	95.7	4.2
4	#5946.15	59.7 PK	68.2	-8.5	3.39 H	299	55.3	4.4
5	11510.00	61.5 PK	74.0	-12.5	3.64 H	125	46.4	15.1
6	11510.00	49.4 AV	54.0	-4.6	3.64 H	125	34.3	15.1
7	#17265.00	57.1 PK	74.0	-16.9	1.67 H	129	37.2	19.9
8	#17265.00	44.6 AV	54.0	-9.4	1.67 H	129	24.7	19.9

ANTENNA POLARITY & TEST DISTANCE: VERTICAL AT 3 M

NO.	FREQ. (MHz)	EMISSION LEVEL (dBuV/m)	LIMIT (dBuV/m)	MARGIN (dB)	ANTENNA HEIGHT (m)	TABLE ANGLE (Degree)	RAW VALUE (dBuV)	CORRECTION FACTOR (dB/m)
1	#5651.18	61.7 PK	69.1	-7.4	2.52 V	101	57.7	4.0
2	*5755.00	119.1 PK			2.52 V	101	114.9	4.2
3	*5755.00	107.8 AV			2.52 V	101	103.6	4.2
4	#5941.40	59.5 PK	68.2	-8.7	2.52 V	101	55.1	4.4
5	11510.00	64.8 PK	74.0	-9.2	2.01 V	222	49.7	15.1
6	11510.00	51.6 AV	54.0	-2.4	2.01 V	222	36.5	15.1
7	#17265.00	57.8 PK	74.0	-16.2	2.77 V	139	37.9	19.9
8	#17265.00	46.0 AV	54.0	-8.0	2.77 V	139	26.1	19.9

REMARKS:

1. Emission Level(dBuV/m) = Raw Value(dBuV) + Correction Factor(dB/m)
2. Correction Factor(dB/m) = Antenna Factor(dB/m) + Cable Factor(dB) – Pre-Amplifier Factor(dB)
3. The other emission levels were very low against the limit.
4. Margin value = Emission Level – Limit value
5. " * ": Fundamental frequency.
6. " # ": The radiated frequency is out of the restricted band.

CHANNEL	TX Channel 159	DETECTOR FUNCTION	Peak (PK)
FREQUENCY RANGE	1GHz ~ 40GHz		Average (AV)

ANTENNA POLARITY & TEST DISTANCE: HORIZONTAL AT 3 M

NO.	FREQ. (MHz)	EMISSION LEVEL (dBuV/m)	LIMIT (dBuV/m)	MARGIN (dB)	ANTENNA HEIGHT (m)	TABLE ANGLE (Degree)	RAW VALUE (dBuV)	CORRECTION FACTOR (dB/m)
1	#5608.90	59.5 PK	68.2	-8.7	3.41 H	299	55.6	3.9
2	*5795.00	111.8 PK			3.41 H	299	107.7	4.1
3	*5795.00	100.7 AV			3.41 H	299	96.6	4.1
4	#5969.43	59.5 PK	68.2	-8.7	3.41 H	299	55.0	4.5
5	11590.00	62.4 PK	74.0	-11.6	3.67 H	131	47.3	15.1
6	11590.00	50.3 AV	54.0	-3.7	3.67 H	131	35.2	15.1
7	#17385.00	56.8 PK	74.0	-17.2	1.66 H	138	36.2	20.6
8	#17385.00	44.5 AV	54.0	-9.5	1.66 H	138	23.9	20.6

ANTENNA POLARITY & TEST DISTANCE: VERTICAL AT 3 M

NO.	FREQ. (MHz)	EMISSION LEVEL (dBuV/m)	LIMIT (dBuV/m)	MARGIN (dB)	ANTENNA HEIGHT (m)	TABLE ANGLE (Degree)	RAW VALUE (dBuV)	CORRECTION FACTOR (dB/m)
1	#5640.25	61.4 PK	68.2	-6.8	2.55 V	101	57.4	4.0
2	*5795.00	119.8 PK			2.55 V	101	115.7	4.1
3	*5795.00	107.6 AV			2.55 V	101	103.5	4.1
4	#5961.82	59.9 PK	68.2	-8.3	2.55 V	101	55.4	4.5
5	11590.00	64.9 PK	74.0	-9.1	3.24 V	187	49.8	15.1
6	11590.00	51.8 AV	54.0	-2.2	3.24 V	187	36.7	15.1
7	#17385.00	58.7 PK	74.0	-15.3	2.74 V	129	38.1	20.6
8	#17385.00	46.5 AV	54.0	-7.5	2.74 V	129	25.9	20.6

REMARKS:

1. Emission Level(dBuV/m) = Raw Value(dBuV) + Correction Factor(dB/m)
2. Correction Factor(dB/m) = Antenna Factor(dB/m) + Cable Factor(dB) – Pre-Amplifier Factor(dB)
3. The other emission levels were very low against the limit.
4. Margin value = Emission Level – Limit value
5. " * ": Fundamental frequency.
6. " # ": The radiated frequency is out of the restricted band.

802.11ac (VHT80)

CHANNEL	TX Channel 42	DETECTOR FUNCTION	Peak (PK)
FREQUENCY RANGE	1GHz ~ 40GHz		Average (AV)

ANTENNA POLARITY & TEST DISTANCE: HORIZONTAL AT 3 M

NO.	FREQ. (MHz)	EMISSION LEVEL (dBuV/m)	LIMIT (dBuV/m)	MARGIN (dB)	ANTENNA HEIGHT (m)	TABLE ANGLE (Degree)	RAW VALUE (dBuV)	CORRECTION FACTOR (dB/m)
1	5150.00	51.0 PK	74.0	-23.0	3.70 H	315	48.0	3.0
2	5150.00	44.1 AV	54.0	-9.9	3.70 H	315	41.1	3.0
3	*5210.00	95.4 PK			3.70 H	315	92.2	3.2
4	*5210.00	83.1 AV			3.70 H	315	79.9	3.2
5	5350.00	51.0 PK	74.0	-23.0	3.70 H	315	47.5	3.5
6	5350.00	39.5 AV	54.0	-14.5	3.70 H	315	36.0	3.5
7	#10420.00	48.7 PK	74.0	-25.3	1.54 H	193	34.9	13.8
8	#10420.00	38.1 AV	54.0	-15.9	1.54 H	193	24.3	13.8
9	15630.00	49.5 PK	74.0	-24.5	1.67 H	124	33.8	15.7
10	15630.00	38.8 AV	54.0	-15.2	1.67 H	124	23.1	15.7

ANTENNA POLARITY & TEST DISTANCE: VERTICAL AT 3 M

NO.	FREQ. (MHz)	EMISSION LEVEL (dBuV/m)	LIMIT (dBuV/m)	MARGIN (dB)	ANTENNA HEIGHT (m)	TABLE ANGLE (Degree)	RAW VALUE (dBuV)	CORRECTION FACTOR (dB/m)
1	5150.00	66.6 PK	74.0	-7.4	2.41 V	120	63.6	3.0
2	5150.00	52.9 AV	54.0	-1.1	2.41 V	120	49.9	3.0
3	*5210.00	105.7 PK			2.41 V	120	102.5	3.2
4	*5210.00	93.8 AV			2.41 V	120	90.6	3.2
5	5350.00	55.2 PK	74.0	-18.8	2.41 V	120	51.7	3.5
6	5350.00	42.7 AV	54.0	-11.3	2.41 V	120	39.2	3.5
7	#10420.00	51.9 PK	74.0	-22.1	2.03 V	94	38.1	13.8
8	#10420.00	39.5 AV	54.0	-14.5	2.03 V	94	25.7	13.8
9	15630.00	51.8 PK	74.0	-22.2	2.97 V	261	36.1	15.7
10	15630.00	39.8 AV	54.0	-14.2	2.97 V	261	24.1	15.7

REMARKS:

1. Emission Level(dBuV/m) = Raw Value(dBuV) + Correction Factor(dB/m)
2. Correction Factor(dB/m) = Antenna Factor(dB/m) + Cable Factor(dB) – Pre-Amplifier Factor(dB)
3. The other emission levels were very low against the limit.
4. Margin value = Emission Level – Limit value
5. " * ": Fundamental frequency.
6. " # ": The radiated frequency is out of the restricted band.

CHANNEL	TX Channel 155	DETECTOR FUNCTION	Peak (PK)
FREQUENCY RANGE	1GHz ~ 40GHz		Average (AV)

ANTENNA POLARITY & TEST DISTANCE: HORIZONTAL AT 3 M

NO.	FREQ. (MHz)	EMISSION LEVEL (dBuV/m)	LIMIT (dBuV/m)	MARGIN (dB)	ANTENNA HEIGHT (m)	TABLE ANGLE (Degree)	RAW VALUE (dBuV)	CORRECTION FACTOR (dB/m)
1	#5646.30	62.1 PK	74.0	-11.9	3.39 H	299	58.1	4.0
2	#5646.30	46.8 AV	54.0	-7.2	3.39 H	299	42.8	4.0
3	*5775.00	108.0 PK			3.39 H	299	103.8	4.2
4	*5775.00	95.8 AV			3.39 H	299	91.6	4.2
5	#5929.50	61.4 PK	74.0	-12.6	3.39 H	299	57.0	4.4
6	#5929.50	46.7 AV	54.0	-7.3	3.39 H	299	42.3	4.4
7	11550.00	57.3 PK	74.0	-16.7	3.68 H	141	42.1	15.2
8	11550.00	45.1 AV	54.0	-8.9	3.68 H	141	29.9	15.2
9	#17325.00	54.3 PK	74.0	-19.7	1.68 H	129	34.0	20.3
10	#17325.00	41.2 AV	54.0	-12.8	1.68 H	129	20.9	20.3

ANTENNA POLARITY & TEST DISTANCE: VERTICAL AT 3 M

NO.	FREQ. (MHz)	EMISSION LEVEL (dBuV/m)	LIMIT (dBuV/m)	MARGIN (dB)	ANTENNA HEIGHT (m)	TABLE ANGLE (Degree)	RAW VALUE (dBuV)	CORRECTION FACTOR (dB/m)
1	#5649.80	67.5 PK	74.0	-6.5	2.72 V	100	63.5	4.0
2	#5649.80	52.9 AV	54.0	-1.1	2.72 V	100	48.9	4.0
3	*5775.00	116.9 PK			2.72 V	100	112.7	4.2
4	*5775.00	101.6 AV			2.72 V	100	97.4	4.2
5	#5923.30	65.5 PK	74.0	-8.5	2.72 V	100	61.1	4.4
6	#5923.30	50.1 AV	54.0	-3.9	2.72 V	100	45.7	4.4
7	11550.00	60.1 PK	74.0	-13.9	3.27 V	184	44.9	15.2
8	11550.00	47.6 AV	54.0	-6.4	3.27 V	184	32.4	15.2
9	#17325.00	56.3 PK	74.0	-17.7	2.71 V	130	36.0	20.3
10	#17325.00	43.6 AV	54.0	-10.4	2.71 V	130	23.3	20.3

REMARKS:

1. Emission Level(dBuV/m) = Raw Value(dBuV) + Correction Factor(dB/m)
2. Correction Factor(dB/m) = Antenna Factor(dB/m) + Cable Factor(dB) – Pre-Amplifier Factor(dB)
3. The other emission levels were very low against the limit.
4. Margin value = Emission Level – Limit value
5. " * ": Fundamental frequency.
6. " # ": The radiated frequency is out of the restricted band.

Below 1GHz Data:

802.11ac (VHT40)

CHANNEL	TX Channel 46	DETECTOR FUNCTION	Quasi-Peak (QP)
FREQUENCY RANGE	9kHz ~ 1GHz		

ANTENNA POLARITY & TEST DISTANCE: HORIZONTAL AT 3 M

NO.	FREQ. (MHz)	EMISSION LEVEL (dBuV/m)	LIMIT (dBuV/m)	MARGIN (dB)	ANTENNA HEIGHT (m)	TABLE ANGLE (Degree)	RAW VALUE (dBuV)	CORRECTION FACTOR (dB/m)
1	30.90	25.8 QP	40.0	-14.2	1.15 H	330	35.1	-9.3
2	81.73	30.8 QP	40.0	-9.2	1.15 H	68	43.4	-12.6
3	143.32	26.3 QP	43.5	-17.2	1.15 H	83	34.9	-8.6
4	360.02	30.9 QP	46.0	-15.1	1.15 H	126	36.9	-6.0
5	400.01	32.9 QP	46.0	-13.1	1.15 H	126	37.9	-5.0
6	440.02	27.9 QP	46.0	-18.1	1.15 H	153	31.4	-3.5

ANTENNA POLARITY & TEST DISTANCE: VERTICAL AT 3 M

NO.	FREQ. (MHz)	EMISSION LEVEL (dBuV/m)	LIMIT (dBuV/m)	MARGIN (dB)	ANTENNA HEIGHT (m)	TABLE ANGLE (Degree)	RAW VALUE (dBuV)	CORRECTION FACTOR (dB/m)
1	30.61	34.7 QP	40.0	-5.3	1.05 V	325	44.0	-9.3
2	47.80	36.9 QP	40.0	-3.1	1.05 V	146	44.6	-7.7
3	75.78	31.5 QP	40.0	-8.5	1.05 V	313	42.7	-11.2
4	101.88	32.2 QP	43.5	-11.3	1.05 V	249	44.6	-12.4
5	355.02	29.2 QP	46.0	-16.8	1.05 V	360	35.5	-6.3
6	875.02	35.3 QP	46.0	-10.7	1.05 V	83	31.4	3.9

REMARKS:

1. Emission Level(dBuV/m) = Raw Value(dBuV) + Correction Factor(dB/m)
2. Correction Factor(dB/m) = Antenna Factor(dB/m) + Cable Factor(dB) – Pre-Amplifier Factor(dB)
3. The other emission levels were very low against the limit.
4. Margin value = Emission Level – Limit value

4.2 Conducted Emission Measurement

4.2.1 Limits of Conducted Emission Measurement

Frequency (MHz)	Conducted Limit (dBuV)	
	Quasi-peak	Average
0.15 - 0.5	66 - 56	56 - 46
0.50 - 5.0	56	46
5.0 - 30.0	60	50

Note: 1. The lower limit shall apply at the transition frequencies.

2. The limit decreases in line with the logarithm of the frequency in the range of 0.15 to 0.50MHz.

4.2.2 Test Instruments

DESCRIPTION & MANUFACTURER	MODEL NO.	SERIAL NO.	CALIBRATED DATE	CALIBRATED UNTIL
Test Receiver R&S	ESCS 30	100375	May 09, 2016	May 08, 2017
Line-Impedance Stabilization Network (for EUT) SCHWARZBECK	NSLK-8127	8127-522	Aug. 31, 2016	Aug. 30, 2017
Line-Impedance Stabilization Network (for Peripheral) R&S	ENV216	100072	June 13, 2016	June 12, 2017
RF Cable	5D-FB	COACAB-002	Mar. 04, 2016	Mar. 03, 2017
10 dB PAD Mini-Circuits	HAT-10+	CONATT-003	Sep. 13, 2016	Sep. 12, 2017
50 ohms Terminator	N/A	EMC-03	Sep. 29, 2016	Sep. 28, 2017
50 ohms Terminator	N/A	EMC-02	Sep. 29, 2016	Sep. 28, 2017
Software BVADT	BVADT_Cond_ V7.3.7.4	NA	NA	NA

Note:

1. The calibration interval of the above test instruments are 12 months and the calibrations are traceable to NML/ROC and NIST/USA.
2. The test was performed in Shielded Room No. C.
- 3 The VCCI Con C Registration No. is C-3611.
- 4 Tested Date: Nov. 09, 2016

4.2.3 Test Procedure

- The EUT was placed 0.4 meters from the conducting wall of the shielded room with EUT being connected to the power mains through a line impedance stabilization network (LISN). Other support units were connected to the power mains through another LISN. The two LISNs provide 50 ohm/ 50uH of coupling impedance for the measuring instrument.
- Both lines of the power mains connected to the EUT were checked for maximum conducted interference.
- The frequency range from 150kHz to 30MHz was searched. Emission levels under (Limit - 20dB) was not recorded.

NOTE: All modes of operation were investigated and the worst-case emissions are reported.

4.2.4 Deviation from Test Standard

No deviation.

4.2.5 Test Setup

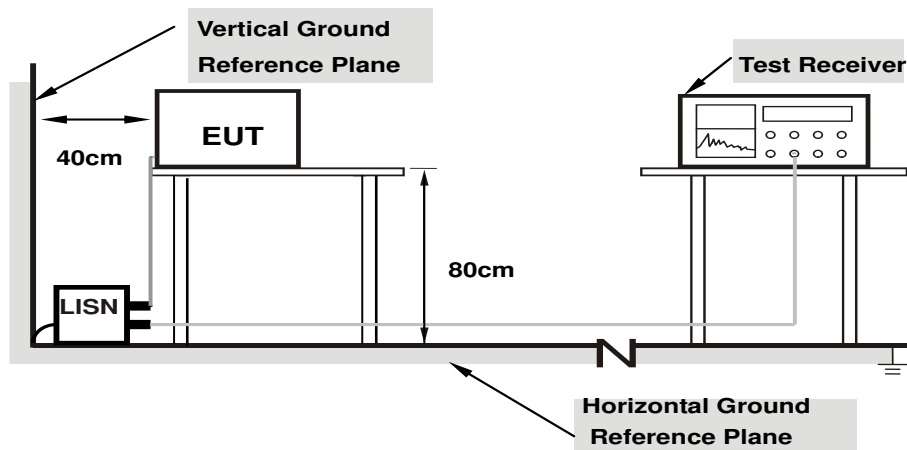

Note: 1.Support units were connected to second LISN.

For the actual test configuration, please refer to the attached file (Test Setup Photo).

4.2.6 EUT Operating Condition

Same as 4.1.6.

4.2.7 Test Results (Mode 1)

Phase	Line (L)	Detector Function	Quasi-Peak (QP) / Average (AV)
-------	----------	-------------------	--------------------------------

No	Freq. [MHz]	Corr.	Reading Value		Emission Level		Limit		Margin	
		Factor (dB)	[dB (uV)]		[dB (uV)]		[dB (uV)]		(dB)	
			Q.P.	AV.	Q.P.	AV.	Q.P.	AV.	Q.P.	AV.
1	0.15781	10.14	35.31	27.42	45.45	37.56	65.58	55.58	-20.13	-18.02
2	0.36484	10.11	32.82	19.85	42.93	29.96	58.62	48.62	-15.69	-18.66
3	0.42344	10.11	37.54	31.26	47.65	41.37	57.38	47.38	-9.73	-6.01
4	0.78672	10.12	27.39	19.25	37.51	29.37	56.00	46.00	-18.49	-16.63
5	1.09375	10.13	30.54	22.39	40.67	32.52	56.00	46.00	-15.33	-13.48
6	2.61719	10.27	26.45	22.25	36.72	32.52	56.00	46.00	-19.28	-13.48

REMARKS:

1. Q.P. and AV. are abbreviations of quasi-peak and average individually.
2. The emission levels of other frequencies were very low against the limit.
3. Margin value = Emission level - Limit value
4. Correction factor = Insertion loss + Cable loss
5. Emission Level = Correction Factor + Reading Value.

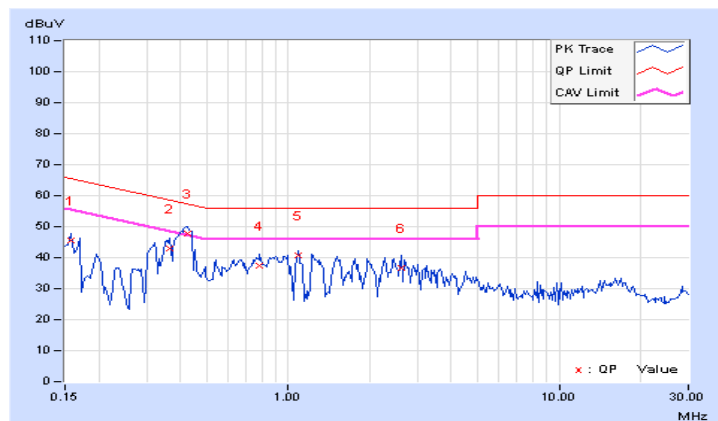

Phase	Neutral (N)	Detector Function	Quasi-Peak (QP) / Average (AV)
-------	-------------	-------------------	--------------------------------

No	Freq. [MHz]	Corr. Factor	Reading Value [dB (uV)]		Emission Level [dB (uV)]		Limit [dB (uV)]		Margin (dB)	
		(dB)	Q.P.	AV.	Q.P.	AV.	Q.P.	AV.	Q.P.	AV.
	1	0.15781	10.17	35.34	27.43	45.51	37.60	65.58	55.58	-20.07
2	0.36094	10.09	32.10	21.67	42.19	31.76	58.71	48.71	-16.52	-16.95
3	0.42344	10.09	36.56	29.46	46.65	39.55	57.38	47.38	-10.73	-7.83
4	0.78281	10.17	26.90	19.59	37.07	29.76	56.00	46.00	-18.93	-16.24
5	1.07813	10.21	29.52	21.53	39.73	31.74	56.00	46.00	-16.27	-14.26
6	1.49219	10.19	26.39	18.49	36.58	28.68	56.00	46.00	-19.42	-17.32
7	1.76953	10.17	25.75	19.20	35.92	29.37	56.00	46.00	-20.08	-16.63

REMARKS:

1. Q.P. and AV. are abbreviations of quasi-peak and average individually.
2. The emission levels of other frequencies were very low against the limit.
3. Margin value = Emission level - Limit value
4. Correction factor = Insertion loss + Cable loss
5. Emission Level = Correction Factor + Reading Value.

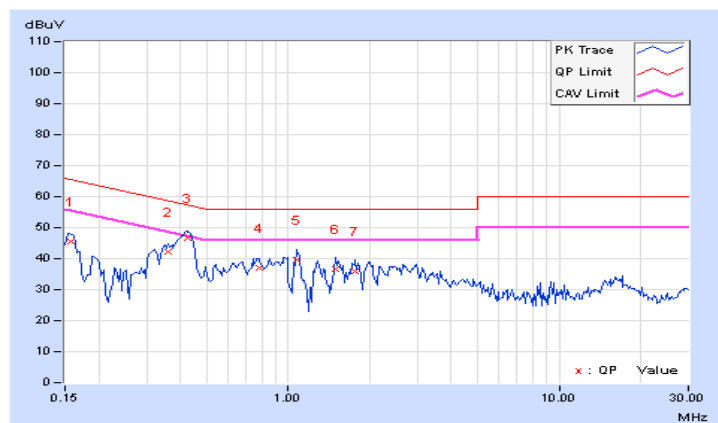

4.2.8 Test Results (Mode 2)

Phase	Line (L)	Detector Function	Quasi-Peak (QP) / Average (AV)
-------	----------	-------------------	--------------------------------

No	Freq. [MHz]	Corr. Factor	Reading Value [dB (uV)]		Emission Level [dB (uV)]		Limit [dB (uV)]		Margin (dB)	
		(dB)	Q.P.	AV.	Q.P.	AV.	Q.P.	AV.	Q.P.	AV.
	1	0.15391	10.14	38.25	26.81	48.39	36.95	65.79	55.79	-17.40
2	0.16953	10.13	33.75	24.02	43.88	34.15	64.98	54.98	-21.10	-20.83
3	0.19687	10.12	30.66	19.67	40.78	29.79	63.74	53.74	-22.96	-23.95
4	0.29844	10.12	22.59	16.20	32.71	26.32	60.29	50.29	-27.58	-23.97
5	0.36875	10.11	27.60	24.85	37.71	34.96	58.53	48.53	-20.82	-13.57
6	4.40625	10.32	18.32	9.12	28.64	19.44	56.00	46.00	-27.36	-26.56
7	20.62109	10.83	23.28	18.22	34.11	29.05	60.00	50.00	-25.89	-20.95

REMARKS:

1. Q.P. and AV. are abbreviations of quasi-peak and average individually.
2. The emission levels of other frequencies were very low against the limit.
3. Margin value = Emission level - Limit value
4. Correction factor = Insertion loss + Cable loss
5. Emission Level = Correction Factor + Reading Value.

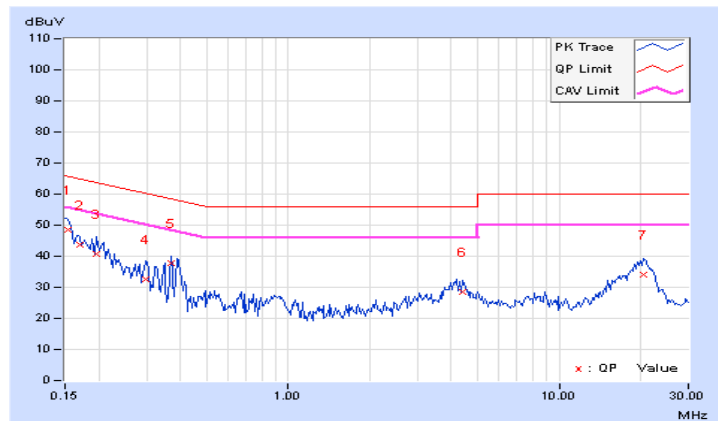

Phase	Neutral (N)	Detector Function	Quasi-Peak (QP) / Average (AV)
-------	-------------	-------------------	--------------------------------

No	Freq. [MHz]	Corr. Factor	Reading Value [dB (uV)]		Emission Level [dB (uV)]		Limit [dB (uV)]		Margin (dB)	
		(dB)	Q.P.	AV.	Q.P.	AV.	Q.P.	AV.	Q.P.	AV.
	1	0.16172	10.16	37.52	25.08	47.68	35.24	65.38	55.38	-17.70
2	0.18516	10.11	33.61	20.97	43.72	31.08	64.25	54.25	-20.53	-23.17
3	0.32578	10.08	27.87	25.08	37.95	35.16	59.56	49.56	-21.61	-14.40
4	0.37266	10.09	31.53	28.89	41.62	38.98	58.44	48.44	-16.82	-9.46
5	0.38828	10.09	29.76	25.62	39.85	35.71	58.10	48.10	-18.25	-12.39
6	4.22656	10.33	20.13	11.43	30.46	21.76	56.00	46.00	-25.54	-24.24
7	20.36719	10.85	24.14	19.08	34.99	29.93	60.00	50.00	-25.01	-20.07

REMARKS:

1. Q.P. and AV. are abbreviations of quasi-peak and average individually.
2. The emission levels of other frequencies were very low against the limit.
3. Margin value = Emission level - Limit value
4. Correction factor = Insertion loss + Cable loss
5. Emission Level = Correction Factor + Reading Value.

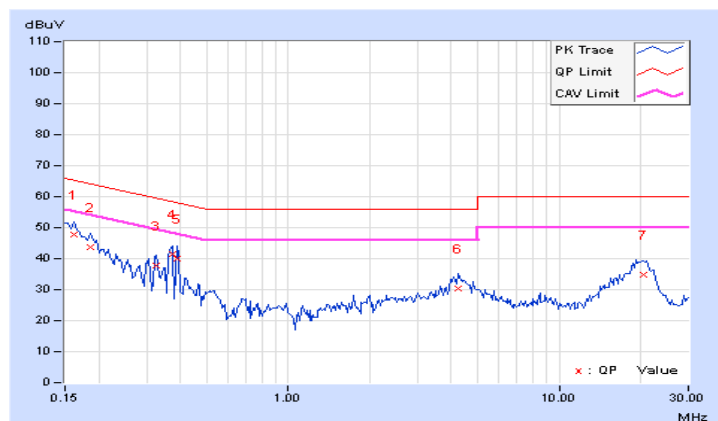

4.3 Transmit Power Measurement

4.3.1 Limits of Transmit Power Measurement

Operation Band	EUT Category		Limit
U-NII-1		Outdoor Access Point	1 Watt (30 dBm) (Max. e.i.r.p \leq 125mW(21 dBm) at any elevation angle above 30 degrees as measured from the horizon)
		Fixed point-to-point Access Point	1 Watt (30 dBm)
	√	Indoor Access Point	1 Watt (30 dBm)
		Mobile and Portable client device	250mW (24 dBm)
U-NII-2A			250mW (24 dBm) or 11 dBm+10 log B*
U-NII-2C			250mW (24 dBm) or 11 dBm+10 log B*
U-NII-3		√	1 Watt (30 dBm)

*B is the 26 dB emission bandwidth in megahertz

Per KDB 662911 Method of conducted output power measurement on IEEE 802.11 devices,

Array Gain = 0 dB (i.e., no array gain) for $N_{ANT} \leq 4$;

Array Gain = 0 dB (i.e., no array gain) for channel widths ≥ 40 MHz for any N_{ANT} ;

Array Gain = $5 \log(N_{ANT}/N_{SS})$ dB or 3 dB, whichever is less for 20-MHz channel widths with $N_{ANT} \geq 5$.

For power measurements on all other devices: Array Gain = $10 \log(N_{ANT}/N_{SS})$ dB.

4.3.2 Test Setup

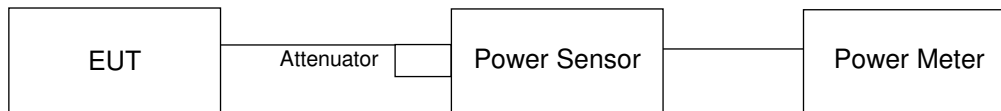

4.3.3 Test Instruments

DESCRIPTION & MANUFACTURER	MODEL NO.	SERIAL NO.	CALIBRATED DATE	CALIBRATED UNTIL
Power meter Anritsu	ML2495A	1014008	May 5, 2016	May 4, 2017
Power sensor Anritsu	MA2411B	0917122	May 5, 2016	May 4, 2017

- NOTE:**
1. The test was performed in Oven room 2.
 2. The calibration interval of the above test instruments is 12 months and the calibrations are traceable to NML/ROC and NIST/USA.
 3. Tested Date: Nov. 09, 2016

4.3.4 Test Procedure

Method PM is used to perform output power measurement, trigger and gating function of wide band power meter is enabled to measure max output power of TX on burst. Duty factor is not added to measured value.

4.3.5 Deviation from Test Standard

No deviation.

4.3.6 EUT Operating Condition

The software provided by client to enable the EUT under transmission condition continuously at lowest, middle and highest channel frequencies individually.

4.3.7 Test Result

802.11a

Chan.	Chan. Freq. (MHz)	Maximum Conducted Power (dBm)			Total Power (mW)	Total Power (dBm)	Limit (dBm)	Pass / Fail
		Chain 0	Chain 1	Chain 2				
36	5180	19.98	20.12	20.04	303.268	24.82	30	Pass
40	5200	20.39	20.19	20.02	314.33	24.97	30	Pass
48	5240	20.36	20.02	20.03	309.798	24.91	30	Pass
149	5745	21.12	21.40	21.46	407.417	26.10	30	Pass
157	5785	20.12	20.23	20.53	321.221	25.07	30	Pass
165	5825	18.69	18.68	18.98	226.819	23.56	30	Pass

802.11ac (VHT20)

Chan.	Chan. Freq. (MHz)	Maximum Conducted Power (dBm)			Total Power (mW)	Total Power (dBm)	Limit (dBm)	Pass / Fail
		Chain 0	Chain 1	Chain 2				
36	5180	20.52	20.47	20.36	332.792	25.22	30	Pass
40	5200	20.39	20.15	20.16	316.663	25.01	30	Pass
48	5240	20.46	20.31	20.44	329.234	25.18	30	Pass
149	5745	21.12	21.23	21.43	401.154	26.03	30	Pass
157	5785	20.02	20.45	20.51	323.839	25.10	30	Pass
165	5825	19.22	19.48	19.69	265.387	24.24	30	Pass

802.11ac (VHT40)

Chan.	Chan. Freq. (MHz)	Maximum Conducted Power (dBm)			Total Power (mW)	Total Power (dBm)	Limit (dBm)	Pass / Fail
		Chain 0	Chain 1	Chain 2				
38	5190	15.82	15.77	15.90	114.856	20.60	30	Pass
46	5230	23.44	23.28	23.50	657.486	28.18	30	Pass
151	5755	23.21	23.32	23.30	637.99	28.05	30	Pass
159	5795	22.35	22.56	22.78	541.764	27.34	30	Pass

802.11ac (VHT80)

Chan.	Chan. Freq. (MHz)	Maximum Conducted Power (dBm)			Total Power (mW)	Total Power (dBm)	Limit (dBm)	Pass / Fail
		Chain 0	Chain 1	Chain 2				
42	5210	14.18	14.01	14.03	76.652	18.85	30	Pass
155	5775	21.42	21.68	21.84	438.664	26.42	30	Pass

4.4 Occupied Bandwidth Measurement

4.4.1 Test Setup

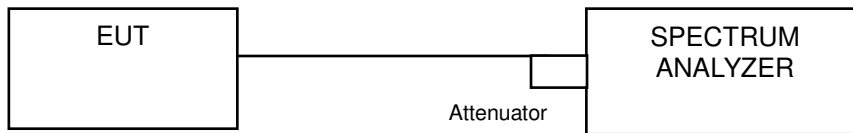

4.4.2 Test Instruments

DESCRIPTION & MANUFACTURER	MODEL NO.	SERIAL NO.	CALIBRATED DATE	CALIBRATED UNTIL
Spectrum Analyzer R&S	FSP40	100060	May 11, 2016	May 10, 2017

- NOTE:**
1. The test was performed in Oven room 2.
 2. The calibration interval of the above test instruments is 12 months and the calibrations are traceable to NML/ROC and NIST/USA.
 3. Tested Date: Nov. 09, 2016

4.4.3 Test Procedure

The transmitter output was connected to the spectrum analyzer through an attenuator. The bandwidth of the fundamental frequency was measured by spectrum analyzer with resolution bandwidth in the range of 1% to 5% of the anticipated emission bandwidth, and a video bandwidth at least 3x the resolution bandwidth and set the detector to SAMPLE. The width of a frequency band such that, below the lower and above the upper frequency limits, the mean powers emitted are each equal to a specified percentage 0.5 %of the total mean power of a given emission.

4.4.4 Test Results

802.11a

Channel	Channel Frequency (MHz)	Occupied Bandwidth (MHz)		
		Chain 0	Chain 1	Chain 2
36	5180	16.56	16.68	16.68
40	5200	16.80	16.68	16.56
48	5240	16.92	16.68	16.68
149	5745	16.68	16.68	16.68
157	5785	16.68	16.68	16.68
165	5825	16.68	16.80	16.68

802.11ac (VHT20)

Channel	Channel Frequency (MHz)	Occupied Bandwidth (MHz)		
		Chain 0	Chain 1	Chain 2
36	5180	18.00	17.88	17.76
40	5200	18.00	17.76	17.76
48	5240	17.64	17.76	17.88
149	5745	18.00	17.52	17.76
157	5785	17.88	18.00	17.88
165	5825	17.88	17.88	17.88

802.11ac (VHT40)

Channel	Channel Frequency (MHz)	Occupied Bandwidth (MHz)		
		Chain 0	Chain 1	Chain 2
38	5190	36.96	36.48	37.20
46	5230	37.20	36.48	36.96
151	5755	36.72	36.24	36.96
159	5795	36.72	37.20	36.96

802.11ac (VHT80)

Channel	Channel Frequency (MHz)	Occupied Bandwidth (MHz)		
		Chain 0	Chain 1	Chain 2
42	5210	76.32	75.36	75.84
155	5775	76.32	75.84	76.32

Spectrum Plot of Worst Value

802.11a_Chain0 / CH48

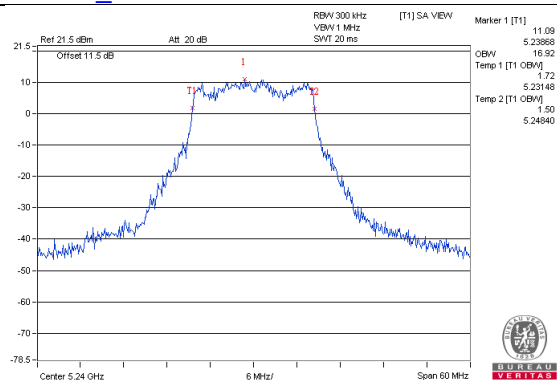

802.11ac (VHT20)_Chain0 / CH36

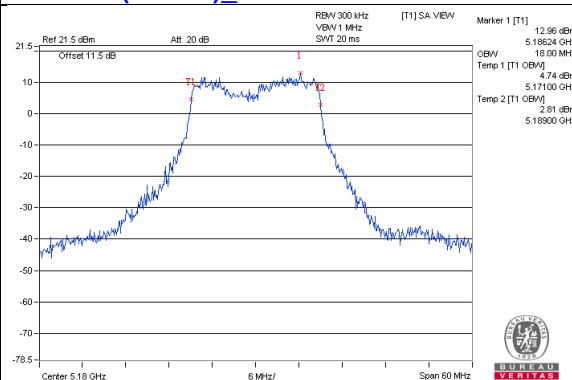

802.11ac (VHT40)_Chain0 / CH46

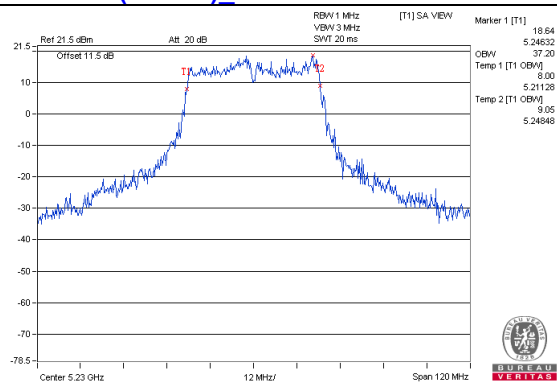

802.11ac (VHT80)_Chain0 / CH42

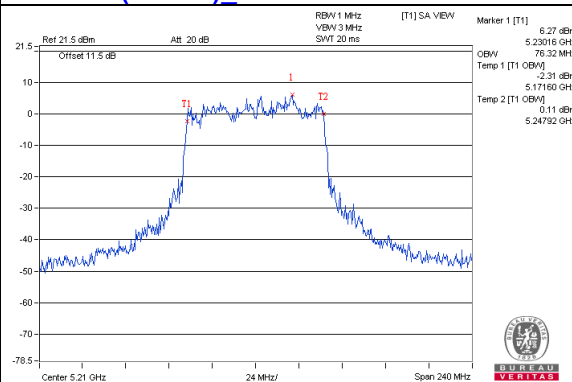

Spectrum Plot for near by DFS band (DFS is required, if 99% OCP straddle into U-NII-2A band)

802.11a_Chain0 / CH48

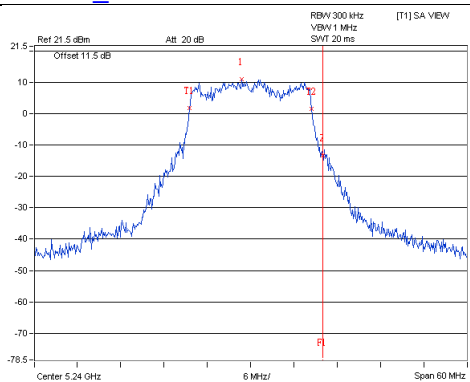

802.11a_Chain1 / CH48

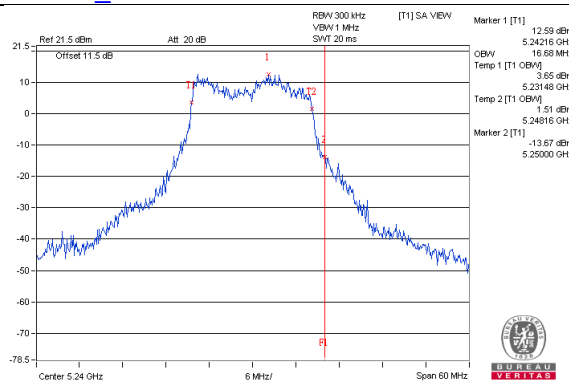

802.11a_Chain2 / CH48

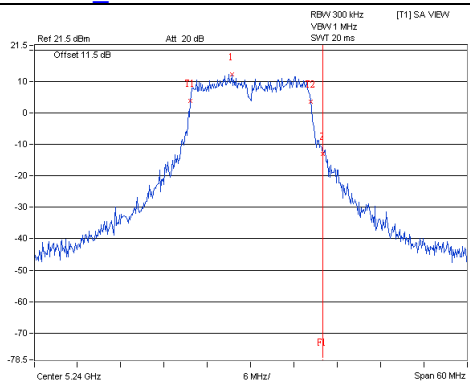

802.11ac(VHT20)_Chain0 / CH48

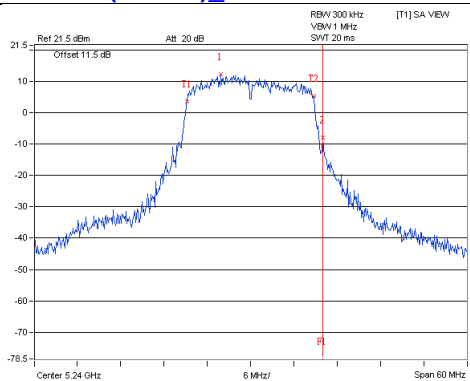

802.11ac(VHT20)_Chain1 / CH48

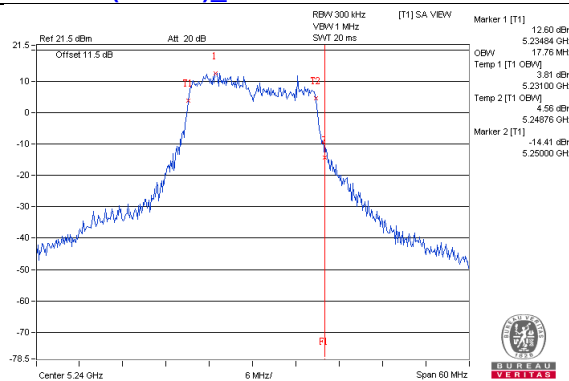

802.11ac(VHT20)_Chain2 / CH48

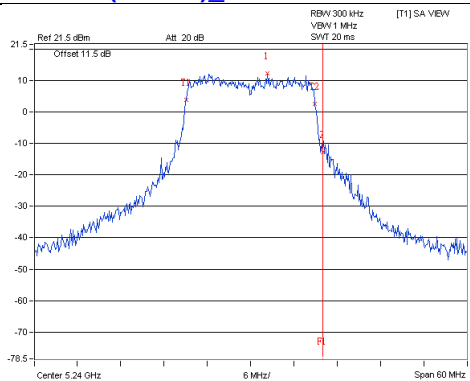

Spectrum Plot for near by DFS band (DFS is required, if 99% OCP straddle into U-NII-2A band)

802.11ac(VHT40)_Chain0 / CH46

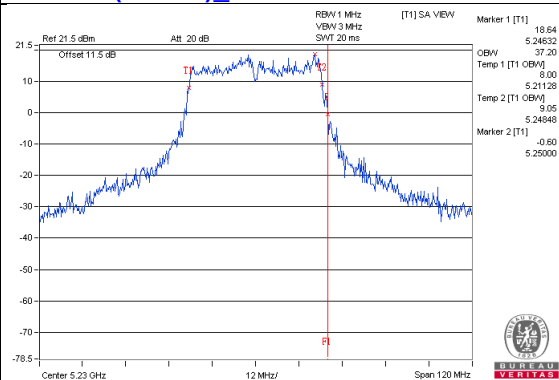

802.11ac(VHT40)_Chain1 / CH46

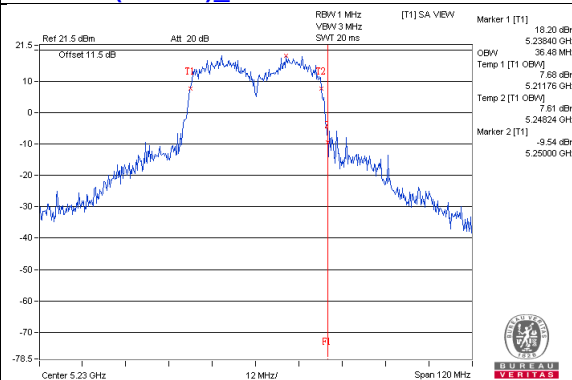

802.11ac(VHT40)_Chain2 / CH46

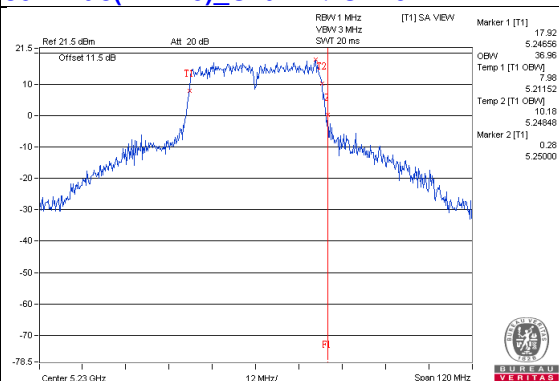

802.11ac(VHT80)_Chain0 / CH42

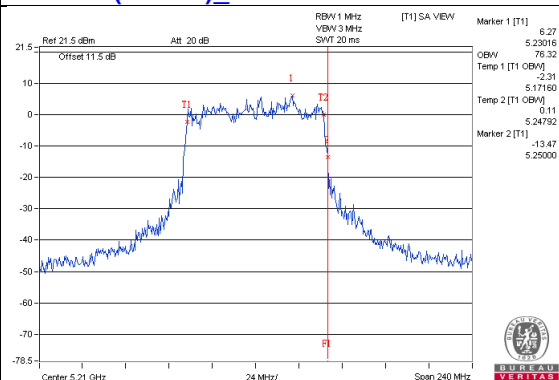

802.11ac(VHT80)_Chain1 / CH42

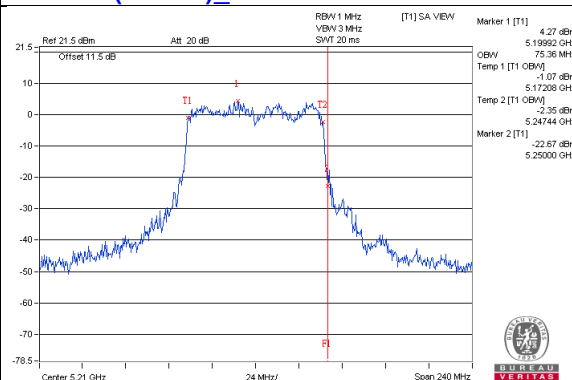

802.11ac(VHT80)_Chain2 / CH42

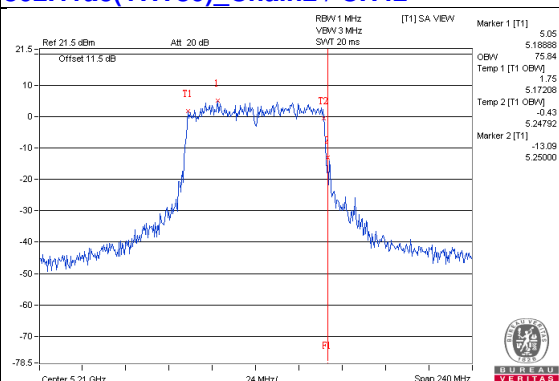

**Spectrum Plot for near by DFS band
(DFS is required, if 99% OCP straddle into U-NII-2C band)**

802.11a_Chain0 / CH149

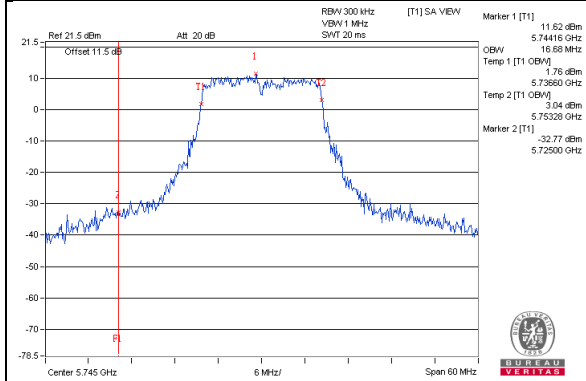

802.11a_Chain1 / CH149

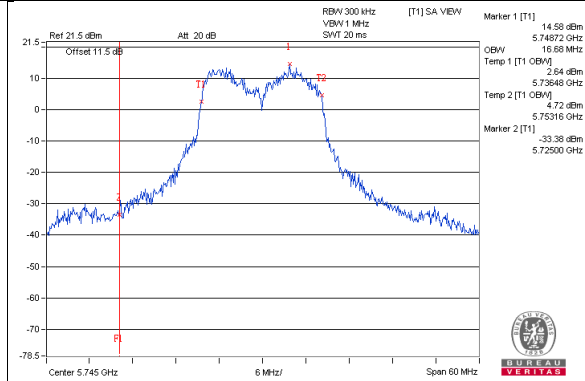

802.11a_Chain2 / CH149

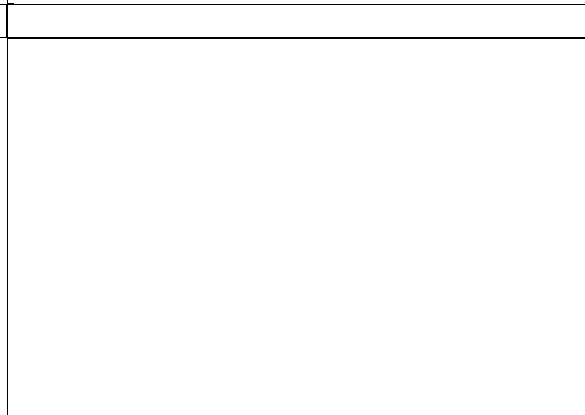
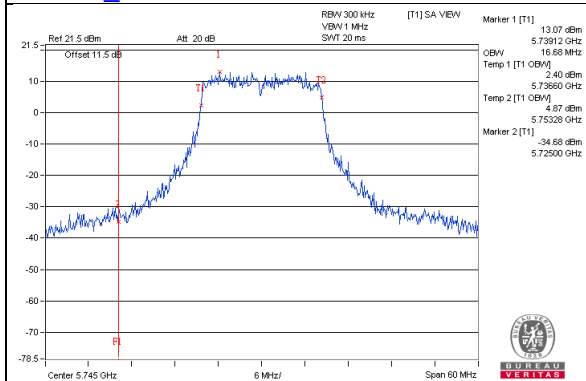

802.11ac(VHT20)_Chain0 / CH149

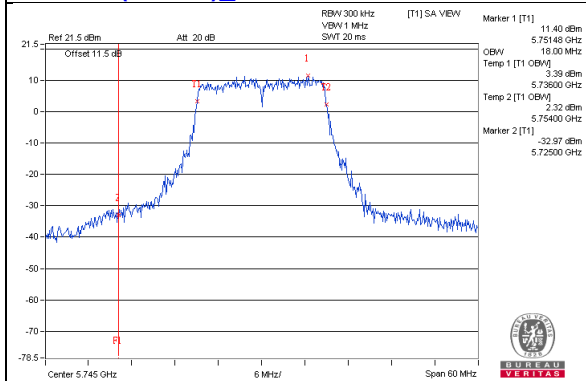

802.11ac(VHT20)_Chain1 / CH149

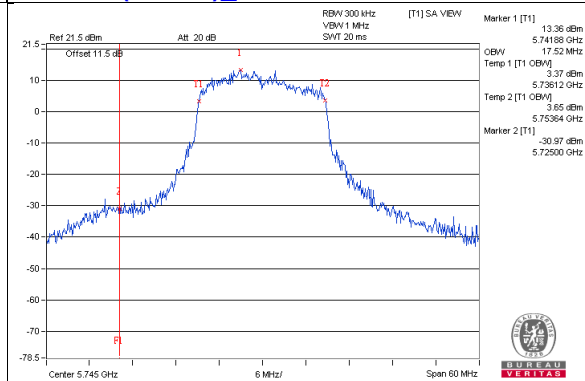

802.11ac(VHT20)_Chain2 / CH149

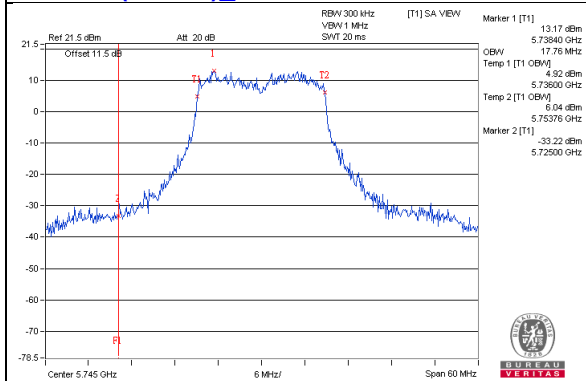

Spectrum Plot for near by DFS band (DFS is required, if 99% OCP straddle into U-NII-2C band)

802.11ac(VHT40)_Chain0 / CH151

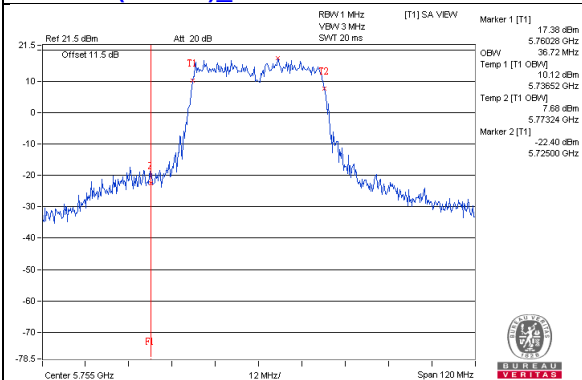

802.11ac(VHT40)_Chain1 / CH151

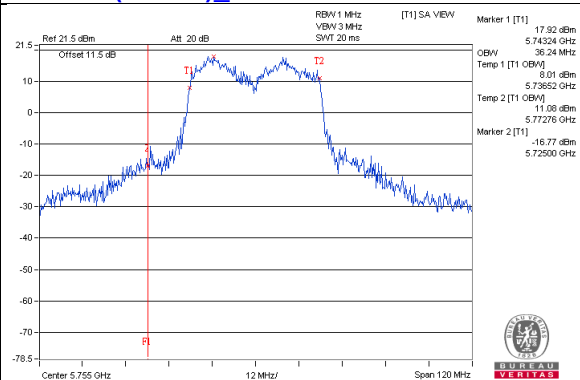

802.11ac(VHT40)_Chain2 / CH151

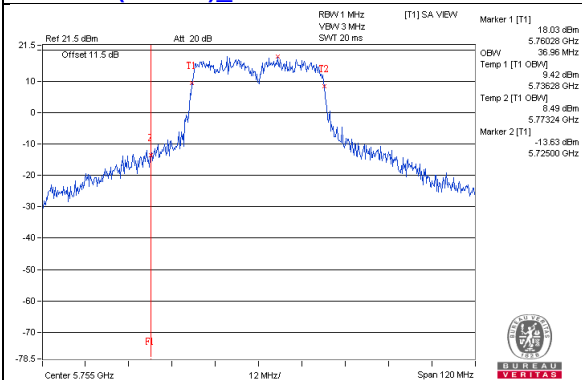

802.11ac(VHT80)_Chain0 / CH155

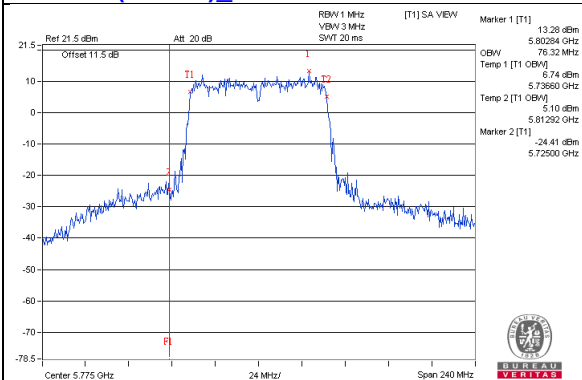

802.11ac(VHT80)_Chain1 / CH155

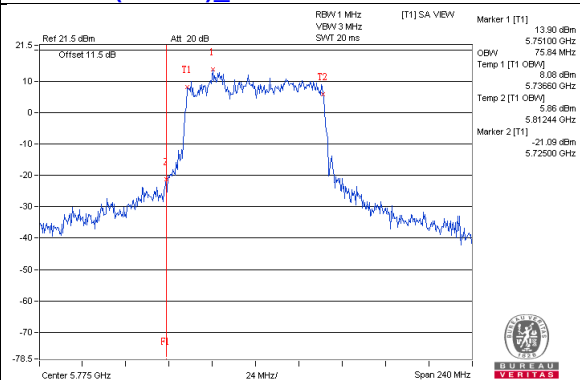

802.11ac(VHT80)_Chain2 / CH155

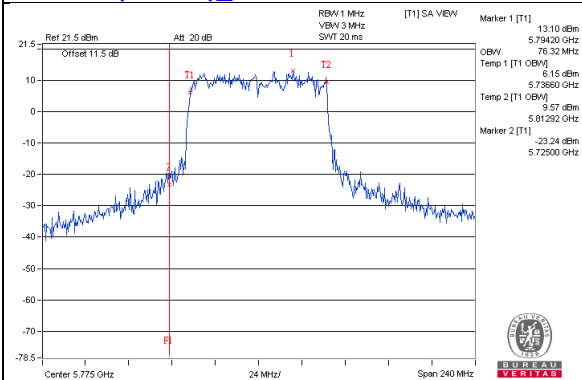

4.5 Peak Power Spectral Density Measurement

4.5.1 Limits of Peak Power Spectral Density Measurement

Operation Band	EUT Category		Limit
U-NII-1		Outdoor Access Point	17dBm/ MHz
		Fixed point-to-point Access Point	
	√	Indoor Access Point	
		Mobile and Portable client device	11dBm/ MHz
U-NII-2A			11dBm/ MHz
U-NII-2C			11dBm/ MHz
U-NII-3	√		30dBm/ 500kHz

4.5.2 Test Setup

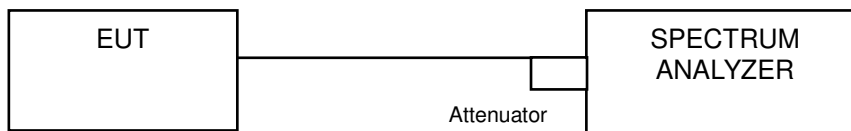

4.5.3 Test Instruments

DESCRIPTION & MANUFACTURER	MODEL NO.	SERIAL NO.	CALIBRATED DATE	CALIBRATED UNTIL
Spectrum Analyzer R&S	FSP40	100060	May 11, 2016	May 10, 2017

- NOTE:**
1. The test was performed in Oven room 2.
 2. The calibration interval of the above test instruments is 12 months and the calibrations are traceable to NML/ROC and NIST/USA.
 3. Tested Date: Nov. 09, 2016

4.5.4 Test Procedure

For U-NII-1:

Using method SA-2

1. Set span to encompass the entire emission bandwidth (EBW) of the signal.
2. Set RBW = 1 MHz, Set VBW \geq 3 MHz, Detector = RMS
3. Sweep time = auto, trigger set to "free run".
4. Trace average at least 100 traces in power averaging mode.
5. Record the max value and add 10 log (1/duty cycle)

For U-NII-3:

1. Set span to encompass the entire emission bandwidth (EBW) of the signal.
2. Set RBW = 300 kHz, Set VBW \geq 1 MHz, Detector = RMS
3. Use the peak marker function to determine the maximum power level in any 300 kHz band segment within the fundamental EBW.
4. Scale the observed power level to an equivalent value in 500 kHz by adjusting (reducing) the measured power by a bandwidth correction factor (BWCF) where $BWCF = 10\log(500 \text{ kHz}/300\text{kHz})$
5. Sweep time = auto, trigger set to "free run".
6. Trace average at least 100 traces in power averaging mode.
7. Record the max value and add 10 log (1/duty cycle)

4.5.5 Deviation from Test Standard

No deviation.

4.5.6 EUT Operating Condition

Same as Item 4.3.6.

4.5.7 Test Results

For U-NII-1:

802.11a

Chan.	Chan. Freq. (MHz)	PSD W/O Duty Factor (dBm/MHz)			Duty Factor (dB)	Total PSD With Duty Factor (dBm/MHz)	MAX. Limit (dBm/MHz)	Pass / Fail
		Chain 0	Chain 1	Chain 2				
36	5180	6.52	7.42	7.22	0.16	12.01	12.23	Pass
40	5200	7.47	6.85	6.80	0.16	11.99	12.23	Pass
48	5240	5.69	8.47	6.81	0.16	12.08	12.23	Pass

- Note:**
- Method a) of power density measurement of KDB 662911 is using for calculating total power density. Total power density is summing entire spectra across corresponding frequency bins on the various outputs by computer.
 - Directional gain = $6\text{dBi} + 10\log(3) = 10.77\text{dBi} > 6\text{dBi}$, so the power density limit shall be reduced to $17 - (10.77 - 6) = 12.23\text{dBm}$.
 - Refer to section 3.3 for duty cycle spectrum plot.

802.11ac (VHT20)

Chan.	Chan. Freq. (MHz)	PSD W/O Duty Factor (dBm/MHz)			Duty Factor (dB)	Total PSD With Duty Factor (dBm/MHz)	MAX. Limit (dBm/MHz)	Pass / Fail
		Chain 0	Chain 1	Chain 2				
36	5180	7.22	7.85	6.05	0.17	12.04	12.23	Pass
40	5200	7.56	8.09	5.60	0.17	12.15	12.23	Pass
48	5240	7.10	7.08	7.48	0.17	12.17	12.23	Pass

- Note:**
- Method a) of power density measurement of KDB 662911 is using for calculating total power density. Total power density is summing entire spectra across corresponding frequency bins on the various outputs by computer.
 - Directional gain = $6\text{dBi} + 10\log(3) = 10.77\text{dBi} > 6\text{dBi}$, so the power density limit shall be reduced to $17 - (10.77 - 6) = 12.23\text{dBm}$.
 - Refer to section 3.3 for duty cycle spectrum plot.

802.11ac (VHT40)

Chan.	Chan. Freq. (MHz)	PSD W/O Duty Factor (dBm/MHz)			Duty Factor (dB)	Total PSD With Duty Factor (dBm/MHz)	MAX. Limit (dBm/MHz)	Pass / Fail
		Chain 0	Chain 1	Chain 2				
38	5190	-1.65	-1.81	-1.82	0.33	3.34	12.23	Pass
46	5230	7.74	2.06	7.00	0.33	11.32	12.23	Pass

- Note:**
- Method a) of power density measurement of KDB 662911 is using for calculating total power density. Total power density is summing entire spectra across corresponding frequency bins on the various outputs by computer.
 - Directional gain = $6\text{dBi} + 10\log(3) = 10.77\text{dBi} > 6\text{dBi}$, so the power density limit shall be reduced to $17 - (10.77 - 6) = 12.23\text{dBm}$.
 - Refer to section 3.3 for duty cycle spectrum plot.

802.11ac (VHT80)

Chan.	Chan. Freq. (MHz)	PSD W/O Duty Factor (dBm/MHz)			Duty Factor (dB)	Total PSD With Duty Factor (dBm/MHz)	MAX. Limit (dBm/MHz)	Pass / Fail
		Chain 0	Chain 1	Chain 2				
42	5210	-7.75	-4.67	-6.30	0.27	-1.02	12.23	Pass

- Note:**
- Method a) of power density measurement of KDB 662911 is using for calculating total power density. Total power density is summing entire spectra across corresponding frequency bins on the various outputs by computer.
 - Directional gain = $6\text{dBi} + 10\log(3) = 10.77\text{dBi} > 6\text{dBi}$, so the power density limit shall be reduced to $17 - (10.77 - 6) = 12.23\text{dBm}$.
 - Refer to section 3.3 for duty cycle spectrum plot.

Spectrum Plot of Worst Value

802.11a_Chain 1 / CH48

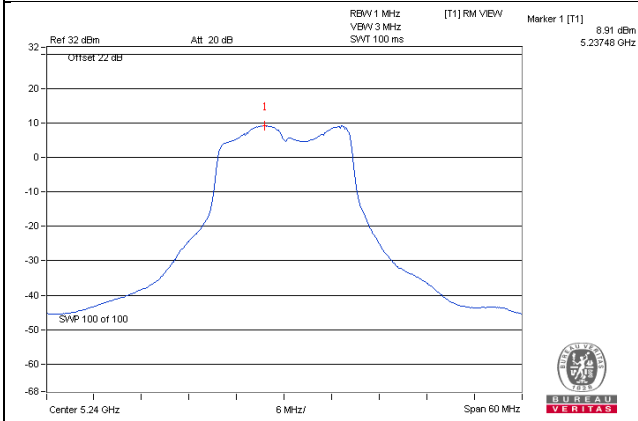

802.11ac (VHT20)_Chain 1 / CH40

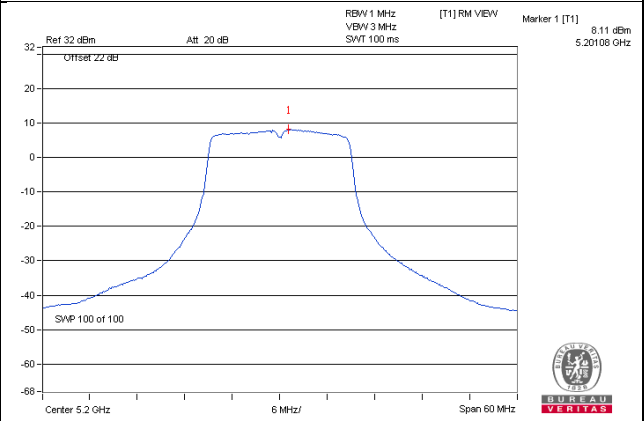

802.11ac (VHT40)_Chain 2 / CH46

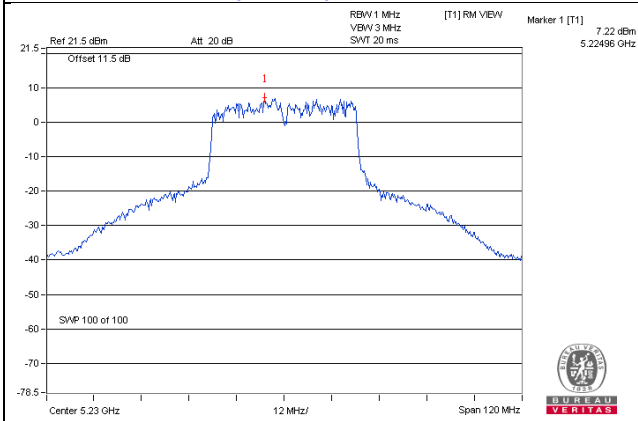

802.11ac (VHT80)_Chain 1 / CH42

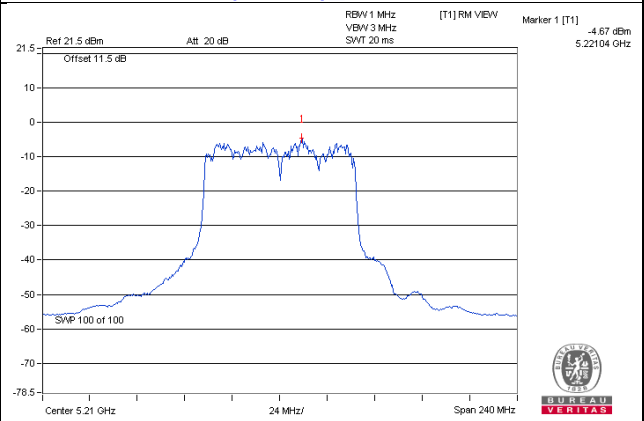

For U-NII-3:
802.11a

TX chain	Chan.	Chan. Freq. (MHz)	PSD W/O Duty Factor		10 log (N=3) dB	Duty Factor (dB)	Total PSD With Duty Factor (dBm/500kHz)	Limit (dBm/500kHz)	Pass /Fail
			(dBm/300kHz)	(dBm/500kHz)					
0	149	5745	-1.04	1.18	4.77	0.16	6.11	25.23	Pass
	157	5785	-1.66	0.56	4.77	0.16	5.49	25.23	Pass
	165	5825	-2.19	0.03	4.77	0.16	4.96	25.23	Pass
1	149	5745	1.98	4.20	4.77	0.16	9.13	25.23	Pass
	157	5785	-1.91	0.31	4.77	0.16	5.24	25.23	Pass
	165	5825	-1.39	0.83	4.77	0.16	5.76	25.23	Pass
2	149	5745	0.28	2.50	4.77	0.16	7.43	25.23	Pass
	157	5785	-1.21	1.01	4.77	0.16	5.94	25.23	Pass
	165	5825	-0.84	1.38	4.77	0.16	6.31	25.23	Pass

Note: 1. Directional gain = $6\text{dBi} + 10\log(3) = 10.77\text{dBi} > 6\text{dBi}$, so the power density limit shall be reduced to $30 - (10.77 - 6) = 25.23\text{dBm}$.

2. Refer to section 3.3 for duty cycle spectrum plot.

802.11ac (VHT20)

TX chain	Chan.	Chan. Freq. (MHz)	PSD W/O Duty Factor		10 log (N=3) dB	Duty Factor (dB)	Total PSD With Duty Factor (dBm/500kHz)	Limit (dBm/500kHz)	Pass /Fail
			(dBm/300kHz)	(dBm/500kHz)					
0	149	5745	-1.13	1.09	4.77	0.17	6.03	25.23	Pass
	157	5785	-1.72	0.50	4.77	0.17	5.44	25.23	Pass
	165	5825	-2.62	-0.40	4.77	0.17	4.54	25.23	Pass
1	149	5745	1.15	3.37	4.77	0.17	8.31	25.23	Pass
	157	5785	-1.57	0.65	4.77	0.17	5.59	25.23	Pass
	165	5825	-3.03	-0.81	4.77	0.17	4.13	25.23	Pass
2	149	5745	0.26	2.48	4.77	0.17	7.42	25.23	Pass
	157	5785	-0.54	1.68	4.77	0.17	6.62	25.23	Pass
	165	5825	-1.45	0.77	4.77	0.17	5.71	25.23	Pass

Note: 1. Directional gain = $6\text{dBi} + 10\log(3) = 10.77\text{dBi} > 6\text{dBi}$, so the power density limit shall be reduced to $30 - (10.77 - 6) = 25.23\text{dBm}$.

2. Refer to section 3.3 for duty cycle spectrum plot.

802.11ac (VHT40)

TX chain	Chan.	Chan. Freq. (MHz)	PSD W/O Duty Factor		10 log (N=3) dB	Duty Factor (dB)	Total PSD With Duty Factor (dBm/500kHz)	Limit (dBm/500kHz)	Pass /Fail
			(dBm/300kHz)	(dBm/500kHz)					
0	151	5755	-2.05	0.17	4.77	0.33	5.27	25.23	Pass
	159	5795	-2.60	-0.38	4.77	0.33	4.72	25.23	Pass
1	151	5755	-0.97	1.25	4.77	0.33	6.35	25.23	Pass
	159	5795	-1.07	1.15	4.77	0.33	6.25	25.23	Pass
2	151	5755	-0.92	1.30	4.77	0.33	6.40	25.23	Pass
	159	5795	-1.66	0.56	4.77	0.33	5.66	25.23	Pass

Note: 1. Directional gain = $6\text{dBi} + 10\log(3) = 10.77\text{dBi} > 6\text{dBi}$, so the power density limit shall be reduced to $30 - (10.77 - 6) = 25.23\text{dBm}$.

2. Refer to section 3.3 for duty cycle spectrum plot.

802.11ac (VHT80)

TX chain	Chan.	Chan. Freq. (MHz)	PSD W/O Duty Factor		10 log (N=3) dB	Duty Factor (dB)	Total PSD With Duty Factor (dBm/500kHz)	Limit (dBm/500kHz)	Pass /Fail
			(dBm/300kHz)	(dBm/500kHz)					
0	155	5775	-6.26	-4.04	4.77	0.27	1.00	25.23	Pass
1	155	5775	-5.36	-3.14	4.77	0.27	1.90	25.23	Pass
2	155	5775	-5.43	-3.21	4.77	0.27	1.83	25.23	Pass

Note: 1. Directional gain = $6\text{dBi} + 10\log(3) = 10.77\text{dBi} > 6\text{dBi}$, so the power density limit shall be reduced to $30 - (10.77 - 6) = 25.23\text{dBm}$.

2. Refer to section 3.3 for duty cycle spectrum plot.

Spectrum Plot of Worst Value

802.11a – Chain 1: CH 149

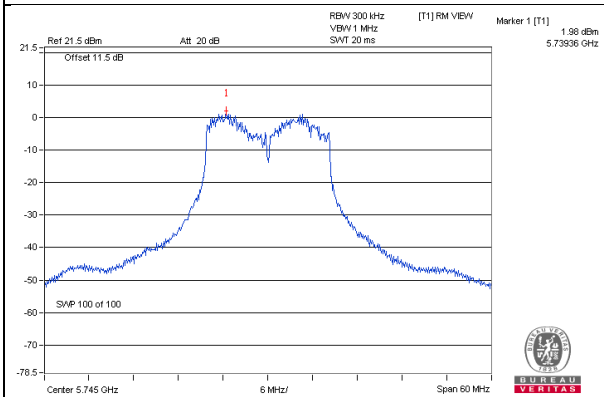

802.11ac (VHT20) – Chain 1: CH 149

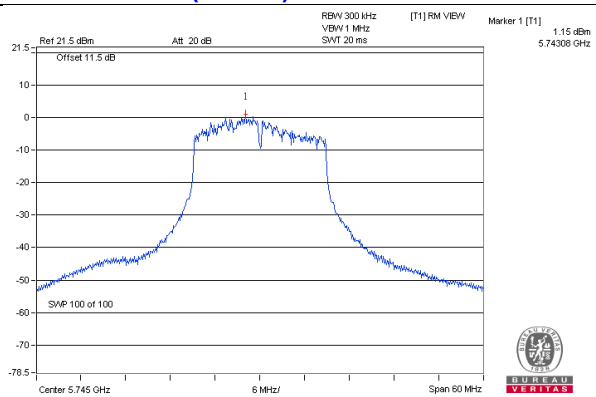

802.11ac (VHT40) – Chain 2: CH 151

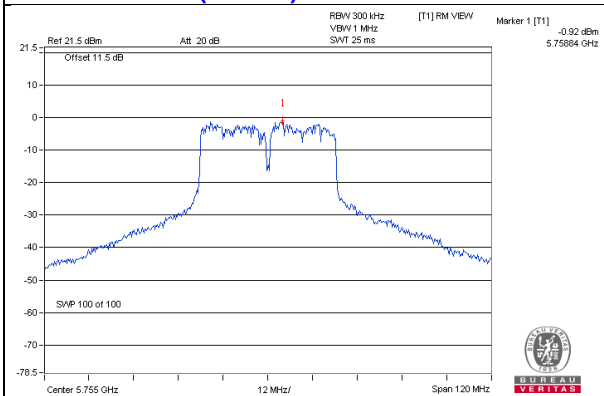

802.11ac (VHT80) – Chain 1: CH 155

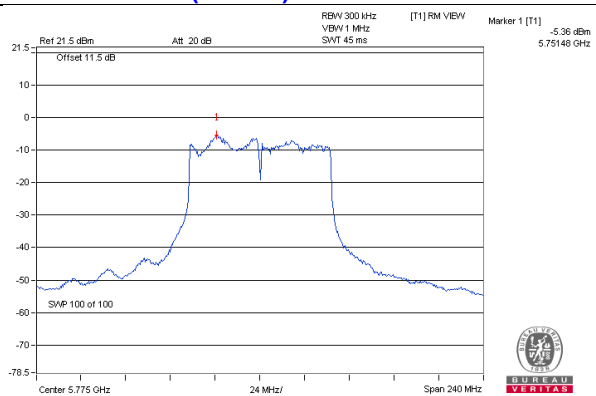

4.6 Frequency Stability Measurement

4.6.1 Limits of Frequency Stability Measurement

The frequency of the carrier signal shall be maintained within band of operation

4.6.2 Test Setup

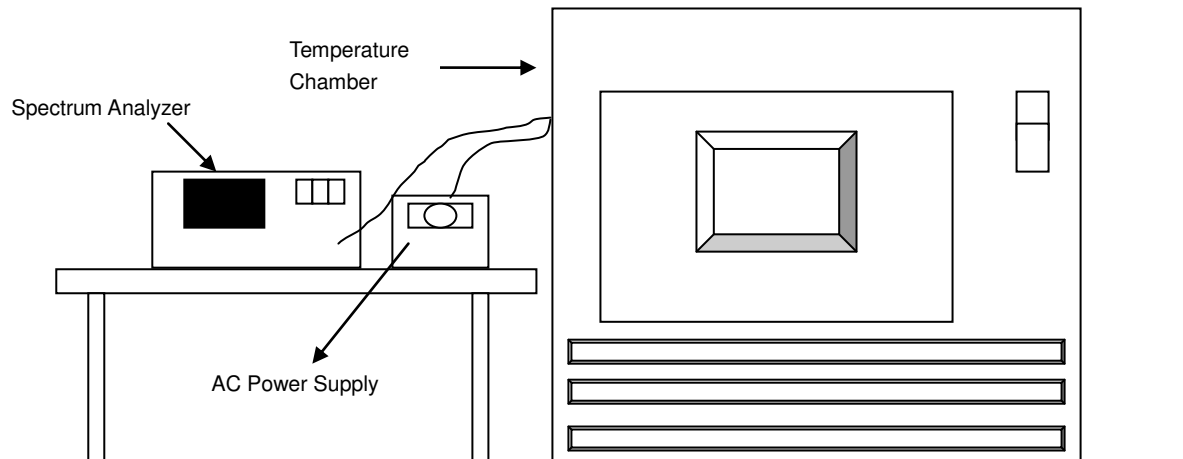

4.6.3 Test Instruments

DESCRIPTION & MANUFACTURER	MODEL NO.	SERIAL NO.	CALIBRATED DATE	CALIBRATED UNTIL
Spectrum Analyzer R&S	FSP40	100060	May 11, 2016	May 10, 2017
AC Power Source Extech Electronics	6205	1440452	NA	NA
Temperature & Humidity Chamber Giant Force	GTH-150-40-SP-AR	MAA0812-008	Jan. 15, 2016	Jan. 14, 2017
Digital Multimeter FLUKE	87III	73680266	Nov. 10, 2015	Nov. 09, 2016

- NOTE:**
1. The test was performed in Oven room 2.
 2. The calibration interval of the above test instruments is 12 months and the calibrations are traceable to NML/ROC and NIST/USA.
 3. Tested Date: Nov. 09, 2016

4.6.4 Test Procedure

- a. The EUT was placed inside the environmental test chamber and powered by nominal AC voltage.
- b. Turn the EUT on and couple its output to a spectrum analyzer.
- c. Turn the EUT off and set the chamber to the highest temperature specified.
- d. Allow sufficient time (approximately 30 min) for the temperature of the chamber to stabilize, turn the EUT on and measure the operating frequency after 2, 5, and 10 Minutes.
- e. Repeat step 2 and 3 with the temperature chamber set to the lowest temperature.
- f. The test chamber was allowed to stabilize at +20 degree C for a minimum of 30 Minutes. The supply voltage was then adjusted on the EUT from 85% to 115% and the frequency record.

4.6.5 Deviation from Test Standard

No deviation.

4.6.6 EUT Operating Condition

Set the EUT transmit at un-modulation mode to test frequency stability.

4.6.7 Test Results

Frequency Stability Versus Temp.									
Operating Frequency: 5180 MHz									
TEMP. (°C)	Power Supply (Vac)	0 Minute		2 Minute		5 Minute		10 Minute	
		Measured Frequency (MHz)	Pass/Fail	Measured Frequency (MHz)	Pass/Fail	Measured Frequency (MHz)	Pass/Fail	Measured Frequency (MHz)	Pass/Fail
50	120	5180.0016	Pass	5180.0006	Pass	5180.0034	Pass	5180.0006	Pass
40	120	5180.0179	Pass	5180.0146	Pass	5180.0185	Pass	5180.0154	Pass
30	120	5180.0042	Pass	5180.0064	Pass	5180.0052	Pass	5180.0055	Pass
20	120	5179.9756	Pass	5179.9773	Pass	5179.9762	Pass	5179.9766	Pass
10	120	5179.9869	Pass	5179.9863	Pass	5179.9852	Pass	5179.987	Pass
0	120	5180.0161	Pass	5180.0164	Pass	5180.016	Pass	5180.0118	Pass
-10	120	5179.9789	Pass	5179.9785	Pass	5179.9758	Pass	5179.977	Pass
-20	120	5179.986	Pass	5179.9856	Pass	5179.9871	Pass	5179.9854	Pass
-30	120	5180.0081	Pass	5180.0087	Pass	5180.0089	Pass	5180.0074	Pass

Frequency Stability Versus Voltage									
Operating Frequency: 5180 MHz									
TEMP. (°C)	Power Supply (Vac)	0 Minute		2 Minute		5 Minute		10 Minute	
		Measured Frequency (MHz)	Pass/Fail	Measured Frequency (MHz)	Pass/Fail	Measured Frequency (MHz)	Pass/Fail	Measured Frequency (MHz)	Pass/Fail
20	138	5179.9756	Pass	5179.9781	Pass	5179.9755	Pass	5179.9768	Pass
	120	5179.9756	Pass	5179.9773	Pass	5179.9762	Pass	5179.9766	Pass
	102	5179.976	Pass	5179.9781	Pass	5179.9767	Pass	5179.9761	Pass

4.7 6dB Bandwidth Measurement

4.7.1 Limits of 6dB Bandwidth Measurement

The minimum of 6dB Bandwidth Measurement is 0.5MHz.

4.7.2 Test Setup

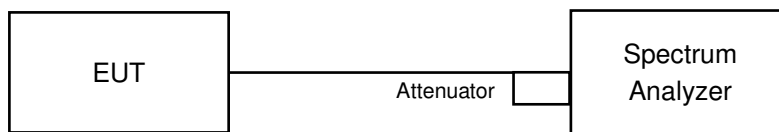

4.7.3 Test Instruments

DESCRIPTION & MANUFACTURER	MODEL NO.	SERIAL NO.	CALIBRATED DATE	CALIBRATED UNTIL
Spectrum Analyzer R&S	FSP40	100060	May 11, 2016	May 10, 2017

- NOTE:**
1. The test was performed in Oven room 2.
 2. The calibration interval of the above test instruments is 12 months and the calibrations are traceable to NML/ROC and NIST/USA.
 3. Tested Date: Nov. 09, 2016

4.7.4 Test Procedure

MEASUREMENT PROCEDURE REF

- a. Set resolution bandwidth (RBW) = 100kHz
- b. Set the video bandwidth (VBW) $\geq 3 \times$ RBW, Detector = Peak.
- c. Trace mode = max hold.
- d. Sweep = auto couple.
- e. Measure the maximum width of the emission that is constrained by the frequencies associated with the two amplitude points (upper and lower) that are attenuated by 6 dB relative to the maximum level measured in the fundamental emission

4.7.5 Deviation from Test Standard

No deviation.

4.7.6 EUT Operating Condition

The software provided by client to enable the EUT under transmission condition continuously at lowest, middle and highest channel frequencies individually.

4.7.7 Test Results

802.11a

Channel	Frequency (MHz)	6dB Bandwidth (MHz)			Minimum Limit (MHz)	Pass / Fail
		Chain 0	Chain 1	Chain 2		
149	5745	16.11	15.49	16.36	0.5	PASS
157	5785	16.39	15.74	16.41	0.5	PASS
165	5825	16.41	15.78	16.40	0.5	PASS

802.11ac (VHT20)

Channel	Frequency (MHz)	6dB Bandwidth (MHz)			Minimum Limit (MHz)	Pass / Fail
		Chain 0	Chain 1	Chain 2		
149	5745	17.39	15.74	16.97	0.5	PASS
157	5785	17.65	17.60	17.64	0.5	PASS
165	5825	17.59	17.33	17.37	0.5	PASS

802.11ac (VHT40)

Channel	Frequency (MHz)	6dB Bandwidth (MHz)			Minimum Limit (MHz)	Pass / Fail
		Chain 0	Chain 1	Chain 2		
151	5755	35.79	35.13	35.88	0.5	PASS
159	5795	36.15	32.08	35.87	0.5	PASS

802.11ac (VHT80)

Channel	Frequency (MHz)	6dB Bandwidth (MHz)			Minimum Limit (MHz)	Pass / Fail
		Chain 0	Chain 1	Chain 2		
155	5775	74.77	74.70	75.82	0.5	PASS

Spectrum Plot of Worst Value

802.11a_Chain 1 / CH149

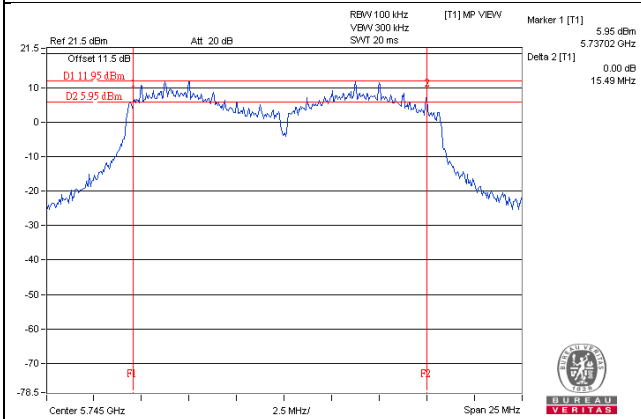

802.11ac (VHT20)_Chain 1 / CH149

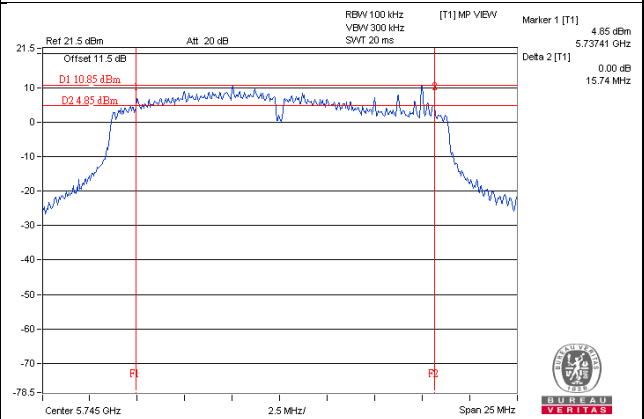

802.11ac (VHT40)_Chain 1 / CH159

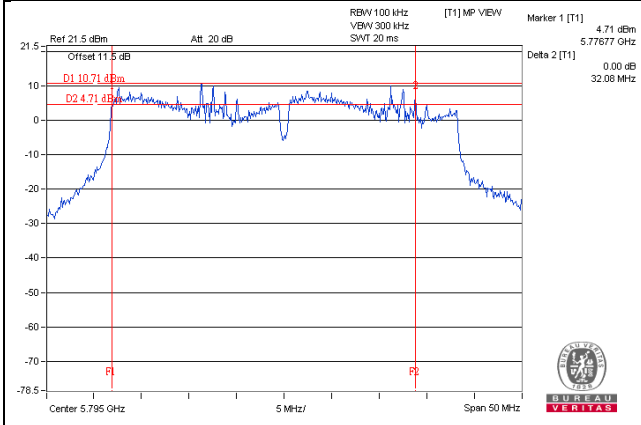

802.11ac (VHT80)_Chain 1 / CH155

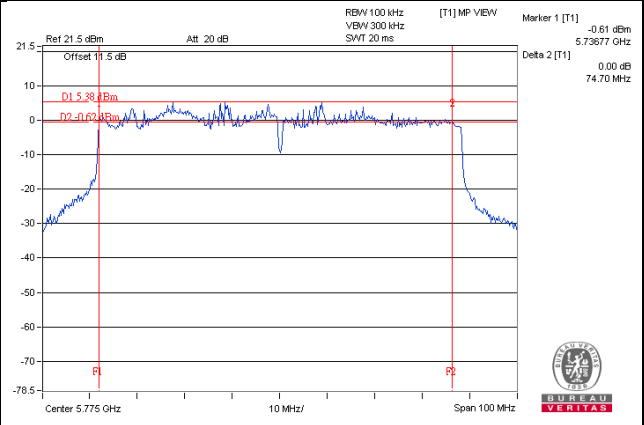

5 Pictures of Test Arrangements

Please refer to the attached file (Test Setup Photo).

Annex A- Radiated Out of Band Emission (OOBE) Measurement (For U-NII-3 band)

802.11a

CH 149 5745 MHz

Horizontal

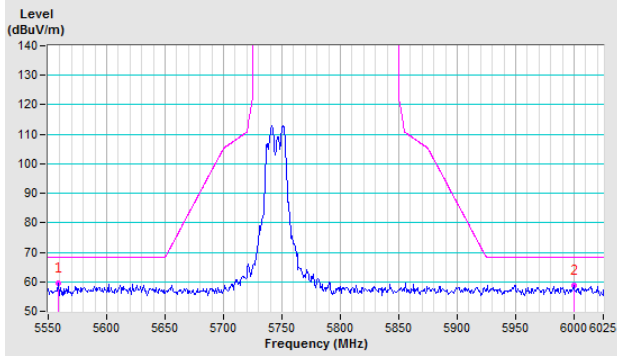

Vertical

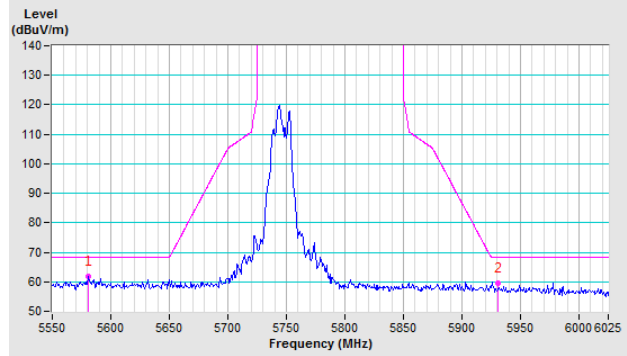

CH 157 5785 MHz

Horizontal

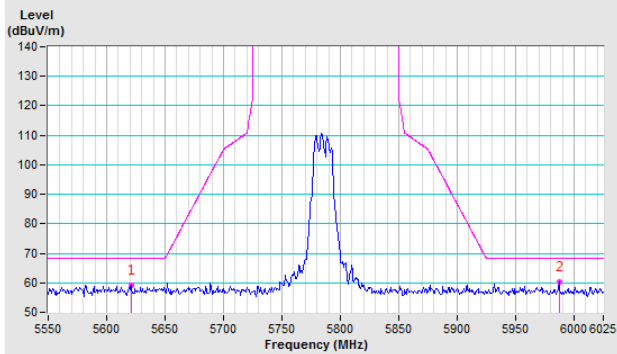

Vertical

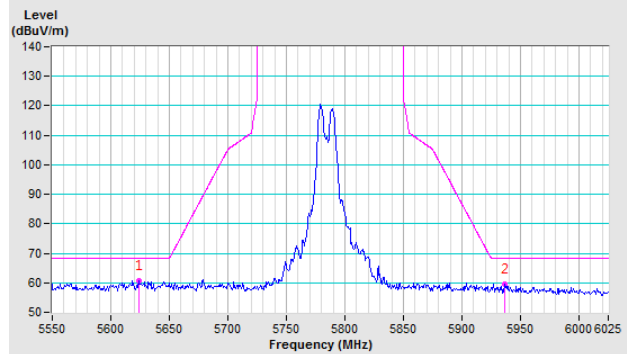

CH 165 5825 MHz

Horizontal

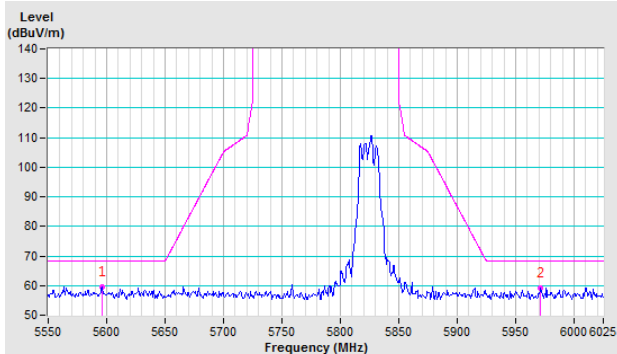

Vertical

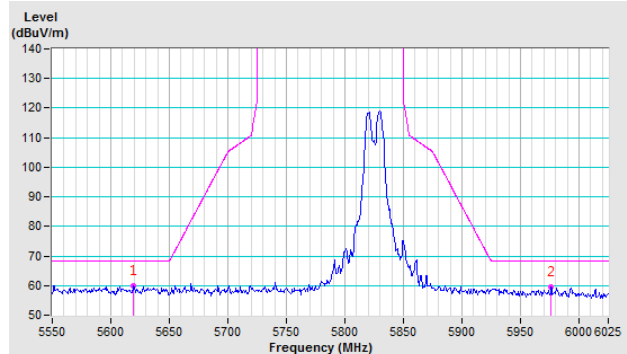

802.11ac (VHT20)

CH 149 5745 MHz

Horizontal

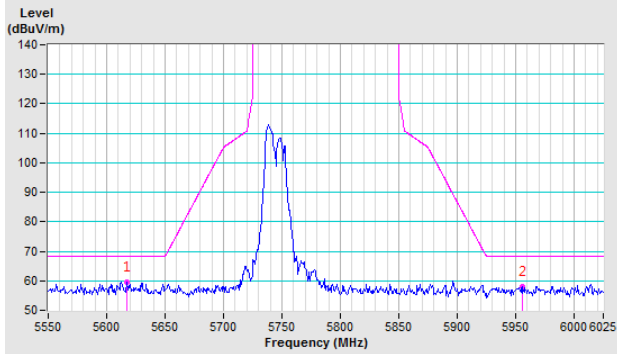

Vertical

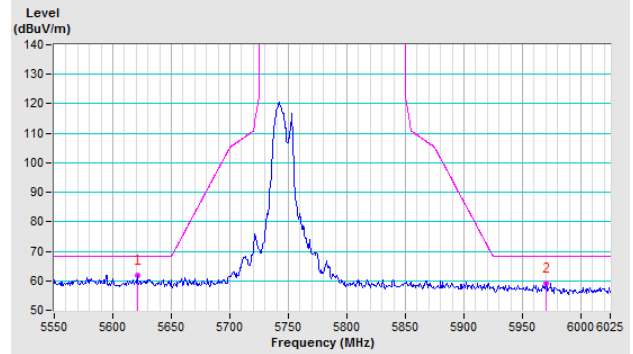

CH 157 5785 MHz

Horizontal

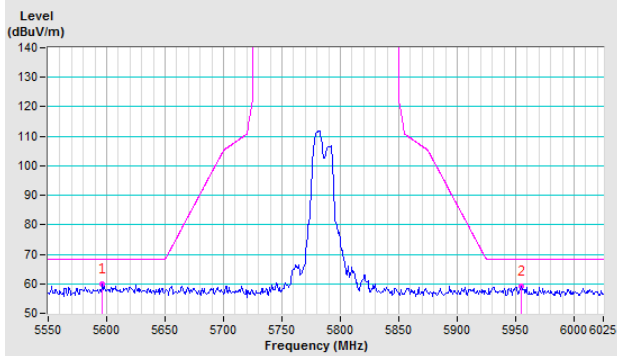

Vertical

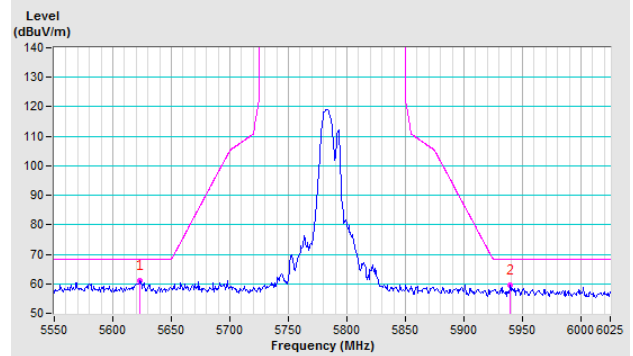

CH 165 5825 MHz

Horizontal

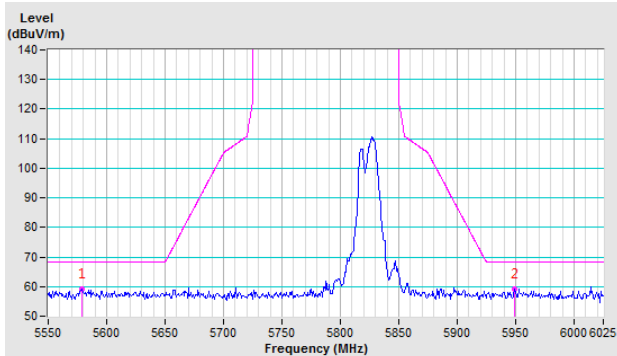

Vertical

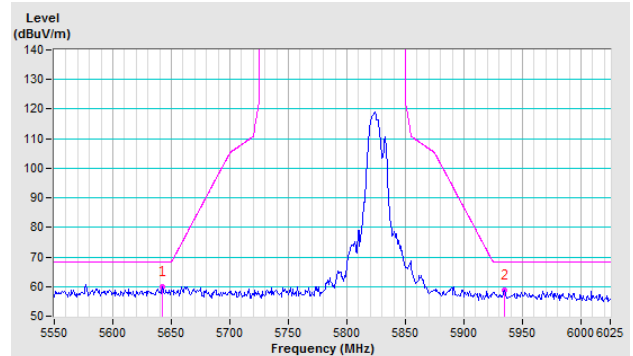

802.11ac (VHT40)

CH 151 5755 MHz

Horizontal

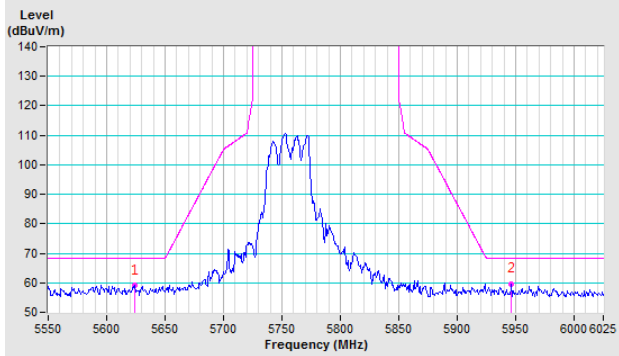

Vertical

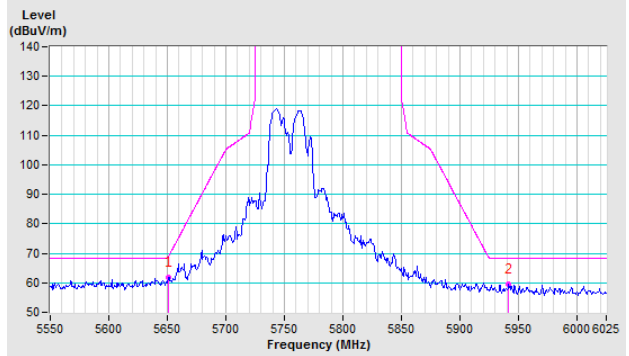

CH 159 5795 MHz

Horizontal

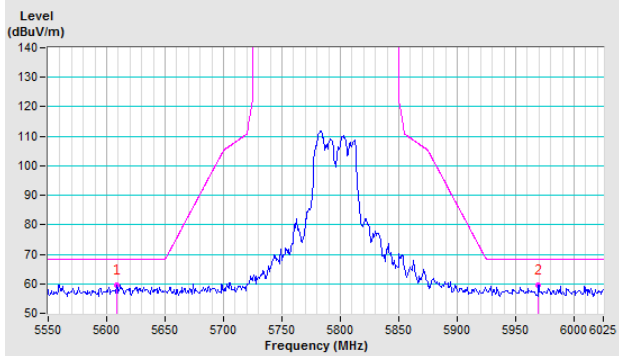

Vertical

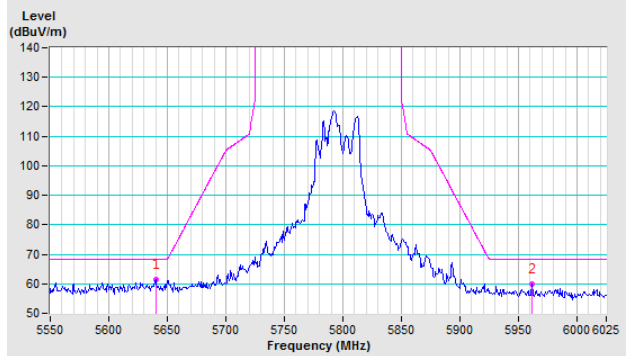

802.11ac (VHT80)

CH 155 5775 MHz

Horizontal

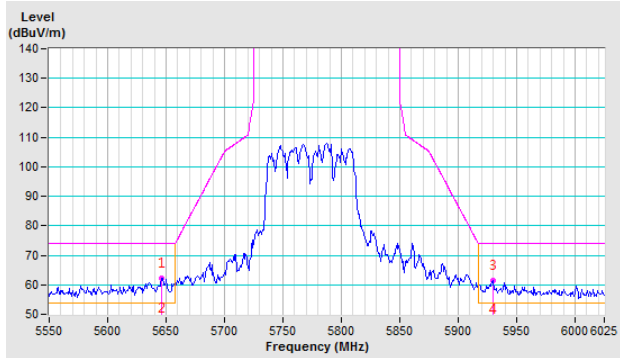

Vertical

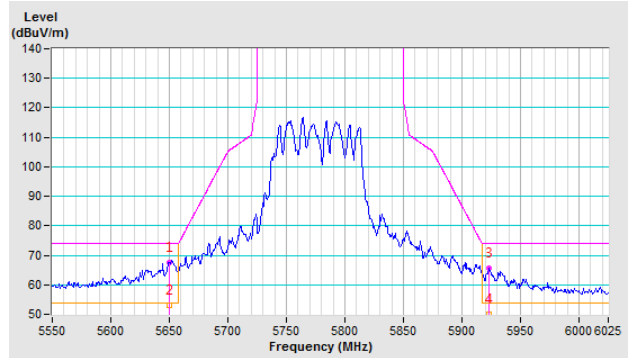

Appendix – Information on the Testing Laboratories

We, Bureau Veritas Consumer Products Services (H.K.) Ltd., Taoyuan Branch, were founded in 1988 to provide our best service in EMC, Radio, Telecom and Safety consultation. Our laboratories are accredited and approved according to ISO/IEC 17025.

If you have any comments, please feel free to contact us at the following:

Linko EMC/RF Lab

Tel: 886-2-26052180

Fax: 886-2-26051924

Hsin Chu EMC/RF/Telecom Lab

Tel: 886-3-6668565

Fax: 886-3-6668323

Hwa Ya EMC/RF/Safety Lab

Tel: 886-3-3183232

Fax: 886-3-3270892

Email: service.adt@tw.bureauveritas.com

Web Site: www.bureauveritas-adt.com

The address and road map of all our labs can be found in our web site also.

--- END ---