



FCC DFS TEST REPORT

FCC ID : MSQ-AXHZ00
Equipment : AX6600 Tri Band WiFi Router
Brand Name : ASUS
Model Name : RT-AX95Q, ZenWiFi XT8, ASUS ZenWiFi XT8, XT8, ASUS ZenWiFi
Applicant : ASUSTeK COMPUTER INC.
4F, No. 150, Li-Te Rd., Peitou, Taipei 112, Taiwan
Manufacturer (1) : Compal Networking (KunShan) Co., LTD.
No. 520, Nanbang Rd., Economic & Technical
Development Zone Kunshan, Jiangsu Province China
Manufacturer (2) : ARCADYAN TECHNOLOGY (VIETNAM) CO., LTD.
Ba Thien Industrial Park, Ba Hien commune, Binh
Xuyen district, Vinh Phuc Province
Standard : 47 CFR FCC Part 15.407

The product was received on May 15, 2019, and testing was started from Jun. 26, 2019 and completed on Aug. 23, 2019. We, SPORTON INTERNATIONAL INC. EMC & Wireless Communications Laboratory, would like to declare that the tested sample has been evaluated in accordance with the procedures given in FCC KDB 905462 D02 UNII DFS Compliance Procedures New Rules v02 and shown compliance with the applicable technical standards.

The report must not be used by the client to claim product certification, approval, or endorsement by TAF or any agency of government.

The test results in this report apply exclusively to the tested model / sample. Without written approval of SPORTON INTERNATIONAL INC. EMC & Wireless Communications Laboratory, the test report shall not be reproduced except in full.

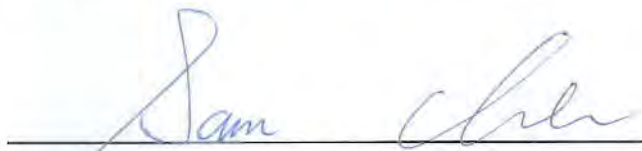
Approved by: Sam Chen

SPORTON INTERNATIONAL INC. EMC & Wireless Communications Laboratory
No. 52, Huaya 1st Rd., Guishan Dist., Taoyuan City, Taiwan (R.O.C.)



Table of Contents

History of this test report.....3

Summary of Test Result.....4

1 General Description5

1.1 Information.....5

1.2 Accessories11

1.3 Support Equipment.....11

1.4 Applicable Standards11

1.5 Testing Location Information.....12

2 Test Configuration of EUT.....13

2.1 Test Channel Frequencies Configuration.....13

2.2 The Worst Case Measurement Configuration.....13

3 Dynamic Frequency Selection (DFS) Test Result14

3.1 General DFS Information14

3.2 Radar Test Waveform Calibration.....17

3.3 UNII Detection Bandwidth30

3.4 Channel Availability Check (CAC).....36

3.5 In-service Monitoring40

3.6 Statistical Performance Check55

4 Test Equipment and Calibration Data186

5 Measurement Uncertainty187

Appendix A. Dynamic In-Service Monitoring Test (Zero-Wait CAC)

Appendix B. Test Photos

Photographs of EUT v01



Summary of Test Result

Report Clause	Ref Std. Clause	Test Items	Result (PASS/FAIL)	Remark
3.3	FCC KDB 905462 7.8.1	DFS: UNII Detection Bandwidth Measurement	PASS	-
3.4	FCC KDB 905462 7.8.2.1	DFS: Initial Channel Availability Check Time	PASS	-
3.4	FCC KDB 905462 7.8.2.2	DFS: Radar Burst at the Beginning of the Channel Availability Check Time	PASS	-
3.4	FCC KDB 905462 7.8.2.3	DFS: Radar Burst at the End of the Channel Availability Check Time	PASS	-
3.5	FCC KDB 905462 7.8.3	DFS: In-Service Monitoring for Channel Move Time (CMT)	PASS	-
3.5	FCC KDB 905462 7.8.3	DFS: In-Service Monitoring for Channel Closing Transmission Time (CCTT)	PASS	-
3.5	FCC KDB 905462 7.8.3	DFS: In-Service Monitoring for Non-Occupancy Period (NOP)	PASS	-
3.6	FCC KDB 905462 7.8.4	DFS: Statistical Performance Check	PASS	-
3.1.4	FCC KDB 905462 8.1	User Access Restrictions	PASS	-
Note: For Bridge mode, that is Slave without radar detection function, only Channel Move Time, Channel Closing Transmission Time and Non-Occupancy Period are required to perform.				

Declaration of Conformity:

The test results with all measurement uncertainty excluded are presented in accordance with the regulation limits or requirements declared by manufacturers.

Comments and Explanations:

The declared of product specification for EUT presented in the report are provided by the manufacturer, and the manufacturer takes all the responsibilities for the accuracy of product specification.

Reviewed by: Sam Chen

Report Producer: Viola Huang



1 General Description

1.1 Information

1.1.1 RF General Information

Specification Items	Description
Frequency Range	5470 MHz – 5725 MHz
Power Type	From power adapter
Channel Bandwidth	20/40/80/160 MHz operating channel bandwidth
Operating Mode	<input checked="" type="checkbox"/> Master (AP Router, Mesh, Repeater)
	<input type="checkbox"/> Client with radar detection
	<input checked="" type="checkbox"/> Client without radar detection (Bridge)
Communication Mode	<input checked="" type="checkbox"/> IP Based (Load Based) <input type="checkbox"/> Frame Based
TPC Function	<input checked="" type="checkbox"/> With TPC <input type="checkbox"/> Without TPC
Weather Band (5600~5650MHz)	<input checked="" type="checkbox"/> With 5600~5650MHz <input type="checkbox"/> Without 5600~5650MHz
Power-on cycle	For Master-AP Router mode 160MHz: Requires 30.435 seconds to complete its power-on cycle. For Slave without radar detection-Bridge mode NA (No Channel Availability Check Function)
Software / Firmware Version	3.0.0.4.348_6450-ge312cee
<ul style="list-style-type: none"> ♦ 11a, HT20 and HT40 use a combination of OFDM-BPSK, QPSK, 16QAM, 64QAM modulation. ♦ VHT20, VHT40, VHT80 and VHT160 use a combination of OFDM-BPSK, QPSK, 16QAM, 64QAM, 256QAM, 1024QAM modulation. ♦ HEW20, HEW40, HEW80 and HEW160 use a combination of OFDMA-BPSK, QPSK, 16QAM, 64QAM, 256QAM, 1024QAM modulation. ♦ EUT employ a TPC mechanism and TPC have the capability to operate at least 6 dB below highest RF output power. 	

Note: The above information was declared by manufacturer.



TPC Power Result
For 4T1S

Mode	Min Power (dBm)	Max Power (dBm)	Min EIRP (dBm)	Max EIRP (dBm)
802.11a_Nss1,(6Mbps)_4TX	-	-	-	-
5.47-5.725GHz	16.18	22.18	18.40	24.40
802.11ax HEW20-BF_Nss1,(MCS0)_4TX	-	-	-	-
5.47-5.725GHz	15.89	21.89	23.96	29.96
802.11ax HEW40-BF_Nss1,(MCS0)_4TX	-	-	-	-
5.47-5.725GHz	15.84	21.84	23.91	29.91
802.11ax HEW80-BF_Nss1,(MCS0)_4TX	-	-	-	-
5.47-5.725GHz	15.86	21.86	23.93	29.93
802.11ax HEW160-BF_Nss1,(MCS0)_4TX	-	-	-	-
5.47-5.725GHz	15.75	21.75	23.82	29.82

For 4T2S

Mode	Min Power (dBm)	Max Power (dBm)	Min EIRP (dBm)	Max EIRP (dBm)
802.11ax HEW20-BF_Nss2,(MCS0)_4TX	-	-	-	-
5.47-5.725GHz	17.95	23.95	23.17	29.17
802.11ax HEW40-BF_Nss2,(MCS0)_4TX	-	-	-	-
5.47-5.725GHz	17.90	23.90	23.12	29.12
802.11ax HEW80-BF_Nss2,(MCS0)_4TX	-	-	-	-
5.47-5.725GHz	17.89	23.89	23.11	29.11
802.11ax HEW160-BF_Nss2,(MCS0)_4TX	-	-	-	-
5.47-5.725GHz	17.91	23.91	23.13	29.13



1.1.2 Antenna Information

Set	Ant.	Brand	P/N	Antenna Type	Connector	Gain (dBi)
1	1	PSA	RFDPA230508IMLB902	Dipole Antenna	I-PEX	Note 1
	2	PSA	RFDPA230508IMLB902	Dipole Antenna	I-PEX	
	3	PSA	RFDPA230508IMLB902	Dipole Antenna	I-PEX	
	4	PSA	RFDPA230508IMLB902	Dipole Antenna	I-PEX	
	5	PSA	RFDPA230508IMLB902	Dipole Antenna	I-PEX	
	6	PSA	RFDPA230508IMLB902	Dipole Antenna	I-PEX	
2	1	M.gear	C660-510484-A	Dipole Antenna	I-PEX	
	2	M.gear	C660-510484-A	Dipole Antenna	I-PEX	
	3	M.gear	C660-510484-A	Dipole Antenna	I-PEX	
	4	M.gear	C660-510484-A	Dipole Antenna	I-PEX	
	5	M.gear	C660-510484-A	Dipole Antenna	I-PEX	
	6	M.gear	C660-510484-A	Dipole Antenna	I-PEX	
3	7	YAGEO	ANT3216A063R2400A	Chip Antenna	N/A	

Note 1:

Gain (dBi) - CDD mode for output power										
Set	Ant.	Port				2.4GHz	5GHz Band 1	5GHz Band 3	5GHz Band 4	Bluetooth
		2.4G 2TX	5G 2TX	5G 4TX	Bluetooth 1TX					
1	1	1	1	-	-	1.82	3.08	-	-	-
	2	2	2	-	-	1.82	3.08	-	-	-
	3	-	-	2	-	-	-	2.22	2.23	-
	4	-	-	3	-	-	-	2.22	2.23	-
	5	-	-	1	-	-	-	2.22	2.23	-
	6	-	-	4	-	-	-	2.22	2.23	-
2	1	-	-	-	-	1.82	3.08	-	-	-
	2	-	-	-	-	1.82	3.08	-	-	-
	3	-	-	-	-	-	-	2.22	2.23	-
	4	-	-	-	-	-	-	2.22	2.23	-
	5	-	-	-	-	-	-	2.22	2.23	-
	6	-	-	-	-	-	-	2.22	2.23	-
3	1	-	-	-	1	-	-	-	-	2.02



Gain (dBi) - Beamforming mode for output power & PSD, CDD mode for PSD												
Set	Ant.	Port				2.4GHz	5GHz Band 1	5GHz Band 3		5GHz Band 4		Bluetooth
		2.4G 2TX	5G 2TX	5G 4TX	Bluetooth 1TX			4T1S	4T2S	4T1S	4T2S	
1	1	1	1	-	-	4.70	5.99	-	-	-	-	-
	2	2	2	-	-	4.70	5.99	-	-	-	-	-
	3	-	-	2	-	-	-	8.07	5.22	8.21	5.23	-
	4	-	-	3	-	-	-	8.07	5.22	8.21	5.23	-
	5	-	-	1	-	-	-	8.07	5.22	8.21	5.23	-
	6	-	-	4	-	-	-	8.07	5.22	8.21	5.23	-
2	1	-	-	-	-	4.70	5.99	-	-	-	-	-
	2	-	-	-	-	4.70	5.99	-	-	-	-	-
	3	-	-	-	-	-	-	8.07	5.22	8.21	5.23	-
	4	-	-	-	-	-	-	8.07	5.22	8.21	5.23	-
	5	-	-	-	-	-	-	8.07	5.22	8.21	5.23	-
	6	-	-	-	-	-	-	8.07	5.22	8.21	5.23	-

Note 2: The EUT has three sets of antennas and there are six antennas for set 1 and set 2.

Set 1~2 are the same antenna type. Only Set 1 antenna was selected to test and record in this report.

For 2.4GHz WLAN function (Radio 1)

IEEE 802.11b/g/n/VHT/ax mode (2TX/2RX):

Port 1 and port 2 can be used as transmitting/receiving antenna.

Port 1 and port 2 could transmit/receive simultaneously.

For 5GHz Band 1 WLAN function (Radio 1)

IEEE 802.11a/n/ac/ax mode (2TX/2RX):

Port 1 and port 2 can be used as transmitting/receiving antenna.

Port 1 and port 2 could transmit/receive simultaneously.

For 5GHz Band 3~Band 4 WLAN function (Radio 2)

IEEE 802.11a/n/ac/ax mode (4TX/4RX):

Port 1, port 2, port 3 and port 4 can be used as transmitting/receiving antenna.

Port 1, port 2, port 3 and port 4 could transmit/receive simultaneously.

For Bluetooth function (Radio 3)

Only Port 1 can be used as transmitting/receiving antenna.



1.1.3 DFS Band Carrier Frequencies

There are four bandwidth systems.

For 20MHz bandwidth systems, use Channel 100, 104, 108, 112, 116, 120, 124, 128, 132, 136, 140, 144.

For 40MHz bandwidth systems, use Channel 102, 110, 118, 126, 134, 142.

For 80MHz bandwidth systems, use Channel 106, 122, 138.

For 160MHz bandwidth systems, use Channel 114

Frequency Band	Channel No.	Frequency	Channel No.	Frequency
5470~5725 MHz Band 3	100	5500 MHz	122	5610 MHz
	102	5510 MHz	124	5620 MHz
	104	5520 MHz	126	5630 MHz
	106	5530 MHz	128	5640 MHz
	108	5540 MHz	132	5660 MHz
	110	5550 MHz	134	5670 MHz
	112	5560 MHz	136	5680 MHz
	114	5570 MHz	138	5690 MHz
	116	5580 MHz	140	5700 MHz
	118	5590 MHz	142	5710 MHz
	120	5600 MHz	144	5720 MHz



1.1.4 Table for Multiple Listing

The five model names in the following table are all refer to the identical product.

Brand Name	Model Name	Description
ASUS	RT-AX95Q	All the models are identical, the different model names served as marketing strategy.
	ZenWiFi XT8	
	ASUS ZenWiFi XT8	
	XT8	
	ASUS ZenWiFi	

From the above models, model: RT-AX95Q was selected as representative model for the test and its data was recorded in this report.

1.1.5 Table for SKU information

EUT No.	SKU No.	Brand Name	P/N
1	SKU 1	NETSWAP	NS773602 / NS771802
2	SKU 2	Mingtek	HN36201CG / HN18101CG

1.1.6 Table for radio information

Radio	2.4GHz	5GHz	Bluetooth
1	V	V (Band 1)	X
2	X	V (Band 3~Band 4)	X
3	X	X	V

1.1.7 Table for EUT supports functions

Function	Support Type
AP Router	Master
Bridge	Slave without radar detection
Repeater	Master
Mesh	Master

Note: After evaluating, there are only Master-AP Router and Slave without radar detection-Bridge were selected to test and record in the report.



1.2 Accessories

Accessories				
Equipment Name	Brand Name	Model Name	Type	Rating
Adapter	PI	AD2088320	010LF	INPUT: 100-240V ~ 50/60Hz, 0.8A OUTPUT: 19V, 1.75A
Other				
RJ-45 cable*1: Non-shielded, 1.5m				

1.3 Support Equipment

For Master-AP Router mode

Support Equipment				
No.	Equipment	Brand Name	Model Name	FCC ID
A	Notebook	DELL	E4300	N/A
B	Notebook	DELL	E4300	N/A
C	WLAN AP	ASUS	MAP-AX6600	N/A

For Slave without radar detection-Bridge mode

Support Equipment				
No.	Equipment	Brand Name	Model Name	FCC ID
A	Notebook	DELL	E4300	N/A
B	Notebook	DELL	E4300	N/A
C	WLAN AP	ASUS	RT-AX95Q	N/A

1.4 Applicable Standards

According to the specifications of the manufacturer, the EUT must comply with the requirements of the following standards:

- ♦ FCC KDB 905462 D02 UNII DFS Compliance Procedures New Rules v02



1.5 Testing Location Information

Testing Location				
<input type="checkbox"/>	HWA YA	ADD : No. 52, Huaya 1st Rd., Guishan Dist., Taoyuan City, Taiwan (R.O.C.) TEL : 886-3-327-3456 FAX : 886-3-327-0973		
<input checked="" type="checkbox"/>	JHUBEI	ADD : No.8, Lane 724, Bo-ai St., Jhubei City, HsinChu County 302, Taiwan, R.O.C. TEL : 886-3-656-9065 FAX : 886-3-656-9085		
Test Condition	Test Site No.	Test Engineer	Test Environment	Test Date
DFS Site	DF01-CB	For Master:Benson Su	22~24°C / 50~60%	26-Jun-19 ~ 23-Aug-19
		For Slave without radar detection: Kevin Huang	24.6~26.2°C / 60~64%	13-Jul-19

Test site Designation No. TW0006 with FCC
Test site registered number IC 4086B with Industry Canada.



2 Test Configuration of EUT

2.1 Test Channel Frequencies Configuration

Test Channel Frequencies Configuration	
IEEE Std.	Test Channel Freq. (MHz)
802.11ac (VHT20)	5500 MHz
802.11ac (VHT40)	5510 MHz
802.11ac (VHT80)	5530 MHz
802.11ac (VHT160), 802.11ax (HEW160)	5570 MHz

2.2 The Worst Case Measurement Configuration

The Worst Case Mode for Following Conformance Tests	
Tests Item	Dynamic Frequency Selection (DFS)
Test Condition	Radiated measurement The EUT shall be configured to operate at the highest transmitter output power setting. If more than one antenna assembly is intended for this power setting, the gain of the antenna assembly with the lowest gain shall be used. The DFS radar test signals have been aligned to the direction corresponding to the EUT's maximum antenna gain.
Modulation Mode	1 Master-AP Router mode 802.11ac (VHT20), 802.11ac (VHT40), 802.11ac (VHT80), 802.11ac (VHT160), 802.11ax (HEW160)
	2 Slave without radar detection-Bridge mode 802.11ax (HEW160)

Note:The EUT can only use Y axis position.



3 Dynamic Frequency Selection (DFS) Test Result

3.1 General DFS Information

3.1.1 DFS Parameters

Table D.1: DFS requirement values	
Parameter	Value
Non-occupancy period	Minimum 30 minutes
Channel Availability Check Time	60 seconds
Channel Move Time	10 seconds (Note 1).
Channel Closing Transmission Time	200 milliseconds + an aggregate of 60 milliseconds over remaining 10 second periods. (Notes 1 and 2).
U-NII Detection Bandwidth	Minimum 100% of the 99% power bandwidth (Note 3).

Note 1: Channel Move Time and the Channel Closing Transmission Time should be performed with Radar Type 0. The measurement timing begins at the end of the Radar Type 0 burst.

Note 2: The Channel Closing Transmission Time is comprised of 200 milliseconds starting at the beginning of the Channel Move Time plus any additional intermittent control signals required to facilitate Channel changes (an aggregate of 60 milliseconds) during the remainder of the 10 second period. The aggregate duration of control signals will not count quiet periods in between transmissions.

Note 3: During the U-NII Detection Bandwidth detection test, radar type 0 is used and for each frequency step the minimum percentage of detection is 90%. Measurements are performed with no data traffic.

Table D.2: Interference threshold values	
Maximum Transmit Power	Value (see note)
EIRP ≥ 200 mW	-64 dBm
EIRP < 200 mW and PSD < 10dBm/MHz	-62 dBm
EIRP < 200 mW and PSD ≥ 10dBm/MHz	-64 dBm

Note 1: This is the level at the input of the receiver assuming a 0 dBi receive antenna.

Note 2: Throughout these test procedures an additional 1 dB has been added to the amplitude of the test transmission waveforms to account for variations in measurement equipment. This will ensure that the test signal is at or above the detection threshold level to trigger a DFS response.

Note3: EIRP is based on the highest antenna gain. For MIMO devices refer to KDB Publication 662911D01.



3.1.2 Applicability of DFS Requirements Prior to Use of a Channel

Requirement	DFS Operational mode		
	Master	Slave without radar detection	Client with radar detection
<i>Non-Occupancy Period</i>	Yes	Not required	Yes
<i>DFS Detection Threshold</i>	Yes	Not required	Yes
<i>Channel Availability Check Time</i>	Yes	Not required	Not required
<i>U-NII Detection Bandwidth</i>	Yes	Not required	Yes

3.1.3 Applicability of DFS Requirements during Normal Operation

Requirement	DFS Operational mode		
	Master	Slave without radar detection	Client with radar detection
<i>DFS Detection Threshold</i>	Yes	Not required	Yes
<i>Channel Closing Transmission Time</i>	Yes	Yes	Yes
<i>Channel Move Time</i>	Yes	Yes	Yes
<i>U-NII Detection Bandwidth</i>	Yes	Not required	Yes

Additional requirements for devices with multiple bandwidth modes	Master Device or Client with Radar Detection	Slave without radar detection
U-NII Detection Bandwidth and Statistical Performance Check	All BW modes must be tested	Not required
Channel Move Time and Channel Closing Transmission Time	Test using widest BW mode available	Test using the widest BW mode available for the link
All other tests	Any single BW mode	Not required

Note: Frequencies selected for statistical performance check (Section 7.8.4) should include several frequencies within the radar detection bandwidth and frequencies near the edge of the radar detection bandwidth. For 802.11 devices it is suggested to select frequencies in each of the bonded 20 MHz channels and the channel center frequency.



3.1.4 User Access Restrictions

User Access Restrictions	
<input checked="" type="checkbox"/>	DFS controls (hardware or software) related to radar detection are NOT accessible to the user. Manufacturer statement confirming that information regarding the parameters of the detected Radar Waveforms is not available to the end user.

3.1.5 Channel Loading/Data Streaming

<input type="checkbox"/>	The data file (MPEG-4) has been transmitting in a streaming mode.
<input checked="" type="checkbox"/>	Software to ping the client is permitted to simulate data transfer with random ping intervals.
<input checked="" type="checkbox"/>	Minimum channel loading of approximately 17%.
<input type="checkbox"/>	Unicast protocol has been used.



3.2 Radar Test Waveform Calibration

3.2.1 Short Pulse Radar Test Waveforms

Radar Type	Pulse Width (µsec)	PRI (µsec)	Number of Pulses	Minimum Percentage of Successful Detection	Minimum Trials
0	1	1428	18	See Note 1	See Note 1
1A	1	15 unique PRI in KDB 905462 D02 Table 5a	$\text{Roundup}\left\{\left(\frac{1}{360}\right) \times \left(\frac{19 \times 10^6}{PRI}\right)\right\}$	60%	15
1B	1	15 unique PRI within 518-3066, Excluding 1A PRI		60%	15
2	1-5	150-230	23-29	60%	30
3	6-10	200-500	16-18	60%	30
4	11-20	200-500	12-16	60%	30
Aggregate (Radar Types 1-4)				80%	120
Note 1: Short Pulse Radar Type 0 should be used for the detection bandwidth test, channel move time, and channel closing time tests.					

A minimum of 30 unique waveforms are required for each of the short pulse radar types 1 through 4. If more than 30 waveforms are used for short pulse radar types 1 through 4, then each additional waveform must also be unique and not repeated from the previous waveforms. The aggregate is the average of the percentage of successful detections of short pulse radar types 1-4.

3.2.2 Long Pulse Radar Test Waveform

Radar Type	Pulse Width (µsec)	Chirp Width (MHz)	PRI (µsec)	Number of Pulses per Burst	Number of Bursts	Minimum Percentage of Successful Detection	Minimum Trials
5	50-100	5-20	1000-2000	1-3	8-20	80%	30

Each waveform is defined as follows:

- The transmission period for the Long Pulse Radar test signal is 12 seconds.
- There are a total of 8 to 20 Bursts in the 12 second period, with the number of Bursts being randomly chosen. This number is Burst Count.
- Each Burst consists of 1 to 3 pulses, with the number of pulses being randomly chosen. Each Burst within the 12 second sequence may have a different number of pulses.
- The pulse width is between 50 and 100 microseconds, with the pulse width being randomly chosen. Each pulse within a Burst will have the same pulse width. Pulses in different Bursts may have different pulse widths.
- Each pulse has a linear FM chirp between 5 and 20 MHz, with the chirp width being randomly chosen. Each pulse within a transmission period will have the same chirp width. The chirp is centered on the pulse. For



example, with a radar frequency of 5300 MHz and a 20 MHz chirped signal, the chirp starts at 5290 MHz and ends at 5310 MHz.

- ♦ If more than one pulse is present in a Burst, the time between the pulses will be between 1000 and 2000 microseconds, with the time being randomly chosen. If three pulses are present in a Burst, the time between the first and second pulses is chosen independently of the time between the second and third pulses.
- ♦ The 12 second transmission period is divided into even intervals. The number of intervals is equal to Burst Count. Each interval is of length (12,000,000 / Burst Count) microseconds. Each interval contains one Burst. The start time for the Burst, relative to the beginning of the interval, is between 1 and [(12,000,000 / Burst Count) - (Total Burst Length) + (One Random PRI Interval)] microseconds, with the start time being randomly chosen. The step interval for the start time is 1 microsecond. The start time for each Burst is chosen independently.

3.2.3 Frequency Hopping Radar Test Waveform

Radar Type	Pulse Width (µsec)	PRI (µsec)	Pulses per Hop	Hopping Rate (kHz)	Hopping Sequence Length (ms)	Minimum Percentage of Successful Detection	Minimum Trials
6	1	333	9	0.333	300	70%	30

The FCC Type 6 waveform uses a static waveform with 100 bursts in the instruments ARB. In addition, the RF list mode is operated with a list containing 100 frequencies from a randomly generated list and it had be ensured that at least one of the random frequencies falls into the UNII Detection Bandwidth of the DUT. Each burst from the waveform file initiates a trigger pulse at the beginning that switches the RF list from one item to the next one.

3.2.4 DFS Threshold Level

DFS Threshold Level	
DFS Threshold level: -63 dBm	<input type="checkbox"/> at the antenna connector
	<input checked="" type="checkbox"/> in front of the antenna
The Interference Radar Detection Threshold Level is is $-64\text{ dBm} + 0\text{ [dBi]} + 1\text{ dB} = -63\text{ dBm}$. That had been taken into account the output power range and antenna gain.	

3.2.5 Calibration Setup

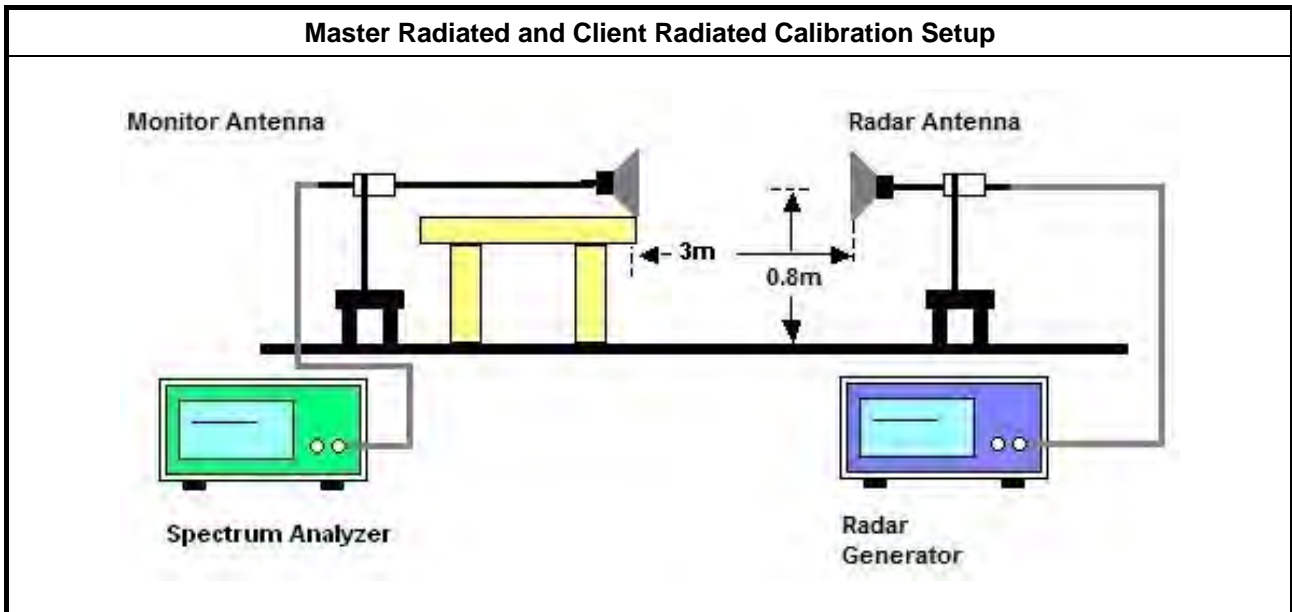



3.2.6 Radar Waveform calibration Plot

For Master-AP Router mode

Test Frequency: 5570 MHz

Radar #0 DFS detection threshold level

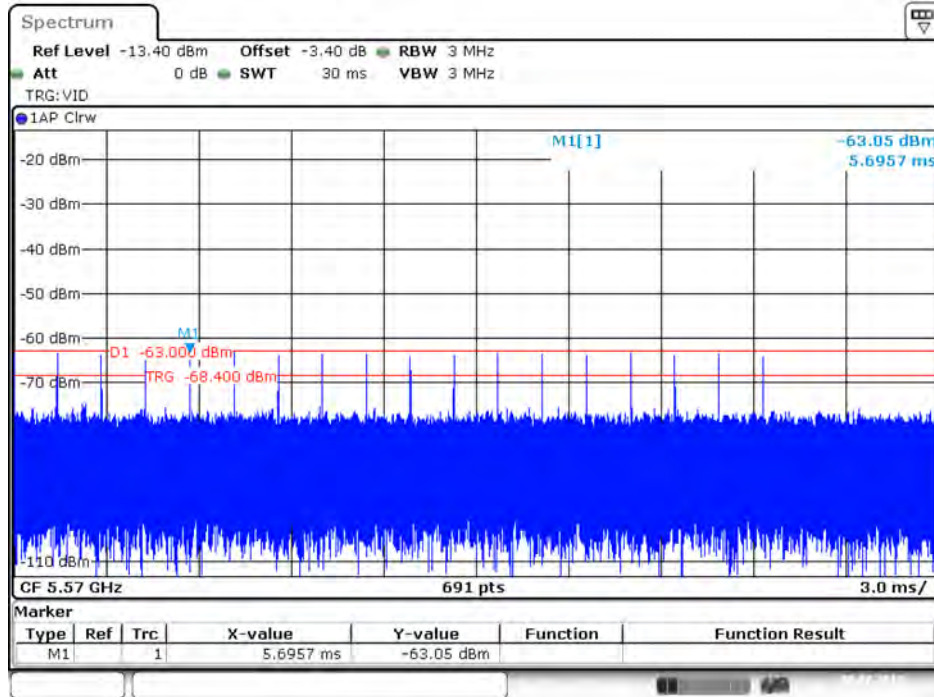

Date: 8.JUL.2019 11:00:47



Radar #1 DFS detection threshold level

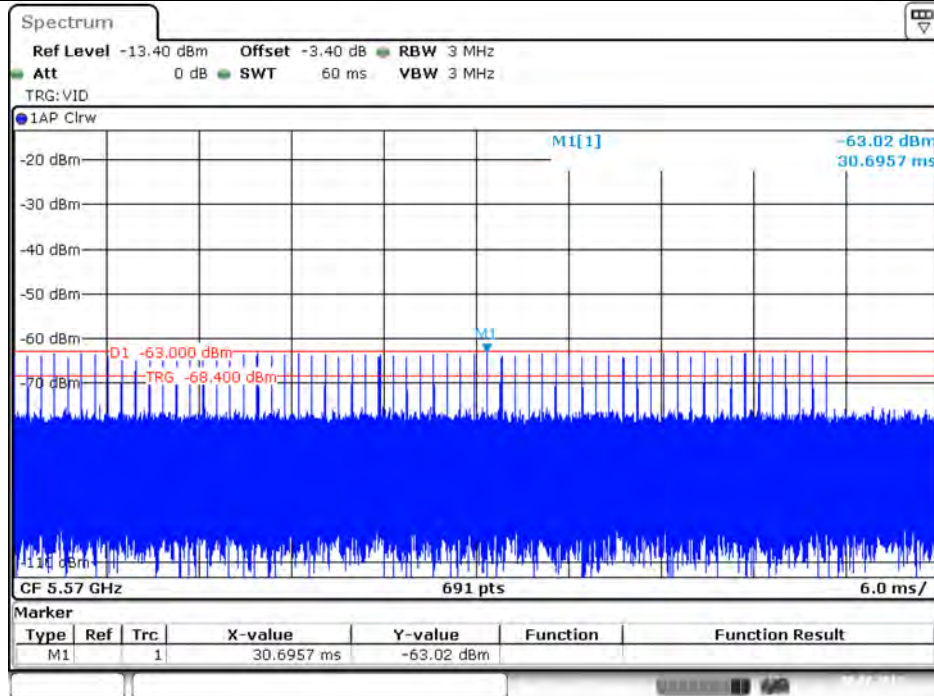

Date: 8 JUL 2019 11:04:43

Radar #2 DFS detection threshold level

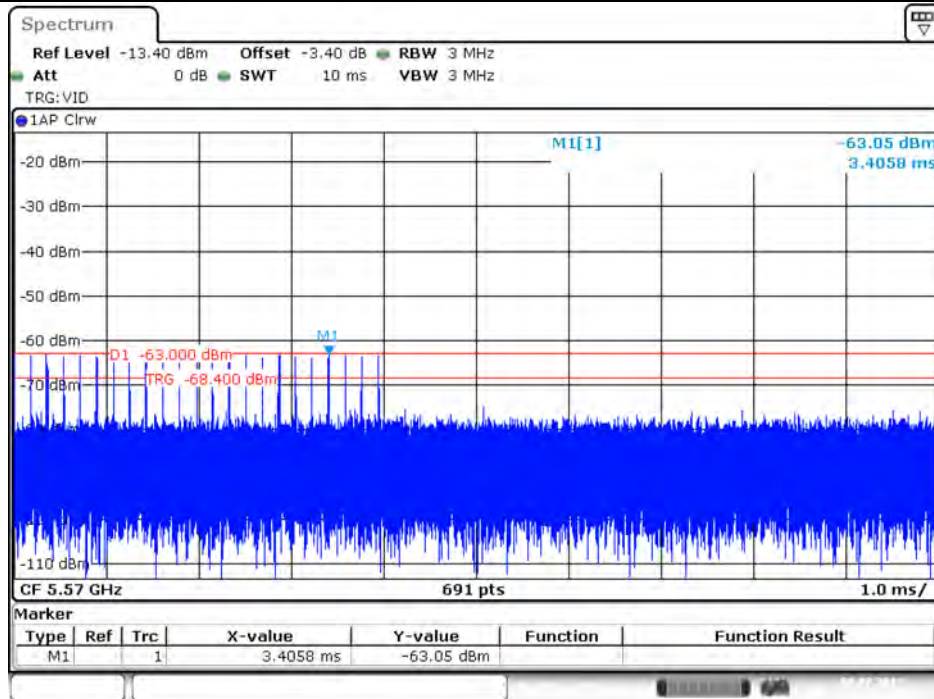

Date: 8 JUL 2019 11:05:58



Radar #3 DFS detection threshold level

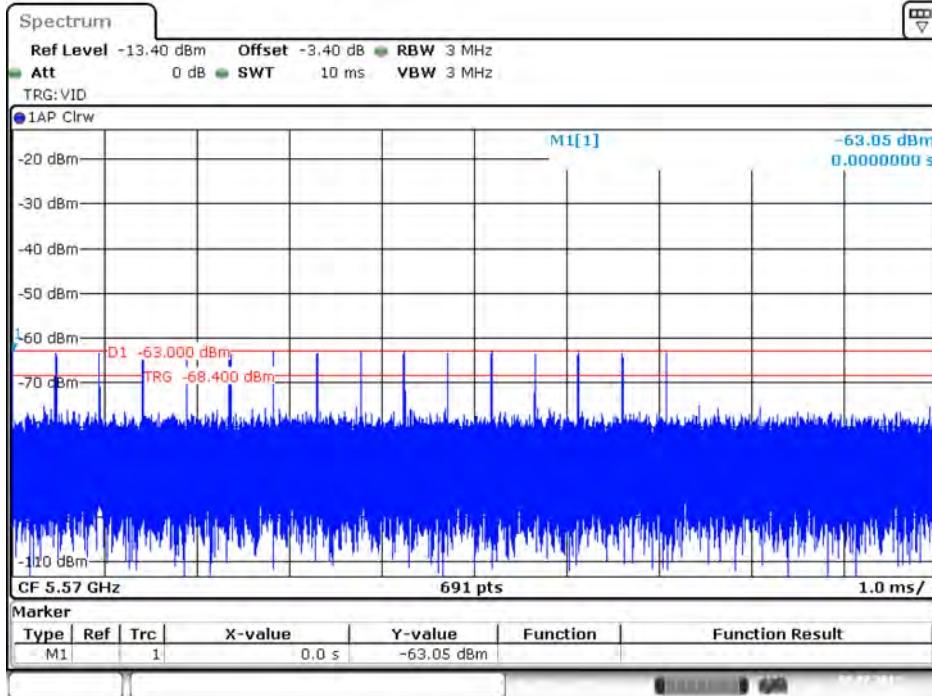

Date: 8 JUL 2019 11:06:47

Radar #4 DFS detection threshold level

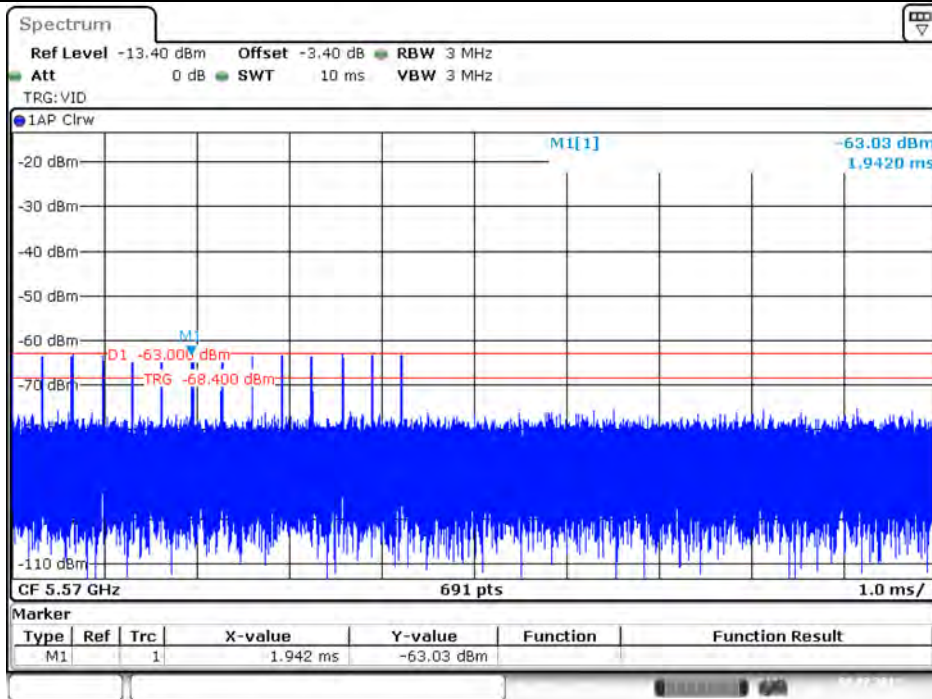

Date: 8 JUL 2019 11:07:16



Radar #5 DFS detection threshold level

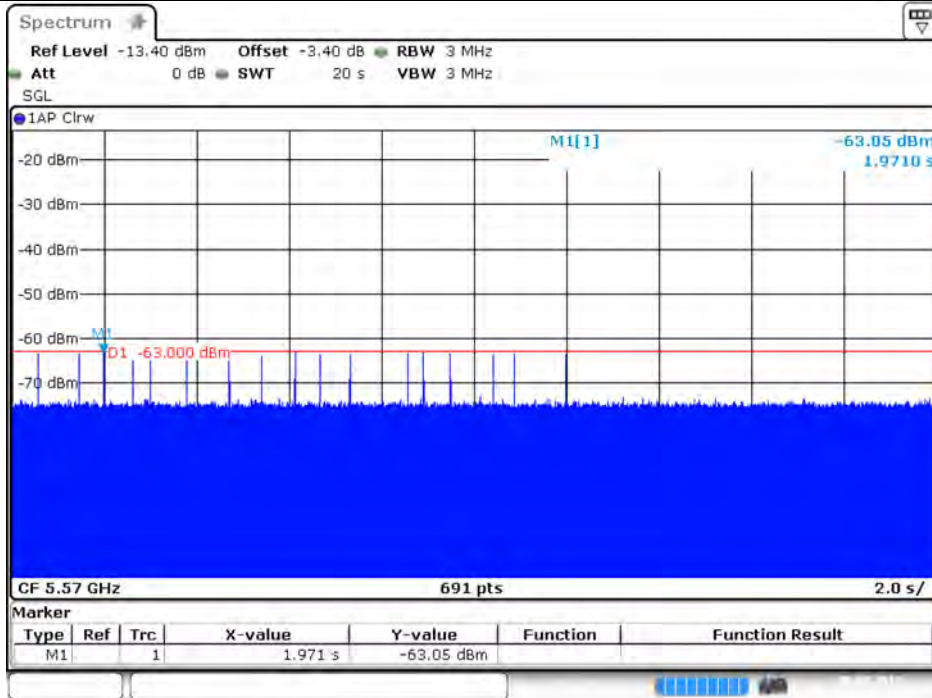

Date: 8.JUL.2019 11:15:38

Radar #6 DFS detection threshold level

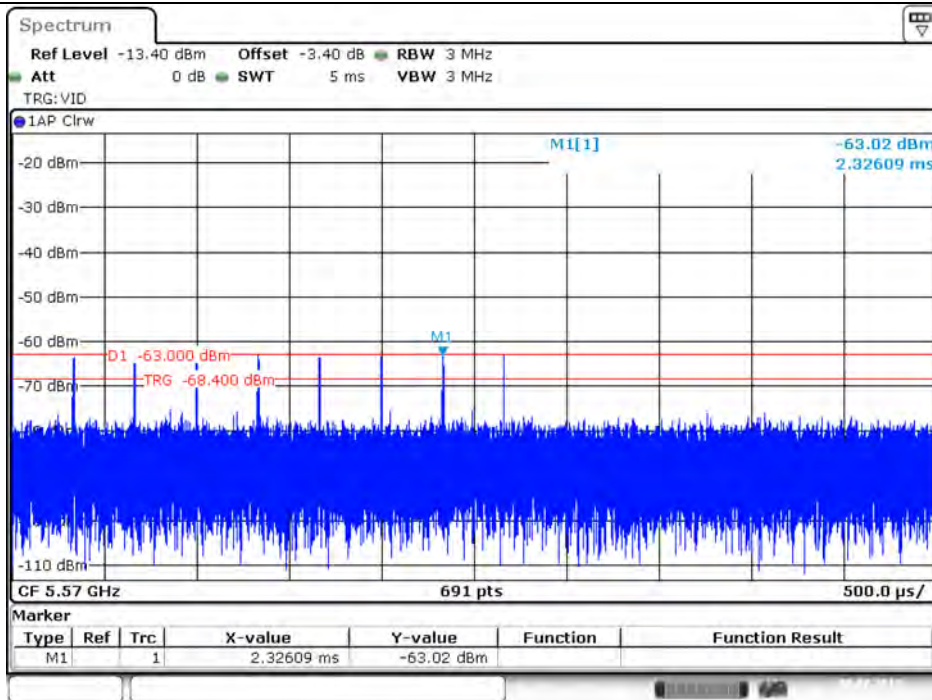

Date: 8.JUL.2019 11:13:47



For Slave without radar detection-Bridge mode

Test Frequency: 5570 MHz

Radar #0 DFS detection threshold level

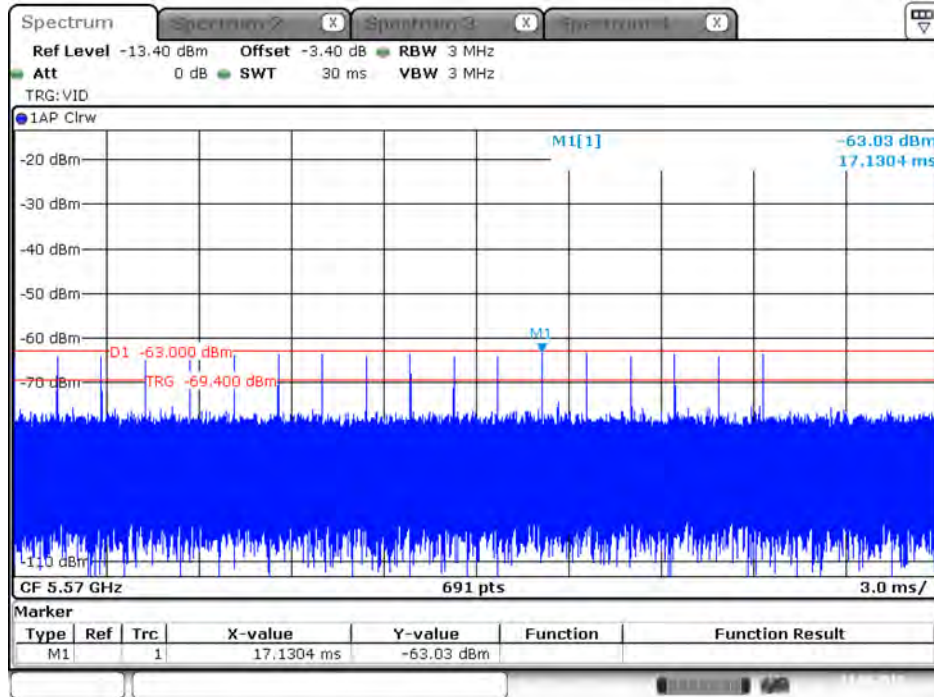

Date: 13.AUG.2019 00:10:00

3.2.7 Test Setup

A spectrum analyzer is used as a monitor to verify that the EUT has vacated the Channel within the (Channel Closing Transmission Time and Channel Move Time, and does not transmit on a Channel during the Non-Occupancy Period after the detection and Channel move.

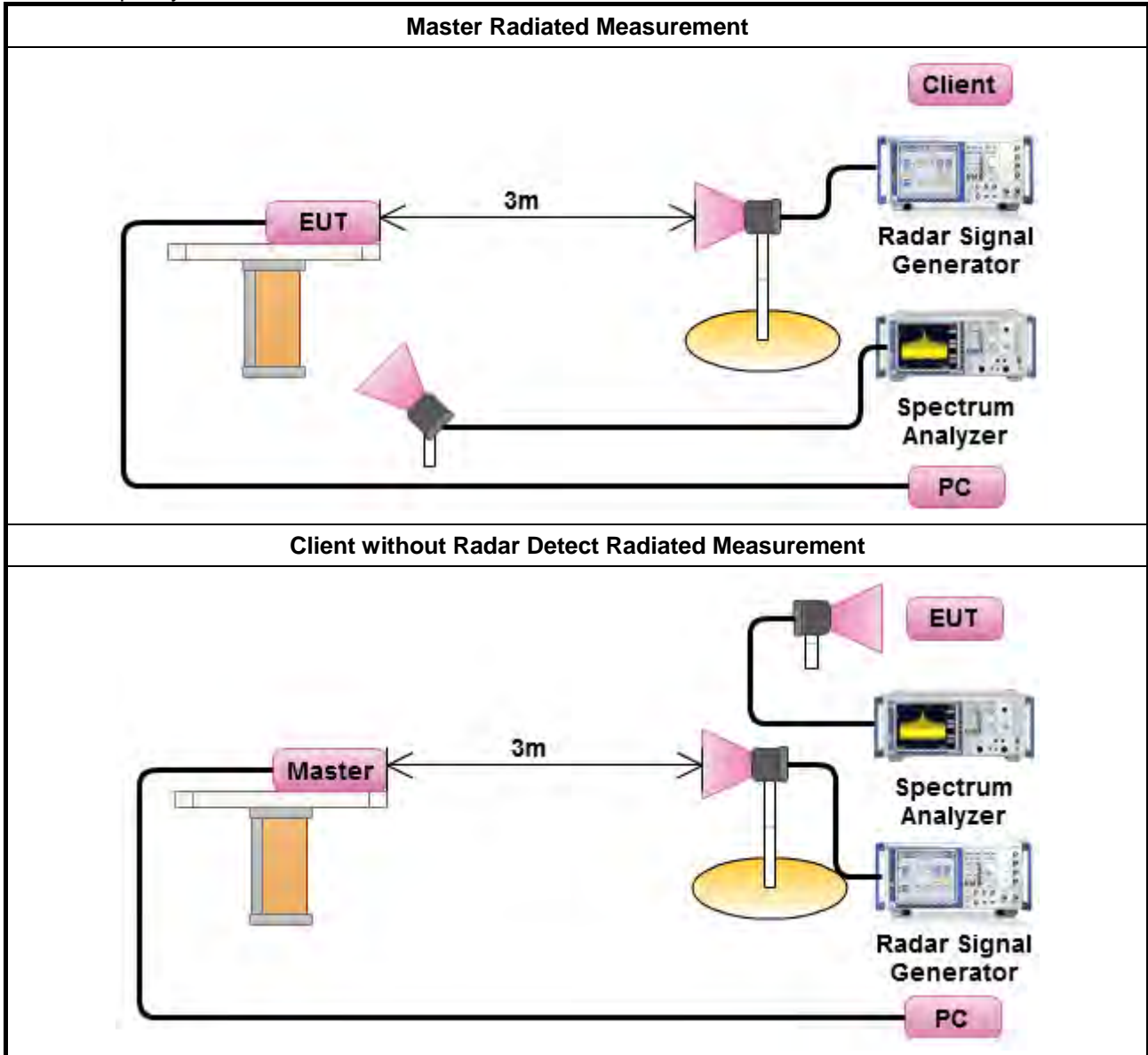



3.2.8 Data traffic Plot

For Master-AP Router mode

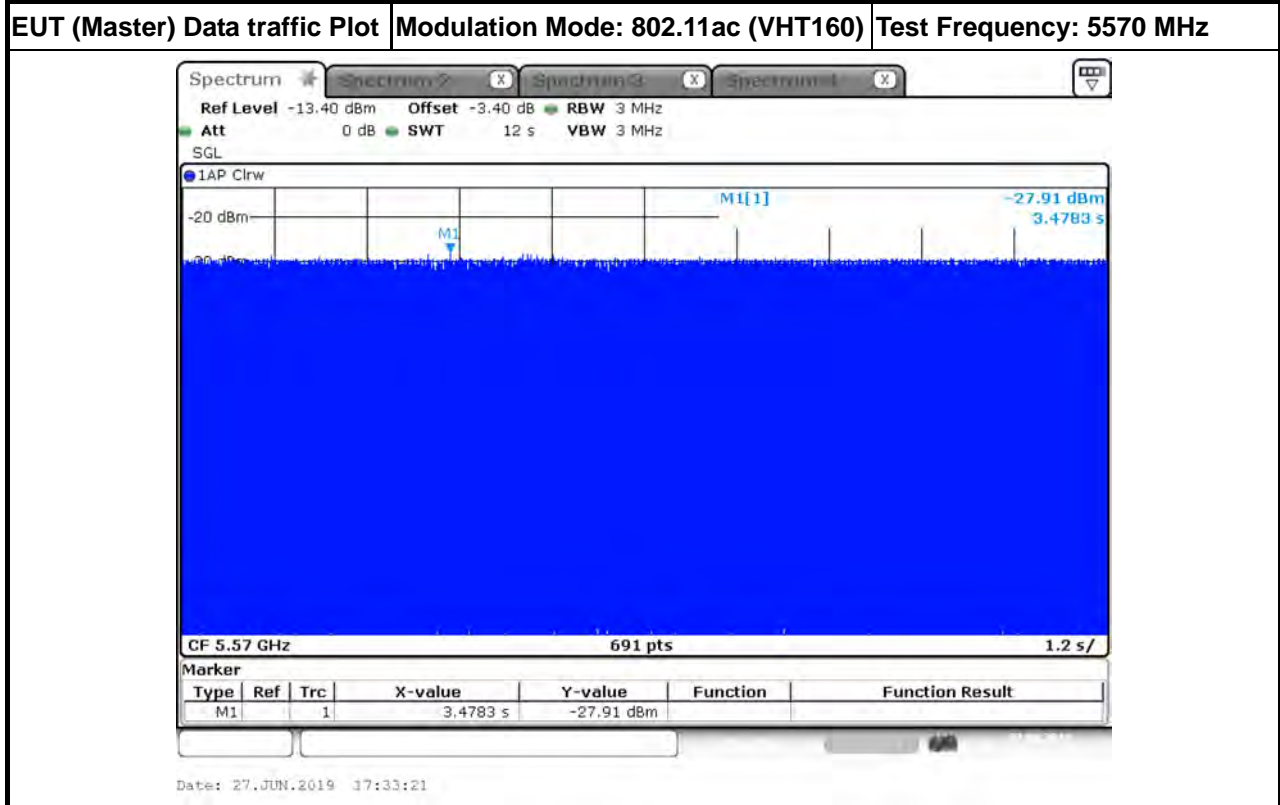

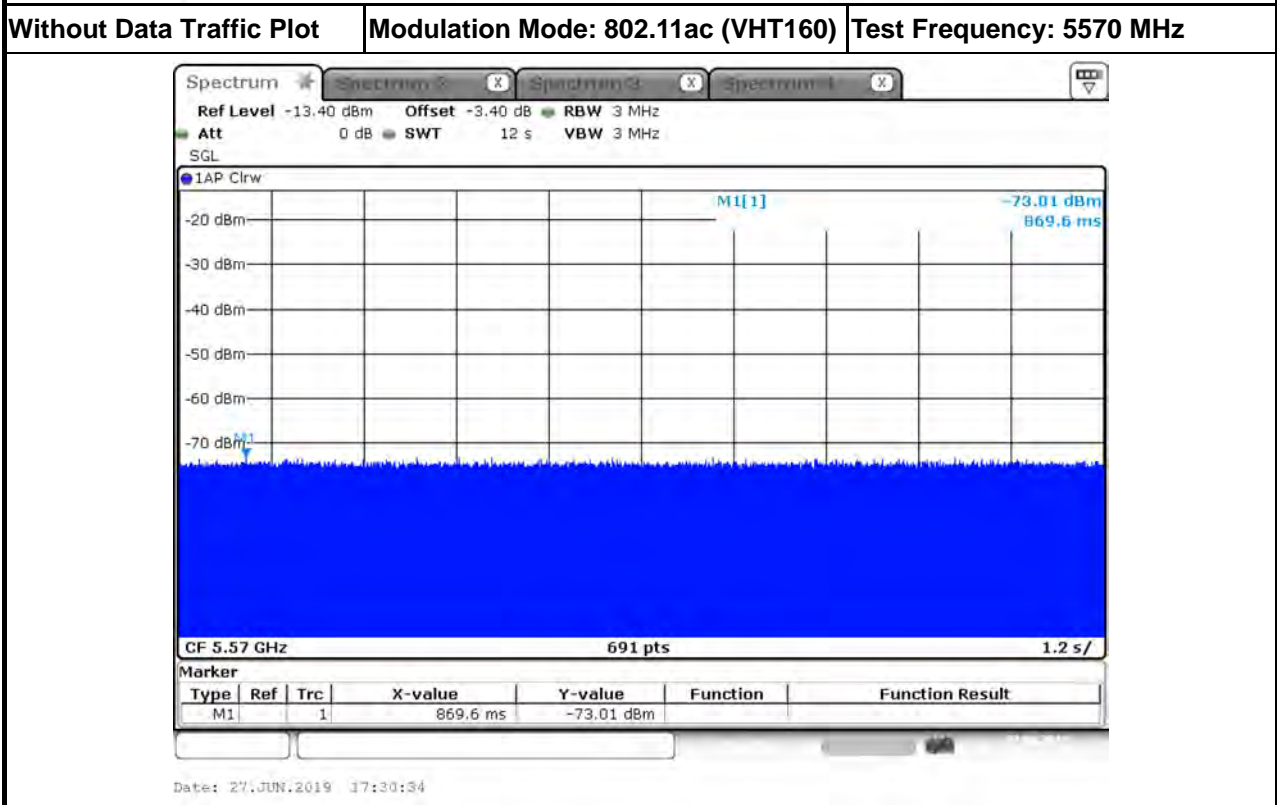
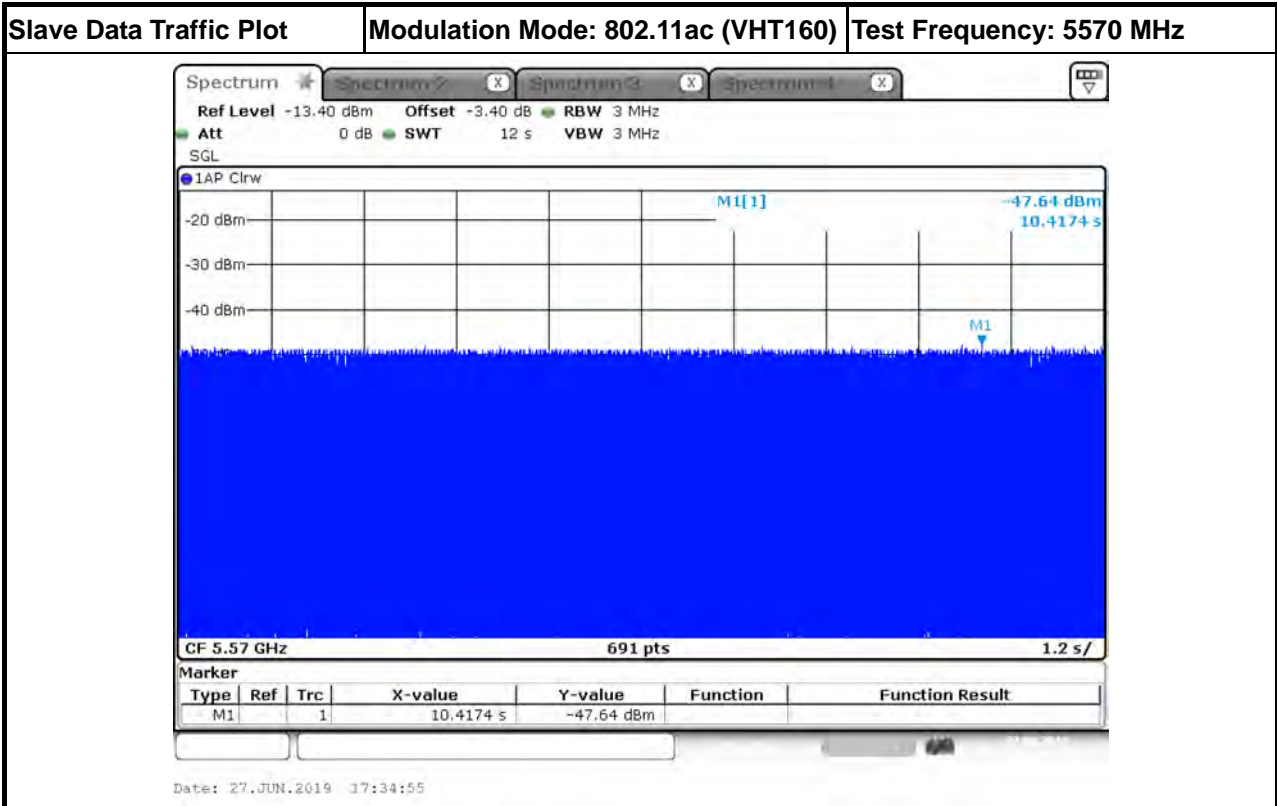



For Slave without radar detection-Bridge mode

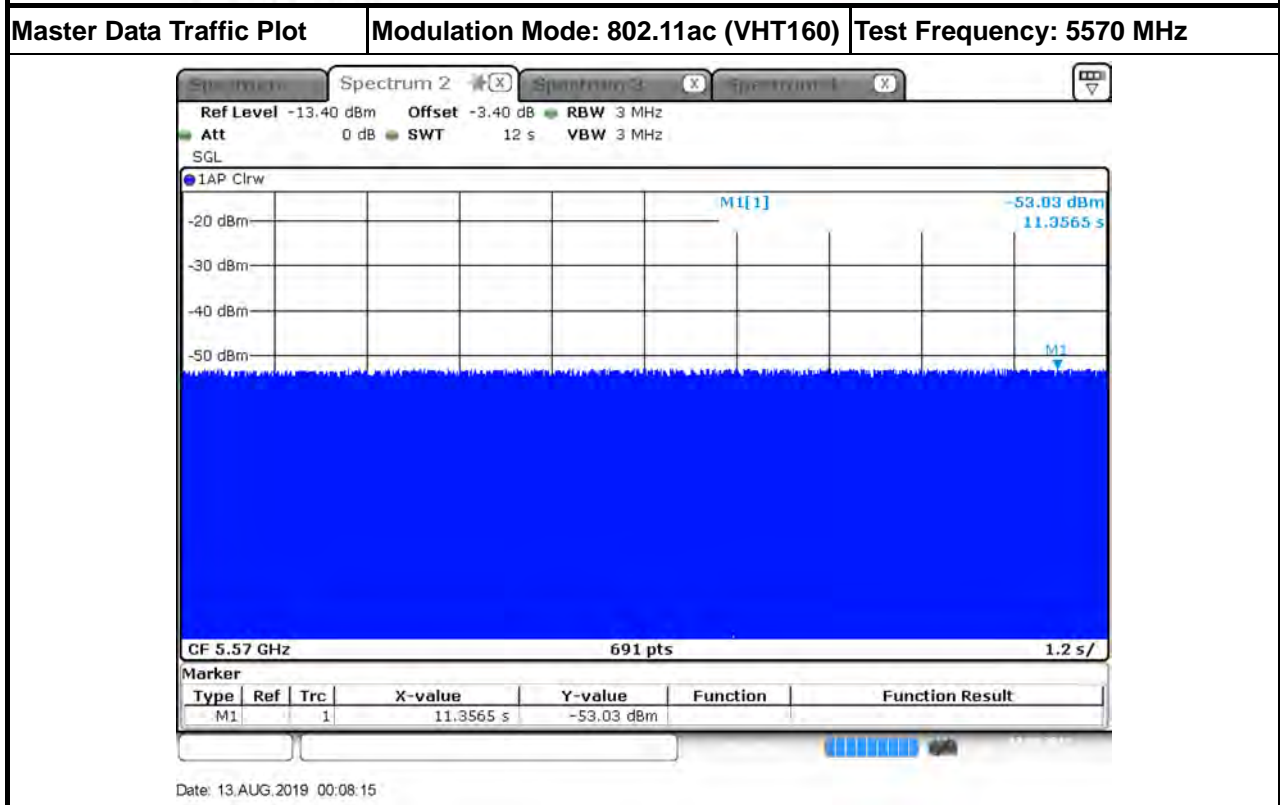
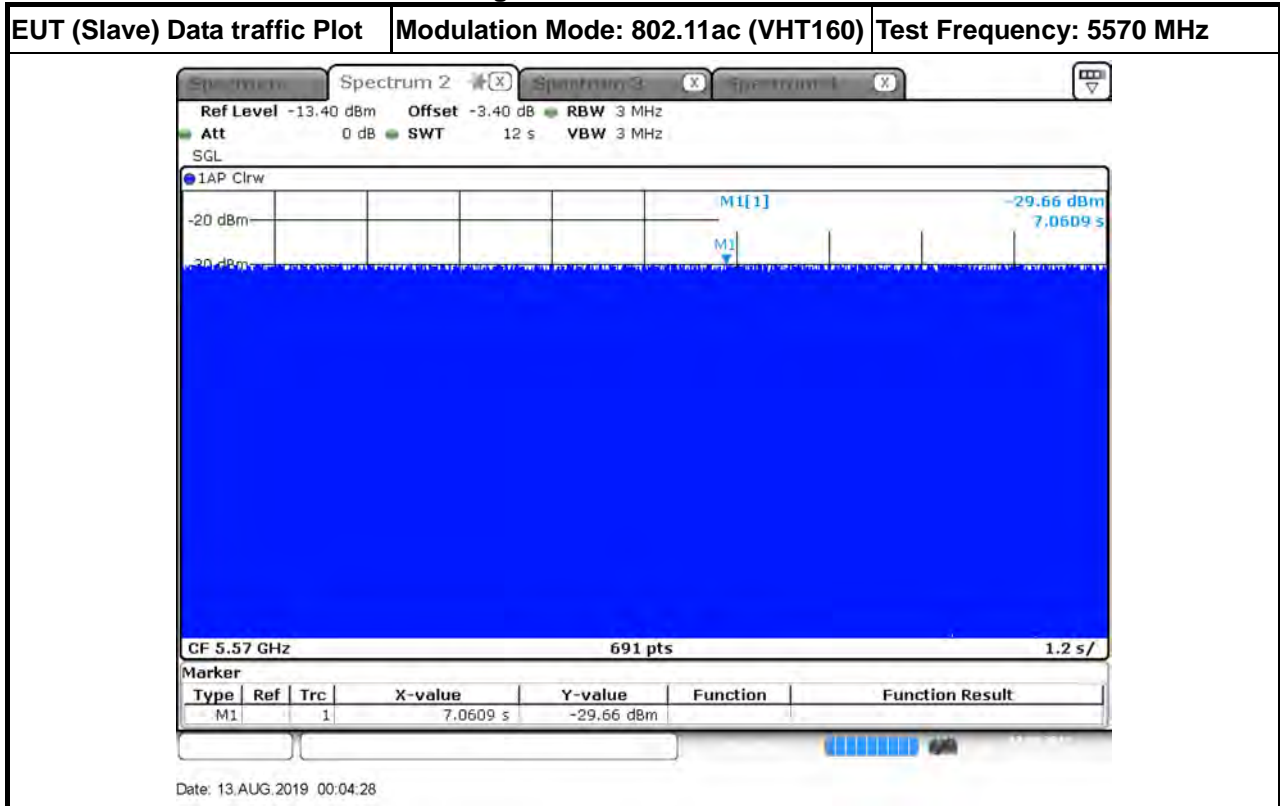

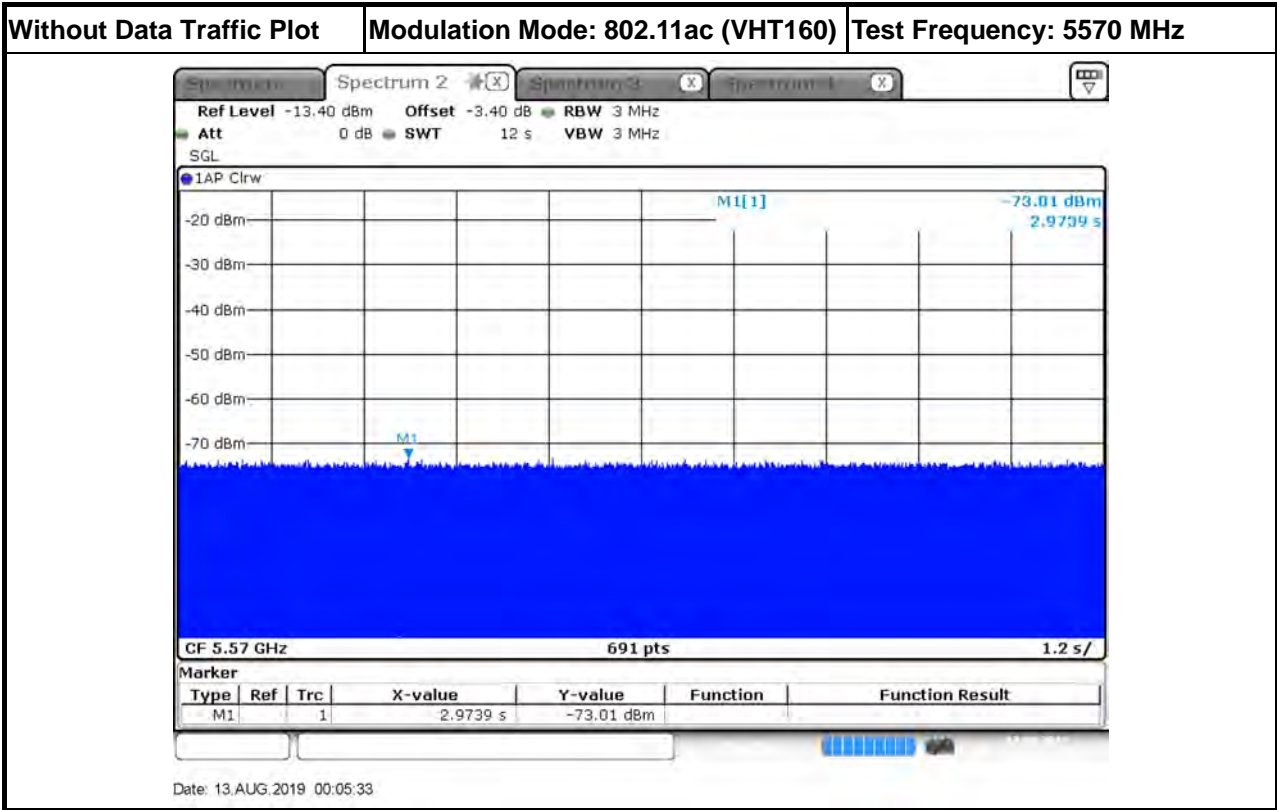



3.3 UNII Detection Bandwidth

3.3.1 UNII Detection Bandwidth Limit

For Master-AP Router mode

Channel Bandwidth (MHz)	Frequency (MHz)	99% Occupied Bandwidth (MHz)	UNII Detection Bandwidth Min. Limit (MHz)
802.11ac (VHT20)	5500 MHz	18.668	19
802.11ac (VHT40)	5510 MHz	36.758	37
802.11ac (VHT80)	5530 MHz	74.963	75
802.11ac (VHT160)	5570 MHz	151.519	152
802.11ax (HEW160)	5570 MHz	154.558	155

UNII Detection Bandwidth is minimum 100% of the 99% power bandwidth. A single radar Burst is generated for a minimum of 10 trials, and the response of the UUT is noted. The UUT must detect the Radar Waveform 90% or more of the time.

3.3.2 Measuring Instruments

Refer a test equipment and calibration data table in this test report.

3.3.3 Test Procedures

Test Method	
<input checked="" type="checkbox"/>	During the U-NII Detection Bandwidth detection test, radar type 0 is used and for each frequency step the minimum percentage of detection is 90 percent. Measurements are performed with no data traffic. The EUT is set up as a standalone device (no associated Client and no traffic). The radar frequency is increased in 1 MHz steps, repeating the above test sequence, until the detection rate falls below 90%. The highest frequency at which detection is greater than or equal to 90% is denoted as F_H . The radar frequency is decreased in 1 MHz steps, repeating the above test sequence, until the detection rate falls below 90%. The lowest frequency at which detection is greater than or equal to 90% is denoted as F_L . UNII Detection Bandwidth = $F_H - F_L$.



3.3.4 Test Result of UNII Detection Bandwidth

For Master-AP Router mode

EUT Frequency=5500 MHz												
Channel Bandwidth (MHz)	802.11ac (VHT20)											
Radar Frequency (MHz)	DFS Detection Trials (1=Detection, 0= No Detection)										Detection Rate (%)	
	1	2	3	4	5	6	7	8	9	10		
5490	0	0	0	0	0	0	0	0	0	0	0	0
5490.5(FL)	1	1	0	1	1	1	1	1	1	1	1	90
5491	1	1	1	1	1	1	1	1	1	1	1	100
5492	1	1	1	1	1	1	1	1	1	1	1	100
5493	1	1	1	1	1	1	1	1	1	1	1	100
5494	1	1	1	1	1	1	1	1	1	1	1	100
5495	1	1	1	1	1	1	1	1	1	1	1	100
5500	1	1	1	1	1	1	1	1	1	1	1	100
5505	1	1	1	1	1	1	1	1	1	1	1	100
5506	1	1	1	1	1	1	1	1	1	1	1	100
5507	1	1	1	1	1	1	1	1	1	1	1	100
5508	1	1	1	1	1	1	1	1	1	1	1	100
5509	1	1	1	1	1	1	1	1	1	1	1	100
5509.5(FH)	1	1	1	1	1	1	0	1	1	1	1	90
5510	0	0	0	0	0	0	0	0	0	0	0	0
Radar Type 0-Detection Bandwidth (MHz) = (FH-FL) = (5509.5MHz-5490.5MHz)=											19	
UNII Detection Bandwidth Min. Limit (MHz) =											19	
Test Result											Complied	



EUT Frequency=5510 MHz											
Channel Bandwidth (MHz)	802.11ac (VHT40)										
Radar Frequency (MHz)	DFS Detection Trials (1=Detection, 0= No Detection)										Detection Rate (%)
	1	2	3	4	5	6	7	8	9	10	
5490	0	0	0	0	0	0	0	0	0	0	0
5491(FL)	1	1	1	1	0	1	1	1	1	1	90
5492	1	1	1	1	1	1	1	1	1	1	100
5493	1	1	1	1	1	1	1	1	1	1	100
5494	1	1	1	1	1	1	1	1	1	1	100
5495	1	1	1	1	1	1	1	1	1	1	100
5500	1	1	1	1	1	1	1	1	1	1	100
5505	1	1	1	1	1	1	1	1	1	1	100
5510	1	1	1	1	1	1	1	1	1	1	100
5515	1	1	1	1	1	1	1	1	1	1	100
5520	1	1	1	1	1	1	1	1	1	1	100
5525	1	1	1	1	1	1	1	1	1	1	100
5526	1	1	1	1	1	1	1	1	1	1	100
5527	1	1	1	1	1	1	1	1	1	1	100
5528	1	1	1	1	1	1	1	1	1	1	100
5529(FH)	1	1	1	1	1	1	1	1	1	0	90
5530	0	0	0	0	0	0	0	0	0	0	0
Radar Type 0-Detection Bandwidth (MHz) = (FH-FL) = (5529MHz-5491MHz)=											38
UNII Detection Bandwidth Min. Limit (MHz) =											37
Test Result											Complied



EUT Frequency=5530 MHz											
Channel Bandwidth (MHz)	802.11ac (VHT80)										
Radar Frequency (MHz)	DFS Detection Trials (1=Detection, 0= No Detection)										Detection Rate (%)
	1	2	3	4	5	6	7	8	9	10	
5490	0	0	0	0	0	0	0	0	0	0	0
5491(FL)	1	1	1	1	1	0	1	1	1	1	90
5492	1	1	1	1	1	1	1	1	1	1	100
5495	1	1	1	1	1	1	1	1	1	1	100
5500	1	1	1	1	1	1	1	1	1	1	100
5505	1	1	1	1	1	1	1	1	1	1	100
5510	1	1	1	1	1	1	1	1	1	1	100
5515	1	1	1	1	1	1	1	1	1	1	100
5520	1	1	1	1	1	1	1	1	1	1	100
5525	1	1	1	1	1	1	1	1	1	1	100
5530	1	1	1	1	1	1	1	1	1	1	100
5535	1	1	1	1	1	1	1	1	1	1	100
5540	1	1	1	1	1	1	1	1	1	1	100
5545	1	1	1	1	1	1	1	1	1	1	100
5550	1	1	1	1	1	1	1	1	1	1	100
5555	1	1	1	1	1	1	1	1	1	1	100
5560	1	1	1	1	1	1	1	1	1	1	100
5567	1	1	1	1	1	1	1	1	1	1	100
5568	1	1	1	1	1	1	1	1	1	1	100
5569(FH)	1	1	1	1	1	1	1	1	0	1	90
5570	0	0	0	0	0	0	0	0	0	0	0
Radar Type 0-Detection Bandwidth (MHz) = (FH-FL) = (5569MHz-5491MHz)=											78
UNII Detection Bandwidth Min. Limit (MHz) =											75
Test Result											Complied



EUT Frequency=5570 MHz											
Channel Bandwidth (MHz)	802.11ac (VHT160)										
Radar Frequency (MHz)	DFS Detection Trials (1=Detection, 0= No Detection)										Detection Rate (%)
	1	2	3	4	5	6	7	8	9	10	
5490	0	0	0	0	0	0	0	0	0	0	0
5491(FL)	1	1	1	1	0	1	1	1	1	1	90
5492	1	1	1	1	1	1	1	1	1	1	100
5493	1	1	1	1	1	1	1	1	1	1	100
5494	1	1	1	1	1	1	1	1	1	1	100
5495	1	1	1	1	1	1	1	1	1	1	100
5500	1	1	1	1	1	1	1	1	1	1	100
5505	1	1	1	1	1	1	1	1	1	1	100
5510	1	1	1	1	1	1	1	1	1	1	100
5515	1	1	1	1	1	1	1	1	1	1	100
5520	1	1	1	1	1	1	1	1	1	1	100
5525	1	1	1	1	1	1	1	1	1	1	100
5530	1	1	1	1	1	1	1	1	1	1	100
5535	1	1	1	1	1	1	1	1	1	1	100
5540	1	1	1	1	1	1	1	1	1	1	100
5545	1	1	1	1	1	1	1	1	1	1	100
5550	1	1	1	1	1	1	1	1	1	1	100
5555	1	1	1	1	1	1	1	1	1	1	100
5560	1	1	1	1	1	1	1	1	1	1	100
5565	1	1	1	1	1	1	1	1	1	1	100
5570	1	1	1	1	1	1	1	1	1	1	100
5575	1	1	1	1	1	1	1	1	1	1	100
5580	1	1	1	1	1	1	1	1	1	1	100
5585	1	1	1	1	1	1	1	1	1	1	100
5590	1	1	1	1	1	1	1	1	1	1	100
5595	1	1	1	1	1	1	1	1	1	1	100
5600	1	1	1	1	1	1	1	1	1	1	100
5605	1	1	1	1	1	1	1	1	1	1	100
5610	1	1	1	1	1	1	1	1	1	1	100
5615	1	1	1	1	1	1	1	1	1	1	100
5620	1	1	1	1	1	1	1	1	1	1	100
5625	1	1	1	1	1	1	1	1	1	1	100
5630	1	1	1	1	1	1	1	1	1	1	100
5635	1	1	1	1	1	1	1	1	1	1	100
5640	1	1	1	1	1	1	1	1	1	1	100
5645	1	1	1	1	1	1	1	1	1	1	100
5646	1	1	1	1	1	1	1	1	1	1	100
5647	1	1	1	1	1	1	1	1	1	1	100
5648	1	1	1	1	1	1	1	1	1	1	100
5649(FH)	1	1	1	1	1	1	1	1	0	1	90
5650	0	0	0	0	0	0	0	0	0	0	0
Radar Type 0-Detection Bandwidth (MHz) = (FH-FL) = (5649MHz-5491MHz)=											158
UNII Detection Bandwidth Min. Limit (MHz) =											152
Test Result											Complied



EUT Frequency=5570 MHz											
Channel Bandwidth (MHz)	802.11ax (HEW160)										
Radar Frequency (MHz)	DFS Detection Trials (1=Detection, 0= No Detection)										Detection Rate (%)
	1	2	3	4	5	6	7	8	9	10	
5490	0	0	0	0	0	0	0	0	0	0	0
5491(FL)	1	1	1	1	1	1	0	1	1	1	90
5492	1	1	1	1	1	1	1	1	1	1	100
5493	1	1	1	1	1	1	1	1	1	1	100
5494	1	1	1	1	1	1	1	1	1	1	100
5495	1	1	1	1	1	1	1	1	1	1	100
5500	1	1	1	1	1	1	1	1	1	1	100
5505	1	1	1	1	1	1	1	1	1	1	100
5510	1	1	1	1	1	1	1	1	1	1	100
5515	1	1	1	1	1	1	1	1	1	1	100
5520	1	1	1	1	1	1	1	1	1	1	100
5525	1	1	1	1	1	1	1	1	1	1	100
5530	1	1	1	1	1	1	1	1	1	1	100
5535	1	1	1	1	1	1	1	1	1	1	100
5540	1	1	1	1	1	1	1	1	1	1	100
5545	1	1	1	1	1	1	1	1	1	1	100
5550	1	1	1	1	1	1	1	1	1	1	100
5555	1	1	1	1	1	1	1	1	1	1	100
5560	1	1	1	1	1	1	1	1	1	1	100
5565	1	1	1	1	1	1	1	1	1	1	100
5570	1	1	1	1	1	1	1	1	1	1	100
5575	1	1	1	1	1	1	1	1	1	1	100
5580	1	1	1	1	1	1	1	1	1	1	100
5585	1	1	1	1	1	1	1	1	1	1	100
5590	1	1	1	1	1	1	1	1	1	1	100
5595	1	1	1	1	1	1	1	1	1	1	100
5600	1	1	1	1	1	1	1	1	1	1	100
5605	1	1	1	1	1	1	1	1	1	1	100
5610	1	1	1	1	1	1	1	1	1	1	100
5615	1	1	1	1	1	1	1	1	1	1	100
5620	1	1	1	1	1	1	1	1	1	1	100
5625	1	1	1	1	1	1	1	1	1	1	100
5630	1	1	1	1	1	1	1	1	1	1	100
5635	1	1	1	1	1	1	1	1	1	1	100
5640	1	1	1	1	1	1	1	1	1	1	100
5645	1	1	1	1	1	1	1	1	1	1	100
5646	1	1	1	1	1	1	1	1	1	1	100
5647	1	1	1	1	1	1	1	1	1	1	100
5648	1	1	1	1	1	1	1	1	1	1	100
5649(FH)	1	1	1	0	1	1	1	1	1	1	90
5650	0	0	0	0	0	0	0	0	0	0	0
Radar Type 0-Detection Bandwidth (MHz) = (FH-FL) = (5649MHz-5491MHz)=											158
UNII Detection Bandwidth Min. Limit (MHz) =											155
Test Result											Complied



3.4 Channel Availability Check (CAC)

3.4.1 Channel Availability Check Limit

Channel Availability Check Limit	
<input checked="" type="checkbox"/>	The EUT shall perform a Channel Availability Check to ensure that there is no radar operating on the channel. After power-up sequence, receive at least 1 minute (60 sec) on the intended operating frequency.

3.4.2 Measuring Instruments

Refer a test equipment and calibration data table in this test report.

3.4.3 Test Procedures

Test Method	
<input checked="" type="checkbox"/>	For Initial Channel Availability Check Time. The EUT does not emit beacon, control, or data signals on the test Channel until the power-up sequence has been completed and the UNII device checks for Radar Waveforms for one minute on the test Channel. This test does not use any Radar Waveforms.
<input checked="" type="checkbox"/>	For Radar Burst at the Beginning of the Channel Availability Check Time. To verify successful radar detection on the selected Channel during a period equal to the Beginning of the Channel Availability Check Time.
<input checked="" type="checkbox"/>	For Radar Burst at the End of the Channel Availability Check Time. To verify successful radar detection on the selected Channel during a period equal to the End of the Channel Availability Check Time.



3.4.4 Test Result of Initial Channel Availability Check Time

For Master-AP Router mode

Modulation Mode	Freq.	Radar Test Signal
802.11ac (VHT160)	5570 MHz	N/A

The EUT does not transmit any beacon or data transmissions until at least 1 minute after the completion of the power-on cycle (30.435 sec). The initial CAC time of the EUT is indicated by marker 1 (30.435 sec). Initial beacons/data transmissions are indicated by marker 2 (90.435 sec).

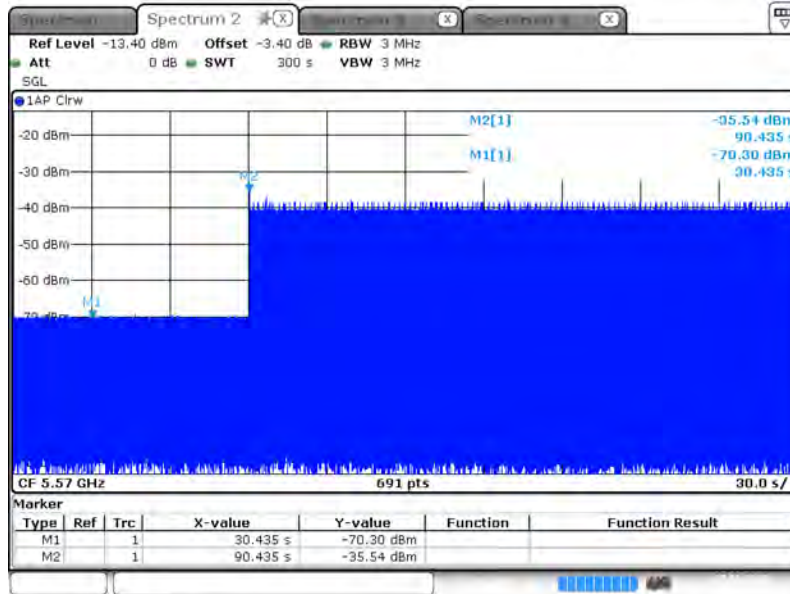

Date: 27 JUN 2019 10:49:21

Test Result	Complied
--------------------	-----------------



3.4.5 Test Result of Radar Burst at the Beginning of the Channel Availability Check Time

For Master-AP Router mode

Modulation Mode	Freq.	Radar Test Signal
802.11ac (VHT160)	5570 MHz	0

Visual indication on the EUT of successful detection of the radar Burst will be recorded and reported. Observation of emissions will continue for 264.783 seconds after the radar Burst has been generated. Verify that during the 300 seconds measurement window no EUT transmissions occurred.

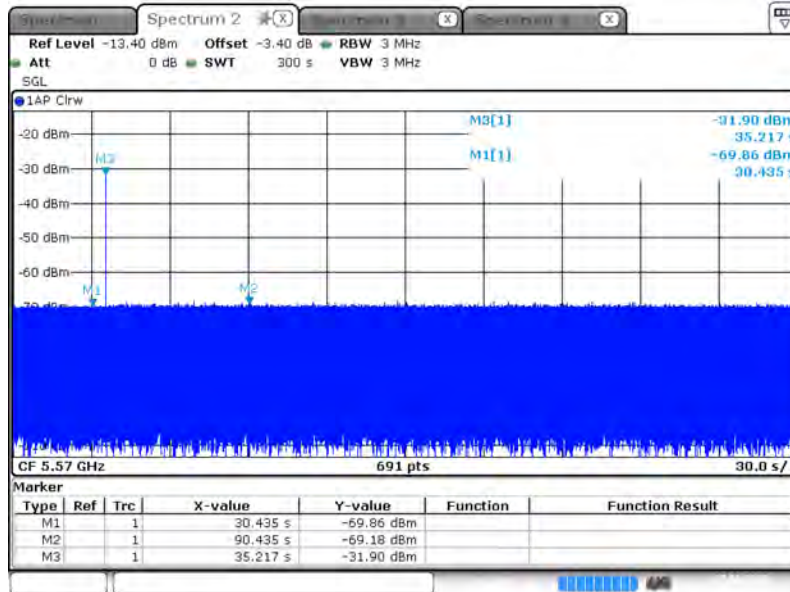

Date: 27 JUN 2019 11:23:33

Test Result	Complied



3.4.6 Test Result of Radar Burst at the End of the Channel Availability Check Time For Master-AP Router mode

Modulation Mode	Freq.	Radar Test Signal
802.11ac (VHT160)	5570 MHz	0

Visual indication on the EUT of successful detection of the radar Burst will be recorded and reported. Observation of emissions will continue for 213.043 seconds after the radar Burst has been generated. Verify that during the 300 seconds measurement window no EUT transmissions occurred.

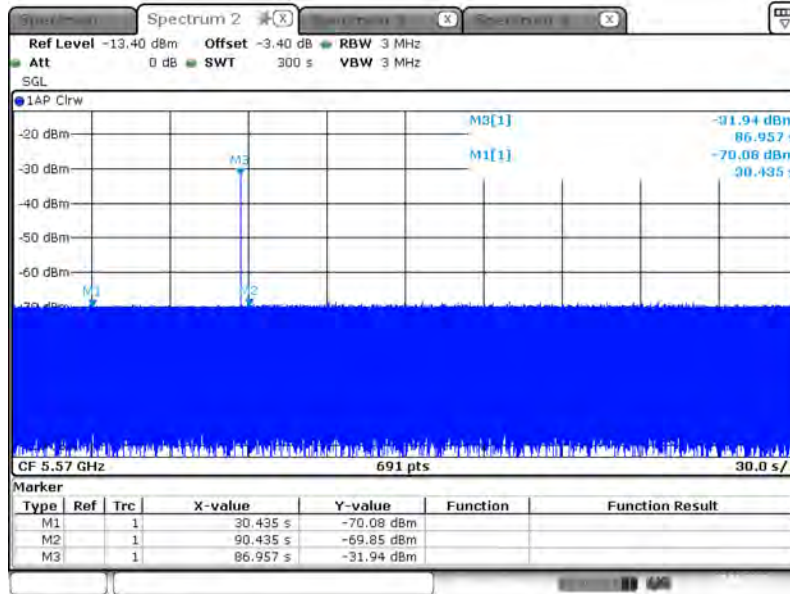

Date: 27 JUN 2019 11:32:26

Test Result	Complied
--------------------	-----------------



3.5 In-service Monitoring

3.5.1 In-service Monitoring Limit

In-service Monitoring Limit	
Channel Move Time	10 sec
Channel Closing Transmission Time	200 ms + an aggregate of 60 ms over remaining 10 sec periods.
Non-occupancy period	Minimum 30 minutes

3.5.2 Measuring Instruments

Refer a test equipment and calibration data table in this test report.

3.5.3 Test Procedures

Test Method	
<input checked="" type="checkbox"/>	Verified during In-Service Monitoring; Channel Closing Transmission Time, Channel Move Time. Client Device will associate with the EUT. Observe the transmissions of the EUT at the end of the radar Burst on the Operating Channel for duration greater than 10 seconds. Measure and record the transmissions from the EUT during the observation time (Channel Move Time). Compare the Channel Move Time and Channel Closing Transmission Time limits.
<input checked="" type="checkbox"/>	Verified during In-Service Monitoring; Channel Closing Transmission Time, Channel Move Time. One 12 sec plot needs to be reported for the Short Pulse Radar Types 0. And zoom-in a 60 ms plot verified channel closing time for the aggregate transmission time starting from 200ms after the end of the radar signal to the completion of the channel move.
<input checked="" type="checkbox"/>	Verified during In-Service Monitoring; Non-Occupancy Period. Client Device will associate with the EUT. Observe the transmissions of the EUT at the end of the radar Burst on the Operating Channel for duration greater than 10 seconds. Measure and record the transmissions from the EUT during the observation time (Non-Occupancy Period). Compare the Non-Occupancy Period limits.



3.5.4 Test Result of Channel Move Time

For Master-AP Router mode

Modulation Mode: 802.11ac (VHT160)

Parameter	Test Result	Limit
	Type 0	
Test Channel (MHz)	5500 MHz	-
Channel Move Time (sec.)	0.800	< 10s

Modulation Mode: 802.11ax (HEW160)

Parameter	Test Result	Limit
	Type 0	
Test Channel (MHz)	5510 MHz	-
Channel Move Time (sec.)	0.834	< 10s

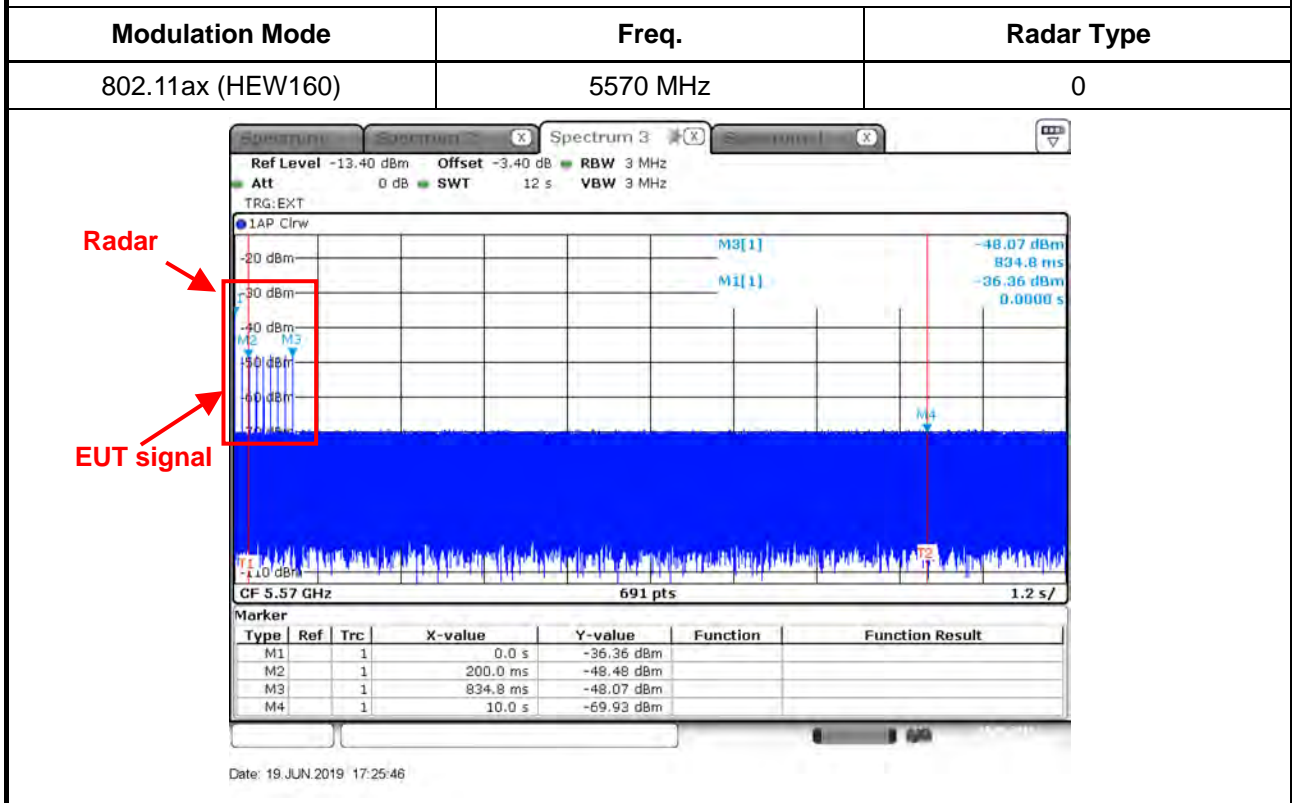
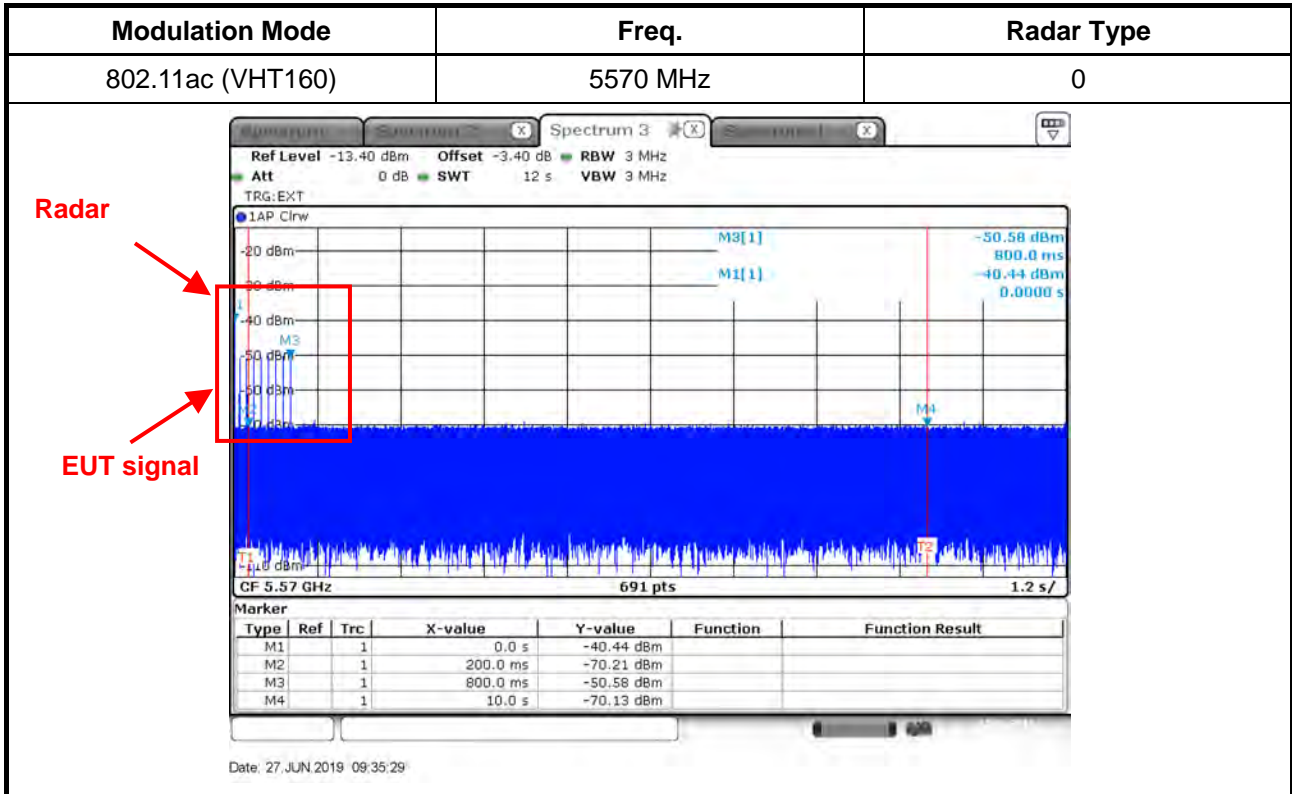



For Slave without radar detection-Bridge mode

Modulation Mode: 802.11ax (HEW160)

Parameter	Test Result	Limit
	Type 0	
Test Channel (MHz)	5570 MHz	-
Channel Move Time (sec.)	0.826	< 10s

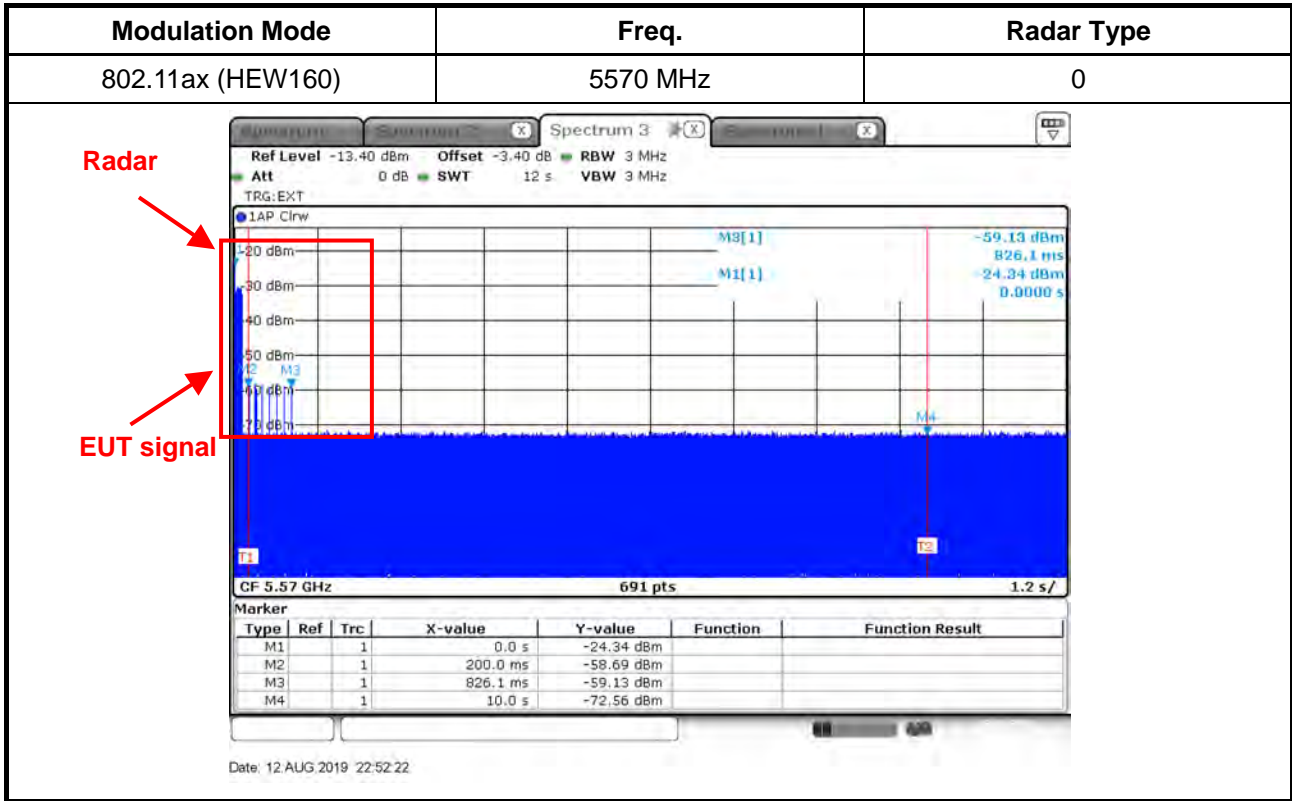



3.5.5 Test Result of Channel Closing Transmission Time

For Master-AP Router mode

Modulation Mode: 802.11ac (VHT160)

Parameter	Test Result	Limit
	Type 0	
Test Channel (MHz)	5570 MHz	-
Channel Closing Transmission Time (ms) (Note)	26.086	< 60ms

Modulation Mode: 802.11ax (HEW160)

Parameter	Test Result	Limit
	Type 0	
Test Channel (MHz)	5570 MHz	-
Channel Closing Transmission Time (ms) (Note)	23.188	< 60ms

Note: The Channel Closing Transmission Time is comprised of 200 milliseconds starting at the beginning of the Channel Move Time plus any additional intermittent control signals required to facilitate a Channel move (an aggregate of 60 milliseconds) during the remainder of the 10 seconds period. The aggregate duration of control signals will not count quiet periods in between transmissions.



Modulation Mode	Freq.	Radar Type
802.11ac (VHT160)	5570 MHz	0

Channel Closing Transmission Time is comprised of 200 ms starting at the beginning of the Channel Move Time plus 60ms additional intermittent control signals

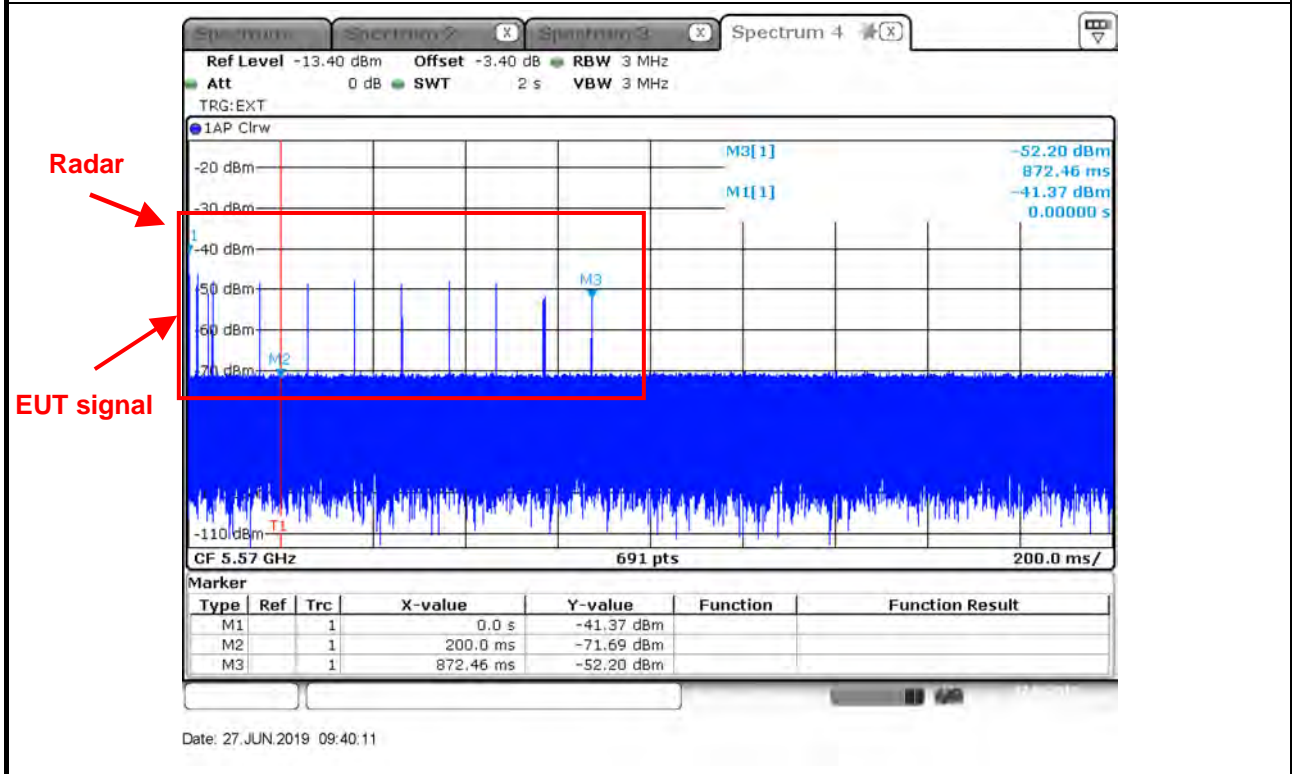

Dwell is the dwell time per spectrum analyzer sampling bin.

S is the sweep time

B is the number of spectrum analyzer sampling bins

C is the intermittent control signals of Channel Closing Transmission Time

N is the number of spectrum analyzer sampling bins (intermittent control signals) showing a U-NII transmission

$$\text{Dwell (2.899 ms)} = \text{S (2000 ms)} / \text{B (690)}$$

$$\text{C (26.086 ms)} = \text{N (9)} \times \text{Dwell (2.899 ms)}$$



Modulation Mode	Freq.	Radar Type
802.11ax (HEW160)	5570 MHz	0

Channel Closing Transmission Time is comprised of 200 ms starting at the beginning of the Channel Move Time plus 60ms additional intermittent control signals

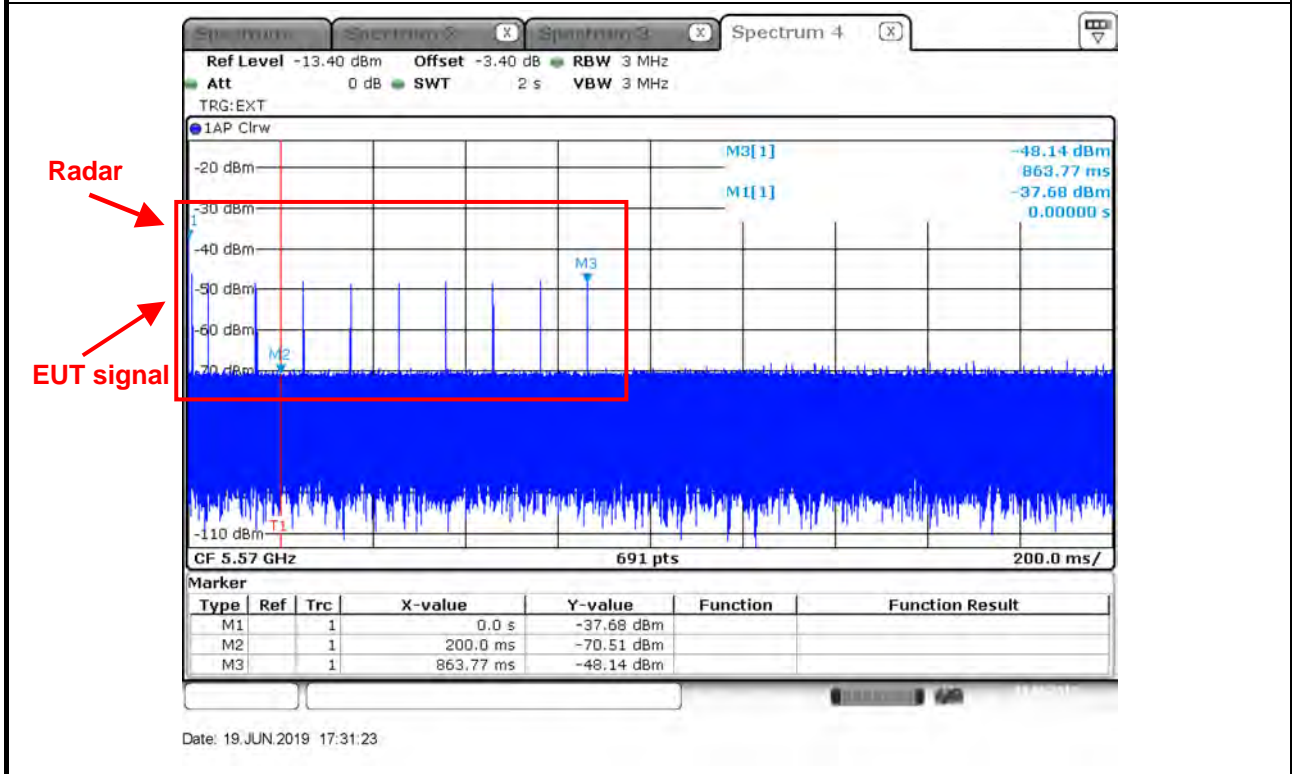

Dwell is the dwell time per spectrum analyzer sampling bin.

S is the sweep time

B is the number of spectrum analyzer sampling bins

C is the intermittent control signals of Channel Closing Transmission Time

N is the number of spectrum analyzer sampling bins (intermittent control signals) showing a U-NII transmission

$$\text{Dwell (2.899 ms)} = \text{S (2000 ms)} / \text{B (690)}$$

$$\text{C (23.188 ms)} = \text{N (8)} \times \text{Dwell (2.899 ms)}$$



**For Slave without radar detection-Bridge mode
Modulation Mode: 802.11ax (HEW160)**

Parameter	Test Result	Limit
	Type 0	
Test Channel (MHz)	5570 MHz	-
Channel Closing Transmission Time (ms) (Note)	26.086	< 60ms

Note: The Channel Closing Transmission Time is comprised of 200 milliseconds starting at the beginning of the Channel Move Time plus any additional intermittent control signals required to facilitate a Channel move (an aggregate of 60 milliseconds) during the remainder of the 10 seconds period. The aggregate duration of control signals will not count quiet periods in between transmissions.



Modulation Mode	Freq.	Radar Type
802.11ax (HEW160)	5570 MHz	0

Channel Closing Transmission Time is comprised of 200 ms starting at the beginning of the Channel Move Time plus 60ms additional intermittent control signals

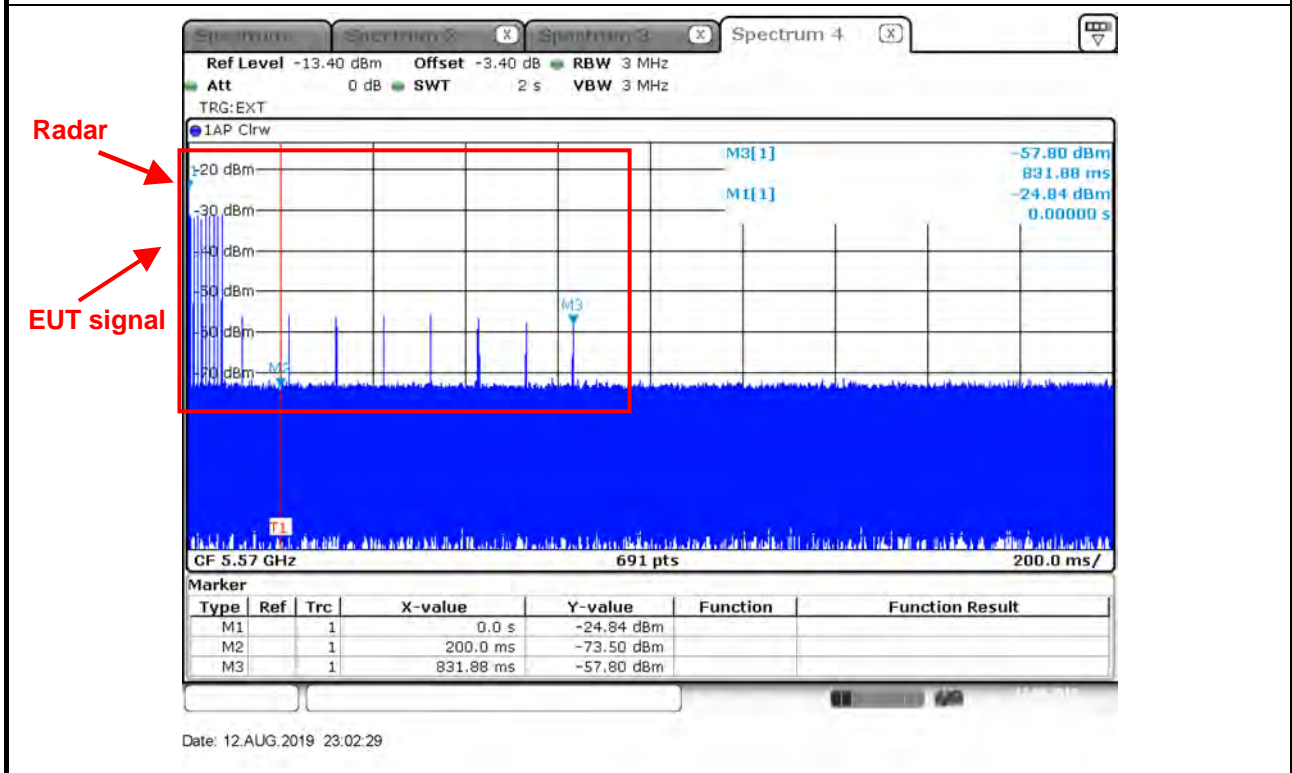

Dwell is the dwell time per spectrum analyzer sampling bin.

S is the sweep time

B is the number of spectrum analyzer sampling bins

C is the intermittent control signals of Channel Closing Transmission Time

N is the number of spectrum analyzer sampling bins (intermittent control signals) showing a U-NII transmission

$$\text{Dwell (2.899 ms)} = \text{S (2000 ms)} / \text{B (690)}$$

$$\text{C (26.086 ms)} = \text{N (9)} \times \text{Dwell (2.899 ms)}$$



3.5.6 Test Result of Non-Occupancy Period

For Master-AP Router mode

Modulation Mode: 802.11ac (VHT160)

Parameter	Test Result	Limit
	Type 0	
Test Channel (MHz)	5570 MHz	-
Non-Occupancy Period (min.)	≥ 30	≥ 30 min



Modulation Mode	Freq.
802.11ac (VHT160)	5570 MHz

Non-Occupancy Period

During the 30 minutes observation time, UUT did not make any transmissions on a channel after a radar signal was detected on that channel by either the Channel Availability Check or the In-Service Monitoring.

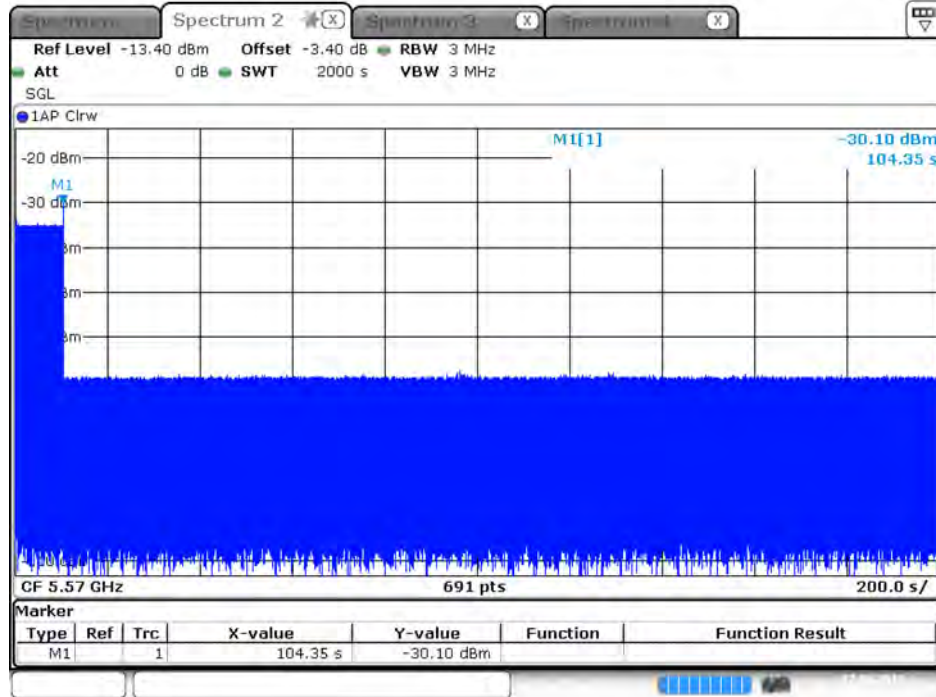

Date: 27 JUN 2019 13:38:19



**For Slave without radar detection-Bridge mode
Modulation Mode: 802.11ax (HEW160)**

Parameter	Test Result	Limit
	Type 0	
Test Channel (MHz)	5570 MHz	-
Non-Occupancy Period (min.)	≥ 30	≥ 30 min



Modulation Mode	Freq.
802.11ax (HEW160)	5570 MHz

Non-Occupancy Period

During the 30 minutes observation time, UUT did not make any transmissions on a channel after a radar signal was detected on that channel by either the Channel Availability Check or the In-Service Monitoring.

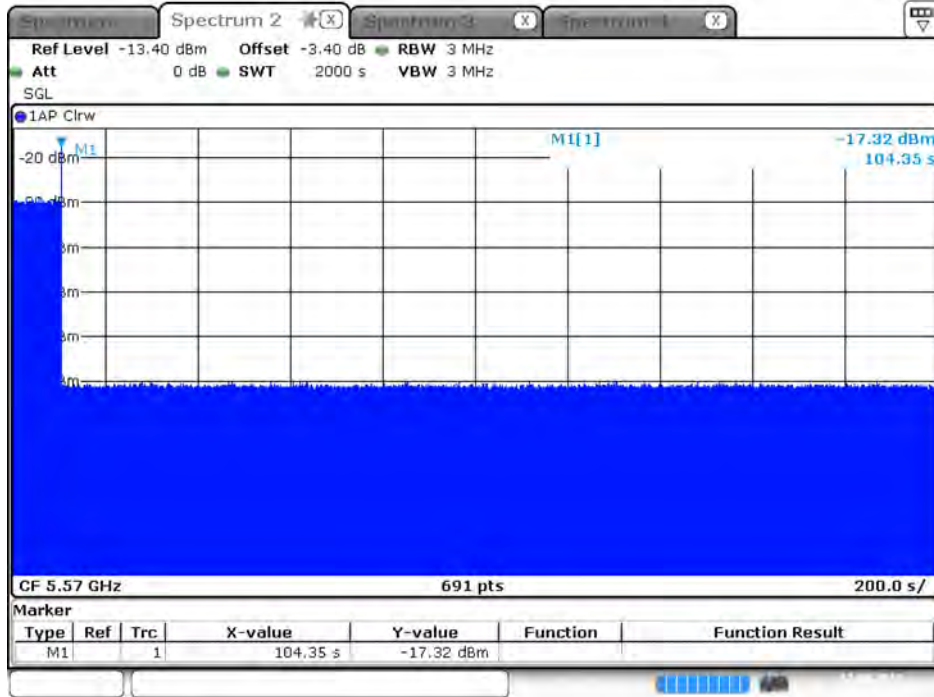

Date: 12.AUG.2019 23:50:36



Non-associated test

Master was off.

During the 30 minutes observation time, The UUT did not make any transmissions in the DFS band after UUT power up.

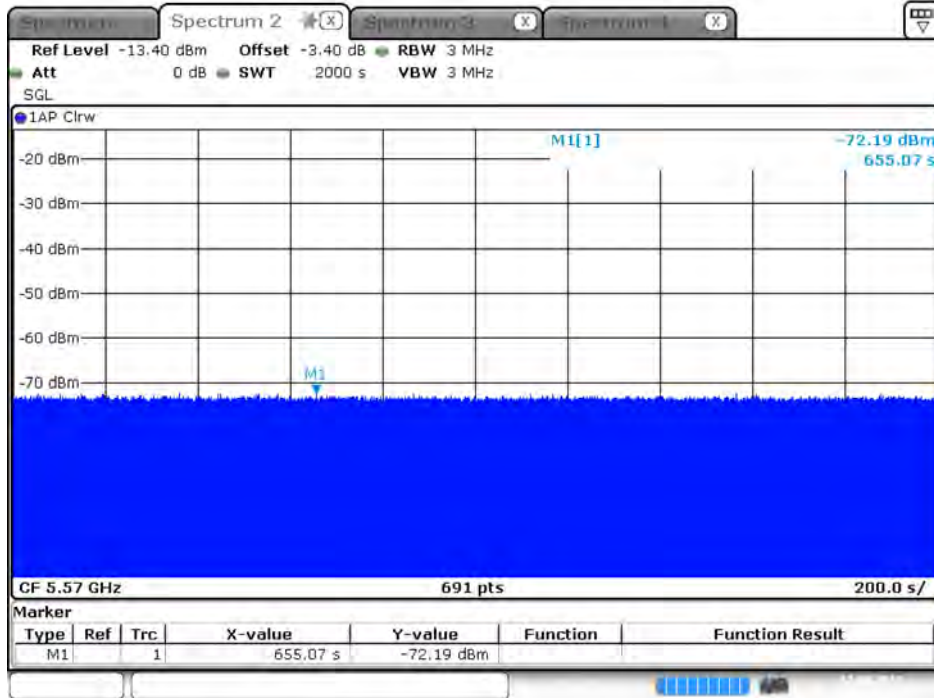

Date: 12.AUG.2019 20:00:23



3.6 Statistical Performance Check

3.6.1 Statistical Performance Check Limit

Radar Type	Minimum Percentage of Successful Detection (Pd)	Minimum Trials
1	60%	30
2	60%	30
3	60%	30
4	60%	30
Aggregate (Radar Types 1-4)	80%	120
5	80%	30
6	70%	30

The percentage of successful detection is calculated by:

$$\frac{TotalWaveformDetections}{TotalWaveformTrails} \times 100 = \text{Probability of Detection Radar Waveform}$$

In addition an aggregate minimum percentage of successful detection across all Short Pulse Radar Types 1-4 is required and is calculated as follows:

$$\frac{Pd1 + Pd2 + Pd3 + Pd4}{4}$$

3.6.2 Measuring Instruments

Refer a test equipment and calibration data table in this test report.

3.6.3 Test Procedures

Test Method
<input checked="" type="checkbox"/> For Statistical Performance Check test. Demonstrating a minimum channel loading of approximately 17% or greater of the test. Observe the transmissions of the UUT at the end of the Burst on the Operating Channel for duration greater than 10 seconds for Short Pulse Radar Types 1-4 and 6 to ensure detection occurs. Then Observe the transmissions of the UUT at the end of the Burst on the Operating Channel for duration greater than 22 seconds for Long Pulse Radar Type 5 to ensure detection occurs. The device can utilize a test mode to demonstrate when detection occurs to prevent the need to reset the device between trial runs.



3.6.4 Test Result of Statistical Performance Check

Modulation Mode: 802.11ac (VHT20)

Type 1 Radar Statistical Performance

Trial #	Test Freq. (MHz)	Pulse Repetition Frequency Number	Pulse Repetition Frequency (Pulse Per Second)	PRI (us)	1=Detection 0=No Detection
1	5495	1	1930.5	518	1
2	5496	23	326.2	3066	1
3	5499	19	1139.0	878	1
4	5496	12	1355.0	738	1
5	5508	4	1730.1	578	1
6	5493	8	1519.8	658	1
7	5496	15	1253.1	798	1
8	5497	6	1618.1	618	1
9	5504	14	1285.3	778	1
10	5498	3	1792.1	558	1
11	5501	13	1319.3	758	1
12	5493	9	1474.9	678	1
13	5508	7	1567.4	638	1
14	5508	17	1193.3	838	1
15	5498	10	1432.7	698	0
16	5509	-	1692.0	591	1
17	5496	-	328.1	3048	1
18	5504	-	373.4	2678	1
19	5491	-	574.4	1741	0
20	5500	-	1216.5	822	1
21	5508	-	801.3	1248	1
22	5506	-	488.5	2047	1
23	5509	-	956.0	1046	1
24	5503	-	517.6	1932	1
25	5503	-	1422.5	703	1
26	5504	-	542.0	1845	1
27	5491	-	741.3	1349	1
28	5502	-	881.8	1134	1
29	5504	-	427.4	2340	0
30	5493	-	628.9	1590	1
Detection Percentage (%)					90.000
Limit					60%
Test Result					Complied



Type 2 Radar Statistical Performance

Trial #	Test Freq. (MHz)	Pulse Width (us)	PRI (us)	Pulses / Burst	1=Detection 0=No Detection
1	5493	2.6	221	23	1
2	5500	4.6	198	27	0
3	5495	1.1	184	29	1
4	5493	4.8	203	24	1
5	5496	2.4	162	25	1
6	5493	3.4	204	28	1
7	5494	2.3	170	27	1
8	5499	3.5	184	23	1
9	5500	4.9	150	27	0
10	5492	4.6	211	29	1
11	5507	2.9	158	23	1
12	5499	2.6	226	27	1
13	5507	1.6	204	26	1
14	5495	3.9	181	25	0
15	5492	4.6	202	24	1
16	5507	4.1	194	27	1
17	5508	2.3	193	28	1
18	5491	3.9	173	29	1
19	5507	4.3	188	23	0
20	5501	1.5	215	26	1
21	5493	4.9	227	27	1
22	5502	1.1	199	23	1
23	5502	4.5	155	29	1
24	5500	4.0	190	27	0
25	5508	2.4	151	23	1
26	5502	2.5	180	28	1
27	5504	2.5	228	23	1
28	5503	2.5	203	25	1
29	5497	1.5	188	25	1
30	5500	1.9	217	24	1
Detection Percentage (%)					83.333
Limit					60%
Test Result					Complied



Type 3 Radar Statistical Performance

Trial #	Test Freq. (MHz)	Pulse Width (us)	PRI (us)	Pulses / Burst	1=Detection ; 0=No Detection
1	5502	8.0	205	16	1
2	5491	6.7	382	18	1
3	5497	8.6	418	16	1
4	5507	9.4	351	17	1
5	5503	7.4	383	18	1
6	5509	9.8	232	16	0
7	5505	9.1	377	17	1
8	5498	9.6	457	16	1
9	5494	8.0	471	18	1
10	5492	9.0	304	18	1
11	5509	8.0	316	17	0
12	5495	9.8	325	16	1
13	5491	8.0	409	17	0
14	5502	9.9	200	17	1
15	5506	8.8	458	16	1
16	5504	8.0	232	18	1
17	5494	8.3	250	16	0
18	5505	8.7	270	16	1
19	5504	7.7	350	17	1
20	5509	7.1	230	16	0
21	5497	7.3	416	18	1
22	5505	7.6	498	18	1
23	5500	7.3	286	17	0
24	5507	7.3	287	16	1
25	5502	7.5	462	17	1
26	5491	6.2	300	17	1
27	5500	6.4	323	18	1
28	5501	7.1	420	16	1
29	5508	7.2	395	18	1
30	5503	8.4	377	16	1
Detection Percentage (%)					80.000
Limit					60%
Test Result					Complied



Type 4 Radar Statistical Performance

Trial #	Test Freq. (MHz)	Pulse Width (us)	PRI (us)	Pulses / Burst	1=Detection 0=No Detection
1	5497	18.0	242	15	1
2	5506	19.9	279	12	1
3	5491	12.9	487	14	1
4	5495	15.0	452	13	1
5	5504	16.3	230	12	1
6	5497	19.8	238	13	1
7	5499	18.2	420	16	1
8	5509	16.3	452	15	1
9	5498	14.2	495	12	0
10	5491	17.8	228	16	1
11	5506	19.1	211	16	1
12	5508	18.4	283	15	1
13	5509	11.8	411	12	1
14	5500	14.2	284	13	1
15	5504	13.9	202	12	0
16	5498	17.8	340	14	1
17	5494	15.6	290	16	1
18	5506	14.6	250	16	0
19	5507	14.4	484	15	1
20	5499	18.9	387	13	1
21	5494	11.1	348	15	0
22	5496	13.8	291	16	1
23	5504	14.3	295	12	1
24	5496	12.5	300	12	1
25	5503	12.5	322	14	0
26	5499	12.5	383	13	1
27	5506	15.7	322	16	1
28	5509	19.8	469	13	1
29	5495	18.6	406	15	1
30	5495	15.9	238	14	1
Detection Percentage (%)					83.333
Limit					60%
Test Result					Complied



Total Type 1~4 Radar Statistical Performance

Radar Type #	Detection Percentage (%)
1	90.000
2	83.333
3	80.000
4	83.333
Aggregate (Radar Types 1-4)	84.167
Limit	80%
Test Result	Complied



Type 5 Radar Statistical Performance

Center Freq. (MHz)	Low Edge (MHz)	High Edge (MHz)	VSG Freq. (MHz)	Detection
Trial	Chirp	Offset		
1	5	2	5500	1
2	20	8	5500	1
3	7	2.8	5500	1
4	8	3.2	5500	1
5	9	3.6	5500	1
6	10	4	5500	1
7	11	4.4	5500	1
8	12	4.8	5500	1
9	13	5.2	5500	1
10	14	5.6	5500	1
11	15	6	5497	1
12	16	6.4	5497	1
13	17	6.8	5497	1
14	20	8	5499	0
15	19	7.6	5498	0
16	18	7.2	5498	0
17	17	6.8	5497	1
18	16	6.4	5497	1
19	15	6	5497	1
20	14	5.6	5496	1
21	13	5.2	5504	1
22	12	4.8	5505	1
23	11	4.4	5505	1
24	10	4	5506	1
25	9	3.6	5506	1
26	8	3.2	5506	1
27	18	7.2	5502	0
28	19	7.6	5502	0
29	20	8	5502	0
30	5	2	5508	1
Total				24
Detection Percentage (%)				80%
Limit				80%
Test Result				Complied



Trial Number							1
Number of Bursts in Trial							8
Chirp Center Frequency							5500
Burst	No. of Pulses	Pulse Width (us)	Chirp Width (MHz)	Pulse 1-to-2 Spacing (us)	Pulse 2-to-3 Spacing (us)	Starting Location Within Interval (ms)	
1	1	62.1	5	-	-	1091	
2	2	56	5	1729	-	133	
3	2	91.3	5	1230	-	1057	
4	3	50.7	5	1762	1616	1442	
5	2	92.6	5	1723	-	544	
6	2	87.3	5	1302	-	1089	
7	2	59.5	5	1291	-	1374	
8	2	52.2	5	1653	-	1237	
Detection Check (1=Detection; 0=No Detection)							1

Trial Number							2
Number of Bursts in Trial							9
Chirp Center Frequency							5500
Burst	No. of Pulses	Pulse Width (us)	Chirp Width (MHz)	Pulse 1-to-2 Spacing (us)	Pulse 2-to-3 Spacing (us)	Starting Location Within Interval (ms)	
1	3	90	20	1007	1326	30	
2	2	73.7	20	1785	-	979	
3	1	78.1	20	-	-	683	
4	2	92.4	20	1281	-	950	
5	1	61.2	20	-	-	612	
6	3	67.2	20	1525	1870	17	
7	1	78.5	20	-	-	429	
8	2	60.3	20	1931	-	936	
9	3	92.9	20	1403	1476	548	
Detection Check (1=Detection; 0=No Detection)							1



Trial Number							3
Number of Bursts in Trial							10
Chirp Center Frequency							5500
Burst	No. of Pulses	Pulse Width (us)	Chirp Width (MHz)	Pulse 1-to-2 Spacing (us)	Pulse 2-to-3 Spacing (us)	Starting Location Within Interval (ms)	
1	3	63.4	7	1574	1607	801	
2	1	98	7	-	-	966	
3	1	58.7	7	-	-	185	
4	1	88	7	-	-	1012	
5	3	79.5	7	1562	1370	943	
6	3	57.1	7	1900	1188	686	
7	2	64.4	7	1090	-	599	
8	1	78.7	7	-	-	1089	
9	1	69.3	7	-	-	188	
10	3	55.3	7	1375	1691	933	
Detection Check (1=Detection; 0=No Detection)							1

Trial Number							4
Number of Bursts in Trial							11
Chirp Center Frequency							5500
Burst	No. of Pulses	Pulse Width (us)	Chirp Width (MHz)	Pulse 1-to-2 Spacing (us)	Pulse 2-to-3 Spacing (us)	Starting Location Within Interval (ms)	
1	2	74.3	8	1642	-	24	
2	1	83.1	8	-	-	985	
3	2	59.5	8	1680	-	988	
4	2	59.8	8	1786	-	800	
5	2	77.6	8	1617	-	339	
6	2	79.9	8	1553	-	1040	
7	1	56	8	-	-	544	
8	3	71.4	8	1406	1927	452	
9	1	97.4	8	-	-	204	
10	2	98.3	8	1037	-	926	
11	1	63.6	8	-	-	1052	
Detection Check (1=Detection; 0=No Detection)							1



Trial Number		5				
Number of Bursts in Trial		12				
Chirp Center Frequency		5500				
Burst	No. of Pulses	Pulse Width (us)	Chirp Width (MHz)	Pulse 1-to-2 Spacing (us)	Pulse 2-to-3 Spacing (us)	Starting Location Within Interval (ms)
1	1	50	9	-	-	557
2	2	62.5	9	1731	-	567
3	2	55.4	9	1070	-	460
4	1	65.7	9	-	-	4
5	2	58	9	1512	-	64
6	2	60.9	9	1230	-	650
7	3	89.6	9	1598	1738	235
8	3	84.4	9	1271	1617	873
9	3	72.3	9	1498	1321	901
10	1	58.9	9	-	-	663
11	2	74.8	9	1584	-	919
12	1	71.8	9	-	-	375
Detection Check (1=Detection; 0=No Detection)						1

Trial Number		6				
Number of Bursts in Trial		13				
Chirp Center Frequency		5500				
Burst	No. of Pulses	Pulse Width (us)	Chirp Width (MHz)	Pulse 1-to-2 Spacing (us)	Pulse 2-to-3 Spacing (us)	Starting Location Within Interval (ms)
1	2	88.1	10	1257	-	846
2	1	58.7	10	-	-	725
3	2	97.1	10	1037	-	30
4	3	83.1	10	1029	1106	490
5	1	62.1	10	-	-	262
6	2	71.4	10	1058	-	283
7	2	86.3	10	1867	-	49
8	3	77.3	10	1418	1876	634
9	1	78.9	10	-	-	304
10	3	79.2	10	1055	1572	564
11	3	52	10	1582	1836	852
12	3	56.5	10	1195	1542	525
13	3	100	10	1638	1729	750
Detection Check (1=Detection; 0=No Detection)						1



Trial Number							7
Number of Bursts in Trial							14
Chirp Center Frequency							5500
Burst	No. of Pulses	Pulse Width (us)	Chirp Width (MHz)	Pulse 1-to-2 Spacing (us)	Pulse 2-to-3 Spacing (us)	Starting Location Within Interval (ms)	
1	2	92.7	11	1208	-	231	
2	2	81.3	11	1144	-	804	
3	2	60.4	11	1555	-	34	
4	2	62.1	11	1320	-	427	
5	1	50	11	-	-	577	
6	3	65.9	11	1020	1365	3	
7	2	73.8	11	1308	-	51	
8	2	74.3	11	1143	-	360	
9	1	62.9	11	-	-	394	
10	2	74.8	11	1404	-	317	
11	2	69.7	11	1309	-	532	
12	2	69.8	11	1688	-	339	
13	2	77.4	11	1857	-	381	
14	1	55.1	11	-	-	426	
Detection Check (1=Detection; 0=No Detection)							1

Trial Number							8
Number of Bursts in Trial							15
Chirp Center Frequency							5500
Burst	No. of Pulses	Pulse Width (us)	Chirp Width (MHz)	Pulse 1-to-2 Spacing (us)	Pulse 2-to-3 Spacing (us)	Starting Location Within Interval (ms)	
1	1	91.7	12	-	-	776	
2	2	90	12	1196	-	187	
3	3	92.3	12	1486	1853	448	
4	2	66.8	12	1545	-	702	
5	1	64	12	-	-	403	
6	3	95.4	12	1123	1473	230	
7	3	66.8	12	1867	1401	604	
8	3	67.7	12	1472	1397	38	
9	1	68.2	12	-	-	735	
10	2	82.2	12	1297	-	610	
11	1	92.1	12	-	-	618	
12	2	57	12	1764	-	705	
13	2	58.5	12	1310	-	22	
14	3	85.5	12	1630	1447	641	
15	2	82.2	12	1371	-	109	
Detection Check (1=Detection; 0=No Detection)							1



Trial Number			9			
Number of Bursts in Trial			16			
Chirp Center Frequency			5500			
Burst	No. of Pulses	Pulse Width (us)	Chirp Width (MHz)	Pulse 1-to-2 Spacing (us)	Pulse 2-to-3 Spacing (us)	Starting Location Within Interval (ms)
1	2	74.4	13	1707	-	442
2	2	63.6	13	1725	-	280
3	2	71.3	13	1704	-	459
4	3	77.6	13	1063	1405	197
5	3	65.2	13	1731	1294	101
6	3	55.1	13	1109	1549	17
7	2	96.8	13	1034	-	131
8	3	80.8	13	1533	1051	365
9	1	60.4	13	-	-	222
10	2	61.8	13	1312	-	371
11	2	71.3	13	1657	-	33
12	2	98.1	13	1024	-	291
13	1	57.9	13	-	-	188
14	1	91.8	13	-	-	163
15	2	56.7	13	1259	-	426
16	2	89.7	13	1690	-	606
Detection Check (1=Detection; 0=No Detection)						1



Trial Number			10			
Number of Bursts in Trial			17			
Chirp Center Frequency			5500			
Burst	No. of Pulses	Pulse Width (us)	Chirp Width (MHz)	Pulse 1-to-2 Spacing (us)	Pulse 2-to-3 Spacing (us)	Starting Location Within Interval (ms)
1	2	74.4	14	1107	-	462
2	1	87.6	14	-	-	653
3	2	61.7	14	1741	-	457
4	2	57.5	14	1566	-	388
5	2	66.1	14	1855	-	63
6	3	70.1	14	1044	1012	136
7	1	66.4	14	-	-	343
8	1	59.2	14	-	-	349
9	2	88.3	14	1240	-	362
10	1	64.7	14	-	-	221
11	2	73	14	1703	-	144
12	2	81.7	14	1450	-	671
13	3	70.1	14	1741	1278	320
14	1	63.6	14	-	-	196
15	1	58.7	14	-	-	413
16	2	65.9	14	1478	-	170
17	1	72.7	14	-	-	564
Detection Check (1=Detection; 0=No Detection)						1



Trial Number			11			
Number of Bursts in Trial			18			
Chirp Center Frequency			5497			
Burst	No. of Pulses	Pulse Width (us)	Chirp Width (MHz)	Pulse 1-to-2 Spacing (us)	Pulse 2-to-3 Spacing (us)	Starting Location Within Interval (ms)
1	2	72.1	15	1193	-	130
2	3	76.3	15	1484	1390	114
3	1	86.1	15	-	-	14
4	1	73.2	15	-	-	604
5	1	81.2	15	-	-	548
6	2	99.5	15	1398	-	173
7	1	93.9	15	-	-	262
8	2	75.9	15	1921	-	38
9	3	79.2	15	1100	1429	84
10	3	77	15	1166	1799	610
11	1	91.8	15	-	-	339
12	3	56.8	15	1330	1556	580
13	2	83.1	15	1556	-	295
14	2	63	15	1552	-	156
15	1	65.7	15	-	-	439
16	1	64.5	15	-	-	188
17	1	88.5	15	-	-	419
18	1	60.6	15	-	-	205
Detection Check (1=Detection; 0=No Detection)						1



Trial Number			12			
Number of Bursts in Trial			19			
Chirp Center Frequency			5497			
Burst	No. of Pulses	Pulse Width (us)	Chirp Width (MHz)	Pulse 1-to-2 Spacing (us)	Pulse 2-to-3 Spacing (us)	Starting Location Within Interval (ms)
1	2	90.5	16	1299	-	381
2	2	88.4	16	1418	-	327
3	2	53.7	16	1055	-	536
4	1	80.5	16	-	-	285
5	1	50.4	16	-	-	398
6	2	61.2	16	1749	-	439
7	2	78.8	16	1065	-	129
8	3	75	16	1748	1820	325
9	2	96.7	16	1254	-	440
10	3	76.3	16	1848	1106	397
11	1	73.3	16	-	-	232
12	2	92.4	16	1317	-	91
13	2	92.4	16	1854	-	256
14	3	64.4	16	1240	1634	582
15	2	67.3	16	1473	-	117
16	2	84.1	16	1795	-	202
17	1	80.9	16	-	-	135
18	1	74.6	16	-	-	396
19	2	97.6	16	1805	-	615
Detection Check (1=Detection; 0=No Detection)						1



Trial Number							13
Number of Bursts in Trial							20
Chirp Center Frequency							5497
Burst	No. of Pulses	Pulse Width (us)	Chirp Width (MHz)	Pulse 1-to-2 Spacing (us)	Pulse 2-to-3 Spacing (us)	Starting Location Within Interval (ms)	
1	2	66.1	17	1417	-	388	
2	2	86.7	17	1693	-	348	
3	2	70.5	17	1263	-	215	
4	2	78	17	1446	-	28	
5	2	66	17	1185	-	585	
6	2	80.6	17	1855	-	65	
7	1	95.5	17	-	-	92	
8	1	98.8	17	-	-	68	
9	3	64.3	17	1641	1108	517	
10	1	75.1	17	-	-	121	
11	2	72.6	17	1499	-	448	
12	1	60.3	17	-	-	567	
13	2	54.9	17	1056	-	245	
14	2	98.8	17	1023	-	584	
15	2	60.9	17	1243	-	579	
16	2	62.7	17	1226	-	464	
17	1	80.1	17	-	-	89	
18	2	70.9	17	1711	-	153	
19	1	90.7	17	-	-	282	
20	1	98.9	17	-	-	71	
Detection Check (1=Detection; 0=No Detection)							1

Trial Number							14
Number of Bursts in Trial							8
Chirp Center Frequency							5499
Burst	No. of Pulses	Pulse Width (us)	Chirp Width (MHz)	Pulse 1-to-2 Spacing (us)	Pulse 2-to-3 Spacing (us)	Starting Location Within Interval (ms)	
1	2	67.5	20	1542	-	947	
2	3	83.6	20	1272	1696	124	
3	2	93.2	20	1877	-	701	
4	1	55.6	20	-	-	1123	
5	3	84.2	20	1733	1619	756	
6	3	69.1	20	1612	1071	1	
7	2	66.9	20	1905	-	7	
8	3	86.8	20	1697	1621	1082	
Detection Check (1=Detection; 0=No Detection)							0



Trial Number							15
Number of Bursts in Trial							9
Chirp Center Frequency							5498
Burst	No. of Pulses	Pulse Width (us)	Chirp Width (MHz)	Pulse 1-to-2 Spacing (us)	Pulse 2-to-3 Spacing (us)	Starting Location Within Interval (ms)	
1	2	62.2	19	1571	-	949	
2	2	85	19	1669	-	189	
3	2	64.5	19	1505	-	176	
4	2	50.4	19	1325	-	538	
5	2	66.1	19	1483	-	908	
6	2	71.2	19	1110	-	1017	
7	3	53.7	19	1445	1677	492	
8	3	62.5	19	1596	1341	349	
9	3	62	19	1929	1221	1105	
Detection Check (1=Detection; 0=No Detection)							0

Trial Number							16
Number of Bursts in Trial							10
Chirp Center Frequency							5498
Burst	No. of Pulses	Pulse Width (us)	Chirp Width (MHz)	Pulse 1-to-2 Spacing (us)	Pulse 2-to-3 Spacing (us)	Starting Location Within Interval (ms)	
1	2	80.5	18	1910	-	284	
2	2	64.2	18	1661	-	751	
3	2	90.1	18	1041	-	491	
4	2	69.8	18	1495	-	107	
5	1	73.1	18	-	-	490	
6	3	77.2	18	1418	1145	1155	
7	3	52.6	18	1732	1787	772	
8	2	71.4	18	1562	-	121	
9	2	89.8	18	1491	-	89	
10	2	76.4	18	1355	-	615	
Detection Check (1=Detection; 0=No Detection)							0



Trial Number							17
Number of Bursts in Trial							11
Chirp Center Frequency							5497
Burst	No. of Pulses	Pulse Width (us)	Chirp Width (MHz)	Pulse 1-to-2 Spacing (us)	Pulse 2-to-3 Spacing (us)	Starting Location Within Interval (ms)	
1	2	51.2	17	1236	-	740	
2	1	71.7	17	-	-	941	
3	2	74.7	17	1164	-	370	
4	2	50.9	17	1919	-	371	
5	2	65.2	17	1206	-	1033	
6	2	98	17	1182	-	346	
7	2	58.7	17	1612	-	639	
8	1	63.8	17	-	-	1056	
9	3	86.3	17	1545	1065	205	
10	1	94.4	17	-	-	753	
11	3	88.5	17	1699	1319	58	
Detection Check (1=Detection; 0=No Detection)							1

Trial Number							18
Number of Bursts in Trial							12
Chirp Center Frequency							5497
Burst	No. of Pulses	Pulse Width (us)	Chirp Width (MHz)	Pulse 1-to-2 Spacing (us)	Pulse 2-to-3 Spacing (us)	Starting Location Within Interval (ms)	
1	2	88.7	16	1405	-	448	
2	3	90.2	16	1544	1235	621	
3	1	96.5	16	-	-	512	
4	2	80.5	16	1090	-	321	
5	2	63.7	16	1268	-	798	
6	1	53.4	16	-	-	809	
7	2	52.3	16	1043	-	301	
8	3	54.7	16	1701	1104	796	
9	3	75.6	16	1923	1729	669	
10	2	59.2	16	1244	-	369	
11	1	56.3	16	-	-	51	
12	2	87.8	16	1608	-	733	
Detection Check (1=Detection; 0=No Detection)							1



Trial Number							19
Number of Bursts in Trial							13
Chirp Center Frequency							5497
Burst	No. of Pulses	Pulse Width (us)	Chirp Width (MHz)	Pulse 1-to-2 Spacing (us)	Pulse 2-to-3 Spacing (us)	Starting Location Within Interval (ms)	
1	2	68.2	15	1104	-	229	
2	2	58.4	15	1627	-	488	
3	3	74.7	15	1861	1015	137	
4	2	58.2	15	1593	-	520	
5	1	51.6	15	-	-	799	
6	2	94.7	15	1469	-	43	
7	2	70.7	15	1091	-	126	
8	2	82.9	15	1472	-	607	
9	3	62.7	15	1168	1453	527	
10	2	63.1	15	1529	-	143	
11	1	96.1	15	-	-	176	
12	2	57	15	1457	-	882	
13	3	95.6	15	1707	1501	214	
Detection Check (1=Detection; 0=No Detection)							1

Trial Number							20
Number of Bursts in Trial							14
Chirp Center Frequency							5496
Burst	No. of Pulses	Pulse Width (us)	Chirp Width (MHz)	Pulse 1-to-2 Spacing (us)	Pulse 2-to-3 Spacing (us)	Starting Location Within Interval (ms)	
1	1	95.7	14	-	-	117	
2	1	93.1	14	-	-	720	
3	1	55.8	14	-	-	297	
4	1	76.7	14	-	-	284	
5	2	68	14	1686	-	472	
6	3	94.1	14	1796	1393	264	
7	2	53.9	14	1293	-	525	
8	1	99.3	14	-	-	155	
9	2	73.3	14	1458	-	65	
10	2	93.3	14	1196	-	451	
11	3	55.8	14	1895	1034	243	
12	1	66.4	14	-	-	228	
13	2	65.6	14	1732	-	746	
14	2	76.5	14	1187	-	522	
Detection Check (1=Detection; 0=No Detection)							1



Trial Number							21
Number of Bursts in Trial							15
Chirp Center Frequency							5504
Burst	No. of Pulses	Pulse Width (us)	Chirp Width (MHz)	Pulse 1-to-2 Spacing (us)	Pulse 2-to-3 Spacing (us)	Starting Location Within Interval (ms)	
1	1	85.1	13	-	-	565	
2	2	72.5	13	1648	-	211	
3	1	67.5	13	-	-	348	
4	2	56.1	13	1360	-	156	
5	1	71.1	13	-	-	718	
6	2	93.1	13	1391	-	400	
7	1	56.5	13	-	-	482	
8	1	63.8	13	-	-	703	
9	2	67.4	13	1727	-	780	
10	1	52.3	13	-	-	102	
11	3	62.4	13	1228	1715	304	
12	2	53.3	13	1630	-	57	
13	2	83.1	13	1205	-	768	
14	2	93.7	13	1085	-	461	
15	2	90.7	13	1297	-	746	
Detection Check (1=Detection; 0=No Detection)							1

Trial Number							22
Number of Bursts in Trial							16
Chirp Center Frequency							5505
Burst	No. of Pulses	Pulse Width (us)	Chirp Width (MHz)	Pulse 1-to-2 Spacing (us)	Pulse 2-to-3 Spacing (us)	Starting Location Within Interval (ms)	
1	2	98.8	12	1439	-	95	
2	1	54.5	12	-	-	676	
3	2	80.5	12	1360	-	8	
4	2	55.9	12	1906	-	373	
5	2	72.1	12	1623	-	254	
6	2	84.4	12	1604	-	480	
7	1	78.5	12	-	-	663	
8	1	88	12	-	-	314	
9	2	74.7	12	1157	-	596	
10	2	97.1	12	1673	-	264	
11	1	81.6	12	-	-	740	
12	1	83.6	12	-	-	163	
13	3	87.6	12	1757	1322	628	
14	2	58.5	12	1372	-	132	
15	3	91.8	12	1767	1183	106	
16	2	58.8	12	1432	-	659	
Detection Check (1=Detection; 0=No Detection)							1



Trial Number			23			
Number of Bursts in Trial			17			
Chirp Center Frequency			5505			
Burst	No. of Pulses	Pulse Width (us)	Chirp Width (MHz)	Pulse 1-to-2 Spacing (us)	Pulse 2-to-3 Spacing (us)	Starting Location Within Interval (ms)
1	1	96	11	-	-	284
2	2	92.5	11	1241	-	488
3	2	89.5	11	1347	-	76
4	2	74.8	11	1607	-	688
5	2	60.6	11	1523	-	28
6	2	71.5	11	1659	-	383
7	2	71.1	11	1454	-	182
8	1	98.7	11	-	-	20
9	2	85.1	11	1770	-	576
10	2	89.2	11	1086	-	410
11	2	60.7	11	1101	-	458
12	2	75.2	11	1719	-	348
13	2	75.7	11	1799	-	481
14	3	56.7	11	1132	1884	587
15	2	65	11	1885	-	480
16	2	64.6	11	1910	-	195
17	3	69.9	11	1410	1190	396
Detection Check (1=Detection; 0=No Detection)						1



Trial Number			24			
Number of Bursts in Trial			18			
Chirp Center Frequency			5506			
Burst	No. of Pulses	Pulse Width (us)	Chirp Width (MHz)	Pulse 1-to-2 Spacing (us)	Pulse 2-to-3 Spacing (us)	Starting Location Within Interval (ms)
1	3	83.8	10	1290	1021	536
2	2	66.9	10	1112	-	44
3	3	91	10	1220	1504	611
4	2	86.1	10	1678	-	456
5	3	65.5	10	1928	1222	330
6	1	62.6	10	-	-	297
7	3	68.7	10	1505	1200	351
8	3	59.2	10	1452	1114	230
9	1	73.9	10	-	-	222
10	1	77.2	10	-	-	57
11	2	96.4	10	1357	-	399
12	2	99.9	10	1173	-	299
13	2	99.9	10	1520	-	464
14	1	86.7	10	-	-	294
15	1	92.6	10	-	-	653
16	1	77.1	10	-	-	550
17	2	81.1	10	1664	-	566
18	3	68.4	10	1536	1309	580
Detection Check (1=Detection; 0=No Detection)						1



Trial Number			25			
Number of Bursts in Trial			19			
Chirp Center Frequency			5506			
Burst	No. of Pulses	Pulse Width (us)	Chirp Width (MHz)	Pulse 1-to-2 Spacing (us)	Pulse 2-to-3 Spacing (us)	Starting Location Within Interval (ms)
1	3	68.2	9	1723	1868	471
2	3	83.7	9	1711	1405	368
3	2	69.7	9	1781	-	425
4	1	59.7	9	-	-	440
5	2	96.7	9	1484	-	123
6	2	95.8	9	1319	-	261
7	3	71.3	9	1095	1354	332
8	3	53.2	9	1527	1427	427
9	2	69.5	9	1771	-	397
10	3	63.9	9	1075	1447	67
11	2	93.4	9	1783	-	174
12	2	77.3	9	1564	-	17
13	2	73.1	9	1294	-	216
14	1	77.4	9	-	-	292
15	3	57.2	9	1722	1886	619
16	2	68.7	9	1629	-	233
17	1	60.8	9	-	-	226
18	3	69.7	9	1128	1224	599
19	1	62.2	9	-	-	433
Detection Check (1=Detection; 0=No Detection)						1



Trial Number							26
Number of Bursts in Trial							20
Chirp Center Frequency							5506
Burst	No. of Pulses	Pulse Width (us)	Chirp Width (MHz)	Pulse 1-to-2 Spacing (us)	Pulse 2-to-3 Spacing (us)	Starting Location Within Interval (ms)	
1	1	80.5	8	-	-	90	
2	3	62.6	8	1406	1343	319	
3	3	85.6	8	1190	1529	384	
4	2	83.9	8	1208	-	567	
5	2	92.4	8	1488	-	234	
6	2	54	8	1529	-	535	
7	3	81.3	8	1501	1812	325	
8	1	98.5	8	-	-	532	
9	1	85.8	8	-	-	272	
10	2	84.7	8	1593	-	182	
11	2	83.3	8	1705	-	134	
12	2	79.8	8	1567	-	286	
13	1	77.9	8	-	-	368	
14	3	98.4	8	1510	1569	290	
15	2	79.9	8	1588	-	231	
16	3	78	8	1140	1353	353	
17	3	55.2	8	1700	1327	53	
18	3	71.9	8	1081	1224	44	
19	1	62	8	-	-	298	
20	3	70.5	8	1888	1442	529	
Detection Check (1=Detection; 0=No Detection)							1

Trial Number							27
Number of Bursts in Trial							8
Chirp Center Frequency							5502
Burst	No. of Pulses	Pulse Width (us)	Chirp Width (MHz)	Pulse 1-to-2 Spacing (us)	Pulse 2-to-3 Spacing (us)	Starting Location Within Interval (ms)	
1	2	69.1	18	1076	-	1436	
2	2	62.1	18	1688	-	22	
3	2	94.8	18	1891	-	897	
4	1	75.8	18	-	-	1186	
5	2	65.4	18	1713	-	589	
6	2	97.7	18	1292	-	614	
7	3	98.1	18	1670	1711	506	
8	2	85.4	18	1672	-	776	
Detection Check (1=Detection; 0=No Detection)							0



Trial Number							28
Number of Bursts in Trial							9
Chirp Center Frequency							5502
Burst	No. of Pulses	Pulse Width (us)	Chirp Width (MHz)	Pulse 1-to-2 Spacing (us)	Pulse 2-to-3 Spacing (us)	Starting Location Within Interval (ms)	
1	3	82	19	1233	1713	679	
2	3	87.7	19	1554	1123	473	
3	2	98.9	19	1518	-	869	
4	1	55	19	-	-	719	
5	1	93.6	19	-	-	902	
6	2	58.7	19	1641	-	1243	
7	2	88.7	19	1387	-	410	
8	1	60.3	19	-	-	1154	
9	1	97.7	19	-	-	512	
Detection Check (1=Detection; 0=No Detection)							0

Trial Number							29
Number of Bursts in Trial							10
Chirp Center Frequency							5502
Burst	No. of Pulses	Pulse Width (us)	Chirp Width (MHz)	Pulse 1-to-2 Spacing (us)	Pulse 2-to-3 Spacing (us)	Starting Location Within Interval (ms)	
1	1	69.6	20	-	-	1131	
2	1	74.5	20	-	-	290	
3	1	60.9	20	-	-	895	
4	1	74.6	20	-	-	202	
5	2	99.3	20	1501	-	139	
6	2	95.3	20	1065	-	854	
7	2	91.9	20	1722	-	219	
8	2	51	20	1285	-	57	
9	2	87.7	20	1747	-	141	
10	1	87.2	20	-	-	596	
Detection Check (1=Detection; 0=No Detection)							0



Trial Number		30				
Number of Bursts in Trial		11				
Chirp Center Frequency		5508				
Burst	No. of Pulses	Pulse Width (us)	Chirp Width (MHz)	Pulse 1-to-2 Spacing (us)	Pulse 2-to-3 Spacing (us)	Starting Location Within Interval (ms)
1	3	59.9	5	1901	1196	935
2	2	77.1	5	1590	-	1038
3	2	62.7	5	1227	-	690
4	1	77.1	5	-	-	547
5	3	99.8	5	1798	1790	551
6	2	61.5	5	1135	-	876
7	2	77.5	5	1583	-	448
8	2	57.3	5	1890	-	736
9	2	53.5	5	1757	-	362
10	1	66.6	5	-	-	836
11	3	80.7	5	1811	1289	410
Detection Check (1=Detection; 0=No Detection)						1



Type 6 Radar Statistical Performance

Trial #	Test Freq. (MHz)	Pulses / Hop	Pulse Width (us)	PRI (us)	1=Detection 0=No Detection
1	5500	9	1	333	1
2	5500	9	1	333	1
3	5500	9	1	333	1
4	5500	9	1	333	1
5	5500	9	1	333	1
6	5500	9	1	333	1
7	5500	9	1	333	1
8	5500	9	1	333	1
9	5500	9	1	333	1
10	5500	9	1	333	1
11	5500	9	1	333	1
12	5500	9	1	333	1
13	5500	9	1	333	1
14	5500	9	1	333	1
15	5500	9	1	333	1
16	5500	9	1	333	1
17	5500	9	1	333	1
18	5500	9	1	333	0
19	5500	9	1	333	1
20	5500	9	1	333	1
21	5500	9	1	333	1
22	5500	9	1	333	1
23	5500	9	1	333	1
24	5500	9	1	333	1
25	5500	9	1	333	1
26	5500	9	1	333	1
27	5500	9	1	333	1
28	5500	9	1	333	1
29	5500	9	1	333	1
30	5500	9	1	333	1
Detection Percentage (%)					96.667
Limit					70%
Test Result					Complied



Modulation Mode: 802.11ac (VHT40)

Type 1 Radar Statistical Performance

Trial #	Test Freq. (MHz)	Pulse Repetition Frequency Number	Pulse Repetition Frequency (Pulse Per Second)	PRI (us)	1=Detection 0=No Detection
1	5520	1	1930.5	518	1
2	5498	23	326.2	3066	1
3	5509	19	1139.0	878	1
4	5494	12	1355.0	738	1
5	5505	4	1730.1	578	1
6	5491	8	1519.8	658	1
7	5524	15	1253.1	798	1
8	5506	6	1618.1	618	1
9	5517	14	1285.3	778	1
10	5510	3	1792.1	558	1
11	5528	13	1319.3	758	1
12	5507	9	1474.9	678	1
13	5516	7	1567.4	638	1
14	5529	17	1193.3	838	0
15	5525	10	1432.7	698	1
16	5499	-	1692.0	591	1
17	5525	-	328.1	3048	1
18	5524	-	373.4	2678	1
19	5521	-	574.4	1741	1
20	5514	-	1216.5	822	1
21	5511	-	801.3	1248	1
22	5502	-	488.5	2047	1
23	5509	-	956.0	1046	1
24	5499	-	517.6	1932	1
25	5511	-	1422.5	703	1
26	5504	-	542.0	1845	1
27	5510	-	741.3	1349	1
28	5507	-	881.8	1134	1
29	5520	-	427.4	2340	1
30	5521	-	628.9	1590	1
Detection Percentage (%)					96.667
Limit					60%
Test Result					Complied



Type 2 Radar Statistical Performance

Trial #	Test Freq. (MHz)	Pulse Width (us)	PRI (us)	Pulses / Burst	1=Detection 0=No Detection
1	5520	2.6	221	23	1
2	5498	4.6	198	27	1
3	5509	1.1	184	29	1
4	5494	4.8	203	24	1
5	5505	2.4	162	25	1
6	5491	3.4	204	28	1
7	5524	2.3	170	27	1
8	5506	3.5	184	23	1
9	5517	4.9	150	27	1
10	5510	4.6	211	29	1
11	5528	2.9	158	23	0
12	5507	2.6	226	27	1
13	5516	1.6	204	26	1
14	5529	3.9	181	25	1
15	5525	4.6	202	24	1
16	5499	4.1	194	27	0
17	5525	2.3	193	28	1
18	5524	3.9	173	29	1
19	5521	4.3	188	23	1
20	5514	1.5	215	26	1
21	5511	4.9	227	27	1
22	5502	1.1	199	23	1
23	5509	4.5	155	29	1
24	5499	4.0	190	27	0
25	5511	2.4	151	23	1
26	5504	2.5	180	28	1
27	5510	2.5	228	23	1
28	5507	2.5	203	25	1
29	5520	1.5	188	25	1
30	5521	1.9	217	24	1
Detection Percentage (%)					90.000
Limit					60%
Test Result					Complied



Type 3 Radar Statistical Performance

Trial #	Test Freq. (MHz)	Pulse Width (us)	PRI (us)	Pulses / Burst	1=Detection 0=No Detection
1	5520	8.0	205	16	1
2	5498	6.7	382	18	1
3	5509	8.6	418	16	1
4	5494	9.4	351	17	1
5	5505	7.4	383	18	1
6	5491	9.8	232	16	1
7	5524	9.1	377	17	1
8	5506	9.6	457	16	1
9	5517	8.0	471	18	1
10	5510	9.0	304	18	1
11	5528	8.0	316	17	0
12	5507	9.8	325	16	1
13	5516	8.0	409	17	1
14	5529	9.9	200	17	1
15	5525	8.8	458	16	1
16	5499	8.0	232	18	0
17	5525	8.3	250	16	1
18	5524	8.7	270	16	1
19	5521	7.7	350	17	1
20	5514	7.1	230	16	1
21	5511	7.3	416	18	1
22	5502	7.6	498	18	1
23	5509	7.3	286	17	1
24	5499	7.3	287	16	1
25	5511	7.5	462	17	1
26	5504	6.2	300	17	0
27	5510	6.4	323	18	1
28	5507	7.1	420	16	1
29	5520	7.2	395	18	1
30	5521	8.4	377	16	1
Detection Percentage (%)					90.000
Limit					60%
Test Result					Complied



Type 4 Radar Statistical Performance

Trial #	Test Freq. (MHz)	Pulse Width (us)	PRI (us)	Pulses / Burst	1=Detection 0=No Detection
1	5520	18.0	242	15	1
2	5498	19.9	279	12	1
3	5509	12.9	487	14	1
4	5494	15.0	452	13	1
5	5505	16.3	230	12	1
6	5491	19.8	238	13	0
7	5524	18.2	420	16	1
8	5506	16.3	452	15	1
9	5517	14.2	495	12	1
10	5510	17.8	228	16	1
11	5528	19.1	211	16	1
12	5507	18.4	283	15	1
13	5516	11.8	411	12	1
14	5529	14.2	284	13	1
15	5525	13.9	202	12	0
16	5499	17.8	340	14	1
17	5525	15.6	290	16	1
18	5524	14.6	250	16	1
19	5521	14.4	484	15	1
20	5514	18.9	387	13	1
21	5511	11.1	348	15	1
22	5502	13.8	291	16	0
23	5509	14.3	295	12	1
24	5499	12.5	300	12	1
25	5511	12.5	322	14	1
26	5504	12.5	383	13	1
27	5510	15.7	322	16	0
28	5507	19.8	469	13	1
29	5520	18.6	406	15	1
30	5521	15.9	238	14	1
Detection Percentage (%)					86.667
Limit					60%
Test Result					Complied



Total Type 1~4 Radar Statistical Performance

Radar Type #	Detection Percentage (%)
1	96.667
2	90.000
3	90.000
4	86.667
Aggregate (Radar Types 1-4)	90.833
Limit	80%
Test Result	Complied



Type 5 Radar Statistical Performance

Center Freq. (MHz)	Low Edge (MHz)	High Edge (MHz)	VSG Freq. (MHz)	Detection
Trial	Chirp	Offset		
5510	5491	5529		
1	5	2	5510	0
2	20	8	5510	1
3	7	2.8	5510	1
4	8	3.2	5510	1
5	9	3.6	5510	1
6	10	4	5510	1
7	11	4.4	5510	1
8	12	4.8	5510	1
9	13	5.2	5510	1
10	14	5.6	5510	1
11	15	6	5497	1
12	16	6.4	5497	1
13	17	6.8	5498	1
14	20	8	5499	1
15	19	7.6	5499	0
16	18	7.2	5498	1
17	17	6.8	5498	1
18	16	6.4	5497	1
19	15	6	5497	1
20	14	5.6	5497	1
21	13	5.2	5524	1
22	12	4.8	5524	0
23	11	4.4	5525	1
24	10	4	5525	1
25	9	3.6	5525	1
26	8	3.2	5526	1
27	18	7.2	5522	1
28	19	7.6	5521	1
29	20	8	5521	1
30	5	2	5527	1
Total				27
Detection Percentage (%)				90%
Limit				80%
Test Result				Complied



Trial Number		1				
Number of Bursts in Trial		8				
Chirp Center Frequency		5510				
Burst	No. of Pulses	Pulse Width (us)	Chirp Width (MHz)	Pulse 1-to-2 Spacing (us)	Pulse 2-to-3 Spacing (us)	Starting Location Within Interval (ms)
1	1	62.1	5	-	-	1091
2	2	56	5	1729	-	133
3	2	91.3	5	1230	-	1057
4	3	50.7	5	1762	1616	1442
5	2	92.6	5	1723	-	544
6	2	87.3	5	1302	-	1089
7	2	59.5	5	1291	-	1374
8	2	52.2	5	1653	-	1237
Detection Check (1=Detection; 0=No Detection)						0

Trial Number		2				
Number of Bursts in Trial		9				
Chirp Center Frequency		5510				
Burst	No. of Pulses	Pulse Width (us)	Chirp Width (MHz)	Pulse 1-to-2 Spacing (us)	Pulse 2-to-3 Spacing (us)	Starting Location Within Interval (ms)
1	3	90	20	1007	1326	30
2	2	73.7	20	1785	-	979
3	1	78.1	20	-	-	683
4	2	92.4	20	1281	-	950
5	1	61.2	20	-	-	612
6	3	67.2	20	1525	1870	17
7	1	78.5	20	-	-	429
8	2	60.3	20	1931	-	936
9	3	92.9	20	1403	1476	548
Detection Check (1=Detection; 0=No Detection)						1



Trial Number							3
Number of Bursts in Trial							10
Chirp Center Frequency							5510
Burst	No. of Pulses	Pulse Width (us)	Chirp Width (MHz)	Pulse 1-to-2 Spacing (us)	Pulse 2-to-3 Spacing (us)	Starting Location Within Interval (ms)	
1	3	63.4	7	1574	1607	801	
2	1	98	7	-	-	966	
3	1	58.7	7	-	-	185	
4	1	88	7	-	-	1012	
5	3	79.5	7	1562	1370	943	
6	3	57.1	7	1900	1188	686	
7	2	64.4	7	1090	-	599	
8	1	78.7	7	-	-	1089	
9	1	69.3	7	-	-	188	
10	3	55.3	7	1375	1691	933	
Detection Check (1=Detection; 0=No Detection)							1

Trial Number							4
Number of Bursts in Trial							11
Chirp Center Frequency							5510
Burst	No. of Pulses	Pulse Width (us)	Chirp Width (MHz)	Pulse 1-to-2 Spacing (us)	Pulse 2-to-3 Spacing (us)	Starting Location Within Interval (ms)	
1	2	74.3	8	1642	-	24	
2	1	83.1	8	-	-	985	
3	2	59.5	8	1680	-	988	
4	2	59.8	8	1786	-	800	
5	2	77.6	8	1617	-	339	
6	2	79.9	8	1553	-	1040	
7	1	56	8	-	-	544	
8	3	71.4	8	1406	1927	452	
9	1	97.4	8	-	-	204	
10	2	98.3	8	1037	-	926	
11	1	63.6	8	-	-	1052	
Detection Check (1=Detection; 0=No Detection)							1



Trial Number							5
Number of Bursts in Trial							12
Chirp Center Frequency							5510
Burst	No. of Pulses	Pulse Width (us)	Chirp Width (MHz)	Pulse 1-to-2 Spacing (us)	Pulse 2-to-3 Spacing (us)	Starting Location Within Interval (ms)	
1	1	50	9	-	-	557	
2	2	62.5	9	1731	-	567	
3	2	55.4	9	1070	-	460	
4	1	65.7	9	-	-	4	
5	2	58	9	1512	-	64	
6	2	60.9	9	1230	-	650	
7	3	89.6	9	1598	1738	235	
8	3	84.4	9	1271	1617	873	
9	3	72.3	9	1498	1321	901	
10	1	58.9	9	-	-	663	
11	2	74.8	9	1584	-	919	
12	1	71.8	9	-	-	375	
Detection Check (1=Detection; 0=No Detection)							1

Trial Number							6
Number of Bursts in Trial							13
Chirp Center Frequency							5510
Burst	No. of Pulses	Pulse Width (us)	Chirp Width (MHz)	Pulse 1-to-2 Spacing (us)	Pulse 2-to-3 Spacing (us)	Starting Location Within Interval (ms)	
1	2	88.1	10	1257	-	846	
2	1	58.7	10	-	-	725	
3	2	97.1	10	1037	-	30	
4	3	83.1	10	1029	1106	490	
5	1	62.1	10	-	-	262	
6	2	71.4	10	1058	-	283	
7	2	86.3	10	1867	-	49	
8	3	77.3	10	1418	1876	634	
9	1	78.9	10	-	-	304	
10	3	79.2	10	1055	1572	564	
11	3	52	10	1582	1836	852	
12	3	56.5	10	1195	1542	525	
13	3	100	10	1638	1729	750	
Detection Check (1=Detection; 0=No Detection)							1



Trial Number							7
Number of Bursts in Trial							14
Chirp Center Frequency							5510
Burst	No. of Pulses	Pulse Width (us)	Chirp Width (MHz)	Pulse 1-to-2 Spacing (us)	Pulse 2-to-3 Spacing (us)	Starting Location Within Interval (ms)	
1	2	92.7	11	1208	-	231	
2	2	81.3	11	1144	-	804	
3	2	60.4	11	1555	-	34	
4	2	62.1	11	1320	-	427	
5	1	50	11	-	-	577	
6	3	65.9	11	1020	1365	3	
7	2	73.8	11	1308	-	51	
8	2	74.3	11	1143	-	360	
9	1	62.9	11	-	-	394	
10	2	74.8	11	1404	-	317	
11	2	69.7	11	1309	-	532	
12	2	69.8	11	1688	-	339	
13	2	77.4	11	1857	-	381	
14	1	55.1	11	-	-	426	
Detection Check (1=Detection; 0=No Detection)							1

Trial Number							8
Number of Bursts in Trial							15
Chirp Center Frequency							5510
Burst	No. of Pulses	Pulse Width (us)	Chirp Width (MHz)	Pulse 1-to-2 Spacing (us)	Pulse 2-to-3 Spacing (us)	Starting Location Within Interval (ms)	
1	1	91.7	12	-	-	776	
2	2	90	12	1196	-	187	
3	3	92.3	12	1486	1853	448	
4	2	66.8	12	1545	-	702	
5	1	64	12	-	-	403	
6	3	95.4	12	1123	1473	230	
7	3	66.8	12	1867	1401	604	
8	3	67.7	12	1472	1397	38	
9	1	68.2	12	-	-	735	
10	2	82.2	12	1297	-	610	
11	1	92.1	12	-	-	618	
12	2	57	12	1764	-	705	
13	2	58.5	12	1310	-	22	
14	3	85.5	12	1630	1447	641	
15	2	82.2	12	1371	-	109	
Detection Check (1=Detection; 0=No Detection)							1



Trial Number			9			
Number of Bursts in Trial			16			
Chirp Center Frequency			5510			
Burst	No. of Pulses	Pulse Width (us)	Chirp Width (MHz)	Pulse 1-to-2 Spacing (us)	Pulse 2-to-3 Spacing (us)	Starting Location Within Interval (ms)
1	2	74.4	13	1707	-	442
2	2	63.6	13	1725	-	280
3	2	71.3	13	1704	-	459
4	3	77.6	13	1063	1405	197
5	3	65.2	13	1731	1294	101
6	3	55.1	13	1109	1549	17
7	2	96.8	13	1034	-	131
8	3	80.8	13	1533	1051	365
9	1	60.4	13	-	-	222
10	2	61.8	13	1312	-	371
11	2	71.3	13	1657	-	33
12	2	98.1	13	1024	-	291
13	1	57.9	13	-	-	188
14	1	91.8	13	-	-	163
15	2	56.7	13	1259	-	426
16	2	89.7	13	1690	-	606
Detection Check (1=Detection; 0=No Detection)						1



Trial Number			10			
Number of Bursts in Trial			17			
Chirp Center Frequency			5510			
Burst	No. of Pulses	Pulse Width (us)	Chirp Width (MHz)	Pulse 1-to-2 Spacing (us)	Pulse 2-to-3 Spacing (us)	Starting Location Within Interval (ms)
1	2	74.4	14	1107	-	462
2	1	87.6	14	-	-	653
3	2	61.7	14	1741	-	457
4	2	57.5	14	1566	-	388
5	2	66.1	14	1855	-	63
6	3	70.1	14	1044	1012	136
7	1	66.4	14	-	-	343
8	1	59.2	14	-	-	349
9	2	88.3	14	1240	-	362
10	1	64.7	14	-	-	221
11	2	73	14	1703	-	144
12	2	81.7	14	1450	-	671
13	3	70.1	14	1741	1278	320
14	1	63.6	14	-	-	196
15	1	58.7	14	-	-	413
16	2	65.9	14	1478	-	170
17	1	72.7	14	-	-	564
Detection Check (1=Detection; 0=No Detection)						1



Trial Number		11				
Number of Bursts in Trial		18				
Chirp Center Frequency		5497				
Burst	No. of Pulses	Pulse Width (us)	Chirp Width (MHz)	Pulse 1-to-2 Spacing (us)	Pulse 2-to-3 Spacing (us)	Starting Location Within Interval (ms)
1	2	72.1	15	1193	-	130
2	3	76.3	15	1484	1390	114
3	1	86.1	15	-	-	14
4	1	73.2	15	-	-	604
5	1	81.2	15	-	-	548
6	2	99.5	15	1398	-	173
7	1	93.9	15	-	-	262
8	2	75.9	15	1921	-	38
9	3	79.2	15	1100	1429	84
10	3	77	15	1166	1799	610
11	1	91.8	15	-	-	339
12	3	56.8	15	1330	1556	580
13	2	83.1	15	1556	-	295
14	2	63	15	1552	-	156
15	1	65.7	15	-	-	439
16	1	64.5	15	-	-	188
17	1	88.5	15	-	-	419
18	1	60.6	15	-	-	205
Detection Check (1=Detection; 0=No Detection)						1



Trial Number			12			
Number of Bursts in Trial			19			
Chirp Center Frequency			5497			
Burst	No. of Pulses	Pulse Width (us)	Chirp Width (MHz)	Pulse 1-to-2 Spacing (us)	Pulse 2-to-3 Spacing (us)	Starting Location Within Interval (ms)
1	2	90.5	16	1299	-	381
2	2	88.4	16	1418	-	327
3	2	53.7	16	1055	-	536
4	1	80.5	16	-	-	285
5	1	50.4	16	-	-	398
6	2	61.2	16	1749	-	439
7	2	78.8	16	1065	-	129
8	3	75	16	1748	1820	325
9	2	96.7	16	1254	-	440
10	3	76.3	16	1848	1106	397
11	1	73.3	16	-	-	232
12	2	92.4	16	1317	-	91
13	2	92.4	16	1854	-	256
14	3	64.4	16	1240	1634	582
15	2	67.3	16	1473	-	117
16	2	84.1	16	1795	-	202
17	1	80.9	16	-	-	135
18	1	74.6	16	-	-	396
19	2	97.6	16	1805	-	615
Detection Check (1=Detection; 0=No Detection)						1



Trial Number							13
Number of Bursts in Trial							20
Chirp Center Frequency							5498
Burst	No. of Pulses	Pulse Width (us)	Chirp Width (MHz)	Pulse 1-to-2 Spacing (us)	Pulse 2-to-3 Spacing (us)	Starting Location Within Interval (ms)	
1	2	66.1	17	1417	-	388	
2	2	86.7	17	1693	-	348	
3	2	70.5	17	1263	-	215	
4	2	78	17	1446	-	28	
5	2	66	17	1185	-	585	
6	2	80.6	17	1855	-	65	
7	1	95.5	17	-	-	92	
8	1	98.8	17	-	-	68	
9	3	64.3	17	1641	1108	517	
10	1	75.1	17	-	-	121	
11	2	72.6	17	1499	-	448	
12	1	60.3	17	-	-	567	
13	2	54.9	17	1056	-	245	
14	2	98.8	17	1023	-	584	
15	2	60.9	17	1243	-	579	
16	2	62.7	17	1226	-	464	
17	1	80.1	17	-	-	89	
18	2	70.9	17	1711	-	153	
19	1	90.7	17	-	-	282	
20	1	98.9	17	-	-	71	
Detection Check (1=Detection; 0=No Detection)							1

Trial Number							14
Number of Bursts in Trial							8
Chirp Center Frequency							5499
Burst	No. of Pulses	Pulse Width (us)	Chirp Width (MHz)	Pulse 1-to-2 Spacing (us)	Pulse 2-to-3 Spacing (us)	Starting Location Within Interval (ms)	
1	2	67.5	20	1542	-	947	
2	3	83.6	20	1272	1696	124	
3	2	93.2	20	1877	-	701	
4	1	55.6	20	-	-	1123	
5	3	84.2	20	1733	1619	756	
6	3	69.1	20	1612	1071	1	
7	2	66.9	20	1905	-	7	
8	3	86.8	20	1697	1621	1082	
Detection Check (1=Detection; 0=No Detection)							1



Trial Number							15
Number of Bursts in Trial							9
Chirp Center Frequency							5499
Burst	No. of Pulses	Pulse Width (us)	Chirp Width (MHz)	Pulse 1-to-2 Spacing (us)	Pulse 2-to-3 Spacing (us)	Starting Location Within Interval (ms)	
1	2	62.2	19	1571	-	949	
2	2	85	19	1669	-	189	
3	2	64.5	19	1505	-	176	
4	2	50.4	19	1325	-	538	
5	2	66.1	19	1483	-	908	
6	2	71.2	19	1110	-	1017	
7	3	53.7	19	1445	1677	492	
8	3	62.5	19	1596	1341	349	
9	3	62	19	1929	1221	1105	
Detection Check (1=Detection; 0=No Detection)							0

Trial Number							16
Number of Bursts in Trial							10
Chirp Center Frequency							5498
Burst	No. of Pulses	Pulse Width (us)	Chirp Width (MHz)	Pulse 1-to-2 Spacing (us)	Pulse 2-to-3 Spacing (us)	Starting Location Within Interval (ms)	
1	2	80.5	18	1910	-	284	
2	2	64.2	18	1661	-	751	
3	2	90.1	18	1041	-	491	
4	2	69.8	18	1495	-	107	
5	1	73.1	18	-	-	490	
6	3	77.2	18	1418	1145	1155	
7	3	52.6	18	1732	1787	772	
8	2	71.4	18	1562	-	121	
9	2	89.8	18	1491	-	89	
10	2	76.4	18	1355	-	615	
Detection Check (1=Detection; 0=No Detection)							1



Trial Number							17
Number of Bursts in Trial							11
Chirp Center Frequency							5498
Burst	No. of Pulses	Pulse Width (us)	Chirp Width (MHz)	Pulse 1-to-2 Spacing (us)	Pulse 2-to-3 Spacing (us)	Starting Location Within Interval (ms)	
1	2	51.2	17	1236	-	740	
2	1	71.7	17	-	-	941	
3	2	74.7	17	1164	-	370	
4	2	50.9	17	1919	-	371	
5	2	65.2	17	1206	-	1033	
6	2	98	17	1182	-	346	
7	2	58.7	17	1612	-	639	
8	1	63.8	17	-	-	1056	
9	3	86.3	17	1545	1065	205	
10	1	94.4	17	-	-	753	
11	3	88.5	17	1699	1319	58	
Detection Check (1=Detection; 0=No Detection)							1

Trial Number							18
Number of Bursts in Trial							12
Chirp Center Frequency							5497
Burst	No. of Pulses	Pulse Width (us)	Chirp Width (MHz)	Pulse 1-to-2 Spacing (us)	Pulse 2-to-3 Spacing (us)	Starting Location Within Interval (ms)	
1	2	88.7	16	1405	-	448	
2	3	90.2	16	1544	1235	621	
3	1	96.5	16	-	-	512	
4	2	80.5	16	1090	-	321	
5	2	63.7	16	1268	-	798	
6	1	53.4	16	-	-	809	
7	2	52.3	16	1043	-	301	
8	3	54.7	16	1701	1104	796	
9	3	75.6	16	1923	1729	669	
10	2	59.2	16	1244	-	369	
11	1	56.3	16	-	-	51	
12	2	87.8	16	1608	-	733	
Detection Check (1=Detection; 0=No Detection)							1



Trial Number							19
Number of Bursts in Trial							13
Chirp Center Frequency							5497
Burst	No. of Pulses	Pulse Width (us)	Chirp Width (MHz)	Pulse 1-to-2 Spacing (us)	Pulse 2-to-3 Spacing (us)	Starting Location Within Interval (ms)	
1	2	68.2	15	1104	-	229	
2	2	58.4	15	1627	-	488	
3	3	74.7	15	1861	1015	137	
4	2	58.2	15	1593	-	520	
5	1	51.6	15	-	-	799	
6	2	94.7	15	1469	-	43	
7	2	70.7	15	1091	-	126	
8	2	82.9	15	1472	-	607	
9	3	62.7	15	1168	1453	527	
10	2	63.1	15	1529	-	143	
11	1	96.1	15	-	-	176	
12	2	57	15	1457	-	882	
13	3	95.6	15	1707	1501	214	
Detection Check (1=Detection; 0=No Detection)							1

Trial Number							20
Number of Bursts in Trial							14
Chirp Center Frequency							5497
Burst	No. of Pulses	Pulse Width (us)	Chirp Width (MHz)	Pulse 1-to-2 Spacing (us)	Pulse 2-to-3 Spacing (us)	Starting Location Within Interval (ms)	
1	1	95.7	14	-	-	117	
2	1	93.1	14	-	-	720	
3	1	55.8	14	-	-	297	
4	1	76.7	14	-	-	284	
5	2	68	14	1686	-	472	
6	3	94.1	14	1796	1393	264	
7	2	53.9	14	1293	-	525	
8	1	99.3	14	-	-	155	
9	2	73.3	14	1458	-	65	
10	2	93.3	14	1196	-	451	
11	3	55.8	14	1895	1034	243	
12	1	66.4	14	-	-	228	
13	2	65.6	14	1732	-	746	
14	2	76.5	14	1187	-	522	
Detection Check (1=Detection; 0=No Detection)							1



Trial Number							21
Number of Bursts in Trial							15
Chirp Center Frequency							5524
Burst	No. of Pulses	Pulse Width (us)	Chirp Width (MHz)	Pulse 1-to-2 Spacing (us)	Pulse 2-to-3 Spacing (us)	Starting Location Within Interval (ms)	
1	1	85.1	13	-	-	565	
2	2	72.5	13	1648	-	211	
3	1	67.5	13	-	-	348	
4	2	56.1	13	1360	-	156	
5	1	71.1	13	-	-	718	
6	2	93.1	13	1391	-	400	
7	1	56.5	13	-	-	482	
8	1	63.8	13	-	-	703	
9	2	67.4	13	1727	-	780	
10	1	52.3	13	-	-	102	
11	3	62.4	13	1228	1715	304	
12	2	53.3	13	1630	-	57	
13	2	83.1	13	1205	-	768	
14	2	93.7	13	1085	-	461	
15	2	90.7	13	1297	-	746	
Detection Check (1=Detection; 0=No Detection)							1

Trial Number							22
Number of Bursts in Trial							16
Chirp Center Frequency							5524
Burst	No. of Pulses	Pulse Width (us)	Chirp Width (MHz)	Pulse 1-to-2 Spacing (us)	Pulse 2-to-3 Spacing (us)	Starting Location Within Interval (ms)	
1	2	98.8	12	1439	-	95	
2	1	54.5	12	-	-	676	
3	2	80.5	12	1360	-	8	
4	2	55.9	12	1906	-	373	
5	2	72.1	12	1623	-	254	
6	2	84.4	12	1604	-	480	
7	1	78.5	12	-	-	663	
8	1	88	12	-	-	314	
9	2	74.7	12	1157	-	596	
10	2	97.1	12	1673	-	264	
11	1	81.6	12	-	-	740	
12	1	83.6	12	-	-	163	
13	3	87.6	12	1757	1322	628	
14	2	58.5	12	1372	-	132	
15	3	91.8	12	1767	1183	106	
16	2	58.8	12	1432	-	659	
Detection Check (1=Detection; 0=No Detection)							0



Trial Number			23			
Number of Bursts in Trial			17			
Chirp Center Frequency			5525			
Burst	No. of Pulses	Pulse Width (us)	Chirp Width (MHz)	Pulse 1-to-2 Spacing (us)	Pulse 2-to-3 Spacing (us)	Starting Location Within Interval (ms)
1	1	96	11	-	-	284
2	2	92.5	11	1241	-	488
3	2	89.5	11	1347	-	76
4	2	74.8	11	1607	-	688
5	2	60.6	11	1523	-	28
6	2	71.5	11	1659	-	383
7	2	71.1	11	1454	-	182
8	1	98.7	11	-	-	20
9	2	85.1	11	1770	-	576
10	2	89.2	11	1086	-	410
11	2	60.7	11	1101	-	458
12	2	75.2	11	1719	-	348
13	2	75.7	11	1799	-	481
14	3	56.7	11	1132	1884	587
15	2	65	11	1885	-	480
16	2	64.6	11	1910	-	195
17	3	69.9	11	1410	1190	396
Detection Check (1=Detection; 0=No Detection)						1



Trial Number			24			
Number of Bursts in Trial			18			
Chirp Center Frequency			5525			
Burst	No. of Pulses	Pulse Width (us)	Chirp Width (MHz)	Pulse 1-to-2 Spacing (us)	Pulse 2-to-3 Spacing (us)	Starting Location Within Interval (ms)
1	3	83.8	10	1290	1021	536
2	2	66.9	10	1112	-	44
3	3	91	10	1220	1504	611
4	2	86.1	10	1678	-	456
5	3	65.5	10	1928	1222	330
6	1	62.6	10	-	-	297
7	3	68.7	10	1505	1200	351
8	3	59.2	10	1452	1114	230
9	1	73.9	10	-	-	222
10	1	77.2	10	-	-	57
11	2	96.4	10	1357	-	399
12	2	99.9	10	1173	-	299
13	2	99.9	10	1520	-	464
14	1	86.7	10	-	-	294
15	1	92.6	10	-	-	653
16	1	77.1	10	-	-	550
17	2	81.1	10	1664	-	566
18	3	68.4	10	1536	1309	580
Detection Check (1=Detection; 0=No Detection)						1



Trial Number			25			
Number of Bursts in Trial			19			
Chirp Center Frequency			5525			
Burst	No. of Pulses	Pulse Width (us)	Chirp Width (MHz)	Pulse 1-to-2 Spacing (us)	Pulse 2-to-3 Spacing (us)	Starting Location Within Interval (ms)
1	3	68.2	9	1723	1868	471
2	3	83.7	9	1711	1405	368
3	2	69.7	9	1781	-	425
4	1	59.7	9	-	-	440
5	2	96.7	9	1484	-	123
6	2	95.8	9	1319	-	261
7	3	71.3	9	1095	1354	332
8	3	53.2	9	1527	1427	427
9	2	69.5	9	1771	-	397
10	3	63.9	9	1075	1447	67
11	2	93.4	9	1783	-	174
12	2	77.3	9	1564	-	17
13	2	73.1	9	1294	-	216
14	1	77.4	9	-	-	292
15	3	57.2	9	1722	1886	619
16	2	68.7	9	1629	-	233
17	1	60.8	9	-	-	226
18	3	69.7	9	1128	1224	599
19	1	62.2	9	-	-	433
Detection Check (1=Detection; 0=No Detection)						1



Trial Number							26
Number of Bursts in Trial							20
Chirp Center Frequency							5526
Burst	No. of Pulses	Pulse Width (us)	Chirp Width (MHz)	Pulse 1-to-2 Spacing (us)	Pulse 2-to-3 Spacing (us)	Starting Location Within Interval (ms)	
1	1	80.5	8	-	-	90	
2	3	62.6	8	1406	1343	319	
3	3	85.6	8	1190	1529	384	
4	2	83.9	8	1208	-	567	
5	2	92.4	8	1488	-	234	
6	2	54	8	1529	-	535	
7	3	81.3	8	1501	1812	325	
8	1	98.5	8	-	-	532	
9	1	85.8	8	-	-	272	
10	2	84.7	8	1593	-	182	
11	2	83.3	8	1705	-	134	
12	2	79.8	8	1567	-	286	
13	1	77.9	8	-	-	368	
14	3	98.4	8	1510	1569	290	
15	2	79.9	8	1588	-	231	
16	3	78	8	1140	1353	353	
17	3	55.2	8	1700	1327	53	
18	3	71.9	8	1081	1224	44	
19	1	62	8	-	-	298	
20	3	70.5	8	1888	1442	529	
Detection Check (1=Detection; 0=No Detection)							1

Trial Number							27
Number of Bursts in Trial							8
Chirp Center Frequency							5522
Burst	No. of Pulses	Pulse Width (us)	Chirp Width (MHz)	Pulse 1-to-2 Spacing (us)	Pulse 2-to-3 Spacing (us)	Starting Location Within Interval (ms)	
1	2	69.1	18	1076	-	1436	
2	2	62.1	18	1688	-	22	
3	2	94.8	18	1891	-	897	
4	1	75.8	18	-	-	1186	
5	2	65.4	18	1713	-	589	
6	2	97.7	18	1292	-	614	
7	3	98.1	18	1670	1711	506	
8	2	85.4	18	1672	-	776	
Detection Check (1=Detection; 0=No Detection)							1



Trial Number		28				
Number of Bursts in Trial		9				
Chirp Center Frequency		5521				
Burst	No. of Pulses	Pulse Width (us)	Chirp Width (MHz)	Pulse 1-to-2 Spacing (us)	Pulse 2-to-3 Spacing (us)	Starting Location Within Interval (ms)
1	3	82	19	1233	1713	679
2	3	87.7	19	1554	1123	473
3	2	98.9	19	1518	-	869
4	1	55	19	-	-	719
5	1	93.6	19	-	-	902
6	2	58.7	19	1641	-	1243
7	2	88.7	19	1387	-	410
8	1	60.3	19	-	-	1154
9	1	97.7	19	-	-	512
Detection Check (1=Detection; 0=No Detection)						1

Trial Number		29				
Number of Bursts in Trial		10				
Chirp Center Frequency		5521				
Burst	No. of Pulses	Pulse Width (us)	Chirp Width (MHz)	Pulse 1-to-2 Spacing (us)	Pulse 2-to-3 Spacing (us)	Starting Location Within Interval (ms)
1	1	69.6	20	-	-	1131
2	1	74.5	20	-	-	290
3	1	60.9	20	-	-	895
4	1	74.6	20	-	-	202
5	2	99.3	20	1501	-	139
6	2	95.3	20	1065	-	854
7	2	91.9	20	1722	-	219
8	2	51	20	1285	-	57
9	2	87.7	20	1747	-	141
10	1	87.2	20	-	-	596
Detection Check (1=Detection; 0=No Detection)						1



Trial Number		30				
Number of Bursts in Trial		11				
Chirp Center Frequency		5527				
Burst	No. of Pulses	Pulse Width (us)	Chirp Width (MHz)	Pulse 1-to-2 Spacing (us)	Pulse 2-to-3 Spacing (us)	Starting Location Within Interval (ms)
1	3	59.9	5	1901	1196	935
2	2	77.1	5	1590	-	1038
3	2	62.7	5	1227	-	690
4	1	77.1	5	-	-	547
5	3	99.8	5	1798	1790	551
6	2	61.5	5	1135	-	876
7	2	77.5	5	1583	-	448
8	2	57.3	5	1890	-	736
9	2	53.5	5	1757	-	362
10	1	66.6	5	-	-	836
11	3	80.7	5	1811	1289	410
Detection Check (1=Detection; 0=No Detection)						1



Type 6 Radar Statistical Performance

Trial #	Test Freq. (MHz)	Pulses / Hop	Pulse Width (us)	PRI (us)	1=Detection 0=No Detection
1	5510	9	1	333	1
2	5510	9	1	333	1
3	5510	9	1	333	1
4	5510	9	1	333	1
5	5510	9	1	333	1
6	5510	9	1	333	1
7	5510	9	1	333	1
8	5510	9	1	333	1
9	5510	9	1	333	1
10	5510	9	1	333	1
11	5510	9	1	333	1
12	5510	9	1	333	1
13	5510	9	1	333	1
14	5510	9	1	333	1
15	5510	9	1	333	1
16	5510	9	1	333	1
17	5510	9	1	333	0
18	5510	9	1	333	1
19	5510	9	1	333	1
20	5510	9	1	333	1
21	5510	9	1	333	1
22	5510	9	1	333	1
23	5510	9	1	333	1
24	5510	9	1	333	1
25	5510	9	1	333	1
26	5510	9	1	333	1
27	5510	9	1	333	1
28	5510	9	1	333	1
29	5510	9	1	333	1
30	5510	9	1	333	1
Detection Percentage (%)					96.667
Limit					70%
Test Result					Complied



Modulation Mode: 802.11ac (VHT80)

Type 1 Radar Statistical Performance

Trial #	Test Freq. (MHz)	Pulse Repetition Frequency Number	Pulse Repetition Frequency (Pulse Per Second)	PRI (us)	1=Detection 0=No Detection
1	5523	1	1930.5	518	1
2	5497	23	326.2	3066	1
3	5500	19	1139.0	878	1
4	5502	12	1355.0	738	1
5	5520	4	1730.1	578	1
6	5504	8	1519.8	658	1
7	5526	15	1253.1	798	1
8	5496	6	1618.1	618	1
9	5521	14	1285.3	778	1
10	5519	3	1792.1	558	1
11	5527	13	1319.3	758	1
12	5494	9	1474.9	678	0
13	5508	7	1567.4	638	1
14	5528	17	1193.3	838	1
15	5512	10	1432.7	698	1
16	5507	-	1692.0	591	1
17	5498	-	328.1	3048	1
18	5527	-	373.4	2678	0
19	5514	-	574.4	1741	1
20	5515	-	1216.5	822	1
21	5524	-	801.3	1248	1
22	5523	-	488.5	2047	0
23	5514	-	956.0	1046	1
24	5506	-	517.6	1932	1
25	5494	-	1422.5	703	1
26	5496	-	542.0	1845	1
27	5497	-	741.3	1349	1
28	5526	-	881.8	1134	1
29	5524	-	427.4	2340	1
30	5492	-	628.9	1590	1
Detection Percentage (%)					90.000
Limit					60%
Test Result					Complied



Type 2 Radar Statistical Performance

Trial #	Test Freq. (MHz)	Pulse Width (us)	PRI (us)	Pulses / Burst	1=Detection 0=No Detection
1	5523	2.6	221	23	1
2	5497	4.6	198	27	1
3	5500	1.1	184	29	1
4	5502	4.8	203	24	1
5	5520	2.4	162	25	1
6	5504	3.4	204	28	1
7	5526	2.3	170	27	1
8	5496	3.5	184	23	1
9	5521	4.9	150	27	1
10	5519	4.6	211	29	1
11	5527	2.9	158	23	1
12	5494	2.6	226	27	0
13	5508	1.6	204	26	1
14	5528	3.9	181	25	1
15	5512	4.6	202	24	1
16	5507	4.1	194	27	1
17	5498	2.3	193	28	1
18	5527	3.9	173	29	1
19	5514	4.3	188	23	1
20	5515	1.5	215	26	1
21	5524	4.9	227	27	1
22	5523	1.1	199	23	1
23	5514	4.5	155	29	1
24	5506	4.0	190	27	1
25	5494	2.4	151	23	1
26	5496	2.5	180	28	1
27	5497	2.5	228	23	0
28	5526	2.5	203	25	0
29	5524	1.5	188	25	1
30	5492	1.9	217	24	1
Detection Percentage (%)					90.000
Limit					60%
Test Result					Complied



Type 3 Radar Statistical Performance

Trial #	Test Freq. (MHz)	Pulse Width (us)	PRI (us)	Pulses / Burst	1=Detection 0=No Detection
1	5523	8.0	205	16	1
2	5497	6.7	382	18	1
3	5500	8.6	418	16	1
4	5502	9.4	351	17	1
5	5520	7.4	383	18	1
6	5504	9.8	232	16	1
7	5526	9.1	377	17	1
8	5496	9.6	457	16	0
9	5521	8.0	471	18	1
10	5519	9.0	304	18	1
11	5527	8.0	316	17	1
12	5494	9.8	325	16	1
13	5508	8.0	409	17	1
14	5528	9.9	200	17	1
15	5512	8.8	458	16	0
16	5507	8.0	232	18	1
17	5498	8.3	250	16	1
18	5527	8.7	270	16	1
19	5514	7.7	350	17	1
20	5515	7.1	230	16	1
21	5524	7.3	416	18	1
22	5523	7.6	498	18	0
23	5514	7.3	286	17	1
24	5506	7.3	287	16	1
25	5494	7.5	462	17	1
26	5496	6.2	300	17	1
27	5497	6.4	323	18	1
28	5526	7.1	420	16	1
29	5524	7.2	395	18	1
30	5492	8.4	377	16	1
Detection Percentage (%)					90.000
Limit					60%
Test Result					Complied



Type 4 Radar Statistical Performance

Trial #	Test Freq. (MHz)	Pulse Width (us)	PRI (us)	Pulses / Burst	1=Detection 0=No Detection
1	5523	18.0	242	15	1
2	5497	19.9	279	12	1
3	5500	12.9	487	14	1
4	5502	15.0	452	13	1
5	5520	16.3	230	12	1
6	5504	19.8	238	13	1
7	5526	18.2	420	16	1
8	5496	16.3	452	15	1
9	5521	14.2	495	12	1
10	5519	17.8	228	16	1
11	5527	19.1	211	16	1
12	5494	18.4	283	15	0
13	5508	11.8	411	12	1
14	5528	14.2	284	13	1
15	5512	13.9	202	12	1
16	5507	17.8	340	14	1
17	5498	15.6	290	16	1
18	5527	14.6	250	16	0
19	5514	14.4	484	15	1
20	5515	18.9	387	13	1
21	5524	11.1	348	15	1
22	5523	13.8	291	16	1
23	5514	14.3	295	12	0
24	5506	12.5	300	12	1
25	5494	12.5	322	14	1
26	5496	12.5	383	13	1
27	5497	15.7	322	16	1
28	5526	19.8	469	13	1
29	5524	18.6	406	15	1
30	5492	15.9	238	14	1
Detection Percentage (%)					90.000
Limit					60%
Test Result					Complied



Total Type 1~4 Radar Statistical Performance

Radar Type #	Detection Percentage (%)
1	90.000
2	90.000
3	90.000
4	90.000
Aggregate (Radar Types 1-4)	90.000
Limit	80%
Test Result	Complied



Type 5 Radar Statistical Performance

Center Freq. (MHz)	Low Edge (MHz)	High Edge (MHz)	VSG Freq. (MHz)	Detection
Trial	Chirp	Offset		
5530	5491	5569		
1	5	2	5530	1
2	20	8	5530	1
3	7	2.8	5530	1
4	8	3.2	5530	1
5	9	3.6	5530	1
6	10	4	5530	1
7	11	4.4	5530	0
8	12	4.8	5530	1
9	13	5.2	5530	1
10	14	5.6	5530	1
11	15	6	5497	1
12	16	6.4	5497	1
13	17	6.8	5498	1
14	20	8	5499	1
15	19	7.6	5499	1
16	18	7.2	5498	1
17	17	6.8	5498	1
18	16	6.4	5497	1
19	15	6	5497	1
20	14	5.6	5497	1
21	13	5.2	5564	1
22	12	4.8	5564	1
23	11	4.4	5565	1
24	10	4	5565	1
25	9	3.6	5565	1
26	8	3.2	5566	1
27	18	7.2	5562	1
28	19	7.6	5561	1
29	20	8	5561	1
30	5	2	5567	1
Total				29
Detection Percentage (%)				97%
Limit				80%
Test Result				Complied



Trial Number							1
Number of Bursts in Trial							8
Chirp Center Frequency							5530
Burst	No. of Pulses	Pulse Width (us)	Chirp Width (MHz)	Pulse 1-to-2 Spacing (us)	Pulse 2-to-3 Spacing (us)	Starting Location Within Interval (ms)	
1	1	62.1	5	-	-	1091	
2	2	56	5	1729	-	133	
3	2	91.3	5	1230	-	1057	
4	3	50.7	5	1762	1616	1442	
5	2	92.6	5	1723	-	544	
6	2	87.3	5	1302	-	1089	
7	2	59.5	5	1291	-	1374	
8	2	52.2	5	1653	-	1237	
Detection Check (1=Detection; 0=No Detection)							1

Trial Number							2
Number of Bursts in Trial							9
Chirp Center Frequency							5530
Burst	No. of Pulses	Pulse Width (us)	Chirp Width (MHz)	Pulse 1-to-2 Spacing (us)	Pulse 2-to-3 Spacing (us)	Starting Location Within Interval (ms)	
1	3	90	20	1007	1326	30	
2	2	73.7	20	1785	-	979	
3	1	78.1	20	-	-	683	
4	2	92.4	20	1281	-	950	
5	1	61.2	20	-	-	612	
6	3	67.2	20	1525	1870	17	
7	1	78.5	20	-	-	429	
8	2	60.3	20	1931	-	936	
9	3	92.9	20	1403	1476	548	
Detection Check (1=Detection; 0=No Detection)							1



Trial Number		3				
Number of Bursts in Trial		10				
Chirp Center Frequency		5530				
Burst	No. of Pulses	Pulse Width (us)	Chirp Width (MHz)	Pulse 1-to-2 Spacing (us)	Pulse 2-to-3 Spacing (us)	Starting Location Within Interval (ms)
1	3	63.4	7	1574	1607	801
2	1	98	7	-	-	966
3	1	58.7	7	-	-	185
4	1	88	7	-	-	1012
5	3	79.5	7	1562	1370	943
6	3	57.1	7	1900	1188	686
7	2	64.4	7	1090	-	599
8	1	78.7	7	-	-	1089
9	1	69.3	7	-	-	188
10	3	55.3	7	1375	1691	933
Detection Check (1=Detection; 0=No Detection)						1

Trial Number		4				
Number of Bursts in Trial		11				
Chirp Center Frequency		5530				
Burst	No. of Pulses	Pulse Width (us)	Chirp Width (MHz)	Pulse 1-to-2 Spacing (us)	Pulse 2-to-3 Spacing (us)	Starting Location Within Interval (ms)
1	2	74.3	8	1642	-	24
2	1	83.1	8	-	-	985
3	2	59.5	8	1680	-	988
4	2	59.8	8	1786	-	800
5	2	77.6	8	1617	-	339
6	2	79.9	8	1553	-	1040
7	1	56	8	-	-	544
8	3	71.4	8	1406	1927	452
9	1	97.4	8	-	-	204
10	2	98.3	8	1037	-	926
11	1	63.6	8	-	-	1052
Detection Check (1=Detection; 0=No Detection)						1



Trial Number							5
Number of Bursts in Trial							12
Chirp Center Frequency							5530
Burst	No. of Pulses	Pulse Width (us)	Chirp Width (MHz)	Pulse 1-to-2 Spacing (us)	Pulse 2-to-3 Spacing (us)	Starting Location Within Interval (ms)	
1	1	50	9	-	-	557	
2	2	62.5	9	1731	-	567	
3	2	55.4	9	1070	-	460	
4	1	65.7	9	-	-	4	
5	2	58	9	1512	-	64	
6	2	60.9	9	1230	-	650	
7	3	89.6	9	1598	1738	235	
8	3	84.4	9	1271	1617	873	
9	3	72.3	9	1498	1321	901	
10	1	58.9	9	-	-	663	
11	2	74.8	9	1584	-	919	
12	1	71.8	9	-	-	375	
Detection Check (1=Detection; 0=No Detection)							1

Trial Number							6
Number of Bursts in Trial							13
Chirp Center Frequency							5530
Burst	No. of Pulses	Pulse Width (us)	Chirp Width (MHz)	Pulse 1-to-2 Spacing (us)	Pulse 2-to-3 Spacing (us)	Starting Location Within Interval (ms)	
1	2	88.1	10	1257	-	846	
2	1	58.7	10	-	-	725	
3	2	97.1	10	1037	-	30	
4	3	83.1	10	1029	1106	490	
5	1	62.1	10	-	-	262	
6	2	71.4	10	1058	-	283	
7	2	86.3	10	1867	-	49	
8	3	77.3	10	1418	1876	634	
9	1	78.9	10	-	-	304	
10	3	79.2	10	1055	1572	564	
11	3	52	10	1582	1836	852	
12	3	56.5	10	1195	1542	525	
13	3	100	10	1638	1729	750	
Detection Check (1=Detection; 0=No Detection)							1



Trial Number							7
Number of Bursts in Trial							14
Chirp Center Frequency							5530
Burst	No. of Pulses	Pulse Width (us)	Chirp Width (MHz)	Pulse 1-to-2 Spacing (us)	Pulse 2-to-3 Spacing (us)	Starting Location Within Interval (ms)	
1	2	92.7	11	1208	-	231	
2	2	81.3	11	1144	-	804	
3	2	60.4	11	1555	-	34	
4	2	62.1	11	1320	-	427	
5	1	50	11	-	-	577	
6	3	65.9	11	1020	1365	3	
7	2	73.8	11	1308	-	51	
8	2	74.3	11	1143	-	360	
9	1	62.9	11	-	-	394	
10	2	74.8	11	1404	-	317	
11	2	69.7	11	1309	-	532	
12	2	69.8	11	1688	-	339	
13	2	77.4	11	1857	-	381	
14	1	55.1	11	-	-	426	
Detection Check (1=Detection; 0=No Detection)							0

Trial Number							8
Number of Bursts in Trial							15
Chirp Center Frequency							5530
Burst	No. of Pulses	Pulse Width (us)	Chirp Width (MHz)	Pulse 1-to-2 Spacing (us)	Pulse 2-to-3 Spacing (us)	Starting Location Within Interval (ms)	
1	1	91.7	12	-	-	776	
2	2	90	12	1196	-	187	
3	3	92.3	12	1486	1853	448	
4	2	66.8	12	1545	-	702	
5	1	64	12	-	-	403	
6	3	95.4	12	1123	1473	230	
7	3	66.8	12	1867	1401	604	
8	3	67.7	12	1472	1397	38	
9	1	68.2	12	-	-	735	
10	2	82.2	12	1297	-	610	
11	1	92.1	12	-	-	618	
12	2	57	12	1764	-	705	
13	2	58.5	12	1310	-	22	
14	3	85.5	12	1630	1447	641	
15	2	82.2	12	1371	-	109	
Detection Check (1=Detection; 0=No Detection)							1



Trial Number			9			
Number of Bursts in Trial			16			
Chirp Center Frequency			5530			
Burst	No. of Pulses	Pulse Width (us)	Chirp Width (MHz)	Pulse 1-to-2 Spacing (us)	Pulse 2-to-3 Spacing (us)	Starting Location Within Interval (ms)
1	2	74.4	13	1707	-	442
2	2	63.6	13	1725	-	280
3	2	71.3	13	1704	-	459
4	3	77.6	13	1063	1405	197
5	3	65.2	13	1731	1294	101
6	3	55.1	13	1109	1549	17
7	2	96.8	13	1034	-	131
8	3	80.8	13	1533	1051	365
9	1	60.4	13	-	-	222
10	2	61.8	13	1312	-	371
11	2	71.3	13	1657	-	33
12	2	98.1	13	1024	-	291
13	1	57.9	13	-	-	188
14	1	91.8	13	-	-	163
15	2	56.7	13	1259	-	426
16	2	89.7	13	1690	-	606
Detection Check (1=Detection; 0=No Detection)						1



Trial Number			10			
Number of Bursts in Trial			17			
Chirp Center Frequency			5530			
Burst	No. of Pulses	Pulse Width (us)	Chirp Width (MHz)	Pulse 1-to-2 Spacing (us)	Pulse 2-to-3 Spacing (us)	Starting Location Within Interval (ms)
1	2	74.4	14	1107	-	462
2	1	87.6	14	-	-	653
3	2	61.7	14	1741	-	457
4	2	57.5	14	1566	-	388
5	2	66.1	14	1855	-	63
6	3	70.1	14	1044	1012	136
7	1	66.4	14	-	-	343
8	1	59.2	14	-	-	349
9	2	88.3	14	1240	-	362
10	1	64.7	14	-	-	221
11	2	73	14	1703	-	144
12	2	81.7	14	1450	-	671
13	3	70.1	14	1741	1278	320
14	1	63.6	14	-	-	196
15	1	58.7	14	-	-	413
16	2	65.9	14	1478	-	170
17	1	72.7	14	-	-	564
Detection Check (1=Detection; 0=No Detection)						1



Trial Number		11				
Number of Bursts in Trial		18				
Chirp Center Frequency		5497				
Burst	No. of Pulses	Pulse Width (us)	Chirp Width (MHz)	Pulse 1-to-2 Spacing (us)	Pulse 2-to-3 Spacing (us)	Starting Location Within Interval (ms)
1	2	72.1	15	1193	-	130
2	3	76.3	15	1484	1390	114
3	1	86.1	15	-	-	14
4	1	73.2	15	-	-	604
5	1	81.2	15	-	-	548
6	2	99.5	15	1398	-	173
7	1	93.9	15	-	-	262
8	2	75.9	15	1921	-	38
9	3	79.2	15	1100	1429	84
10	3	77	15	1166	1799	610
11	1	91.8	15	-	-	339
12	3	56.8	15	1330	1556	580
13	2	83.1	15	1556	-	295
14	2	63	15	1552	-	156
15	1	65.7	15	-	-	439
16	1	64.5	15	-	-	188
17	1	88.5	15	-	-	419
18	1	60.6	15	-	-	205
Detection Check (1=Detection; 0=No Detection)						1



Trial Number			12			
Number of Bursts in Trial			19			
Chirp Center Frequency			5497			
Burst	No. of Pulses	Pulse Width (us)	Chirp Width (MHz)	Pulse 1-to-2 Spacing (us)	Pulse 2-to-3 Spacing (us)	Starting Location Within Interval (ms)
1	2	90.5	16	1299	-	381
2	2	88.4	16	1418	-	327
3	2	53.7	16	1055	-	536
4	1	80.5	16	-	-	285
5	1	50.4	16	-	-	398
6	2	61.2	16	1749	-	439
7	2	78.8	16	1065	-	129
8	3	75	16	1748	1820	325
9	2	96.7	16	1254	-	440
10	3	76.3	16	1848	1106	397
11	1	73.3	16	-	-	232
12	2	92.4	16	1317	-	91
13	2	92.4	16	1854	-	256
14	3	64.4	16	1240	1634	582
15	2	67.3	16	1473	-	117
16	2	84.1	16	1795	-	202
17	1	80.9	16	-	-	135
18	1	74.6	16	-	-	396
19	2	97.6	16	1805	-	615
Detection Check (1=Detection; 0=No Detection)						1



Trial Number							13
Number of Bursts in Trial							20
Chirp Center Frequency							5498
Burst	No. of Pulses	Pulse Width (us)	Chirp Width (MHz)	Pulse 1-to-2 Spacing (us)	Pulse 2-to-3 Spacing (us)	Starting Location Within Interval (ms)	
1	2	66.1	17	1417	-	388	
2	2	86.7	17	1693	-	348	
3	2	70.5	17	1263	-	215	
4	2	78	17	1446	-	28	
5	2	66	17	1185	-	585	
6	2	80.6	17	1855	-	65	
7	1	95.5	17	-	-	92	
8	1	98.8	17	-	-	68	
9	3	64.3	17	1641	1108	517	
10	1	75.1	17	-	-	121	
11	2	72.6	17	1499	-	448	
12	1	60.3	17	-	-	567	
13	2	54.9	17	1056	-	245	
14	2	98.8	17	1023	-	584	
15	2	60.9	17	1243	-	579	
16	2	62.7	17	1226	-	464	
17	1	80.1	17	-	-	89	
18	2	70.9	17	1711	-	153	
19	1	90.7	17	-	-	282	
20	1	98.9	17	-	-	71	
Detection Check (1=Detection; 0=No Detection)							1

Trial Number							14
Number of Bursts in Trial							8
Chirp Center Frequency							5499
Burst	No. of Pulses	Pulse Width (us)	Chirp Width (MHz)	Pulse 1-to-2 Spacing (us)	Pulse 2-to-3 Spacing (us)	Starting Location Within Interval (ms)	
1	2	67.5	20	1542	-	947	
2	3	83.6	20	1272	1696	124	
3	2	93.2	20	1877	-	701	
4	1	55.6	20	-	-	1123	
5	3	84.2	20	1733	1619	756	
6	3	69.1	20	1612	1071	1	
7	2	66.9	20	1905	-	7	
8	3	86.8	20	1697	1621	1082	
Detection Check (1=Detection; 0=No Detection)							1



Trial Number							15
Number of Bursts in Trial							9
Chirp Center Frequency							5499
Burst	No. of Pulses	Pulse Width (us)	Chirp Width (MHz)	Pulse 1-to-2 Spacing (us)	Pulse 2-to-3 Spacing (us)	Starting Location Within Interval (ms)	
1	2	62.2	19	1571	-	949	
2	2	85	19	1669	-	189	
3	2	64.5	19	1505	-	176	
4	2	50.4	19	1325	-	538	
5	2	66.1	19	1483	-	908	
6	2	71.2	19	1110	-	1017	
7	3	53.7	19	1445	1677	492	
8	3	62.5	19	1596	1341	349	
9	3	62	19	1929	1221	1105	
Detection Check (1=Detection; 0=No Detection)							1

Trial Number							16
Number of Bursts in Trial							10
Chirp Center Frequency							5498
Burst	No. of Pulses	Pulse Width (us)	Chirp Width (MHz)	Pulse 1-to-2 Spacing (us)	Pulse 2-to-3 Spacing (us)	Starting Location Within Interval (ms)	
1	2	80.5	18	1910	-	284	
2	2	64.2	18	1661	-	751	
3	2	90.1	18	1041	-	491	
4	2	69.8	18	1495	-	107	
5	1	73.1	18	-	-	490	
6	3	77.2	18	1418	1145	1155	
7	3	52.6	18	1732	1787	772	
8	2	71.4	18	1562	-	121	
9	2	89.8	18	1491	-	89	
10	2	76.4	18	1355	-	615	
Detection Check (1=Detection; 0=No Detection)							1



Trial Number							17
Number of Bursts in Trial							11
Chirp Center Frequency							5498
Burst	No. of Pulses	Pulse Width (us)	Chirp Width (MHz)	Pulse 1-to-2 Spacing (us)	Pulse 2-to-3 Spacing (us)	Starting Location Within Interval (ms)	
1	2	51.2	17	1236	-	740	
2	1	71.7	17	-	-	941	
3	2	74.7	17	1164	-	370	
4	2	50.9	17	1919	-	371	
5	2	65.2	17	1206	-	1033	
6	2	98	17	1182	-	346	
7	2	58.7	17	1612	-	639	
8	1	63.8	17	-	-	1056	
9	3	86.3	17	1545	1065	205	
10	1	94.4	17	-	-	753	
11	3	88.5	17	1699	1319	58	
Detection Check (1=Detection; 0=No Detection)							1

Trial Number							18
Number of Bursts in Trial							12
Chirp Center Frequency							5497
Burst	No. of Pulses	Pulse Width (us)	Chirp Width (MHz)	Pulse 1-to-2 Spacing (us)	Pulse 2-to-3 Spacing (us)	Starting Location Within Interval (ms)	
1	2	88.7	16	1405	-	448	
2	3	90.2	16	1544	1235	621	
3	1	96.5	16	-	-	512	
4	2	80.5	16	1090	-	321	
5	2	63.7	16	1268	-	798	
6	1	53.4	16	-	-	809	
7	2	52.3	16	1043	-	301	
8	3	54.7	16	1701	1104	796	
9	3	75.6	16	1923	1729	669	
10	2	59.2	16	1244	-	369	
11	1	56.3	16	-	-	51	
12	2	87.8	16	1608	-	733	
Detection Check (1=Detection; 0=No Detection)							1



Trial Number							19
Number of Bursts in Trial							13
Chirp Center Frequency							5497
Burst	No. of Pulses	Pulse Width (us)	Chirp Width (MHz)	Pulse 1-to-2 Spacing (us)	Pulse 2-to-3 Spacing (us)	Starting Location Within Interval (ms)	
1	2	68.2	15	1104	-	229	
2	2	58.4	15	1627	-	488	
3	3	74.7	15	1861	1015	137	
4	2	58.2	15	1593	-	520	
5	1	51.6	15	-	-	799	
6	2	94.7	15	1469	-	43	
7	2	70.7	15	1091	-	126	
8	2	82.9	15	1472	-	607	
9	3	62.7	15	1168	1453	527	
10	2	63.1	15	1529	-	143	
11	1	96.1	15	-	-	176	
12	2	57	15	1457	-	882	
13	3	95.6	15	1707	1501	214	
Detection Check (1=Detection; 0=No Detection)							1

Trial Number							20
Number of Bursts in Trial							14
Chirp Center Frequency							5497
Burst	No. of Pulses	Pulse Width (us)	Chirp Width (MHz)	Pulse 1-to-2 Spacing (us)	Pulse 2-to-3 Spacing (us)	Starting Location Within Interval (ms)	
1	1	95.7	14	-	-	117	
2	1	93.1	14	-	-	720	
3	1	55.8	14	-	-	297	
4	1	76.7	14	-	-	284	
5	2	68	14	1686	-	472	
6	3	94.1	14	1796	1393	264	
7	2	53.9	14	1293	-	525	
8	1	99.3	14	-	-	155	
9	2	73.3	14	1458	-	65	
10	2	93.3	14	1196	-	451	
11	3	55.8	14	1895	1034	243	
12	1	66.4	14	-	-	228	
13	2	65.6	14	1732	-	746	
14	2	76.5	14	1187	-	522	
Detection Check (1=Detection; 0=No Detection)							1



Trial Number							21
Number of Bursts in Trial							15
Chirp Center Frequency							5564
Burst	No. of Pulses	Pulse Width (us)	Chirp Width (MHz)	Pulse 1-to-2 Spacing (us)	Pulse 2-to-3 Spacing (us)	Starting Location Within Interval (ms)	
1	1	85.1	13	-	-	565	
2	2	72.5	13	1648	-	211	
3	1	67.5	13	-	-	348	
4	2	56.1	13	1360	-	156	
5	1	71.1	13	-	-	718	
6	2	93.1	13	1391	-	400	
7	1	56.5	13	-	-	482	
8	1	63.8	13	-	-	703	
9	2	67.4	13	1727	-	780	
10	1	52.3	13	-	-	102	
11	3	62.4	13	1228	1715	304	
12	2	53.3	13	1630	-	57	
13	2	83.1	13	1205	-	768	
14	2	93.7	13	1085	-	461	
15	2	90.7	13	1297	-	746	
Detection Check (1=Detection; 0=No Detection)							1

Trial Number							22
Number of Bursts in Trial							16
Chirp Center Frequency							5564
Burst	No. of Pulses	Pulse Width (us)	Chirp Width (MHz)	Pulse 1-to-2 Spacing (us)	Pulse 2-to-3 Spacing (us)	Starting Location Within Interval (ms)	
1	2	98.8	12	1439	-	95	
2	1	54.5	12	-	-	676	
3	2	80.5	12	1360	-	8	
4	2	55.9	12	1906	-	373	
5	2	72.1	12	1623	-	254	
6	2	84.4	12	1604	-	480	
7	1	78.5	12	-	-	663	
8	1	88	12	-	-	314	
9	2	74.7	12	1157	-	596	
10	2	97.1	12	1673	-	264	
11	1	81.6	12	-	-	740	
12	1	83.6	12	-	-	163	
13	3	87.6	12	1757	1322	628	
14	2	58.5	12	1372	-	132	
15	3	91.8	12	1767	1183	106	
16	2	58.8	12	1432	-	659	
Detection Check (1=Detection; 0=No Detection)							1



Trial Number			23			
Number of Bursts in Trial			17			
Chirp Center Frequency			5565			
Burst	No. of Pulses	Pulse Width (us)	Chirp Width (MHz)	Pulse 1-to-2 Spacing (us)	Pulse 2-to-3 Spacing (us)	Starting Location Within Interval (ms)
1	1	96	11	-	-	284
2	2	92.5	11	1241	-	488
3	2	89.5	11	1347	-	76
4	2	74.8	11	1607	-	688
5	2	60.6	11	1523	-	28
6	2	71.5	11	1659	-	383
7	2	71.1	11	1454	-	182
8	1	98.7	11	-	-	20
9	2	85.1	11	1770	-	576
10	2	89.2	11	1086	-	410
11	2	60.7	11	1101	-	458
12	2	75.2	11	1719	-	348
13	2	75.7	11	1799	-	481
14	3	56.7	11	1132	1884	587
15	2	65	11	1885	-	480
16	2	64.6	11	1910	-	195
17	3	69.9	11	1410	1190	396
Detection Check (1=Detection; 0=No Detection)						1



Trial Number			24			
Number of Bursts in Trial			18			
Chirp Center Frequency			5565			
Burst	No. of Pulses	Pulse Width (us)	Chirp Width (MHz)	Pulse 1-to-2 Spacing (us)	Pulse 2-to-3 Spacing (us)	Starting Location Within Interval (ms)
1	3	83.8	10	1290	1021	536
2	2	66.9	10	1112	-	44
3	3	91	10	1220	1504	611
4	2	86.1	10	1678	-	456
5	3	65.5	10	1928	1222	330
6	1	62.6	10	-	-	297
7	3	68.7	10	1505	1200	351
8	3	59.2	10	1452	1114	230
9	1	73.9	10	-	-	222
10	1	77.2	10	-	-	57
11	2	96.4	10	1357	-	399
12	2	99.9	10	1173	-	299
13	2	99.9	10	1520	-	464
14	1	86.7	10	-	-	294
15	1	92.6	10	-	-	653
16	1	77.1	10	-	-	550
17	2	81.1	10	1664	-	566
18	3	68.4	10	1536	1309	580
Detection Check (1=Detection; 0=No Detection)						1



Trial Number			25			
Number of Bursts in Trial			19			
Chirp Center Frequency			5565			
Burst	No. of Pulses	Pulse Width (us)	Chirp Width (MHz)	Pulse 1-to-2 Spacing (us)	Pulse 2-to-3 Spacing (us)	Starting Location Within Interval (ms)
1	3	68.2	9	1723	1868	471
2	3	83.7	9	1711	1405	368
3	2	69.7	9	1781	-	425
4	1	59.7	9	-	-	440
5	2	96.7	9	1484	-	123
6	2	95.8	9	1319	-	261
7	3	71.3	9	1095	1354	332
8	3	53.2	9	1527	1427	427
9	2	69.5	9	1771	-	397
10	3	63.9	9	1075	1447	67
11	2	93.4	9	1783	-	174
12	2	77.3	9	1564	-	17
13	2	73.1	9	1294	-	216
14	1	77.4	9	-	-	292
15	3	57.2	9	1722	1886	619
16	2	68.7	9	1629	-	233
17	1	60.8	9	-	-	226
18	3	69.7	9	1128	1224	599
19	1	62.2	9	-	-	433
Detection Check (1=Detection; 0=No Detection)						1



Trial Number							26
Number of Bursts in Trial							20
Chirp Center Frequency							5566
Burst	No. of Pulses	Pulse Width (us)	Chirp Width (MHz)	Pulse 1-to-2 Spacing (us)	Pulse 2-to-3 Spacing (us)	Starting Location Within Interval (ms)	
1	1	80.5	8	-	-	90	
2	3	62.6	8	1406	1343	319	
3	3	85.6	8	1190	1529	384	
4	2	83.9	8	1208	-	567	
5	2	92.4	8	1488	-	234	
6	2	54	8	1529	-	535	
7	3	81.3	8	1501	1812	325	
8	1	98.5	8	-	-	532	
9	1	85.8	8	-	-	272	
10	2	84.7	8	1593	-	182	
11	2	83.3	8	1705	-	134	
12	2	79.8	8	1567	-	286	
13	1	77.9	8	-	-	368	
14	3	98.4	8	1510	1569	290	
15	2	79.9	8	1588	-	231	
16	3	78	8	1140	1353	353	
17	3	55.2	8	1700	1327	53	
18	3	71.9	8	1081	1224	44	
19	1	62	8	-	-	298	
20	3	70.5	8	1888	1442	529	
Detection Check (1=Detection; 0=No Detection)							1

Trial Number							27
Number of Bursts in Trial							8
Chirp Center Frequency							5562
Burst	No. of Pulses	Pulse Width (us)	Chirp Width (MHz)	Pulse 1-to-2 Spacing (us)	Pulse 2-to-3 Spacing (us)	Starting Location Within Interval (ms)	
1	2	69.1	18	1076	-	1436	
2	2	62.1	18	1688	-	22	
3	2	94.8	18	1891	-	897	
4	1	75.8	18	-	-	1186	
5	2	65.4	18	1713	-	589	
6	2	97.7	18	1292	-	614	
7	3	98.1	18	1670	1711	506	
8	2	85.4	18	1672	-	776	
Detection Check (1=Detection; 0=No Detection)							1



Trial Number							28
Number of Bursts in Trial							9
Chirp Center Frequency							5561
Burst	No. of Pulses	Pulse Width (us)	Chirp Width (MHz)	Pulse 1-to-2 Spacing (us)	Pulse 2-to-3 Spacing (us)	Starting Location Within Interval (ms)	
1	3	82	19	1233	1713	679	
2	3	87.7	19	1554	1123	473	
3	2	98.9	19	1518	-	869	
4	1	55	19	-	-	719	
5	1	93.6	19	-	-	902	
6	2	58.7	19	1641	-	1243	
7	2	88.7	19	1387	-	410	
8	1	60.3	19	-	-	1154	
9	1	97.7	19	-	-	512	
Detection Check (1=Detection; 0=No Detection)							1

Trial Number							29
Number of Bursts in Trial							10
Chirp Center Frequency							5561
Burst	No. of Pulses	Pulse Width (us)	Chirp Width (MHz)	Pulse 1-to-2 Spacing (us)	Pulse 2-to-3 Spacing (us)	Starting Location Within Interval (ms)	
1	1	69.6	20	-	-	1131	
2	1	74.5	20	-	-	290	
3	1	60.9	20	-	-	895	
4	1	74.6	20	-	-	202	
5	2	99.3	20	1501	-	139	
6	2	95.3	20	1065	-	854	
7	2	91.9	20	1722	-	219	
8	2	51	20	1285	-	57	
9	2	87.7	20	1747	-	141	
10	1	87.2	20	-	-	596	
Detection Check (1=Detection; 0=No Detection)							1



Trial Number		30				
Number of Bursts in Trial		11				
Chirp Center Frequency		5567				
Burst	No. of Pulses	Pulse Width (us)	Chirp Width (MHz)	Pulse 1-to-2 Spacing (us)	Pulse 2-to-3 Spacing (us)	Starting Location Within Interval (ms)
1	3	59.9	5	1901	1196	935
2	2	77.1	5	1590	-	1038
3	2	62.7	5	1227	-	690
4	1	77.1	5	-	-	547
5	3	99.8	5	1798	1790	551
6	2	61.5	5	1135	-	876
7	2	77.5	5	1583	-	448
8	2	57.3	5	1890	-	736
9	2	53.5	5	1757	-	362
10	1	66.6	5	-	-	836
11	3	80.7	5	1811	1289	410
Detection Check (1=Detection; 0=No Detection)						1



Type 6 Radar Statistical Performance

Trial #	Test Freq. (MHz)	Pulses / Hop	Pulse Width (us)	PRI (us)	1=Detection 0=No Detection
1	5530	9	1	333	1
2	5530	9	1	333	1
3	5530	9	1	333	1
4	5530	9	1	333	1
5	5530	9	1	333	1
6	5530	9	1	333	1
7	5530	9	1	333	1
8	5530	9	1	333	1
9	5530	9	1	333	1
10	5530	9	1	333	1
11	5530	9	1	333	1
12	5530	9	1	333	1
13	5530	9	1	333	1
14	5530	9	1	333	1
15	5530	9	1	333	1
16	5530	9	1	333	1
17	5530	9	1	333	1
18	5530	9	1	333	1
19	5530	9	1	333	1
20	5530	9	1	333	1
21	5530	9	1	333	1
22	5530	9	1	333	1
23	5530	9	1	333	1
24	5530	9	1	333	1
25	5530	9	1	333	1
26	5530	9	1	333	1
27	5530	9	1	333	1
28	5530	9	1	333	1
29	5530	9	1	333	1
30	5530	9	1	333	1
Detection Percentage (%)					100.000
Limit					70%
Test Result					Complied



Modulation Mode: 802.11ac (VHT160)

Type 1 Radar Statistical Performance

Trial #	Test Freq. (MHz)	Pulse Repetition Frequency Number	Pulse Repetition Frequency (Pulse Per Second)	PRI (us)	1=Detection 0=No Detection
1	5517	1	1930.5	518	1
2	5625	23	326.2	3066	1
3	5512	19	1139.0	878	1
4	5562	12	1355.0	738	1
5	5536	4	1730.1	578	1
6	5581	8	1519.8	658	1
7	5518	15	1253.1	798	1
8	5646	6	1618.1	618	1
9	5632	14	1285.3	778	1
10	5563	3	1792.1	558	1
11	5511	13	1319.3	758	1
12	5502	9	1474.9	678	1
13	5595	7	1567.4	638	1
14	5639	17	1193.3	838	1
15	5590	10	1432.7	698	1
16	5578	-	1692.0	591	0
17	5573	-	328.1	3048	1
18	5543	-	373.4	2678	1
19	5519	-	574.4	1741	1
20	5643	-	1216.5	822	1
21	5604	-	801.3	1248	1
22	5535	-	488.5	2047	1
23	5622	-	956.0	1046	1
24	5605	-	517.6	1932	1
25	5644	-	1422.5	703	1
26	5545	-	542.0	1845	1
27	5557	-	741.3	1349	0
28	5611	-	881.8	1134	1
29	5529	-	427.4	2340	1
30	5569	-	628.9	1590	1
Detection Percentage (%)					93.333
Limit					60%
Test Result					Complied



Type 2 Radar Statistical Performance

Trial #	Test Freq. (MHz)	Pulse Width (us)	PRI (us)	Pulses / Burst	1=Detection 0=No Detection
1	5602	2.6	221	23	1
2	5604	4.6	198	27	1
3	5576	1.1	184	29	1
4	5532	4.8	203	24	1
5	5641	2.4	162	25	1
6	5610	3.4	204	28	1
7	5575	2.3	170	27	0
8	5647	3.5	184	23	1
9	5607	4.9	150	27	1
10	5629	4.6	211	29	1
11	5497	2.9	158	23	1
12	5501	2.6	226	27	1
13	5623	1.6	204	26	1
14	5507	3.9	181	25	1
15	5541	4.6	202	24	1
16	5518	4.1	194	27	1
17	5604	2.3	193	28	0
18	5634	3.9	173	29	0
19	5593	4.3	188	23	1
20	5562	1.5	215	26	1
21	5535	4.9	227	27	0
22	5491	1.1	199	23	1
23	5507	4.5	155	29	1
24	5535	4.0	190	27	1
25	5598	2.4	151	23	1
26	5620	2.5	180	28	1
27	5538	2.5	228	23	1
28	5605	2.5	203	25	1
29	5598	1.5	188	25	1
30	5628	1.9	217	24	1
Detection Percentage (%)					86.667
Limit					60%
Test Result					Complied



Type 3 Radar Statistical Performance

Trial #	Test Freq. (MHz)	Pulse Width (us)	PRI (us)	Pulses / Burst	1=Detection 0=No Detection
1	5536	8.0	205	16	1
2	5554	6.7	382	18	0
3	5634	8.6	418	16	1
4	5595	9.4	351	17	1
5	5610	7.4	383	18	0
6	5533	9.8	232	16	1
7	5519	9.1	377	17	1
8	5513	9.6	457	16	0
9	5623	8.0	471	18	1
10	5597	9.0	304	18	0
11	5604	8.0	316	17	1
12	5638	9.8	325	16	1
13	5639	8.0	409	17	1
14	5552	9.9	200	17	1
15	5629	8.8	458	16	1
16	5636	8.0	232	18	1
17	5542	8.3	250	16	1
18	5525	8.7	270	16	1
19	5556	7.7	350	17	1
20	5518	7.1	230	16	1
21	5638	7.3	416	18	1
22	5564	7.6	498	18	1
23	5552	7.3	286	17	1
24	5646	7.3	287	16	1
25	5606	7.5	462	17	1
26	5533	6.2	300	17	1
27	5502	6.4	323	18	1
28	5639	7.1	420	16	1
29	5604	7.2	395	18	1
30	5535	8.4	377	16	1
Detection Percentage (%)					86.667
Limit					60%
Test Result					Complied



Type 4 Radar Statistical Performance

Trial #	Test Freq. (MHz)	Pulse Width (us)	PRI (us)	Pulses / Burst	1=Detection 0=No Detection
1	5549	18.0	242	15	1
2	5524	19.9	279	12	1
3	5556	12.9	487	14	1
4	5542	15.0	452	13	1
5	5584	16.3	230	12	1
6	5555	19.8	238	13	1
7	5595	18.2	420	16	0
8	5546	16.3	452	15	0
9	5642	14.2	495	12	1
10	5529	17.8	228	16	1
11	5588	19.1	211	16	1
12	5528	18.4	283	15	1
13	5508	11.8	411	12	1
14	5644	14.2	284	13	1
15	5507	13.9	202	12	0
16	5629	17.8	340	14	1
17	5513	15.6	290	16	0
18	5592	14.6	250	16	1
19	5570	14.4	484	15	1
20	5513	18.9	387	13	1
21	5638	11.1	348	15	1
22	5587	13.8	291	16	1
23	5592	14.3	295	12	0
24	5635	12.5	300	12	1
25	5599	12.5	322	14	1
26	5593	12.5	383	13	1
27	5616	15.7	322	16	1
28	5627	19.8	469	13	1
29	5638	18.6	406	15	0
30	5600	15.9	238	14	1
Detection Percentage (%)					80.000
Limit					60%
Test Result					Complied



Total Type 1~4 Radar Statistical Performance

Radar Type #	Detection Percentage (%)
1	93.333
2	86.667
3	86.667
4	80.000
Aggregate (Radar Types 1-4)	86.667
Limit	80%
Test Result	Complied



Type 5 Radar Statistical Performance

Center Freq. (MHz)	Low Edge (MHz)	High Edge (MHz)	VSG Freq. (MHz)	Detection
Trial	Chirp	Offset		
5570	5491	5649		
1	5	2	5570	1
2	20	8	5570	1
3	7	2.8	5570	1
4	8	3.2	5570	1
5	9	3.6	5570	1
6	10	4	5570	1
7	11	4.4	5570	1
8	12	4.8	5570	1
9	13	5.2	5570	1
10	14	5.6	5570	1
11	15	6	5497	1
12	16	6.4	5497	1
13	17	6.8	5498	1
14	20	8	5499	1
15	19	7.6	5499	1
16	18	7.2	5498	1
17	17	6.8	5498	1
18	16	6.4	5497	1
19	15	6	5497	1
20	14	5.6	5497	1
21	13	5.2	5644	0
22	12	4.8	5644	1
23	11	4.4	5645	1
24	10	4	5645	1
25	9	3.6	5645	1
26	8	3.2	5646	1
27	18	7.2	5642	1
28	19	7.6	5641	0
29	20	8	5641	1
30	5	2	5647	1
Total				28
Detection Percentage (%)				93%
Limit				80%
Test Result				Complied



Trial Number							1
Number of Bursts in Trial							8
Chirp Center Frequency							5570
Burst	No. of Pulses	Pulse Width (us)	Chirp Width (MHz)	Pulse 1-to-2 Spacing (us)	Pulse 2-to-3 Spacing (us)	Starting Location Within Interval (ms)	
1	1	62.1	5	-	-	1091	
2	2	56	5	1729	-	133	
3	2	91.3	5	1230	-	1057	
4	3	50.7	5	1762	1616	1442	
5	2	92.6	5	1723	-	544	
6	2	87.3	5	1302	-	1089	
7	2	59.5	5	1291	-	1374	
8	2	52.2	5	1653	-	1237	
Detection Check (1=Detection; 0=No Detection)							1

Trial Number							2
Number of Bursts in Trial							9
Chirp Center Frequency							5570
Burst	No. of Pulses	Pulse Width (us)	Chirp Width (MHz)	Pulse 1-to-2 Spacing (us)	Pulse 2-to-3 Spacing (us)	Starting Location Within Interval (ms)	
1	3	90	20	1007	1326	30	
2	2	73.7	20	1785	-	979	
3	1	78.1	20	-	-	683	
4	2	92.4	20	1281	-	950	
5	1	61.2	20	-	-	612	
6	3	67.2	20	1525	1870	17	
7	1	78.5	20	-	-	429	
8	2	60.3	20	1931	-	936	
9	3	92.9	20	1403	1476	548	
Detection Check (1=Detection; 0=No Detection)							1



Trial Number							3
Number of Bursts in Trial							10
Chirp Center Frequency							5570
Burst	No. of Pulses	Pulse Width (us)	Chirp Width (MHz)	Pulse 1-to-2 Spacing (us)	Pulse 2-to-3 Spacing (us)	Starting Location Within Interval (ms)	
1	3	63.4	7	1574	1607	801	
2	1	98	7	-	-	966	
3	1	58.7	7	-	-	185	
4	1	88	7	-	-	1012	
5	3	79.5	7	1562	1370	943	
6	3	57.1	7	1900	1188	686	
7	2	64.4	7	1090	-	599	
8	1	78.7	7	-	-	1089	
9	1	69.3	7	-	-	188	
10	3	55.3	7	1375	1691	933	
Detection Check (1=Detection; 0=No Detection)							1

Trial Number							4
Number of Bursts in Trial							11
Chirp Center Frequency							5570
Burst	No. of Pulses	Pulse Width (us)	Chirp Width (MHz)	Pulse 1-to-2 Spacing (us)	Pulse 2-to-3 Spacing (us)	Starting Location Within Interval (ms)	
1	2	74.3	8	1642	-	24	
2	1	83.1	8	-	-	985	
3	2	59.5	8	1680	-	988	
4	2	59.8	8	1786	-	800	
5	2	77.6	8	1617	-	339	
6	2	79.9	8	1553	-	1040	
7	1	56	8	-	-	544	
8	3	71.4	8	1406	1927	452	
9	1	97.4	8	-	-	204	
10	2	98.3	8	1037	-	926	
11	1	63.6	8	-	-	1052	
Detection Check (1=Detection; 0=No Detection)							1



Trial Number							5
Number of Bursts in Trial							12
Chirp Center Frequency							5570
Burst	No. of Pulses	Pulse Width (us)	Chirp Width (MHz)	Pulse 1-to-2 Spacing (us)	Pulse 2-to-3 Spacing (us)	Starting Location Within Interval (ms)	
1	1	50	9	-	-	557	
2	2	62.5	9	1731	-	567	
3	2	55.4	9	1070	-	460	
4	1	65.7	9	-	-	4	
5	2	58	9	1512	-	64	
6	2	60.9	9	1230	-	650	
7	3	89.6	9	1598	1738	235	
8	3	84.4	9	1271	1617	873	
9	3	72.3	9	1498	1321	901	
10	1	58.9	9	-	-	663	
11	2	74.8	9	1584	-	919	
12	1	71.8	9	-	-	375	
Detection Check (1=Detection; 0=No Detection)							1

Trial Number							6
Number of Bursts in Trial							13
Chirp Center Frequency							5570
Burst	No. of Pulses	Pulse Width (us)	Chirp Width (MHz)	Pulse 1-to-2 Spacing (us)	Pulse 2-to-3 Spacing (us)	Starting Location Within Interval (ms)	
1	2	88.1	10	1257	-	846	
2	1	58.7	10	-	-	725	
3	2	97.1	10	1037	-	30	
4	3	83.1	10	1029	1106	490	
5	1	62.1	10	-	-	262	
6	2	71.4	10	1058	-	283	
7	2	86.3	10	1867	-	49	
8	3	77.3	10	1418	1876	634	
9	1	78.9	10	-	-	304	
10	3	79.2	10	1055	1572	564	
11	3	52	10	1582	1836	852	
12	3	56.5	10	1195	1542	525	
13	3	100	10	1638	1729	750	
Detection Check (1=Detection; 0=No Detection)							1



Trial Number							7
Number of Bursts in Trial							14
Chirp Center Frequency							5570
Burst	No. of Pulses	Pulse Width (us)	Chirp Width (MHz)	Pulse 1-to-2 Spacing (us)	Pulse 2-to-3 Spacing (us)	Starting Location Within Interval (ms)	
1	2	92.7	11	1208	-	231	
2	2	81.3	11	1144	-	804	
3	2	60.4	11	1555	-	34	
4	2	62.1	11	1320	-	427	
5	1	50	11	-	-	577	
6	3	65.9	11	1020	1365	3	
7	2	73.8	11	1308	-	51	
8	2	74.3	11	1143	-	360	
9	1	62.9	11	-	-	394	
10	2	74.8	11	1404	-	317	
11	2	69.7	11	1309	-	532	
12	2	69.8	11	1688	-	339	
13	2	77.4	11	1857	-	381	
14	1	55.1	11	-	-	426	
Detection Check (1=Detection; 0=No Detection)							1

Trial Number							8
Number of Bursts in Trial							15
Chirp Center Frequency							5570
Burst	No. of Pulses	Pulse Width (us)	Chirp Width (MHz)	Pulse 1-to-2 Spacing (us)	Pulse 2-to-3 Spacing (us)	Starting Location Within Interval (ms)	
1	1	91.7	12	-	-	776	
2	2	90	12	1196	-	187	
3	3	92.3	12	1486	1853	448	
4	2	66.8	12	1545	-	702	
5	1	64	12	-	-	403	
6	3	95.4	12	1123	1473	230	
7	3	66.8	12	1867	1401	604	
8	3	67.7	12	1472	1397	38	
9	1	68.2	12	-	-	735	
10	2	82.2	12	1297	-	610	
11	1	92.1	12	-	-	618	
12	2	57	12	1764	-	705	
13	2	58.5	12	1310	-	22	
14	3	85.5	12	1630	1447	641	
15	2	82.2	12	1371	-	109	
Detection Check (1=Detection; 0=No Detection)							1



Trial Number			9			
Number of Bursts in Trial			16			
Chirp Center Frequency			5570			
Burst	No. of Pulses	Pulse Width (us)	Chirp Width (MHz)	Pulse 1-to-2 Spacing (us)	Pulse 2-to-3 Spacing (us)	Starting Location Within Interval (ms)
1	2	74.4	13	1707	-	442
2	2	63.6	13	1725	-	280
3	2	71.3	13	1704	-	459
4	3	77.6	13	1063	1405	197
5	3	65.2	13	1731	1294	101
6	3	55.1	13	1109	1549	17
7	2	96.8	13	1034	-	131
8	3	80.8	13	1533	1051	365
9	1	60.4	13	-	-	222
10	2	61.8	13	1312	-	371
11	2	71.3	13	1657	-	33
12	2	98.1	13	1024	-	291
13	1	57.9	13	-	-	188
14	1	91.8	13	-	-	163
15	2	56.7	13	1259	-	426
16	2	89.7	13	1690	-	606
Detection Check (1=Detection; 0=No Detection)						1



Trial Number			10			
Number of Bursts in Trial			17			
Chirp Center Frequency			5570			
Burst	No. of Pulses	Pulse Width (us)	Chirp Width (MHz)	Pulse 1-to-2 Spacing (us)	Pulse 2-to-3 Spacing (us)	Starting Location Within Interval (ms)
1	2	74.4	14	1107	-	462
2	1	87.6	14	-	-	653
3	2	61.7	14	1741	-	457
4	2	57.5	14	1566	-	388
5	2	66.1	14	1855	-	63
6	3	70.1	14	1044	1012	136
7	1	66.4	14	-	-	343
8	1	59.2	14	-	-	349
9	2	88.3	14	1240	-	362
10	1	64.7	14	-	-	221
11	2	73	14	1703	-	144
12	2	81.7	14	1450	-	671
13	3	70.1	14	1741	1278	320
14	1	63.6	14	-	-	196
15	1	58.7	14	-	-	413
16	2	65.9	14	1478	-	170
17	1	72.7	14	-	-	564
Detection Check (1=Detection; 0=No Detection)						1



Trial Number			11			
Number of Bursts in Trial			18			
Chirp Center Frequency			5497			
Burst	No. of Pulses	Pulse Width (us)	Chirp Width (MHz)	Pulse 1-to-2 Spacing (us)	Pulse 2-to-3 Spacing (us)	Starting Location Within Interval (ms)
1	2	72.1	15	1193	-	130
2	3	76.3	15	1484	1390	114
3	1	86.1	15	-	-	14
4	1	73.2	15	-	-	604
5	1	81.2	15	-	-	548
6	2	99.5	15	1398	-	173
7	1	93.9	15	-	-	262
8	2	75.9	15	1921	-	38
9	3	79.2	15	1100	1429	84
10	3	77	15	1166	1799	610
11	1	91.8	15	-	-	339
12	3	56.8	15	1330	1556	580
13	2	83.1	15	1556	-	295
14	2	63	15	1552	-	156
15	1	65.7	15	-	-	439
16	1	64.5	15	-	-	188
17	1	88.5	15	-	-	419
18	1	60.6	15	-	-	205
Detection Check (1=Detection; 0=No Detection)						1



Trial Number			12			
Number of Bursts in Trial			19			
Chirp Center Frequency			5497			
Burst	No. of Pulses	Pulse Width (us)	Chirp Width (MHz)	Pulse 1-to-2 Spacing (us)	Pulse 2-to-3 Spacing (us)	Starting Location Within Interval (ms)
1	2	90.5	16	1299	-	381
2	2	88.4	16	1418	-	327
3	2	53.7	16	1055	-	536
4	1	80.5	16	-	-	285
5	1	50.4	16	-	-	398
6	2	61.2	16	1749	-	439
7	2	78.8	16	1065	-	129
8	3	75	16	1748	1820	325
9	2	96.7	16	1254	-	440
10	3	76.3	16	1848	1106	397
11	1	73.3	16	-	-	232
12	2	92.4	16	1317	-	91
13	2	92.4	16	1854	-	256
14	3	64.4	16	1240	1634	582
15	2	67.3	16	1473	-	117
16	2	84.1	16	1795	-	202
17	1	80.9	16	-	-	135
18	1	74.6	16	-	-	396
19	2	97.6	16	1805	-	615
Detection Check (1=Detection; 0=No Detection)						1



Trial Number							13
Number of Bursts in Trial							20
Chirp Center Frequency							5498
Burst	No. of Pulses	Pulse Width (us)	Chirp Width (MHz)	Pulse 1-to-2 Spacing (us)	Pulse 2-to-3 Spacing (us)	Starting Location Within Interval (ms)	
1	2	66.1	17	1417	-	388	
2	2	86.7	17	1693	-	348	
3	2	70.5	17	1263	-	215	
4	2	78	17	1446	-	28	
5	2	66	17	1185	-	585	
6	2	80.6	17	1855	-	65	
7	1	95.5	17	-	-	92	
8	1	98.8	17	-	-	68	
9	3	64.3	17	1641	1108	517	
10	1	75.1	17	-	-	121	
11	2	72.6	17	1499	-	448	
12	1	60.3	17	-	-	567	
13	2	54.9	17	1056	-	245	
14	2	98.8	17	1023	-	584	
15	2	60.9	17	1243	-	579	
16	2	62.7	17	1226	-	464	
17	1	80.1	17	-	-	89	
18	2	70.9	17	1711	-	153	
19	1	90.7	17	-	-	282	
20	1	98.9	17	-	-	71	
Detection Check (1=Detection; 0=No Detection)							1

Trial Number							14
Number of Bursts in Trial							8
Chirp Center Frequency							5499
Burst	No. of Pulses	Pulse Width (us)	Chirp Width (MHz)	Pulse 1-to-2 Spacing (us)	Pulse 2-to-3 Spacing (us)	Starting Location Within Interval (ms)	
1	2	67.5	20	1542	-	947	
2	3	83.6	20	1272	1696	124	
3	2	93.2	20	1877	-	701	
4	1	55.6	20	-	-	1123	
5	3	84.2	20	1733	1619	756	
6	3	69.1	20	1612	1071	1	
7	2	66.9	20	1905	-	7	
8	3	86.8	20	1697	1621	1082	
Detection Check (1=Detection; 0=No Detection)							1



Trial Number							15
Number of Bursts in Trial							9
Chirp Center Frequency							5499
Burst	No. of Pulses	Pulse Width (us)	Chirp Width (MHz)	Pulse 1-to-2 Spacing (us)	Pulse 2-to-3 Spacing (us)	Starting Location Within Interval (ms)	
1	2	62.2	19	1571	-	949	
2	2	85	19	1669	-	189	
3	2	64.5	19	1505	-	176	
4	2	50.4	19	1325	-	538	
5	2	66.1	19	1483	-	908	
6	2	71.2	19	1110	-	1017	
7	3	53.7	19	1445	1677	492	
8	3	62.5	19	1596	1341	349	
9	3	62	19	1929	1221	1105	
Detection Check (1=Detection; 0=No Detection)							1

Trial Number							16
Number of Bursts in Trial							10
Chirp Center Frequency							5498
Burst	No. of Pulses	Pulse Width (us)	Chirp Width (MHz)	Pulse 1-to-2 Spacing (us)	Pulse 2-to-3 Spacing (us)	Starting Location Within Interval (ms)	
1	2	80.5	18	1910	-	284	
2	2	64.2	18	1661	-	751	
3	2	90.1	18	1041	-	491	
4	2	69.8	18	1495	-	107	
5	1	73.1	18	-	-	490	
6	3	77.2	18	1418	1145	1155	
7	3	52.6	18	1732	1787	772	
8	2	71.4	18	1562	-	121	
9	2	89.8	18	1491	-	89	
10	2	76.4	18	1355	-	615	
Detection Check (1=Detection; 0=No Detection)							1



Trial Number							17
Number of Bursts in Trial							11
Chirp Center Frequency							5498
Burst	No. of Pulses	Pulse Width (us)	Chirp Width (MHz)	Pulse 1-to-2 Spacing (us)	Pulse 2-to-3 Spacing (us)	Starting Location Within Interval (ms)	
1	2	51.2	17	1236	-	740	
2	1	71.7	17	-	-	941	
3	2	74.7	17	1164	-	370	
4	2	50.9	17	1919	-	371	
5	2	65.2	17	1206	-	1033	
6	2	98	17	1182	-	346	
7	2	58.7	17	1612	-	639	
8	1	63.8	17	-	-	1056	
9	3	86.3	17	1545	1065	205	
10	1	94.4	17	-	-	753	
11	3	88.5	17	1699	1319	58	
Detection Check (1=Detection; 0=No Detection)							1

Trial Number							18
Number of Bursts in Trial							12
Chirp Center Frequency							5497
Burst	No. of Pulses	Pulse Width (us)	Chirp Width (MHz)	Pulse 1-to-2 Spacing (us)	Pulse 2-to-3 Spacing (us)	Starting Location Within Interval (ms)	
1	2	88.7	16	1405	-	448	
2	3	90.2	16	1544	1235	621	
3	1	96.5	16	-	-	512	
4	2	80.5	16	1090	-	321	
5	2	63.7	16	1268	-	798	
6	1	53.4	16	-	-	809	
7	2	52.3	16	1043	-	301	
8	3	54.7	16	1701	1104	796	
9	3	75.6	16	1923	1729	669	
10	2	59.2	16	1244	-	369	
11	1	56.3	16	-	-	51	
12	2	87.8	16	1608	-	733	
Detection Check (1=Detection; 0=No Detection)							1



Trial Number							19
Number of Bursts in Trial							13
Chirp Center Frequency							5497
Burst	No. of Pulses	Pulse Width (us)	Chirp Width (MHz)	Pulse 1-to-2 Spacing (us)	Pulse 2-to-3 Spacing (us)	Starting Location Within Interval (ms)	
1	2	68.2	15	1104	-	229	
2	2	58.4	15	1627	-	488	
3	3	74.7	15	1861	1015	137	
4	2	58.2	15	1593	-	520	
5	1	51.6	15	-	-	799	
6	2	94.7	15	1469	-	43	
7	2	70.7	15	1091	-	126	
8	2	82.9	15	1472	-	607	
9	3	62.7	15	1168	1453	527	
10	2	63.1	15	1529	-	143	
11	1	96.1	15	-	-	176	
12	2	57	15	1457	-	882	
13	3	95.6	15	1707	1501	214	
Detection Check (1=Detection; 0=No Detection)							1

Trial Number							20
Number of Bursts in Trial							14
Chirp Center Frequency							5497
Burst	No. of Pulses	Pulse Width (us)	Chirp Width (MHz)	Pulse 1-to-2 Spacing (us)	Pulse 2-to-3 Spacing (us)	Starting Location Within Interval (ms)	
1	1	95.7	14	-	-	117	
2	1	93.1	14	-	-	720	
3	1	55.8	14	-	-	297	
4	1	76.7	14	-	-	284	
5	2	68	14	1686	-	472	
6	3	94.1	14	1796	1393	264	
7	2	53.9	14	1293	-	525	
8	1	99.3	14	-	-	155	
9	2	73.3	14	1458	-	65	
10	2	93.3	14	1196	-	451	
11	3	55.8	14	1895	1034	243	
12	1	66.4	14	-	-	228	
13	2	65.6	14	1732	-	746	
14	2	76.5	14	1187	-	522	
Detection Check (1=Detection; 0=No Detection)							1



Trial Number							21
Number of Bursts in Trial							15
Chirp Center Frequency							5644
Burst	No. of Pulses	Pulse Width (us)	Chirp Width (MHz)	Pulse 1-to-2 Spacing (us)	Pulse 2-to-3 Spacing (us)	Starting Location Within Interval (ms)	
1	1	85.1	13	-	-	565	
2	2	72.5	13	1648	-	211	
3	1	67.5	13	-	-	348	
4	2	56.1	13	1360	-	156	
5	1	71.1	13	-	-	718	
6	2	93.1	13	1391	-	400	
7	1	56.5	13	-	-	482	
8	1	63.8	13	-	-	703	
9	2	67.4	13	1727	-	780	
10	1	52.3	13	-	-	102	
11	3	62.4	13	1228	1715	304	
12	2	53.3	13	1630	-	57	
13	2	83.1	13	1205	-	768	
14	2	93.7	13	1085	-	461	
15	2	90.7	13	1297	-	746	
Detection Check (1=Detection; 0=No Detection)							0

Trial Number							22
Number of Bursts in Trial							16
Chirp Center Frequency							5644
Burst	No. of Pulses	Pulse Width (us)	Chirp Width (MHz)	Pulse 1-to-2 Spacing (us)	Pulse 2-to-3 Spacing (us)	Starting Location Within Interval (ms)	
1	2	98.8	12	1439	-	95	
2	1	54.5	12	-	-	676	
3	2	80.5	12	1360	-	8	
4	2	55.9	12	1906	-	373	
5	2	72.1	12	1623	-	254	
6	2	84.4	12	1604	-	480	
7	1	78.5	12	-	-	663	
8	1	88	12	-	-	314	
9	2	74.7	12	1157	-	596	
10	2	97.1	12	1673	-	264	
11	1	81.6	12	-	-	740	
12	1	83.6	12	-	-	163	
13	3	87.6	12	1757	1322	628	
14	2	58.5	12	1372	-	132	
15	3	91.8	12	1767	1183	106	
16	2	58.8	12	1432	-	659	
Detection Check (1=Detection; 0=No Detection)							1



Trial Number			23			
Number of Bursts in Trial			17			
Chirp Center Frequency			5645			
Burst	No. of Pulses	Pulse Width (us)	Chirp Width (MHz)	Pulse 1-to-2 Spacing (us)	Pulse 2-to-3 Spacing (us)	Starting Location Within Interval (ms)
1	1	96	11	-	-	284
2	2	92.5	11	1241	-	488
3	2	89.5	11	1347	-	76
4	2	74.8	11	1607	-	688
5	2	60.6	11	1523	-	28
6	2	71.5	11	1659	-	383
7	2	71.1	11	1454	-	182
8	1	98.7	11	-	-	20
9	2	85.1	11	1770	-	576
10	2	89.2	11	1086	-	410
11	2	60.7	11	1101	-	458
12	2	75.2	11	1719	-	348
13	2	75.7	11	1799	-	481
14	3	56.7	11	1132	1884	587
15	2	65	11	1885	-	480
16	2	64.6	11	1910	-	195
17	3	69.9	11	1410	1190	396
Detection Check (1=Detection; 0=No Detection)						1



Trial Number			24			
Number of Bursts in Trial			18			
Chirp Center Frequency			5645			
Burst	No. of Pulses	Pulse Width (us)	Chirp Width (MHz)	Pulse 1-to-2 Spacing (us)	Pulse 2-to-3 Spacing (us)	Starting Location Within Interval (ms)
1	3	83.8	10	1290	1021	536
2	2	66.9	10	1112	-	44
3	3	91	10	1220	1504	611
4	2	86.1	10	1678	-	456
5	3	65.5	10	1928	1222	330
6	1	62.6	10	-	-	297
7	3	68.7	10	1505	1200	351
8	3	59.2	10	1452	1114	230
9	1	73.9	10	-	-	222
10	1	77.2	10	-	-	57
11	2	96.4	10	1357	-	399
12	2	99.9	10	1173	-	299
13	2	99.9	10	1520	-	464
14	1	86.7	10	-	-	294
15	1	92.6	10	-	-	653
16	1	77.1	10	-	-	550
17	2	81.1	10	1664	-	566
18	3	68.4	10	1536	1309	580
Detection Check (1=Detection; 0=No Detection)						1



Trial Number			25			
Number of Bursts in Trial			19			
Chirp Center Frequency			5645			
Burst	No. of Pulses	Pulse Width (us)	Chirp Width (MHz)	Pulse 1-to-2 Spacing (us)	Pulse 2-to-3 Spacing (us)	Starting Location Within Interval (ms)
1	3	68.2	9	1723	1868	471
2	3	83.7	9	1711	1405	368
3	2	69.7	9	1781	-	425
4	1	59.7	9	-	-	440
5	2	96.7	9	1484	-	123
6	2	95.8	9	1319	-	261
7	3	71.3	9	1095	1354	332
8	3	53.2	9	1527	1427	427
9	2	69.5	9	1771	-	397
10	3	63.9	9	1075	1447	67
11	2	93.4	9	1783	-	174
12	2	77.3	9	1564	-	17
13	2	73.1	9	1294	-	216
14	1	77.4	9	-	-	292
15	3	57.2	9	1722	1886	619
16	2	68.7	9	1629	-	233
17	1	60.8	9	-	-	226
18	3	69.7	9	1128	1224	599
19	1	62.2	9	-	-	433
Detection Check (1=Detection; 0=No Detection)						1



Trial Number							26
Number of Bursts in Trial							20
Chirp Center Frequency							5646
Burst	No. of Pulses	Pulse Width (us)	Chirp Width (MHz)	Pulse 1-to-2 Spacing (us)	Pulse 2-to-3 Spacing (us)	Starting Location Within Interval (ms)	
1	1	80.5	8	-	-	90	
2	3	62.6	8	1406	1343	319	
3	3	85.6	8	1190	1529	384	
4	2	83.9	8	1208	-	567	
5	2	92.4	8	1488	-	234	
6	2	54	8	1529	-	535	
7	3	81.3	8	1501	1812	325	
8	1	98.5	8	-	-	532	
9	1	85.8	8	-	-	272	
10	2	84.7	8	1593	-	182	
11	2	83.3	8	1705	-	134	
12	2	79.8	8	1567	-	286	
13	1	77.9	8	-	-	368	
14	3	98.4	8	1510	1569	290	
15	2	79.9	8	1588	-	231	
16	3	78	8	1140	1353	353	
17	3	55.2	8	1700	1327	53	
18	3	71.9	8	1081	1224	44	
19	1	62	8	-	-	298	
20	3	70.5	8	1888	1442	529	
Detection Check (1=Detection; 0=No Detection)							1

Trial Number							27
Number of Bursts in Trial							8
Chirp Center Frequency							5642
Burst	No. of Pulses	Pulse Width (us)	Chirp Width (MHz)	Pulse 1-to-2 Spacing (us)	Pulse 2-to-3 Spacing (us)	Starting Location Within Interval (ms)	
1	2	69.1	18	1076	-	1436	
2	2	62.1	18	1688	-	22	
3	2	94.8	18	1891	-	897	
4	1	75.8	18	-	-	1186	
5	2	65.4	18	1713	-	589	
6	2	97.7	18	1292	-	614	
7	3	98.1	18	1670	1711	506	
8	2	85.4	18	1672	-	776	
Detection Check (1=Detection; 0=No Detection)							1



Trial Number		28				
Number of Bursts in Trial		9				
Chirp Center Frequency		5641				
Burst	No. of Pulses	Pulse Width (us)	Chirp Width (MHz)	Pulse 1-to-2 Spacing (us)	Pulse 2-to-3 Spacing (us)	Starting Location Within Interval (ms)
1	3	82	19	1233	1713	679
2	3	87.7	19	1554	1123	473
3	2	98.9	19	1518	-	869
4	1	55	19	-	-	719
5	1	93.6	19	-	-	902
6	2	58.7	19	1641	-	1243
7	2	88.7	19	1387	-	410
8	1	60.3	19	-	-	1154
9	1	97.7	19	-	-	512
Detection Check (1=Detection; 0=No Detection)						0

Trial Number		29				
Number of Bursts in Trial		10				
Chirp Center Frequency		5641				
Burst	No. of Pulses	Pulse Width (us)	Chirp Width (MHz)	Pulse 1-to-2 Spacing (us)	Pulse 2-to-3 Spacing (us)	Starting Location Within Interval (ms)
1	1	69.6	20	-	-	1131
2	1	74.5	20	-	-	290
3	1	60.9	20	-	-	895
4	1	74.6	20	-	-	202
5	2	99.3	20	1501	-	139
6	2	95.3	20	1065	-	854
7	2	91.9	20	1722	-	219
8	2	51	20	1285	-	57
9	2	87.7	20	1747	-	141
10	1	87.2	20	-	-	596
Detection Check (1=Detection; 0=No Detection)						1



Trial Number		30				
Number of Bursts in Trial		11				
Chirp Center Frequency		5647				
Burst	No. of Pulses	Pulse Width (us)	Chirp Width (MHz)	Pulse 1-to-2 Spacing (us)	Pulse 2-to-3 Spacing (us)	Starting Location Within Interval (ms)
1	3	59.9	5	1901	1196	935
2	2	77.1	5	1590	-	1038
3	2	62.7	5	1227	-	690
4	1	77.1	5	-	-	547
5	3	99.8	5	1798	1790	551
6	2	61.5	5	1135	-	876
7	2	77.5	5	1583	-	448
8	2	57.3	5	1890	-	736
9	2	53.5	5	1757	-	362
10	1	66.6	5	-	-	836
11	3	80.7	5	1811	1289	410
Detection Check (1=Detection; 0=No Detection)						1



Type 6 Radar Statistical Performance

Trial #	Test Freq. (MHz)	Pulses / Hop	Pulse Width (us)	PRI (us)	1=Detection 0=No Detection
1	5570	9	1	333	1
2	5570	9	1	333	1
3	5570	9	1	333	1
4	5570	9	1	333	1
5	5570	9	1	333	1
6	5570	9	1	333	1
7	5570	9	1	333	1
8	5570	9	1	333	1
9	5570	9	1	333	1
10	5570	9	1	333	1
11	5570	9	1	333	1
12	5570	9	1	333	1
13	5570	9	1	333	1
14	5570	9	1	333	1
15	5570	9	1	333	1
16	5570	9	1	333	1
17	5570	9	1	333	1
18	5570	9	1	333	1
19	5570	9	1	333	1
20	5570	9	1	333	1
21	5570	9	1	333	1
22	5570	9	1	333	1
23	5570	9	1	333	1
24	5570	9	1	333	1
25	5570	9	1	333	1
26	5570	9	1	333	1
27	5570	9	1	333	1
28	5570	9	1	333	1
29	5570	9	1	333	1
30	5570	9	1	333	1
Detection Percentage (%)					100.000
Limit					70%
Test Result					Complied



Modulation Mode: 802.11ax (HEW160)

Type 1 Radar Statistical Performance

Trial #	Test Freq. (MHz)	Pulse Repetition Frequency Number	Pulse Repetition Frequency (Pulse Per Second)	PRI (us)	1=Detection 0=No Detection
1	5503	1	1930.5	518	1
2	5553	23	326.2	3066	1
3	5512	19	1139.0	878	1
4	5511	12	1355.0	738	1
5	5580	4	1730.1	578	1
6	5572	8	1519.8	658	1
7	5519	15	1253.1	798	1
8	5592	6	1618.1	618	1
9	5516	14	1285.3	778	1
10	5646	3	1792.1	558	1
11	5547	13	1319.3	758	1
12	5576	9	1474.9	678	1
13	5543	7	1567.4	638	0
14	5564	17	1193.3	838	1
15	5565	10	1432.7	698	1
16	5555	-	1692.0	591	1
17	5586	-	328.1	3048	1
18	5560	-	373.4	2678	1
19	5638	-	574.4	1741	1
20	5560	-	1216.5	822	0
21	5524	-	801.3	1248	1
22	5614	-	488.5	2047	1
23	5638	-	956.0	1046	1
24	5637	-	517.6	1932	1
25	5584	-	1422.5	703	1
26	5617	-	542.0	1845	1
27	5547	-	741.3	1349	1
28	5639	-	881.8	1134	1
29	5625	-	427.4	2340	1
30	5516	-	628.9	1590	1
Detection Percentage (%)					93.333
Limit					60%
Test Result					Complied



Type 2 Radar Statistical Performance

Trial #	Test Freq. (MHz)	Pulse Width (us)	PRI (us)	Pulses / Burst	1=Detection 0=No Detection
1	5581	2.6	221	23	1
2	5573	4.6	198	27	0
3	5592	1.1	184	29	1
4	5645	4.8	203	24	1
5	5496	2.4	162	25	1
6	5629	3.4	204	28	1
7	5541	2.3	170	27	1
8	5559	3.5	184	23	1
9	5540	4.9	150	27	1
10	5495	4.6	211	29	1
11	5562	2.9	158	23	1
12	5633	2.6	226	27	1
13	5593	1.6	204	26	1
14	5616	3.9	181	25	1
15	5614	4.6	202	24	1
16	5540	4.1	194	27	1
17	5607	2.3	193	28	1
18	5646	3.9	173	29	1
19	5640	4.3	188	23	1
20	5606	1.5	215	26	1
21	5621	4.9	227	27	1
22	5590	1.1	199	23	1
23	5633	4.5	155	29	1
24	5584	4.0	190	27	1
25	5508	2.4	151	23	1
26	5574	2.5	180	28	1
27	5556	2.5	228	23	1
28	5610	2.5	203	25	1
29	5575	1.5	188	25	0
30	5646	1.9	217	24	1
Detection Percentage (%)					93.333
Limit					60%
Test Result					Complied



Type 3 Radar Statistical Performance

Trial #	Test Freq. (MHz)	Pulse Width (us)	PRI (us)	Pulses / Burst	1=Detection 0=No Detection
1	5585	8.0	205	16	1
2	5620	6.7	382	18	1
3	5491	8.6	418	16	1
4	5648	9.4	351	17	1
5	5522	7.4	383	18	0
6	5564	9.8	232	16	1
7	5644	9.1	377	17	1
8	5630	9.6	457	16	1
9	5514	8.0	471	18	1
10	5590	9.0	304	18	1
11	5623	8.0	316	17	1
12	5502	9.8	325	16	1
13	5609	8.0	409	17	1
14	5561	9.9	200	17	1
15	5591	8.8	458	16	1
16	5600	8.0	232	18	1
17	5618	8.3	250	16	1
18	5648	8.7	270	16	1
19	5638	7.7	350	17	1
20	5505	7.1	230	16	1
21	5538	7.3	416	18	1
22	5644	7.6	498	18	1
23	5538	7.3	286	17	1
24	5576	7.3	287	16	1
25	5547	7.5	462	17	1
26	5507	6.2	300	17	1
27	5639	6.4	323	18	0
28	5519	7.1	420	16	1
29	5522	7.2	395	18	1
30	5569	8.4	377	16	1
Detection Percentage (%)					93.333
Limit					60%
Test Result					Complied



Type 4 Radar Statistical Performance

Trial #	Test Freq. (MHz)	Pulse Width (us)	PRI (us)	Pulses / Burst	1=Detection 0=No Detection
1	5548	18.0	242	15	1
2	5539	19.9	279	12	1
3	5594	12.9	487	14	0
4	5615	15.0	452	13	1
5	5579	16.3	230	12	1
6	5621	19.8	238	13	0
7	5605	18.2	420	16	1
8	5584	16.3	452	15	1
9	5515	14.2	495	12	1
10	5520	17.8	228	16	1
11	5625	19.1	211	16	1
12	5516	18.4	283	15	1
13	5496	11.8	411	12	1
14	5498	14.2	284	13	1
15	5559	13.9	202	12	1
16	5557	17.8	340	14	1
17	5493	15.6	290	16	0
18	5491	14.6	250	16	0
19	5535	14.4	484	15	1
20	5606	18.9	387	13	1
21	5611	11.1	348	15	0
22	5521	13.8	291	16	0
23	5618	14.3	295	12	0
24	5584	12.5	300	12	1
25	5524	12.5	322	14	1
26	5508	12.5	383	13	1
27	5538	15.7	322	16	1
28	5617	19.8	469	13	1
29	5557	18.6	406	15	1
30	5604	15.9	238	14	1
Detection Percentage (%)					76.667
Limit					60%
Test Result					Complied



Total Type 1~4 Radar Statistical Performance

Radar Type #	Detection Percentage (%)
1	93.333
2	93.333
3	93.333
4	76.667
Aggregate (Radar Types 1-4)	89.167
Limit	80%
Test Result	Complied



Type 5 Radar Statistical Performance

Center Freq. (MHz)	Low Edge (MHz)	High Edge (MHz)	VSG Freq. (MHz)	Detection
Trial	Chirp	Offset		
5570	5491	5649		
1	5	2	5570	0
2	20	8	5570	1
3	7	2.8	5570	1
4	8	3.2	5570	1
5	9	3.6	5570	1
6	10	4	5570	1
7	11	4.4	5570	1
8	12	4.8	5570	1
9	13	5.2	5570	1
10	14	5.6	5570	1
11	15	6	5497	1
12	16	6.4	5497	1
13	17	6.8	5498	1
14	20	8	5499	1
15	19	7.6	5499	1
16	18	7.2	5498	1
17	17	6.8	5498	1
18	16	6.4	5497	1
19	15	6	5497	1
20	14	5.6	5497	1
21	13	5.2	5644	0
22	12	4.8	5644	1
23	11	4.4	5645	0
24	10	4	5645	1
25	9	3.6	5645	1
26	8	3.2	5646	1
27	18	7.2	5642	1
28	19	7.6	5641	0
29	20	8	5641	0
30	5	2	5647	1
Total				25
Detection Percentage (%)				83%
Limit				80%
Test Result				Complied



Trial Number							1
Number of Bursts in Trial							8
Chirp Center Frequency							5570
Burst	No. of Pulses	Pulse Width (us)	Chirp Width (MHz)	Pulse 1-to-2 Spacing (us)	Pulse 2-to-3 Spacing (us)	Starting Location Within Interval (ms)	
1	1	62.1	5	-	-	1091	
2	2	56	5	1729	-	133	
3	2	91.3	5	1230	-	1057	
4	3	50.7	5	1762	1616	1442	
5	2	92.6	5	1723	-	544	
6	2	87.3	5	1302	-	1089	
7	2	59.5	5	1291	-	1374	
8	2	52.2	5	1653	-	1237	
Detection Check (1=Detection; 0=No Detection)							0

Trial Number							2
Number of Bursts in Trial							9
Chirp Center Frequency							5570
Burst	No. of Pulses	Pulse Width (us)	Chirp Width (MHz)	Pulse 1-to-2 Spacing (us)	Pulse 2-to-3 Spacing (us)	Starting Location Within Interval (ms)	
1	3	90	20	1007	1326	30	
2	2	73.7	20	1785	-	979	
3	1	78.1	20	-	-	683	
4	2	92.4	20	1281	-	950	
5	1	61.2	20	-	-	612	
6	3	67.2	20	1525	1870	17	
7	1	78.5	20	-	-	429	
8	2	60.3	20	1931	-	936	
9	3	92.9	20	1403	1476	548	
Detection Check (1=Detection; 0=No Detection)							1



Trial Number							3
Number of Bursts in Trial							10
Chirp Center Frequency							5570
Burst	No. of Pulses	Pulse Width (us)	Chirp Width (MHz)	Pulse 1-to-2 Spacing (us)	Pulse 2-to-3 Spacing (us)	Starting Location Within Interval (ms)	
1	3	63.4	7	1574	1607	801	
2	1	98	7	-	-	966	
3	1	58.7	7	-	-	185	
4	1	88	7	-	-	1012	
5	3	79.5	7	1562	1370	943	
6	3	57.1	7	1900	1188	686	
7	2	64.4	7	1090	-	599	
8	1	78.7	7	-	-	1089	
9	1	69.3	7	-	-	188	
10	3	55.3	7	1375	1691	933	
Detection Check (1=Detection; 0=No Detection)							1

Trial Number							4
Number of Bursts in Trial							11
Chirp Center Frequency							5570
Burst	No. of Pulses	Pulse Width (us)	Chirp Width (MHz)	Pulse 1-to-2 Spacing (us)	Pulse 2-to-3 Spacing (us)	Starting Location Within Interval (ms)	
1	2	74.3	8	1642	-	24	
2	1	83.1	8	-	-	985	
3	2	59.5	8	1680	-	988	
4	2	59.8	8	1786	-	800	
5	2	77.6	8	1617	-	339	
6	2	79.9	8	1553	-	1040	
7	1	56	8	-	-	544	
8	3	71.4	8	1406	1927	452	
9	1	97.4	8	-	-	204	
10	2	98.3	8	1037	-	926	
11	1	63.6	8	-	-	1052	
Detection Check (1=Detection; 0=No Detection)							1



Trial Number							5
Number of Bursts in Trial							12
Chirp Center Frequency							5570
Burst	No. of Pulses	Pulse Width (us)	Chirp Width (MHz)	Pulse 1-to-2 Spacing (us)	Pulse 2-to-3 Spacing (us)	Starting Location Within Interval (ms)	
1	1	50	9	-	-	557	
2	2	62.5	9	1731	-	567	
3	2	55.4	9	1070	-	460	
4	1	65.7	9	-	-	4	
5	2	58	9	1512	-	64	
6	2	60.9	9	1230	-	650	
7	3	89.6	9	1598	1738	235	
8	3	84.4	9	1271	1617	873	
9	3	72.3	9	1498	1321	901	
10	1	58.9	9	-	-	663	
11	2	74.8	9	1584	-	919	
12	1	71.8	9	-	-	375	
Detection Check (1=Detection; 0=No Detection)							1

Trial Number							6
Number of Bursts in Trial							13
Chirp Center Frequency							5570
Burst	No. of Pulses	Pulse Width (us)	Chirp Width (MHz)	Pulse 1-to-2 Spacing (us)	Pulse 2-to-3 Spacing (us)	Starting Location Within Interval (ms)	
1	2	88.1	10	1257	-	846	
2	1	58.7	10	-	-	725	
3	2	97.1	10	1037	-	30	
4	3	83.1	10	1029	1106	490	
5	1	62.1	10	-	-	262	
6	2	71.4	10	1058	-	283	
7	2	86.3	10	1867	-	49	
8	3	77.3	10	1418	1876	634	
9	1	78.9	10	-	-	304	
10	3	79.2	10	1055	1572	564	
11	3	52	10	1582	1836	852	
12	3	56.5	10	1195	1542	525	
13	3	100	10	1638	1729	750	
Detection Check (1=Detection; 0=No Detection)							1



Trial Number							7
Number of Bursts in Trial							14
Chirp Center Frequency							5570
Burst	No. of Pulses	Pulse Width (us)	Chirp Width (MHz)	Pulse 1-to-2 Spacing (us)	Pulse 2-to-3 Spacing (us)	Starting Location Within Interval (ms)	
1	2	92.7	11	1208	-	231	
2	2	81.3	11	1144	-	804	
3	2	60.4	11	1555	-	34	
4	2	62.1	11	1320	-	427	
5	1	50	11	-	-	577	
6	3	65.9	11	1020	1365	3	
7	2	73.8	11	1308	-	51	
8	2	74.3	11	1143	-	360	
9	1	62.9	11	-	-	394	
10	2	74.8	11	1404	-	317	
11	2	69.7	11	1309	-	532	
12	2	69.8	11	1688	-	339	
13	2	77.4	11	1857	-	381	
14	1	55.1	11	-	-	426	
Detection Check (1=Detection; 0=No Detection)							1

Trial Number							8
Number of Bursts in Trial							15
Chirp Center Frequency							5570
Burst	No. of Pulses	Pulse Width (us)	Chirp Width (MHz)	Pulse 1-to-2 Spacing (us)	Pulse 2-to-3 Spacing (us)	Starting Location Within Interval (ms)	
1	1	91.7	12	-	-	776	
2	2	90	12	1196	-	187	
3	3	92.3	12	1486	1853	448	
4	2	66.8	12	1545	-	702	
5	1	64	12	-	-	403	
6	3	95.4	12	1123	1473	230	
7	3	66.8	12	1867	1401	604	
8	3	67.7	12	1472	1397	38	
9	1	68.2	12	-	-	735	
10	2	82.2	12	1297	-	610	
11	1	92.1	12	-	-	618	
12	2	57	12	1764	-	705	
13	2	58.5	12	1310	-	22	
14	3	85.5	12	1630	1447	641	
15	2	82.2	12	1371	-	109	
Detection Check (1=Detection; 0=No Detection)							1



Trial Number			9			
Number of Bursts in Trial			16			
Chirp Center Frequency			5570			
Burst	No. of Pulses	Pulse Width (us)	Chirp Width (MHz)	Pulse 1-to-2 Spacing (us)	Pulse 2-to-3 Spacing (us)	Starting Location Within Interval (ms)
1	2	74.4	13	1707	-	442
2	2	63.6	13	1725	-	280
3	2	71.3	13	1704	-	459
4	3	77.6	13	1063	1405	197
5	3	65.2	13	1731	1294	101
6	3	55.1	13	1109	1549	17
7	2	96.8	13	1034	-	131
8	3	80.8	13	1533	1051	365
9	1	60.4	13	-	-	222
10	2	61.8	13	1312	-	371
11	2	71.3	13	1657	-	33
12	2	98.1	13	1024	-	291
13	1	57.9	13	-	-	188
14	1	91.8	13	-	-	163
15	2	56.7	13	1259	-	426
16	2	89.7	13	1690	-	606
Detection Check (1=Detection; 0=No Detection)						1



Trial Number			10			
Number of Bursts in Trial			17			
Chirp Center Frequency			5570			
Burst	No. of Pulses	Pulse Width (us)	Chirp Width (MHz)	Pulse 1-to-2 Spacing (us)	Pulse 2-to-3 Spacing (us)	Starting Location Within Interval (ms)
1	2	74.4	14	1107	-	462
2	1	87.6	14	-	-	653
3	2	61.7	14	1741	-	457
4	2	57.5	14	1566	-	388
5	2	66.1	14	1855	-	63
6	3	70.1	14	1044	1012	136
7	1	66.4	14	-	-	343
8	1	59.2	14	-	-	349
9	2	88.3	14	1240	-	362
10	1	64.7	14	-	-	221
11	2	73	14	1703	-	144
12	2	81.7	14	1450	-	671
13	3	70.1	14	1741	1278	320
14	1	63.6	14	-	-	196
15	1	58.7	14	-	-	413
16	2	65.9	14	1478	-	170
17	1	72.7	14	-	-	564
Detection Check (1=Detection; 0=No Detection)						1



Trial Number			11			
Number of Bursts in Trial			18			
Chirp Center Frequency			5497			
Burst	No. of Pulses	Pulse Width (us)	Chirp Width (MHz)	Pulse 1-to-2 Spacing (us)	Pulse 2-to-3 Spacing (us)	Starting Location Within Interval (ms)
1	2	72.1	15	1193	-	130
2	3	76.3	15	1484	1390	114
3	1	86.1	15	-	-	14
4	1	73.2	15	-	-	604
5	1	81.2	15	-	-	548
6	2	99.5	15	1398	-	173
7	1	93.9	15	-	-	262
8	2	75.9	15	1921	-	38
9	3	79.2	15	1100	1429	84
10	3	77	15	1166	1799	610
11	1	91.8	15	-	-	339
12	3	56.8	15	1330	1556	580
13	2	83.1	15	1556	-	295
14	2	63	15	1552	-	156
15	1	65.7	15	-	-	439
16	1	64.5	15	-	-	188
17	1	88.5	15	-	-	419
18	1	60.6	15	-	-	205
Detection Check (1=Detection; 0=No Detection)						1



Trial Number			12			
Number of Bursts in Trial			19			
Chirp Center Frequency			5497			
Burst	No. of Pulses	Pulse Width (us)	Chirp Width (MHz)	Pulse 1-to-2 Spacing (us)	Pulse 2-to-3 Spacing (us)	Starting Location Within Interval (ms)
1	2	90.5	16	1299	-	381
2	2	88.4	16	1418	-	327
3	2	53.7	16	1055	-	536
4	1	80.5	16	-	-	285
5	1	50.4	16	-	-	398
6	2	61.2	16	1749	-	439
7	2	78.8	16	1065	-	129
8	3	75	16	1748	1820	325
9	2	96.7	16	1254	-	440
10	3	76.3	16	1848	1106	397
11	1	73.3	16	-	-	232
12	2	92.4	16	1317	-	91
13	2	92.4	16	1854	-	256
14	3	64.4	16	1240	1634	582
15	2	67.3	16	1473	-	117
16	2	84.1	16	1795	-	202
17	1	80.9	16	-	-	135
18	1	74.6	16	-	-	396
19	2	97.6	16	1805	-	615
Detection Check (1=Detection; 0=No Detection)						1



Trial Number							13
Number of Bursts in Trial							20
Chirp Center Frequency							5498
Burst	No. of Pulses	Pulse Width (us)	Chirp Width (MHz)	Pulse 1-to-2 Spacing (us)	Pulse 2-to-3 Spacing (us)	Starting Location Within Interval (ms)	
1	2	66.1	17	1417	-	388	
2	2	86.7	17	1693	-	348	
3	2	70.5	17	1263	-	215	
4	2	78	17	1446	-	28	
5	2	66	17	1185	-	585	
6	2	80.6	17	1855	-	65	
7	1	95.5	17	-	-	92	
8	1	98.8	17	-	-	68	
9	3	64.3	17	1641	1108	517	
10	1	75.1	17	-	-	121	
11	2	72.6	17	1499	-	448	
12	1	60.3	17	-	-	567	
13	2	54.9	17	1056	-	245	
14	2	98.8	17	1023	-	584	
15	2	60.9	17	1243	-	579	
16	2	62.7	17	1226	-	464	
17	1	80.1	17	-	-	89	
18	2	70.9	17	1711	-	153	
19	1	90.7	17	-	-	282	
20	1	98.9	17	-	-	71	
Detection Check (1=Detection; 0=No Detection)							1

Trial Number							14
Number of Bursts in Trial							8
Chirp Center Frequency							5499
Burst	No. of Pulses	Pulse Width (us)	Chirp Width (MHz)	Pulse 1-to-2 Spacing (us)	Pulse 2-to-3 Spacing (us)	Starting Location Within Interval (ms)	
1	2	67.5	20	1542	-	947	
2	3	83.6	20	1272	1696	124	
3	2	93.2	20	1877	-	701	
4	1	55.6	20	-	-	1123	
5	3	84.2	20	1733	1619	756	
6	3	69.1	20	1612	1071	1	
7	2	66.9	20	1905	-	7	
8	3	86.8	20	1697	1621	1082	
Detection Check (1=Detection; 0=No Detection)							1



Trial Number							15
Number of Bursts in Trial							9
Chirp Center Frequency							5499
Burst	No. of Pulses	Pulse Width (us)	Chirp Width (MHz)	Pulse 1-to-2 Spacing (us)	Pulse 2-to-3 Spacing (us)	Starting Location Within Interval (ms)	
1	2	62.2	19	1571	-	949	
2	2	85	19	1669	-	189	
3	2	64.5	19	1505	-	176	
4	2	50.4	19	1325	-	538	
5	2	66.1	19	1483	-	908	
6	2	71.2	19	1110	-	1017	
7	3	53.7	19	1445	1677	492	
8	3	62.5	19	1596	1341	349	
9	3	62	19	1929	1221	1105	
Detection Check (1=Detection; 0=No Detection)							1

Trial Number							16
Number of Bursts in Trial							10
Chirp Center Frequency							5498
Burst	No. of Pulses	Pulse Width (us)	Chirp Width (MHz)	Pulse 1-to-2 Spacing (us)	Pulse 2-to-3 Spacing (us)	Starting Location Within Interval (ms)	
1	2	80.5	18	1910	-	284	
2	2	64.2	18	1661	-	751	
3	2	90.1	18	1041	-	491	
4	2	69.8	18	1495	-	107	
5	1	73.1	18	-	-	490	
6	3	77.2	18	1418	1145	1155	
7	3	52.6	18	1732	1787	772	
8	2	71.4	18	1562	-	121	
9	2	89.8	18	1491	-	89	
10	2	76.4	18	1355	-	615	
Detection Check (1=Detection; 0=No Detection)							1



Trial Number							17
Number of Bursts in Trial							11
Chirp Center Frequency							5498
Burst	No. of Pulses	Pulse Width (us)	Chirp Width (MHz)	Pulse 1-to-2 Spacing (us)	Pulse 2-to-3 Spacing (us)	Starting Location Within Interval (ms)	
1	2	51.2	17	1236	-	740	
2	1	71.7	17	-	-	941	
3	2	74.7	17	1164	-	370	
4	2	50.9	17	1919	-	371	
5	2	65.2	17	1206	-	1033	
6	2	98	17	1182	-	346	
7	2	58.7	17	1612	-	639	
8	1	63.8	17	-	-	1056	
9	3	86.3	17	1545	1065	205	
10	1	94.4	17	-	-	753	
11	3	88.5	17	1699	1319	58	
Detection Check (1=Detection; 0=No Detection)							1

Trial Number							18
Number of Bursts in Trial							12
Chirp Center Frequency							5497
Burst	No. of Pulses	Pulse Width (us)	Chirp Width (MHz)	Pulse 1-to-2 Spacing (us)	Pulse 2-to-3 Spacing (us)	Starting Location Within Interval (ms)	
1	2	88.7	16	1405	-	448	
2	3	90.2	16	1544	1235	621	
3	1	96.5	16	-	-	512	
4	2	80.5	16	1090	-	321	
5	2	63.7	16	1268	-	798	
6	1	53.4	16	-	-	809	
7	2	52.3	16	1043	-	301	
8	3	54.7	16	1701	1104	796	
9	3	75.6	16	1923	1729	669	
10	2	59.2	16	1244	-	369	
11	1	56.3	16	-	-	51	
12	2	87.8	16	1608	-	733	
Detection Check (1=Detection; 0=No Detection)							1



Trial Number							19
Number of Bursts in Trial							13
Chirp Center Frequency							5497
Burst	No. of Pulses	Pulse Width (us)	Chirp Width (MHz)	Pulse 1-to-2 Spacing (us)	Pulse 2-to-3 Spacing (us)	Starting Location Within Interval (ms)	
1	2	68.2	15	1104	-	229	
2	2	58.4	15	1627	-	488	
3	3	74.7	15	1861	1015	137	
4	2	58.2	15	1593	-	520	
5	1	51.6	15	-	-	799	
6	2	94.7	15	1469	-	43	
7	2	70.7	15	1091	-	126	
8	2	82.9	15	1472	-	607	
9	3	62.7	15	1168	1453	527	
10	2	63.1	15	1529	-	143	
11	1	96.1	15	-	-	176	
12	2	57	15	1457	-	882	
13	3	95.6	15	1707	1501	214	
Detection Check (1=Detection; 0=No Detection)							1

Trial Number							20
Number of Bursts in Trial							14
Chirp Center Frequency							5497
Burst	No. of Pulses	Pulse Width (us)	Chirp Width (MHz)	Pulse 1-to-2 Spacing (us)	Pulse 2-to-3 Spacing (us)	Starting Location Within Interval (ms)	
1	1	95.7	14	-	-	117	
2	1	93.1	14	-	-	720	
3	1	55.8	14	-	-	297	
4	1	76.7	14	-	-	284	
5	2	68	14	1686	-	472	
6	3	94.1	14	1796	1393	264	
7	2	53.9	14	1293	-	525	
8	1	99.3	14	-	-	155	
9	2	73.3	14	1458	-	65	
10	2	93.3	14	1196	-	451	
11	3	55.8	14	1895	1034	243	
12	1	66.4	14	-	-	228	
13	2	65.6	14	1732	-	746	
14	2	76.5	14	1187	-	522	
Detection Check (1=Detection; 0=No Detection)							1



Trial Number							21
Number of Bursts in Trial							15
Chirp Center Frequency							5644
Burst	No. of Pulses	Pulse Width (us)	Chirp Width (MHz)	Pulse 1-to-2 Spacing (us)	Pulse 2-to-3 Spacing (us)	Starting Location Within Interval (ms)	
1	1	85.1	13	-	-	565	
2	2	72.5	13	1648	-	211	
3	1	67.5	13	-	-	348	
4	2	56.1	13	1360	-	156	
5	1	71.1	13	-	-	718	
6	2	93.1	13	1391	-	400	
7	1	56.5	13	-	-	482	
8	1	63.8	13	-	-	703	
9	2	67.4	13	1727	-	780	
10	1	52.3	13	-	-	102	
11	3	62.4	13	1228	1715	304	
12	2	53.3	13	1630	-	57	
13	2	83.1	13	1205	-	768	
14	2	93.7	13	1085	-	461	
15	2	90.7	13	1297	-	746	
Detection Check (1=Detection; 0=No Detection)							0

Trial Number							22
Number of Bursts in Trial							16
Chirp Center Frequency							5644
Burst	No. of Pulses	Pulse Width (us)	Chirp Width (MHz)	Pulse 1-to-2 Spacing (us)	Pulse 2-to-3 Spacing (us)	Starting Location Within Interval (ms)	
1	2	98.8	12	1439	-	95	
2	1	54.5	12	-	-	676	
3	2	80.5	12	1360	-	8	
4	2	55.9	12	1906	-	373	
5	2	72.1	12	1623	-	254	
6	2	84.4	12	1604	-	480	
7	1	78.5	12	-	-	663	
8	1	88	12	-	-	314	
9	2	74.7	12	1157	-	596	
10	2	97.1	12	1673	-	264	
11	1	81.6	12	-	-	740	
12	1	83.6	12	-	-	163	
13	3	87.6	12	1757	1322	628	
14	2	58.5	12	1372	-	132	
15	3	91.8	12	1767	1183	106	
16	2	58.8	12	1432	-	659	
Detection Check (1=Detection; 0=No Detection)							1



Trial Number			23			
Number of Bursts in Trial			17			
Chirp Center Frequency			5645			
Burst	No. of Pulses	Pulse Width (us)	Chirp Width (MHz)	Pulse 1-to-2 Spacing (us)	Pulse 2-to-3 Spacing (us)	Starting Location Within Interval (ms)
1	1	96	11	-	-	284
2	2	92.5	11	1241	-	488
3	2	89.5	11	1347	-	76
4	2	74.8	11	1607	-	688
5	2	60.6	11	1523	-	28
6	2	71.5	11	1659	-	383
7	2	71.1	11	1454	-	182
8	1	98.7	11	-	-	20
9	2	85.1	11	1770	-	576
10	2	89.2	11	1086	-	410
11	2	60.7	11	1101	-	458
12	2	75.2	11	1719	-	348
13	2	75.7	11	1799	-	481
14	3	56.7	11	1132	1884	587
15	2	65	11	1885	-	480
16	2	64.6	11	1910	-	195
17	3	69.9	11	1410	1190	396
Detection Check (1=Detection; 0=No Detection)						0



Trial Number			24			
Number of Bursts in Trial			18			
Chirp Center Frequency			5645			
Burst	No. of Pulses	Pulse Width (us)	Chirp Width (MHz)	Pulse 1-to-2 Spacing (us)	Pulse 2-to-3 Spacing (us)	Starting Location Within Interval (ms)
1	3	83.8	10	1290	1021	536
2	2	66.9	10	1112	-	44
3	3	91	10	1220	1504	611
4	2	86.1	10	1678	-	456
5	3	65.5	10	1928	1222	330
6	1	62.6	10	-	-	297
7	3	68.7	10	1505	1200	351
8	3	59.2	10	1452	1114	230
9	1	73.9	10	-	-	222
10	1	77.2	10	-	-	57
11	2	96.4	10	1357	-	399
12	2	99.9	10	1173	-	299
13	2	99.9	10	1520	-	464
14	1	86.7	10	-	-	294
15	1	92.6	10	-	-	653
16	1	77.1	10	-	-	550
17	2	81.1	10	1664	-	566
18	3	68.4	10	1536	1309	580
Detection Check (1=Detection; 0=No Detection)						1



Trial Number			25			
Number of Bursts in Trial			19			
Chirp Center Frequency			5645			
Burst	No. of Pulses	Pulse Width (us)	Chirp Width (MHz)	Pulse 1-to-2 Spacing (us)	Pulse 2-to-3 Spacing (us)	Starting Location Within Interval (ms)
1	3	68.2	9	1723	1868	471
2	3	83.7	9	1711	1405	368
3	2	69.7	9	1781	-	425
4	1	59.7	9	-	-	440
5	2	96.7	9	1484	-	123
6	2	95.8	9	1319	-	261
7	3	71.3	9	1095	1354	332
8	3	53.2	9	1527	1427	427
9	2	69.5	9	1771	-	397
10	3	63.9	9	1075	1447	67
11	2	93.4	9	1783	-	174
12	2	77.3	9	1564	-	17
13	2	73.1	9	1294	-	216
14	1	77.4	9	-	-	292
15	3	57.2	9	1722	1886	619
16	2	68.7	9	1629	-	233
17	1	60.8	9	-	-	226
18	3	69.7	9	1128	1224	599
19	1	62.2	9	-	-	433
Detection Check (1=Detection; 0=No Detection)						1



Trial Number							26
Number of Bursts in Trial							20
Chirp Center Frequency							5646
Burst	No. of Pulses	Pulse Width (us)	Chirp Width (MHz)	Pulse 1-to-2 Spacing (us)	Pulse 2-to-3 Spacing (us)	Starting Location Within Interval (ms)	
1	1	80.5	8	-	-	90	
2	3	62.6	8	1406	1343	319	
3	3	85.6	8	1190	1529	384	
4	2	83.9	8	1208	-	567	
5	2	92.4	8	1488	-	234	
6	2	54	8	1529	-	535	
7	3	81.3	8	1501	1812	325	
8	1	98.5	8	-	-	532	
9	1	85.8	8	-	-	272	
10	2	84.7	8	1593	-	182	
11	2	83.3	8	1705	-	134	
12	2	79.8	8	1567	-	286	
13	1	77.9	8	-	-	368	
14	3	98.4	8	1510	1569	290	
15	2	79.9	8	1588	-	231	
16	3	78	8	1140	1353	353	
17	3	55.2	8	1700	1327	53	
18	3	71.9	8	1081	1224	44	
19	1	62	8	-	-	298	
20	3	70.5	8	1888	1442	529	
Detection Check (1=Detection; 0=No Detection)							1

Trial Number							27
Number of Bursts in Trial							8
Chirp Center Frequency							5642
Burst	No. of Pulses	Pulse Width (us)	Chirp Width (MHz)	Pulse 1-to-2 Spacing (us)	Pulse 2-to-3 Spacing (us)	Starting Location Within Interval (ms)	
1	2	69.1	18	1076	-	1436	
2	2	62.1	18	1688	-	22	
3	2	94.8	18	1891	-	897	
4	1	75.8	18	-	-	1186	
5	2	65.4	18	1713	-	589	
6	2	97.7	18	1292	-	614	
7	3	98.1	18	1670	1711	506	
8	2	85.4	18	1672	-	776	
Detection Check (1=Detection; 0=No Detection)							1



Trial Number							28
Number of Bursts in Trial							9
Chirp Center Frequency							5641
Burst	No. of Pulses	Pulse Width (us)	Chirp Width (MHz)	Pulse 1-to-2 Spacing (us)	Pulse 2-to-3 Spacing (us)	Starting Location Within Interval (ms)	
1	3	82	19	1233	1713	679	
2	3	87.7	19	1554	1123	473	
3	2	98.9	19	1518	-	869	
4	1	55	19	-	-	719	
5	1	93.6	19	-	-	902	
6	2	58.7	19	1641	-	1243	
7	2	88.7	19	1387	-	410	
8	1	60.3	19	-	-	1154	
9	1	97.7	19	-	-	512	
Detection Check (1=Detection; 0=No Detection)							0

Trial Number							29
Number of Bursts in Trial							10
Chirp Center Frequency							5641
Burst	No. of Pulses	Pulse Width (us)	Chirp Width (MHz)	Pulse 1-to-2 Spacing (us)	Pulse 2-to-3 Spacing (us)	Starting Location Within Interval (ms)	
1	1	69.6	20	-	-	1131	
2	1	74.5	20	-	-	290	
3	1	60.9	20	-	-	895	
4	1	74.6	20	-	-	202	
5	2	99.3	20	1501	-	139	
6	2	95.3	20	1065	-	854	
7	2	91.9	20	1722	-	219	
8	2	51	20	1285	-	57	
9	2	87.7	20	1747	-	141	
10	1	87.2	20	-	-	596	
Detection Check (1=Detection; 0=No Detection)							0



Trial Number		30				
Number of Bursts in Trial		11				
Chirp Center Frequency		5647				
Burst	No. of Pulses	Pulse Width (us)	Chirp Width (MHz)	Pulse 1-to-2 Spacing (us)	Pulse 2-to-3 Spacing (us)	Starting Location Within Interval (ms)
1	3	59.9	5	1901	1196	935
2	2	77.1	5	1590	-	1038
3	2	62.7	5	1227	-	690
4	1	77.1	5	-	-	547
5	3	99.8	5	1798	1790	551
6	2	61.5	5	1135	-	876
7	2	77.5	5	1583	-	448
8	2	57.3	5	1890	-	736
9	2	53.5	5	1757	-	362
10	1	66.6	5	-	-	836
11	3	80.7	5	1811	1289	410
Detection Check (1=Detection; 0=No Detection)						1



Type 6 Radar Statistical Performance

Trial #	Test Freq. (MHz)	Pulses / Hop	Pulse Width (us)	PRI (us)	1=Detection 0=No Detection
1	5570	9	1	333	1
2	5570	9	1	333	1
3	5570	9	1	333	1
4	5570	9	1	333	1
5	5570	9	1	333	1
6	5570	9	1	333	1
7	5570	9	1	333	1
8	5570	9	1	333	1
9	5570	9	1	333	1
10	5570	9	1	333	1
11	5570	9	1	333	1
12	5570	9	1	333	1
13	5570	9	1	333	1
14	5570	9	1	333	1
15	5570	9	1	333	1
16	5570	9	1	333	1
17	5570	9	1	333	1
18	5570	9	1	333	1
19	5570	9	1	333	1
20	5570	9	1	333	1
21	5570	9	1	333	0
22	5570	9	1	333	1
23	5570	9	1	333	1
24	5570	9	1	333	1
25	5570	9	1	333	1
26	5570	9	1	333	1
27	5570	9	1	333	1
28	5570	9	1	333	1
29	5570	9	1	333	1
30	5570	9	1	333	1
Detection Percentage (%)					96.667
Limit					70%
Test Result					Complied



4 Test Equipment and Calibration Data

Instrument	Manufacturer	Model No.	Serial No.	Characteristics	Calibration Date	Calibration Due Date	Remark
Spectrum Analyzer	R&S	FSV40	101026	9kHz~40GHz	Sep. 28, 2018	Sep. 27, 2019	Radiated (DF01-CB)
Vector Signal generator	R&S	SMU200A	102782	100kHz-6GHz	Jan. 16, 2019	Jan. 15, 2020	Radiated (DF01-CB)
Horn Antenna	SCHWARZBECK	BBHA 9120 D	BBHA 9120 D 1370	1GHz~18GHz	Jun. 03, 2019	Jun. 02, 2020	Radiated (DF01-CB)
Horn Antenna	COM-POWER	AH-118	071042	1GHz – 18GHz	Dec. 24, 2018	Dec. 23, 2019	Radiated (DF01-CB)
RF Power Divider	ANAREN	2 Way	DFS-01-DV-02	1GHz ~ 6GHz	Oct. 08, 2018	Oct. 07, 2019	Radiated (DF01-CB)
RF Power Divider	MTJ	2 Way	DFS-01-DV-03	1GHz ~ 6GHz	Oct. 08, 2018	Oct. 07, 2019	Radiated (DF01-CB)
RF Power Divider	ANAREN	4 Way	DFS-01-DV-01	1GHz ~ 6GHz	Oct. 08, 2018	Oct. 07, 2019	Radiated (DF01-CB)
RF Cable-high	Woken	RG402	High Cable-57	1 GHz –18 GHz	Oct. 08, 2018	Oct. 07, 2019	Radiated (DF01-CB)
RF Cable-high	Woken	RG402	High Cable-58	1 GHz –18 GHz	Oct. 08, 2018	Oct. 07, 2019	Radiated (DF01-CB)
Wireless Connectivity Tester	R&S	CMW270	100854	N/A	Nov. 18, 2018	Nov. 19, 2019	Radiated (DF01-CB)

Note: Calibration Interval of instruments listed above is one year.



5 Measurement Uncertainty

Test Items	Uncertainty	Remark
Radiated Emission	3.4 dB	Confidence levels of 95%

Appendix A. Dynamic In-Service Monitoring Test (Zero-Wait CAC)

1. Dynamic In-Service Monitoring (Zero-Wait CAC)

1.1. Measuring Instruments

Refer a test equipment and calibration data table in this test report.

1.2. Test Procedure

Pre-clearing a DFS channel for zero time switching from a non-DFS channel

Before the operation channel moves from non-DFS channels to DFS channels for zero time switching, one minute CAC should be performed on the targeted switching channel to make sure no radar presence. When CAC completed with no radar presence, channel move to targeted channel immediately. If radar detected at any time during CAC, EUT stays on the original non-DFS channel.

1.3. Test Setup

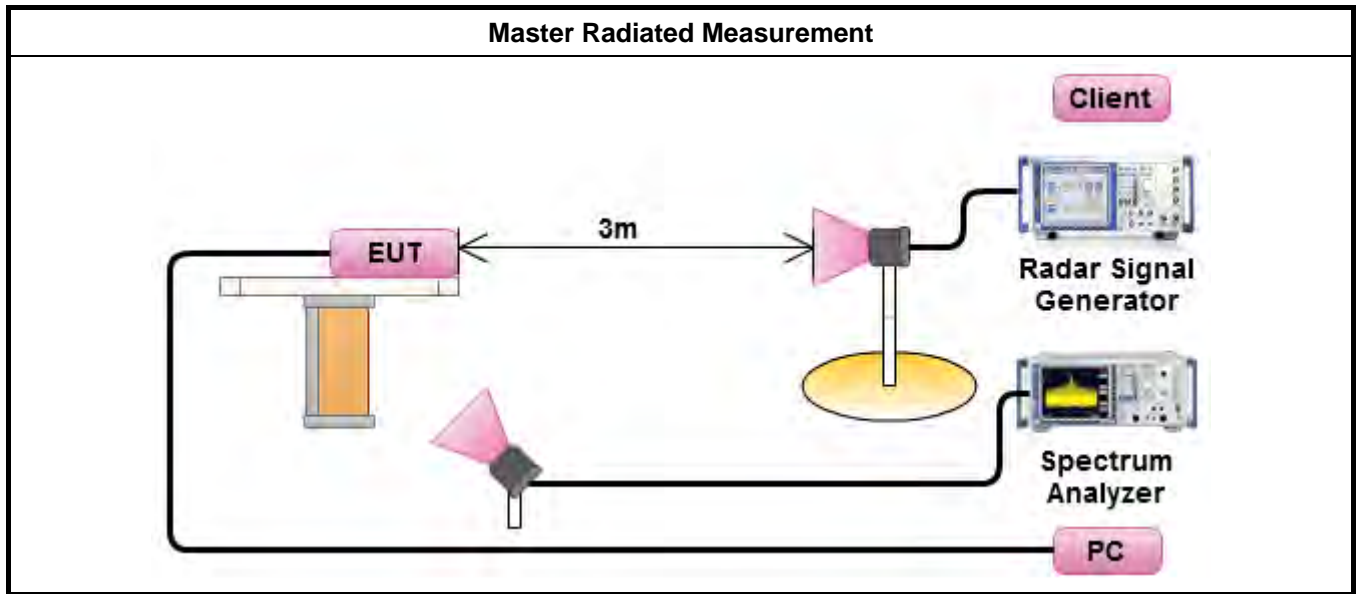

Test Channel Frequencies Configuration

IEEE Std.	Test Channel Freq. (MHz)
802.11ac (VHT80)	5530 MHz

1.4. Test Result of Dynamic In-Service Monitoring

Dynamic In-Service Monitoring Test Result						
Detection Threshold Level (dBm)			-63			
Modulation Mode	Operation Freq.(MHz)	Targeted Channel Freq.(MHz)	Radar Test Signal (#)	Nr of Times Triggered (# out of 20)	Detection Probability (%)	Detection Probability Limit (%)
802.11ac (VHT80)	5690	5530	0	19	95%	60

Initial CAC – Zero Wait		
Modulation Mode	Zero-Wait Freq.	Radar Type
802.11ac (VHT80)	5530 MHz	0

The EUT does not transmit any beacon or data transmissions until at least 1 minute after the completion of the power-on cycle (0.435 sec). The initial CAC time of the EUT is indicated by marker 1 (0.435 sec). Initial beacons/data transmissions are indicated by marker 2 (60.435 sec).

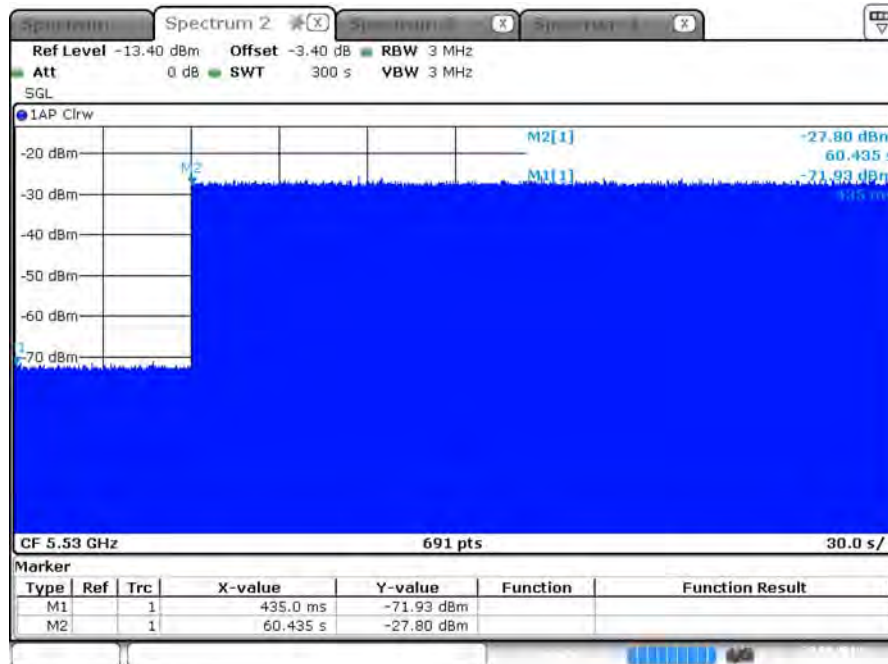

Date: 23 AUG 2019 17:32:48

Begin CAC – Zero Wait

Modulation Mode	Zero-Wait Freq.	Radar Type
802.11ac (VHT80)	5530 MHz	0

Visual indication on the EUT of successful detection of the radar Burst will be recorded and reported. Observation of emissions will continue for 298.261 seconds after the radar Burst has been generated. Verify that during the 300 seconds measurement window no EUT transmissions occurred.

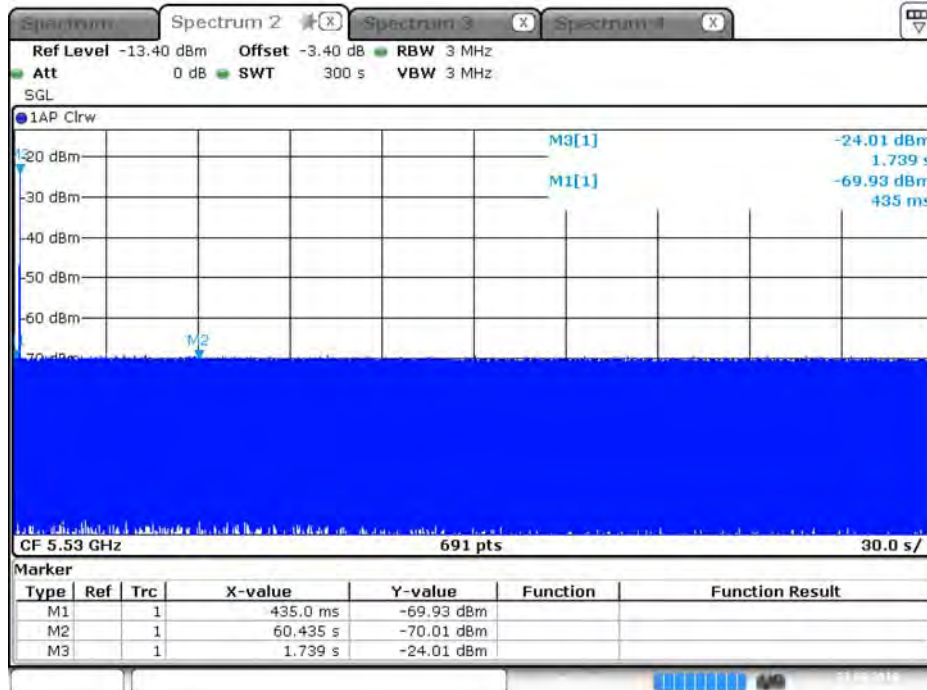

Date: 23.AUG.2019 17:50:07

End CAC – Zero Wait

Modulation Mode	Zero-Wait Freq.	Radar Type
802.11ac (VHT80)	5530 MHz	0

Visual indication on the EUT of successful detection of the radar Burst will be recorded and reported. Observation of emissions will continue for 242.609 seconds after the radar Burst has been generated. Verify that during the 300 seconds measurement window no EUT transmissions occurred.

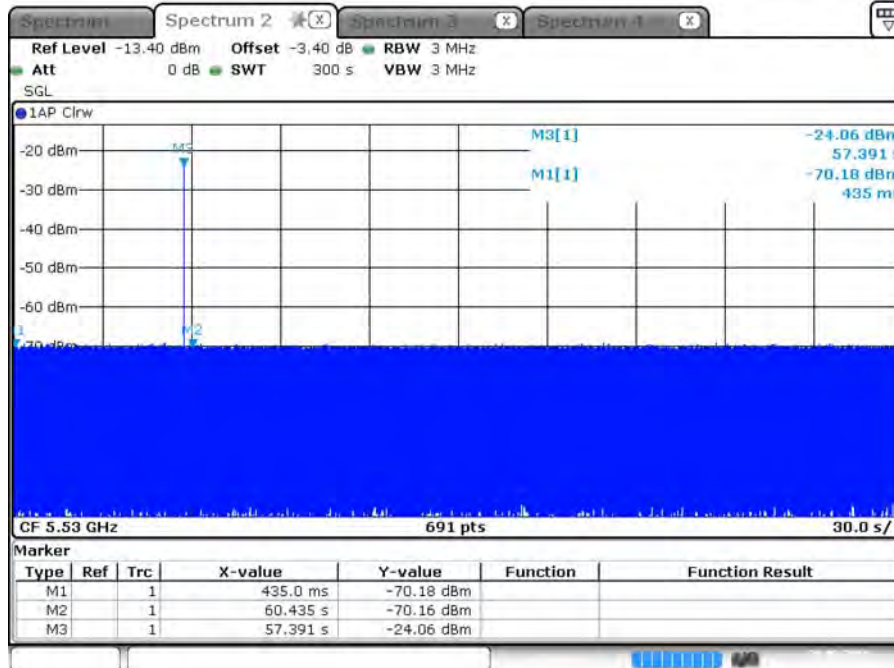

Date: 23.AUG.2019 18:02:44