



Test Report No:
2430203R-RFUSV09S-A

TEST REPORT

FCC Rules&Regulations

Product Name	Gaming Headset
Brand Name	ASUS
Model No.	A701
FCC ID	MSQ-A701
Applicant's Name / Address	ASUSTeK Computer Inc 1F, No. 15, Lide Rd, Beitou, Taipei, 112 Taiwan
Manufacturer's Name	ASUSTeK COMPUTER INC.
Test Method Requested, Standard	FCC CFR Title 47 Part 15 Subpart C Section 15.249 ANSI C63.10-2013
Verdict Summary	IN COMPLIANCE
Documented By Jinn Chen	<i>Jinn Chen</i>
Tested By Jason Tuan	<i>Jason Tuan</i>
Approved By Alan Chen	<i>Alan Chen</i>
Date of Receipt	2024/03/07
Date of Issue	2024/05/09
Report Version	V1.0

INDEX

	page
Competences and Guarantees.....	3
General Conditions.....	3
Revision History.....	4
Summary of Test Result.....	5
1. General Information.....	6
1.1. EUT Description.....	6
1.2. EUT Information.....	7
1.3. Testing Location Information.....	7
1.4. Measurement Uncertainty.....	7
1.5. List of Test Equipment.....	8
2. Test Configuration of EUT.....	9
2.1. Test Condition.....	9
2.2. Test Software.....	9
2.3. Duty Cycle.....	10
2.4. The Worst Case Measurement Configuration.....	11
2.5. Tested System Details.....	12
2.6. Configuration of tested System.....	12
2.7. EUT Operating Procedures.....	12
3. AC Power Line Conducted Emission.....	13
3.1. Test Setup.....	13
3.2. Test Limit.....	13
3.3. Test Procedure.....	13
3.4. Test Result of AC Power Line Conducted Emission.....	13
4. Field Strength of Fundamental.....	14
4.1. Test Setup.....	14
4.2. Test Limit.....	14
4.3. Test Procedures.....	15
4.4. Test Result of Field Strength of Fundamental.....	15
5. Radiated Emission.....	16
5.1. Test Setup.....	16
5.2. Test Limit.....	17
5.3. Test Procedure.....	17
5.4. Test Result of Radiated Emissions.....	17
Appendix A. Test Result of AC Power Line Conducted Emission	
Appendix B. Test Result of Field Strength of Fundamental	
Appendix C. Test Result of Radiated Emissions	
Appendix D. Test Setup Photograph	

Competences and Guarantees

DEKRA is a testing laboratory competent to carry out the tests described in this report.

In order to assure the traceability to other national and international laboratories, DEKRA has a calibration and maintenance program for its measurement equipment.

DEKRA guarantees the reliability of the data presented in this report, which is the result of the measurements and the tests performed to the item under test on the date and under the conditions stated in the report and it is based on the knowledge and technical facilities available at DEKRA at the time of performance of the test.

DEKRA is liable to the client for the maintenance of the confidentiality of all information related to the item under test and the results of the test.

The results presented in this Test Report apply only to the particular item under test established in this document.

IMPORTANT: No parts of this report may be reproduced or quoted out of context, in any form or by any means, except in full, without the previous written permission of DEKRA.

General Conditions

1. The test results relate only to the samples tested.
2. The test results shown in the test report are traceable to the national/international standard through the calibration report of the equipment and evaluated measurement uncertainty herein.
3. This report must not be used to claim product endorsement by TAF or any agency of the government.
4. The test report shall not be reproduced without the written approval of DEKRA Testing and Certification Co., Ltd.
5. Measurement uncertainties evaluated for each testing system and associated connections are given here to provide the system information for reference. Compliance determinations do not take into account measurement uncertainties for each testing system, but are based on the results of the compliance measurement.

Revision History

Version	Description	Issued Date
V1.0	Initial issue of report	2024/05/09

Summary of Test Result

Report Clause	Test Items	Result (PASS/FAIL)	Remark
3	AC Power Line Conducted Emission	PASS	-
4	Field Strength of Fundamental	PASS	-
5	Radiated Emission	PASS	-

Comments and Explanations

The declared of product specification for EUT presented in the report are provided by the manufacturer, and the manufacturer takes all the responsibilities for the accuracy of product specification.

1. General Information

1.1. EUT Description

Frequency Range	2400 ~ 2483.5 MHz
Operation Frequency	2402 ~ 2480 MHz
Channel Number	40 Channels
Mode	2.4 GHz Wireless
Type of Modulation	GFSK

Accessories Information			
No.	Equipment Name	Brand Name	Model No.
1	Microphone	ASUS	A701
2	Audio Cable	ASUS	A701
3	USB Type C to Type A Adapter	ASUS	A701
4	USB Type C to Type A Cable	ASUS	A701
5	Gaming Headset Wireless Receiver	ASUS	A701Dongle

Antenna Information				
Item.	Brand Name	Model No.	Type	Antenna Gain (dBi)
1	Cicent	102BK3E1440	PIFA	2.1

Note:

1. The above EUT information is declared by the manufacturer.
2. The antenna of EUT conforms to FCC 15.203.

Working Frequency of Each Channel							
Channel	Frequency (MHz)	Channel	Frequency (MHz)	Channel	Frequency (MHz)	Channel	Frequency (MHz)
00	2402	01	2404	02	2406	03	2408
04	2410	05	2412	06	2414	07	2416
08	2418	09	2420	10	2422	11	2424
12	2426	13	2428	14	2430	15	2432
16	2434	17	2436	18	2438	19	2440
20	2442	21	2444	22	2446	23	2448
24	2450	25	2452	26	2454	27	2456
28	2458	29	2460	30	2462	31	2464
32	2466	33	2468	34	2470	35	2472
36	2474	37	2476	38	2478	39	2480

1.2. EUT Information

EUT Power Type	From DC 3.7V by Battery / DC 5V by USB
----------------	--

1.3. Testing Location Information

USA	FCC Registration Number: TW0033
Canada	CAB Identifier Number: TW3023 / Company Number: 26930

Site Description	Accredited by TAF
	Accredited Number: 3023

Test Laboratory	DEKRA Testing and Certification Co., Ltd.
	Linkou Laboratory
Address	No.5-22, Ruishukeng Linkou District, New Taipei City, 24451, Taiwan, R.O.C.
Performed Location	No. 26, Huaya 1st Rd., Guishan Dist., Taoyuan City 333411, Taiwan, R.O.C.
Phone Number	+886-3-275-7255
Fax Number	+886-3-327-8031

Ambient conditions in the laboratory:

Performed Item	Items	Required	Actual	Test Date
AC Power Line Conducted Emission	Temperature (°C)	10~40 °C	23.8 °C	2024/04/11
	Humidity (%RH)	10~90 %	61.4 %	
Radiated Emission	Temperature (°C)	10~40 °C	22.6 °C	2024/03/20-2024/03/22
	Humidity (%RH)	10~90 %	60.8 %	

1.4. Measurement Uncertainty

Uncertainties have been calculated according to the DEKRA internal document with the emissions test results be included in the report. The measurement uncertainties given below are based on a 95% confidence level (based on a coverage factor (k=2)).

Test item	Uncertainty
AC Power Line Conducted Emission	±3.50 dB
Field Strength of Fundamental	9 kHz~30 MHz: ±3.88 dB 30 MHz~1 GHz: ±4.42 dB 1 GHz~18 GHz: ±4.28 dB 18 GHz~40 GHz: ±3.90 dB
Radiated Emission	9 kHz~30 MHz: ±3.88 dB 30 MHz~1 GHz: ±4.42 dB 1 GHz~18 GHz: ±4.28 dB 18 GHz~40 GHz: ±3.90 dB

1.5. List of Test Equipment

For Conduction Measurements / HY-SR01

	Equipment	Manufacturer	Model No.	Serial No.	Cal. Date	Due Date
V	EMI Test Receiver	R&S	ESR7	101601	2023/06/20	2024/06/19
V	Two-Line V-Network	R&S	ENV216	101478	2023/09/13	2024/09/12
V	Two-Line V-Network	R&S	ENV216	101307	2023/08/17	2024/08/16
V	Coaxial Cable	SUHNER	RG400_BNC	RF001	2024/01/10	2025/01/09

Note:

1. All equipments are calibrated every one year.
2. The test instruments marked with "V" are used to measure the final test results.
3. Test Software Version: e3 230303 dekra V9.

For Radiated Measurements /HY-CB02

	Equipment	Manufacturer	Model No.	Serial No.	Cal. Date	Due Date
V	Loop Antenna	AMETEK	HLA6121	56736	2023/05/23	2024/05/22
V	Bi-Log Antenna	SCHWARZBECK	VULB9168	9168-0675	2023/08/09	2025/08/08
V	Horn Antenna	RF SPIN	DRH18-E	210503A18ES	2024/02/29	2025/02/28
V	Horn Antenna	Com-Power	AH-840	101100	2023/10/02	2025/10/01
V	Pre-Amplifier	SGH	SGH0301-9	20211007-8	2024/01/10	2025/01/09
V	Pre-Amplifier	SGH	SGH118-HS	20211102-1	2024/01/10	2025/01/09
V	Pre-Amplifier	EMCI	EMC05820SE	980285	2024/01/10	2025/01/09
V	Pre-Amplifier	EMCI	EMC184045SE	980369	2024/01/10	2025/01/09
V	Coaxial Cable	EMCI	EMC102-KM-KM-600	1160314	2024/01/10	2025/01/09
V	Coaxial Cable	EMCI	EMC102-KM-KM-7000	170242	2024/01/10	2025/01/09
V	Filter	MICRO TRONICS	BRM50702	G249	2024/01/05	2025/01/04
V	Filter	MICRO TRONICS	BRM50716	G067	2024/01/05	2025/01/04
V	EMI Test Receiver	R&S	ESR3	102793	2023/12/11	2024/12/10
V	Spectrum Analyzer	R&S	FSV3044	101113	2024/02/05	2025/02/04
V	Coaxial Cable	SGH	HA800	GD20110223-2	2024/01/10	2025/01/09
V	Coaxial Cable	SGH	HA800	GD20110222-4	2024/01/10	2025/01/09
V	Coaxial Cable	SGH	SGH18	202108-5	2024/01/10	2025/01/09
V	Coaxial Cable	SGH	SGH18	202212-2	2023/11/27	2024/11/26

Note:

1. Bi-Log Antenna and Horn Antenna(AH-840) is calibrated every two years, the other equipments are calibrated every one year.
2. The test instruments marked with "V" are used to measure the final test results.
3. Test Software Version: e3 230303 dekra V9.

2. Test Configuration of EUT

2.1. Test Condition

EUT Operational Condition	
Testing Voltage	DC 5V By USB

2.2. Test Software

Test Software Version	Airoha Tool Kit (AB1565 68 Lab Test Tool) / Version 3.8.0.1
-----------------------	---

Modulation	Frequency (MHz)	Power Setting
2.4GHz Wireless	2402	56
	2440	55
	2480	55

2.3. Duty Cycle

Modulation	Time on of 100 ms (ms)	Duty Cycle (Ton/100 ms)	Duty Cycle Correction factor (dB)
2.4GHz Wireless	0.498	0.00498	-46.055

Note: Duty Cycle correction factor = 20 LOG(Duty Cycle).

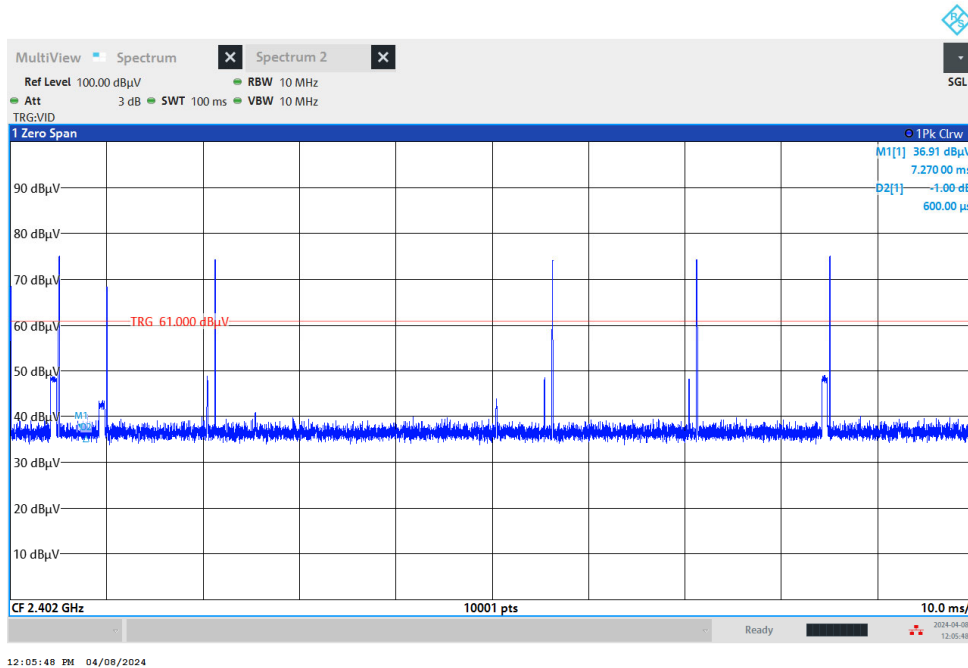
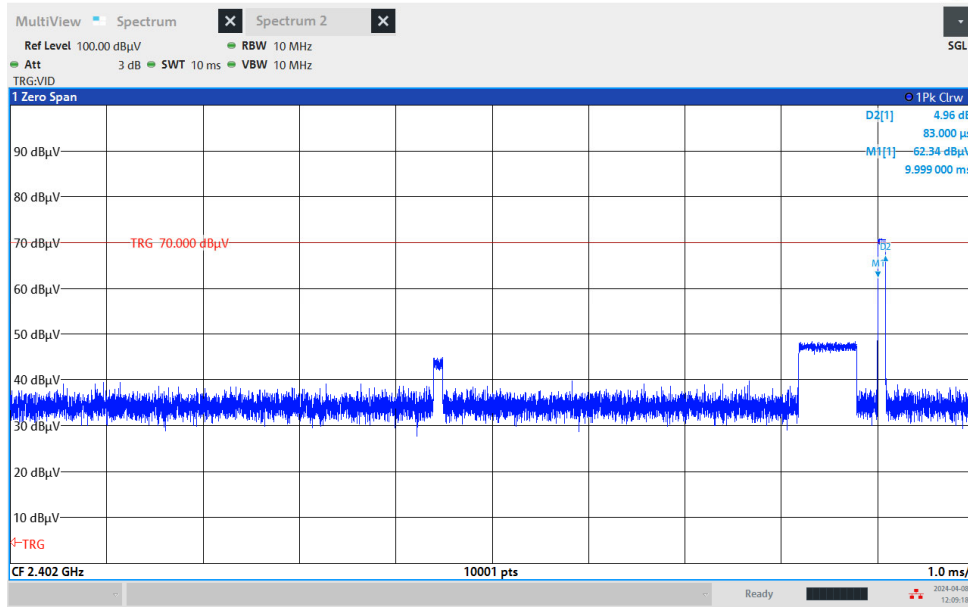

2.4. The Worst Case Measurement Configuration

Test Mode	Mode 1 (Transmit)	GFSK
-----------	-------------------	------

Note:

1. Determining compliance shall be based on the results of the compliance measurement, not taking into account measurement instrumentation uncertainty.
2. The radiation measurements are performed in X, Y, Z axis positioning. Only the worst case is shown in the report.

2.5. Tested System Details

No.	Equipment	Brand Name	Model No.	Serial No.	Power Cord
1	Notebook PC	Lenovo	TP00135A	RF-3ZD0E9	N/A
2	Test Fixture	Mercury Electronics	FT232RL USB To UART	N/A	N/A

2.6. Configuration of tested System

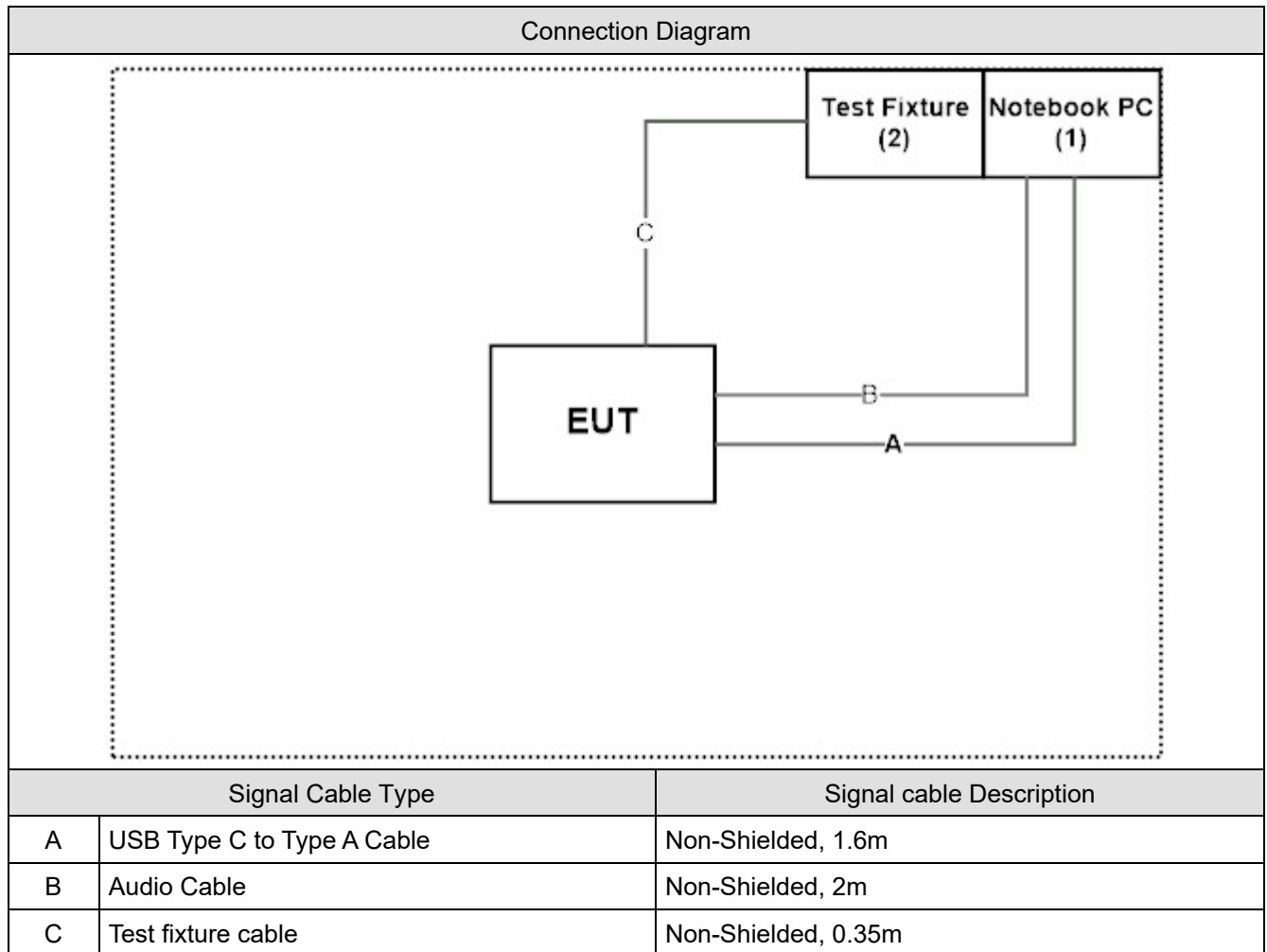

2.7. EUT Operating Procedures

1.	Setup the EUT as shown in Section 2.6.
2.	Execute software "Airoha Tool Kit (AB1565 68 Lab Test Tool) / Version 3.8.0.1" on the Notebook PC.
3.	Configure the test mode, the test channel, and the data rate.
4.	Press "OK" to start the continuous Transmit.
5.	Verify that the EUT works properly.

3. AC Power Line Conducted Emission

3.1. Test Setup

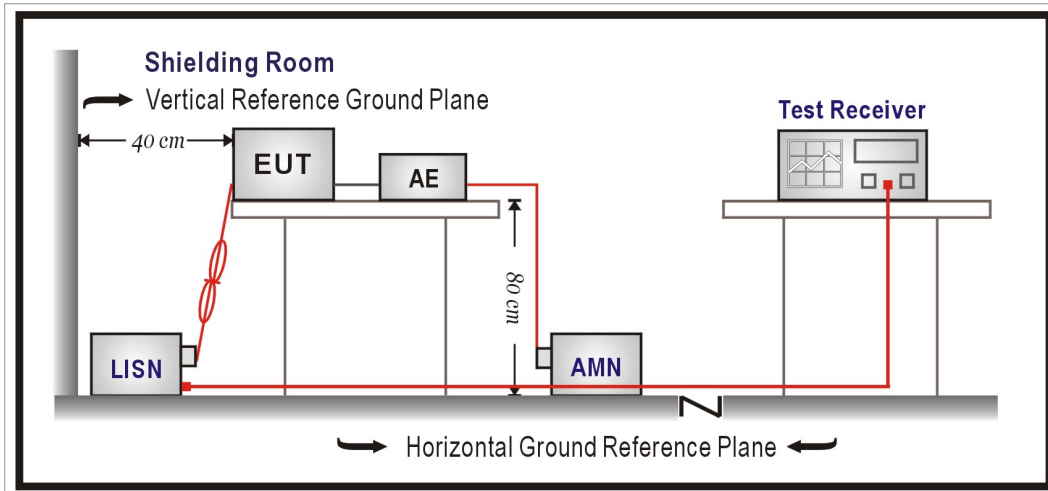

3.2. Test Limit

Frequency (MHz)	QP (dBuV)	AV (dBuV)
0.15 - 0.50	66 - 56	56 - 46
0.50 - 5.0	56	46
5.0 - 30	60	50

Remarks: In the above table, the tighter limit applies at the band edges.

3.3. Test Procedure

The EUT and simulators are connected to the main power through a line impedance stabilization network (L.I.S.N.). This provides a 50 ohm /50 uH coupling impedance for the measuring equipment. The peripheral devices are also connected to the main power through a LISN that provides a 50 ohm /50 uH coupling impedance with 50ohm termination. (Please refer to the block diagram of the test setup and photographs.) Both sides of A.C. line are checked for maximum conducted interference. In order to find the maximum emission, the relative positions of equipment and all of the interface cables must be changed according to ANSI C63.10: 2013 on conducted measurement.

Conducted emissions were investigated over the frequency range from 0.15 MHz to 30 MHz using a receiver bandwidth of 9 kHz.

3.4. Test Result of AC Power Line Conducted Emission

Refer as Appendix A

4. Field Strength of Fundamental

4.1. Test Setup

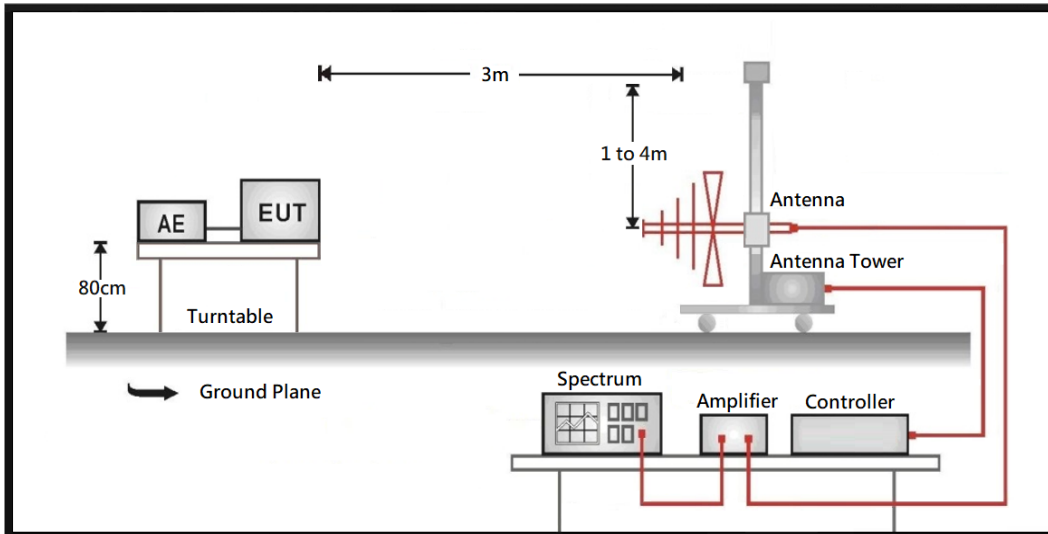

4.2. Test Limit

The field strength of emissions from intentional radiators operated within these frequency bands shall comply with the following:

Fundamental Frequency (MHz)	Field Strength of Fundamental (millivolts/meter)	Field Strength of Harmonics (microvolts/meter)
902 ~ 928	50	500
2400 ~ 2483.5	50	500
5725 ~ 5875	50	500
24000 ~ 24250	250	2500

Note :

1. The lower limit shall apply at the transition frequencies.
2. Emission level (dBuV/m) = 20 log Emission level (uV/m).
3. Emissions radiated outside of the specified frequency bands, except for harmonics, shall be attenuated by at least 50 dB below the level of the fundamental or to the general radiated emission limit in §15.209, whichever is the lesser attenuation.
4. For frequencies above 1000 MHz, the field strength limit are based on average detector, however, the peak field strength of any emission shall not exceed the maximum permitted average limit, specified above by more than 20 dB under any condition of modulation.

4.3. Test Procedures

The EUT and its simulators are placed on a turn table which is 0.8 meter above ground. The EUT was positioned such that the distance from antenna to the EUT was 3 meters. The turn table can rotate 360 degrees to determine the position of the maximum emission level. The antenna can move up and down between 1 meter and 4 meters to find out the maximum emission level.

Both horizontal and vertical polarization of the antenna are set on measurement. In order to find the maximum emission, all of the interface cables must be manipulated according to ANSI C63.10: 2013 on radiated measurement.

4.4. Test Result of Field Strength of Fundamental

Refer as Appendix B

5. Radiated Emission

5.1. Test Setup

9 kHz ~ 30 MHz

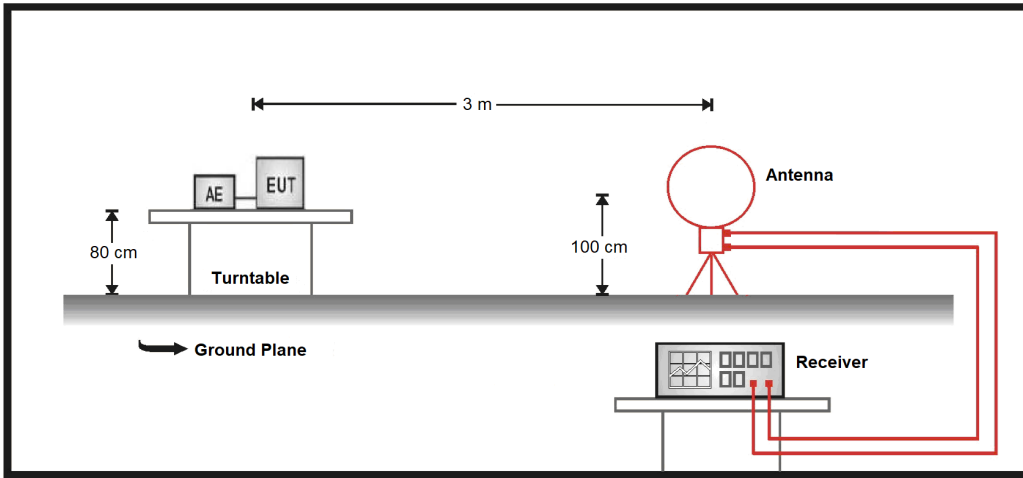

30 MHz ~ 1 GHz

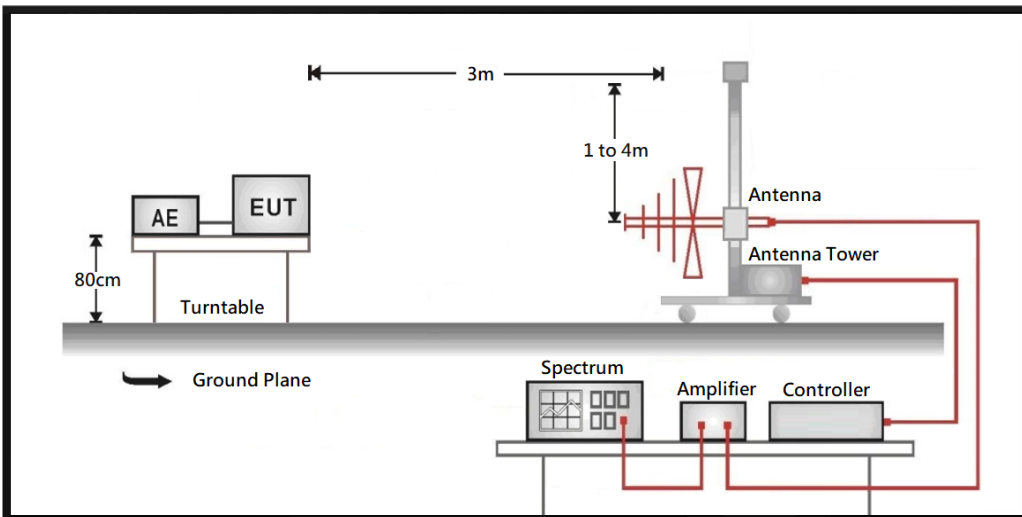

Above 1 GHz

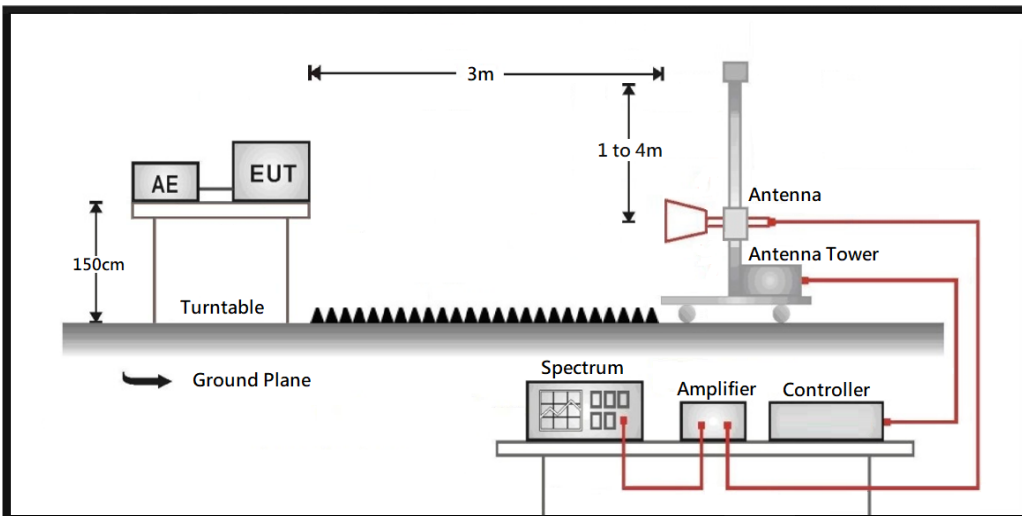

5.2. Test Limit

Frequency (MHz)	Field strength (uV/m)	Field strength (dBuV/m)	Measurement distance (m)
0.009 – 0.490	2400/F(kHz)	20 log (2400/F(kHz))	300
0.490 – 1.705	24000/F(kHz)	20 log (24000/F(kHz))	30
1.705 - 30	30	29.5	30
30 - 88	100	40	3
88 - 216	150	43.5	3
216 - 960	200	46	3
Above 960	500	54	3

Remarks:

1. Field strength (dBuV/m) = 20 log Field strength (uV/m)
2. In the Above Table, the tighter limit applies at the band edges.
3. Distance refers to the distance in meters between the measuring instrument antenna and the closed point of any part of the device or system

5.3. Test Procedure

The EUT was setup according to ANSI C63.10: 2013 for compliance to FCC 47CFR 15.249 requirements.

The EUT and its simulators are placed on a turn table which is 0.8 or 1.5 meter above ground. The turn table can rotate 360 degrees to determine the position of the maximum emission level. The antenna can move up and down between 1 meter and 4 meters to find out the maximum emission level.

Both horizontal and vertical polarization of the antenna are set on measurement. In order to find the maximum emission, all of the interface cables must be manipulated according to ANSI C63.10: 2013 on radiated measurement.

On any frequency or frequencies from 9kHz(include The the lowest oscillator frequency generated within the device up to the 10th harmonic) to 1000 MHz, the limit shown are based on measuring equipment employing a quasi-peak detector function and on any frequency or frequencies above 1000 MHz the radiated limit shown are based upon the use of measurement instrumentation employing an average detector function. When average radiated emission measurement are included emission measurement below 1000 MHz, there also is a limit on the radio frequency emissions, as measured using instrumentation with a peak detector function, corresponding to 20 dB above the maximum permitted average limit.

The bandwidth below 1 GHz setting on the field strength meter is 120 kHz and above 1 GHz is 1MHz.

5.4. Test Result of Radiated Emissions

Refer as Appendix C