



Test Report No:  
2430203R-RFUSV01S-B

## TEST REPORT FCC Rules&Regulations

Product Name	Gaming Headset
Brand Name	ASUS
Model No.	A701
FCC ID	MSQ-A701
Applicant's Name / Address	ASUSTeK Computer Inc 1F, No. 15, Lide Rd, Beitou, Taipei, 112 Taiwan
Manufacturer's Name	ASUSTeK COMPUTER INC.
Test Method Requested, Standard	FCC CFR Title 47 Part 15 Subpart C Section 15.247 ANSI C63.10-2013
Verdict Summary	IN COMPLIANCE
Documented By Jinn Chen	<i>Jinn Chen</i>
Tested By Jason Tuan	<i>Jason Tuan</i>
Approved By Alan Chen	<i>Alan Chen</i>
Date of Receipt	2024/03/07
Date of Issue	2024/05/09
Report Version	V1.0

## INDEX

	<b>page</b>
Competences and Guarantees.....	4
General Conditions.....	4
Revision History.....	5
Summary of Test Result.....	6
1. General Information.....	7
1.1. EUT Description .....	7
1.2. EUT Information .....	8
1.3. Testing Location Information .....	8
1.4. Measurement Uncertainty .....	9
1.5. List of Test Equipment .....	10
2. Test Configuration of EUT .....	10
2.1. Test Condition.....	11
2.2. Test Frequency Mode.....	11
2.3. Duty Cycle .....	12
2.4. The Worst Case Measurement Configuration.....	13
2.5. Tested System Details.....	14
2.6. Configuration of Tested System .....	14
2.7. EUT Operating Procedures.....	14
3. AC Power Line Conducted Emission .....	15
3.1. Test Setup .....	15
3.2. Test Limit .....	15
3.3. Test Procedure .....	15
3.4. Test Result of AC Power Line Conducted Emission .....	15
4. 6dB Bandwidth .....	16
4.1. Test Setup .....	16
4.2. Test Limit .....	16
4.3. Test Procedures .....	16
4.4. Test Result of DTS Bandwidth .....	16
5. Maximum Conducted Output Power .....	17
5.1. Test Setup .....	17
5.2. Test Limit .....	17
5.3. Test Procedures .....	17
5.4. Test Result of Maximum Conducted Output Power .....	17
6. Power Spectral Density .....	18
6.1. Test Setup .....	18
6.2. Test Limit .....	18

---

6.3.	Test Procedures .....	18
6.4.	Test Result of Maximum Power Spectral Density .....	18
7.	Antenna Port Conducted Emission .....	19
7.1.	Test Setup .....	19
7.2.	Test Limit .....	19
7.3.	Test Procedure .....	19
7.4.	Test Result of Antenna Port Conducted Emission .....	19
8.	Radiated Emission .....	20
8.1.	Test Setup .....	20
8.2.	Test Limit .....	21
8.3.	Test Procedure .....	21
8.4.	Test Result of Radiated Emission .....	21
Appendix A. Test Result of AC Power Line Conducted Emission		
Appendix B. Test Result of 6dB Bandwidth		
Appendix C. Test Result of Maximum Conducted Output Power		
Appendix D. Test Result of Power Spectral Density		
Appendix E. Test Result of Antenna Port Conducted Emission		
Appendix F. Test Result of Radiated Emission		
Appendix G. Test Setup Photograph		

---

## Competences and Guarantees

---

DEKRA is a testing laboratory competent to carry out the tests described in this report.

In order to assure the traceability to other national and international laboratories, DEKRA has a calibration and maintenance program for its measurement equipment.

DEKRA guarantees the reliability of the data presented in this report, which is the result of the measurements and the tests performed to the item under test on the date and under the conditions stated in the report and it is based on the knowledge and technical facilities available at DEKRA at the time of performance of the test.

DEKRA is liable to the client for the maintenance of the confidentiality of all information related to the item under test and the results of the test.

The results presented in this Test Report apply only to the particular item under test established in this document.

**IMPORTANT:** No parts of this report may be reproduced or quoted out of context, in any form or by any means, except in full, without the previous written permission of DEKRA.

---

## General Conditions

---

1. The test results relate only to the samples tested.
2. The test results shown in the test report are traceable to the national/international standard through the calibration report of the equipment and evaluated measurement uncertainty herein.
3. This report must not be used to claim product endorsement by TAF or any agency of the government.
4. The test report shall not be reproduced without the written approval of DEKRA Testing and Certification Co., Ltd.
5. Measurement uncertainties evaluated for each testing system and associated connections are given here to provide the system information for reference. Compliance determinations do not take into account measurement uncertainties for each testing system, but are based on the results of the compliance measurement.

## Revision History

---

Version	Description	Issued Date
V1.0	Initial issue of report	2024/05/09

## Summary of Test Result

Report Clause	Test Items	Result (PASS/FAIL)	Remark
3	AC Power Line Conducted Emission	PASS	-
4	DTS Bandwidth	PASS	-
5	Maximum Conducted Output Power	PASS	-
6	Maximum Power Spectral Density	PASS	-
7	Antenna Port Conducted Emission	PASS	-
8	Radiated Emission	PASS	-

### Comments and Explanations

The declared of product specification for EUT presented in the report are provided by the manufacturer, and the manufacturer takes all the responsibilities for the accuracy of product specification.

## 1. General Information

### 1.1. EUT Description

Frequency Range	2400 ~ 2483.5 MHz
Operating Frequency	1 Mbps: 2402 ~ 2480 MHz 2 Mbps: 2402 ~ 2480 MHz
Channel Number	1 Mbps: 40 Channels 2 Mbps: 40 Channels
Mode	Bluetooth LE
Type of Modulation	GFSK

Accessories Information			
No.	Equipment Name	Brand Name	Model No.
1	Microphone	ASUS	A701
2	Audio Cable	ASUS	A701
3	USB Type C to Type A Adapter	ASUS	A701
4	USB Type C to Type A Cable	ASUS	A701
5	Gaming Headset Wireless Receiver	ASUS	A701Dongle

Antenna Information				
Item.	Brand Name	Model No.	Type	Antenna Gain (dBi)
1	Cicent	102BK3F1438	Dipole	-1.6

Note:

1. The above EUT information is declared by the manufacturer.
2. The antenna of EUT conforms to FCC 15.203.

## 1.2. EUT Information

EUT Power Type	From DC 3.7V by Battery / DC 5V by USB		
EUT Function	<input checked="" type="checkbox"/>	Point-to-multipoint	<input type="checkbox"/> Point-to-point

## 1.3. Testing Location Information

USA	FCC Registration Number: TW0033
Canada	CAB Identifier Number: TW3023 / Company Number: 26930

Site Description	Accredited by TAF
	Accredited Number: 3023

Test Laboratory	DEKRA Testing and Certification Co., Ltd.
	Linkou Laboratory
Address	No.5-22, Ruishukeng Linkou District, New Taipei City, 24451, Taiwan, R.O.C.
Performed Location	No. 26, Huaya 1st Rd., Guishan Dist., Taoyuan City 333411, Taiwan, R.O.C.
Phone Number	+886-3-275-7255
Fax Number	+886-3-327-8031

Ambient conditions in the laboratory:

Performed Item	Items	Required	Actual	Test Date
AC Power Line Conducted Emission	Temperature (°C)	10~40 °C	23.8 °C	2024/04/11
	Humidity (%RH)	10~90 %	61.4 %	
RF Conducted Emission	Temperature (°C)	10~40 °C	23.3 °C	2024/03/11
	Humidity (%RH)	10~90 %	57.2 %	
Radiated Emission	Temperature (°C)	10~40 °C	22.8 °C	2024/03/20-2024/03/21
	Humidity (%RH)	10~90 %	60.4 %	



#### 1.4. Measurement Uncertainty

Uncertainties have been calculated according to the DEKRA internal document with the emissions test results be included in the report. The measurement uncertainties given below are based on a 95% confidence level (based on a coverage factor (k=2)).

Test item	Uncertainty
AC Power Line Conducted Emission	±3.50 dB
DTS Bandwidth	±1580.61 Hz
Maximum Conducted Output Power	Spectrum Analyzer: ±2.14 dB Power Meter: ±1.05 dB
Maximum Power Spectral Density	±2.14 dB
Antenna Port Conducted Emission	±2.14 dB
Radiated Emission	9 kHz~30 MHz: ±3.88 dB 30 MHz~1 GHz: ±4.42 dB 1 GHz~18 GHz: ±4.28 dB 18 GHz~40 GHz: ±3.90 dB

## 1.5. List of Test Equipment

### For Conduction Measurements / HY-SR01

	Equipment	Manufacturer	Model No.	Serial No.	Cal. Date	Due Date
V	EMI Test Receiver	R&S	ESR7	101601	2023/06/20	2024/06/19
V	Two-Line V-Network	R&S	ENV216	101478	2023/09/13	2024/09/12
V	Two-Line V-Network	R&S	ENV216	101307	2023/08/17	2024/08/16
V	Coaxial Cable	SUHNER	RG400_BNC	RF001	2024/01/10	2025/01/09

Note:

1. All equipments are calibrated every one year.
2. The test instruments marked with "V" are used to measure the final test results.
3. Test Software Version: e3 230303 dekra V9.

### For Conducted Measurements / HY-SR02

	Equipment	Manufacturer	Model No.	Serial No.	Cal. Date	Due Date
V	Spectrum Analyzer	R&S	FSV30	103465	2023/06/14	2024/06/13
V	Spectrum Analyzer	KEYSIGHT	N9010A	MY53470892	2023/11/09	2024/11/08
V	Peak Power Analyzer	KEYSIGHT	8990B	MY51000539	2023/05/15	2024/05/14
V	Wideband Power Sensor	KEYSIGHT	N1923A	MY59240002	2023/05/18	2024/05/17
V	Wideband Power Sensor	KEYSIGHT	N1923A	MY59240003	2023/05/18	2024/05/17

Note:

1. All equipments are calibrated every one year.
2. The test instruments marked with "V" are used to measure the final test results.
3. Test Software Version: RF Conducted Test Tools R3 V3.0.0.14.

### For Radiated Measurements /HY-CB02

	Equipment	Manufacturer	Model No.	Serial No.	Cal. Date	Due Date
V	Loop Antenna	AMETEK	HLA6121	56736	2023/05/23	2024/05/22
V	Bi-Log Antenna	SCHWARZBECK	VULB9168	9168-0675	2023/08/09	2025/08/08
V	Horn Antenna	RF SPIN	DRH18-E	210503A18ES	2024/02/29	2025/02/28
V	Horn Antenna	Com-Power	AH-840	101100	2023/10/02	2025/10/01
V	Pre-Amplifier	SGH	SGH0301-9	20211007-8	2024/01/10	2025/01/09
V	Pre-Amplifier	SGH	SGH118-HS	20211102-1	2024/01/10	2025/01/09
V	Pre-Amplifier	EMCI	EMC05820SE	980285	2024/01/10	2025/01/09
V	Pre-Amplifier	EMCI	EMC184045SE	980369	2024/01/10	2025/01/09
V	Coaxial Cable	EMCI	EMC102-KM-KM-600	1160314	2024/01/10	2025/01/09
V	Coaxial Cable	EMCI	EMC102-KM-KM-7000	170242	2024/01/10	2025/01/09
V	Filter	MICRO TRONICS	BRM50702	G249	2024/01/05	2025/01/04
	Filter	MICRO TRONICS	BRM50716	G067	2024/01/05	2025/01/04
V	EMI Test Receiver	R&S	ESR3	102793	2023/12/11	2024/12/10
V	Spectrum Analyzer	R&S	FSV3044	101113	2024/02/05	2025/02/04
V	Coaxial Cable	SGH	HA800	GD20110223-2	2024/01/10	2025/01/09
V	Coaxial Cable	SGH	HA800	GD20110222-4	2024/01/10	2025/01/09
V	Coaxial Cable	SGH	SGH18	202108-5	2024/01/10	2025/01/09
V	Coaxial Cable	SGH	SGH18	202212-2	2023/11/27	2024/11/26

Note:

1. Bi-Log Antenna and Horn Antenna(AH-840) is calibrated every two years, the other equipments are calibrated every one year.
2. The test instruments marked with "V" are used to measure the final test results.
3. Test Software Version: e3 230303 dekra V9.

## 2. Test Configuration of EUT

### 2.1. Test Condition

EUT Operational Condition	
Testing Voltage	DC 5V By USB

### 2.2. Test Frequency Mode

Test Software Version	Airoha Tool Kit (AB1565 68 Lab Test Tool) / Version 3.8.0.1
-----------------------	---

Modulation	Frequency (MHz)	Power Setting
GFSK (1 Mbps)	2402	61
	2440	61
	2480	61
GFSK (2 Mbps)	2402	61
	2440	61
	2480	61

### 2.3. Duty Cycle

Mode	On Time (ms)	On+Off Time (ms)	Duty Cycle (%)	Duty Factor (dB)	VBW (Hz)
GFSK (1 Mbps)	2.1100	2.5000	84.40	0.74	500
GFSK (2 Mbps)	1.0600	2.5000	42.40	3.73	1000

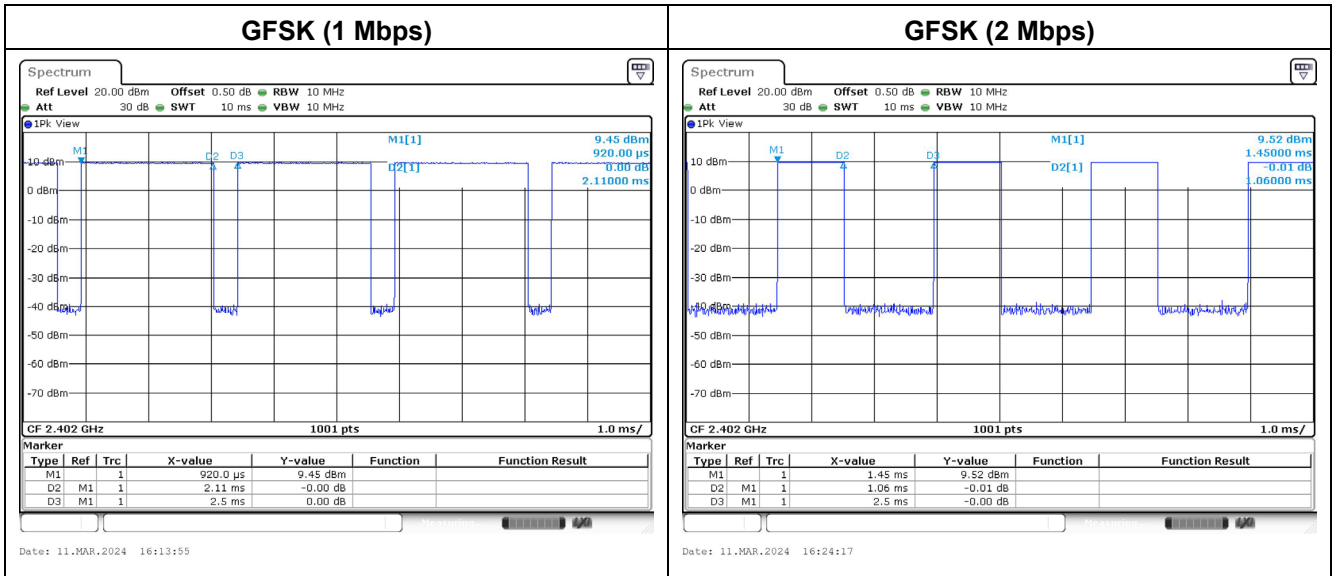

## 2.4. The Worst Case Measurement Configuration

Test Mode	Mode 1 (Transmit)	1 Mbps
		2 Mbps

Note:

1. Determining compliance shall be based on the results of the compliance measurement, not taking into account measurement instrumentation uncertainty.
2. For radiated emission below 1 GHz and AC power line conducted emission have performed all modes of operation were investigated and the worst-case emissions are reported.
3. The spectrum plot against conducted item only shows the worst case.
4. The radiation measurements are performed in X, Y, Z axis positioning. Only the worst case is shown in the report.

### 2.5. Tested System Details

No.	Equipment	Brand Name	Model No.	Serial No.	Power Cord
1	Notebook PC	Lenovo	TP00135A	RF-3ZD0E9	N/A
2	Test Fixture	Mercury Electronics	FT232RL USB To UART	N/A	N/A

### 2.6. Configuration of Tested System

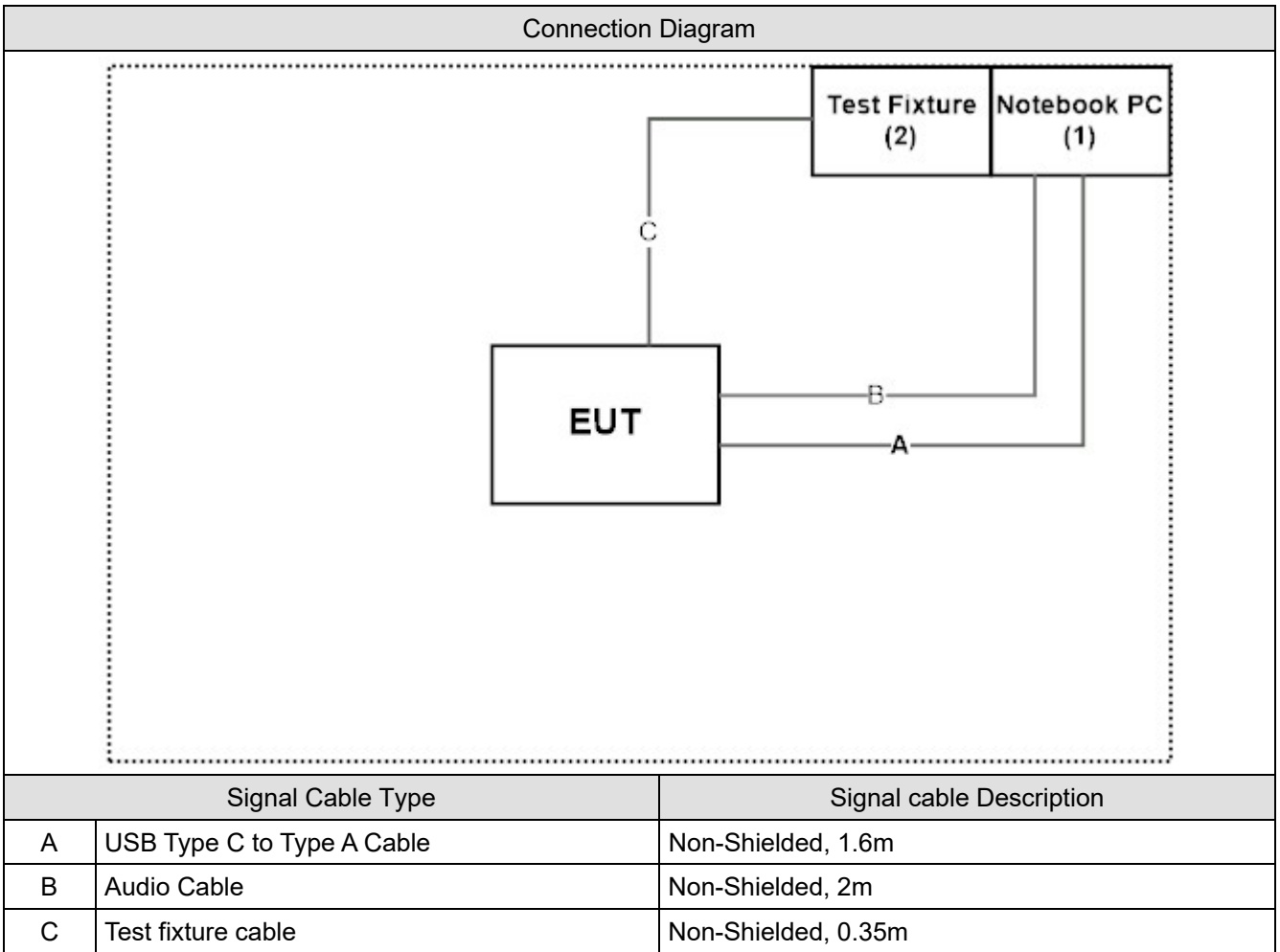

### 2.7. EUT Operating Procedures

1	Setup the EUT as shown in Section 2.6.
2	Execute software "Airoha Tool Kit (AB1565 68 Lab Test Tool) / Version 3.8.0.1" on the Notebook PC.
3	Configure the test mode, the test channel, and the data rate.
4	Press "OK" to start the continuous Transmit.
5	Verify that the EUT works properly.

### 3. AC Power Line Conducted Emission

#### 3.1. Test Setup

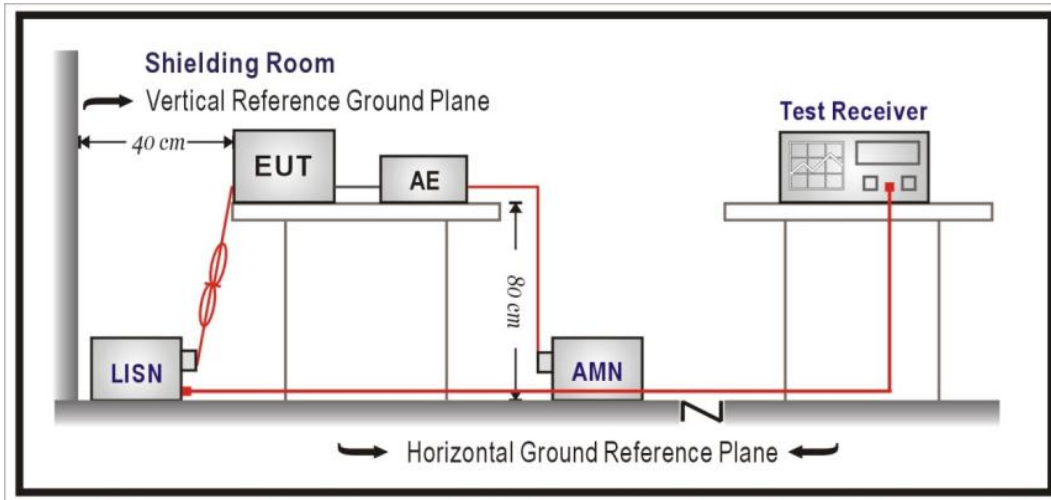

#### 3.2. Test Limit

Frequency (MHz)	QP (dBuV)	AV (dBuV)
0.15 - 0.50	66 - 56	56 - 46
0.50 - 5.0	56	46
5.0 - 30	60	50

Remarks: In the above table, the tighter limit applies at the band edges.

#### 3.3. Test Procedure

The EUT was setup according to ANSI C63.10: 2013 for AC Power Line Conducted Emissions.

#### 3.4. Test Result of AC Power Line Conducted Emission

Refer as Appendix A

## 4. 6dB Bandwidth

### 4.1. Test Setup

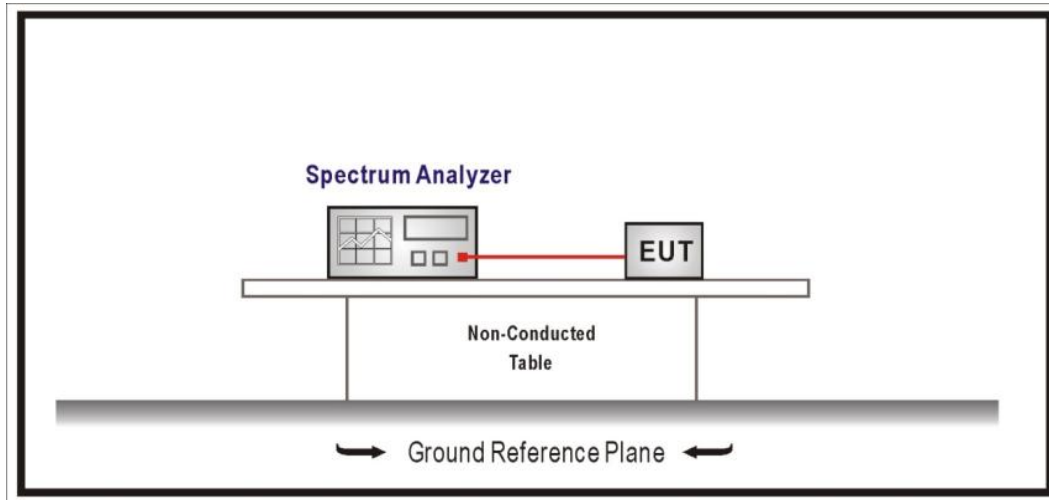

### 4.2. Test Limit

The 6 dB bandwidth:  $\geq 500$  kHz.

### 4.3. Test Procedures

The EUT was setup according to ANSI C63.10: 2013; tested according to DTS test procedure of KDB 558074.

### 4.4. Test Result of DTS Bandwidth

Refer as Appendix B



## 5. Maximum Conducted Output Power

### 5.1. Test Setup

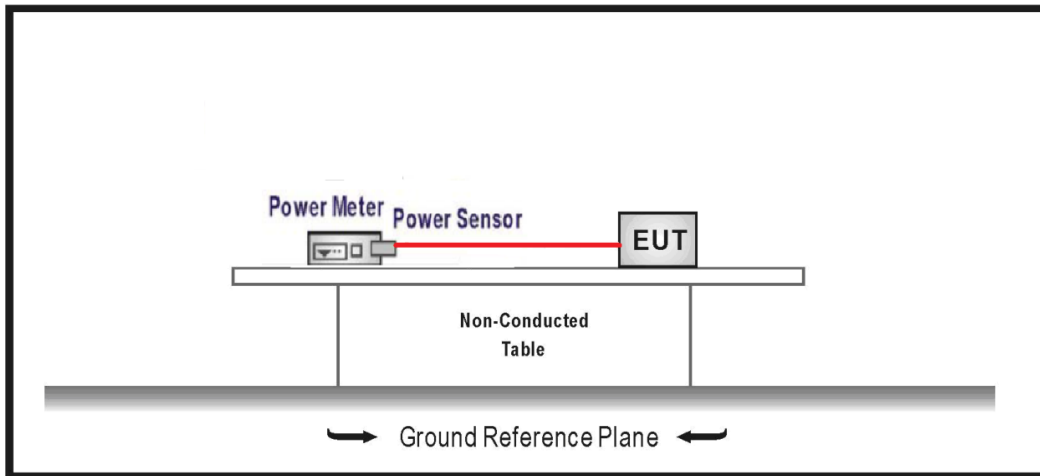

### 5.2. Test Limit

The Maximum Conducted Output Power shall be less 1 Watt.

### 5.3. Test Procedures

The EUT was setup according to ANSI C63.10: 2013; tested according to DTS test procedure of KDB 558074.

### 5.4. Test Result of Maximum Conducted Output Power

Refer as Appendix C

## 6. Power Spectral Density

### 6.1. Test Setup

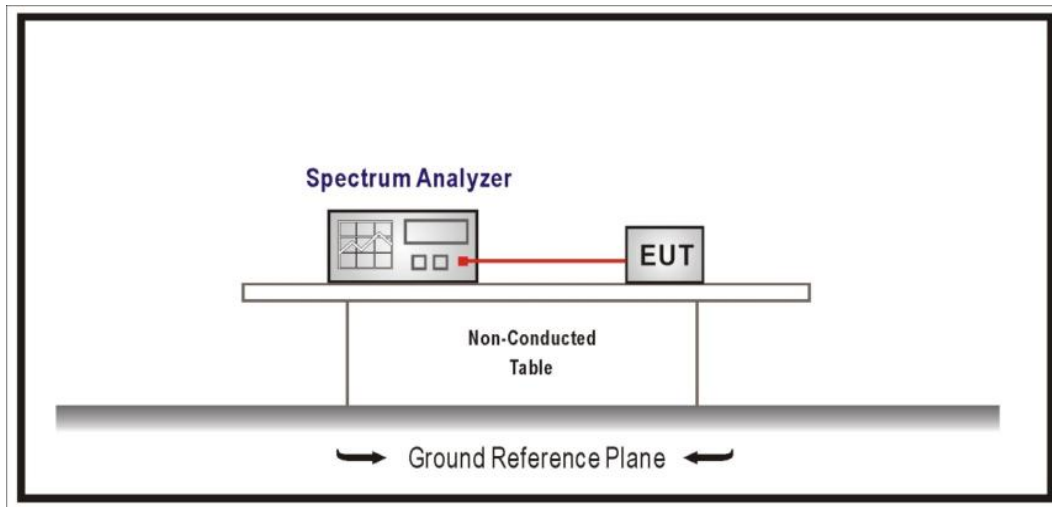

### 6.2. Test Limit

The power spectral density conducted from the intentional radiated to the antenna shall not be greater than +8 dBm in any 3 kHz band during any time interval of continuous transmission.

### 6.3. Test Procedures

The EUT was setup according to ANSI C63.10: 2013; tested according to DTS test procedure of KDB 558074.

### 6.4. Test Result of Maximum Power Spectral Density

Refer as Appendix D

## 7. Antenna Port Conducted Emission

### 7.1. Test Setup

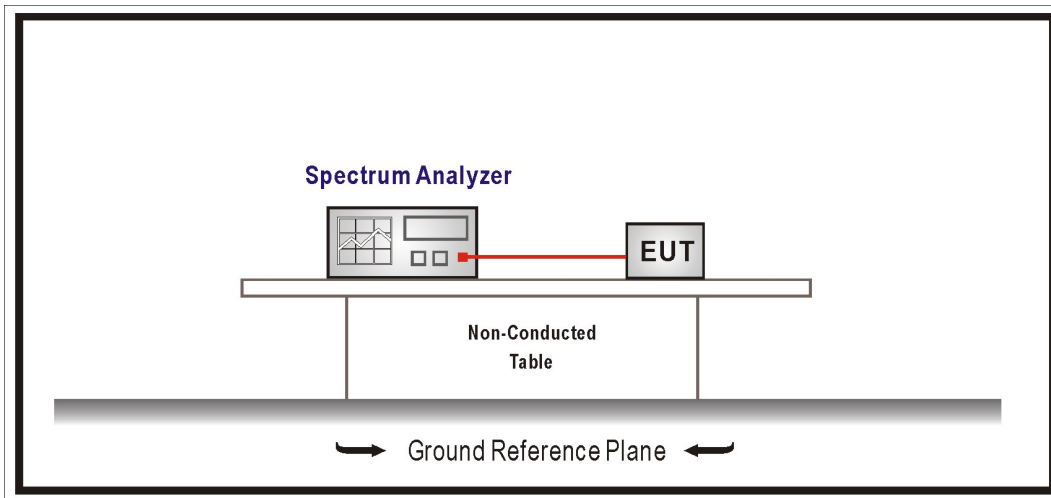

### 7.2. Test Limit

RF output power procedure	Limit (dBc)
Peak output power procedure	20
Average output power procedure	30

#### Remarks:

1. In any 100 kHz bandwidth outside the frequency band in which the spread spectrum or digitally modulated intentional radiator is operating, the radio frequency power that is produced by the intentional radiator shall be at least 20 dB below that in the 100 kHz bandwidth within the band that contains the highest level of the desired power, based on either an RF conducted or a radiated measurement, provided the transmitter demonstrates compliance with the peak conducted power limit.
2. If the transmitter complies with the conducted power limit based on the use of RMS averaging over a time interval, the attenuation required under this paragraph shall be 30 dB instead of 20 dB.

### 7.3. Test Procedure

The EUT was setup according to ANSI C63.10: 2013 and tested according to DTS test procedure of KDB 558074.

### 7.4. Test Result of Antenna Port Conducted Emission

Refer as Appendix E

## 8. Radiated Emission

### 8.1. Test Setup

9 kHz ~ 30 MHz

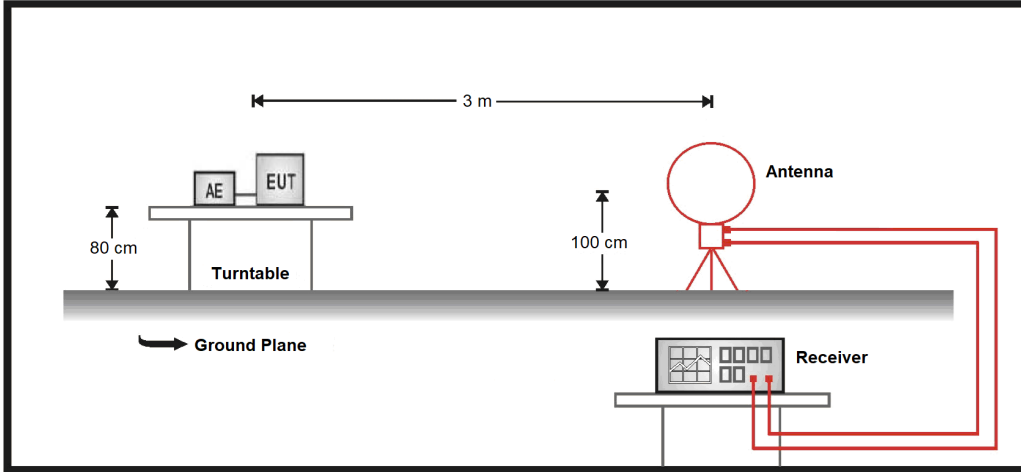

30 MHz ~ 1 GHz

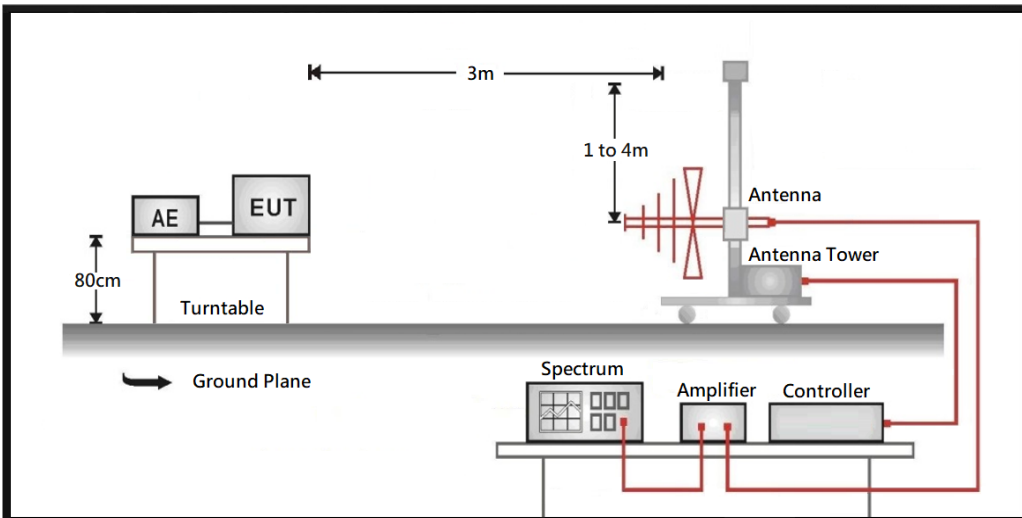

Above 1 GHz

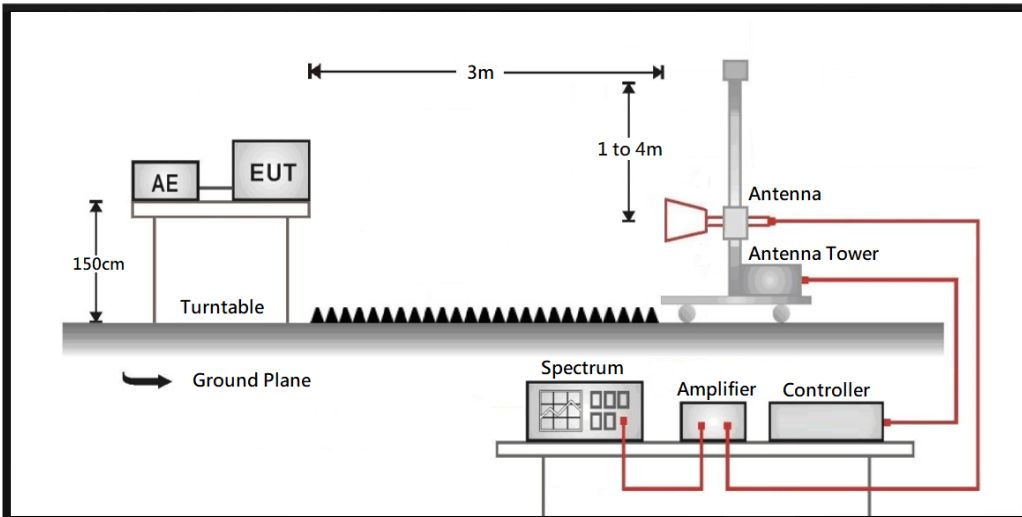

## 8.2. Test Limit

Frequency (MHz)	Field strength (uV/m)	Field strength (dBuV/m)	Measurement distance (m)
0.009 – 0.490	2400/F(kHz)	20 log (2400/F(kHz))	300
0.490 – 1.705	24000/F(kHz)	20 log (24000/F(kHz))	30
1.705 - 30	30	29.5	30
30 - 88	100	40	3
88 - 216	150	43.5	3
216 - 960	200	46	3
Above 960	500	54	3

Remarks:

1. Field strength (dBuV/m) = 20 log Field strength (uV/m)
2. In the Above Table, the tighter limit applies at the band edges.
3. Distance refers to the distance in meters between the measuring instrument antenna and the closed point of any part of the device or system.

## 8.3. Test Procedure

The EUT was setup according to ANSI C63.10: 2013 and tested according to DTS test procedure of KDB 558074.

The EUT and its simulators are placed on a turn table which is 0.8 or 1.5 meter above ground. The turn table can rotate 360 degrees to determine the position of the maximum emission level.

The antenna can move up and down between 1 meter and 4 meters to find out the maximum emission level.

Both horizontal and vertical polarization of the antenna are set on measurement. In order to find the maximum emission, all of the interface cables must be manipulated according to ANSI C63.10: 2013 on radiated measurement.

On any frequency or frequencies from 9 kHz (include The the lowest oscillator frequency generated within the device up to the 10th harmonic) to 1000 MHz, the limit shown are based on measuring equipment employing a quasi-peak detector function and on any frequency or frequencies above 1000 MHz the radiated limit shown are based upon the use of measurement instrumentation employing an average detector function. When average radiated emission measurement are included emission measurement below 1000 MHz, there also is a limit on the radio frequency emissions, as measured using instrumentation with a peak detector function, corresponding to 20 dB above the maximum permitted average limit.

The bandwidth below 1 GHz setting on the field strength meter is 120 kHz and above 1 GHz is 1 MHz.

## 8.4. Test Result of Radiated Emission

Refer as Appendix F