

FCC RF Test Report

APPLICANT : ASUSTek COMPUTER INC.
EQUIPMENT : PDA Phone
BRAND NAME : ASUS
MODEL NAME : E600
FCC ID : MSQ-0121180101
STANDARD : FCC Part 15 Subpart C §15.247
CLASSIFICATION : Digital Spread Spectrum (DSS)

The product was received on Apr. 17, 2010 and completely tested on May 20, 2010. We, SPORTON INTERNATIONAL INC., would like to declare that the tested sample has been evaluated in accordance with the procedures given in ANSI C63.4-2003 and shown the compliance with the applicable technical standards.

The test results in this report apply exclusively to the tested model / sample. Without written approval of SPORTON INTERNATIONAL INC., the test report shall not be reproduced except in full.

Reviewed by:



Roy Wu / Manager



SPORTON INTERNATIONAL INC.

No. 52, Hwa Ya 1st Rd., Hwa Ya Technology Park, Kwei-Shan Hsiang, Tao Yuan Hsien, Taiwan, R.O.C.



TABLE OF CONTENTS

REVISION HISTORY..... 3

SUMMARY OF TEST RESULT 4

1 GENERAL DESCRIPTION..... 5

 1.1 Applicant 5

 1.2 Manufacturer..... 5

 1.3 Feature of Equipment Under Test 5

 1.4 Testing Site 6

 1.5 Applied Standards 6

 1.6 Ancillary Equipment List 7

2 TEST CONFIGURATION OF EQUIPMENT UNDER TEST..... 8

 2.1 RF Output Power 8

 2.2 Test Mode..... 9

 2.3 Connection Diagram of Test System..... 10

 2.4 RF Utility 11

3 TEST RESULT 12

 3.1 Number of Channel Measurement 12

 3.2 20dB Bandwidth Measurement 14

 3.3 Hopping Channel Separation Measurement 21

 3.4 Dwell Time Measurement..... 24

 3.5 Peak Output Power Measurement 26

 3.6 Band Edges Measurement 29

 3.7 Spurious Emission Measurement..... 41

 3.8 AC Conducted Emission Measurement..... 46

 3.9 Radiated Emission Measurement..... 50

 3.10 Antenna Requirements..... 59

4 LIST OF MEASURING EQUIPMENT..... 60

5 UNCERTAINTY OF EVALUATION..... 61

APPENDIX A. PHOTOGRAPHS OF EUT

APPENDIX B. SETUP PHOTOGRAPHS

**SUMMARY OF TEST RESULT**

Report Section	FCC Rule	IC Rule	Description	Limit	Result	Remark
3.1	15.247(a)(1)	A8.4(2)	Number of Channels	≥ 15Chs	Pass	-
3.2	15.247(a)(1)	A8.1(a)	20dB Bandwidth	NA	Pass	-
3.3	15.247(a)(1)	A8.1(b)	Channel Separation	≥ 2/3 of 20dB BW	Pass	-
3.4	15.247(a)(1)	A8.1(d)	Dwell Time of Each Channel	≤ 0.4sec in 31.6sec period	Pass	-
3.5	15.247(b)(1)	A8.1(b)	Peak Output Power	≤ 1W	Pass	-
3.6	15.247(d)	A8.5	Frequency Band Edges	≤ 20dBc	Pass	-
3.7	15.247(d)	A8.5	Spurious Emission	< 20 dBc	Pass	-
3.8	15.207	Gen 7.2.2	AC Conducted Emission	15.207(a)	Pass	Under limit 14.6 dB at 0.366 MHz
3.9	15.247(d)	A8.5	Transmitter Radiated Emission	15.209(a) & 15.247(d)	Pass	Under limit 4.06 dB at 2483.5 MHz
3.10	15.203 & 15.247(b)	A8.4	Antenna Requirement	N/A	Pass	-

1 General Description

1.1 Applicant

ASUSTek COMPUTER INC.

4F., No. 150, Li-Te Rd., Peitou, Taipei, Taiwan

1.2 Manufacturer

ProTek (Shanghai) Ltd.

No. 3768, Xiu Yan Road, Nanhui District, 201315 Shanghai, P.R.C.

1.3 Feature of Equipment Under Test

Product Feature & Specification	
Equipment	PDA Phone
Brand Name	ASUS
Model Name	E600
FCC ID	MSQ-0121180101
Tx/Rx Frequency Range	2400 MHz ~ 2483.5 MHz
Number of Channels	79
Carrier Frequency of Each Channel	2402+n*1 MHz; n=0~78
Channel Spacing	1 MHz
Maximum Output Power to Antenna	Bluetooth (1Mbps) : 5.29 dBm (3.38 mW) Bluetooth EDR (2Mbps) : 7.40 dBm (5.50 mW) Bluetooth EDR (3Mbps) : 7.77 dBm (5.98 mW)
Antenna Type	PIFA Antenna with gain 4 dBi
HW Version	V1.1
SW Version	V2.3.3_Build_1403 modem: M1.4.7-Q1
Type of Modulation	Bluetooth (1Mbps) : GFSK Bluetooth EDR (2Mbps) : π /4-DQPSK Bluetooth EDR (3Mbps) : 8-DPSK
EUT Stage	Identical Prototype

Remark:

1. For other wireless features of this EUT, test report will be issued separately.
2. This test report recorded only product characteristics and test results of Digital Spread Spectrum (DSS).
3. The above EUT's information was declared by manufacturer. Please refer to the specifications or user's manual for more detailed description.



1.4 Testing Site

Test Site	SPORTON INTERNATIONAL INC.		
Test Site Location	No. 52, Hwa Ya 1 st Rd., Hwa Ya Technology Park, Kwei-Shan Hsiang, Tao Yuan Hsien, Taiwan, R.O.C. TEL: +886-3-3273456 / FAX: +886-3-3284978		
Test Site No.	Sporton Site No.		FCC/IC Registration No.
	CO05-HY	03CH06-HY	TW1022/4086B-1

1.5 Applied Standards

According to the specifications of the manufacturer, the EUT must comply with the requirements of the following standards:

- ♦ FCC Part 15 Subpart C §15.247
- ♦ FCC Public Notice DA 00-705
- ♦ ANSI C63.4-2003
- ♦ IC RSS-210 Issue 7

Remark:

1. All test items were verified and recorded according to the standards and without any deviation during the test.
2. This EUT has also been tested and complied with the requirements of FCC Part 15, Subpart B (DoC), recorded in a separate test report.



1.6 Ancillary Equipment List

Item	Equipment	Trade Name	Model Name	FCC ID	Data Cable	Power Cord
1.	System Simulator	R&S	CMU 200	N/A	N/A	Unshielded, 1.8 m
2.	Bluetooth Base Station	R&S	CBT32	N/A	N/A	Unshielded, 1.8 m
3.	WLAN AP	D-Link	DIR-628	KA2DIR628A2	N/A	Unshielded, 1.8 m
4.	Notebook	DELL	Vostro 1510	FCC DoC	N/A	AC I/P: Unshielded, 1.2 m DC O/P: Shielded, 1.8 m
5.	Bluetooth Earphone	Nokia	BH-102	PYAHS-107W	N/A	N/A

2 Test Configuration of Equipment Under Test

2.1 RF Output Power

Preliminary tests were performed in different data rate and recorded the RF output power in the following table:

Channel	Frequency	Bluetooth RF Output Power		
		Data Rate / Modulation		
		GFSK	π /4-DQPSK	8-DPSK
		1Mbps	2Mbps	3Mbps
Ch00	2402MHz	5.16 dBm	6.88 dBm	7.15 dBm
Ch39	2441MHz	5.22 dBm	7.23 dBm	7.66 dBm
Ch78	2480MHz	5.29 dBm	7.40 dBm	7.77 dBm

Remark:

1. The data rate was set in 3Mbps for all the test items due to the highest RF output power.
2. The EUT is programmed to transmit signals continuously for all testing.

2.2 Test Mode

The EUT has been associated with peripherals pursuant to ANSI C63.4-2003 and configuration operated in a manner tended to maximize its emission characteristics in a typical application. Frequency range investigated: conduction (150 kHz to 30 MHz), radiation (9 kHz to the 10th harmonic of the highest fundamental frequency or to 40 GHz, whichever is lower).

Pre-scanned tests were conducted to determine the final configuration from all possible combinations.

The following tables are showing the test modes as the worst cases and recorded in this report.

Test Cases			
Test Item	Data Rate / Modulation		
	Bluetooth 1Mbps GFSK	Bluetooth EDR 2Mbps π /4-DQPSK	Bluetooth EDR 3Mbps 8-DPSK
Conducted TCs	Mode 1: CH00_2402 MHz Mode 2: CH39_2441 MHz Mode 3: CH78_2480 MHz	Mode 4: CH00_2402 MHz Mode 5: CH39_2441 MHz Mode 6: CH78_2480 MHz	Mode 7: CH00_2402 MHz Mode 8: CH39_2441 MHz Mode 9: CH78_2480 MHz
Radiated TCs	N/A	N/A	Mode 1: CH00_2402 MHz Mode 2: CH39_2441 MHz Mode 3: CH78_2480 MHz
AC Conducted Emission	Mode 1 :GSM850 Idle + Bluetooth Link + WLAN Link + Earphone + USB Cable (Charging from Adapter) + Camera		
Remark: For radiated TCs, the data rate was set in 3Mbps due to the highest RF output power; only the data of these modes was reported.			

2.3 Connection Diagram of Test System

<Bluetooth Tx Mode>

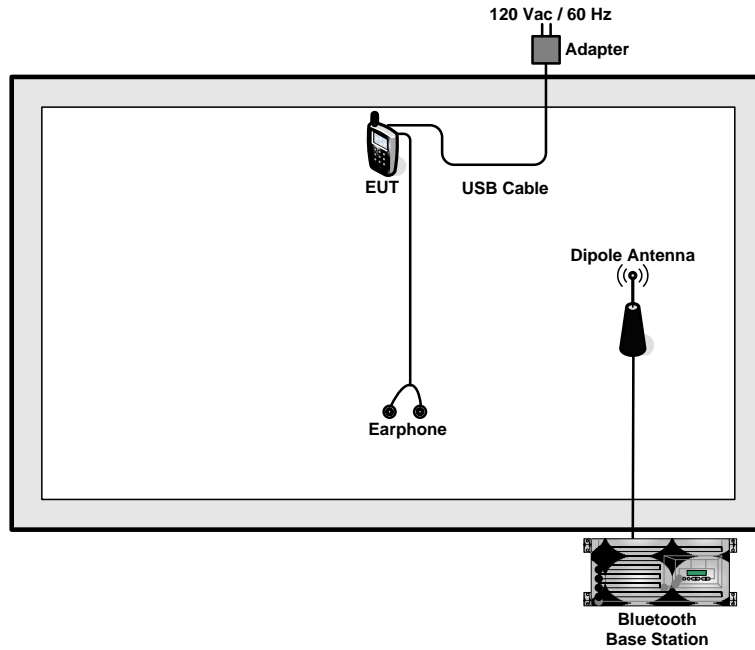

<EUT with Adapter Mode>

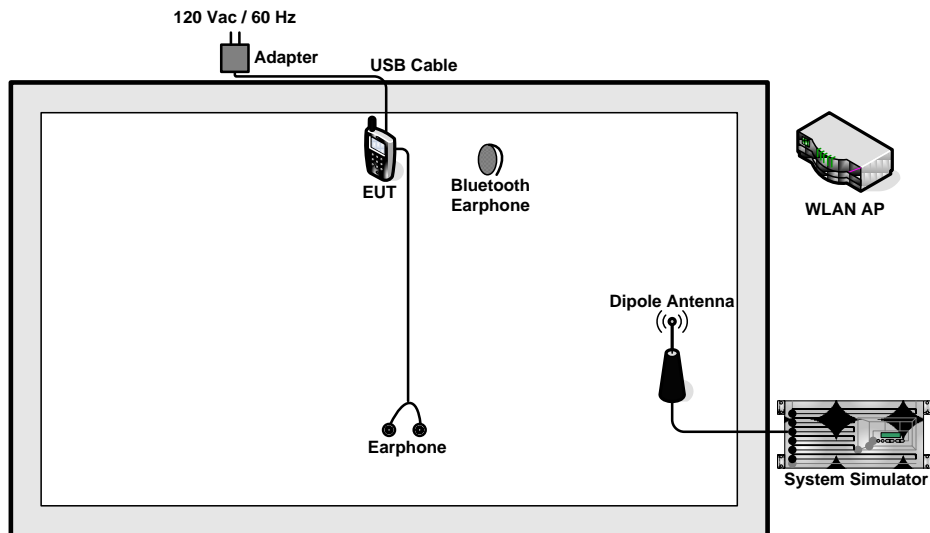



2.4 RF Utility

For Bluetooth function, the RF utility, "BT Test_Mode" was installed in EUT which was programmed in order to make the EUT into the engineering modes to contact with Bluetooth base station for transmitting and receiving signals continuously.

3 Test Result

3.1 Number of Channel Measurement

3.1.1 Limits of Number of Hopping Frequency

Frequency hopping systems in the 2400-2483.5 MHz band shall use at least 15 channels.

3.1.2 Measuring Instruments

See list of measuring instruments of this test report.

3.1.3 Test Procedure

1. The testing follows FCC Public Notice DA 00-705 Measurement Guidelines.
2. The RF output of EUT was connected to the spectrum analyzer by a low loss cable.
3. The modulation types of EUT are irrelevant to number of hopping channels deviation.
4. The EUT must have its hopping function enabled. Use the following spectrum analyzer settings:
Span = the frequency band of operation; $RBW \geq 1\%$ of the span; $VBW \geq RBW$; Sweep = auto;
Detector function = peak; Trace = max hold.
5. The number of hopping frequency used is defined as the device has the numbers of total channel.

3.1.4 Test Setup

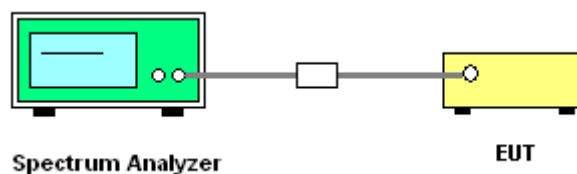

3.1.5 Test Result of Number of Hopping Frequency

Test Mode :	Mode 7~9	Temperature :	26~28°C
Test Engineer :	Andy Yeh	Relative Humidity :	44~47%
Number of Hopping Channels (Channel)		Limits (Channel)	
79		> 15	
		Pass/Fail	
		Pass	

Number of Hopping Channel Plot on Channel 00 - 78

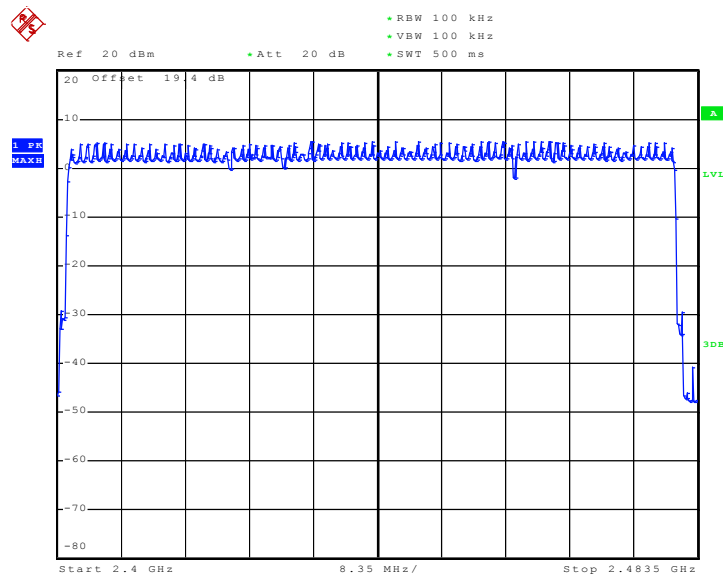

Date: 17.MAY.2010 03:47:52

3.2 20dB Bandwidth Measurement

3.2.1 Limit of 20dB Bandwidth

N/A

3.2.2 Measuring Instruments

See list of measuring instruments of this test report.

3.2.3 Test Procedures

1. The testing follows FCC Public Notice DA 00-705 Measurement Guidelines.
2. The RF output of EUT was connected to the spectrum analyzer by a low loss cable.
3. The EUT should be transmitting at its maximum data rate as the worst cases.
4. Use the following spectrum analyzer settings:
Span = approximately 2 to 3 times the 20 dB bandwidth, centered on a hopping channel;
RBW \geq 1% of the 20 dB bandwidth; VBW \geq RBW; Sweep = auto; Detector function = peak;
Trace = max hold.
5. The marker-delta reading at this point is the 20 dB bandwidth of the emission.

3.2.4 Test Setup

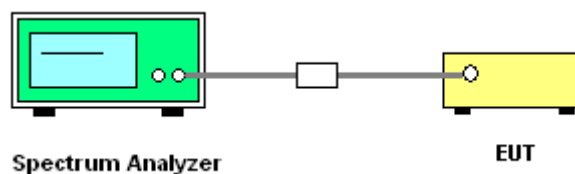



3.2.5 Test Result of 20dB Bandwidth

Test Mode :	Mode 1, 2, 3	Temperature :	26~28°C
Test Engineer :	Andy Yeh	Relative Humidity :	44~47%

Channel	Frequency (MHz)	20dB Bandwidth (MHz)
00	2402	0.795
39	2441	0.798
78	2480	0.798

20 dB Bandwidth Plot on Channel 00

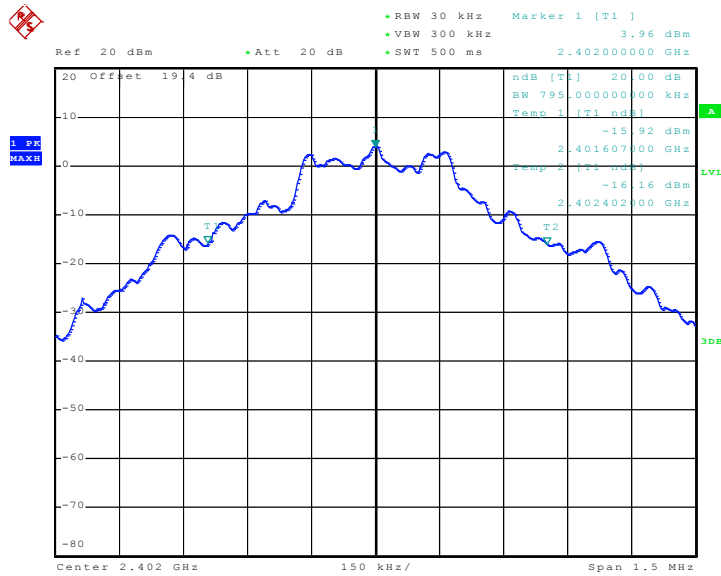

Date: 17.MAY.2010 02:27:00



20 dB Bandwidth Plot on Channel 39

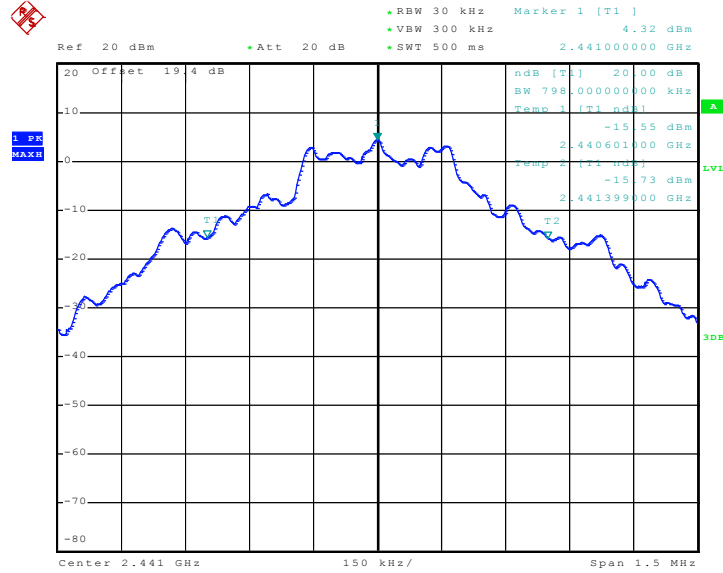

Date: 17.MAY.2010 02:30:17

20 dB Bandwidth Plot on Channel 78

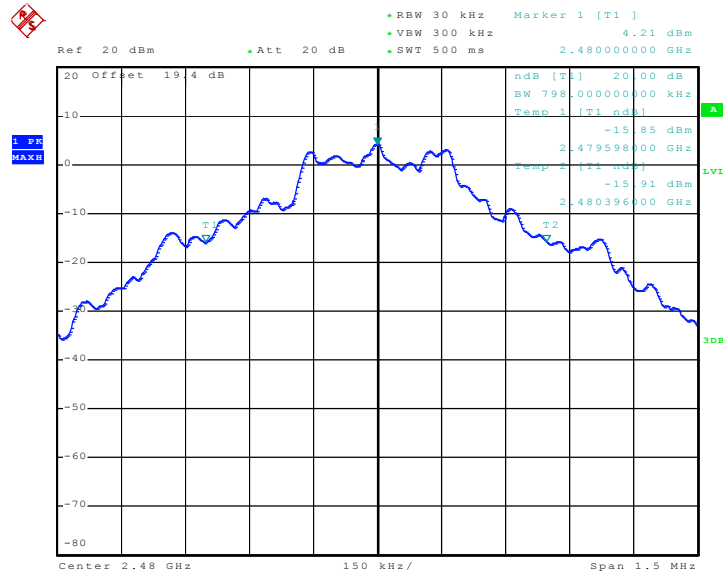

Date: 17.MAY.2010 02:31:43



Test Mode :	Mode 4, 5, 6	Temperature :	26~28°C
Test Engineer :	Andy Yeh	Relative Humidity :	44~47%

Channel	Frequency (MHz)	20dB Bandwidth (MHz)
00	2402	1.252
39	2441	1.256
78	2480	1.256

20 dB Bandwidth Plot on Channel 00

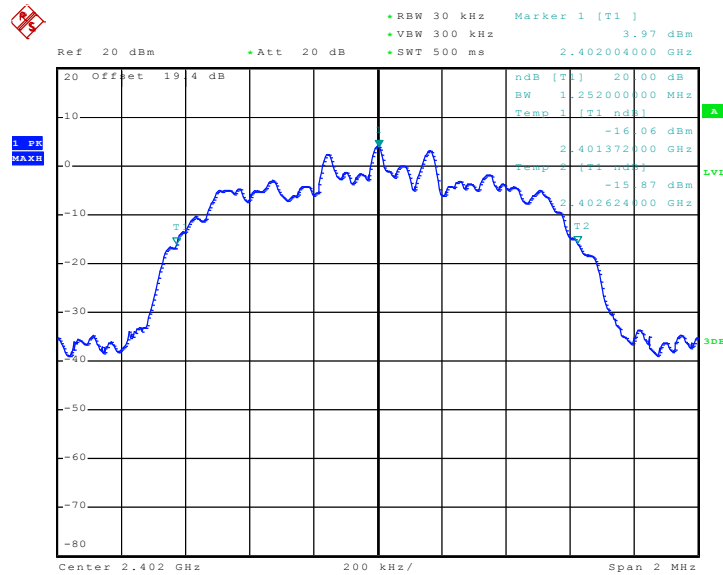

Date: 17.MAY.2010 02:33:07



20 dB Bandwidth Plot on Channel 39

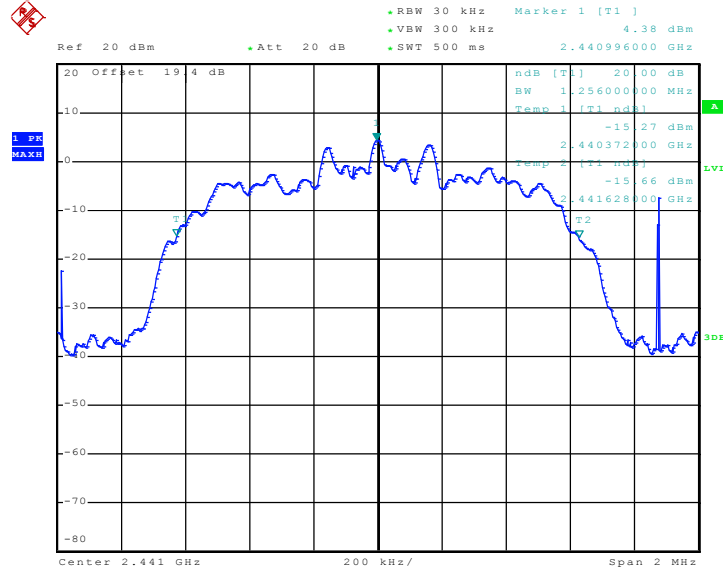

Date: 17.MAY.2010 02:34:14

20 dB Bandwidth Plot on Channel 78

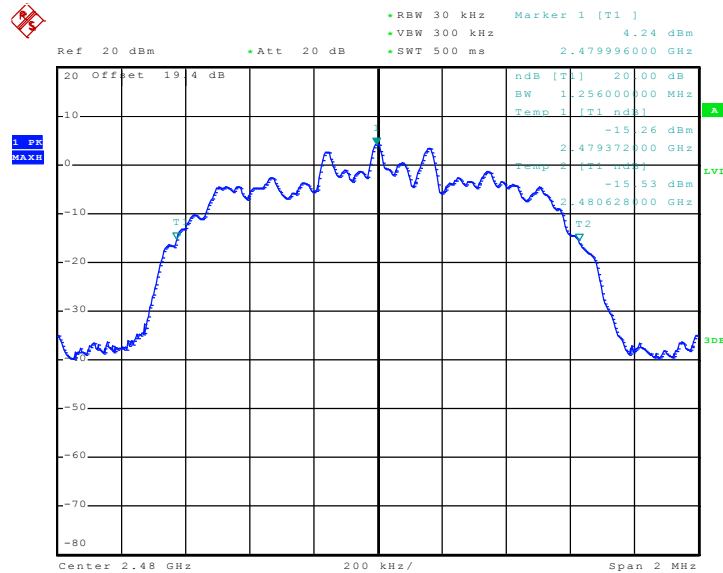

Date: 17.MAY.2010 02:35:11



Test Mode :	Mode 7, 8, 9	Temperature :	26~28°C
Test Engineer :	Andy Yeh	Relative Humidity :	44~47%

Channel	Frequency (MHz)	20dB Bandwidth (MHz)
00	2402	1.228
39	2441	1.228
78	2480	1.228

20 dB Bandwidth Plot on Channel 00

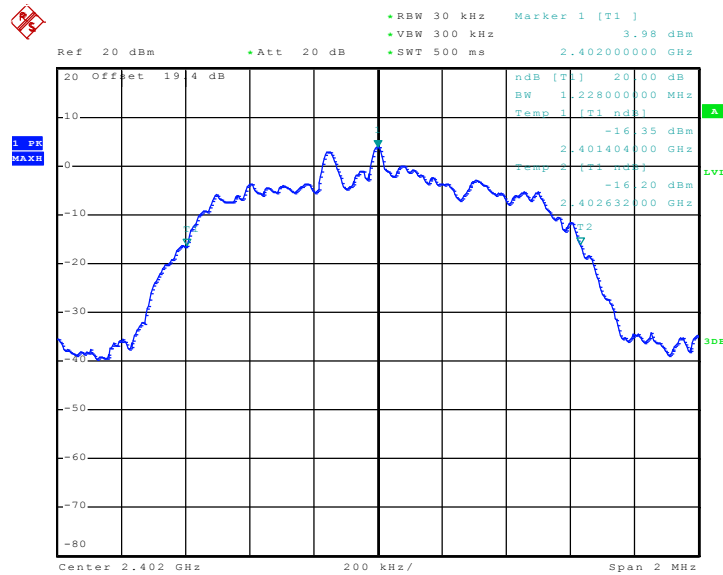

Date: 17.MAY.2010 02:37:55



20 dB Bandwidth Plot on Channel 39

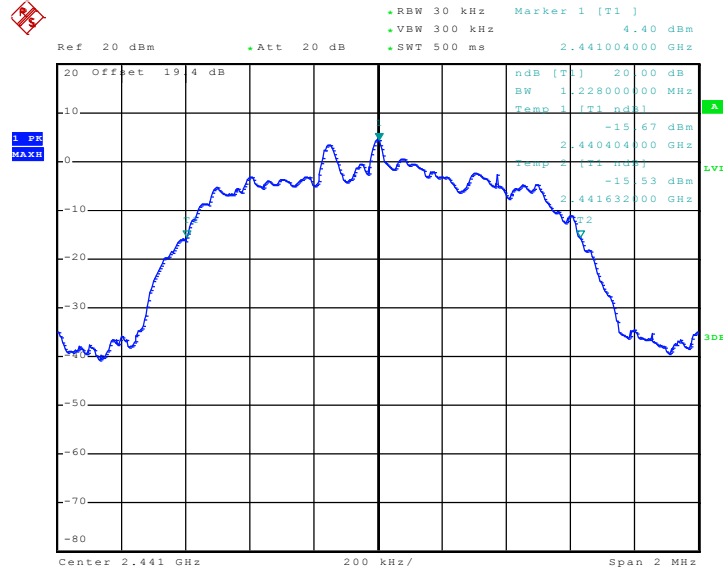

Date: 17.MAY.2010 02:37:01

20 dB Bandwidth Plot on Channel 78

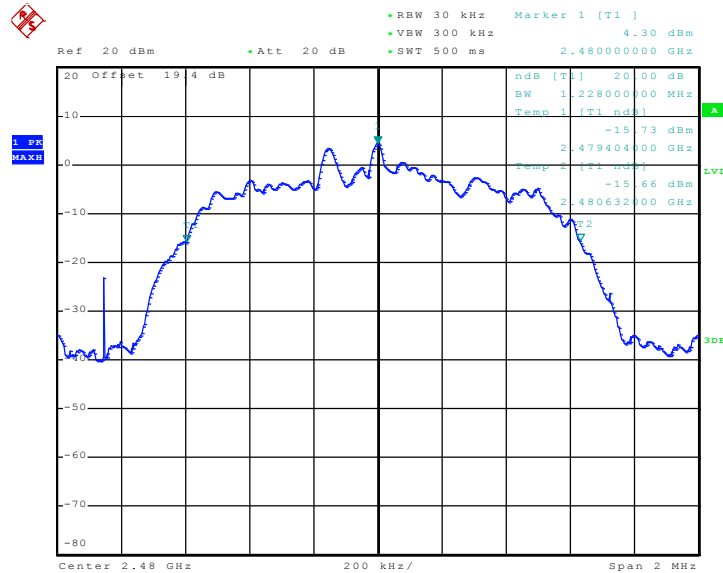

Date: 17.MAY.2010 02:36:08

3.3 Hopping Channel Separation Measurement

3.3.1 Limit of Hopping Channel Separation

Frequency hopping systems operating in the 2400-2483.5 MHz band may have hopping channel carrier frequencies that are separated by 25 kHz or two-thirds of the 20 dB bandwidth of the hopping channel, whichever is greater.

3.3.2 Measuring Instruments

See list of measuring instruments of this test report.

3.3.3 Test Procedures

1. Please refer FCC Public Notice DA 00-705 Measurement Guidelines.
2. The RF output of EUT was connected to the spectrum analyzer by a low loss cable.
3. The EUT should be transmitting at its maximum data rate as the worst cases.
4. Use the following spectrum analyzer settings:
Span = wide enough to capture the peaks of two adjacent channels; $RBW \geq 1\%$ of the span;
VBW \geq RBW; Sweep = auto; Detector function = peak; Trace = max hold.
5. Use the marker-delta function to determine the separation between the peaks of the adjacent channels.

3.3.4 Test Setup

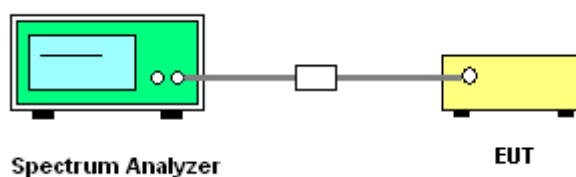

3.3.5 Test Result of Hopping Channel Separation

Test Mode :	Mode 7, 8, 9	Temperature :	26~28°C
Test Engineer :	Andy Yeh	Relative Humidity :	44~47%

Channel	Frequency (MHz)	Frequency Separation (MHz)	(2/3 of 20dB BW) Limits (MHz)	Pass/Fail
00	2402	1.008	0.819	Pass
39	2441	1.008	0.819	Pass
78	2480	1.008	0.819	Pass

Channel Separation Plot on Channel 00 - 01

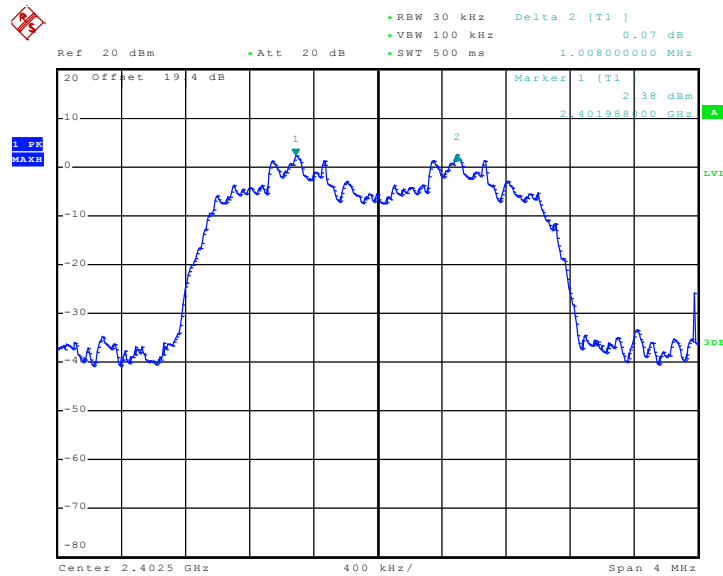

Date: 17.MAY.2010 04:52:36



Channel Separation Plot on Channel 39 - 40

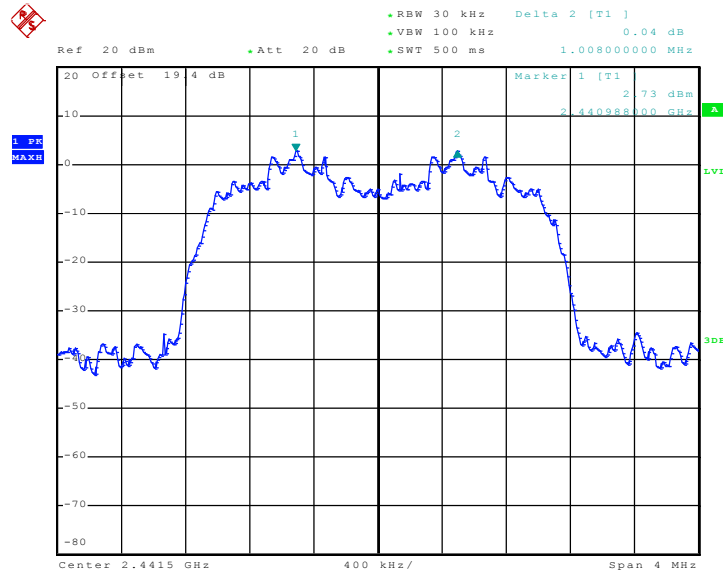

Date: 17.MAY.2010 04:53:01

Channel Separation Plot on Channel 77 - 78

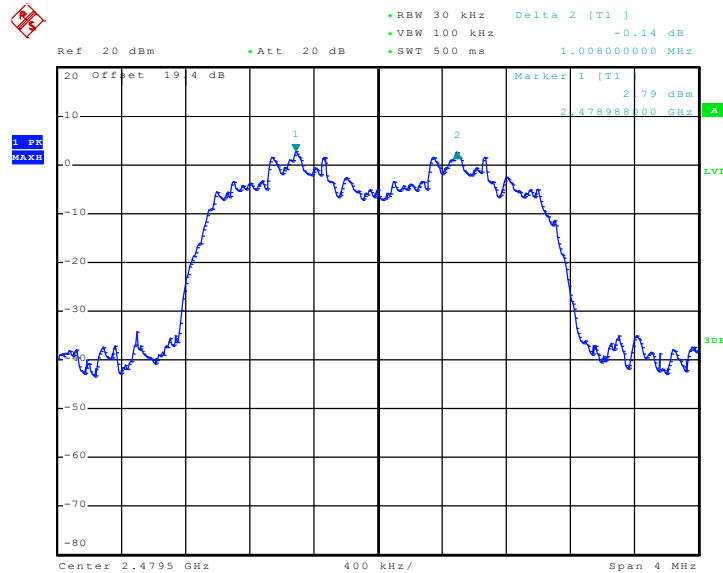

Date: 17.MAY.2010 04:53:25

3.4 Dwell Time Measurement

3.4.1 Limit of Dwell Time

The average time of occupancy on any channel shall not be greater than 0.4 seconds within a period of 0.4 seconds multiplied by the number of hopping channels employed.

3.4.2 Measuring Instruments

See list of measuring instruments of this test report.

3.4.3 Test Procedures

1. The testing follows FCC Public Notice DA 00-705 Measurement Guidelines.
2. The RF output of EUT was connected to the spectrum analyzer by a low loss cable.
3. The EUT should be transmitting at its maximum data rate as the worst cases.
4. The EUT must have its hopping function enabled. Use the following spectrum analyzer settings:
Span = zero span, centered on a hopping channel; RBW = 1 MHz; VBW ≥ RBW; Sweep = as necessary to capture the entire dwell time per hopping channel; Detector function = peak; Trace = max hold.
5. Use the marker-delta function to calculate the dwell time.

3.4.4 Test Setup

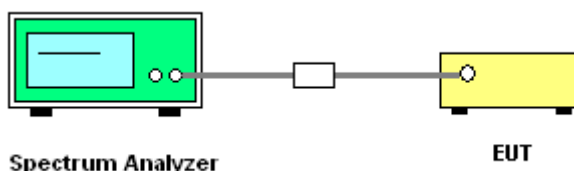

3.4.5 Test Result of Dwell Time

Test Mode :	Mode 8	Temperature :	26~28°C
Test Engineer :	Andy Yeh	Relative Humidity :	44~47%

Package Mode	Average Hopping Channel	Package Transfer Time (usec)	Dwell Time (sec)	Limits (sec)	Pass/Fail
3DH5	3.30	2966.00	0.31	0.4	Pass

Remark:

1. Dwell Time=79(channels) x 0.4(s) x average hopping channel x package transfer time
2. 79 channels come from the Hopping Channel number.
3. Average Hopping Channel = hops/sweep time
4. t: Package Transfer Time(us)



3DH5 Dwell Time (One Pulse) Plot on Channel 39

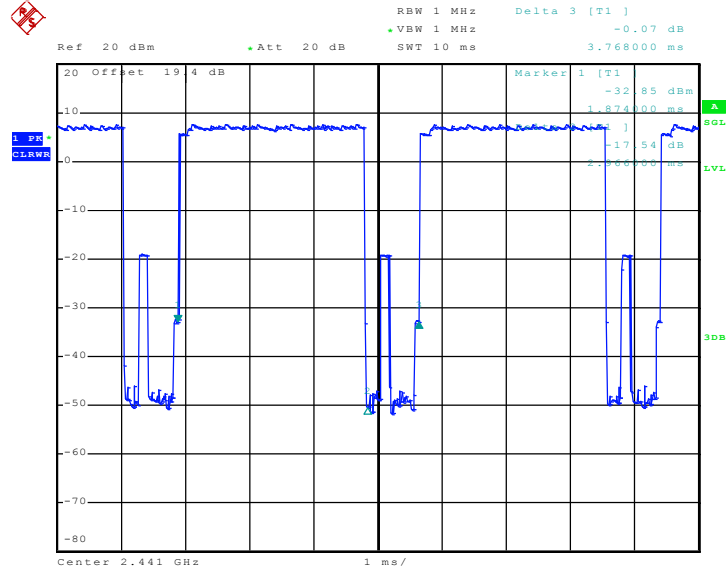

Date: 17.MAY.2010 03:42:18

3DH5 Dwell Time (Count Pulses) Plot on Channel 39

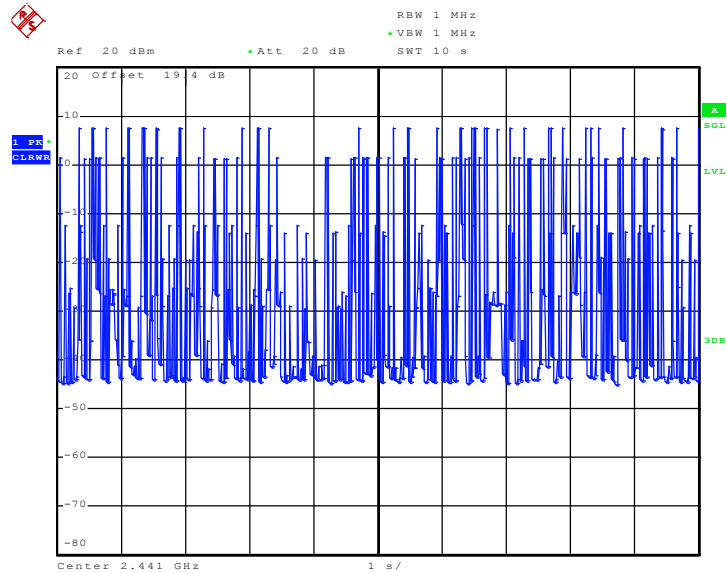

Date: 17.MAY.2010 03:57:51

3.5 Peak Output Power Measurement

3.5.1 Limit of Peak Output Power

Frequency hopping systems operating in the 2400-2483.5 MHz band employing at least 75 non-overlapping hopping channels: 1W (30 dBm).

3.5.2 Measuring Instruments

See list of measuring instruments of this test report.

3.5.3 Test Procedures

1. The testing follows FCC Public Notice DA 00-705 Measurement Guidelines.
2. The RF output of EUT was connected to the spectrum analyzer by a low loss cable.

3.5.4 Test Setup

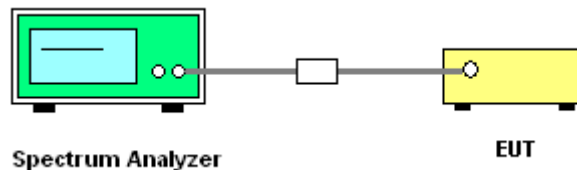

3.5.5 Test Result of Peak Output Power

Test Mode :	Mode 7, 8, 9	Temperature :	26~28°C
Test Engineer :	Andy Yeh	Relative Humidity :	44~47%

Channel	Frequency (MHz)	RF Power (dBm)		
		8-DPSK	Max. Limits (dBm)	Pass/Fail
		3 Mbps		
00	2402	7.15	30	Pass
39	2441	7.66	30	Pass
78	2480	7.77	30	Pass



Peak Output Power Plot on Channel 00

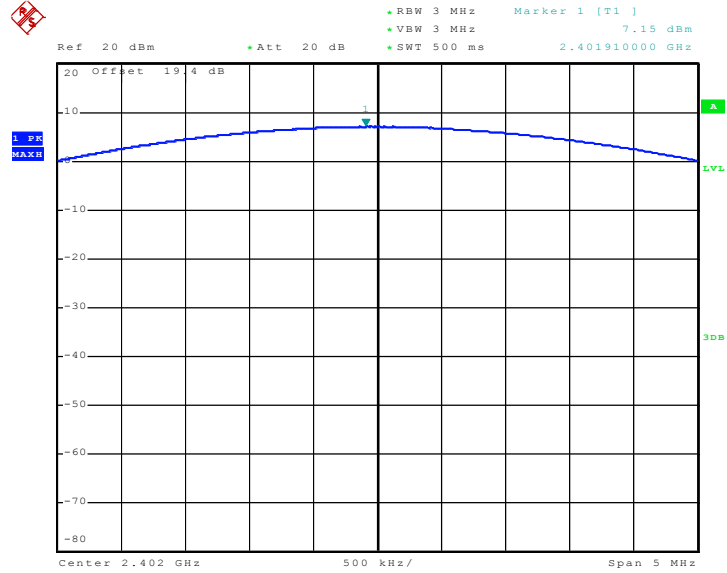

Date: 13.MAY.2010 14:11:25

Peak Output Power Plot on Channel 39

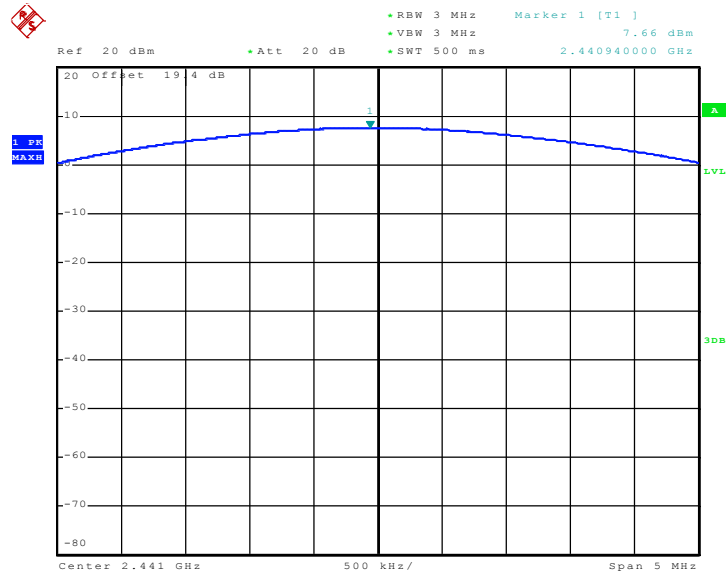

Date: 13.MAY.2010 14:12:27



Peak Output Power Plot on Channel 78

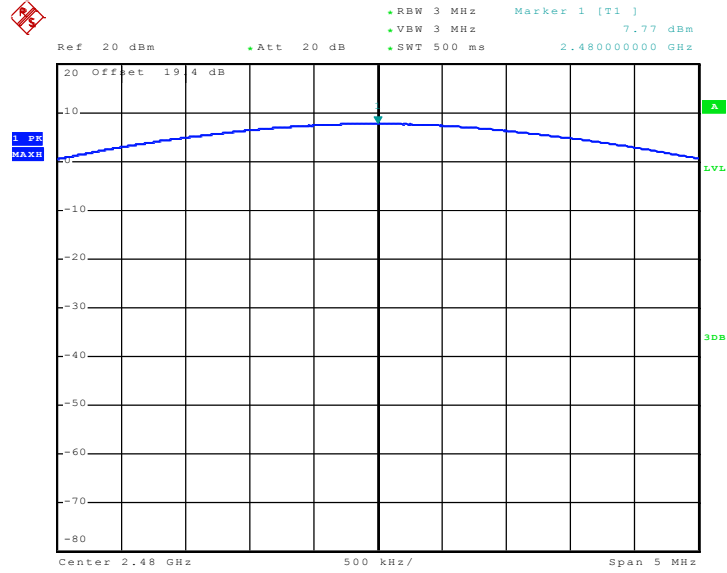

Date: 13.MAY.2010 14:11:51



3.6 Band Edges Measurement

3.6.1 Limit of Band Edges

In any 100 kHz bandwidth outside the intentional radiation frequency band, the radio frequency power shall be at least 20 dB below the highest level of the radiated power. In addition, radiated emissions which fall in the restricted bands must also comply with the radiated emission limits.

3.6.2 Measuring Instruments

See list of measuring instruments of this test report.

3.6.3 Test Procedures

1. The testing follows the guidelines in ANSI C63.4-2003 and FCC Public Notice DA 00-705 Measurement Guidelines.
2. RF antenna conducted test: Set RBW = 300kHz, Video bandwidth (VBW) \geq RBW. Band edge emissions must be at least 20 dB down from the highest emission level within the authorized band as measured with a 300k Hz RBW. Note: If the device complies with the use of power option 2 the attenuation under this paragraph shall be 30 dB instead of 20 dB.
3. Radiated emission test: Applies to band edge emissions that fall in the restricted bands listed in FCC Section 15.205. The maximum permitted average field strength is listed in FCC Section 15.209. A pre-amp is necessary for this measurement. For measurements above 1 GHz, set RBW = 1MHz, VBW = 1MHz, Sweep: Auto for Peak; set RBW = 1MHz, VBW = 10 Hz, Sweep: Auto for Average. If the emission is pulsed, modify the unit for continuous operation; use the settings shown above, then correct the reading by subtracting the peak-average correction factor, derived from the appropriate duty cycle calculation. See FCC Section 15.35(b) and (c).
4. In case the emission is fail due to the used RBW / VBW is too wide, marker-delta method of FCC Public Notice DA 00-705 will be followed.

3.6.4 Test Setup

<Radiated Band Edges>

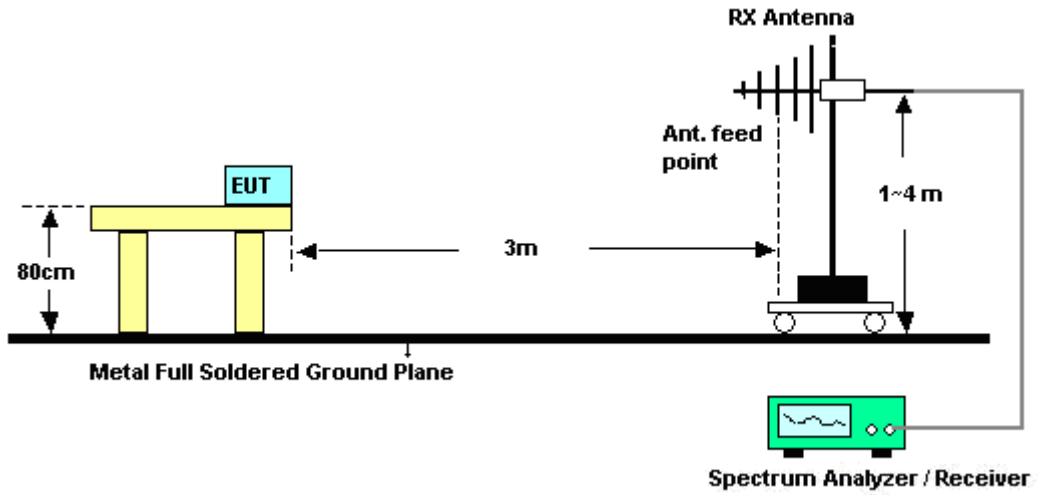

<Conducted Band Edges>

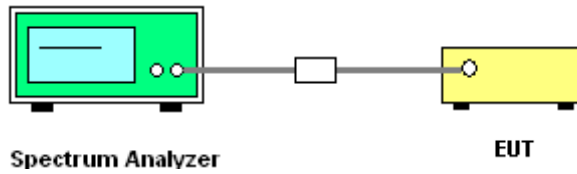



3.6.5 Test Result of Radiated Band Edges

Test Mode :	Mode 1	Temperature :	24~25°C
Test Channel :	00	Relative Humidity :	43~44%
		Test Engineer :	Kay Wu

ANTENNA POLARITY : HORIZONTAL										
Frequency (MHz)	Level (dBuV/m)	Over Limit (dB)	Limit Line (dBuV/m)	Read Level (dBuV)	Antenna Factor (dB)	Cable Loss (dB)	Preamp Factor (dB)	Ant Pos (cm)	Table Pos (deg)	Remark
2388.69	48.32	-25.68	74	46.93	31.86	3.92	34.39	100	342	Peak
2388.69	35.18	-18.82	54	33.79	31.86	3.92	34.39	100	342	Average

ANTENNA POLARITY : VERTICAL										
Frequency (MHz)	Level (dBuV/m)	Over Limit (dB)	Limit Line (dBuV/m)	Read Level (dBuV)	Antenna Factor (dB)	Cable Loss (dB)	Preamp Factor (dB)	Ant Pos (cm)	Table Pos (deg)	Remark
2387.14	46.14	-27.86	74	44.75	31.86	3.92	34.39	100	55	Peak
2387.14	32.81	-21.19	54	31.42	31.86	3.92	34.39	100	55	Average

Test Mode :	Mode 3	Temperature :	24~25°C
Test Channel :	78	Relative Humidity :	43~44%
		Test Engineer :	Kay Wu

ANTENNA POLARITY : HORIZONTAL										
Frequency (MHz)	Level (dBuV/m)	Over Limit (dB)	Limit Line (dBuV/m)	Read Level (dBuV)	Antenna Factor (dB)	Cable Loss (dB)	Preamp Factor (dB)	Ant Pos (cm)	Table Pos (deg)	Remark
2483.5	69.94	-4.06	74	68.28	31.98	4.05	34.37	100	350	Peak
2483.5	30.14	-23.86	54	28.48	31.98	4.05	34.37	100	350	Average

ANTENNA POLARITY : VERTICAL										
Frequency (MHz)	Level (dBuV/m)	Over Limit (dB)	Limit Line (dBuV/m)	Read Level (dBuV)	Antenna Factor (dB)	Cable Loss (dB)	Preamp Factor (dB)	Ant Pos (cm)	Table Pos (deg)	Remark
2483.5	67.71	-6.29	74	66.05	31.98	4.05	34.37	134	315	Peak
2483.5	28.31	-25.69	54	26.65	31.98	4.05	34.37	134	315	Average



Test Mode :	Mode 3	Temperature :	24~25°C
Test Channel :	78	Relative Humidity :	43~44%
		Test Engineer :	Kay Wu

ANTENNA POLARITY : HORIZONTAL										
Frequency (MHz)	Level (dBuV/m)	Over Limit (dB)	Limit Line (dBuV/m)	Read Level (dBuV)	Antenna Factor (dB)	Cable Loss (dB)	Preamp Factor (dB)	Ant Pos (cm)	Table Pos (deg)	Remark
2480	104.9	30.9	74	103.24	31.98	4.05	34.37	100	350	Peak
2480	87.15	33.15	54	85.49	31.98	4.05	34.37	100	350	Average

Summary results of marker-delta method:

Test mode	Maximum field strength of the fundamental emission (dBµV/m)	Delta Result (dB)	Average Result (dBµV/m)	Average Limit (dBµV/m)	Margin (dB)	Result
Single Carrier Mode	87.15	57.01	30.14	54	87.15	Pass
Hopping Mode	87.15	58.29	28.86	54	87.15	Pass

Note : Average result = Maximum field strength – Delta result

ANTENNA POLARITY : VERTICAL										
Frequency (MHz)	Level (dBuV/m)	Over Limit (dB)	Limit Line (dBuV/m)	Read Level (dBuV)	Antenna Factor (dB)	Cable Loss (dB)	Preamp Factor (dB)	Ant Pos (cm)	Table Pos (deg)	Remark
2480	102.9	28.9	74	101.24	31.98	4.05	34.37	134	315	Peak
2480	85.61	31.61	54	83.95	31.98	4.05	34.37	134	315	Average

Summary results of marker-delta method:

Test mode	Maximum field strength of the fundamental emission (dBµV/m)	Delta Result (dB)	Average Result (dBµV/m)	Average Limit (dBµV/m)	Margin (dB)	Result
Single Carrier Mode	85.61	57.3	28.31	54	85.61	Pass
Hopping Mode	85.61	58.61	27.00	54	85.61	Pass

Note : Average result = Maximum field strength – Delta result



Test Mode :	Mode 3	Temperature :	24~25°C
Test Channel :	78	Relative Humidity :	43~44%
Test Engineer :	Kay Wu	Polarization :	Horizontal

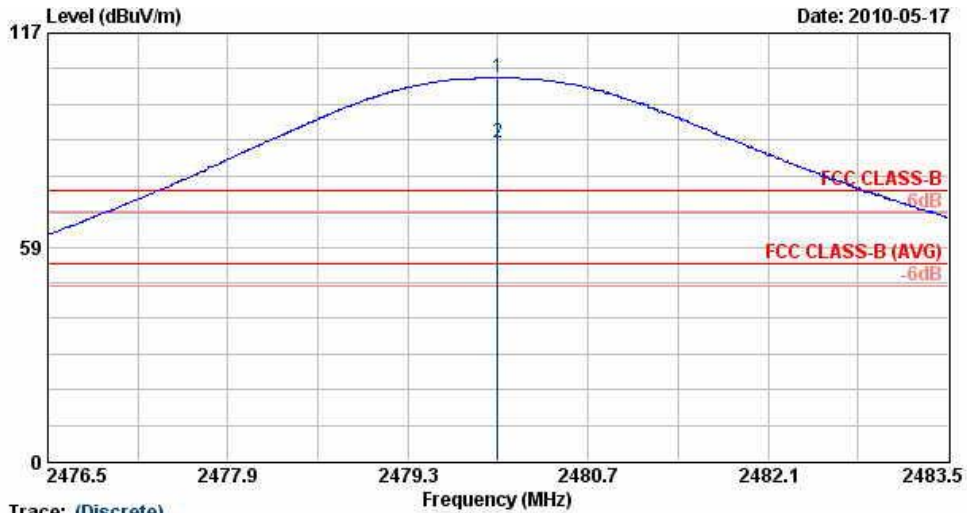

Trace: (Discrete)
 Site : 03CH06-HY
 Condition : FCC CLASS-B 3m HF-ANT_000824 HORIZONTAL
 Project : FR 041702
 Memo : Mode 3
 Temp : 25 °C
 Humidity : 46 %

	Freq	Level	Over Limit	Limit Line	Read Level	Antenna Factor	Cable Loss	Preamp Factor	Ant Pos	Table Pos	Remark
	MHz	dBUV/m	dB	dBUV/m	dBuV	dB/m	dB	dB	cm	deg	
1	X	2480.00	104.90	30.90	74.00	103.25	31.98	4.05	34.37	100	350 Peak
2	@	2480.00	87.15	33.15	54.00	85.49	31.98	4.05	34.37	100	350 Average

* Maximum field strength of the fundamental emission



Test Mode :	Mode 3	Temperature :	24~25°C
Test Channel :	78	Relative Humidity :	43~44%
Test Engineer :	Kay Wu	Polarization :	Horizontal

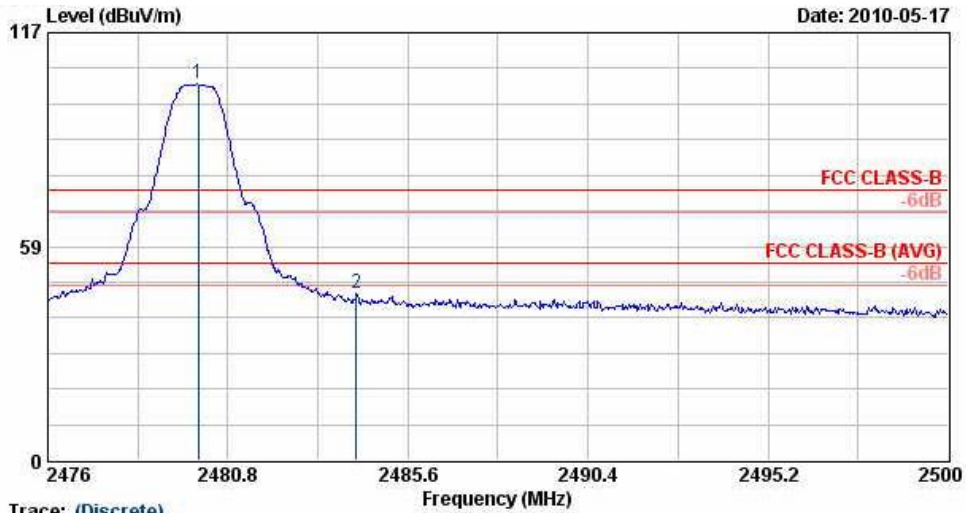

Trace: (Discrete)
 Site : 03CH06-HY
 Condition : FCC CLASS-B 3m HF-ANT_090824 HORIZONTAL
 Project : FR 041702
 Memo : Mode 3
 Temp : 25 °C
 Humidity : 46 %

	Freq	Level	Over Limit	Limit Line	ReadAntenna Level	Antenna Factor	Cable Loss	Preamp Factor	Ant Pos	Table Pos	Remark
	MHz	dBuV/m	dB	dBuV/m	dBuV	dB/m	dB	dB	cm	deg	
1 X	2480.00	102.88	28.88	74.00	101.22	31.98	4.05	34.37	100	350	Peak
2	2484.23	45.87	-28.13	74.00	44.22	31.98	4.05	34.37	100	350	Peak

* Marker-Delta Method (RBW/VBW=100KHz): 57.01 dB , single carrier Mode



Test Mode :	Mode 3	Temperature :	24~25°C
Test Channel :	78	Relative Humidity :	43~44%
Test Engineer :	Kay Wu	Polarization :	Horizontal

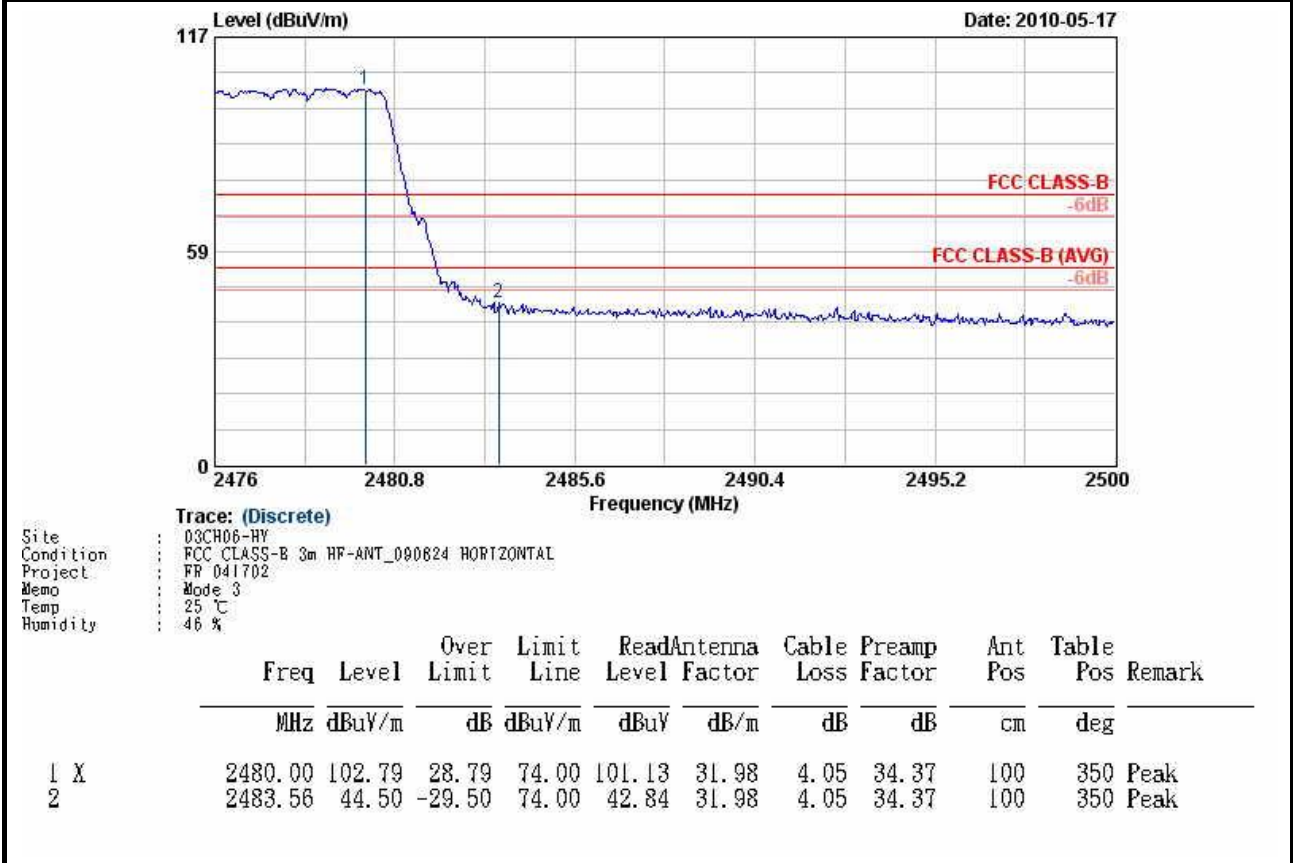

* Marker-Delta Method (RBW/VBW=100KHz): 58.29 dB , Hopping Mode



Test Mode :	Mode 3	Temperature :	24~25°C
Test Channel :	78	Relative Humidity :	43~44%
Test Engineer :	Kay Wu	Polarization :	Vertical

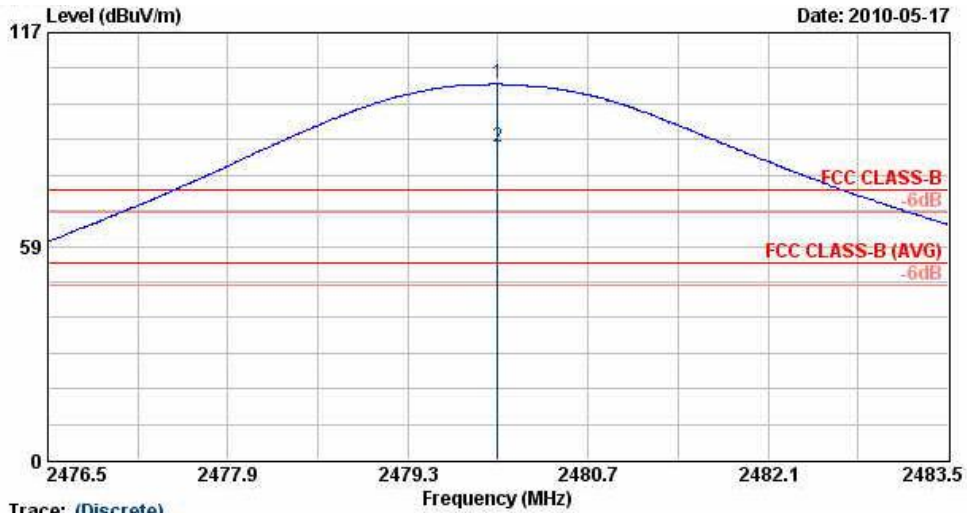

Trace: (Discrete)
 Site : 03CH06-HY
 Condition : FCC CLASS-B 3m HF-ANT_000824 VERTICAL
 Project : FR 041702
 Memo : Mode 3
 Temp : 25 °C
 Humidity : 46 %

	Freq	Level	Over Limit	Limit Line	ReadAntenna Level	Antenna Factor	Cable Loss	Preamp Factor	Ant Pos	Table Pos	Remark
	MHz	dBUV/m	dB	dBUV/m	dBUV	dB/m	dB	dB	cm	deg	
1 X	2480.00	102.90	28.90	74.00	101.25	31.98	4.05	34.37	134	315	Peak
2 @	2480.00	85.61	31.61	54.00	83.95	31.98	4.05	34.37	134	315	Average

* Maximum field strength of the fundamental emission



Test Mode :	Mode 3	Temperature :	24~25°C
Test Channel :	78	Relative Humidity :	43~44%
Test Engineer :	Kay Wu	Polarization :	Vertical

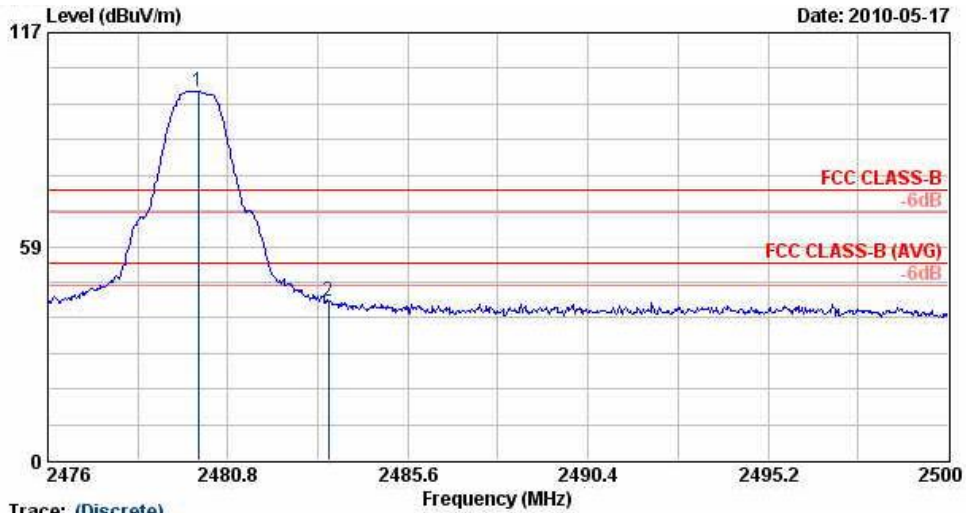

Trace: (Discrete)
 Site : 03CH06-HY
 Condition : FCC CLASS-B 3m HF-ANT_090824 VERTICAL
 Project : FR 041702
 Memo : Mode 3
 Temp : 25 °C
 Humidity : 46 %

	Freq	Level	Over Limit	Limit Line	ReadAntenna Level	Antenna Factor	Cable Loss	Preamp Factor	Ant Pos	Table Pos	Remark
	MHz	dBuV/m	dB	dBuV/m	dBuV	dB/m	dB	dB	cm	deg	
1 X	2480.00	100.82	26.82	74.00	99.17	31.98	4.05	34.37	134	315	Peak
2	2483.49	43.52	-30.48	74.00	41.86	31.98	4.05	34.37	134	315	Peak

* Marker-Delta Method (RBW/VBW=100KHz): 57.3 dB , single carrier Mode



Test Mode :	Mode 3	Temperature :	24~25°C
Test Channel :	78	Relative Humidity :	43~44%
Test Engineer :	Kay Wu	Polarization :	Vertical

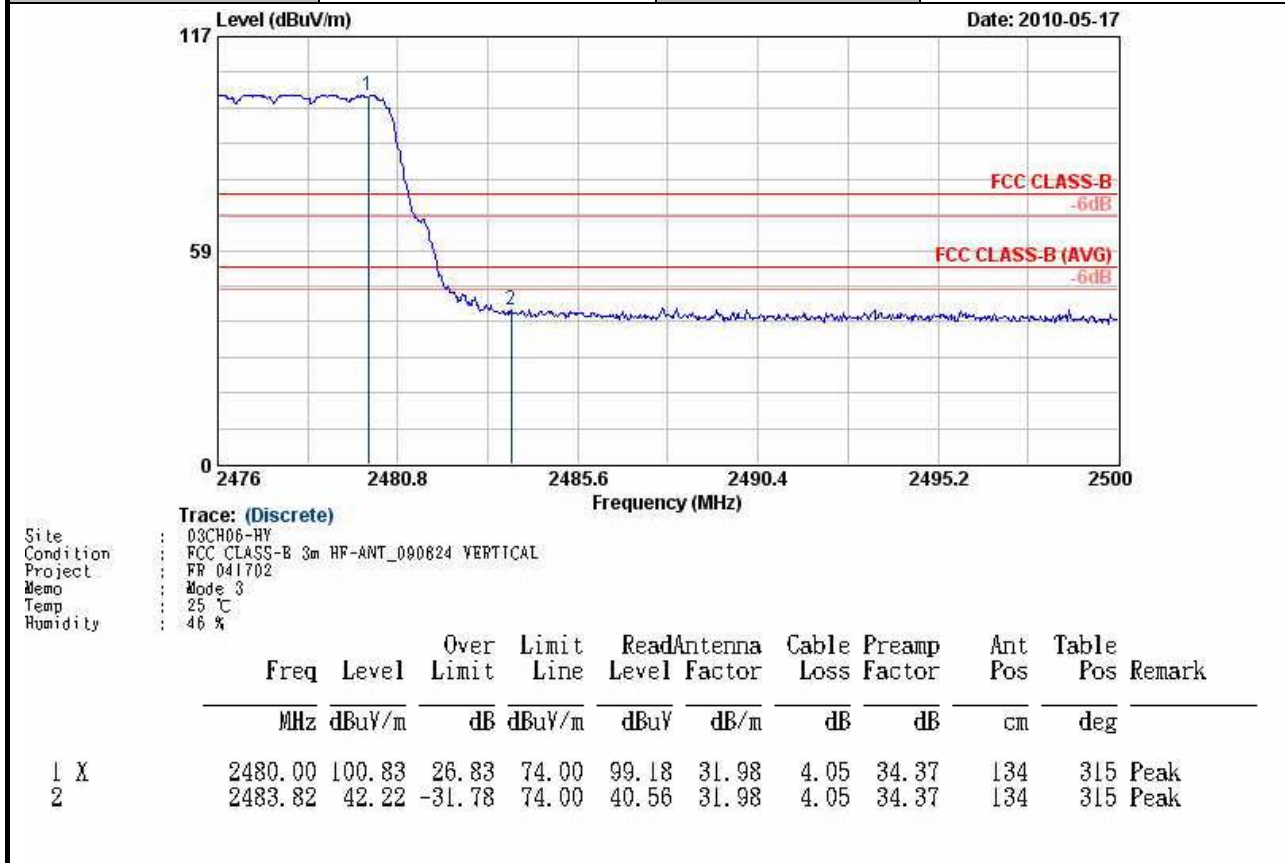

* Marker-Delta Method (RBW/VBW=100KHz): 58.61 dB , Hopping Mode



3.6.6 Test Result of Conducted Band Edges

Test Mode :	Mode 7 and 9	Temperature :	26~28°C
Test Channel :	00 and 78	Relative Humidity :	44~47%
		Test Engineer :	Andy Yeh

Low Band Edge Plot on Channel 00

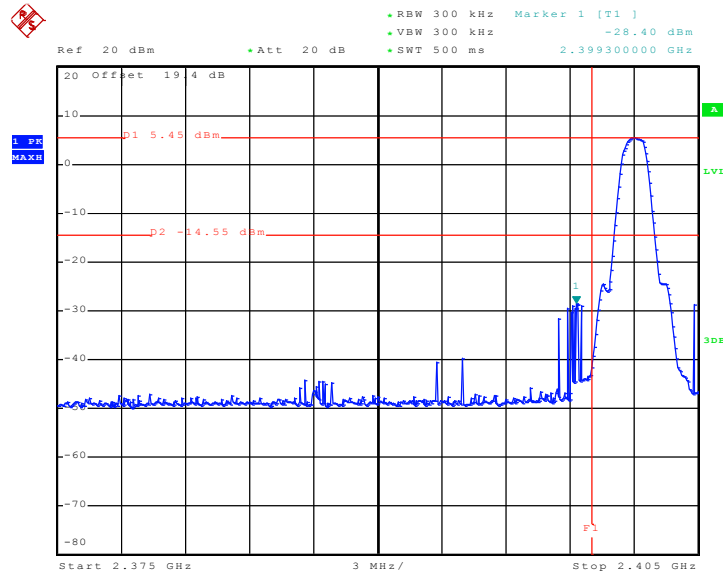

Date: 17.MAY.2010 03:18:47



High Band Edge Plot on Channel 78

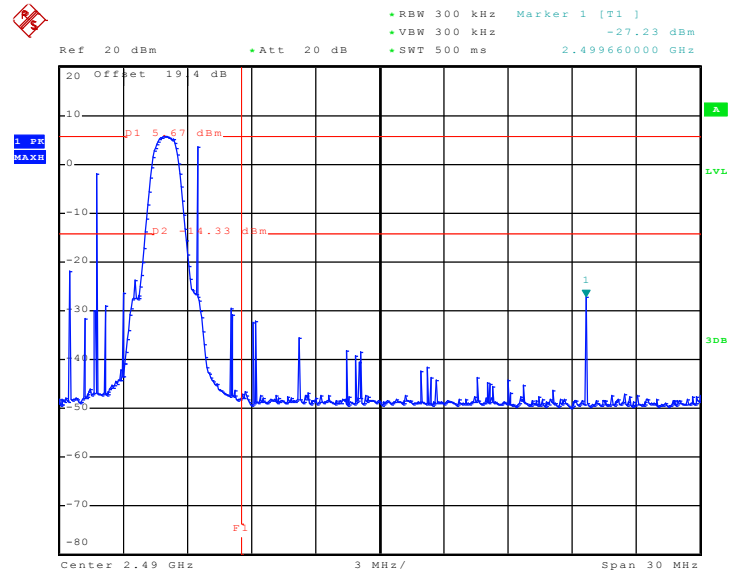

Date: 17.MAY.2010 03:16:51

3.7 Spurious Emission Measurement

3.7.1 Limit of Spurious Emission Measurement

All harmonics/spurs must be at least 20 dB down from the highest emission level within the authorized band.

3.7.2 Measuring Instruments

See list of measuring instruments of this test report.

3.7.3 Test Procedure

1. The transmitter output was connected to the spectrum analyzer via a low lose cable.
2. Set RBW = 100 kHz, Video bandwidth (VBW) \geq RBW, scan up through 10th harmonic. All harmonics / spurs must be at least 20 dB down from the highest emission level within the authorized band as measured with a 100 kHz RBW.

3.7.4 Test Setup

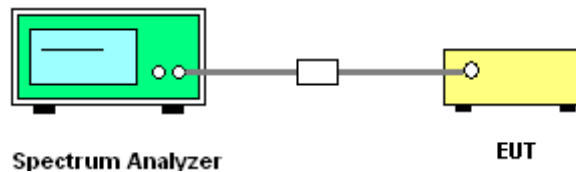



3.7.5 Test Result

Test Mode :	Mode 7	Temperature :	26~28°C
Test Channel :	00	Relative Humidity :	44~47%
		Test Engineer :	Andy Yeh

Conducted Spurious Emission Plot between 9 kHz ~ 3 GHz

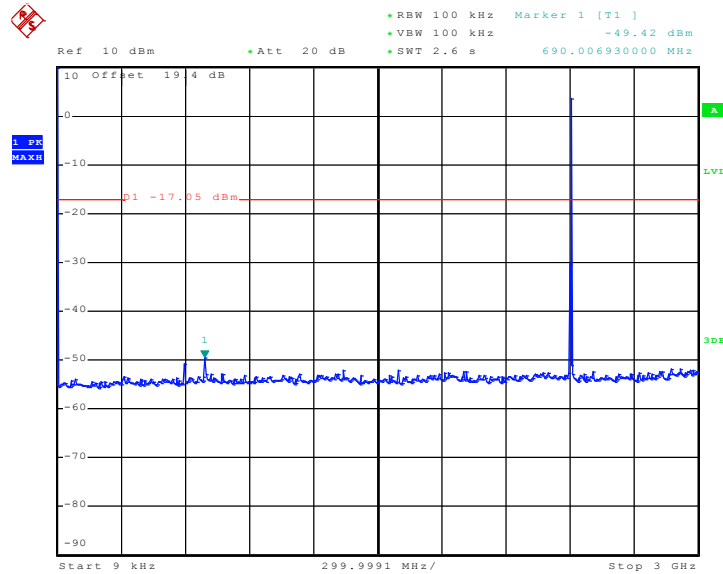

Date: 17.MAY.2010 05:07:20



Conducted Spurious Emission Plot between 1 GHz ~ 25 GHz

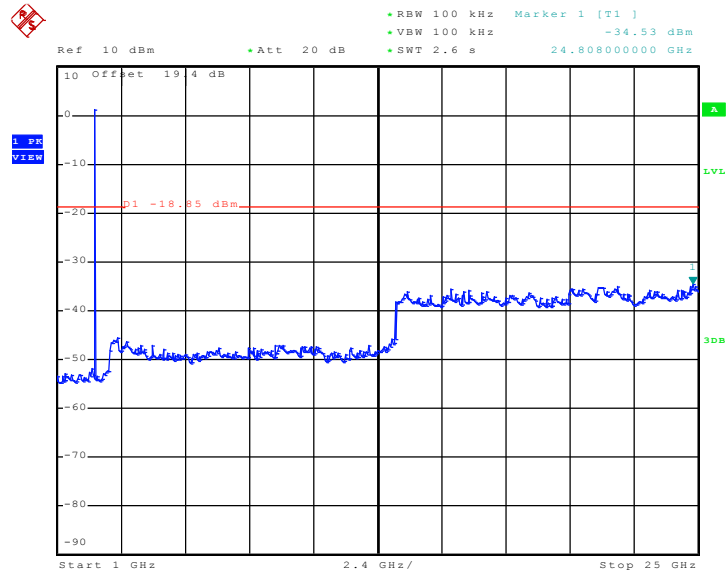

Date: 17.MAY.2010 05:02:12



Test Mode :	Mode 8	Temperature :	26~28°C
Test Channel :	39	Relative Humidity :	44~47%
		Test Engineer :	Andy Yeh

Conducted Spurious Emission Plot between 9 kHz ~ 3 GHz

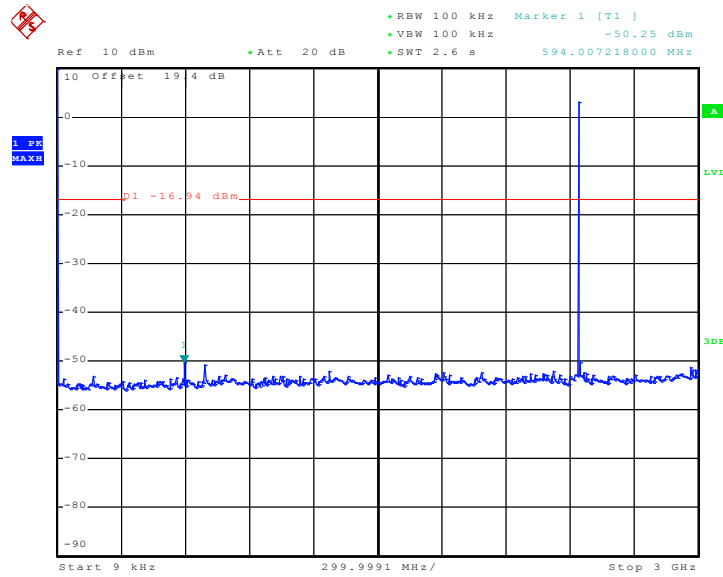

Date: 17.MAY.2010 05:10:46

Conducted Spurious Emission Plot between 1 GHz ~ 25 GHz

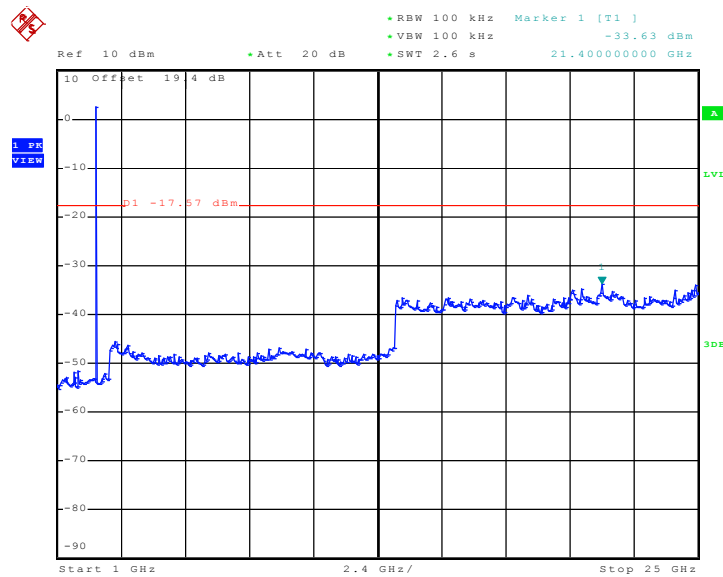

Date: 17.MAY.2010 05:03:15



Test Mode :	Mode 9	Temperature :	26~28°C
Test Channel :	78	Relative Humidity :	44~47%
		Test Engineer :	Andy Yeh

Conducted Spurious Emission Plot between 9 kHz ~ 3 GHz

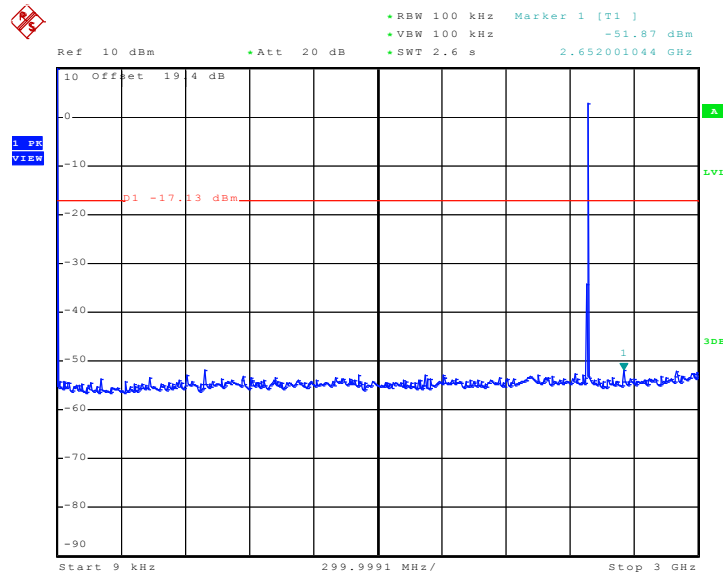

Date: 17.MAY.2010 05:04:07

Conducted Spurious Emission Plot between 1 GHz ~ 25 GHz

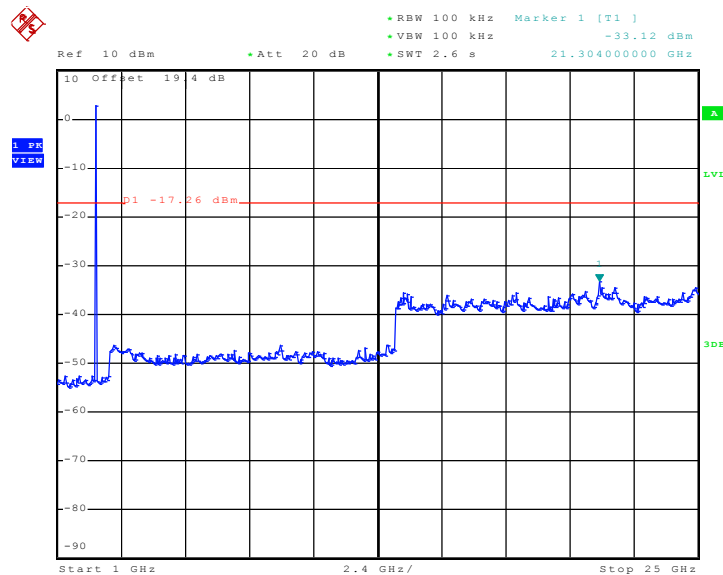

Date: 17.MAY.2010 05:04:39

3.8 AC Conducted Emission Measurement

3.8.1 Limit of AC Conducted Emission

For equipment that is designed to be connected to the public utility (AC) power line, the radio frequency voltage that is conducted back onto the AC power line on any frequency or frequencies within the band 150 kHz to 30 MHz shall not exceed the limits in the following table.

Frequency of emission (MHz)	Conducted limit (dBuV)	
	Quasi-peak	Average
0.15-0.5	66 to 56*	56 to 46*
0.5-5	56	46
5-30	60	50

*Decreases with the logarithm of the frequency.

3.8.2 Measuring Instruments

See list of measuring instruments of this test report.

3.8.3 Test Procedures

1. Please follow the guidelines in ANSI C63.4-2003.
2. The EUT was placed 0.4 meter from the conducting wall of the shielding room was kept at least 80 centimeters from any other grounded conducting surface.
3. Connect EUT to the power mains through a line impedance stabilization network (LISN).
4. All the support units are connecting to the other LISN.
5. The LISN provides 50 ohm coupling impedance for the measuring instrument.
6. The FCC states that a 50 ohm, 50 microhenry LISN should be used.
7. Both sides of AC line were checked for maximum conducted interference.
8. The frequency range from 150 kHz to 30 MHz was searched.
9. Set the test-receiver system to Peak Detect Function and specified bandwidth with Maximum Hold Mode.

3.8.4 Test Setup

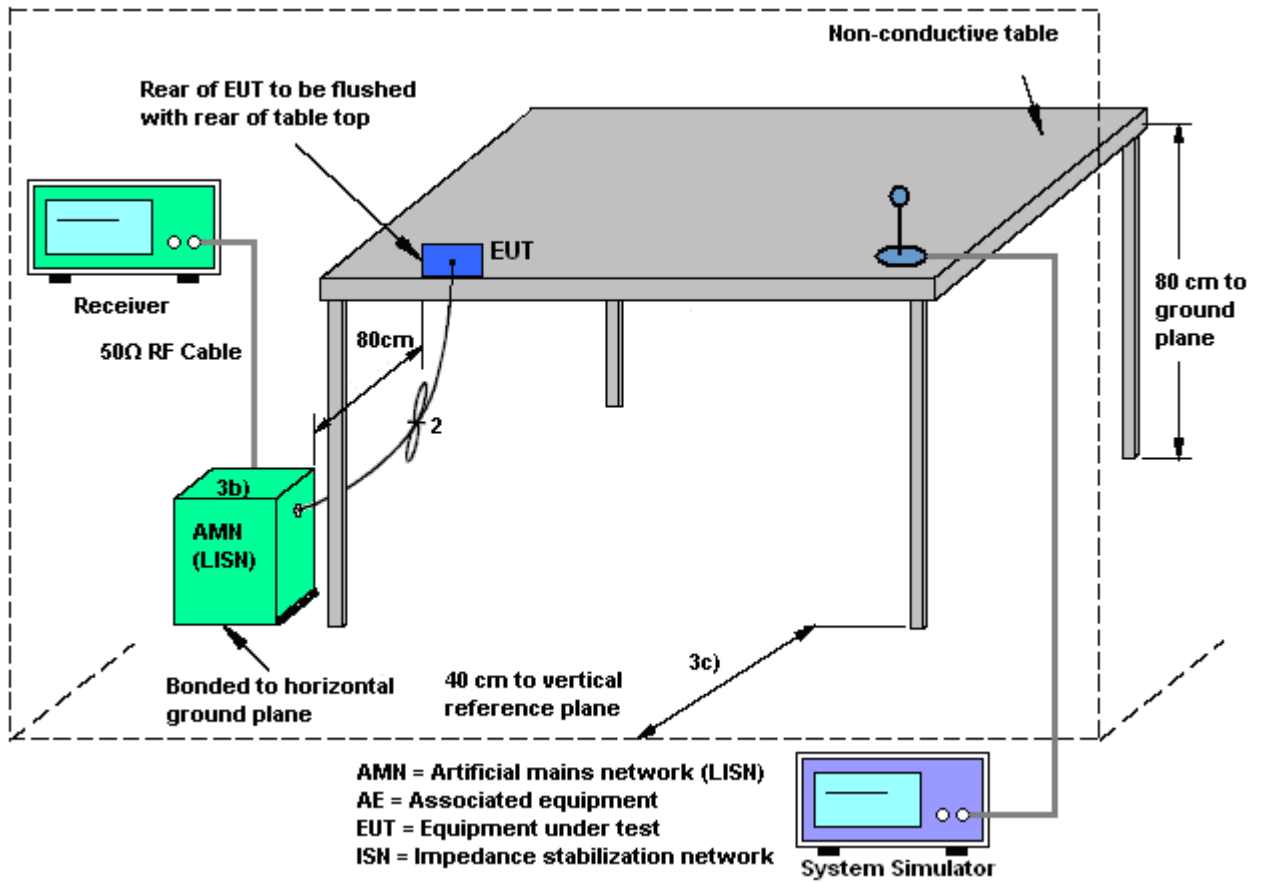

3.8.5 Test Result of AC Conducted Emission

Test Mode :	Mode 1	Temperature :	20~22°C
Test Engineer :	Novic Jiang	Relative Humidity :	34~36%
Test Voltage :	120Vac / 60Hz	Phase :	Line
Function Type :	GSM850 Idle + Bluetooth Link + WLAN Link + Earphone + USB Cable (Charging from Adapter) + Camera		
Remark :	All emissions not reported here are more than 10 dB below the prescribed limit.		

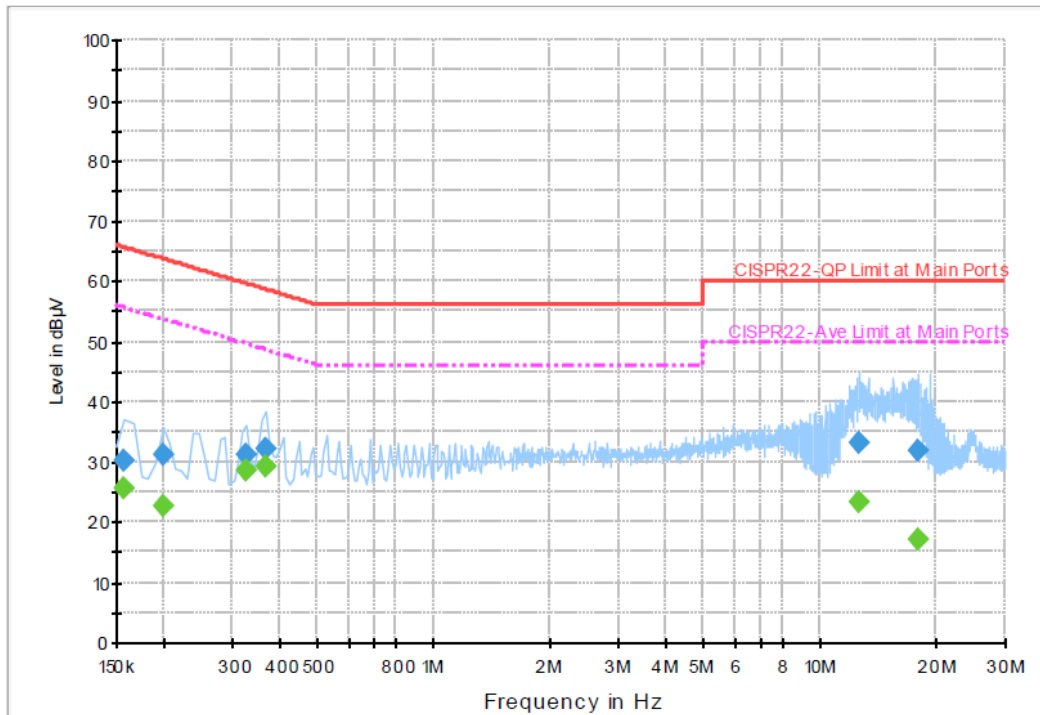

Final Result 1

Frequency (MHz)	QuasiPeak (dBµV)	Filter	Line	Corr. (dB)	Margin (dB)	Limit (dBµV)
0.158000	30.2	Off	L1	19.5	35.4	65.6
0.198000	31.2	Off	L1	19.6	32.5	63.7
0.326000	31.2	Off	L1	19.5	28.4	59.6
0.366000	32.2	Off	L1	19.5	26.4	58.6
12.526000	33.1	Off	L1	19.6	26.9	60.0
17.830000	32.0	Off	L1	19.7	28.0	60.0

Final Result 2

Frequency (MHz)	Average (dBµV)	Filter	Line	Corr. (dB)	Margin (dB)	Limit (dBµV)
0.158000	25.5	Off	L1	19.5	30.1	55.6
0.198000	22.7	Off	L1	19.6	31.0	53.7
0.326000	28.7	Off	L1	19.5	20.9	49.6
0.366000	29.3	Off	L1	19.5	19.3	48.6
12.526000	23.2	Off	L1	19.6	26.8	50.0
17.830000	17.1	Off	L1	19.7	32.9	50.0



Test Mode :	Mode 1	Temperature :	20~22°C
Test Engineer :	Novic Jiang	Relative Humidity :	34~36%
Test Voltage :	120Vac / 60Hz	Phase :	Neutral
Function Type :	GSM850 Idle + Bluetooth Link + WLAN Link + Earphone + USB Cable (Charging from Adapter) + Camera		
Remark :	All emissions not reported here are more than 10 dB below the prescribed limit.		

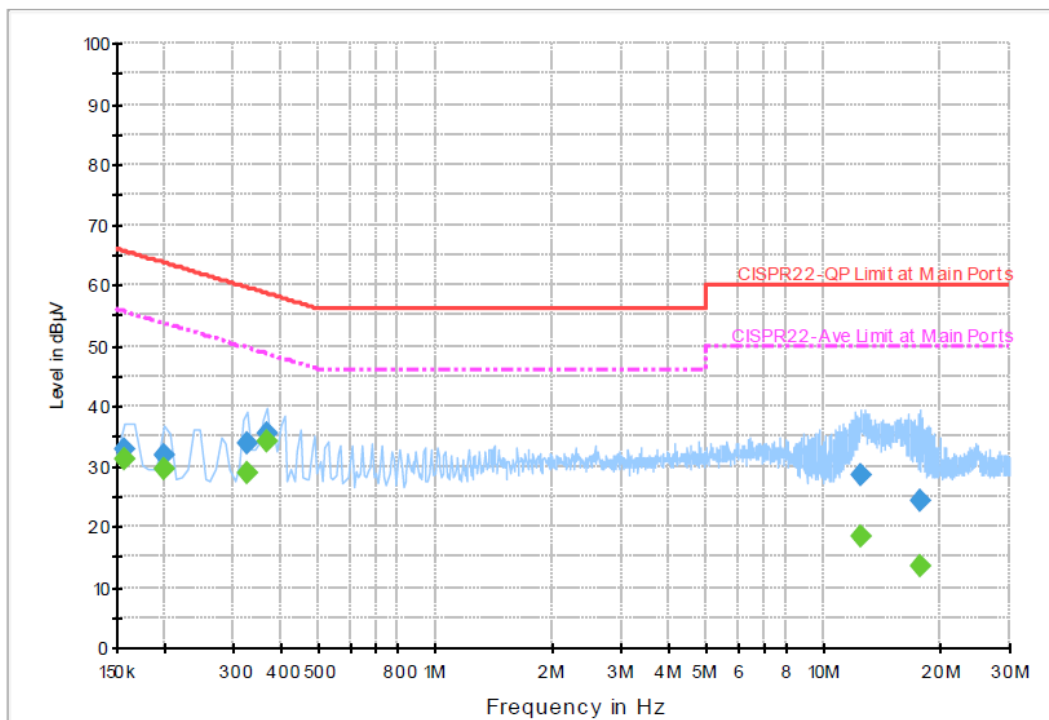

Final Result 1

Frequency (MHz)	QuasiPeak (dBµV)	Filter	Line	Corr. (dB)	Margin (dB)	Limit (dBµV)
0.158000	32.7	Off	N	19.5	32.9	65.6
0.198000	31.7	Off	N	19.5	32.0	63.7
0.326000	33.8	Off	N	19.5	25.8	59.6
0.366000	35.5	Off	N	19.4	23.1	58.6
12.406000	28.5	Off	N	19.6	31.5	60.0
17.734000	24.3	Off	N	19.8	35.7	60.0

Final Result 2

Frequency (MHz)	Average (dBµV)	Filter	Line	Corr. (dB)	Margin (dB)	Limit (dBµV)
0.158000	31.1	Off	N	19.5	24.5	55.6
0.198000	29.5	Off	N	19.5	24.2	53.7
0.326000	28.9	Off	N	19.5	20.7	49.6
0.366000	34.0	Off	N	19.4	14.6	48.6
12.406000	18.4	Off	N	19.6	31.6	50.0
17.734000	13.5	Off	N	19.8	36.5	50.0

3.9 Radiated Emission Measurement

3.9.1 Limit of Radiated Emission

In any 100 kHz bandwidth outside the intentional radiator frequency band, all harmonics/spurious must be at least 20 dB below the highest emission level within the authorized band. In addition, radiated emissions which fall in the restricted bands must also comply with the FCC section 15.209 limits as below.

Frequency (MHz)	Field Strength (microvolts/meter)	Measurement Distance (meters)
0.009 – 0.490	2400/F(kHz)	300
0.490 – 1.705	24000/F(kHz)	30
1.705 – 30.0	30	30
30 – 88	100	3
88 – 216	150	3
216 - 960	200	3
Above 960	500	3

3.9.2 Measuring Instruments

See list of measuring instruments of this test report.

3.9.3 Test Procedures

1. The testing follows the guidelines in FCC Public Notice DA 00-705 Measurement Guidelines.
2. Use the following spectrum analyzer settings:
 - (1) Span = wide enough to fully capture the emission being measured; RBW = 1 MHz for $f \geq 1$ GHz, 100 kHz for $f < 1$ GHz; VBW \geq RBW; Sweep = auto; Detector function = peak; Trace = max hold.
 - (2) Above 18 GHz shall be extrapolated to the specified distance using an extrapolation factor of 20 dB/decade from 3m to 1m.
 Distance extrapolation factor = $20 \log(\text{specific distance [3m]} / \text{test distance [1m]})$ (dB)
3. Follow the guidelines in ANSI C63.4-2003 with respect to maximizing the emission by rotating the EUT, measuring the emission for three EUT orthogonal planes, and adjusting the measurement antenna height and polarization. A pre-amp and a high pass filter are used for this test in order to get the good signal level.

3.9.4 Test Setup

For radiated emissions below 30MHz

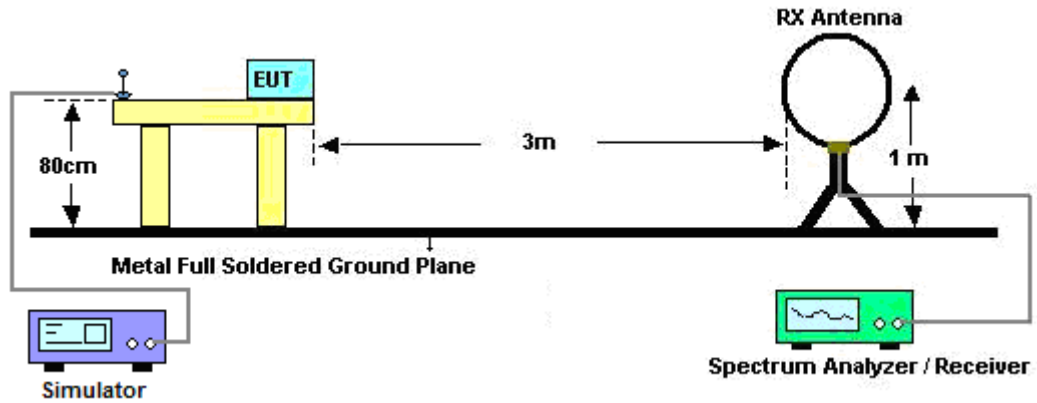

For radiated emissions above 30MHz

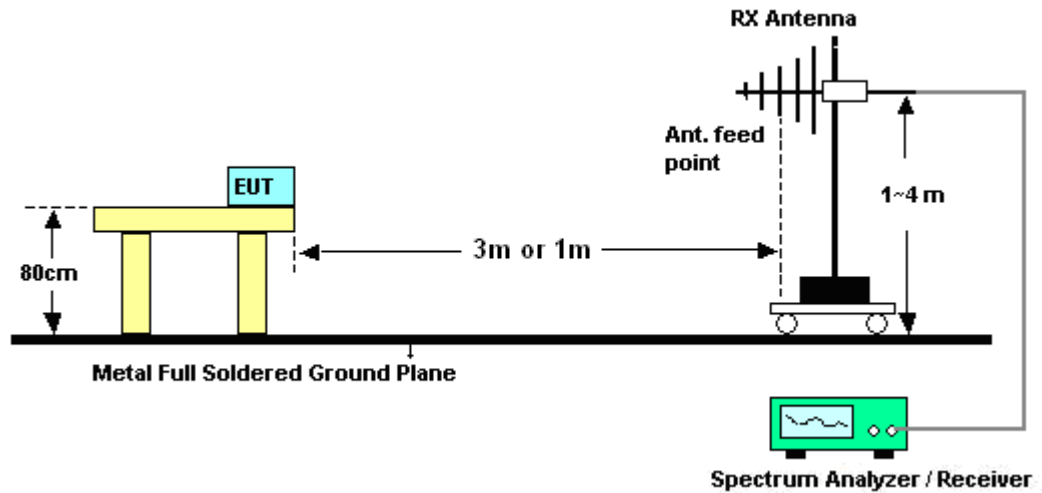



3.9.5 Test Results of Radiated Emissions (9 kHz ~ 30 MHz)

Test Engineer :	Kay Wu	Temperature :	24~25°C	
		Relative Humidity :	43~44%	
Frequency (MHz)	Level (dBuV)	Over Limit (dB)	Limit Line (dBuV)	Remark
-	-	-	-	See Note

Note:

The amplitude of spurious emissions that are attenuated by more than 20dB below the permissible value has no need to be reported.

Distance extrapolation factor = $40 \log(\text{specific distance} / \text{test distance})$ (dB);

Limit line = specific limits (dBuV) + distance extrapolation factor.



3.9.6 Test Result of Radiated Emission (30 MHz ~ 10th Harmonic)

Test Mode :	Mode 1	Temperature :	24~25°C
Test Channel :	00	Relative Humidity :	43~44%
Test Engineer :	Kay Wu	Polarization :	Horizontal
Remark :	2402 MHz is Fundamental Signals which can be ignored.		

Frequency (MHz)	Level (dBuV/m)	Over Limit (dB)	Limit Line (dBuV/m)	Read Level (dBuV)	Antenna Factor (dB)	Cable Loss (dB)	Preamp Factor (dB)	Ant Pos (cm)	Table Pos (deg)	Remark
31.08	17.95	-22.05	40	30.78	17.98	0.85	31.66	-	-	Peak
130.44	17.64	-25.86	43.5	35.76	11.59	1.84	31.55	-	-	Peak
241.14	17.83	-28.17	46	35.46	11.19	2.64	31.46	-	-	Peak
554.8	21.58	-24.42	46	30.86	18.15	4.16	31.59	-	-	Peak
777.4	25.37	-20.63	46	32.01	19.88	5.03	31.55	-	-	Peak
957.3	28.92	-17.08	46	32.92	20.96	5.59	30.55	100	127	Peak
2388.69	35.18	-18.82	54	33.79	31.86	3.92	34.39	100	342	Average
2388.69	48.32	-25.68	74	46.93	31.86	3.92	34.39	100	342	Peak
2402	104.83	-	-	103.42	31.88	3.92	34.39	100	342	Peak
2402	87.21	-	-	85.82	31.86	3.92	34.39	100	342	Average
2494	43.41	-30.59	74	41.73	32	4.05	34.37	100	342	Peak
2494	31.41	-22.59	54	29.73	32	4.05	34.37	100	342	Average
8373	52.63	-21.37	74	43.68	35.72	7.26	34.03	100	284	Peak
8373	39.11	-14.89	54	30.16	35.72	7.26	34.03	100	284	Average



Test Mode :	Mode 1	Temperature :	24~25°C
Test Channel :	00	Relative Humidity :	43~44%
Test Engineer :	Kay Wu	Polarization :	Vertical
Remark :	2402 MHz is Fundamental Signals which can be ignored.		

Frequency (MHz)	Level (dBuV/m)	Over Limit (dB)	Limit Line (dBuV/m)	Read Level (dBuV)	Antenna Factor (dB)	Cable Loss (dB)	Preamp Factor (dB)	Ant Pos (cm)	Table Pos (deg)	Remark
73.74	20.8	-19.2	40	44.21	6.87	1.33	31.61	-	-	Peak
147.18	18.39	-25.11	43.5	37.3	10.52	1.99	31.42	-	-	Peak
241.14	19.57	-26.43	46	37.2	11.19	2.64	31.46	-	-	Peak
584.9	23.82	-22.18	46	32.61	18.53	4.34	31.66	-	-	Peak
812.4	26.18	-19.82	46	32.28	20.15	5.16	31.41	-	-	Peak
957.3	29.61	-16.39	46	33.61	20.96	5.59	30.55	100	227	Peak
2387.14	32.81	-21.19	54	31.42	31.86	3.92	34.39	100	55	Average
2387.14	46.14	-27.86	74	44.75	31.86	3.92	34.39	100	55	Peak
2402	100.41	-	-	99	31.88	3.92	34.39	100	55	Peak
2402	84.97	-	-	83.58	31.86	3.92	34.39	100	55	Average
2486	44.14	-29.86	74	42.48	31.98	4.05	34.37	100	55	Peak
2486	31.48	-22.52	54	29.82	31.98	4.05	34.37	100	55	Average
8094	52.76	-21.24	74	43.49	35.78	7.45	33.96	100	285	Peak
8094	39.89	-14.11	54	30.62	35.78	7.45	33.96	100	285	Average



Test Mode :	Mode 2	Temperature :	24~25°C
Test Channel :	39	Relative Humidity :	43~44%
Test Engineer :	Kay Wu	Polarization :	Horizontal
Remark :	2441 MHz is Fundamental Signals which can be ignored.		

Frequency (MHz)	Level (dBuV/m)	Over Limit (dB)	Limit Line (dBuV/m)	Read Level (dBuV)	Antenna Factor (dB)	Cable Loss (dB)	Preamp Factor (dB)	Ant Pos (cm)	Table Pos (deg)	Remark
31.08	17.95	-22.05	40	30.78	17.98	0.85	31.66	-	-	Peak
130.44	19.64	-23.86	43.5	37.76	11.59	1.84	31.55	-	-	Peak
241.14	17.83	-28.17	46	35.46	11.19	2.64	31.46	-	-	Peak
518.4	21.3	-24.7	46	31.08	17.71	4.03	31.52	-	-	Peak
747.3	25.16	-20.84	46	32.22	19.63	4.93	31.62	-	-	Peak
866.3	26.77	-19.23	46	32.01	20.51	5.36	31.11	100	27	Peak
2350	44.48	-29.52	74	43.25	31.78	3.86	34.41	100	341	Peak
2350	31.84	-22.16	54	30.61	31.78	3.86	34.41	100	341	Average
2441	104.66	-	-	103.12	31.93	3.99	34.38	100	341	Peak
2441	86.9	-	-	85.36	31.93	3.99	34.38	100	341	Average
2500	31.73	-22.27	54	30.05	32	4.05	34.37	100	341	Average
2500	43.2	-30.8	74	41.52	32	4.05	34.37	100	341	Peak
8142	53	-21	74	43.79	35.77	7.42	33.98	100	31	Peak
8142	39.76	-14.24	54	30.55	35.77	7.42	33.98	100	31	Average



Test Mode :	Mode 2	Temperature :	24~25°C
Test Channel :	39	Relative Humidity :	43~44%
Test Engineer :	Kay Wu	Polarization :	Vertical
Remark :	2441 MHz is Fundamental Signals which can be ignored.		

Frequency (MHz)	Level (dBuV/m)	Over Limit (dB)	Limit Line (dBuV/m)	Read Level (dBuV)	Antenna Factor (dB)	Cable Loss (dB)	Preamp Factor (dB)	Ant Pos (cm)	Table Pos (deg)	Remark
31.08	20.53	-19.47	40	33.36	17.98	0.85	31.66	-	-	Peak
54.84	21.69	-18.31	40	43.25	8.85	1.14	31.55	100	228	Peak
200.64	19.46	-24.04	43.5	40.3	8.24	2.4	31.48	-	-	Peak
458.9	19.94	-26.06	46	30.92	16.73	3.79	31.5	-	-	Peak
628.3	24.72	-21.28	46	32.99	18.87	4.51	31.65	-	-	Peak
812.4	27.18	-18.82	46	33.28	20.15	5.16	31.41	-	-	Peak
2324	44.11	-29.89	74	42.94	31.76	3.82	34.41	150	48	Peak
2324	31.74	-22.26	54	30.57	31.76	3.82	34.41	150	48	Average
2441	100.48	-	-	98.94	31.93	3.99	34.38	150	48	Peak
2441	84.95	-	-	83.41	31.93	3.99	34.38	150	48	Average
2484	31.47	-22.53	54	29.81	31.98	4.05	34.37	150	48	Average
2484	44.05	-29.95	74	42.39	31.98	4.05	34.37	150	48	Peak
8481	52.35	-21.65	74	43.53	35.7	7.18	34.06	100	66	Peak
8481	39.42	-14.58	54	30.6	35.7	7.18	34.06	100	66	Average



Test Mode :	Mode 3	Temperature :	24~25°C
Test Channel :	78	Relative Humidity :	43~44%
Test Engineer :	Kay Wu	Polarization :	Horizontal
Remark :	2480 MHz is Fundamental Signals which can be ignored.		

Frequency (MHz)	Level (dBuV/m)	Over Limit (dB)	Limit Line (dBuV/m)	Read Level (dBuV)	Antenna Factor (dB)	Cable Loss (dB)	Preamp Factor (dB)	Ant Pos (cm)	Table Pos (deg)	Remark
49.98	13.28	-26.72	40	32.5	11.28	1.12	31.62	-	-	Peak
130.44	16.64	-26.86	43.5	34.76	11.59	1.84	31.55	-	-	Peak
190.38	17.49	-26.01	43.5	37.96	8.69	2.34	31.5	-	-	Peak
630.4	23.36	-22.64	46	31.61	18.88	4.52	31.65	-	-	Peak
785.8	25.46	-20.54	46	31.98	19.95	5.06	31.53	-	-	Peak
957.3	28.92	-17.08	46	32.92	20.96	5.59	30.55	100	0	Peak
2388	46.88	-27.12	74	45.49	31.86	3.92	34.39	100	350	Peak
2388	32.02	-21.98	54	30.63	31.86	3.92	34.39	100	350	Average
2480	104.52	-	-	102.86	31.98	4.05	34.37	100	350	Peak
2480	87.15	-	-	85.49	31.98	4.05	34.37	100	350	Average
2483.5	69.94	-4.06	74	68.28	31.98	4.05	34.37	100	350	Peak
2483.5	30.14	-23.86	54	28.48	31.98	4.05	34.37	100	350	Average
8121	53	-21	74	43.76	35.78	7.43	33.97	100	117	Peak
8121	39.54	-14.46	54	30.3	35.78	7.43	33.97	100	117	Average



Test Mode :	Mode 3	Temperature :	24~25°C
Test Channel :	78	Relative Humidity :	43~44%
Test Engineer :	Kay Wu	Polarization :	Vertical
Remark :	2480 MHz is Fundamental Signals which can be ignored.		

Frequency (MHz)	Level (dBuV/m)	Over Limit (dB)	Limit Line (dBuV/m)	Read Level (dBuV)	Antenna Factor (dB)	Cable Loss (dB)	Preamp Factor (dB)	Ant Pos (cm)	Table Pos (deg)	Remark
73.74	22.8	-17.2	40	46.21	6.87	1.33	31.61	100	94	Peak
147.18	18.39	-25.11	43.5	37.3	10.52	1.99	31.42	-	-	Peak
200.64	18.46	-25.04	43.5	39.3	8.24	2.4	31.48	-	-	Peak
500.9	20.83	-25.17	46	30.87	17.48	3.97	31.49	-	-	Peak
584.9	23.82	-22.18	46	32.61	18.53	4.34	31.66	-	-	Peak
812.4	26.18	-19.82	46	32.28	20.15	5.16	31.41	-	-	Peak
2388	45.73	-28.27	74	44.34	31.86	3.92	34.39	134	315	Peak
2388	32	-22	54	30.61	31.86	3.92	34.39	134	315	Average
2480	101.1	-	-	99.44	31.98	4.05	34.37	134	315	Peak
2480	85.61	-	-	83.95	31.98	4.05	34.37	134	315	Average
2483.5	67.71	-6.29	74	66.05	31.98	4.05	34.37	134	315	Peak
2483.5	28.31	-25.69	54	26.65	31.98	4.05	34.37	134	315	Average
8118	53.28	-20.72	74	44.04	35.78	7.43	33.97	100	67	Peak
8118	39.74	-14.26	54	30.5	35.78	7.43	33.97	100	67	Average



3.10 Antenna Requirements

3.10.1 Standard Applicable

If directional gain of transmitting antennas is greater than 6dBi, the power shall be reduced by the same level in dB comparing to gain minus 6dBi. The use of a permanently attached antenna or of an antenna that uses a unique coupling to the intentional radiator shall be considered sufficient to comply with the FCC rule.

3.10.2 Antenna Connected Construction

The antennas type used in this product is PIFA Antenna without connector and it is considered to meet antenna requirement.

3.10.3 Antenna Gain

The antenna peak gain of EUT is less than 6 dBi. Therefore, it is not necessary to reduce maximum peak output power limit.



4 List of Measuring Equipment

Instrument	Manufacturer	Model No.	Serial No.	Characteristics	Calibration Date	Due Date	Remark
Spectrum Analyzer	R&S	FSP40	100055	9kHz~40GHz	Jun. 23, 2009	Jun. 22, 2010	Conducted (TH02-HY)
Power Meter	Anritsu	ML2495A	0932001	N/A	Sep. 17, 2009	Sep. 16, 2010	Conducted (TH02-HY)
Power Sensor	Anritsu	MA2411B	0846202	N/A	Sep. 10, 2009	Sep. 09, 2010	Conducted (TH02-HY)
EMI Test Receive	R&S	ESCS 30	100356	9KHz – 2.75GHz	Aug. 05, 2009	Aug. 04, 2010	Conduction (CO05-HY)
Two-LISN	R&S	ENV216	11-100081	9kHz~30MHz	Nov. 30, 2009	Nov. 29, 2010	Conduction (CO05-HY)
Two-LISN	R&S	ENV216	11-100080	9kHz~30MHz	Nov. 23, 2009	Nov. 22, 2010	Conduction (CO05-HY)
AC Power Source	APC	APC-1000W	N/A	N/A	N/A	N/A	Conduction (CO05-HY)
Spectrum Analyzer	Agilent	E4408B	MY442110 30	9KHz-26.5GHz	Oct. 23, 2009	Oct. 22, 2010	Radiation (03CH06-HY)
Spectrum Analyzer	R&S	FSP40	100057	9KHz-40GHz	Oct. 20, 2009	Oct. 19, 2010	Radiation (03CH06-HY)
EMI Test Receiver	R&S	ESVS10	834468/00 3	20MHz-1000MHz	Apr. 28, 2010	Apr. 27, 2011	Radiation (03CH06-HY)
Bilog Antenna	SCHAFFNER	CBL6112B	2885	30MHz -2GHz	Oct. 31, 2009	Oct. 30, 2010	Radiation (03CH06-HY)
Double Ridge Horn Antenna	EMCO	3117	00066583	1GHz~18GHz	Aug. 20, 2009	Aug. 19, 2010	Radiation (03CH06-HY)
Double Ridge Horn Antenna	Training Research	AH-0801	95119	8GHz~18GHz	Nov. 02, 2009	Nov. 01, 2010	Radiation (03CH06-HY)
SHF-EHF Horn Antenna	SCHWARZBECK	BBHA 9170	BBHA9170 251	15GHz- 40GHz	Oct. 14, 2009	Oct. 13, 2010	Radiation (03CH06-HY)
Pre Amplifier	Agilent	8449B	3008A019 17	1GHz- 26.5GHz	Nov. 11, 2009	Nov. 10, 2010	Radiation (03CH06-HY)
Amplifier	Agilent	310N	186713	9KHz~1GHz	Apr. 15, 2010	Apr. 14, 2011	Radiation (03CH06-HY)
Loop Antenna	R&S	HFH2-Z2	860004/00 1	9KHz~30MHz	May 22, 2008	May 21, 2010	Radiation (03CH06-HY)

5 Uncertainty of Evaluation

Uncertainty of Conducted Emission Measurement (150 kHz ~ 30 MHz)

Contribution	Uncertainty of X_i		$u(X_i)$
	dB	Probability Distribution	
Receiver Reading	0.10	Normal (k=2)	0.05
Cable Loss	0.10	Normal (k=2)	0.05
AMN Insertion Loss	2.50	Rectangular	0.63
Receiver Specification	1.50	Rectangular	0.43
Site Imperfection	1.39	Rectangular	0.80
Mismatch	+0.34 / -0.35	U-Shape	0.24
Combined Standard Uncertainty $U_c(y)$	1.13		
Measuring Uncertainty for a Level of Confidence of 95% ($U = 2U_c(y)$)	2.26		

Uncertainty of Radiated Emission Measurement (30 MHz ~ 1000 MHz)

Contribution	Uncertainty of X_i		$u(X_i)$
	dB	Probability Distribution	
Receiver Reading	0.41	Normal (k=2)	0.21
Antenna Factor Calibration	0.83	Normal (k=2)	0.42
Cable Loss Calibration	0.25	Normal (k=2)	0.13
Pre-Amplifier Gain Calibration	0.27	Normal (k=2)	0.14
RCV/SPA Specification	2.50	Rectangular	0.72
Antenna Factor Interpolation for Frequency	1.00	Rectangular	0.29
Site Imperfection	1.43	Rectangular	0.83
Mismatch	+0.39 / -0.41	U-Shape	0.28
Combined Standard Uncertainty $U_c(y)$	1.27		
Measuring Uncertainty for a Level of Confidence of 95% ($U = 2U_c(y)$)	2.54		



Uncertainty of Radiated Emission Measurement (1 GHz ~ 40 GHz)

Contribution	Uncertainty of X_i		$u(X_i)$	C_i	$C_i * u(X_i)$
	dB	Probability Distribution			
Receiver Reading	±0.10	Normal (k=2)	0.10	1	0.10
Antenna Factor Calibration	±1.70	Normal (k=2)	0.85	1	0.85
Cable Loss Calibration	±0.50	Normal (k=2)	0.25	1	0.25
Receiver Correction	±2.00	Rectangular	1.15	1	1.15
Antenna Factor Directional	±1.50	Rectangular	0.87	1	0.87
Site Imperfection	±2.80	Triangular	1.14	1	1.14
Mismatch Receiver VSWR $\Gamma_1 = 0.197$ Antenna VSWR $\Gamma_2 = 0.194$ Uncertainty = $20\text{Log}(1-\Gamma_1*\Gamma_2)$	+0.34 / -0.35	U-Shape	0.244	1	0.244
Combined Standard Uncertainty $U_c(y)$	2.36				
Measuring Uncertainty for a Level of Confidence of 95% ($U = 2U_c(y)$)	4.72				



Appendix A. Photographs of EUT

Please refer to Sporton report number EP041702 as below.