



Willow Run Test Labs, LLC
8501 Beck Road, Building 2227
Belleville, Michigan 48111 USA
Tel: (734) 252 9785
Fax: (734) 926 9785
e-mail: info@wrtest.com

Testing of
Electromagnetic Emissions

per

USA: CFR Title 47, Part 15.231(a,e)
Canada: RSS-210, RSS-GEN

are herein reported for

Schrader Electronics Limited
MW2433A

Test Report No.: 20120709-01
Copyright © 2012

Applicant/Provider:
Schrader Electronics Limited
11 Technology Park, Belfast Road, Antrim Northern Ireland BT41 1QS United Kingdom
Phone: +44 28 9448 3073, Fax: +44 28 9446 8440
Contact Person: Adrian Condon; acondon@schrader.co.uk

Measured by:

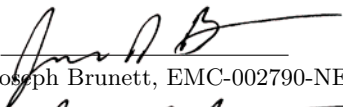
Dr. Joseph Brunett, EMC-002790-NE

Report Approved by:

Dr. Joseph Brunett, EMC-002790-NE

Report by:

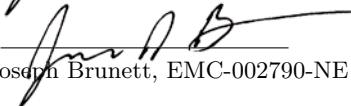
Dr. Joseph Brunett, EMC-002790-NE

Report Date of Issue:

July 9, 2012

Results of equipment under test (EUT) testing completed before July 9, 2012 are as follows.

Emissions The transmitter fundamental emission meets the regulatory limit(s) by no less than 5.6 dB. Transmit chain spurious harmonic emissions comply by no less than 3.8 dB.

Contents

| | | |
|----------|---|----------|
| 1 | Test Specifications, General Procedures, and Location | 3 |
| 1.1 | Test Specification and General Procedures | 3 |
| 1.2 | Test Location and Equipment Used | 4 |
| 2 | Configuration and Identification of the Equipment Under Test | 5 |
| 2.1 | Description and Declarations | 5 |
| 2.1.1 | EUT Configuration | 5 |
| 2.1.2 | Modes of Operation | 5 |
| 2.1.3 | Variants | 6 |
| 2.1.4 | Test Samples | 6 |
| 2.1.5 | Functional Exerciser | 6 |
| 2.1.6 | Modifications Made | 6 |
| 2.1.7 | Production Intent | 6 |
| 2.1.8 | Declared Exemptions and Additional Product Notes | 6 |
| 3 | Emissions | 7 |
| 3.1 | General Test Procedures | 7 |
| 3.1.1 | Radiated Test Setup and Procedures | 7 |
| 3.1.2 | Conducted Emissions Test Setup and Procedures | 9 |
| 3.1.3 | Power Supply Variation | 9 |
| 3.1.4 | Thermal Variation | 9 |
| 3.2 | Intentional Emissions | 10 |
| 3.2.1 | Fundamental Emission Pulsed Operation | 10 |
| 3.2.2 | Fundamental Emission Bandwidth | 13 |
| 3.2.3 | Fundamental Emission | 14 |
| 3.3 | Unintentional Emissions | 15 |
| 3.3.1 | Transmit Chain Spurious Emissions | 15 |

List of Tables

| | | |
|---|---|----|
| 1 | Willow Run Test Labs, LLC Equipment List. | 4 |
| 2 | EUT Declarations. | 5 |
| 3 | Pulsed Emission Characteristics (Duty Cycle). | 10 |
| 4 | Intentional Emission Bandwidth. | 13 |
| 5 | Fundamental Radiated Emissions. | 14 |
| 6 | Transmit Chain Spurious Emissions. | 15 |

List of Figures

| | | |
|---|---|----|
| 1 | Photos of EUT. | 5 |
| 2 | EUT Test Configuration Diagram. | 6 |
| 3 | Radiated Emissions Diagram of the EUT. | 7 |
| 4 | Radiated Emissions Test Setup Photograph(s). | 8 |
| 5 | Pulsed Emission Characteristics (Duty Cycle). | 11 |
| 5 | Pulsed Emission Characteristics (Duty Cycle). | 12 |
| 6 | Intentional Emission Bandwidth. | 13 |

1 Test Specifications, General Procedures, and Location

1.1 Test Specification and General Procedures

The ultimate goal of Schrader Electronics Limited is to demonstrate that the EUT complies with the Rules and/or Directives below. Detailed in this report are the results of testing the Schrader Electronics Limited MW2433A for compliance to:

| Country/Region | Rules or Directive | Referenced Section(s) |
|----------------|-----------------------------|--------------------------------|
| United States | Code of Federal Regulations | CFR Title 47, Part 15.231(a,e) |
| Canada | Industry Canada | RSS-210, RSS-GEN |

In association with the rules and directives outlined above, the following specifications and procedures are followed herein.

| | |
|-----------------|--|
| ANSI C63.4-2003 | "Methods of Measurement of Radio-Noise Emissions from Low-Voltage Electrical and Electronic Equipment in the Range of 9 kHz to 40 GHz" |
| Industry Canada | "The Measurement of Occupied Bandwidth" |

1.2 Test Location and Equipment Used

Test Location The EUT was fully tested at **Willow Run Test Labs, LLC**, 8501 Beck Road, Building 2227, Belleville, Michigan 48111 USA. The **Open Area Test Site (OATS)** description and attenuation characteristics are on file with the FCC Laboratory, Columbia, Maryland (FCC Reg. No: 688478) and with Industry Canada, Ottawa, ON (File Ref. No: IC 8719A-1).

Test Equipment Pertinent test equipment used for measurements at this facility is listed in Table 1. The quality system employed at Willow Run Test Labs, LLC has been established to ensure all equipment has a clearly identifiable classification, calibration expiry date, and that all calibrations are traceable to the SI through NIST, other recognized national laboratories, accepted fundamental or natural physical constants, ratio type of calibration, or by comparison to consensus standards.

Table 1: Willow Run Test Labs, LLC Equipment List.

| Description | Manufacturer/Model | SN | Quality Number | Last Cal By / Date Due |
|--|--------------------|------------|--------------------|--------------------------|
| Antennas | | | | |
| Shielded Loop (9 kHz - 50 MHz) | EMCO/6502 | 2855 | UMLOOP1 | UMRL / July-2012 |
| Dipole Set (20 MHz - 1000 MHz) | EMCO/3121C | 9504-1121 | DIPEMC001 | Liberty Labs / Sept-2012 |
| Bicone (20 MHz - 250 MHz) | JEF | 1 | BICJEF001 | UMRL / July-2012 |
| Bicone (200 MHz - 1000 MHz) | JEF | 1 | SBICJEF001 | UMRL / July-2012 |
| Log-Periodic Array (200 MHz - 1000 MHz) | JEF/Isbell | 1 | LOGJEF001 | UMRL / July-2012 |
| Ridge-Horn Antenna | Univ. of Michigan | 5 | UMHORN005 | UMRL / July-2012 |
| L-Band | JEF | | HRNL001 | JEF / July-2012* |
| LS-Band Horns | JEF/NRL | 001, 002 | HRN15001, HRN15002 | JEF / July-2012* |
| S-Band Horns | Scientific-Atlanta | 1854 | HRNSB001 | JEF / July-2012* |
| C-Band | JEF/NRL | 1 | HRNC001 | JEF / July-2012* |
| XN-Band Horns | JEF/NRL | 001, 002 | HRNXN001, HRNXN002 | JEF / July-2012* |
| X-Band Horns | JEF/NRL | 001, 002 | HRNXB001, HRNXB002 | JEF / July-2012* |
| Ku-Band Horns | JEF/NRL | 001, 002 | HRNKU001, HRNKU002 | JEF / July-2012* |
| Ka-Band Horns | JEF/NRL | 001, 002 | HRNKA001, HRNKA002 | JEF / July-2012* |
| Receiver's / Spectrum Analyzers | | | | |
| Spectrum Analyzer | HP/8593E | 3649A02722 | HP8593E001 | DTI / Sept-2012 |
| Signal Generators | | | | |
| Tracking Generator | HP/8593E | 3649A02722 | HP8593E001 | DTI / Sept-2012 |
| Line Impedance Stabilization Networks | | | | |
| LISN | EMCO | 9304-2081 | LISNEM001 | JEF / Jan-2013 |

* Verification Only - Standard Gain Horn Antennas

2 Configuration and Identification of the Equipment Under Test

2.1 Description and Declarations

The EUT is a wireless tire pressure and temperature sensor. The equipment under test (EUT) is approximately 7 x 8 x 1.5 cm (with stem) in dimension, and is depicted in Figure 1. It is powered by a 3 VDC Lithium cell battery. In use, this device is permanently affixed as the valve-stem in the tire of a motor vehicle. Table 2 outlines provider declared EUT specifications.

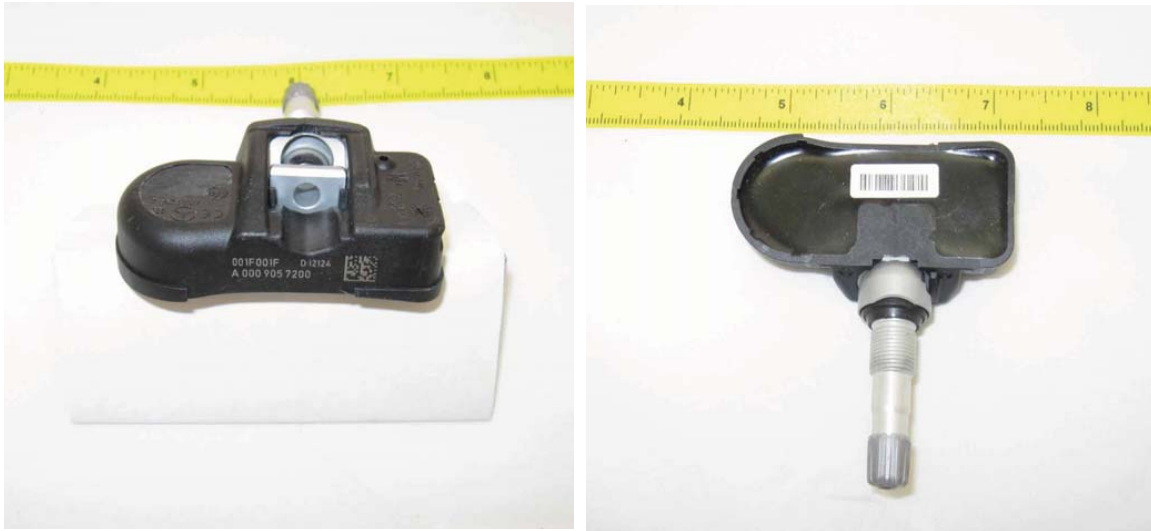

Figure 1: Photos of EUT.

Table 2: EUT Declarations.

| General Declarations | | | |
|----------------------------|----------------------|----------------------------|---|
| Equipment Type: | TPMS | Country of Origin: | UK |
| Nominal Supply: | 3 VDC | Oper. Temp Range: | -40° C to +85° C |
| Frequency Range: | 433.92 MHz | Antenna Dimension: | 60 mm |
| Antenna Type: | Tire Stem (monopole) | Antenna Gain: | -18.3 dBi (declared) |
| Number of Channels: | One (1) | Channel Spacing: | Not Applicable |
| Alignment Range: | 433.9 ± 0.1 MHz | Type of Modulation: | ASK |
| United States | | | |
| FCC ID Number: | MRXMW2433A | Classification: | DSC |
| Canada | | | |
| IC Number: | 2546A-MW2433A | Classification: | Remote Control Device, Vehicular Device |

2.1.1 EUT Configuration

The EUT is configured for testing as depicted in Figure 2.

2.1.2 Modes of Operation

The EUT is capable of three key modes of operation. Upon manually activated LF interrogation (through the use of special LF tool at a vehicle dealership), the EUT responds with a single transmission containing a number of frames used to configure the device with the vehicle. When the EUT is placed in the vehicle tire, it can, in the worst case,

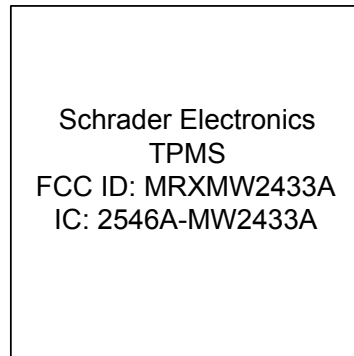

Figure 2: EUT Test Configuration Diagram.

periodically transmit where the duration of each transmission is always less than 1 second and the silent period between transmissions is at least 30 times the duration of the transmission, and never less than 10 seconds. In the case of an emergency condition, the EUT will transmit tire pressure and temperature information throughout the duration of the condition.

2.1.3 Variants

There is only a single variant of the EUT, as tested. Normal samples were actuated for worst case on time, worst case emission bandwidth, and CW mode. Please see the description of operation exhibit supplied with this filing detailing the operating modes of this device.

2.1.4 Test Samples

Three samples in total were provided. Two normal samples capable of normal, test, and CW mode activation. One sample un-potted for testing and photographs.

2.1.5 Functional Exerciser

Not Applicable.

2.1.6 Modifications Made

There were no modifications made to the EUT by this laboratory.

2.1.7 Production Intent

The EUT appears to be a production ready sample.

2.1.8 Declared Exemptions and Additional Product Notes

The EUT is permanently installed in a transportation vehicle. As such, digital emissions are exempt from US and Canadian digital emissions regulations (per FCC 15.103(a) and IC correspondence on ICES-003).

The EUT also employs some modes of operation that alert the vehicle user of sudden changes in tire pressure. Such alert modes fall under FCC 15.231(a)(4), and may operate during the pendency of the alarm condition. A detailed list of all operating modes is included in the Description of Operation exhibit included in this application.

3 Emissions

3.1 General Test Procedures

3.1.1 Radiated Test Setup and Procedures

Radiated electromagnetic emissions from the EUT are first evaluated in our shielded fully anechoic chamber. Spectrum and modulation characteristics of all emissions are recorded, and emissions above 1 GHz are fully characterized. The anechoic chamber contains a set-up similar to that of our outdoor 3-meter site, with a turntable and antenna mast. Instrumentation, including spectrum analyzers and other test equipment as detailed in Section 1.2 are employed. After indoor pre-scans, emission measurements up to 1 GHz are made on our outdoor 3-meter Open Area Test Site (OATS). If the EUT connects to auxiliary equipment and is table or floor standing, the configurations prescribed in ANSI C63.4 / CISPR 22 are followed. Alternatively, a layout closest to normal use (as declared by the provider) is employed if the resulting emissions appear to be worst-case in such a configuration. See Figure 3.

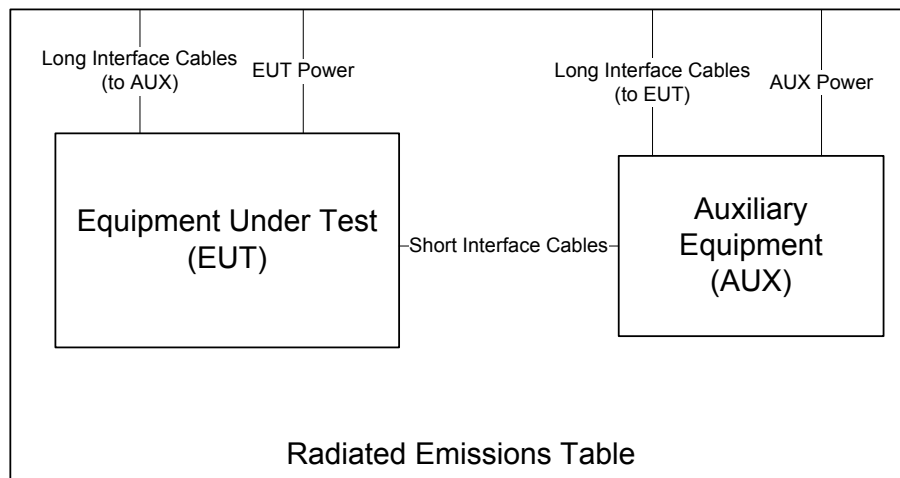

Figure 3: Radiated Emissions Diagram of the EUT.

All intentionally radiating elements are placed on the test table lying flat, on their side, and on their end (3-axes) and the resulting worst case emissions are recorded. For both horizontal and vertical polarizations, the test antenna is raised and lowered from 1 to 4 m in height until a maximum emission level is detected. The EUT is then rotated through 360° in azimuth until the highest emission is detected. The test antenna is then raised and lowered one last time from 1 to 4 m and the worst case value is recorded. Photographs of the test setup employed are depicted in Figure 4.

If the EUT exhibits spurious emissions due to internal receiver circuitry, such emissions are measured with an appropriate carrier signal applied. For devices with intentional emissions below 30 MHz, a shielded loop antenna is used as the test antenna. It is placed at a 1 meter receive height and appropriate low frequency magnetic field extrapolation to the regulatory limit distance is employed. Emissions between 30 MHz and 1 GHz are measured using tuned dipoles and/or calibrated broadband antennas. Emissions above 1 GHz are characterized using standard gain horn antennas. Care is taken to ensure that test receiver resolution and video bandwidths meet the regulatory requirements, and that the emission bandwidth of the EUT is not reduced.

Where regulations allow for direct measurement of field strength, power values (dBm) measured on the test receiver / analyzer are converted to dB μ V/m at the regulatory distance, using

$$E_{dist} = 107 + P_R + K_A - K_G + K_E - C_F$$

where P_R is the power recorded on spectrum analyzer, in dBm, K_A is the test antenna factor in dB/m, K_G is the combined pre-amplifier gain and cable loss in dB, K_E is duty correction factor (when applicable) in dB, and C_F is a distance conversion (employed only if limits are specified at alternate distance) in dB. This field strength value is then compared with the regulatory limit. If effective isotropic radiated power (EIRP) is compute, it is computed as

$$EIRP(dBm) = E_{3m}(dB\mu V/m) - 95.2.$$

When presenting data at each frequency, the highest measured emission under all possible EUT orientations (3-axes) is reported.



Figure 4: Radiated Emissions Test Setup Photograph(s).

3.1.2 Conducted Emissions Test Setup and Procedures

Battery Power Conducted Spurious The EUT is not subject to power line conducted emissions measurements when it is powered solely by its internal battery.

3.1.3 Power Supply Variation

Tests at extreme supply voltages are made if required by the the procedures specified in the test standard, and results of this testing are detailed in this report.

In the case the EUT is designed for operation from a lead-acid battery power source, the extreme test voltages are evaluated between 90% and 130% of the nominal battery voltage declared by the manufacturer. For float charge applications using gel-cell type batteries, extreme test voltages are evaluated between 85% and 115% of the nominal battery voltage declared. For all battery operated equipment, worst case intentional and spurious emissions are re-checked employing a new (fully charged) battery.

3.1.4 Thermal Variation

Tests at extreme temperatures are made if required by the procedures specified in the test standard, and results of this testing are detailed in this report. The provider has declared that the EUT is designed for operation over the temperature range -40°C to $+85^{\circ}\text{C}$. Before any temperature measurements are made, the equipment is allowed to reach a thermal balance in the test chamber, temperature and humidity are recorded, and thermal balance is verified via a thermocouple based probe.

3.2 Intentional Emissions

3.2.1 Fundamental Emission Pulsed Operation

The details and results of testing the EUT for pulsed operation are summarized in Table 3. Plots showing the measurements made to obtain these values are provided in Figure 5.

Table 3: Pulsed Emission Characteristics (Duty Cycle).

| | | | |
|-----------------|---------------------|------------------------|-----------------------|
| Detector | IF Bandwidth | Video Bandwidth | Test Date: |
| Pk | 1 MHz | 3 MHz | 9-Jul-12 |
| | | | Test Engineer: |
| | | | Joseph Brunett |
| | | | Meas Distance: |
| | | | 10 cm |

| FCC/IC | | | | | | | | | |
|--------|---|----------------------------|--------------------|---------------------------------|--------------------------------|------------------------|---|---------------------|------|
| # | EUT Test Mode* | Overall Transmission | | | Internal Frame Characteristics | | | Computed Duty Cycle | |
| | | Min. Repetition Rate (sec) | Max. No. of Frames | Total Transmission Length (sec) | Max. Frame Length (ms) | Min. Frame Period (ms) | Frame Encoding | (%) | (dB) |
| 1 | LF Activated "LEARN" mode. See Figure (a) | Single | 36 | 4.625 | 16.7000 | 100.0 | Each ASK frame is less than 16.7 ms in duration with no less than 100 ms period. Frames consist of one 0.4888 ms wake pulse, four 0.130 ms sync pulses, a 0.2496 ms lead pulse, followed by 62 Manchester encoded bits with a maximum bit width of 0.130ms. | 9.32 | <-20 |
| 2 | Worst-case Rolling Mode. See Figure (b) | 36 | 6 | 0.75 | 16.7000 | 100.0 | same as above | 9.32 | <-20 |

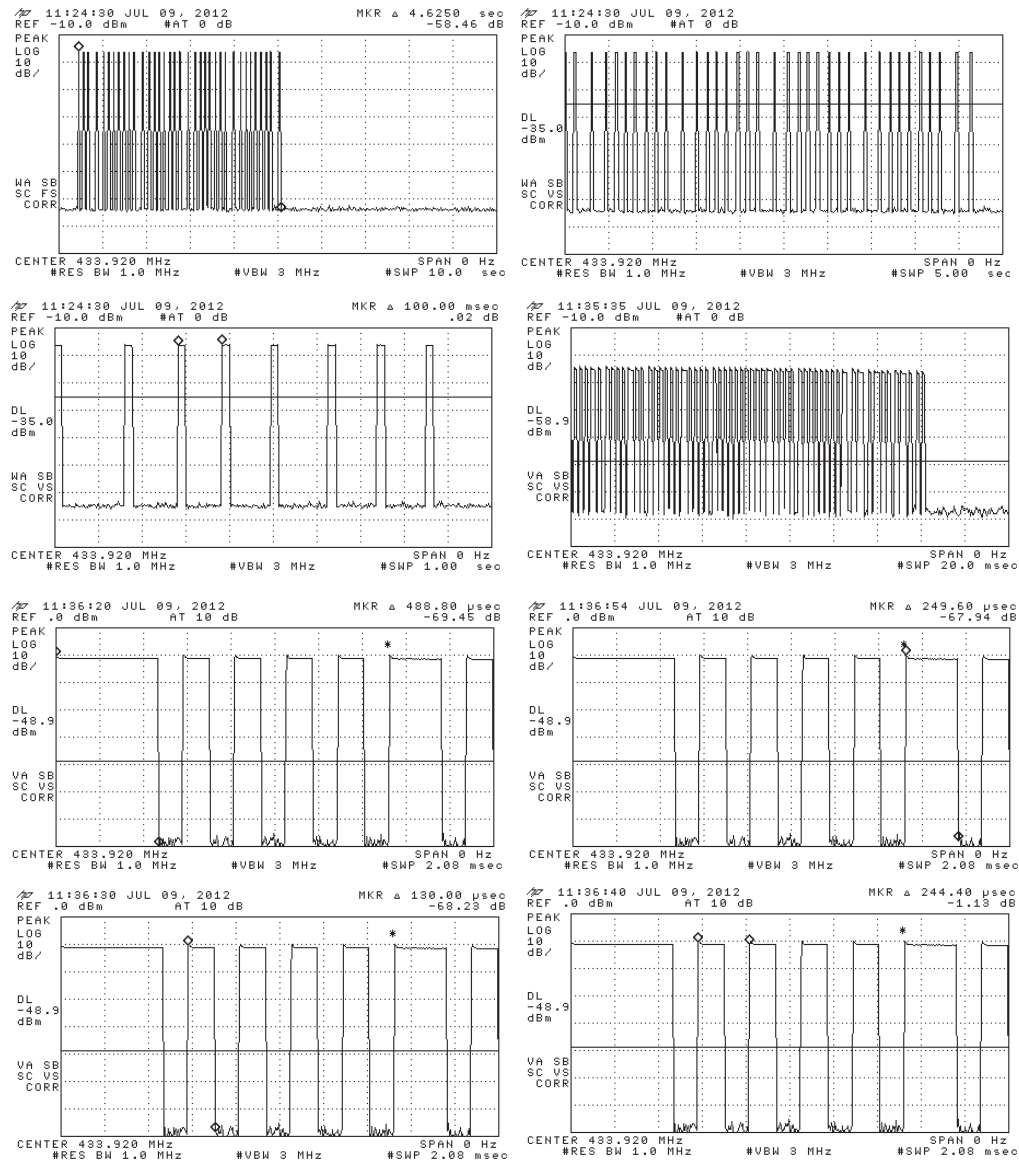

Figure 5(a): Pulsed Emission Characteristics (Duty Cycle).

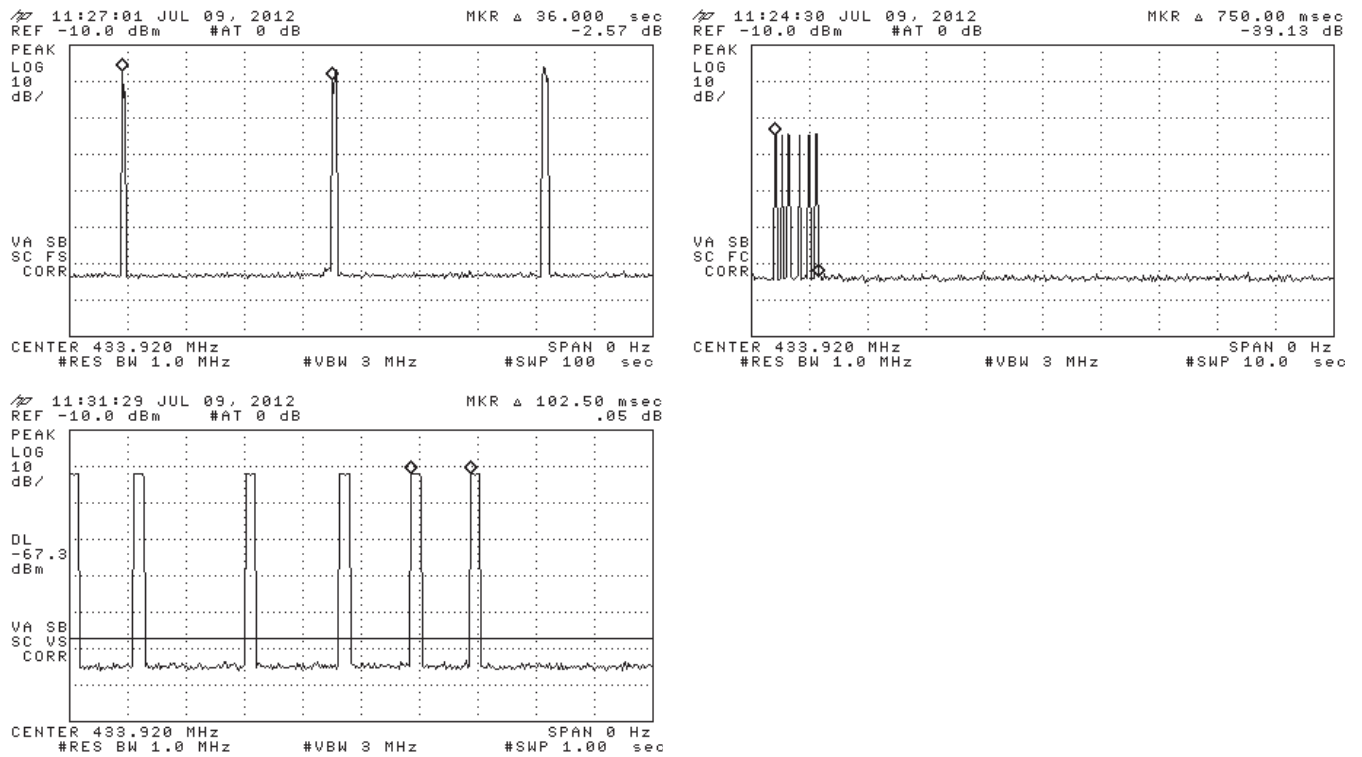

Figure 5(b): Pulsed Emission Characteristics (Duty Cycle).

3.2.2 Fundamental Emission Bandwidth

Emission bandwidth (EBW) of the EUT is measured with the device placed in the test mode(s) with the shortest available frame length and minimum frame spacing. Radiated emissions are recorded following the test procedures listed in Section 1.1. The 20 dB EBW is measured as the max-held peak-detected signal when the IF bandwidth is greater than or equal to 1% of the receiver span. For complex modulations other than ASK and FSK, the 99% emission bandwidth per IC test procedures has a different result, and is also separately reported. The results of EBW testing are summarized in Table 4. Plots showing measurements employed to obtain the emission bandwidth reported are provided in Figure 6.

Table 4: Intentional Emission Bandwidth.

| | | | | | | | | | | | | | | | |
|---|---------------------|------------------------|------------------------|----|--------|--------|--|-------------------|-----------|-----------------------|----------------|------------------|-----------|------------------------|-------|
| <table border="0"> <tr> <td>Detector</td> <td>IF Bandwidth</td> <td>Video Bandwidth</td> </tr> <tr> <td>Pk</td> <td>10 kHz</td> <td>30 kHz</td> </tr> </table> | Detector | IF Bandwidth | Video Bandwidth | Pk | 10 kHz | 30 kHz | <table border="0"> <tr> <td>Test Date:</td> <td>15-Mar-12</td> </tr> <tr> <td>Test Engineer:</td> <td>Joseph Brunett</td> </tr> <tr> <td>EUT Mode:</td> <td>Modulated</td> </tr> <tr> <td>Meas. Distance:</td> <td>10 cm</td> </tr> </table> | Test Date: | 15-Mar-12 | Test Engineer: | Joseph Brunett | EUT Mode: | Modulated | Meas. Distance: | 10 cm |
| Detector | IF Bandwidth | Video Bandwidth | | | | | | | | | | | | | |
| Pk | 10 kHz | 30 kHz | | | | | | | | | | | | | |
| Test Date: | 15-Mar-12 | | | | | | | | | | | | | | |
| Test Engineer: | Joseph Brunett | | | | | | | | | | | | | | |
| EUT Mode: | Modulated | | | | | | | | | | | | | | |
| Meas. Distance: | 10 cm | | | | | | | | | | | | | | |

| FCC/IC | | | | | | | |
|--------|------|------------------------|-----------------|-----------------|--|--|--|
| # | Mode | Center Frequency (MHz) | 20 dB EBW (MHz) | EBW Limit (MHz) | | | |
| 1 | ASK | 433.9 | 0.060 | 1.08475 | | | |
| 2 | | | | | | | |

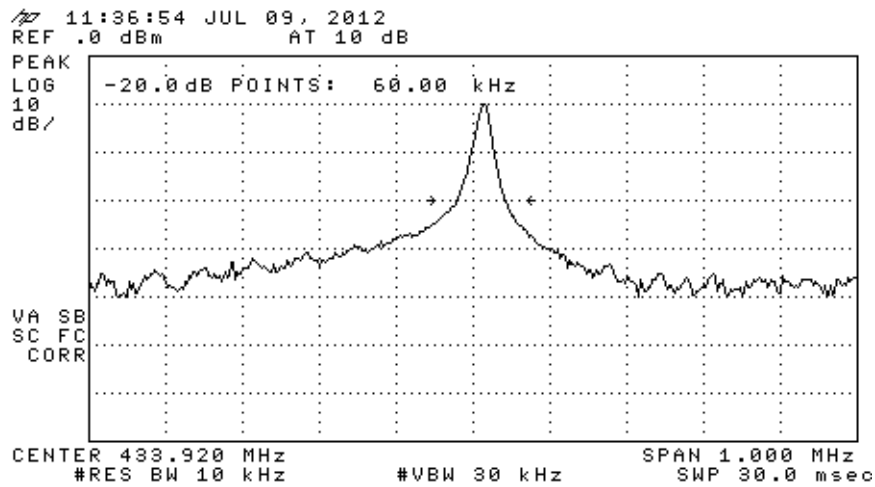

Figure 6: Intentional Emission Bandwidth.

3.2.3 Fundamental Emission

Following the test procedures listed in Section 1.1, radiated emissions measurements are made on the EUT for both Horizontal and Vertical polarized fields. Table 5 details the results of these measurements.

Table 5: Fundamental Radiated Emissions.

| | | | | | |
|------------------------|------------|---------------------|------------------------|------------------------|----------------|
| Frequency Range | Det | IF Bandwidth | Video Bandwidth | Test Date: | 15-Jun-12 |
| 25 MHz ≤ f ≤ 1 000 MHz | Pk/QPk | 120 kHz | 300 kHz | Test Engineer: | Joseph Brunett |
| f > 1 000 MHz | Pk | 3 MHz | 3MHz | EUT Mode: | CW |
| f > 1 000 MHz | Avg | 3 MHz | 10kHz | Leas. Distance: | 3 meters |

| FCC/IC | | | | | | | | | | | | |
|--------|------------------------|-------------------|-----------|------------------------|---------------|---------|-------|---------------|----------------|----------------------------|------------|-----------------|
| # | Freq. MHz | Ant. Used | Ant. Pol. | Pr (Pk) dBm | Pr (Avg)* dBm | Ka dB/m | Kg dB | E3(Pk) dBµV/m | E3(Avg) dBµV/m | FCC/IC E3(Avg) Lim. dBµV/m | Pass dB | Comments |
| 1 | Sample No.: TX1 | | | | | | | | | | | |
| 2 | 433.9 | Dip | H | -19.7 | -39.7 | 21.5 | 21.5 | 87.3 | 67.3 | 72.9 | 5.6 | (fresh battery) |
| 3 | 433.9 | Dip | V | -20.4 | -40.4 | 21.5 | 21.5 | 86.6 | 66.6 | 72.9 | 6.3 | |
| 4 | | | | | | | | | | | | |
| 5 | | | | | | | | | | | | |
| 6 | | | | | | | | | | | | |
| # | Freq. MHz | DC Supply Voltage | | Relative Pr (Pk) dBm** | | | | | | | | |
| 7 | 433.9 | 2.50 | | -42.1 | | | | | | | | |
| 8 | 433.9 | 2.75 | | -40.5 | | | | | | | | |
| 9 | 433.9 | 3.00 | | -40.0 | | | | | | | | |
| 10 | 433.9 | 3.25 | | -39.5 | | | | | | | | |
| 11 | 433.9 | 3.50 | | -38.3 | | | | | | | | |

*Avg data computed from Peak Measured Data and EUT Duty Cycle. EUT in CW mode.

** EUT in CW mode.

3.3 Unintentional Emissions

3.3.1 Transmit Chain Spurious Emissions

The results for the measurement of transmit chain spurious emissions at the nominal voltage and temperature are provided in Table 6. Measurements are performed to 10 times the highest fundamental operating frequency.

Table 6: Transmit Chain Spurious Emissions.

| | | | | | |
|------------------------|------------|---------------------|------------------------|------------------------|----------------|
| Frequency Range | Det | IF Bandwidth | Video Bandwidth | Test Date: | 15-Jun-12 |
| 25 MHz ≤ f ≤ 1 000 MHz | Pk/QPk | 120 kHz | 300 kHz | Test Engineer: | Joseph Brunett |
| f > 1 000 MHz | Pk | 1 MHz | 3 MHz | EUT Mode: | CW |
| f > 1 000 MHz | Avg | 1 MHz | 10kHz | Meas. Distance: | 3 meters |

| Transmitter Unintentional Spurious Emissions | | | | | | | | | | | | FCC/IC |
|--|--------------------|-----------|-----------|-------------|---------------|---------|-------|---------------|----------------|---------------------------|------------|---------------------|
| # | Freq. MHz | Ant. Used | Ant. Pol. | Pr (Pk) dBm | Pr (Avg)* dBm | Ka dB/m | Kg dB | E3(Pk) dBμV/m | E3(Avg) dBμV/m | FCC/IC E3lim (Avg) dBμV/m | Pass dB | Comments |
| 1 | Sample# Tx1 | | | | | | | | | | | |
| 2 | 867.8 | Dip | H | -52.3 | -72.3 | 27.8 | 18.1 | 64.4 | 44.4 | 52.9 | 8.5 | flat (IFBW = 3 kHz) |
| 3 | 867.8 | Dip | V | -59.7 | -79.7 | 27.8 | 18.1 | 57.0 | 37.0 | 52.9 | 15.9 | end (IFBW = 3 kHz) |
| 4 | 1301.7 | R-Horn | H | -33.9 | -53.9 | 20.7 | 23.7 | 70.2 | 50.2 | 54.0 | 3.8 | max all |
| 5 | 1735.6 | R-Horn | H | -53.2 | -73.2 | 21.9 | 30.7 | 45.0 | 25.0 | 54.0 | 29.0 | max all |
| 6 | 2169.5 | R-Horn | H | -55.4 | -75.4 | 22.9 | 31.0 | 43.5 | 23.5 | 54.0 | 30.5 | max all |
| 7 | 2603.4 | R-Horn | H | -64.5 | -84.5 | 24.1 | 29.5 | 37.1 | 17.1 | 54.0 | 36.9 | max all |
| 8 | 3037.3 | R-Horn | H | -60.5 | -80.5 | 25.5 | 27.9 | 44.1 | 24.1 | 54.0 | 29.9 | max all |
| 9 | 3471.2 | R-Horn | H | -68.2 | -88.2 | 26.8 | 26.4 | 39.3 | 19.3 | 54.0 | 34.7 | max all |
| 10 | 3905.1 | R-Horn | H | -66.7 | -86.7 | 28.1 | 24.8 | 43.7 | 23.7 | 54.0 | 30.3 | max all |
| 11 | 4339.0 | R-Horn | H | -79.1 | -99.1 | 29.5 | 22.9 | 34.4 | 14.4 | 54.0 | 39.6 | max all, noise |
| 12 | | | | | | | | | | | | |
| 13 | | | | | | | | | | | | |
| 14 | | | | | | | | | | | | |
| 15 | | | | | | | | | | | | |
| 16 | | | | | | | | | | | | |
| 17 | | | | | | | | | | | | |
| 18 | | | | | | | | | | | | |
| 19 | | | | | | | | | | | | |
| 20 | | | | | | | | | | | | |
| 21 | | | | | | | | | | | | |
| 22 | | | | | | | | | | | | |
| 23 | | | | | | | | | | | | |
| 24 | | | | | | | | | | | | |
| 25 | | | | | | | | | | | | |
| 26 | | | | | | | | | | | | |

*Avg data computed from Peak Measured Data and EUT Duty Cycle. EUT in CW mode.