



Willow Run Test Labs, LLC
8501 Beck Road, Building 2227
Belleville, Michigan 48111 USA
Tel: (734) 252 9785
Fax: (734) 926 9785
e-mail: info@wrtest.com

Testing of
Electromagnetic Emissions

per

USA: CFR Title 47, Part 15.231(a,e)
Canada: RSS-210, RSS-GEN

are herein reported for

Schrader Electronics
GMG2R3FM

Test Report No.: 20111006-01
Copyright © 2011

Applicant/Provider:
Schrader Electronics
11 Technology Park, Belfast Road, Antrim Northern Ireland BT41 1QS
Phone: +44 28 9446 1300, Fax: +44 28 9446 8440
Contact Person: Adrian Condon; acondon@schrader.co.uk

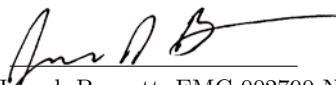
Measured by: 
Dr. Joseph Brunett, EMC-002790-NE

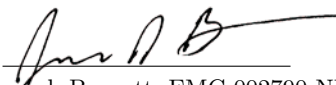
Report Approved by: 
Dr. Joseph Brunett, EMC-002790-NE

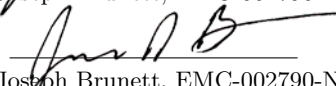
Report by: 
Dr. Joseph Brunett, EMC-002790-NE

Report Date of Issue: October 6, 2011

Results of equipment under test (EUT) testing completed before October 6, 2011 are as follows.

Emissions The transmitter fundamental emission meets the regulatory limit(s) by no less than 4.7 dB. Transmit chain spurious harmonic emissions comply by no less than 8.7 dB.

Contents

1	Test Specifications, General Procedures, and Location	3
1.1	Test Specification and General Procedures	3
1.2	Test Location and Equipment Used	4
2	Configuration and Identification of the Equipment Under Test	5
2.1	Description and Declarations	5
2.1.1	EUT Configuration	5
2.1.2	Modes of Operation	6
2.1.3	Variants	6
2.1.4	Test Samples	6
2.1.5	Functional Exerciser	6
2.1.6	Modifications Made	6
2.1.7	Production Intent	6
2.1.8	Declared Exemptions and Additional Product Notes	6
3	Emissions	7
3.1	General Test Procedures	7
3.1.1	Radiated Test Setup and Procedures	7
3.1.2	Conducted Test Setup and Procedures	9
3.1.3	Power Supply Variation	9
3.1.4	Thermal Variation	9
3.2	Intentional Emissions	10
3.2.1	Fundamental Emission Pulsed Operation	10
3.2.2	Fundamental Emission Bandwidth	11
3.2.3	Fundamental Emission	12
3.3	Unintentional Emissions	13
3.3.1	Transmit Chain Spurious Emissions	13

List of Tables

1	Willow Run Test Labs, LLC Equipment List.	4
2	EUT Declarations.	5
3	Pulsed Emission Characteristics (Duty Cycle).	10
4	Intentional Emission Bandwidth.	11
5	Fundamental Radiated Emissions.	12
6	Transmit Chain Spurious Emissions.	13

List of Figures

1	Photographs of the EUT.	5
2	EUT Test Configuration Diagram.	6
3	Radiated Emissions Diagram of the EUT.	7
4	Radiated Emissions Test Setup Photograph(s).	8
5	Pulsed Emission Characteristics (Duty Cycle).	10
5	Pulsed Emission Characteristics (Duty Cycle).	10
6	Intentional Emission Bandwidth.	11

1 Test Specifications, General Procedures, and Location

1.1 Test Specification and General Procedures

The ultimate goal of Schrader Electronics is to demonstrate that the EUT complies with the Rules and/or Directives below. Detailed in this report are the results of testing the Schrader Electronics GMG2R3FM for compliance to:

Country/Region	Rules or Directive	Referenced Section(s)
United States	Code of Federal Regulations	CFR Title 47, Part 15.231(a,e)
Canada	Industry Canada	RSS-210, RSS-GEN

In association with the rules and directives outlined above, the following specifications and procedures are followed herein.

ANSI C63.4-2003	"Methods of Measurement of Radio-Noise Emissions from Low-Voltage Electrical and Electronic Equipment in the Range of 9 kHz to 40 GHz"
Industry Canada	"The Measurement of Occupied Bandwidth"

1.2 Test Location and Equipment Used

Test Location The EUT was fully tested at **Willow Run Test Labs, LLC**, 8501 Beck Road, Building 2227, Belleville, Michigan 48111 USA. The **Open Area Test Site (OATS)** description and attenuation characteristics are on file with the FCC Laboratory, Columbia, Maryland (FCC Reg. No: 688478) and with Industry Canada, Ottawa, ON (File Ref. No: IC 8719A-1).

Test Equipment Pertinent test equipment used for measurements at this facility is listed in Table 1. The quality system employed at Willow Run Test Labs, LLC has been established to ensure all equipment has a clearly identifiable classification, calibration expiry date, and that all calibrations are traceable to the SI through NIST, other recognized national laboratories, accepted fundamental or natural physical constants, ratio type of calibration, or by comparison to consensus standards.

Table 1: Willow Run Test Labs, LLC Equipment List.

Description	Manufacturer/Model	SN	Quality Number	Last Cal By / Date Due
Antennas				
Shielded Loop (9 kHz - 50 MHz)	EMCO/6502	2855	UMLOOP1	UMRL / July-2012
Dipole Set (20 MHz - 1000 MHz)	EMCO/3121C	9504-1121	DIPEMC001	Liberty Labs / Sept-2012
Bicone (20 MHz - 250 MHz)	JEF	1	BICJEF001	UMRL / July-2012
Bicone (200 MHz - 1000 MHz)	JEF	1	SBICJEF001	UMRL / July-2012
Log-Periodic Array (200 MHz - 1000 MHz)	JEF/Isbell	1	LOGJEF001	UMRL / July-2012
Ridge-Horn Antenna	Univ. of Michigan	5	UMHORN005	UMRL / July-2012
L-Band	JEF		HRNL001	JEF / July-2012*
LS-Band Horns	JEF/NRL	001, 002	HRN15001, HRN15002	JEF / July-2012*
S-Band Horns	Scientific-Atlanta	1854	HRNSB001	JEF / July-2012*
C-Band	JEF/NRL	1	HRNC001	JEF / July-2012*
XN-Band Horns	JEF/NRL	001, 002	HRNXN001, HRNXN002	JEF / July-2012*
X-Band Horns	JEF/NRL	001, 002	HRNXB001, HRNXB002	JEF / July-2012*
Ku-Band Horns	JEF/NRL	001, 002	HRNKU001, HRNKU002	JEF / July-2012*
Ka-Band Horns	JEF/NRL	001, 002	HRNKA001, HRNKA002	JEF / July-2012*
Receiver's / Spectrum Analyzers				
Spectrum Analyzer	HP/8593E	3649A02722	HP8593E001	DTI / Sept-2012
Signal Generators				
Tracking Generator	HP/8593E	3649A02722	HP8593E001	DTI / Sept-2012
Line Impedance Stabilization Networks				
LISN	EMCO	9304-2081	LISNEM001	JEF / Jan-2012

* Verification Only - Standard Gain Horn Antennas

2 Configuration and Identification of the Equipment Under Test

2.1 Description and Declarations

The EUT is a wireless tire pressure and temperature sensor. The equipment under test (EUT) is approximately 6 x 3 x 1.5 cm (without stem) in dimension, and is depicted in Figure 1. It is powered by a 3 VDC Lithium cell battery. In use, this device is permanently affixed as the valve-stem in the tire of a motor vehicle. Table 2 outlines provider declared



Figure 1: Photographs of the EUT.

EUT specifications.

Table 2: EUT Declarations.

General Declarations			
Equipment Type:	TPMS	Country of Origin:	UK
Nominal Supply:	3 VDC	Oper. Temp Range:	-40° C to +85° C
Frequency Range:	315 MHz	Antenna Dimension:	46 mm
Antenna Type:	Tire Stem (monopole)	Antenna Gain:	-5 dBi (declared)
Number of Channels:	One (1)	Channel Spacing:	Not Applicable
Alignment Range:	±0.1 MHz	Type of Modulation:	FSK
United States			
FCC ID Number:	MRXGMG2R3FM	Classification:	DSC
Canada			
IC Number:	2546A-GMG2R3FM	Classification:	Remote Control Device, Vehicular Device

2.1.1 EUT Configuration

The EUT is configured for testing as depicted in Figure 2.

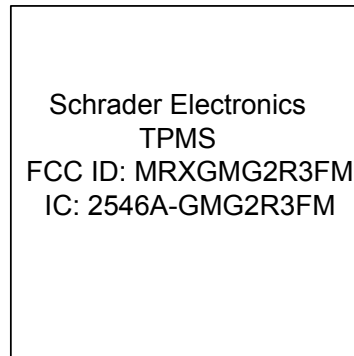

Figure 2: EUT Test Configuration Diagram.

2.1.2 Modes of Operation

The EUT is capable of three key modes of operation. Upon manually activated LF interrogation (through the use of special LF tool at a vehicle dealership), the EUT responds with a single transmission containing a number of frames used to configure the device with the vehicle. When the EUT is placed in the vehicle tire and the vehicle drives, it can, in the worst case, periodically transmit where the duration of each transmission is always less than 1 second and the silent period between transmissions is at least 30 times the duration of the transmission, and never less than 10 seconds. In the case of an emergency condition, the EUT will transmit tire pressure and temperature information throughout the duration of the condition.

2.1.3 Variants

There is only a single variant of the EUT, as tested. Normal samples were actuated for worst case on time, worst case emission bandwidth, and CW mode. Please see the description of operation exhibit supplied with this filing detailing the operating modes of this device.

2.1.4 Test Samples

Three samples in total were provided. Two normal samples capable of normal, test, and CW mode activation. One sample un-potted for testing and photographs.

2.1.5 Functional Exerciser

Not Applicable.

2.1.6 Modifications Made

There were no modifications made to the EUT by this laboratory.

2.1.7 Production Intent

The EUT appears to be a production ready sample.

2.1.8 Declared Exemptions and Additional Product Notes

The EUT is permanently installed in a transportation vehicle. As such, digital emissions are exempt from US and Canadian digital emissions regulations (per FCC 15.103(a) and IC correspondence on ICES-003).

The EUT also employs some modes of operation that alert the vehicle user of sudden changes in tire pressure. Such alert modes fall under FCC 15.231(a)(4), and may operate during the pendency of the alarm condition. A detailed list of all operating modes is included in the Description of Operation exhibit included in this application.

3 Emissions

3.1 General Test Procedures

3.1.1 Radiated Test Setup and Procedures

Radiated electromagnetic emissions from the EUT are first evaluated in our shielded fully anechoic chamber. Spectrum and modulation characteristics of all emissions are recorded, and emissions above 1 GHz are fully characterized. The anechoic chamber contains a set-up similar to that of our outdoor 3-meter site, with a turntable and antenna mast. Instrumentation, including spectrum analyzers and other test equipment as detailed in Section 1.2 are employed. After indoor pre-scans, emission measurements up to 1 GHz are made on our outdoor 3-meter Open Area Test Site (OATS). If the EUT connects to auxiliary equipment and is table or floor standing, the configurations prescribed in ANSI C63.4 / CISPR 22 are followed. Alternatively, a layout closest to normal use (as declared by the provider) is employed if the resulting emissions appear to be worst-case in such a configuration. See Figure 3.

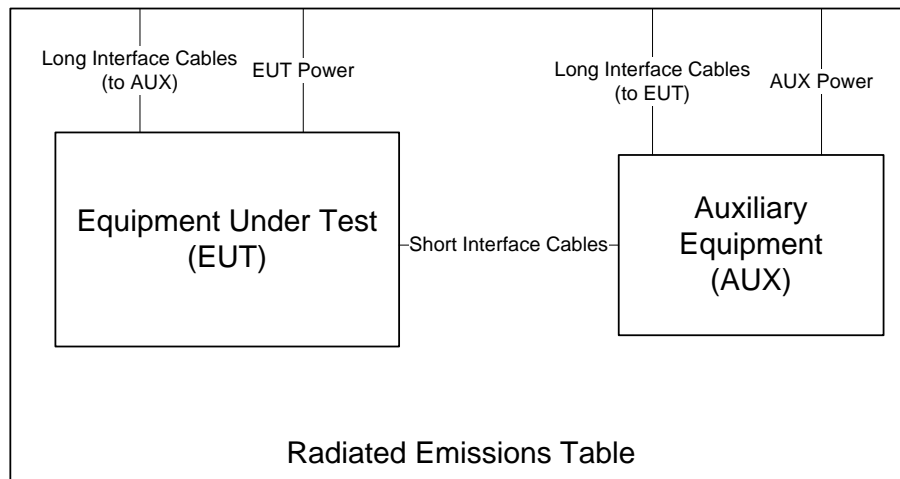

Figure 3: Radiated Emissions Diagram of the EUT.

All intentionally radiating elements are placed on the test table lying flat, on their side, and on their end (3-axes) and the resulting worst case emissions are recorded. For both horizontal and vertical polarizations, the test antenna is raised and lowered from 1 to 4 m in height until a maximum emission level is detected. The EUT is then rotated through 360° in azimuth until the highest emission is detected. The test antenna is then raised and lowered one last time from 1 to 4 m and the worst case value is recorded.

If the EUT exhibits spurious emissions due to internal receiver circuitry, such emissions are measured with an appropriate carrier signal applied. For devices with intentional emissions below 30 MHz, a shielded loop antenna is used as the test antenna. It is placed at a 1 meter receive height and appropriate low frequency magnetic field extrapolation to the regulatory limit distance is employed. Emissions between 30 MHz and 1 GHz are measured using tuned dipoles and/or calibrated broadband antennas. Emissions above 1 GHz are characterized using standard gain horn antennas. Care is taken to ensure that test receiver resolution and video bandwidths meet the regulatory requirements, and that the emission bandwidth of the EUT is not reduced.

Photographs of the test setup employed are depicted in Figure 4.



Figure 4: Radiated Emissions Test Setup Photograph(s).

3.1.2 Conducted Test Setup and Procedures

Battery Power Conducted Spurious The EUT is not subject to power line conducted emissions measurements when it is powered solely by its internal battery.

3.1.3 Power Supply Variation

Tests at extreme supply voltages are made if required by the the procedures specified in the test standard, and results of this testing are detailed in this report.

DC Extreme Voltages If the EUT is designed for operation from a lead-acid battery power source, the extreme test voltages are evaluated between 90% and 130% of the nominal battery voltage declared by the manufacturer. For float charge applications using gel-cell type batteries, extreme test voltages are evaluated between 85% and 115% of the nominal battery voltage declared. For all battery operated equipment, worst case intentional and spurious emissions are re-checked employing a new (fully charged) battery.

3.1.4 Thermal Variation

Tests at extreme temperatures are made if required by the procedures specified in the test standard, and results of this testing are detailed in this report. The provider has declared that the EUT is designed for operation over the temperature range -40° C to $+85^{\circ}$ C. Before any temperature measurements are made, the equipment is allowed to reach a thermal balance in the test chamber, temperature and humidity are recorded, and thermal balance is verified via a thermocouple based probe.

3.2 Intentional Emissions

3.2.1 Fundamental Emission Pulsed Operation

The details and results of testing the EUT for pulsed operation are summarized in Table 3. Plots showing the measurements made to obtain these values are provided in Figure 5.

Table 3: Pulsed Emission Characteristics (Duty Cycle).

FCC/IC									
		Detector	IF Bandwidth	Video Bandwidth	Test Date: 24-Sep-11				
		Pk	1 MHz	3 MHz	Test Engineer: Joseph Brunett				
		Meas Distance: 10 cm							
#	EUT Test Mode*	Overall Transmission			Internal Frame Characteristics			Computed Duty Cycle	
		Min. Repetition Rate (sec)	Max. No. of Frames	Total Transmission Length (sec)	Max. Frame Length (ms)	Min. Frame Period (ms)	Frame Encoding	(%)	(dB)
1	LF Activated "LEARN" mode. See Figure (a)	Single	32	< 1.0	12.7500	100.0	Each FSK frame is 12.75 ms in duration with no less than 100 ms period.	12.75	-17.9
2	Worst-case Rolling Mode. See Figure (b)	30	8	< 1.0	< 25	100.0	same as above	12.75	-17.9

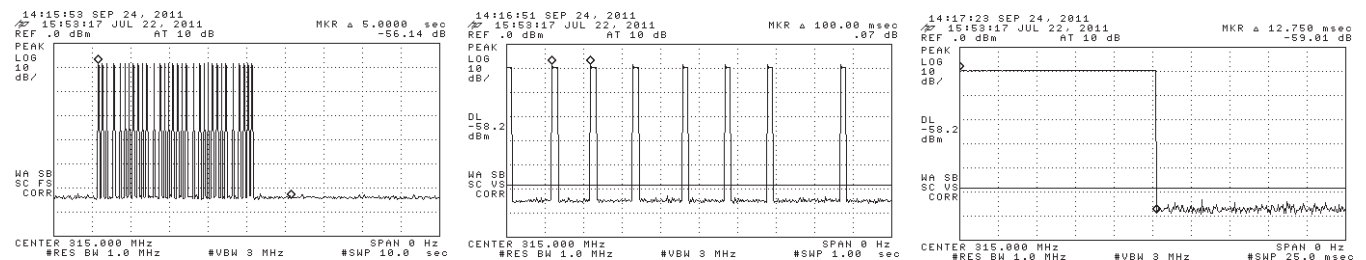

Figure 5(a): Pulsed Emission Characteristics (Duty Cycle).

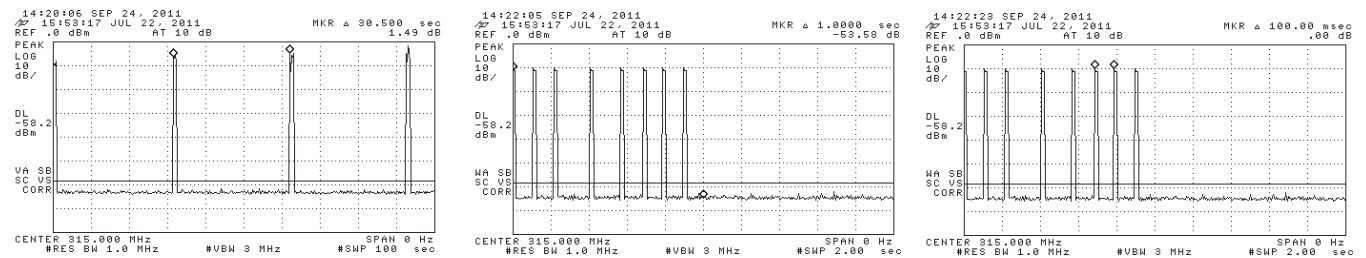

Figure 5(b): Pulsed Emission Characteristics (Duty Cycle).

3.2.2 Fundamental Emission Bandwidth

Emission bandwidth (EBW) of the EUT is measured with the device placed in the test mode(s) with the shortest available frame length and minimum frame spacing. Radiated emissions are recorded following the test procedures listed in Section 1.1. The 20 dB EBW is measured as the max-held peak-detected signal when the IF bandwidth is greater than or equal to 1% of the receiver span. For complex modulations other than ASK and FSK, the 99% emission bandwidth per IC test procedures has a different result, and is also separately reported. The results of EBW testing are summarized in Table 4. Plots showing measurements employed to obtain the emission bandwidth reported are provided in Figure 6.

Table 4: Intentional Emission Bandwidth.

Detector	IF Bandwidth	Video Bandwidth	Test Date: 24-Sep-11
Pk	10 kHz	30 kHz	Test Engineer: Joseph Brunett
			EUT Mode: Modulated
			Meas. Distance: 10 cm

FCC/IC							
#	Mode	Center Frequency (MHz)	20 dB EBW (MHz)	EBW Limit (MHz)			
1	FSK	315	0.092	0.7875			
2							

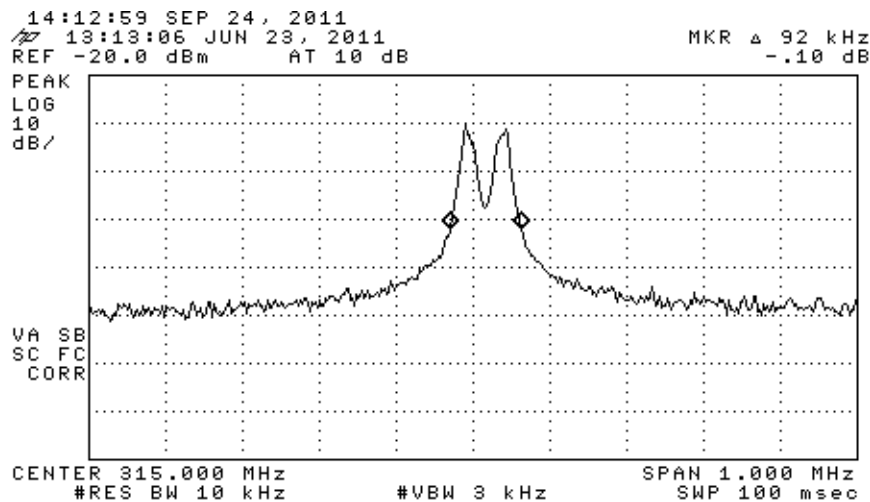

Figure 6: Intentional Emission Bandwidth.

3.2.3 Fundamental Emission

Following the test procedures listed in Section 1.1, radiated emissions measurements are made on the EUT for both Horizontal and Vertical polarized fields. Table 5 details the results of these measurements.

Table 5: Fundamental Radiated Emissions.

Frequency Range	Det	IF Bandwidth	Video Bandwidth	Test Date:	10-Sep-11
25 MHz ≤ f ≤ 1 000 MHz	Pk/QPk	120 kHz	300 kHz	Test Engineer:	Joseph Brunett
f > 1 000 MHz	Pk	3 MHz	3MHz	EUT Mode:	CW
f > 1 000 MHz	Avg	3 MHz	10kHz	Meas. Distance:	3 meters

FCC/IC											
#	Freq. MHz	Ant. Used	Ant. Pol.	Pr (Pk) dBm	Pr (Avg)* dBm	Ka dB/m	Kg dB	E3(Pk) dBμV/m	E3(Avg) dBμV/m	FCC/IC (Avg) E3lim dBμV/m	Pass dB
1	PN: 70503076										
2	315	Dip	H	-23.9	-41.8	18.6	20.8	80.9	63.0	67.7	4.7
3	315	Dip	V	-29.5	-47.4	18.6	20.8	75.3	57.4	67.7	10.3
4											
5											
6											
	Freq. MHz	DC Supply Voltage		Relative Pr (Pk) dBm**							
7	315	2.50		-27.8							
8	315	2.75		-27.4							
9	315	3.00		-26.8							
10	315	3.25		-26.5							
11	315	3.50		-26.4							

*Avg data computed from Peak Measured Data and EUT Duty Cycle. EUT in CW mode.

** EUT in CW mode.

3.3 Unintentional Emissions

3.3.1 Transmit Chain Spurious Emissions

The results for the measurement of transmit chain spurious emissions at the nominal voltage and temperature are provided in Table 6. Measurements are performed to 10 times the highest fundamental operating frequency.

Table 6: Transmit Chain Spurious Emissions.

Frequency Range	Det	IF Bandwidth	Video Bandwidth	Test Date:	10-Sep-11
25 MHz ≤ f ≤ 1 000 MHz	Pk/QPk	120 kHz	300 kHz	Test Engineer:	Joseph Brunett
f > 1 000 MHz	Pk	1 MHz	3 MHz	EUT Mode:	CW
f > 1 000 MHz	Avg	1 MHz	10kHz	Meas. Distance:	3 meters

Transmitter Unintentional Spurious Emissions												FCC/IC
#	Freq. MHz	Ant. Used	Ant. Pol.	Pr (Pk) dBm	Pr (Avg)* dBm	Ka dB/m	Kg dB	E3(Pk) dBμV/m	E3(Avg) dBμV/m	FCC/IC E3lim (Avg) dBμV/m	Pass dB	Comments
1	PN: 70503076											
2	630.0	Dip	H	-73.4	-91.3	24.4	17.6	40.3	22.4	47.7	25.2	flat
3	630.0	Dip	V	-74.1	-92.0	24.4	17.6	39.6	21.7	47.7	25.9	end
4	945.0	Dip	H	-64.5	-82.4	19.3	6.5	55.3	37.4	47.7	10.2	flat
5	945.0	Dip	V	-63.0	-80.9	19.3	6.5	56.8	38.9	47.7	8.7	end
6	1260.0	R-Horn	H	-49.1	-67.0	20.6	22.4	56.1	38.2	54.0	15.8	max all
7	1575.0	R-Horn	H	-44.7	-62.6	21.5	29.2	54.5	36.6	54.0	17.4	max all
8	1890.0	R-Horn	H	-47.4	-65.3	22.2	31.2	50.6	32.7	54.0	21.3	max all
9	2205.0	R-Horn	H	-56.9	-74.8	23.0	30.9	42.1	24.2	54.0	29.7	max all
10	2520.0	R-Horn	H	-63.6	-81.5	23.9	29.8	37.5	19.6	54.0	34.4	max all
11	2835.0	R-Horn	H	-64.9	-82.8	24.8	28.6	38.3	20.4	54.0	33.6	max all
12	3150.0	R-Horn	H	-61.1	-79.0	25.8	27.5	44.2	26.3	54.0	27.6	max all
13												
14												
15												
16												
17												
18												
19												
20												
21												
22												
23												
24												
25												
26												

*Avg data computed from Peak Measured Data and EUT Duty Cycle. EUT in CW mode.