



Willow Run Test Labs, LLC
8501 Beck Road, Building 2227
Belleville, Michigan 48111 USA
Tel: (734) 252-9785
Fax: (734) 926-9785
e-mail: info@wrtest.com

Testing of
Electromagnetic Emissions

per

USA: CFR Title 47, Part 15.231(e)
Canada: IC RSS-210/GENe

are herein reported for

Schrader Electronics
AG6SP3-F, AG6SP3-D

Test Report No.: 20140822-01r1
Copyright © 2014

Applicant/Provider:
Schrader Electronics

11 Technology Park, Belfast Road, Antrim Northern Ireland BT41 1QS United Kingdom
Phone: +44 28 9448 3067, Fax: +44 28 9446 8440
Contact Person: James Kyle; jakyle@schrader.co.uk

Measured by: Joseph Brunett Report Approved by: Joseph Brunett
Dr. Joseph Brunett, EMC-002790-NE Dr. Joseph Brunett, EMC-002790-NE
Report by: Joseph Brunett Report Date of Issue: August 22, 2014
Dr. Joseph Brunett, EMC-002790-NE

Results of testing completed on (or before) August 22, 2014 are as follows.

Emissions: The transmitter intentional emissions **COMPLY** with the regulatory limit(s) by no less than 12.1 dB.
Transmit chain spurious harmonic emissions **COMPLY** by no less than 21.8 dB.

Contents

1	Test Specifications, General Procedures, and Location	3
1.1	Test Specification and General Procedures	3
1.2	Test Location and Equipment Used	4
2	Configuration and Identification of the Equipment Under Test	5
2.1	Description and Declarations	5
2.1.1	EUT Configuration	5
2.1.2	Modes of Operation	5
2.1.3	Variants	6
2.1.4	Test Samples	6
2.1.5	Functional Exerciser	6
2.1.6	Modifications Made	6
2.1.7	Production Intent	6
2.1.8	Declared Exemptions and Additional Product Notes	6
3	Emissions	7
3.1	General Test Procedures	7
3.1.1	Radiated Test Setup and Procedures	7
3.1.2	Conducted Emissions Test Setup and Procedures	9
3.1.3	Power Supply Variation	9
3.1.4	Thermal Variation	9
3.2	Intentional Emissions	10
3.2.1	Fundamental Emission Pulsed Operation	10
3.2.2	Fundamental Emission Bandwidth	13
3.2.3	Fundamental Emission	15
3.3	Unintentional Emissions	16
3.3.1	Transmit Chain Spurious Emissions	16

List of Tables

1	Willow Run Test Labs, LLC Equipment List.	4
2	EUT Declarations.	5
3	Pulsed Emission Characteristics (Duty Cycle).	10
4	Intentional Emission Bandwidth.	13
5	Fundamental Radiated Emissions.	15
6	Transmit Chain Spurious Emissions.	16

List of Figures

1	Photos of EUT.	5
2	EUT Test Configuration Diagram.	6
3	Radiated Emissions Diagram of the EUT.	7
4	Radiated Emissions Test Setup Photograph(s).	8
5	Pulsed Emission Characteristics (Duty Cycle).	11
5	Pulsed Emission Characteristics (Duty Cycle).	12
6	Intentional Emission Bandwidth.	14

1 Test Specifications, General Procedures, and Location

1.1 Test Specification and General Procedures

The ultimate goal of Schrader Electronics is to demonstrate that the Equipment Under Test (EUT) complies with the Rules and/or Directives below. Detailed in this report are the results of testing the Schrader Electronics AG6SP3-F, AG6SP3-D for compliance to:

Country/Region	Rules or Directive	Referenced Section(s)
United States	Code of Federal Regulations	CFR Title 47, Part 15.231(e)
Canada	Industry Canada	IC RSS-210/GENe

In association with the rules and directives outlined above, the following specifications and procedures are followed herein.

ANSI C63.4-2003	"Methods of Measurement of Radio-Noise Emissions from Low-Voltage Electrical and Electronic Equipment in the Range of 9 kHz to 40 GHz"
Industry Canada	"The Measurement of Occupied Bandwidth"

1.2 Test Location and Equipment Used

Test Location The EUT was fully tested by **Willow Run Test Labs, LLC**, 8501 Beck Road, Building 2227, Belleville, Michigan 48111 USA. The Test Facility description and attenuation characteristics are on file with the FCC Laboratory, Columbia, Maryland (FCC Reg. No: 688478) and with Industry Canada, Ottawa, ON (File Ref. No: IC 8719A-1).

Test Equipment Pertinent test equipment used for measurements at this facility is listed in Table 1. The quality system employed at Willow Run Test Labs, LLC has been established to ensure all equipment has a clearly identifiable classification, calibration expiry date, and that all calibrations are traceable to the SI through NIST, other recognized national laboratories, accepted fundamental or natural physical constants, ratio type of calibration, or by comparison to consensus standards.

Table 1: Willow Run Test Labs, LLC Equipment List.

Description	Manufacturer/Model	SN	Quality Number	Last Cal By / Date Due
Antennas				
Shielded Loop (9 kHz - 50 MHz)	EMCO/6502	2855	UMLOOP1	UMRL / July-2015
Dipole Set (20 MHz - 1000 MHz)	EMCO/3121C	9504-1121	DIPEMC001	Liberty Labs / Sept-2016
Bicone (20 MHz - 250 MHz)	JEF	1	BICJEF001	UMRL / July-2015
Bicone (200 MHz - 1000 MHz)	JEF	1	SBICJEF001	UMRL / July-2015
Log-Periodic Array (200 MHz - 1000 MHz)	JEF/Isbell	1	LOGJEF001	UMRL / July-2015
Ridge-Horn Antenna	Univ. of Michigan	5	UMHORN005	UMRL / July-2015
L-Band	JEF		HRNL001	WRTL / July-2015*
LS-Band Horns	JEF/NRL	001, 002	HRN15001, HRN15002	WRTL / July-2015*
S-Band Horns	Scientific-Atlanta	1854	HRNSB001	WRTL / July-2015*
C-Band	JEF/NRL	1	HRNC001	WRTL / July-2015*
XN-Band Horns	JEF/NRL	001, 002	HRNXN001, HRNXN002	WRTL / July-2015*
X-Band Horns	JEF/NRL	001, 002	HRNXB001, HRNXB002	WRTL / July-2015*
Ku-Band Horns	JEF/NRL	001, 002	HRNKU001, HRNKU002	WRTL / July-2015*
Ka-Band Horns	JEF/NRL	001, 002	HRNKA001, HRNKA002	WRTL / July-2015*
Quad-Ridge Horns	Condor AS-48461	C35200	QRH218001	WRTL / July-2015
Analyzers & Generators				
Spectrum Analyzer	HP/8593E	3649A02722	HP8593E001	DTI / Nov-2014
Spectrum Analyzer	R&S/FSV30	101660	RSFSV30001	R&S / Mar-2015
Radio Test Set	R&S/CMU200	100104	RSCMU20001	Not Necessary
Line Impedance Stabilization Networks				
LISN	EMCO	9304-2081	LISNEM001	WRTL / Jan-2015

* Verification Only - Standard Gain Horn Antennas

2 Configuration and Identification of the Equipment Under Test

2.1 Description and Declarations

The equipment under test is a wireless tire pressure and temperature sensor. The EUT is approximately 50 x 70 x 30 mm in dimension, and is depicted in Figure 1. It is powered by a 3 VDC Lithium cell battery. In use, this device is permanently affixed inside the tire of a motor vehicle. Table 2 outlines provider declared EUT specifications.



Figure 1: Photos of EUT.

Table 2: EUT Declarations.

General Declarations			
Equipment Type:	TPMS	Country of Origin:	UK
Nominal Supply:	3 VDC	Oper. Temp Range:	-40° C to +125° C
Frequency Range:	314.6 – 315.4 MHz	Antenna Dimension:	1 cm loop (approx)
Antenna Type:	PCB trace	Antenna Gain:	-27 dBi (approx)
Number of Channels:	1	Channel Spacing:	Not Applicable
Alignment Range:	Not Declared	Type of Modulation:	ASK
United States			
FCC ID Number:	MRXAG6SP3	Classification:	DSC
Canada			
IC Number:	2546A-AG6SP3	Classification:	Remote Control Device, Vehicular Device

2.1.1 EUT Configuration

The EUT is configured for testing as depicted in Figure 2.

2.1.2 Modes of Operation

This device is capable of three key modes of operation. Upon manually activated LF interrogation (through the use of special LF tool at a vehicle dealership), the EUT responds with a single ASK transmission containing a number of frames used to configure the device with the vehicle. When the EUT is placed in the vehicle tire and the vehicle drives, it can, in the worst case, periodically transmit where the duration of each transmission is always less than 1 second and the silent period between transmissions is at least 30 times the duration of the transmission, and never less than 10 seconds. In the case of an emergency condition, the EUT will transmit tire pressure and temperature information throughout the duration of the condition.

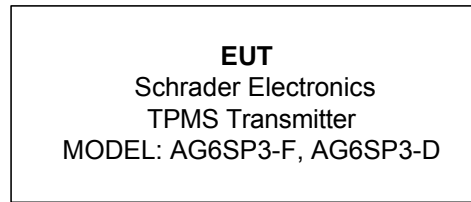

Figure 2: EUT Test Configuration Diagram.

2.1.3 Variants

There are two electrically identical variants of the EUT. Model AG6SP3-F employs a smaller plastic chassis. Model AG6SP3-D employs a slightly larger chassis with a metal ridge molded into it.

2.1.4 Test Samples

Six samples in total were provided. One sample programmed for periodic transmission, one normal operating sample capable of LEARN mode transmissions via LF interrogation, two test samples capable of CW transmission (one for each chassis variant), and two normal samples open for testing and photographs.

2.1.5 Functional Exerciser

Normal operating EUT functionality was verified by observation of transmitted signal.

2.1.6 Modifications Made

There were no modifications made to the EUT by this laboratory.

2.1.7 Production Intent

The EUT appears to be a production ready sample.

2.1.8 Declared Exemptions and Additional Product Notes

The EUT is permanently installed in a transportation vehicle. As such, digital emissions are exempt from US and Canadian digital emissions regulations (per FCC 15.103(a) and IC correspondence on ICES-003).

The EUT also employs some modes of operation that alert the vehicle user of sudden changes in tire pressure. Such alert modes fall under FCC 15.231(a)(4), and may operate during the pendency of the alarm condition. A detailed list of all operating modes is included in the Description of Operation exhibit included in this application.

3 Emissions

3.1 General Test Procedures

3.1.1 Radiated Test Setup and Procedures

Radiated electromagnetic emissions from the EUT are first evaluated in our shielded fully anechoic chamber. Spectrum and modulation characteristics of all emissions are recorded, and emissions above 1 GHz are fully characterized. The anechoic chamber contains a set-up similar to that of our outdoor 3-meter site, with a turntable and antenna mast. Instrumentation, including spectrum analyzers and other test equipment as detailed in Section 1.2 are employed. After indoor pre-scans, emission measurements are made on our outdoor 3-meter Open Area Test Site (OATS). If the EUT connects to auxiliary equipment and is table or floor standing, the configurations prescribed in ANSI C63.4 / CISPR-22 are followed. Alternatively, a layout closest to normal use (as declared by the provider) is employed if the resulting emissions appear to be worst-case in such a configuration. See Figure 3. All

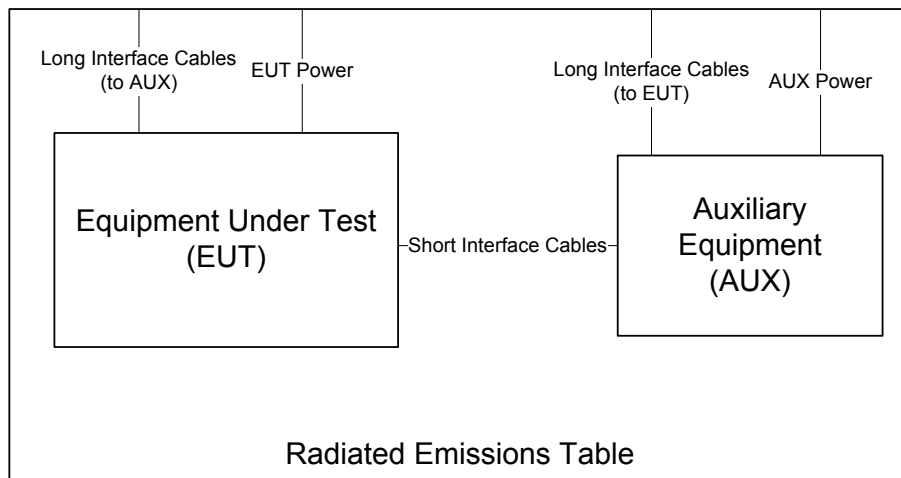

Figure 3: Radiated Emissions Diagram of the EUT.

intentionally radiating elements that are not fixed-mounted in use are placed on the test table lying flat, on their side, and on their end (3-axes) and the resulting worst case emissions are recorded. If the EUT is fixed-mounted in use, measurements are made with the device oriented in the manner consistent with installation and then emissions are recorded.

If the EUT exhibits spurious emissions due to internal receiver circuitry, such emissions are measured with an appropriate carrier signal applied. For devices with intentional emissions below 30 MHz, a shielded loop antenna is used as the test antenna. It is placed at a 1 meter receive height and appropriate low frequency magnetic field extrapolation to the regulatory limit distance is employed. Emissions between 30 MHz and 1 GHz are measured using tuned dipoles and/or calibrated broadband antennas. For both horizontal and vertical polarizations, the test antenna is raised and lowered from 1 to 4 m in height until a maximum emission level is detected. The EUT is then rotated through 360° in azimuth until the highest emission is detected. The test antenna is then raised and lowered one last time from 1 to 4 m and the worst case value is recorded. Emissions above 1 GHz are characterized using standard gain horn antennas or calibrated broadband ridge-horn antennas. Care is taken to ensure that test receiver resolution and video bandwidths meet the regulatory requirements, and that the emission bandwidth of the EUT is not reduced. Photographs of the test setup employed are depicted in Figure 4.

Where regulations allow for direct measurement of field strength, power values (dBm) measured on the test receiver / analyzer are converted to dBμV/m at the regulatory distance, using

$$E_{dist} = 107 + P_R + K_A - K_G + K_E - C_F$$

where P_R is the power recorded on spectrum analyzer, in dBm, K_A is the test antenna factor in dB/m, K_G is the combined pre-amplifier gain and cable loss in dB, K_E is duty correction factor (when applicable) in dB, and C_F is

a distance conversion (employed only if limits are specified at alternate distance) in dB. This field strength value is then compared with the regulatory limit. If effective isotropic radiated power (EIRP) is compute, it is computed as

$$EIRP(dBm) = E_{3m}(dB\mu V/m) - 95.2.$$

When presenting data at each frequency, the highest measured emission under all possible EUT orientations (3-axes) is reported.



Figure 4: Radiated Emissions Test Setup Photograph(s).

3.1.2 Conducted Emissions Test Setup and Procedures

Battery Power Conducted Spurious The EUT is not subject to measurement of power line conducted emissions as it is powered solely by its internal battery.

3.1.3 Power Supply Variation

Tests at extreme supply voltages are made if required by the the procedures specified in the test standard, and results of this testing are detailed in this report.

In the case the EUT is designed for operation from a battery power source, the extreme test voltages are evaluated over the range specified in the test standard; no less than $\pm 10\%$ of the nominal battery voltage declared by the manufacturer. For all battery operated equipment, worst case intentional and spurious emissions are re-checked employing a new (fully charged) battery.

3.1.4 Thermal Variation

Tests at extreme temperatures are made if required by the procedures specified in the test standard, and results of this testing are detailed in this report. The provider has declared that the EUT is designed for operation over the temperature range -40°C to $+125^{\circ}\text{C}$. Before any temperature measurements are made, the equipment is allowed to reach a thermal balance in the test chamber, temperature and humidity are recorded, and thermal balance is verified via a thermocouple based probe.

3.2 Intentional Emissions

3.2.1 Fundamental Emission Pulsed Operation

The details and results of testing the EUT for pulsed operation are summarized in Table 3. Plots showing the measurements made to obtain these values are provided in Figure 5.

Table 3: Pulsed Emission Characteristics (Duty Cycle).

Detector Pk **Span** 0 **IF Bandwidth** 1 MHz **Video Bandwidth** 3 MHz

Test Date: 22-Aug-14
Test Engineer: Joseph Brunett
EUT: Schrader AG6SP3
EUT Mode: Modulated
Meas. Distance: 10 cm

FCC/IC									
#	EUT Test Mode	Overall Transmission			Internal Frame Characteristics			Computed Duty Cycle	
		Min. Repetition Rate (sec)	Max. No. of Frames	Total Transmission Length (sec)	Max. Frame Length (ms)	Min. Frame Period (ms)	Frame Encoding	(%)	(dB)
1	Worst-case ASK Learn Mode. See Subfigure (a)	Single	16	2.11	28.3	>100	When manually actuated by encoded LF, the EUT transmits 16 frames of Manchester encoded ASK data (one of which may occur in any 100 ms window). Manchester encoding exhibits a 0.123 ms bit on time over a 0.241 ms period .	14.4	-16.8
3	Worst-case Rolling Mode. See Subfigure (b)	58.4	6	0.75	28.3	>100	Same Frames as above	14.4	-16.8

Example Calculation: ASK Duty (%) = ((28.3 ms x (0.123 ms / 0.241 ms)) / 100 ms) x 100 = 14.4 %

Equipment Used: DIPEMC001, RSFSV30001

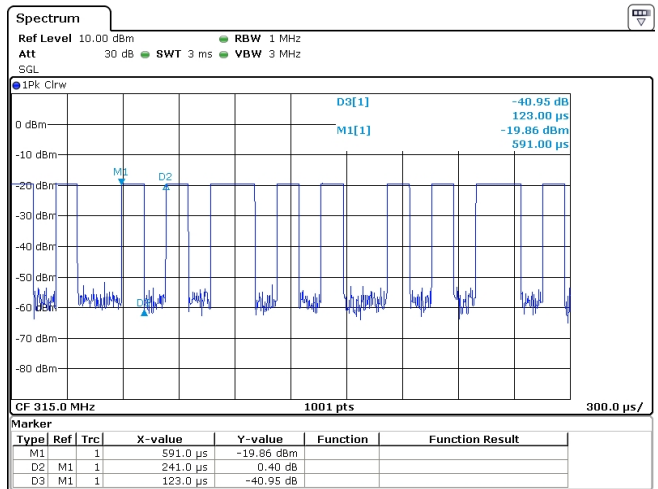
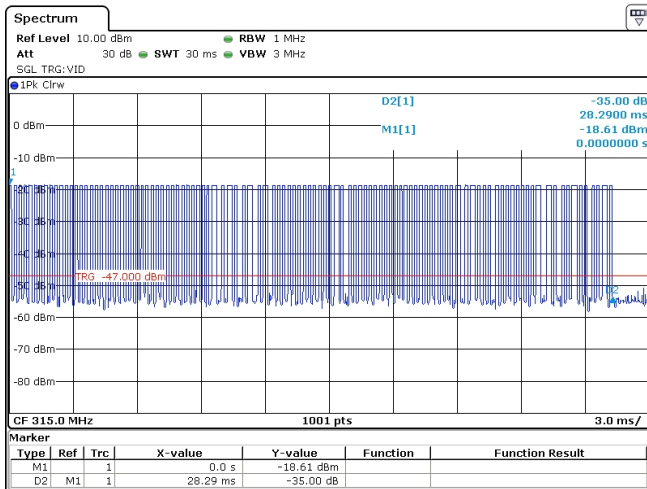
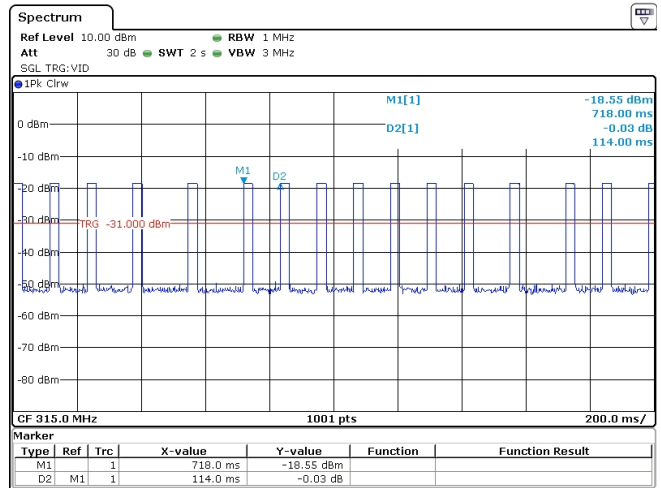
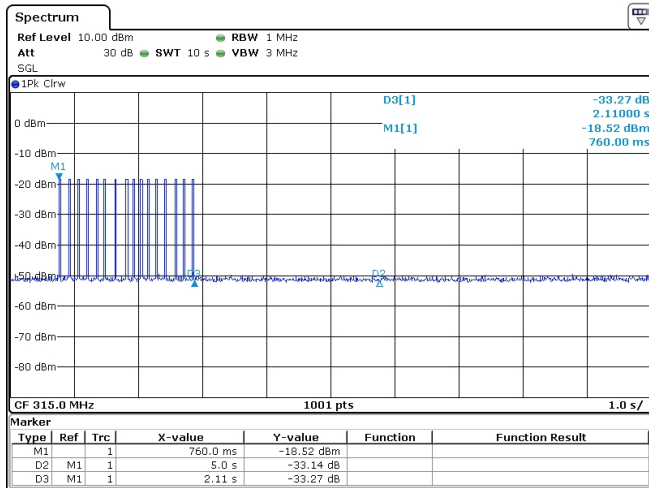

Figure 5(a): Pulsed Emission Characteristics (Duty Cycle).

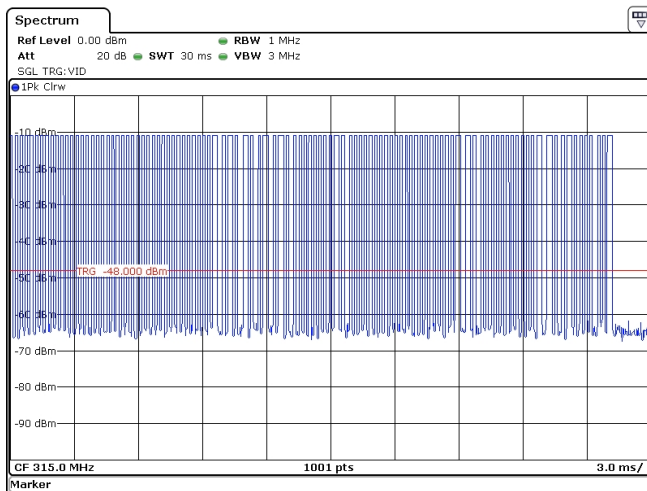
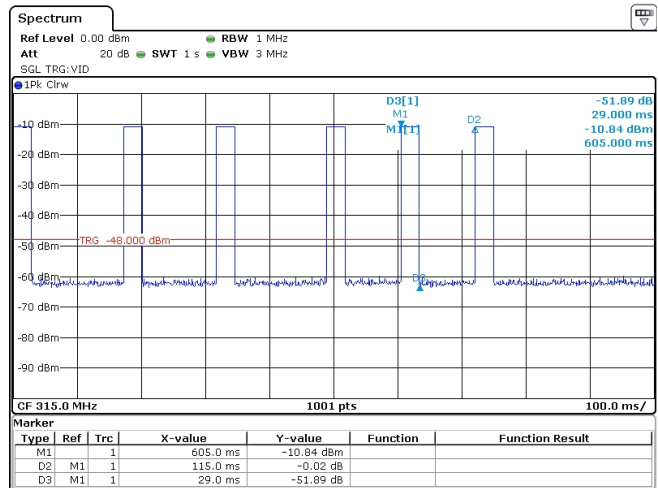
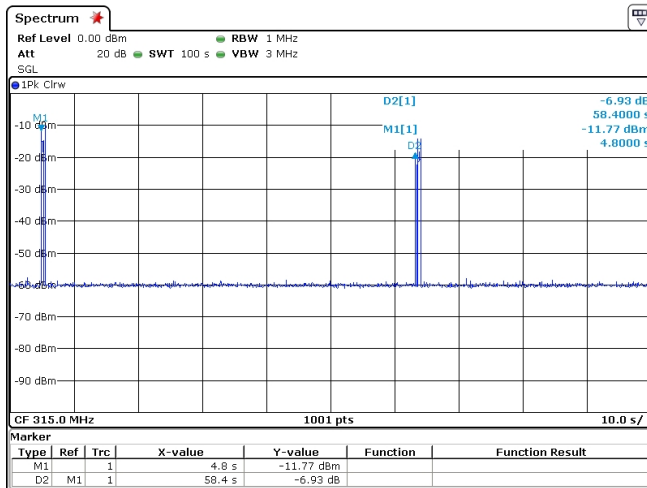

Figure 5(b): Pulsed Emission Characteristics (Duty Cycle).

3.2.2 Fundamental Emission Bandwidth

Emission bandwidth (EBW) of the EUT is measured with the device placed in the test mode(s) with the shortest available frame length and minimum frame spacing. Radiated emissions are recorded following the test procedures listed in Section 1.1. The 20 dB EBW is measured as the max-held peak-detected signal when the IF bandwidth is greater than or equal to 1% of the receiver span. For complex modulations other than ASK and FSK, the 99% emission bandwidth per IC test procedures has a different result, and is also separately reported. The results of EBW testing are summarized in Table 4. Plots showing measurements employed to obtain the emission bandwidth reported are provided in Figure 6.

Table 4: Intentional Emission Bandwidth.

Detector	IF Bandwidth	Video Bandwidth	Test Date:	22-Aug-14
Pk	10 kHz	30 kHz	Test Engineer:	Joseph Brunett
			EUT:	Schrader AG6SP3
			EUT Mode:	Modulated
			Meas. Distance:	10 cm

FCC/IC						
#	Modulation	Center Frequency (MHz)	20 dB EBW (MHz)	EBW Limit (MHz)		
1	ASK	315	0.0549	0.7875		
2						

Equipment Used: DIPEMC001, RSFSV30001

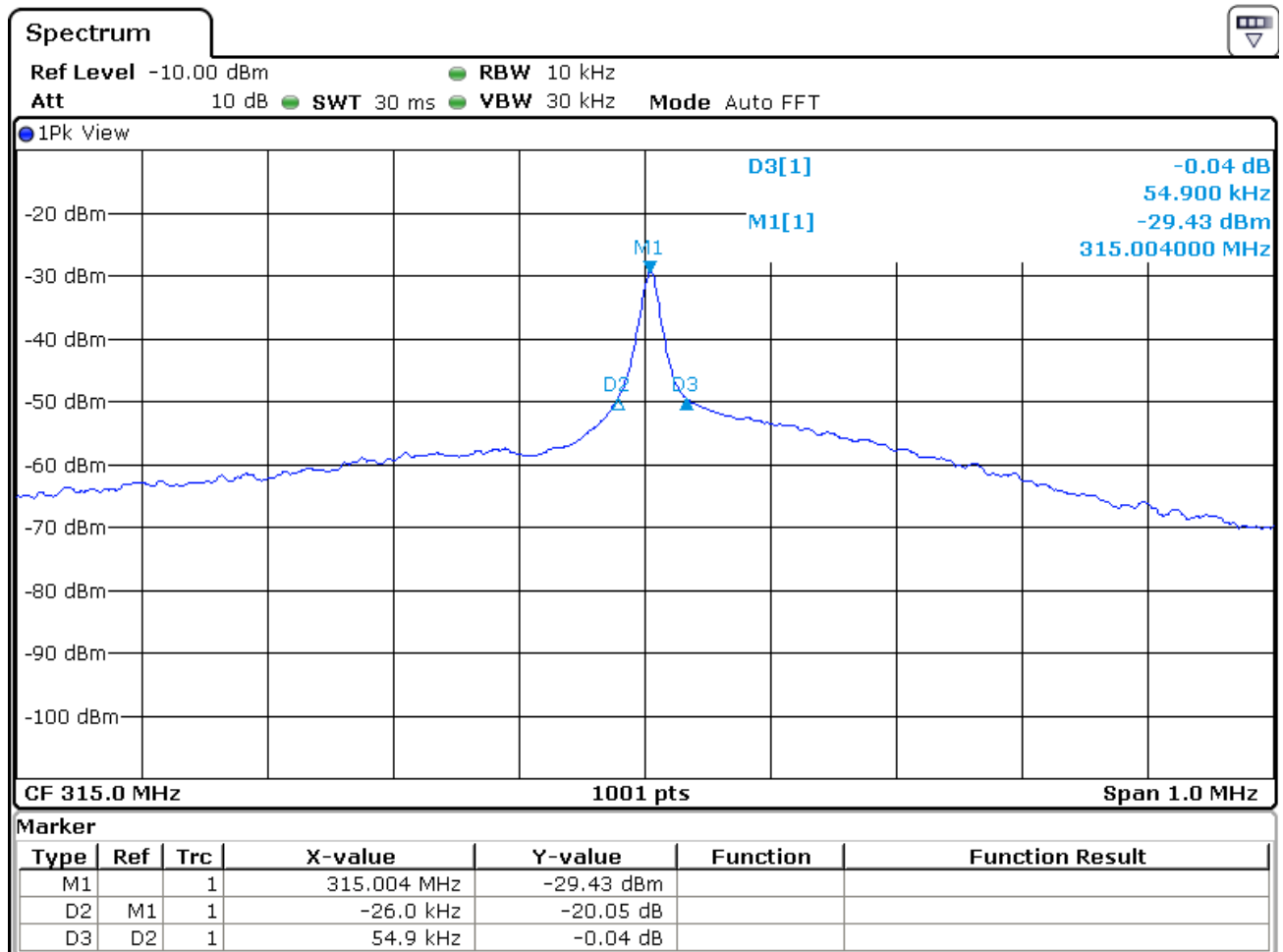

Figure 6: Intentional Emission Bandwidth.

3.2.3 Fundamental Emission

Following the test procedures listed in Section 1.1, radiated emissions measurements are made on the EUT for both Horizontal and Vertical polarized fields. Table 5 details the results of these measurements.

Table 5: Fundamental Radiated Emissions.

Frequency Range	Det	IF Bandwidth	Video Bandwidth	Test Date:	23-May-14
25 MHz f 1 000 MHz	Pk/QPk	120 kHz	300 kHz	Test Engineer:	Joseph Brunett
f > 1 000 MHz	Pk	1 MHz	3MHz	EUT:	Schrader AG6SP3
f > 1 000 MHz	Avg	1 MHz	10kHz	EUT Mode:	CW
				Meas. Distance:	3 meters

FCC/IC												
#	Freq. MHz	Ant. Used	Ant. Pol.	Pr (Pk) dBm	Pr (Avg)* dBm	Ka dB/m	Kg dB	E3(Pk) dBμ V/m	E3(Avg) dBμ V/m	FCC/IC E3(Avg) Lim. dBμ V/m	Pass dB	Comments
1	AG6SP3-F (Smaller Housing)											
2	315.0	Dip	H	-23.0	-39.8	18.6	33.8	68.8	52.0	67.7	15.7	flat
3	315.0	Dip	V	-21.5	-38.3	18.6	33.8	70.3	53.5	67.7	14.2	end
4	AG6SP3-D (Larger Housing)											
5	315.0	Dip	H	-21.0	-37.8	18.6	33.8	70.8	54.0	67.7	13.7	side
6	315.0	Dip	V	-19.4	-36.2	18.6	33.8	72.4	55.6	67.7	12.1	end
#	Freq. MHz	DC Supply Voltage		Relative Pr (Pk) dBm**								
7	315.0	2.60		-25.8								
8	315.0	2.80		-24.5								
9	315.0	3.00		-23.0								
10	315.0	3.15		-21.5								
11	315.0	3.30		-20.3								

*Avg data computed from Peak Measured Data and EUT Duty Cycle. EUT in CW mode.

** EUT in CW mode.

Equipment Used: DIPEMC001, RSFSV30001

3.3 Unintentional Emissions

3.3.1 Transmit Chain Spurious Emissions

The results for the measurement of transmit chain spurious emissions at the nominal voltage and temperature are provided in Table 6. Measurements are performed to 10 times the highest fundamental operating frequency.

Table 6: Transmit Chain Spurious Emissions.

Frequency Range	Det	IF Bandwidth	Video Bandwidth	Test Date:	23-May-14
25 MHz f 1 000 MHz	Pk/QPk	120 kHz	300 kHz	Test Engineer:	Joseph Brunett
f > 1 000 MHz	Pk	1 MHz	3 MHz	EUT:	Schrader AG6SP3
f > 1 000 MHz	Avg	1 MHz	10kHz	EUT Mode:	CW
				Meas. Distance:	3 meters

Transmitter Unintentional Spurious Emissions												FCC/IC
#	Freq. MHz	Ant. Used	Ant. Pol.	Pr (Pk) dBm	Pr (Avg)* dBm	Ka dB/m	Kg dB	E3(Pk) dBμV/m	E3(Avg) dBμV/m	FCC/IC E3lim (Avg) dBμV/m	Pass dB	Comments
1	AG6SP3-F (Smaller Housing)											
2	630.0	Dip	H	-67.7	-84.5	24.4	30.5	33.2	16.4	47.7	31.2	flat
3	630.0	Dip	V	-71.0	-87.8	24.4	30.5	29.9	13.1	47.7	34.5	max all, noise
4	945.0	Dip	H	-78.9	-95.7	28.8	27.5	29.4	12.6	47.7	35.0	max all, noise
5	945.0	Dip	V	-80.1	-96.9	28.8	27.5	28.2	11.4	47.7	36.2	max all, noise
6	1260.0	R-Horn	H	-69.6	-86.4	20.6	22.4	35.6	18.8	54.0	35.2	max all, noise
7	1575.0	R-Horn	H	-67.8	-84.6	21.5	29.2	31.4	14.6	54.0	39.4	max all, noise
8	1890.0	R-Horn	H	-49.0	-65.8	22.2	31.2	49.0	32.2	54.0	21.8	flat
9	2205.0	R-Horn	H	-58.5	-75.3	23.0	30.9	40.5	23.7	54.0	30.2	max all, noise
10	2520.0	R-Horn	H	-58.1	-74.9	23.9	29.8	43.0	26.2	54.0	27.8	max all, noise
11	2835.0	R-Horn	H	-64.6	-81.4	24.8	28.6	38.6	21.8	54.0	32.2	max all, noise
12	3150.0	R-Horn	H	-65.0	-81.8	25.8	27.5	40.3	23.5	54.0	30.4	max all, noise
13	AG6SP3-D (Larger Housing)											
14	630.0	Dip	H	-68.3	-85.1	24.4	30.5	32.6	15.8	47.7	31.8	side
15	630.0	Dip	V	-70.4	-87.2	24.4	30.5	30.5	13.7	47.7	33.9	flat
16	945.0	Dip	H	-81.0	-97.8	28.8	27.5	27.3	10.5	47.7	37.1	max all, noise
17	945.0	Dip	V	-79.3	-96.1	28.8	27.5	29.0	12.2	47.7	35.4	max all, noise
18	1260.0	R-Horn	H	-68.5	-85.3	20.6	22.4	36.7	19.9	54.0	34.1	max all, noise
19	1575.0	R-Horn	H	-67.0	-83.8	21.5	29.2	32.2	15.4	54.0	38.6	max all, noise
20	1890.0	R-Horn	H	-50.7	-67.5	22.2	31.2	47.3	30.5	54.0	23.5	flat
21	2205.0	R-Horn	H	-56.6	-73.4	23.0	30.9	42.4	25.6	54.0	28.3	max all, noise
22	2520.0	R-Horn	H	-55.8	-72.6	23.9	29.8	45.3	28.5	54.0	25.5	max all, noise
23	2835.0	R-Horn	H	-65.3	-82.1	24.8	28.6	37.9	21.1	54.0	32.9	max all, noise
24	3150.0	R-Horn	H	-66.1	-82.9	25.8	27.5	39.2	22.4	54.0	31.5	max all, noise
25												
26												

*Avg data computed from Peak Measured Data and EUT Duty Cycle. EUT in CW mode.

Equipment Used: DIPEMC001, UMHORN005, RSFSV30001