

**Amber Helm Development L.C.**

92723 Michigan Hwy-152

Sister Lakes, Michigan 49047 USA

Tel: 888-847-8027

# EMC Test Report

**BCSTP-WR1906TX**

Issued: March 20, 2019

regarding

**USA: CFR Title 47, Part 15.231 (Emissions)**  
**Canada: ISED RSS-210v9/GENv5 (Emissions)**

for



## AG3PF4

**Category: TPMS Transmitter**

Judgments:

**15.231e/RSS-210v9 Compliant Transmitter**

Testing Completed: March 12, 2019



Prepared for:

## Schrader Electronics

11 Technology Park, Belfast Road, Antrim Northern Ireland BT41 1QS United Kingdom

Phone: +44 28 9448 3067, Fax: +44 28 9446 8440

Contact: James Kyle, jakyle@schrader.co.uk

Data Recorded by:

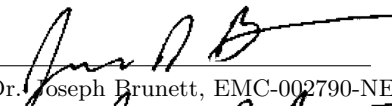
  
Dr. Joseph Brunett, EMC-002790-NE

Reviewed by:

  
Gordon Helm, EMC-002401-NE

Prepared by:

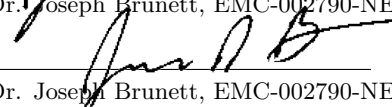
  
Dr. Joseph Brunett, EMC-002790-NE

Date of Issue: March 20, 2019

## Revision History

Rev. No.	Date	Details	Revised By
r0	March 20, 2019	Initial Release.	J. Brunett

## Contents

<b>Revision History</b>	<b>2</b>
<b>Table of Contents</b>	<b>2</b>
<b>1 Test Report Scope and Limitations</b>	<b>4</b>
1.1 Laboratory Authorization . . . . .	4
1.2 Report Retention . . . . .	4
1.3 Subcontracted Testing . . . . .	4
1.4 Test Data . . . . .	4
1.5 Limitation of Results . . . . .	4
1.6 Copyright . . . . .	4
1.7 Endorsements . . . . .	4
1.8 Test Location . . . . .	5
1.9 Traceability and Equipment Used . . . . .	5
<b>2 Test Specifications and Procedures</b>	<b>6</b>
2.1 Test Specification and General Procedures . . . . .	6
<b>3 Configuration and Identification of the Equipment Under Test</b>	<b>7</b>
3.1 Description and Declarations . . . . .	7
3.1.1 EUT Configuration . . . . .	7
3.1.2 Modes of Operation . . . . .	8
3.1.3 Variants . . . . .	8
3.1.4 Test Samples . . . . .	8
3.1.5 Functional Exerciser . . . . .	8
3.1.6 Modifications Made . . . . .	8
3.1.7 Production Intent . . . . .	8
3.1.8 Declared Exemptions and Additional Product Notes . . . . .	8
<b>4 Emissions</b>	<b>9</b>
4.1 General Test Procedures . . . . .	9
4.1.1 Radiated Test Setup and Procedures . . . . .	9
4.1.2 Conducted Emissions Test Setup and Procedures . . . . .	11
4.1.3 Power Supply Variation . . . . .	11
4.2 Intentional Emissions . . . . .	12
4.2.1 Fundamental Emission Pulsed Operation . . . . .	12
4.2.2 Fundamental Emission Bandwidth . . . . .	14
4.2.3 Fundamental Emission Field Strength . . . . .	15
4.3 Unintentional Emissions . . . . .	16
4.3.1 Transmit Chain Spurious Emissions . . . . .	16
<b>5 Measurement Uncertainty and Accreditation Documents</b>	<b>17</b>

**List of Tables**

1	Test Site List. . . . .	5
2	Equipment List. . . . .	5
3	EUT Declarations. . . . .	7
4	Fundamental Emission Pulsed Operation. . . . .	12
5	Fundamental Emission Bandwidth. . . . .	14
6	Fundamental Emission Field Strength. . . . .	15
7	Transmit Chain Spurious Emissions. . . . .	16
8	Measurement Uncertainty. . . . .	17

**List of Figures**

1	Photos of EUT. . . . .	7
2	EUT Test Configuration Diagram. . . . .	8
3	Radiated Emissions Diagram of the EUT. . . . .	9
4	Radiated Emissions Test Setup Photograph(s). . . . .	10
5	Fundamental Emission Pulsed Operation. . . . .	12
5	Fundamental Emission Pulsed Operation. . . . .	13
6	Fundamental Emission Bandwidth. . . . .	14
7	Accreditation Documents . . . . .	17

## **1 Test Report Scope and Limitations**

### **1.1 Laboratory Authorization**

Test Facility description and attenuation characteristics are on file with the FCC Laboratory, Columbia, Maryland (FCC Reg. No: US5348 and US5356) and with ISED Canada, Ottawa, ON (File Ref. No: US0213). Amber Helm Development L.C. holds accreditation under NVLAP Lab Code 200129-0.

### **1.2 Report Retention**

For equipment verified to comply with the regulations herein, the manufacturer is obliged to retain this report with the product records for the life of the product, and no less than ten years. A copy of this Report will remain on file with this laboratory until April 2029.

### **1.3 Subcontracted Testing**

This report does not contain data produced under subcontract.

### **1.4 Test Data**

This test report contains data included within the laboratories scope of accreditation.

### **1.5 Limitation of Results**

The test results contained in this report relate only to the item(s) tested. Any electrical or mechanical modification made to the test item subsequent to the test date shall invalidate the data presented in this report. Any electrical or mechanical modification made to the test item subsequent to this test date shall require reevaluation.

### **1.6 Copyright**

This report shall not be reproduced, except in full, without the written approval of Amber Helm Development L.C.

### **1.7 Endorsements**

This report shall not be used to claim product endorsement by any accrediting, regulatory, or governmental agency.

## 1.8 Test Location

The EUT was fully tested by **Amber Helm Development L.C.**, headquartered at 92723 Michigan Hwy-152, Sister Lakes, Michigan 49047 USA. Table 1 lists all sites employed herein. Specific test sites utilized are also listed in the test results sections of this report where needed.

Table 1: Test Site List.

Description	Location	Quality Num.
OATS (3 meter)	3615 E Grand River Rd., Williamston, Michigan 48895	OATSC

## 1.9 Traceability and Equipment Used

Pertinent test equipment used for measurements at this facility is listed in Table 2. The quality system employed at Amber Helm Development L.C. has been established to ensure all equipment has a clearly identifiable classification, calibration expiry date, and that all calibrations are traceable to the SI through NIST, other recognized national laboratories, accepted fundamental or natural physical constants, ratio type of calibration, or by comparison to consensus standards.

Table 2: Equipment List.

Description	Manufacturer/Model	SN	Quality Num.	Last Cal By / Date Due
Biconical	EMCO / 93110B	9802-3039	BICEMCO01	Keysight / Aug-2019
Log Periodic Antenna	EMCO / 3146	9305-3614	LOGEMCO01	Keysight / Aug-2019
BNC-BNC Coax	WRTL / RG58/U	001	CAB001-BLACK	AHD / Mar-2019
3.5-3.5MM Coax	PhaseFlex / PhaseFlex	001	CAB015-PURPLE	AHD / Mar-2019
Spectrum Analyzer	Rohde & Schwarz / FSV30	101660	RSFSV30001	RS / Apr-2019
Quad Ridge Horn	Singer / A6100	C35200	HQR1TO18S01	Keysight / Aug-2019

## 2 Test Specifications and Procedures

### 2.1 Test Specification and General Procedures

The ultimate goal of Schrader Electronics is to demonstrate that the Equipment Under Test (EUT) complies with the Rules and/or Directives below. Detailed in this report are the results of testing the Schrader Electronics AG3PF4 for compliance to:

Country/Region	Rules or Directive	Referenced Section(s)
United States	Code of Federal Regulations	CFR Title 47, Part 15.231
Canada	ISED Canada	ISED RSS-210v9/GENv5

It has been determined that the equipment under test is subject to the rules and directives above at the date of this testing. In conjunction with these rules and directives, the following specifications and procedures are followed herein to demonstrate compliance (in whole or in part) with these regulations.

ANSI C63.4:2014	"Methods of Measurement of Radio-Noise Emissions from Low-Voltage Electrical and Electronic Equipment in the Range of 9 kHz to 40 GHz"
ANSI C63.10:2013	"American National Standard of Procedures for Compliance Testing of Unlicensed Wireless Devices"
TP0102RA	"AHD Internal Document TP0102 - Radiated Emissions Test Procedure"
ISED Canada	"The Measurement of Occupied Bandwidth"

### 3 Configuration and Identification of the Equipment Under Test

#### 3.1 Description and Declarations

The equipment under test is a UHF transmitter for automotive tire pressure monitoring. The EUT is approximately 3.5 x 3.5 x 1.5 cm in dimension, and is depicted in Figure 1. It is powered by 3 VDC Lithium cell battery. In use, this device is permanently installed in the tire of a motor vehicle. Table 3 outlines provider declared EUT specifications.



Figure 1: Photos of EUT.

Table 3: EUT Declarations.

General Declarations			
<b>Equipment Type:</b>	TPMS Transmitter	<b>Country of Origin:</b>	Not Declared
<b>Nominal Supply:</b>	3 VDC	<b>Oper. Temp Range:</b>	Not Declared
<b>Frequency Range:</b>	433.92 MHz	<b>Antenna Dimension:</b>	Not Declared
<b>Antenna Type:</b>	metal frame	<b>Antenna Gain:</b>	-20 dBi (approx)
<b>Number of Channels:</b>	1	<b>Channel Spacing:</b>	Not Applicable
<b>Alignment Range:</b>	Not Declared	<b>Type of Modulation:</b>	FSK
United States			
<b>FCC ID Number:</b>	MRXAG3PF4	<b>Classification:</b>	DSC
Canada			
<b>IC Number:</b>	2456A-AG3PF4	<b>Classification:</b>	Remote Control Device, Vehicular Device

#### 3.1.1 EUT Configuration

The EUT is configured for testing as depicted in Figure 2.

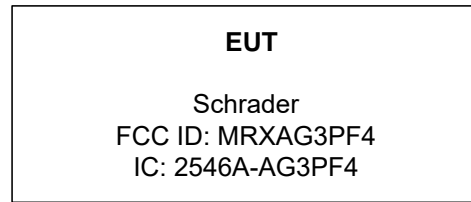

Figure 2: EUT Test Configuration Diagram.

### 3.1.2 Modes of Operation

This device is capable of three key modes of operation. Upon manually activated LF interrogation (through the use of special LF tool at a vehicle dealership), the EUT responds with a single transmission containing a number of frames used to configure the device with the vehicle (LEARN MODE). When the EUT is placed in the vehicle tire and the vehicle drives, it can, in the worst case, periodically transmit where the duration of each transmission is always less than 1 second and the silent period between transmissions is at least 30 times the duration of the transmission, and never less than 10 seconds (DRIVE MODE). (See duty cycle table and operational description exhibit for details.) In the case of an emergency condition (delta Pressure), the EUT will transmit tire pressure and temperature information throughout the duration of the condition.

### 3.1.3 Variants

There is only a single variant of the EUT, as tested.

### 3.1.4 Test Samples

Four samples in total were provided; one normal operating sample without laser welding (for photographs), two normal operating samples capable of transmitting 4 frames periodically and two CW samples. The normal operating sample was tested for LF activation response using a LF diagnostic tool provided by the manufacturer.

### 3.1.5 Functional Exerciser

Normal operating EUT functionality was verified by observation of transmitted signal.

### 3.1.6 Modifications Made

There were no modifications made to the EUT by this laboratory.

### 3.1.7 Production Intent

The EUT appears to be a production ready sample.

### 3.1.8 Declared Exemptions and Additional Product Notes

The EUT is permanently installed in a transportation vehicle. As such, digital emissions are exempt from US and Canadian digital emissions regulations (per FCC 15.103(a) and IC correspondence on ICES-003).

The EUT also employs some modes of operation that alert the vehicle user of sudden changes in tire pressure. Such alert modes fall under FCC 15.231(a)(4), and may operate during the pendency of the alarm condition. A detailed list of all operating modes is included in the Description of Operation exhibit included in this application.



## 4 Emissions

### 4.1 General Test Procedures

#### 4.1.1 Radiated Test Setup and Procedures

Radiated electromagnetic emissions from the EUT are first pre-scanned in our screen room. Spectrum and modulation characteristics of all emissions are recorded. Instrumentation, including spectrum analyzers and other test equipment as detailed in Section 1.8 are employed. After pre-scan, emission measurements are made on the test site of record. If the EUT connects to auxiliary equipment and is table or floor standing, the configurations prescribed in relevant test standards are followed. Alternatively, a layout closest to normal use (as declared by the provider) is employed if the resulting emissions appear to be worst-case in such a configuration. See Figure 3. All intentionally radiating elements that are not fixed-mounted in use are placed on the test table lying flat, on their side, and on their end (3-axes) and the resulting worst case emissions are recorded. If the EUT is fixed-mounted in use, measurements are made with the device oriented in the manner consistent with installation and then emissions are recorded. If the EUT exhibits spurious emissions due to internal receiver circuitry, such emissions are measured with an appropriate carrier signal applied.

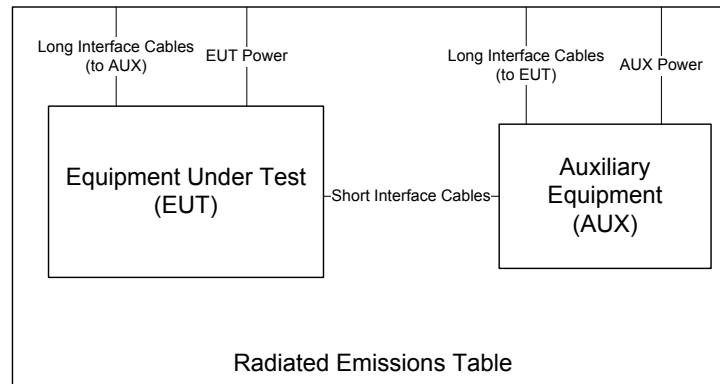

Figure 3: Radiated Emissions Diagram of the EUT.

For devices with intentional emissions below 30 MHz, a shielded loop antenna and/or E-field and H-Field broadband probes are used depending on the regulations. Shielded loops are placed at a 1 meter receive height at the desired measurement distance. For exposure in this band, the broadband probes employed are 10cm diameter single-axis shielded transducers and measurements are repeated and summed over three axes.

Emissions between 30 MHz and 1 GHz are measured using calibrated broadband antennas. For both horizontal and vertical polarizations, the test antenna is raised and lowered from 1 to 4 m in height until a maximum emission level is detected. The EUT is then rotated through  $360^\circ$  in azimuth until the highest emission is detected. The test antenna is then raised and lowered one last time from 1 to 4 m and the worst case value is recorded. Emissions above 1 GHz are characterized using standard gain or broadband ridge-horn antennas on our OATS with a  $4 \times 5$  m rectangle of ECCOSORB absorber covering the OATS ground screen and a 1.5m table height. Care is taken to ensure that test receiver resolution and video bandwidths meet the regulatory requirements, and that the emission bandwidth of the EUT is not reduced. Photographs of the test setup employed are depicted in Figure 4.

Where regulations allow for direct measurement of field strength, power values (dBm) measured on the test receiver / analyzer are converted to  $\text{dB}\mu\text{V}/\text{m}$  at the regulatory distance, using

$$E_{dist} = 107 + P_R + K_A - K_G + K_E - C_F$$

where  $P_R$  is the power recorded on spectrum analyzer, in dBm,  $K_A$  is the test antenna factor in dB/m,  $K_G$  is the combined pre-amplifier gain and cable loss in dB,  $K_E$  is duty correction factor (when applicable) in dB, and  $C_F$  is a distance conversion (employed only if limits are specified at alternate distance) in dB. This field strength value is then compared with the regulatory limit. If effective isotropic radiated power (EIRP) is computed, it is computed as

$$EIRP(\text{dBm}) = E_{3m}(\text{dB}\mu\text{V}/\text{m}) - 95.2.$$

When presenting data at each frequency, the highest measured emission under all possible EUT orientations (3-axes) is reported.

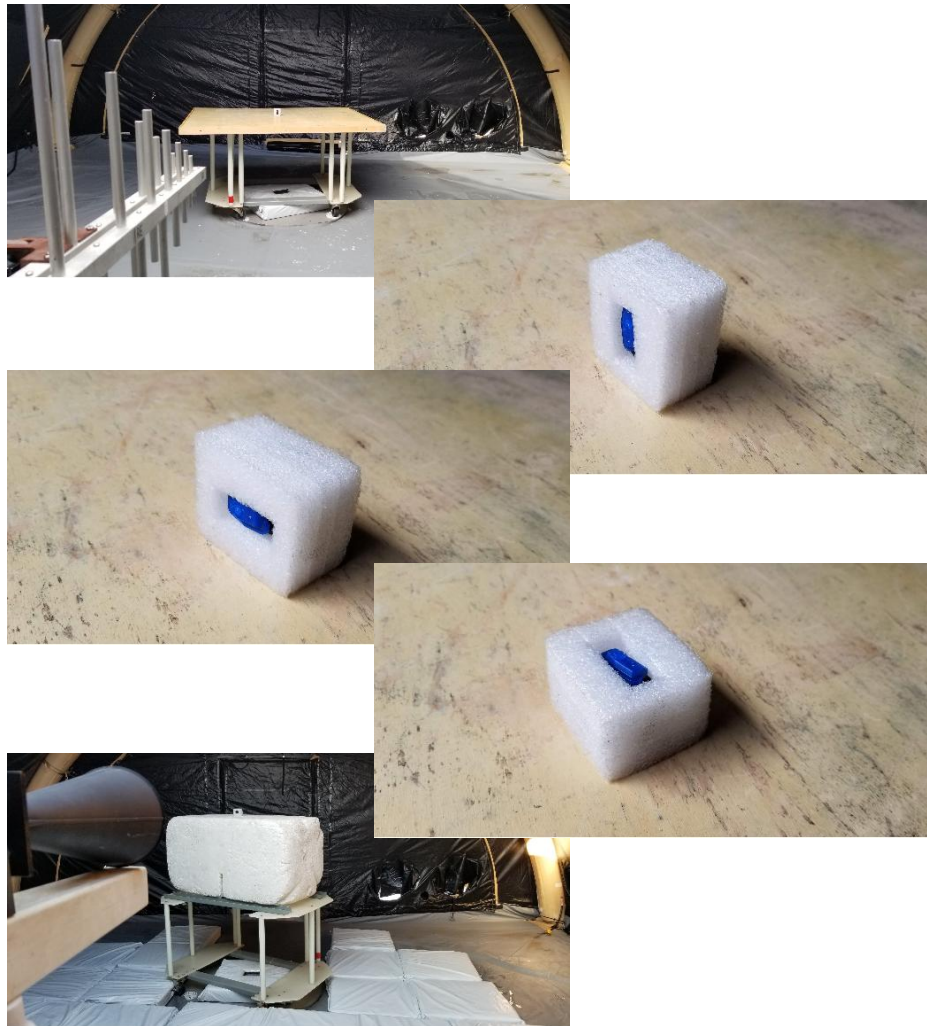

Figure 4: Radiated Emissions Test Setup Photograph(s).

#### **4.1.2 Conducted Emissions Test Setup and Procedures**

The EUT is not subject to measurement of power line conducted emissions as it is powered solely by its internal battery.

#### **4.1.3 Power Supply Variation**

Tests at extreme supply voltages are made if required by the procedures specified in the test standard, and results of this testing are detailed in this report.

In the case the EUT is designed for operation from a battery power source, the extreme test voltages are evaluated over the range specified in the test standard; no less than  $\pm 10\%$  of the nominal battery voltage declared by the manufacturer. For all battery operated equipment, worst case intentional and spurious emissions are re-checked employing a new (fully charged) battery.

## 4.2 Intentional Emissions

### 4.2.1 Fundamental Emission Pulsed Operation

**Test Setup & Procedure** The test equipment and facilities were setup in accordance with the standards and procedures listed in Section 2.1. Environmental conditions were set at the appropriate temperature and thermal balance was checked with a thermocouple based probe. Duty cycle is reported for all relevant modes of operation. The test equipment employed includes RSFSV30001, LOGEMCO01.

**Measurement Results** The details and results of testing the EUT are summarized in Table 4. Plots showing the measurements made to obtain these values are provided in Figure 5.

Table 4: Fundamental Emission Pulsed Operation.

<b>Detector</b>	<b>Span</b>	<b>IF Bandwidth</b>	<b>Video Bandwidth</b>	<b>Test Date:</b>	11-Mar-19
Pk	0	3 MHz	10 MHz	<b>Test Engineer:</b>	Joseph Brunett
				<b>EUT:</b>	Schrader AG3PF4
				<b>EUT Mode:</b>	Modulated
				<b>Meas. Distance:</b>	10 cm

#	Frequency (MHz)	EUT Test Mode*	Overall Transmission				Internal Frame Characteristics			Computed Duty Cycle	
			Min. Repetition Rate (sec)	Max. No. of Frames	Total Transmission Length (sec)	Max. Frame Length (ms)	Min. Frame Period (ms)	Frame Encoding	(%)	(dB)	
1	433.92	LF Activated LEARN Mode (see Figure 5(a))	Single	4	0.42	24.950	>100	In LF Activated (LEARN) mode the EUT can be manually activated by encoded LF interrogation to transmit a single set of 4 frames. In the worst case a 24.95 ms FSK frame occurs within a 100 ms window.	25.0	-12.1	
2	433.92	Drive Mode (see Figure 5(b))	10.9	4	0.245	18.500	<100	In worst case Drive (periodic tx) mode the EUT transmits 4 FSK frames every 10.9 seconds, wherein one 18.5 ms and one 5.6 ms FSK frame occur in a 100ms window.	24.1	-12.4	

Example Calculation: Worst Case Duty (%) = (24.95 ms / 100 ms ) x 100 = 25 % = -12.1 dB Field Strength Duty

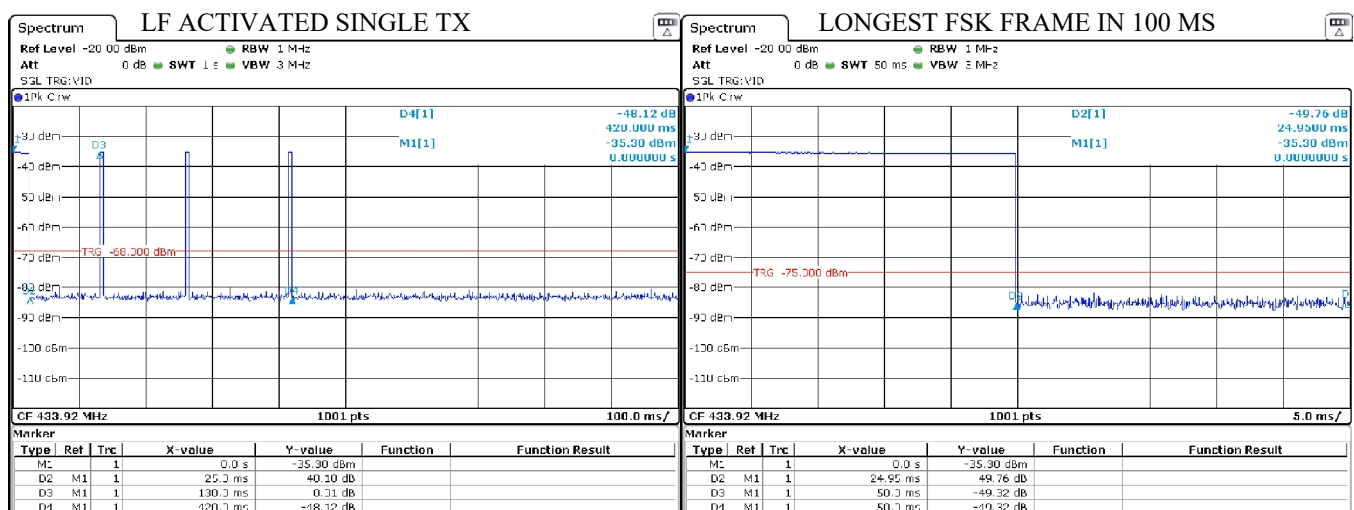

Figure 5(a): Fundamental Emission Pulsed Operation.

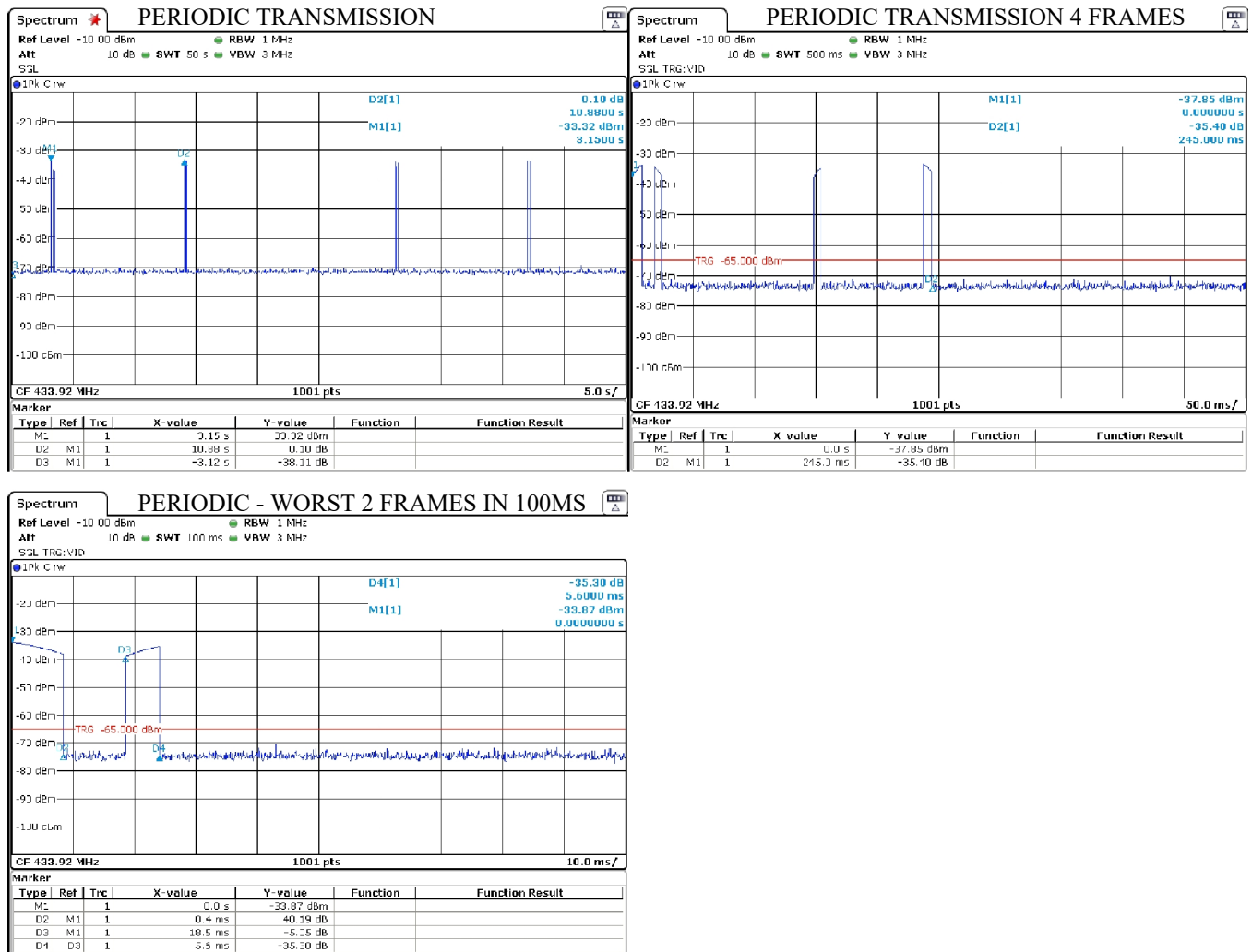

Figure 5(b): Fundamental Emission Pulsed Operation.

### 4.2.2 Fundamental Emission Bandwidth

**Test Setup & Procedure** The test equipment and facilities were setup in accordance with the standards and procedures listed in Section 2.1. Environmental conditions were set at the appropriate temperature and thermal balance was checked with a thermocouple based probe. Emission bandwidth (EBW) of the EUT is measured with the device placed in the test mode(s) with the shortest available frame length and minimum frame spacing. The 20 dB EBW is measured as the max-held peak-detected signal when the IF bandwidth is greater than or equal to 1% of the receiver span. For complex modulations other than ASK and FSK, the 99% emission bandwidth per IC test procedures has a different result, and is also reported. The test equipment employed includes RSFSV30001, LOGEMCO01.

**Measurement Results** The details and results of testing the EUT are summarized in Table 5. Plots showing the measurements made to obtain these values are provided in Figure 6.

Table 5: Fundamental Emission Bandwidth.

<b>Detector</b>	<b>IF Bandwidth</b>	<b>Video Bandwidth</b>	<b>Test Date:</b>	11-Mar-19
Pk	10 kHz	30 kHz	<b>Test Engineer:</b>	Joseph Brunett
			<b>EUT:</b>	Schrader AG3PF4
			<b>EUT Mode:</b>	Normal
			<b>Meas. Distance:</b>	10 cm

FCC/IC						
#	Modulation	Center Frequency (MHz)	20 dB EBW (MHz)	EBW Limit (MHz)	99% OBW (MHz)	
1	FSK	433.92	0.127	1.0848	0.281	
2						

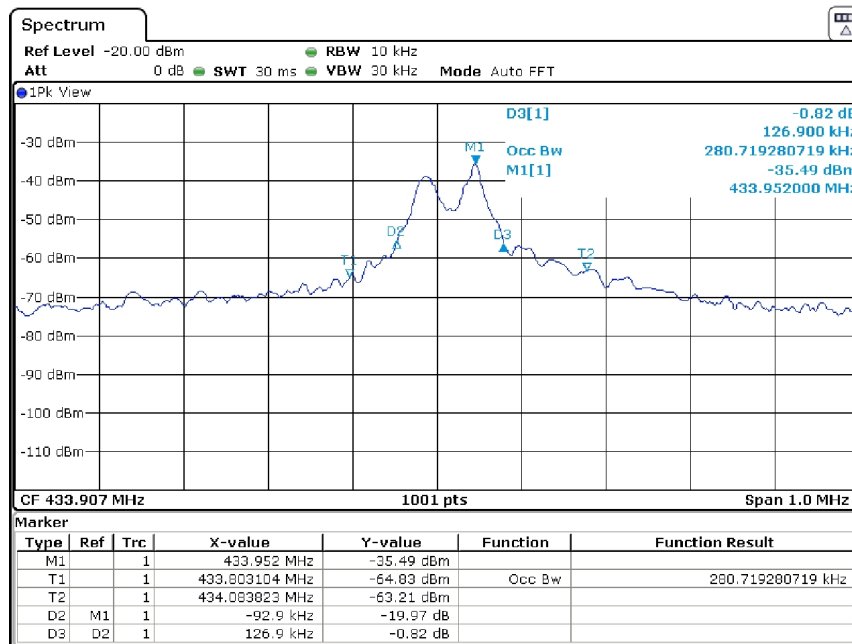

Figure 6: Fundamental Emission Bandwidth.

### 4.2.3 Fundamental Emission Field Strength

**Test Setup & Procedure** The test equipment and facilities were setup in accordance with the standards and procedures listed in Section 2.1. Environmental conditions were set at the appropriate temperature and thermal balance was checked with a thermocouple based probe. Fundamental emissions are measured at the regulatory distance on our OATS. The test equipment employed includes RSFSV30001, LOGEMCO01.

**Measurement Results** The details and results of testing the EUT are summarized in Table 6.

Table 6: Fundamental Emission Field Strength.

<b>Frequency Range</b>	<b>Det</b>	<b>IF Bandwidth</b>	<b>Video Bandwidth</b>	<b>Test Date:</b>	8-Mar-19
25 MHz f 1 000 MHz	Pk/QPk	120 kHz	300 kHz	<b>Test Engineer:</b>	Joseph Brunett
				<b>EUT:</b>	Schrader AG3PF4
				<b>EUT Mode:</b>	CW
				<b>Meas. Distance:</b>	3 meters

													FCC/IC	
#	Freq. MHz	Ant. Used	Ant. Pol.	Table Azim. deg	Ant Height m	Ka dB/m	Kg dB	E3(Pk) dBµV/m	E3(Avg)* dBµV/m	FCC/IC E3(Pk) Lim. dBµV/m	FCC/IC E3(Avg) Lim. dBµV/m	Pass dB	Comments	
1														
2	433.9	LOGEMCO01	H	220.0	1.0	16.3	-1.5	78.6	66.5	92.8	72.8	<b>6.3</b>	end	
3	433.9	LOGEMCO01	V	.0	1.4	16.3	-1.5	76.7	64.6	92.8	72.8	<b>8.2</b>	side	
4														
5														
6														

\*Avg data computed from Peak Measured Data and EUT Duty Cycle. EUT in CW mode.

### 4.3 Unintentional Emissions

#### 4.3.1 Transmit Chain Spurious Emissions

**Test Setup & Procedure** The test equipment and facilities were setup in accordance with the standards and procedures listed in Section 2.1. Environmental conditions were set at the appropriate temperature and thermal balance was checked with a thermocouple based probe. Spurious radiated emissions measurements are performed to 10 times the highest fundamental operating frequency. The test equipment employed includes RSFSV30001, LOGEMCO01, HQR2TO18S01.

**Measurement Results** The details and results of testing the EUT are summarized in Table 7.

Table 7: Transmit Chain Spurious Emissions.

<b>Frequency Range</b>	<b>Det</b>	<b>IF Bandwidth</b>	<b>Video Bandwidth</b>	<b>Test Date:</b>	8-Mar-19
25 MHz f 1 000 MHz	Pk/QPk	120 kHz	300 kHz	<b>Test Engineer:</b>	Joseph Brunett
f > 1 000 MHz	Pk	1 MHz	3 MHz	<b>EUT:</b>	Schrader AG3PF4
f > 1 000 MHz	Avg	1 MHz	10kHz	<b>EUT Mode:</b>	CW
				<b>Meas. Distance:</b>	3 meters

Transmitter Unintentional Spurious Emissions													FCC/IC
#	Freq. MHz	Ant. Used	Ant. Pol.	Table Azim. deg	Ant Height m	Ka dB/m	Kg dB	E3(Pk) dBµV/m	E3(Avg)* dBµV/m	FCC/IC E3lim (Pk) dBµV/m	FCC/IC E3lim (Avg) dBµV/m	Pass dB	Comments
1	867.8	LOGEMCO01	H	210.0	1.00	22.2	-2.8	34.3	22.2	74.0	54.0	31.8	max all
2	867.8	LOGEMCO01	V	.0	1.30	22.2	-6.9	32.4	20.3	74.0	54.0	33.7	max all
3	1301.8	HQR1TO18S01	H/V	max all	1.50	32.4	-3.5	38.9	26.8	74.0	54.0	27.2	max all, noise
4	1735.7	HQR1TO18S01	H/V	max all	1.50	30.4	-4.2	43.0	30.9	74.0	54.0	23.1	max all, noise
5	2169.6	HQR1TO18S01	H/V	max all	1.50	29.8	-4.8	49.2	37.1	74.0	54.0	<b>16.9</b>	max all
6	2603.5	HQR1TO18S01	H/V	max all	1.50	30.1	-5.3	53.6	41.5	74.0	54.0	12.5	max all
7	3037.4	HQR1TO18S01	H/V	max all	1.50	30.7	-5.7	46.0	33.9	74.0	54.0	20.1	max all
8	3471.4	HQR1TO18S01	H/V	max all	1.50	31.3	-6.1	45.6	33.5	74.0	54.0	20.5	max all, noise
9	3905.3	HQR1TO18S01	H/V	max all	1.50	31.8	-6.4	46.8	34.7	74.0	54.0	19.3	max all, noise
10	4339.2	HQR1TO18S01	H/V	max all	1.50	32.1	-6.7	42.8	30.7	74.0	54.0	23.3	max all, noise
11													
12													
13													
14													
15													

\*Avg data computed from Peak Measured Data and EUT Duty Cycle. EUT in CW mode.



## 5 Measurement Uncertainty and Accreditation Documents

The maximum values of measurement uncertainty for the laboratory test equipment and facilities associated with each test are given in the table below. This uncertainty is computed for a 95.45% confidence level based on a coverage factor of  $k = 2$ .

Table 8: Measurement Uncertainty.

Measured Parameter	Measurement Uncertainty <sup>†</sup>
Radio Frequency	$\pm(f_{Mkr}/10^7 + RBW/10 + (SPN/(PTS - 1))/2 + 1 \text{ Hz})$
Conducted Emm. Amplitude	$\pm 1.9 \text{ dB}$
Radiated Emm. Amplitude (30 – 200 MHz)	$\pm 4.0 \text{ dB}$
Radiated Emm. Amplitude (200 – 1000 MHz)	$\pm 5.2 \text{ dB}$
Radiated Emm. Amplitude ( $f > 1000 \text{ MHz}$ )	$\pm 3.7 \text{ dB}$

<sup>†</sup>Ref: CISPR 16-4-2:2011+A1:2014



**FEDERAL COMMUNICATIONS COMMISSION**  
 Laboratory Division  
 7435 Oakland Mills Road  
 Columbia, MD 21046  
 July 06, 2018

National Voluntary Laboratory Accreditation Program  
 100 Bureau Drive  
 Gaithersburg, MD 20899-2140

Attention: Timothy Rasinski

Re: Accreditation of AHD (Amber Helm Development, L.C.)  
 Designation Number: US5348  
 Test Firm Registration #: 639064

Dear Sir or Madam:

We have been notified by National Voluntary Laboratory Accreditation Program that AHD (Amber Helm Development, L.C.) has been accredited as a testing laboratory.

At this time AHD (Amber Helm Development, L.C.) is hereby recognized to perform compliance testing on equipment subject to Declaration of Conformity (DOC) and Certification of the Commission's Rules.

This recognition will expire upon expiration of the accreditation or notification of withdrawal of recognition.

Any questions about this recognition should be submitted as an inquiry to the FCC Knowledge Database at [www.fcc.gov/kdb](http://www.fcc.gov/kdb).

Sincerely,

George Tanshill  
 Electronics Engineer



Figure 7: Accreditation Documents