

WesternUnion

TERMINAL PAYMENT CRADLE

XC70-W

INSTALLATION GUIDE

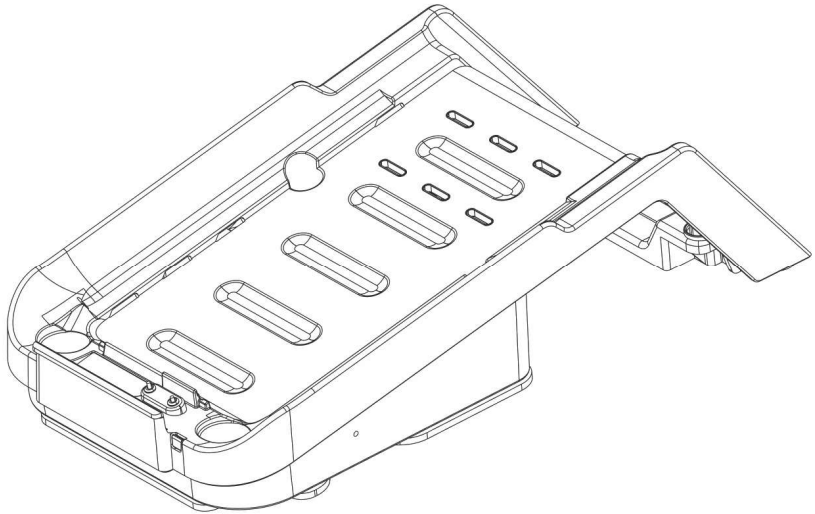

Model:
XC70-W

1. PACKAGE CONTENT

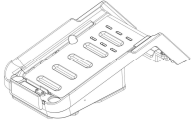

■ XC70-W

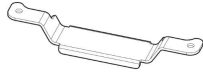

■ Cable holder*1



■ Adhesive Sticker*1
(Optional)



■ Screw*2(M3x6L)

2. DEVICE OVERVIEW

Device Overview

FRONT SIDE

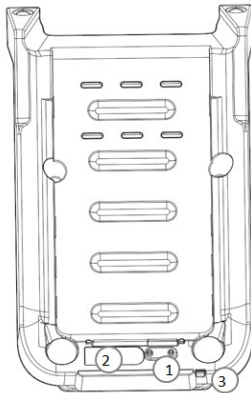

Figure 1

FRONT AREA	1	Charging Pin
	2	Rib
	3	LED

LEFT SIDE

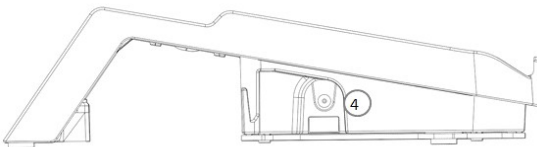
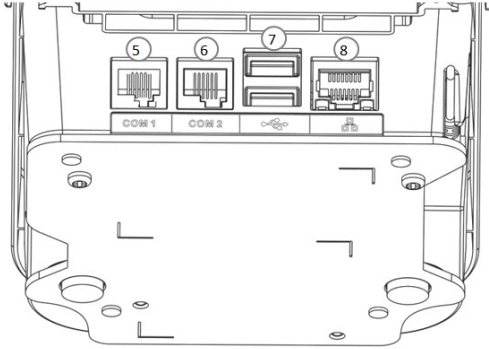

Figure 2

LEFT AREA	4	DC JACK
-----------	---	---------

IO PORT SIDE



IO PORT AREA	5	COM1
	6	COM2
	7	USB Host
	8	LAN

Figure 3

■XC70 Power spec:

Input: 12~24VDC, 2A

■Power Adapter spec:

Input: 100 ~240 ac

Output: 12~24VDC, 2Amin

3. INSTALLING CABLES

1. Plug in the DC Jack as Figure 4.
2. Plug in the USB/COM/Ethernet cable as Figure 5.
3. Using 2*M3x6L screws to fix cable holder as Figure 6.

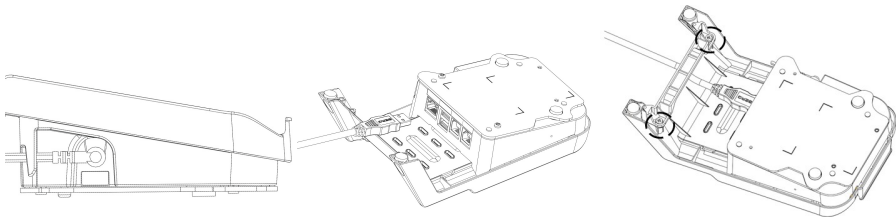

Figure 4 Figure 5 Figure 6

4. POWER ON/OFF THE DEVICE

To power ON the device: Plug-in the DC JACK

To power OFF the device: Un-Plug the DC JACK

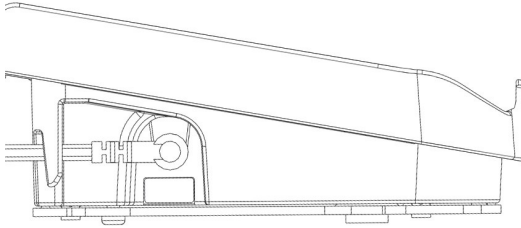

Figure 7

5. LED BEHAVIORS

Insert Power adapter and device will power up, there is a LED status (Figure 8):

- Blinking Red - System update process
- Solid Red - System errors and can't operation
- Solid Orange – System power on
- Solid Green – System power on and under connection
- Blinking Green – System power on and in idle mode

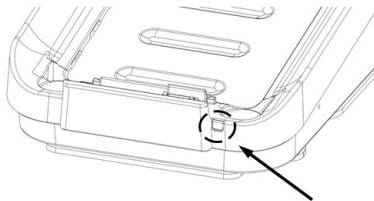

Figure 8

6. MOUNT THE STAND ON THE COUNTERTOP

Choose your preferred method of attaching the stand to the countertop.

METHOD #1: USING ADHESIVE STICKER

Remove the white protective sticker cover under the base as Figure 9 and press the base firmly to the countertop. (Note: The countertop should be wiped with detergent before using sticker)

METHOD #2: USING THE SCREWS

Use 2*M3 screws to mount stand on the countertop from bottom of countertop through screw hole as Figure 10. (Note: refer to countertop hole as Figure 11, screws lengths reference: 4mm + countertop thickness)

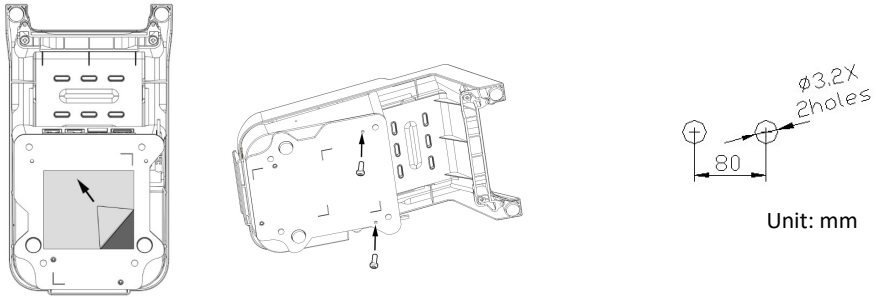

Figure 9 Figure 10 Figure 11

7. CONNECT WITH xCL_AT-170

Place xCL_AT-170 on the XC70 for charging and as Figure 12 and Figure 13.

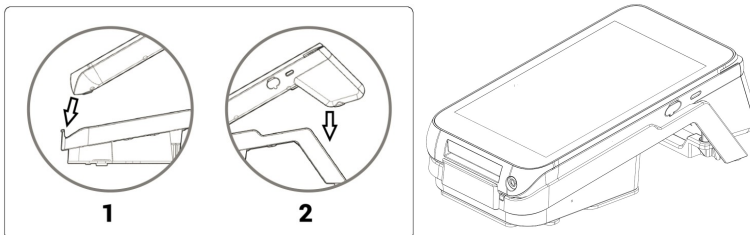

Figure 12 Figure 13

FEDERAL COMMUNICATION COMMISSION INTERFERENCE STATEMENT

This device complies with Part 15 of the FCC Rules. Operation is subject to the following two conditions: (1) This device may not cause harmful interference, and (2) this device must accept any interference received, including interference that may cause undesired operation.

Note: This equipment has been tested and found to comply with the limits for a Class B digital device, pursuant to Part 15 of the FCC Rules. These limits are designed to provide reasonable protection against harmful interference in a residential installation. This equipment generates, uses and can radiate radio frequency energy and, if not installed and used in accordance with the instructions, may cause harmful interference to radio communications. However, there is no guarantee that interference will not occur in a particular installation. If this equipment does cause harmful interference to radio or television reception, which can be determined by turning the equipment off and on, the user is encouraged to try to correct the interference by one of the following measures:

- Reorient or relocate the receiving antenna.
- Increase the separation between the equipment and receiver.
- Connect the equipment into an outlet on a circuit different from that to which the receiver is connected.
- Consult the dealer or an experienced radio/TV technician for help.

FCC Caution: Any changes or modifications not expressly approved by the party responsible for compliance could void the user's authority to operate this equipment.

This transmitter must not be co-located or operating in conjunction with any other antenna or transmitter.

RADIATION EXPOSURE STATEMENT:

This equipment complies with FCC radiation exposure limits set forth for an uncontrolled environment. This equipment should be installed and operated with minimum distance 20cm between the radiator & your body.



XAC Automation Corporation
886-3-577-2738
www.xac.com.tw

The above information is the exclusive intellectual property of XAC Automation Corporation and shall not be disclosed, distributed or reproduced without permission of XAC Automation Corporation.

XAC AUTOMATION CORP. shall not be held liable for technical and editorial omissions or errors made herein; nor for incidental or consequential damages resulting from the furnishing, performance or use of his material.



241990000