



# FCC TEST REPORT (WLAN)

**REPORT NO.:** RF131029E03B

**MODEL NO.:** xAPT-103WiFi

**FCC ID:** MQT-XAPT103WIFI

**RECEIVED:** Oct. 22, 2013

**TESTED:** Oct. 22 to 31, 2013 and Feb. 11, 2014

**ISSUED:** Feb. 18, 2014

**APPLICANT:** XAC AUTOMATION CORP.

**ADDRESS:** 4F, No. 30, INDUSTRY E. RD. IX,  
SCIENCE-BASED INDUSTRIAL  
PARK,HSINCHU,TAIWAN

**ISSUED BY:** Bureau Veritas Consumer Products Services  
(H.K.) Ltd., Taoyuan Branch Hsin Chu Laboratory

**LAB ADDRESS :** No. 81-1, Lu Liao Keng, 9th Ling, Wu Lung Tsuen,  
Chiung Lin Hsiang, Hsin Chu Hsien 307, Taiwan,  
R.O.C.

**TEST LOCATION (1):** No. 81-1, Lu Liao Keng, 9th Ling, Wu Lung Tsuen,  
Chiung Lin Hsiang, Hsin Chu Hsien 307, Taiwan,  
R.O.C.

**TEST LOCATION (2):** No. 49, Ln. 206, Wende Rd., Shangshan Tsuen,  
Chiung Lin Hsiang, Hsin Chu Hsien 307, Taiwan,  
R.O.C.

This report should not be used by the client to claim product certification, approval, or endorsement by TAF or any government agencies.



This report is for your exclusive use. Any copying or replication of this report to or for any other person or entity, or use of our name or trademark, is permitted only with our prior written permission. This report sets forth our findings solely with respect to the test samples identified herein. The results set forth in this report are not indicative or representative of the quality or characteristics of the lot from which a test sample was taken or any similar or identical product unless specifically and expressly noted. Our report includes all of the tests requested by you and the results thereof based upon the information that you provided to us. You have 60 days from date of issuance of this report to notify us of any material error or omission caused by our negligence, provided, however, that such notice shall be in writing and shall specifically address the issue you wish to raise. A failure to raise such issue within the prescribed time shall constitute your unqualified acceptance of the completeness of this report, the tests conducted and the correctness of the report contents. Unless specific mention, the uncertainty of measurement has been explicitly taken into account to declare the compliance or non-compliance to the specification



A D T

## Table of Contents

RELEASE CONTROL RECORD .....	4
1. CERTIFICATION .....	5
2. SUMMARY OF TEST RESULTS .....	6
2.1 MEASUREMENT UNCERTAINTY .....	7
3. GENERAL INFORMATION .....	8
3.1 GENERAL DESCRIPTION OF EUT .....	8
3.2 DESCRIPTION OF TEST MODES .....	10
3.2.1 TEST MODE APPLICABILITY AND TESTED CHANNEL DETAIL .....	11
3.3 GENERAL DESCRIPTION OF APPLIED STANDARDS .....	14
3.4 DUTY CYCLE OF TEST SIGNAL .....	15
3.5 DESCRIPTION OF SUPPORT UNITS .....	16
3.6 CONFIGURATION OF SYSTEM UNDER TEST .....	17
4. TEST TYPES AND RESULTS .....	18
4.1 CONDUCTED EMISSION MEASUREMENT .....	18
4.1.1 LIMITS OF CONDUCTED EMISSION MEASUREMENT .....	18
4.1.2 TEST INSTRUMENTS .....	18
4.1.3 TEST PROCEDURES .....	19
4.1.4 DEVIATION FROM TEST STANDARD .....	19
4.1.5 TEST SETUP .....	19
4.1.6 EUT OPERATING CONDITIONS .....	20
4.1.7 TEST RESULTS .....	21
4.2 RADIATED EMISSION AND BANDEDGE MEASUREMENT .....	23
4.2.1 LIMITS OF RADIATED EMISSION AND BANDEDGE MEASUREMENT .....	23
4.2.2 TEST INSTRUMENTS .....	24
4.2.3 TEST PROCEDURES .....	26
4.2.4 DEVIATION FROM TEST STANDARD .....	26
4.2.5 TEST SETUP .....	27
4.2.6 EUT OPERATING CONDITIONS .....	27
4.2.7 TEST RESULTS .....	28
4.3 6dB BANDWIDTH MEASUREMENT .....	41
4.3.1 LIMITS OF 6dB BANDWIDTH MEASUREMENT .....	41
4.3.2 TEST INSTRUMENTS .....	41
4.3.3 TEST PROCEDURE .....	41
4.3.4 DEVIATION FROM TEST STANDARD .....	41
4.3.5 TEST SETUP .....	41
4.3.6 EUT OPERATING CONDITIONS .....	41
4.3.7 TEST RESULTS .....	42
4.4 CONDUCTED OUTPUT POWER MEASUREMENT .....	44
4.4.1 LIMITS OF MAXIMUM PEAK OUTPUT POWER MEASUREMENT .....	44
4.4.2 INSTRUMENTS .....	44
4.4.3 TEST PROCEDURES .....	44
4.4.4 DEVIATION FROM TEST STANDARD .....	44
4.4.5 TEST SETUP .....	44
4.4.6 EUT OPERATING CONDITIONS .....	44
4.4.7 TEST RESULTS .....	45
4.5 AVERAGE OUTPUT POWER .....	46
4.5.1 FOR REFERENCE .....	46
4.5.2 TEST INSTRUMENTS .....	46
4.5.3 TEST PROCEDURES .....	46
4.5.4 TEST SETUP .....	46



A D T

4.5.5	EUT OPERATING CONDITIONS .....	46
4.5.6	TEST RESULTS .....	47
4.6	POWER SPECTRAL DENSITY MEASUREMENT .....	48
4.6.1	LIMITS OF POWER SPECTRAL DENSITY MEASUREMENT .....	48
4.6.2	TEST INSTRUMENTS.....	48
4.6.3	TEST PROCEDURE.....	48
4.6.4	DEVIATION FROM TEST STANDARD.....	48
4.6.5	TEST SETUP .....	48
4.6.6	EUT OPERATING CONDITION.....	48
4.6.7	TEST RESULTS .....	49
4.7	CONDUCTED OUT-BAND EMISSION MEASUREMENT.....	51
4.7.1	LIMITS OF CONDUCTED OUT-BAND EMISSION MEASUREMENT.....	51
4.7.2	TEST INSTRUMENTS.....	51
4.7.3	TEST PROCEDURE.....	51
4.7.4	DEVIATION FROM TEST STANDARD.....	52
4.7.5	TEST SETUP .....	52
4.7.6	EUT OPERATING CONDITION.....	52
4.7.7	TEST RESULTS .....	52
5.	PHOTOGRAPHS OF THE TEST CONFIGURATION.....	57
6.	INFORMATION ON THE TESTING LABORATORIES .....	58
7.	APPENDIX A - MODIFICATIONS RECORDERS FOR ENGINEERING CHANGES TO THE EUT BY THE LAB.....	59



A D T

## RELEASE CONTROL RECORD

ISSUE NO.	REASON FOR CHANGE	DATE ISSUED
RF131029E03B	Original release	Feb. 18, 2014



A D T

## 1. CERTIFICATION

**PRODUCT:** Terminal  
**BRAND NAME:** XAC  
**MODEL NO.:** xAPT-103WiFi  
**TEST SAMPLE:** ENGINEERING SAMPLE  
**APPLICANT:** XAC AUTOMATION CORP.  
**TESTED:** Oct. 22 to 31, 2013 and Feb. 11, 2014  
**STANDARDS:** **FCC Part 15, Subpart C (Section 15.247)**  
ANSI C63.10-2009

The above equipment (Model: xAPT-103WiFi) has been tested by **Bureau Veritas Consumer Products Services (H.K.) Ltd., Taoyuan Branch**, and found compliance with the requirement of the above standards. The test record, data evaluation & Equipment Under Test (EUT) configurations represented herein are true and accurate accounts of the measurements of the sample's EMC characteristics under the conditions specified in this report.

**PREPARED BY :** Midoli Peng , **DATE:** Feb. 18, 2014  
( Midoli Peng, Specialist )

**APPROVED BY :** May Chen , **DATE:** Feb. 18, 2014  
( May Chen, Manager )

## 2. SUMMARY OF TEST RESULTS

The EUT has been tested according to the following specifications:

<b>APPLIED STANDARD: FCC PART 15, SUBPART C (SECTION 15.247)</b>			
<b>STANDARD SECTION</b>	<b>TEST TYPE</b>	<b>RESULT</b>	<b>REMARK</b>
15.207	AC Power Conducted Emission	PASS	Meet the requirement of limit. Minimum passing margin is -13.31dB at 0.16562MHz
15.247(d) 15.209	Radiated Emissions	PASS	Meet the requirement of limit. Minimum passing margin is -1.6dB at 180.01MHz
15.247(d)	Band Edge Measurement	PASS	Meet the requirement of limit.
15.247(a)(2)	6dB bandwidth	PASS	Meet the requirement of limit.
15.247(b)	Conducted output power	PASS	Meet the requirement of limit.
15.247(e)	Power Spectral Density	PASS	Meet the requirement of limit.
15.203	Antenna Requirement	PASS	No antenna connector is used.



A D T

## 2.1 MEASUREMENT UNCERTAINTY

Where relevant, the following measurement uncertainty levels have been estimated for tests performed on the EUT as specified in CISPR 16-4-2:

This uncertainty represents an expanded uncertainty expressed at approximately the 95% confidence level using a coverage factor of  $k=2$ .

Measurement	Value
Conducted emissions	2.98 dB
Radiated emissions (30MHz-1GHz)	5.37 dB
Radiated emissions (1GHz -6GHz)	3.54 dB
Radiated emissions (6GHz -18GHz)	4.08 dB
Radiated emissions (18GHz -40GHz)	4.11 dB

### 3. GENERAL INFORMATION

#### 3.1 GENERAL DESCRIPTION OF EUT(WLAN)

<b>PRODUCT</b>	Terminal
<b>MODEL NO.</b>	xAPT-103WiFi
<b>POWER SUPPLY</b>	DC 12V from power adapter
<b>MODULATION TYPE</b>	CCK, DQPSK, DBPSK for DSSS 64QAM, 16QAM, QPSK, BPSK for OFDM
<b>MODULATION TECHNOLOGY</b>	DSSS,OFDM
<b>TRANSFER RATE</b>	802.11b: up to 11Mbps 802.11a/g: up to 54Mbps 802.11n: up to 150Mbps
<b>OPERATING FREQUENCY</b>	2.412 ~ 2.462GHz
<b>NUMBER OF CHANNEL</b>	802.11b & g & 802.11n (HT20): 11 802.11n (HT40): 7
<b>MAXIMUM OUTPUT POWER</b>	802.11b: 33.420mW 802.11g: 129.718mW 802.11n (HT20): 118.577mW 802.11n (HT40): 103.276mW
<b>ANTENNA TYPE</b>	Please see NOTE
<b>DATA CABLE</b>	NA
<b>I/O PORTS</b>	Refer to user's manual
<b>ASSOCIATED DEVICES</b>	Adapter × 1

**NOTE:**

1. The EUT is a WLAN and RFID device.
2. WLAN and RFID technology cannot transmit at same time.
3. The EUT could be supplied with a power adapter as the following table:

Brand	Model No.	Spec.
HON-KWANG	HK-AX-120A200-US	AC I/P: 100-240V, 50/60Hz, 0.8A DC O/P: 12V, 2A DC output cable(Unshielded, 1.5m)



4. The antennas provided to the EUT, please refer to the following table:

<b>RFID Antenna Spec.</b>						
Brand	Model No.		Antenna Type	Antenna Connector	Gain(dBi)	Frequency (MHz)
XAC	PCB ENIG ANT BOARD (W/KEY) 8006(ROHS)		PCB (2 Layer)	NA	13	13.56
<b>WLAN Antenna Spec.</b>						
Transmitter Circuit	Brand	Model No.	Antenna Type	Antenna Connector	Gain(dBi)	Frequency (MHz)
Chain (0)	HUN-PAI	M30-005+-000	PIFA	NA	1.5	2400-2500
Chain (1)					2.9	
NOTE: 1. Chain (0) -- Tx & Rx / Chain (1) -- Tx						

5. The EUT incorporates a SISO function.

<b>MODULATION MODE</b>	<b>Tx/Rx FUNCTION</b>
<b>802.11b</b>	1Tx/1Rx (Diversity)
<b>802.11g</b>	1Tx/1Rx (Diversity)
<b>802.11n (HT20)</b>	1Tx/1Rx (Diversity)
<b>802.11n (HT40)</b>	1Tx/1Rx (Diversity)

6. When the EUT operating in 802.11n, the software operation, which is defined by manufacturer, MCS (Modulation and Coding Schemes) from 0 to 7.

7. The above EUT information was declared by the manufacturer and for more detailed features description, please refer to the manufacturer's specifications or User's Manual.

### 3.2 DESCRIPTION OF TEST MODES

11 channels are provided for 802.11b, 802.11g, 802.11n (HT20):

CHANNEL	FREQUENCY	CHANNEL	FREQUENCY
1	2412MHz	7	2442MHz
2	2417MHz	8	2447MHz
3	2422MHz	9	2452MHz
4	2427MHz	10	2457MHz
5	2432MHz	11	2462MHz
6	2437MHz		

7 channels are provided for 802.11n (HT40):

CHANNEL	FREQUENCY	CHANNEL	FREQUENCY
3	2422MHz	7	2442MHz
4	2427MHz	8	2447MHz
5	2432MHz	9	2452MHz
6	2437MHz		

### 3.2.1 TEST MODE APPLICABILITY AND TESTED CHANNEL DETAIL

EUT CONFIGURE MODE	APPLICABLE TO					DESCRIPTION
	PLC	RE < 1G	RE ≥ 1G	APCM	OB	
-	√	√	√	√	√	-

Where **PLC**: Power Line Conducted Emission      **RE < 1G**: Radiated Emission below 1GHz  
**RE ≥ 1G**: Radiated Emission above 1GHz      **APCM**: Antenna Port Conducted Measurement  
**OB**: Conducted Out-Band Emission Measurement

**NOTE:** 1. "-" means no effect.

#### **POWER LINE CONDUCTED EMISSION TEST:**

- Pre-Scan has been conducted to determine the worst-case mode from all possible combinations between available modulations, data rates and antenna ports (if EUT with antenna diversity architecture).
- Following channel(s) was (were) selected for the final test as listed below.

MODE	AVAILABLE CHANNEL	TESTED CHANNEL	MODULATION TECHNOLOGY	MODULATION TYPE	DATA RATE (Mbps)
802.11g	1 to 11	1	OFDM	BPSK	6

#### **RADIATED EMISSION TEST (BELOW 1 GHz):**

- Pre-Scan has been conducted to determine the worst-case mode from all possible combinations between available modulations, data rates and antenna ports (if EUT with antenna diversity architecture).
- Following channel(s) was (were) selected for the final test as listed below.

MODE	AVAILABLE CHANNEL	TESTED CHANNEL	MODULATION TECHNOLOGY	MODULATION TYPE	DATA RATE (Mbps)
802.11g	1 to 11	1	OFDM	BPSK	6



A D T

**RADIATED EMISSION TEST (ABOVE 1 GHz):**

- Pre-Scan has been conducted to determine the worst-case mode from all possible combinations between available modulations, data rates and antenna ports (if EUT with antenna diversity architecture).
- Following channel(s) was (were) selected for the final test as listed below.

MODE	AVAILABLE CHANNEL	TESTED CHANNEL	MODULATION TECHNOLOGY	MODULATION TYPE	DATA RATE (Mbps)
802.11b	1 to 11	1, 6, 11	DSSS	DBPSK	1
802.11g	1 to 11	1, 6, 11	OFDM	BPSK	6
802.11n (HT20)	1 to 11	1, 6, 11	OFDM	BPSK	6.5
802.11n (HT40)	3 to 9	3, 6, 9	OFDM	BPSK	13.5

**ANTENNA PORT CONDUCTED MEASUREMENT:**

- Pre-Scan has been conducted to determine the worst-case mode from all possible combinations between available modulations, data rates and antenna ports (if EUT with antenna diversity architecture).
- Following channel(s) was (were) selected for the final test as listed below.

MODE	AVAILABLE CHANNEL	TESTED CHANNEL	MODULATION TECHNOLOGY	MODULATION TYPE	DATA RATE (Mbps)
802.11b	1 to 11	1, 6, 11	DSSS	DBPSK	1
802.11g	1 to 11	1, 6, 11	OFDM	BPSK	6
802.11n (HT20)	1 to 11	1, 6, 11	OFDM	BPSK	6.5
802.11n (HT40)	3 to 9	3, 6, 9	OFDM	BPSK	13.5

**CONDUCTED OUT-BAND EMISSION MEASUREMENT:**

- Pre-Scan has been conducted to determine the worst-case mode from all possible combinations between available modulations, data rates and antenna ports (if EUT with antenna diversity architecture).
- Following channel(s) was (were) selected for the final test as listed below.

MODE	AVAILABLE CHANNEL	TESTED CHANNEL	MODULATION TECHNOLOGY	MODULATION TYPE	DATA RATE (Mbps)
802.11b	1 to 11	1, 6, 11	DSSS	DBPSK	1
802.11g	1 to 11	1, 6, 11	OFDM	BPSK	6
802.11n (HT20)	1 to 11	1, 6, 11	OFDM	BPSK	6.5
802.11n (HT40)	3 to 9	3, 6, 9	OFDM	BPSK	13.5

**TEST CONDITION:**

APPLICABLE TO	ENVIRONMENTAL CONDITIONS	INPUT POWER	TESTED BY
PLC	25deg. C, 53%RH	120Vac, 60Hz	Jyunchun Lin
RE<1G	23deg. C, 71%RH	120Vac, 60Hz	Tim Ho
RE <sup>3</sup> 1G	23deg. C, 69%RH	120Vac, 60Hz	Robert Cheng Andy Ho
APCM	25deg. C, 60%RH	120Vac, 60Hz	Robert Cheng
OB	25deg. C, 60%RH	120Vac, 60Hz	Robert Cheng

### **3.3 GENERAL DESCRIPTION OF APPLIED STANDARDS**

The EUT is a RF product. According to the specifications of the manufacturer, it must comply with the requirements of the following standards:

**FCC Part 15, Subpart C (15.247)**

**558074 D01 DTS Meas Guidance v03r01**

**ANSI C63.10-2009**

All test items have been performed and recorded as per the above standards.



A D T

### 3.4 DUTY CYCLE OF TEST SIGNAL

Duty cycle of test signal is 100 %, duty factor is not required.

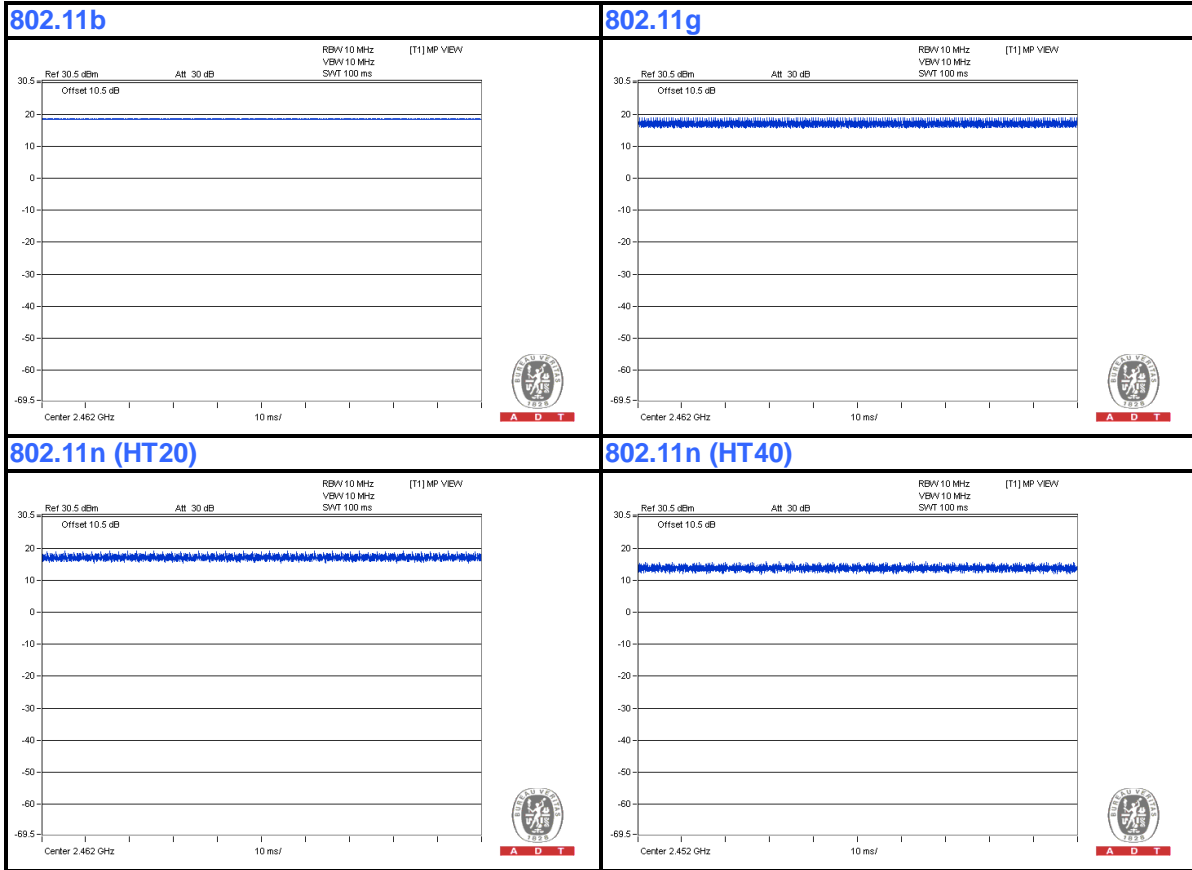



A D T

### 3.5 DESCRIPTION OF SUPPORT UNITS

The EUT has been tested as an independent unit together with other necessary accessories or support units. The following support units or accessories were used to form a representative test configuration during the tests.

NO.	PRODUCT	BRAND	MODEL NO.	SERIAL NO.	FCC ID
1	NOTEBOOK COMPUTER	DELL	PP32LA	FSLB32S	FCC DoC
2	iPod shuffle	Apple	MC749TA/A	CC4DN25WDFDM	NA
3	iPod shuffle	Apple	MC749TA/A	CC4DMFJUDFDM	NA
4	PROGRAM-CONTROL TELEPHONE EXCHANGE	TELTONE	TC-104H	TC001	NA

NO.	SIGNAL CABLE DESCRIPTION OF THE ABOVE SUPPORT UNITS
1	UTP cable, 10m
2	USB cable, 0.1m
3	USB cable, 0.1m
4	RJ-11 cable, 10m

**NOTE:** All power cords of the above support units are non shielded (1.8m).



### 3.6 CONFIGURATION OF SYSTEM UNDER TEST

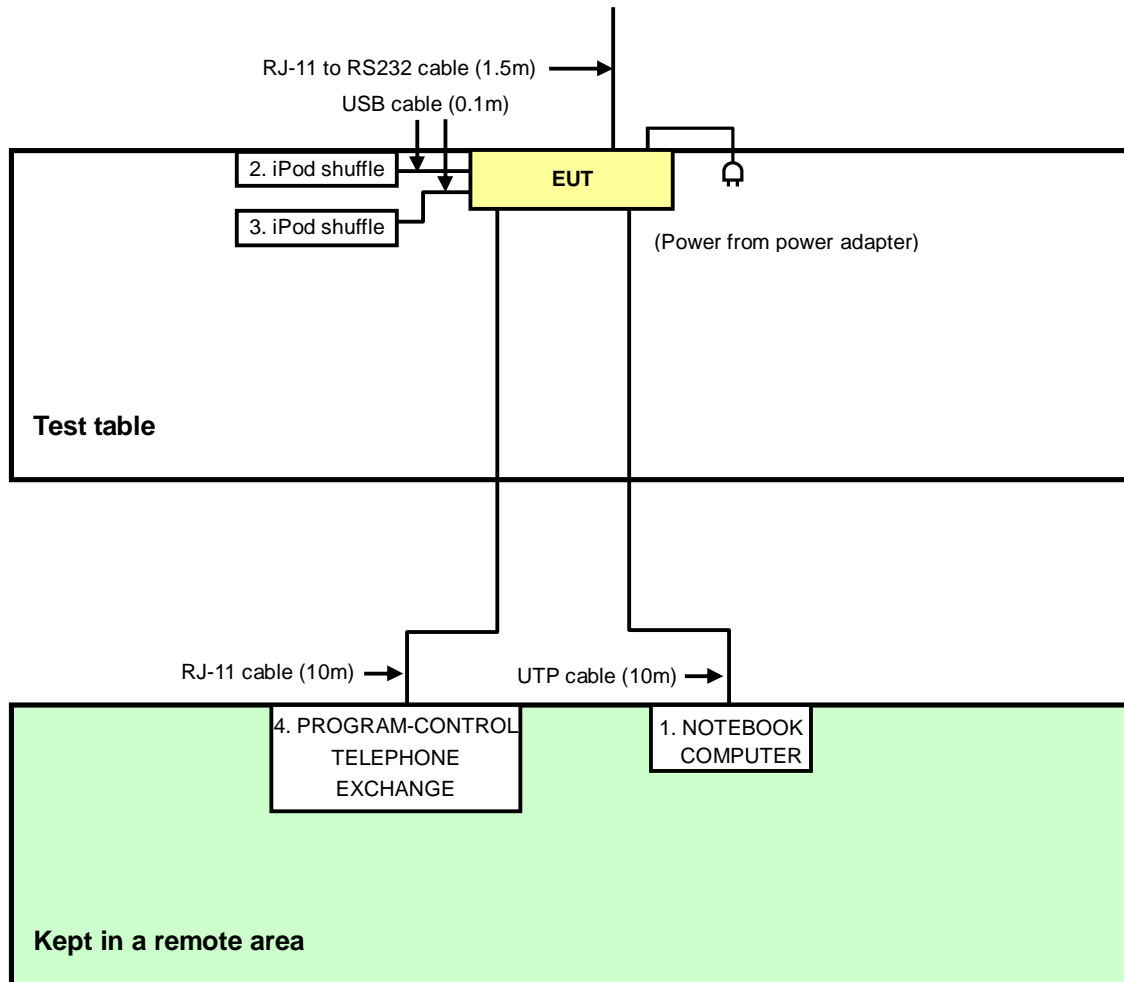



A D T

## 4. TEST TYPES AND RESULTS

### 4.1 CONDUCTED EMISSION MEASUREMENT

#### 4.1.1 LIMITS OF CONDUCTED EMISSION MEASUREMENT

FREQUENCY OF EMISSION (MHz)	CONDUCTED LIMIT (dB $\mu$ V)	
	Quasi-peak	Average
0.15-0.5	66 to 56	56 to 46
0.5-5	56	46
5-30	60	50

- NOTE:**
1. The lower limit shall apply at the transition frequencies.
  2. The limit decreases in line with the logarithm of the frequency in the range of 0.15 to 0.50 MHz.

#### 4.1.2 TEST INSTRUMENTS

DESCRIPTION & MANUFACTURER	MODEL NO.	SERIAL NO.	CALIBRATED DATE	CALIBRATED UNTIL
Test Receiver ROHDE & SCHWARZ	ESCS 30	100375	Mar. 08, 2013	Mar. 07, 2014
Line-Impedance Stabilization Network (for EUT) SCHWARZBECK	NSLK8127	8127-522	Sep. 05, 2013	Sep. 04, 2014
Line-Impedance Stabilization Network (for Peripheral)	ENV216	100072	June 06, 2013	June 05, 2014
RF Cable (JYEBAO)	5DFB	COCCAB-001	Mar. 11, 2013	Mar. 10, 2014
50 ohms Terminator	50	EMC-03	Sep. 24, 2013	Sep. 23, 2014
Software ADT	BV ADT_Cond_V7.3.7. 3	NA	NA	NA

**Note:**

1. The calibration interval of the above test instruments is 12 months and the calibrations are traceable to NML/ROC and NIST/USA.
2. The test was performed in Shielded Room No. C.
3. The VCCI Con C Registration No. is C-3611.
4. Tested Date: Oct. 22, 2013

#### 4.1.3 TEST PROCEDURES

- a. The EUT was placed 0.4 meters from the conducting wall of the shielded room with EUT being connected to the power mains through a line impedance stabilization network (LISN). Other support units were connected to the power mains through another LISN.
- b. The two LISNs provide 50 ohm/ 50uH of coupling impedance for the measuring instrument.
- c. Both lines of the power mains connected to the EUT were checked for maximum conducted interference.
- d. The frequency range from 150kHz to 30MHz was searched. Emission levels under (Limit - 20dB) were not recorded.

#### NOTE:

1. The resolution bandwidth of test receiver is 9kHz for Quasi-peak detection (QP) & Average detection (AV).

#### 4.1.4 DEVIATION FROM TEST STANDARD

No deviation

#### 4.1.5 TEST SETUP

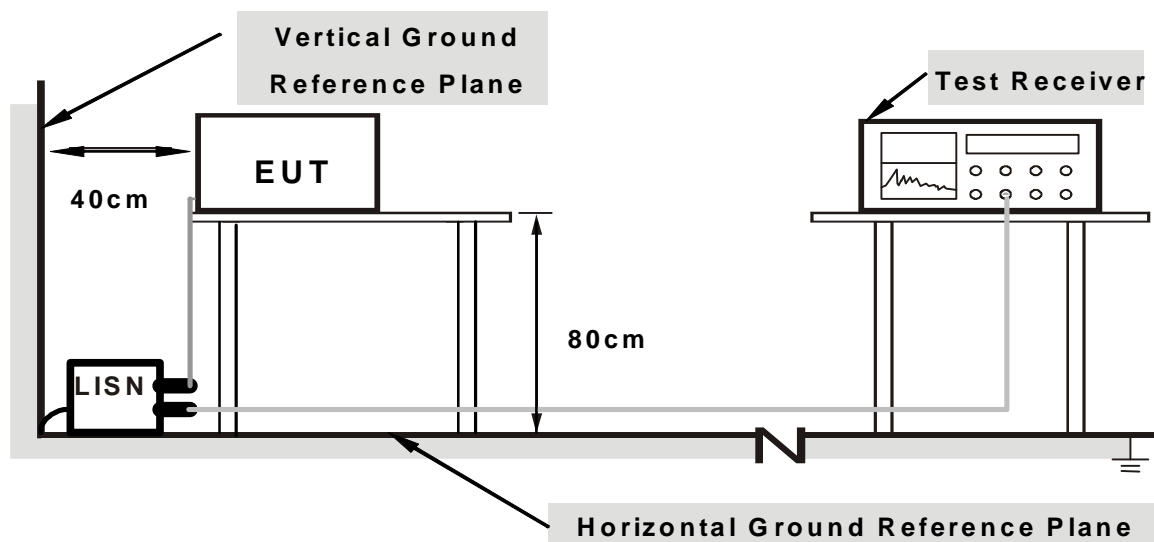

**Note: 1. Support units were connected to second LISN.**

For the actual test configuration, please refer to the related item – Photographs of the Test Configuration.

#### 4.1.6 EUT OPERATING CONDITIONS

1. Turn on the power of EUT.
2. The communication partner run test program “RT5x7xQA.exe” to enable EUT under transmission/receiving condition continuously at specific channel frequency.

### 4.1.7 TEST RESULTS

PHASE	Line (L)	DETECTOR FUNCTION	Quasi-Peak (QP) / Average (AV)
-------	----------	-------------------	--------------------------------

No	Freq.	Corr.	Reading Value		Emission Level		Limit		Margin	
	[MHz]	Factor (dB)	[dB (uV)]		[dB (uV)]		[dB (uV)]		(dB)	
			Q.P.	AV.	Q.P.	AV.	Q.P.	AV.	Q.P.	AV.
1	0.16562	0.05	48.14	41.81	48.19	41.86	65.18	55.18	-16.98	-13.31
2	0.19297	0.06	42.42	28.85	42.48	28.91	63.91	53.91	-21.43	-25.00
3	0.21641	0.06	39.11	22.17	39.17	22.23	62.96	52.96	-23.78	-30.72
4	0.40391	0.11	25.01	17.30	25.12	17.41	57.77	47.77	-32.65	-30.36
5	3.82813	0.33	16.63	5.50	16.96	5.83	56.00	46.00	-39.04	-40.17
6	22.29688	0.88	31.14	26.87	32.02	27.75	60.00	50.00	-27.98	-22.25

**REMARKS:**

1. Q.P. and AV. are abbreviations of quasi-peak and average individually.
2. The emission levels of other frequencies were very low against the limit.
3. Margin value = Emission level – Limit value
4. Correction factor = Insertion loss + Cable loss
5. Emission Level = Correction Factor + Reading Value

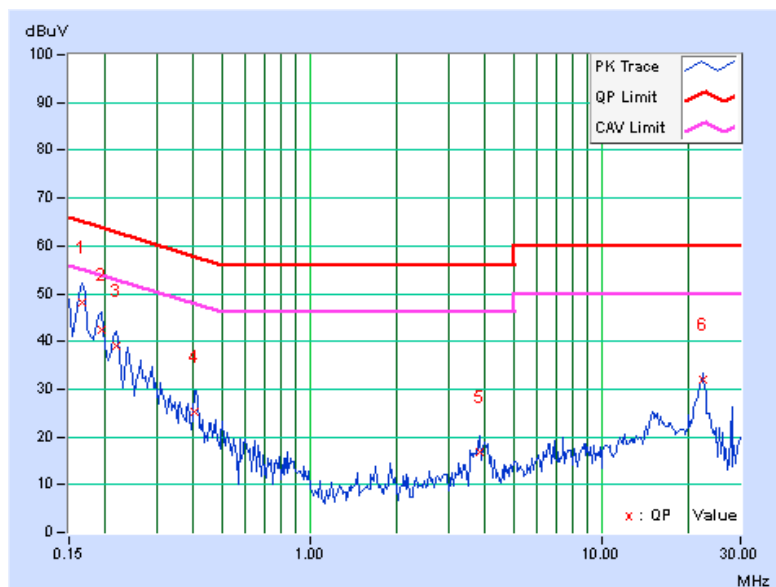



A D T

<b>PHASE</b>	Neutral (N)	<b>DETECTOR FUNCTION</b>	Quasi-Peak (QP) / Average (AV)
--------------	-------------	--------------------------	--------------------------------

No	Freq.	Corr.	Reading Value		Emission Level		Limit		Margin	
	[MHz]	Factor (dB)	[dB (uV)]		[dB (uV)]		[dB (uV)]		(dB)	
			Q.P.	AV.	Q.P.	AV.	Q.P.	AV.	Q.P.	AV.
1	0.16562	0.05	48.36	41.61	48.41	41.66	65.18	55.18	-16.77	-13.52
2	0.19297	0.05	42.64	28.71	42.69	28.76	63.91	53.91	-21.22	-25.15
3	0.23594	0.06	34.42	18.46	34.48	18.52	62.24	52.24	-27.76	-33.72
4	0.40781	0.11	25.95	11.46	26.06	11.57	57.69	47.69	-31.63	-36.12
5	3.66016	0.24	14.09	8.49	14.33	8.73	56.00	46.00	-41.67	-37.27
6	22.06250	0.82	27.53	20.46	28.35	21.28	60.00	50.00	-31.65	-28.72

**REMARKS:**

1. Q.P. and AV. are abbreviations of quasi-peak and average individually.
2. The emission levels of other frequencies were very low against the limit.
3. Margin value = Emission level – Limit value
4. Correction factor = Insertion loss + Cable loss
5. Emission Level = Correction Factor + Reading Value

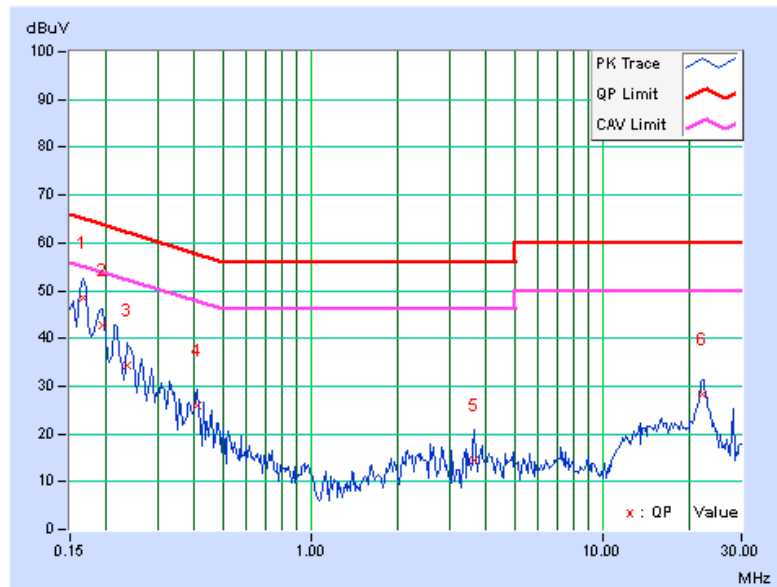

## 4.2 RADIATED EMISSION AND BANDEGE MEASUREMENT

### 4.2.1 LIMITS OF RADIATED EMISSION AND BANDEGE MEASUREMENT

Radiated emissions which fall in the restricted bands must comply with the radiated emission limits specified as below table. Other emissions shall be at least 20dB below the highest level of the desired power:

Frequencies (MHz)	Field strength (microvolts/meter)	Measurement distance (meters)
0.009-0.490	2400/F(kHz)	300
0.490-1.705	24000/F(kHz)	30
1.705-30.0	30	30
30-88	100	3
88-216	150	3
216-960	200	3
Above 960	500	3

**NOTE:**

1. The lower limit shall apply at the transition frequencies.
2. Emission level (dBuV/m) = 20 log Emission level (uV/m).
3. For frequencies above 1000MHz, the field strength limits are based on average detector, however, the peak field strength of any emission shall not exceed the maximum permitted average limits, specified above by more than 20dB under any condition of modulation.



A D T

## 4.2.2 TEST INSTRUMENTS

### Below 1GHz test:

DESCRIPTION & MANUFACTURER	MODEL NO.	SERIAL NO.	CALIBRATED DATE	CALIBRATED UNTIL
MXE EMI Receiver Agilent	N9038A	MY51210105	Jan. 21, 2014	Jan. 20, 2015
Pre-Amplifier Mini-Circuits	ZFL-1000VH2 B	AMP-ZFL-03	Nov. 13, 2013	Nov. 12, 2014
Trilog Broadband Antenna SCHWARZBECK	VULB 9168	9168-360	Mar. 19, 2013	Mar. 18, 2014
RF Cable	NA	CHGCAB_001	Oct. 05, 2013	Oct. 04, 2014
Spectrum Analyzer R&S	FSV40	100964	July 15, 2013	July 14, 2014
Horn_Antenna AISI	AIH.8018	0000320091110	Nov. 18, 2013	Nov. 17, 2014
Pre-Amplifier Agilent	8449B	3008A02578	June 25, 2013	June 24, 2014
RF Cable	NA	RF104-201 RF104-203 RF104-204	Dec. 12, 2013	Dec. 11, 2014
Spectrum Analyzer Agilent	E4446A	MY48250253	Aug. 28, 2013	Aug. 27, 2014
Pre-Amplifier SPACEK LABS	SLKKa-48-6	9K16	Nov. 13, 2013	Nov. 12, 2014
Horn_Antenna SCHWARZBECK	BBHA 9170	9170-424	Oct. 08, 2013	Oct. 07, 2014
Software	ADT_Radiated _V8.7.07	NA	NA	NA
Antenna Tower & Turn Table CT	NA	NA	NA	NA

### Note:

1. The calibration interval of the above test instruments is 12 months and the calibrations are traceable to NML/ROC and NIST/USA.
2. The horn antenna, preamplifier (model: 8449B) are used only for the measurement of emission frequency above 1GHz if tested.
- 3 The test was performed in 966 Chamber No. G.
4. The FCC Site Registration No. is 966073.
- 5 The VCCI Site Registration No. is G-137.
- 6 The CANADA Site Registration No. is IC 7450H-2.
- 7 Tested Date: Feb. 11, 2014





A D T

**Above 1GHz test:**

DESCRIPTION & MANUFACTURER	MODEL NO.	SERIAL NO.	CALIBRATED DATE	CALIBRATED UNTIL
MXE EMI Receiver Agilent	N9038A	MY50010156	Jan. 16, 2013	Jan. 15, 2014
Pre-Amplifier Mini-Circuits	ZFL-1000VH2 B	AMP-ZFL-04	Nov. 14, 2012	Nov. 13, 2013
Trilog Broadband Antenna SCHWARZBECK	VULB 9168	9168-361	Mar. 25, 2013	Mar. 24, 2014
RF Cable	NA	CHHCAB_001	Oct. 06, 2013	Oct. 05, 2014
Horn_Antenna AISL	AIH.8018	0000220091110	Nov. 27, 2012	Nov. 26, 2013
Pre-Amplifier Agilent	8449B	3008A01923	Oct. 30, 2012	Oct. 29, 2013
RF Cable	NA	RF104-205 RF104-207 RF104-202	Dec. 26, 2012	Dec. 25, 2013
Spectrum Analyzer Agilent	E4446A	MY48250253	Aug. 28, 2013	Aug. 27, 2014
Pre-Amplifier SPACEK LABS	SLKKa-48-6	9K16	Nov. 14, 2012	Nov. 13, 2013
Horn_Antenna SCHWARZBECK	BBHA 9170	9170-424	Oct. 08, 2013	Oct. 07, 2014
Software	ADT_Radiated _V8.7.07	NA	NA	NA
Antenna Tower & Turn Table CT	NA	NA	NA	NA

**Note:**

1. The calibration interval of the above test instruments is 12 months and the calibrations are traceable to NML/ROC and NIST/USA.
2. The horn antenna, preamplifier (model: 8449B) are used only for the measurement of emission frequency above 1GHz if tested.
3. The test was performed in 966 Chamber No. H.
4. The FCC Site Registration No. is 797305.
5. The CANADA Site Registration No. is IC 7450H-3.
6. Tested Date: Oct. 26, 2013

#### 4.2.3 TEST PROCEDURES

- a. The EUT was placed on the top of a rotating table 0.8 meters above the ground at 3 meter chamber room for test. The table was rotated 360 degrees to determine the position of the highest radiation.
- b. The EUT was set 3 meters away from the interference-receiving antenna, which was mounted on the top of a variable-height antenna tower.
- c. The height of antenna is varied from one meter to four meters above the ground to determine the maximum value of the field strength. Both horizontal and vertical polarizations of the antenna are set to make the measurement.
- d. For each suspected emission, the EUT was arranged to its worst case and then the antenna was tuned to heights from 1 meter to 4 meters and the rotatable table was turned from 0 degrees to 360 degrees to find the maximum reading.
- e. The test-receiver system was set to quasi-peak detect function and specified bandwidth with maximum hold mode when the test frequency is below 1 GHz.
- f. The test-receiver system was set to peak and average detect function and specified bandwidth with maximum hold mode when the test frequency is above 1 GHz. If the peak reading value also meets average limit, measurement with the average detector is unnecessary.

**NOTE:**

1. The resolution bandwidth and video bandwidth of test receiver/spectrum analyzer is 120kHz for Quasi-peak detection (QP) at frequency below 1GHz.
2. The resolution bandwidth of test receiver/spectrum analyzer is 1 MHz and the video bandwidth is 3 MHz for Peak detection (PK) at frequency above 1GHz.
3. The resolution bandwidth of test receiver/spectrum analyzer is 1MHz and the video bandwidth is  $\geq 1/T$  (Duty cycle < 98%) or 10Hz (Duty cycle  $\geq 98\%$ ) for Average detection (AV) at frequency above 1GHz.
4. All modes of operation were investigated and the worst-case emissions are reported.

#### 4.2.4 DEVIATION FROM TEST STANDARD

No deviation

#### 4.2.5 TEST SETUP

##### <Frequency Range below 1GHz>

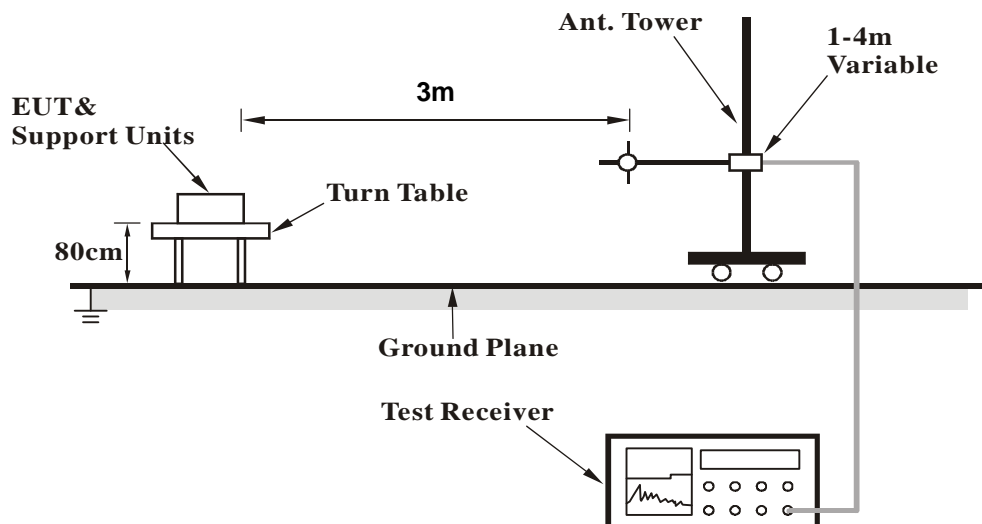

##### <Frequency Range above 1GHz>

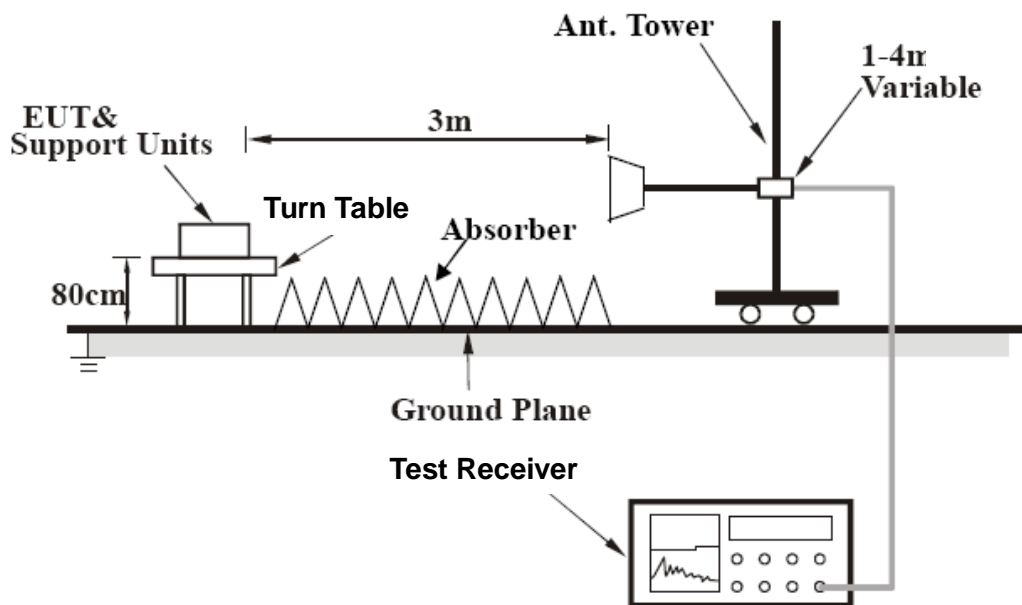

For the actual test configuration, please refer to the related item – Photographs of the Test Configuration.

#### 4.2.6 EUT OPERATING CONDITIONS

Same as 4.1.6

## 4.2.7 TEST RESULTS

### BELOW 1GHz WORST-CASE DATA

#### 802.11g

<b>CHANNEL</b>	TX Channel 1	<b>DETECTOR FUNCTION</b>	Quasi-Peak (QP)
<b>FREQUENCY RANGE</b>	30MHz ~ 1GHz		

ANTENNA POLARITY & TEST DISTANCE: HORIZONTAL AT 3 M								
NO.	FREQ. (MHz)	EMISSION LEVEL (dBuV/m)	LIMIT (dBuV/m)	MARGIN (dB)	ANTENNA HEIGHT (m)	TABLE ANGLE (Degree)	RAW VALUE (dBuV)	CORRECTION FACTOR (dB/m)
1	180.01	41.9 QP	43.5	-1.6	2.00 H	282	56.66	-14.79
2	204.02	39.6 QP	43.5	-3.9	1.00 H	279	55.95	-16.38
3	240.01	43.9 QP	46.0	-2.1	1.50 H	357	58.63	-14.76
4	266.68	41.0 QP	46.0	-5.0	1.00 H	83	54.83	-13.80
5	373.33	42.8 QP	46.0	-3.2	1.00 H	89	53.37	-10.57
6	560.01	41.0 QP	46.0	-5.0	1.50 H	110	47.35	-6.33
ANTENNA POLARITY & TEST DISTANCE: VERTICAL AT 3 M								
NO.	FREQ. (MHz)	EMISSION LEVEL (dBuV/m)	LIMIT (dBuV/m)	MARGIN (dB)	ANTENNA HEIGHT (m)	TABLE ANGLE (Degree)	RAW VALUE (dBuV)	CORRECTION FACTOR (dB/m)
1	38.34	34.7 QP	40.0	-5.3	1.00 V	292	48.81	-14.09
2	293.36	41.8 QP	46.0	-4.2	2.00 V	134	54.52	-12.75
3	373.33	41.9 QP	46.0	-4.1	1.50 V	96	52.51	-10.57
4	480.03	43.7 QP	46.0	-2.3	1.00 V	96	51.55	-7.85
5	506.66	42.9 QP	46.0	-3.1	1.00 V	79	50.15	-7.25
6	560.01	44.3 QP	46.0	-1.7	1.00 V	76	50.62	-6.33

#### REMARKS:

1. Emission Level(dBuV/m) = Raw Value(dBuV) + Correction Factor(dB/m)
2. Correction Factor(dB/m) = Antenna Factor(dB/m) + Cable Factor(dB) – Pre-Amplifier Factor(dB)
3. The other emission levels were very low against the limit.
4. Margin value = Emission Level – Limit value



A D T

**ABOVE 1GHz DATA**

**802.11b**

<b>CHANNEL</b>	TX Channel 1	<b>DETECTOR FUNCTION</b>	Peak (PK)
<b>FREQUENCY RANGE</b>	1GHz ~ 25GHz		Average (AV)

**ANTENNA POLARITY & TEST DISTANCE: HORIZONTAL AT 3 M**

NO.	FREQ. (MHz)	EMISSION LEVEL (dBuV/m)	LIMIT (dBuV/m)	MARGIN (dB)	ANTENNA HEIGHT (m)	TABLE ANGLE (Degree)	RAW VALUE (dBuV)	CORRECTION FACTOR (dB/m)
1	2332.00	54.7 PK	74.0	-19.3	1.09 H	233	22.11	32.59
2	2332.00	46.2 AV	54.0	-7.8	1.09 H	233	13.61	32.59
3	*2412.00	107.2 PK			1.26 H	233	74.36	32.84
4	*2412.00	105.7 AV			1.26 H	233	72.86	32.84
5	2492.70	54.4 PK	74.0	-19.6	1.26 H	233	21.34	33.06
6	2492.70	45.4 AV	54.0	-8.6	1.26 H	233	12.34	33.06
7	4824.00	47.2 PK	74.0	-26.8	1.07 H	314	4.92	42.28
8	4824.00	36.4 AV	54.0	-17.6	1.07 H	314	-5.88	42.28

**ANTENNA POLARITY & TEST DISTANCE: VERTICAL AT 3 M**

NO.	FREQ. (MHz)	EMISSION LEVEL (dBuV/m)	LIMIT (dBuV/m)	MARGIN (dB)	ANTENNA HEIGHT (m)	TABLE ANGLE (Degree)	RAW VALUE (dBuV)	CORRECTION FACTOR (dB/m)
1	2332.00	50.9 PK	74.0	-23.1	1.00 V	158	18.31	32.59
2	2332.00	38.1 AV	54.0	-15.9	1.00 V	158	5.51	32.59
3	*2412.00	102.7 PK			1.00 V	158	69.86	32.84
4	*2412.00	99.0 AV			1.00 V	158	66.16	32.84
5	2492.70	48.5 PK	74.0	-25.5	1.00 V	158	15.44	33.06
6	2492.70	36.6 AV	54.0	-17.4	1.00 V	158	3.54	33.06
7	4824.00	47.4 PK	74.0	-26.6	1.00 V	179	5.12	42.28
8	4824.00	36.1 AV	54.0	-17.9	1.00 V	179	-6.18	42.28

**REMARKS:**

1. Emission Level(dBuV/m) = Raw Value(dBuV) + Correction Factor(dB/m)
2. Correction Factor(dB/m) = Antenna Factor(dB/m) + Cable Factor(dB) – Pre-Amplifier Factor(dB)
3. The other emission levels were very low against the limit.
4. Margin value = Emission Level – Limit value
5. " \* ": Fundamental frequency.

<b>CHANNEL</b>	TX Channel 6	<b>DETECTOR FUNCTION</b>	Peak (PK)
<b>FREQUENCY RANGE</b>	1GHz ~ 25GHz		Average (AV)

ANTENNA POLARITY & TEST DISTANCE: HORIZONTAL AT 3 M								
NO.	FREQ. (MHz)	EMISSION LEVEL (dBuV/m)	LIMIT (dBuV/m)	MARGIN (dB)	ANTENNA HEIGHT (m)	TABLE ANGLE (Degree)	RAW VALUE (dBuV)	CORRECTION FACTOR (dB/m)
1	2357.00	54.8 PK	74.0	-19.2	1.08 H	233	22.13	32.67
2	2357.00	46.3 AV	54.0	-7.7	1.08 H	233	13.63	32.67
3	*2437.00	105.7 PK			1.26 H	233	72.80	32.90
4	*2437.00	103.1 AV			1.26 H	233	70.20	32.90
5	4874.00	47.2 PK	74.0	-26.8	1.05 H	317	4.88	42.32
6	4874.00	36.3 AV	54.0	-17.7	1.05 H	317	-6.02	42.32
7	7311.00	55.3 PK	74.0	-18.7	1.00 H	238	8.35	46.95
8	7311.00	43.2 AV	54.0	-10.8	1.00 H	238	-3.75	46.95

ANTENNA POLARITY & TEST DISTANCE: VERTICAL AT 3 M								
NO.	FREQ. (MHz)	EMISSION LEVEL (dBuV/m)	LIMIT (dBuV/m)	MARGIN (dB)	ANTENNA HEIGHT (m)	TABLE ANGLE (Degree)	RAW VALUE (dBuV)	CORRECTION FACTOR (dB/m)
1	2357.00	51.4 PK	74.0	-22.6	1.00 V	251	18.73	32.67
2	2357.00	42.3 AV	54.0	-11.7	1.00 V	251	9.63	32.67
3	*2437.00	103.9 PK			1.35 V	95	71.00	32.90
4	*2437.00	101.0 AV			1.35 V	95	68.10	32.90
5	4874.00	47.4 PK	74.0	-26.6	1.03 V	173	5.08	42.32
6	4874.00	36.1 AV	54.0	-17.9	1.03 V	173	-6.22	42.32
7	7311.00	56.7 PK	74.0	-17.3	1.03 V	238	9.75	46.95
8	7311.00	43.8 AV	54.0	-10.2	1.03 V	238	-3.15	46.95

**REMARKS:**

1. Emission Level(dBuV/m) = Raw Value(dBuV) + Correction Factor(dB/m)
2. Correction Factor(dB/m) = Antenna Factor(dB/m) + Cable Factor(dB) – Pre-Amplifier Factor(dB)
3. The other emission levels were very low against the limit.
4. Margin value = Emission Level – Limit value
5. " \* ": Fundamental frequency.



A D T

<b>CHANNEL</b>	TX Channel 11	<b>DETECTOR FUNCTION</b>	Peak (PK)
<b>FREQUENCY RANGE</b>	1GHz ~ 25GHz		Average (AV)

**ANTENNA POLARITY & TEST DISTANCE: HORIZONTAL AT 3 M**

NO.	FREQ. (MHz)	EMISSION LEVEL (dBuV/m)	LIMIT (dBuV/m)	MARGIN (dB)	ANTENNA HEIGHT (m)	TABLE ANGLE (Degree)	RAW VALUE (dBuV)	CORRECTION FACTOR (dB/m)
1	2382.00	54.2 PK	74.0	-19.8	1.06 H	232	21.48	32.75
2	2382.00	45.4 AV	54.0	-8.6	1.06 H	232	12.65	32.75
3	*2462.00	108.9 PK			1.28 H	233	75.93	32.97
4	*2462.00	106.5 AV			1.28 H	233	73.53	32.97
5	2483.50	54.1 PK	74.0	-20.0	1.28 H	233	21.02	33.03
6	2483.50	41.6 AV	54.0	-12.4	1.28 H	233	8.57	33.03
7	4924.00	47.4 PK	74.0	-26.6	1.00 H	301	5.07	42.33
8	4924.00	36.5 AV	54.0	-17.5	1.00 H	301	-5.83	42.33
9	7386.00	55.7 PK	74.0	-18.3	1.00 H	247	8.51	47.19
10	7386.00	43.6 AV	54.0	-10.4	1.00 H	247	-3.59	47.19

**ANTENNA POLARITY & TEST DISTANCE: VERTICAL AT 3 M**

NO.	FREQ. (MHz)	EMISSION LEVEL (dBuV/m)	LIMIT (dBuV/m)	MARGIN (dB)	ANTENNA HEIGHT (m)	TABLE ANGLE (Degree)	RAW VALUE (dBuV)	CORRECTION FACTOR (dB/m)
1	2382.00	51.3 PK	74.0	-22.7	1.00 V	238	18.55	32.75
2	2382.00	42.1 AV	54.0	-11.9	1.00 V	238	9.35	32.75
3	*2462.00	103.6 PK			1.41 V	92	70.63	32.97
4	*2462.00	100.9 AV			1.41 V	92	67.93	32.97
5	2483.50	49.9 PK	74.0	-24.1	1.41 V	92	16.87	33.03
6	2483.50	37.4 AV	54.0	-16.6	1.41 V	92	4.37	33.03
7	4924.00	47.2 PK	74.0	-26.8	1.00 V	176	4.87	42.33
8	4924.00	35.7 AV	54.0	-18.3	1.00 V	176	-6.63	42.33
9	7386.00	56.1 PK	74.0	-17.9	1.00 V	245	8.91	47.19
10	7386.00	43.4 AV	54.0	-10.6	1.00 V	245	-3.79	47.19

**REMARKS:**

1. Emission Level(dBuV/m) = Raw Value(dBuV) + Correction Factor(dB/m)
2. Correction Factor(dB/m) = Antenna Factor(dB/m) + Cable Factor(dB) – Pre-Amplifier Factor(dB)
3. The other emission levels were very low against the limit.
4. Margin value = Emission Level – Limit value
5. " \* ": Fundamental frequency.



A D T

## 802.11g

<b>CHANNEL</b>	TX Channel 1	<b>DETECTOR FUNCTION</b>	Peak (PK)
<b>FREQUENCY RANGE</b>	1GHz ~ 25GHz		Average (AV)

**ANTENNA POLARITY & TEST DISTANCE: HORIZONTAL AT 3 M**

NO.	FREQ. (MHz)	EMISSION LEVEL (dBuV/m)	LIMIT (dBuV/m)	MARGIN (dB)	ANTENNA HEIGHT (m)	TABLE ANGLE (Degree)	RAW VALUE (dBuV)	CORRECTION FACTOR (dB/m)
1	2332.00	56.5 PK	74.0	-17.5	1.38 H	235	23.91	32.59
2	2332.00	51.1 AV	54.0	-2.9	1.38 H	235	18.51	32.59
3	2390.00	59.8 PK	74.0	-14.2	1.28 H	233	27.02	32.78
4	2390.00	42.4 AV	54.0	-11.6	1.28 H	233	9.62	32.78
5	*2412.00	103.0 PK			1.28 H	233	70.16	32.84
6	*2412.00	93.2 AV			1.28 H	233	60.36	32.84
7	2492.00	54.2 PK	74.0	-19.8	1.26 H	233	21.15	33.05
8	2492.00	45.8 AV	54.0	-8.2	1.26 H	233	12.75	33.05
9	4824.00	49.4 PK	74.0	-24.6	1.01 H	360	7.12	42.28
10	4824.00	37.3 AV	54.0	-16.7	1.01 H	360	-4.98	42.28

**ANTENNA POLARITY & TEST DISTANCE: VERTICAL AT 3 M**

NO.	FREQ. (MHz)	EMISSION LEVEL (dBuV/m)	LIMIT (dBuV/m)	MARGIN (dB)	ANTENNA HEIGHT (m)	TABLE ANGLE (Degree)	RAW VALUE (dBuV)	CORRECTION FACTOR (dB/m)
1	2332.00	49.5 PK	74.0	-24.5	1.00 V	264	16.91	32.59
2	2332.00	40.3 AV	54.0	-13.7	1.00 V	264	7.71	32.59
3	2390.00	50.1 PK	74.0	-23.9	1.00 V	158	17.32	32.78
4	2390.00	38.0 AV	54.0	-16.0	1.00 V	158	5.22	32.78
5	*2412.00	99.1 PK			1.00 V	158	66.26	32.84
6	*2412.00	90.0 AV			1.00 V	158	57.16	32.84
7	2492.00	49.9 PK	74.0	-24.1	1.00 V	261	16.85	33.05
8	2492.00	37.7 AV	54.0	-16.3	1.00 V	261	4.65	33.05
9	4824.00	48.1 PK	74.0	-25.9	1.06 V	220	5.82	42.28
10	4824.00	36.5 AV	54.0	-17.5	1.06 V	220	-5.78	42.28

**REMARKS:**

1. Emission Level(dBuV/m) = Raw Value(dBuV) + Correction Factor(dB/m)
2. Correction Factor(dB/m) = Antenna Factor(dB/m) + Cable Factor(dB) – Pre-Amplifier Factor(dB)
3. The other emission levels were very low against the limit.
4. Margin value = Emission Level – Limit value
5. " \* ": Fundamental frequency.





A D T

<b>CHANNEL</b>	TX Channel 6	<b>DETECTOR FUNCTION</b>	Peak (PK)
<b>FREQUENCY RANGE</b>	1GHz ~ 25GHz		Average (AV)

**ANTENNA POLARITY & TEST DISTANCE: HORIZONTAL AT 3 M**

NO.	FREQ. (MHz)	EMISSION LEVEL (dBuV/m)	LIMIT (dBuV/m)	MARGIN (dB)	ANTENNA HEIGHT (m)	TABLE ANGLE (Degree)	RAW VALUE (dBuV)	CORRECTION FACTOR (dB/m)
1	2357.00	55.4 PK	74.0	-18.6	1.02 H	222	22.73	32.67
2	2357.00	46.8 AV	54.0	-7.2	1.02 H	222	14.13	32.67
3	*2437.00	104.2 PK			1.22 H	246	71.30	32.90
4	*2437.00	94.2 AV			1.22 H	246	61.30	32.90
5	4874.00	49.4 PK	74.0	-24.6	1.00 H	356	7.08	42.32
6	4874.00	37.2 AV	54.0	-16.8	1.00 H	356	-5.12	42.32
7	7311.00	54.6 PK	74.0	-19.4	1.04 H	360	7.65	46.95
8	7311.00	42.7 AV	54.0	-11.3	1.04 H	360	-4.25	46.95

**ANTENNA POLARITY & TEST DISTANCE: VERTICAL AT 3 M**

NO.	FREQ. (MHz)	EMISSION LEVEL (dBuV/m)	LIMIT (dBuV/m)	MARGIN (dB)	ANTENNA HEIGHT (m)	TABLE ANGLE (Degree)	RAW VALUE (dBuV)	CORRECTION FACTOR (dB/m)
1	2357.00	48.3 PK	74.0	-25.7	1.07 V	167	15.63	32.67
2	2357.00	38.8 AV	54.0	-15.2	1.07 V	167	6.13	32.67
3	*2437.00	99.2 PK			1.04 V	265	66.30	32.90
4	*2437.00	90.5 AV			1.04 V	265	57.60	32.90
5	4874.00	48.9 PK	74.0	-25.1	1.00 V	211	6.58	42.32
6	4874.00	37.0 AV	54.0	-17.0	1.00 V	211	-5.32	42.32
7	7311.00	54.0 PK	74.0	-20.0	1.00 V	218	7.05	46.95
8	7311.00	42.1 AV	54.0	-11.9	1.00 V	218	-4.85	46.95

**REMARKS:**

1. Emission Level(dBuV/m) = Raw Value(dBuV) + Correction Factor(dB/m)
2. Correction Factor(dB/m) = Antenna Factor(dB/m) + Cable Factor(dB) – Pre-Amplifier Factor(dB)
3. The other emission levels were very low against the limit.
4. Margin value = Emission Level – Limit value
5. " \* ": Fundamental frequency.



A D T

<b>CHANNEL</b>	TX Channel 11	<b>DETECTOR FUNCTION</b>	Peak (PK)
<b>FREQUENCY RANGE</b>	1GHz ~ 25GHz		Average (AV)

**ANTENNA POLARITY & TEST DISTANCE: HORIZONTAL AT 3 M**

NO.	FREQ. (MHz)	EMISSION LEVEL (dBuV/m)	LIMIT (dBuV/m)	MARGIN (dB)	ANTENNA HEIGHT (m)	TABLE ANGLE (Degree)	RAW VALUE (dBuV)	CORRECTION FACTOR (dB/m)
1	2382.00	52.4 PK	74.0	-21.6	1.26 H	233	19.65	32.75
2	2382.00	47.8 AV	54.0	-6.2	1.26 H	233	15.05	32.75
3	*2462.00	103.4 PK			1.26 H	233	70.43	32.97
4	*2462.00	93.7 AV			1.26 H	233	60.73	32.97
5	2483.50	54.1 PK	74.0	-19.9	1.26 H	233	21.07	33.03
6	2483.50	40.8 AV	54.0	-13.2	1.26 H	233	7.77	33.03
7	4924.00	49.8 PK	74.0	-24.2	1.03 H	342	7.47	42.33
8	4924.00	37.6 AV	54.0	-16.4	1.03 H	342	-4.73	42.33
9	7386.00	55.2 PK	74.0	-18.8	1.00 H	360	8.01	47.19
10	7386.00	43.1 AV	54.0	-10.9	1.00 H	360	-4.09	47.19

**ANTENNA POLARITY & TEST DISTANCE: VERTICAL AT 3 M**

NO.	FREQ. (MHz)	EMISSION LEVEL (dBuV/m)	LIMIT (dBuV/m)	MARGIN (dB)	ANTENNA HEIGHT (m)	TABLE ANGLE (Degree)	RAW VALUE (dBuV)	CORRECTION FACTOR (dB/m)
1	2382.00	48.3 PK	74.0	-25.7	1.06 V	158	15.55	32.75
2	2382.00	38.9 AV	54.0	-15.1	1.06 V	158	6.15	32.75
3	*2462.00	99.1 PK			1.06 V	265	66.13	32.97
4	*2462.00	90.1 AV			1.06 V	265	57.13	32.97
5	2483.50	49.8 PK	74.0	-24.2	1.06 V	265	16.77	33.03
6	2483.50	37.2 AV	54.0	-16.8	1.06 V	265	4.17	33.03
7	4924.00	49.0 PK	74.0	-25.0	1.00 V	211	6.67	42.33
8	4924.00	36.8 AV	54.0	-17.2	1.00 V	211	-5.53	42.33
9	7386.00	54.3 PK	74.0	-19.7	1.00 V	205	7.11	47.19
10	7386.00	42.3 AV	54.0	-11.7	1.00 V	205	-4.89	47.19

**REMARKS:**

1. Emission Level(dBuV/m) = Raw Value(dBuV) + Correction Factor(dB/m)
2. Correction Factor(dB/m) = Antenna Factor(dB/m) + Cable Factor(dB) – Pre-Amplifier Factor(dB)
3. The other emission levels were very low against the limit.
4. Margin value = Emission Level – Limit value
5. " \* ": Fundamental frequency.



A D T

802.11n (HT20)

<b>CHANNEL</b>	TX Channel 1	<b>DETECTOR FUNCTION</b>	Peak (PK)
<b>FREQUENCY RANGE</b>	1GHz ~ 25GHz		Average (AV)

**ANTENNA POLARITY & TEST DISTANCE: HORIZONTAL AT 3 M**

NO.	FREQ. (MHz)	EMISSION LEVEL (dBuV/m)	LIMIT (dBuV/m)	MARGIN (dB)	ANTENNA HEIGHT (m)	TABLE ANGLE (Degree)	RAW VALUE (dBuV)	CORRECTION FACTOR (dB/m)
1	2332.00	56.6 PK	74.0	-17.4	1.35 H	251	24.01	32.59
2	2332.00	51.4 AV	54.0	-2.6	1.35 H	251	18.81	32.59
3	2390.00	60.0 PK	74.0	-14.0	1.23 H	233	27.22	32.78
4	2390.00	42.8 AV	54.0	-11.2	1.23 H	233	10.02	32.78
5	*2412.00	103.1 PK			1.23 H	233	70.26	32.84
6	*2412.00	93.6 AV			1.23 H	233	60.76	32.84
7	2492.00	54.3 PK	74.0	-19.7	1.24 H	244	21.25	33.05
8	2492.00	46.1 AV	54.0	-7.9	1.24 H	244	13.05	33.05
9	4824.00	49.8 PK	74.0	-24.2	1.06 H	346	7.52	42.28
10	4824.00	37.8 AV	54.0	-16.2	1.06 H	346	-4.48	42.28

**ANTENNA POLARITY & TEST DISTANCE: VERTICAL AT 3 M**

NO.	FREQ. (MHz)	EMISSION LEVEL (dBuV/m)	LIMIT (dBuV/m)	MARGIN (dB)	ANTENNA HEIGHT (m)	TABLE ANGLE (Degree)	RAW VALUE (dBuV)	CORRECTION FACTOR (dB/m)
1	2332.00	49.3 PK	74.0	-24.7	1.01 V	260	16.71	32.59
2	2332.00	40.3 AV	54.0	-13.7	1.01 V	260	7.71	32.59
3	2390.00	50.6 PK	74.0	-23.4	1.03 V	172	17.82	32.78
4	2390.00	38.3 AV	54.0	-15.7	1.03 V	172	5.52	32.78
5	*2412.00	98.3 PK			1.00 V	271	65.46	32.84
6	*2412.00	88.3 AV			1.00 V	271	55.46	32.84
7	2492.00	50.4 PK	74.0	-23.6	1.00 V	262	17.35	33.05
8	2492.00	38.2 AV	54.0	-15.8	1.00 V	262	5.15	33.05
9	4824.00	49.2 PK	74.0	-24.8	1.02 V	224	6.92	42.28
10	4824.00	36.7 AV	54.0	-17.3	1.02 V	224	-5.58	42.28

**REMARKS:**

1. Emission Level(dBuV/m) = Raw Value(dBuV) + Correction Factor(dB/m)
2. Correction Factor(dB/m) = Antenna Factor(dB/m) + Cable Factor(dB) – Pre-Amplifier Factor(dB)
3. The other emission levels were very low against the limit.
4. Margin value = Emission Level – Limit value
5. " \* ": Fundamental frequency.



A D T

<b>CHANNEL</b>	TX Channel 6	<b>DETECTOR FUNCTION</b>	Peak (PK)
<b>FREQUENCY RANGE</b>	1GHz ~ 25GHz		Average (AV)

**ANTENNA POLARITY & TEST DISTANCE: HORIZONTAL AT 3 M**

NO.	FREQ. (MHz)	EMISSION LEVEL (dBuV/m)	LIMIT (dBuV/m)	MARGIN (dB)	ANTENNA HEIGHT (m)	TABLE ANGLE (Degree)	RAW VALUE (dBuV)	CORRECTION FACTOR (dB/m)
1	2357.00	55.1 PK	74.0	-18.9	1.07 H	208	22.43	32.67
2	2357.00	46.3 AV	54.0	-7.7	1.07 H	208	13.63	32.67
3	*2437.00	103.4 PK			1.23 H	234	70.50	32.90
4	*2437.00	93.5 AV			1.23 H	234	60.60	32.90
5	4874.00	49.4 PK	74.0	-24.6	1.04 H	352	7.08	42.32
6	4874.00	37.6 AV	54.0	-16.4	1.04 H	352	-4.72	42.32
7	7311.00	55.2 PK	74.0	-18.8	1.00 H	360	8.25	46.95
8	7311.00	43.2 AV	54.0	-10.8	1.00 H	360	-3.75	46.95

**ANTENNA POLARITY & TEST DISTANCE: VERTICAL AT 3 M**

NO.	FREQ. (MHz)	EMISSION LEVEL (dBuV/m)	LIMIT (dBuV/m)	MARGIN (dB)	ANTENNA HEIGHT (m)	TABLE ANGLE (Degree)	RAW VALUE (dBuV)	CORRECTION FACTOR (dB/m)
1	2357.00	49.9 PK	74.0	-24.1	1.00 V	255	17.23	32.67
2	2357.00	40.1 AV	54.0	-13.9	1.00 V	255	7.43	32.67
3	*2437.00	98.8 PK			1.00 V	267	65.90	32.90
4	*2437.00	88.6 AV			1.00 V	267	55.70	32.90
5	4874.00	49.2 PK	74.0	-24.8	1.02 V	216	6.88	42.32
6	4874.00	36.5 AV	54.0	-17.5	1.02 V	216	-5.82	42.32
7	7311.00	54.7 PK	74.0	-19.3	1.05 V	313	7.75	46.95
8	7311.00	42.9 AV	54.0	-11.1	1.05 V	313	-4.05	46.95

**REMARKS:**

1. Emission Level(dBuV/m) = Raw Value(dBuV) + Correction Factor(dB/m)
2. Correction Factor(dB/m) = Antenna Factor(dB/m) + Cable Factor(dB) – Pre-Amplifier Factor(dB)
3. The other emission levels were very low against the limit.
4. Margin value = Emission Level – Limit value
5. " \* ": Fundamental frequency.



A D T

<b>CHANNEL</b>	TX Channel 11	<b>DETECTOR FUNCTION</b>	Peak (PK)
<b>FREQUENCY RANGE</b>	1GHz ~ 25GHz		Average (AV)

**ANTENNA POLARITY & TEST DISTANCE: HORIZONTAL AT 3 M**

NO.	FREQ. (MHz)	EMISSION LEVEL (dBuV/m)	LIMIT (dBuV/m)	MARGIN (dB)	ANTENNA HEIGHT (m)	TABLE ANGLE (Degree)	RAW VALUE (dBuV)	CORRECTION FACTOR (dB/m)
1	2382.00	52.4 PK	74.0	-21.6	1.23 H	226	19.65	32.75
2	2382.00	47.8 AV	54.0	-6.2	1.23 H	226	15.05	32.75
3	*2462.00	103.4 PK			1.24 H	229	70.43	32.97
4	*2462.00	93.7 AV			1.24 H	229	60.73	32.97
5	2483.50	53.6 PK	74.0	-20.4	1.24 H	229	20.57	33.03
6	2483.50	40.5 AV	54.0	-13.5	1.24 H	229	7.47	33.03
7	4924.00	49.7 PK	74.0	-24.3	1.00 H	355	7.37	42.33
8	4924.00	37.7 AV	54.0	-16.3	1.00 H	355	-4.63	42.33
9	7386.00	54.7 PK	74.0	-19.3	1.00 H	356	7.51	47.19
10	7386.00	42.9 AV	54.0	-11.1	1.00 H	356	-4.29	47.19

**ANTENNA POLARITY & TEST DISTANCE: VERTICAL AT 3 M**

NO.	FREQ. (MHz)	EMISSION LEVEL (dBuV/m)	LIMIT (dBuV/m)	MARGIN (dB)	ANTENNA HEIGHT (m)	TABLE ANGLE (Degree)	RAW VALUE (dBuV)	CORRECTION FACTOR (dB/m)
1	2382.00	49.7 PK	74.0	-24.3	1.00 V	262	16.95	32.75
2	2382.00	39.9 AV	54.0	-14.1	1.00 V	262	7.15	32.75
3	*2462.00	98.8 PK			1.00 V	265	65.83	32.97
4	*2462.00	88.8 AV			1.00 V	265	55.83	32.97
5	2483.50	51.8 PK	74.0	-22.2	1.00 V	265	18.77	33.03
6	2483.50	37.8 AV	54.0	-16.2	1.00 V	265	4.77	33.03
7	4924.00	49.4 PK	74.0	-24.6	1.00 V	205	7.07	42.33
8	4924.00	36.8 AV	54.0	-17.2	1.00 V	205	-5.53	42.33
9	7386.00	54.6 PK	74.0	-19.4	1.00 V	303	7.41	47.19
10	7386.00	42.5 AV	54.0	-11.5	1.00 V	303	-4.69	47.19

**REMARKS:**

1. Emission Level(dBuV/m) = Raw Value(dBuV) + Correction Factor(dB/m)
2. Correction Factor(dB/m) = Antenna Factor(dB/m) + Cable Factor(dB) – Pre-Amplifier Factor(dB)
3. The other emission levels were very low against the limit.
4. Margin value = Emission Level – Limit value
5. " \* ": Fundamental frequency.



A D T

802.11n (HT40)

<b>CHANNEL</b>	TX Channel 3	<b>DETECTOR FUNCTION</b>	Peak (PK)
<b>FREQUENCY RANGE</b>	1GHz ~ 25GHz		Average (AV)

**ANTENNA POLARITY & TEST DISTANCE: HORIZONTAL AT 3 M**

NO.	FREQ. (MHz)	EMISSION LEVEL (dBuV/m)	LIMIT (dBuV/m)	MARGIN (dB)	ANTENNA HEIGHT (m)	TABLE ANGLE (Degree)	RAW VALUE (dBuV)	CORRECTION FACTOR (dB/m)
1	2372.00	61.9 PK	74.0	-12.1	1.24 H	234	29.18	32.72
2	2372.00	45.0 AV	54.0	-9.0	1.24 H	234	12.28	32.72
3	*2422.00	99.9 PK			1.24 H	234	67.04	32.86
4	*2422.00	90.7 AV			1.24 H	234	57.84	32.86
5	4844.00	49.3 PK	74.0	-24.7	1.37 H	13	7.01	42.29
6	4844.00	38.6 AV	54.0	-15.4	1.37 H	13	-3.69	42.29
7	7266.00	55.0 PK	74.0	-19.0	1.09 H	221	8.19	46.81
8	7266.00	42.4 AV	54.0	-11.6	1.09 H	221	-4.41	46.81

**ANTENNA POLARITY & TEST DISTANCE: VERTICAL AT 3 M**

NO.	FREQ. (MHz)	EMISSION LEVEL (dBuV/m)	LIMIT (dBuV/m)	MARGIN (dB)	ANTENNA HEIGHT (m)	TABLE ANGLE (Degree)	RAW VALUE (dBuV)	CORRECTION FACTOR (dB/m)
1	2372.00	47.8 PK	74.0	-26.2	1.04 V	267	15.08	32.72
2	2372.00	36.7 AV	54.0	-17.3	1.04 V	267	3.98	32.72
3	*2422.00	93.6 PK			1.05 V	267	60.74	32.86
4	*2422.00	84.7 AV			1.05 V	267	51.84	32.86
5	4844.00	49.3 PK	74.0	-24.7	1.01 V	212	7.01	42.29
6	4844.00	36.5 AV	54.0	-17.5	1.01 V	212	-5.79	42.29
7	7266.00	54.7 PK	74.0	-19.3	1.06 V	183	7.89	46.81
8	7266.00	41.8 AV	54.0	-12.2	1.06 V	183	-5.01	46.81

**REMARKS:**

1. Emission Level(dBuV/m) = Raw Value(dBuV) + Correction Factor(dB/m)
2. Correction Factor(dB/m) = Antenna Factor(dB/m) + Cable Factor(dB) – Pre-Amplifier Factor(dB)
3. The other emission levels were very low against the limit.
4. Margin value = Emission Level – Limit value
5. " \* ": Fundamental frequency.



A D T

<b>CHANNEL</b>	TX Channel 6	<b>DETECTOR FUNCTION</b>	Peak (PK)
<b>FREQUENCY RANGE</b>	1GHz ~ 25GHz		Average (AV)

**ANTENNA POLARITY & TEST DISTANCE: HORIZONTAL AT 3 M**

NO.	FREQ. (MHz)	EMISSION LEVEL (dBuV/m)	LIMIT (dBuV/m)	MARGIN (dB)	ANTENNA HEIGHT (m)	TABLE ANGLE (Degree)	RAW VALUE (dBuV)	CORRECTION FACTOR (dB/m)
1	*2437.00	102.0 PK			1.31 H	230	69.10	32.90
2	*2437.00	92.1 AV			1.31 H	230	59.20	32.90
3	4874.00	49.0 PK	74.0	-25.0	1.42 H	7	6.68	42.32
4	4874.00	38.4 AV	54.0	-15.6	1.42 H	7	-3.92	42.32
5	7311.00	55.2 PK	74.0	-18.8	1.09 H	212	8.25	46.95
6	7311.00	42.3 AV	54.0	-11.7	1.09 H	212	-4.65	46.95

**ANTENNA POLARITY & TEST DISTANCE: VERTICAL AT 3 M**

NO.	FREQ. (MHz)	EMISSION LEVEL (dBuV/m)	LIMIT (dBuV/m)	MARGIN (dB)	ANTENNA HEIGHT (m)	TABLE ANGLE (Degree)	RAW VALUE (dBuV)	CORRECTION FACTOR (dB/m)
1	*2437.00	95.6 PK			1.09 V	263	62.70	32.90
2	*2437.00	86.0 AV			1.09 V	263	53.10	32.90
3	4874.00	49.5 PK	74.0	-24.5	1.00 V	222	7.18	42.32
4	4874.00	36.5 AV	54.0	-17.5	1.00 V	222	-5.82	42.32
5	7311.00	54.4 PK	74.0	-19.6	1.02 V	189	7.45	46.95
6	7311.00	41.5 AV	54.0	-12.5	1.02 V	189	-5.45	46.95

**REMARKS:**

1. Emission Level(dBuV/m) = Raw Value(dBuV) + Correction Factor(dB/m)
2. Correction Factor(dB/m) = Antenna Factor(dB/m) + Cable Factor(dB) – Pre-Amplifier Factor(dB)
3. The other emission levels were very low against the limit.
4. Margin value = Emission Level – Limit value
5. " \* ": Fundamental frequency.



A D T

<b>CHANNEL</b>	TX Channel 9	<b>DETECTOR FUNCTION</b>	Peak (PK)
<b>FREQUENCY RANGE</b>	1GHz ~ 25GHz		Average (AV)

**ANTENNA POLARITY & TEST DISTANCE: HORIZONTAL AT 3 M**

NO.	FREQ. (MHz)	EMISSION LEVEL (dBuV/m)	LIMIT (dBuV/m)	MARGIN (dB)	ANTENNA HEIGHT (m)	TABLE ANGLE (Degree)	RAW VALUE (dBuV)	CORRECTION FACTOR (dB/m)
1	2372.00	50.1 PK	74.0	-23.9	1.26 H	236	17.38	32.72
2	2372.00	43.2 AV	54.0	-10.8	1.26 H	236	10.48	32.72
3	*2452.00	101.8 PK			1.26 H	236	68.86	32.94
4	*2452.00	92.2 AV			1.26 H	236	59.26	32.94
5	2483.50	60.4 PK	74.0	-13.6	1.26 H	236	27.37	33.03
6	2483.50	44.1 AV	54.0	-9.9	1.26 H	236	11.07	33.03
7	4904.00	49.0 PK	74.0	-25.0	1.43 H	14	6.66	42.34
8	4904.00	38.4 AV	54.0	-15.6	1.43 H	14	-3.94	42.34
9	7356.00	54.9 PK	74.0	-19.1	1.09 H	218	7.81	47.09
10	7356.00	41.9 AV	54.0	-12.1	1.09 H	218	-5.19	47.09

**ANTENNA POLARITY & TEST DISTANCE: VERTICAL AT 3 M**

NO.	FREQ. (MHz)	EMISSION LEVEL (dBuV/m)	LIMIT (dBuV/m)	MARGIN (dB)	ANTENNA HEIGHT (m)	TABLE ANGLE (Degree)	RAW VALUE (dBuV)	CORRECTION FACTOR (dB/m)
1	2372.00	47.7 PK	74.0	-26.3	1.09 V	254	14.98	32.72
2	2372.00	36.5 AV	54.0	-17.5	1.09 V	254	3.78	32.72
3	*2452.00	95.5 PK			1.09 V	263	62.56	32.94
4	*2452.00	86.0 AV			1.09 V	263	53.06	32.94
5	2483.50	51.1 PK	74.0	-22.9	1.09 V	263	18.07	33.03
6	2483.50	37.8 AV	54.0	-16.2	1.09 V	263	4.77	33.03
7	4904.00	49.5 PK	74.0	-24.5	1.00 V	211	7.16	42.34
8	4904.00	36.8 AV	54.0	-17.2	1.00 V	211	-5.54	42.34
9	7356.00	54.7 PK	74.0	-19.3	1.00 V	195	7.61	47.09
10	7356.00	41.9 AV	54.0	-12.1	1.00 V	195	-5.19	47.09

**REMARKS:**

1. Emission Level(dBuV/m) = Raw Value(dBuV) + Correction Factor(dB/m)
2. Correction Factor(dB/m) = Antenna Factor(dB/m) + Cable Factor(dB) – Pre-Amplifier Factor(dB)
3. The other emission levels were very low against the limit.
4. Margin value = Emission Level – Limit value
5. " \* ": Fundamental frequency.



### 4.3 6dB BANDWIDTH MEASUREMENT

#### 4.3.1 LIMITS OF 6dB BANDWIDTH MEASUREMENT

The minimum of 6dB Bandwidth Measurement is 0.5 MHz.

#### 4.3.2 TEST INSTRUMENTS

DESCRIPTION & MANUFACTURER	MODEL NO.	SERIAL NO.	CALIBRATED DATE	CALIBRATED UNTIL
R&S SPECTRUM ANALYZER	FSP40	100036	Jan. 21, 2013	Jan. 20, 2014

**Note:**

1. The calibration interval of the above test instruments is 12 months and the calibrations are traceable to NML/ROC and NIST/USA.
2. Tested date : Oct. 31, 2013

#### 4.3.3 TEST PROCEDURE

1. Set resolution bandwidth (RBW) = 100kHz
2. Set the video bandwidth (VBW)  $\geq 3 \times$  RBW, Detector = Peak.
3. Trace mode = max hold.
4. Sweep = auto couple.
5. Measure the maximum width of the emission that is constrained by the frequencies associated with the two amplitude points (upper and lower) that are attenuated by 6 dB relative to the maximum level measured in the fundamental emission

#### 4.3.4 DEVIATION FROM TEST STANDARD

No deviation

#### 4.3.5 TEST SETUP

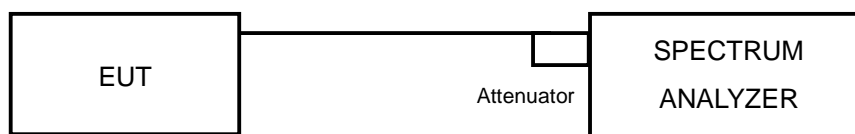

#### 4.3.6 EUT OPERATING CONDITIONS

The software provided by client to enable the EUT under transmission condition continuously at lowest, middle and highest channel frequencies individually.

### 4.3.7 TEST RESULTS

#### 802.11b

CHANNEL	FREQUENCY (MHz)	6dB BANDWIDTH (MHz)	MINIMUM LIMIT (MHz)	PASS / FAIL
1	2412	10.11	0.5	PASS
6	2437	10.12	0.5	PASS
11	2462	10.12	0.5	PASS

#### 802.11g

CHANNEL	FREQUENCY (MHz)	6dB BANDWIDTH (MHz)	MINIMUM LIMIT (MHz)	PASS / FAIL
1	2412	16.62	0.5	PASS
6	2437	16.62	0.5	PASS
11	2462	16.61	0.5	PASS

#### 802.11n (HT20)

CHANNEL	FREQUENCY (MHz)	6dB BANDWIDTH (MHz)	MINIMUM LIMIT (MHz)	PASS / FAIL
1	2412	17.84	0.5	PASS
6	2437	17.82	0.5	PASS
11	2462	17.84	0.5	PASS

#### 802.11n (HT40)

CHANNEL	FREQUENCY (MHz)	6dB BANDWIDTH (MHz)	MINIMUM LIMIT (MHz)	PASS / FAIL
3	2422	36.47	0.5	PASS
6	2437	36.48	0.5	PASS
9	2452	36.50	0.5	PASS



A D T

### SPECTRUM PLOT OF WORST VALUE

#### 802.11b / CH1

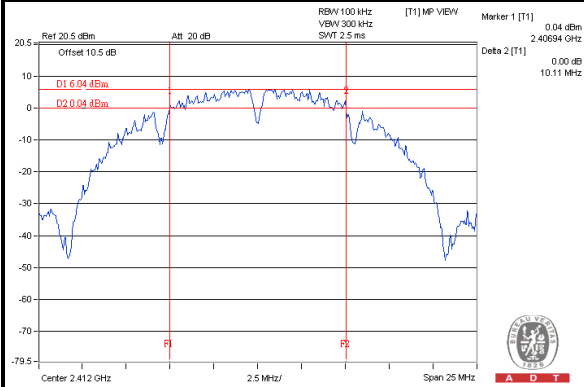

#### 802.11g / CH11

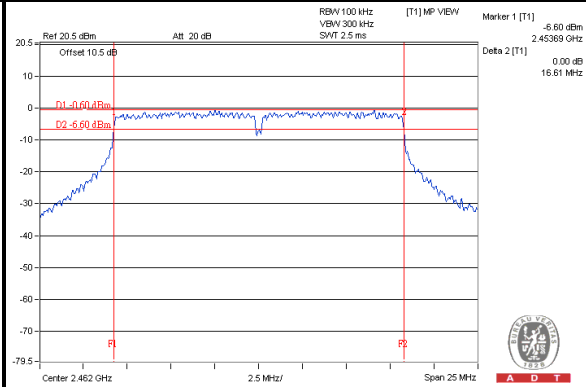

#### 802.11n (HT20) / CH6

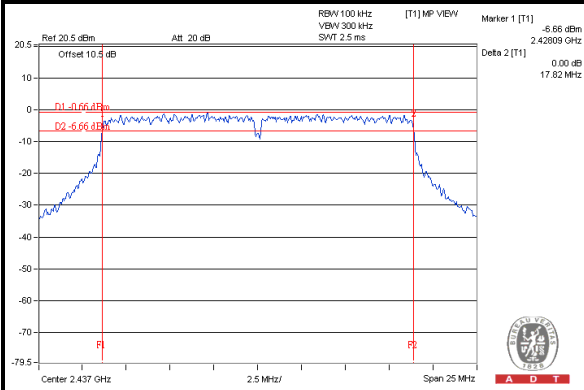

#### 802.11n (HT40) / CH3

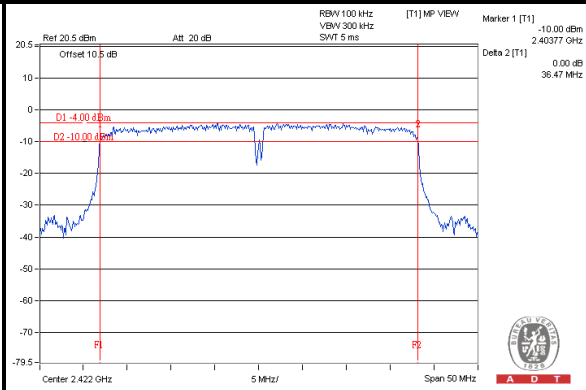

## 4.4 CONDUCTED OUTPUT POWER MEASUREMENT

### 4.4.1 LIMITS OF MAXIMUM PEAK OUTPUT POWER MEASUREMENT

For systems using digital modulation in the 2400–2483.5 MHz bands: 1 Watt (30dBm)

### 4.4.2 INSTRUMENTS

DESCRIPTION & MANUFACTURER	MODEL NO.	SERIAL NO.	CALIBRATED DATE	CALIBRATED UNTIL
Power Meter	ML2495A	0824006	May 20, 2013	May 19, 2014
Power Sensor	MA2411B	0738172	May 20, 2013	May 19, 2014

**Note:**

1. The calibration interval of the above test instruments is 12 months and the calibrations are traceable to NML/ROC and NIST/USA.
2. Tested date : Oct. 31, 2013

### 4.4.3 TEST PROCEDURES

The peak power sensor was used on the output port of the EUT. A power meter was used to read the response of the peak power sensor. Record the peak power level.

### 4.4.4 DEVIATION FROM TEST STANDARD

No deviation.

### 4.4.5 TEST SETUP

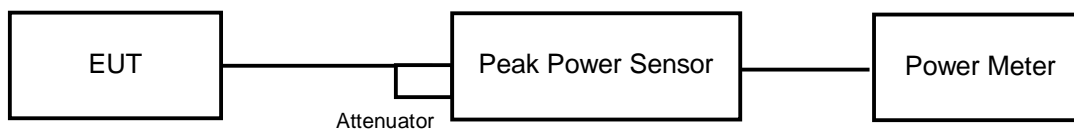

### 4.4.6 EUT OPERATING CONDITIONS

Same as Item 4.3.6



A D T

#### 4.4.7 TEST RESULTS

##### 802.11b

CHANNEL	FREQUENCY (MHz)	PEAK POWER (mW)	PEAK POWER (dBm)	LIMIT (dBm)	PASS/FAIL
1	2412	32.137	15.07	30	PASS
6	2437	32.659	15.14	30	PASS
11	2462	33.420	15.24	30	PASS

##### 802.11g

CHANNEL	FREQUENCY (MHz)	PEAK POWER (mW)	PEAK POWER (dBm)	LIMIT (dBm)	PASS/FAIL
1	2412	129.718	21.13	30	PASS
6	2437	127.350	21.05	30	PASS
11	2462	121.619	20.85	30	PASS

##### 802.11n (HT20)

CHANNEL	FREQUENCY (MHz)	PEAK POWER (mW)	PEAK POWER (dBm)	LIMIT (dBm)	PASS/FAIL
1	2412	118.577	20.74	30	PASS
6	2437	112.720	20.52	30	PASS
11	2462	118.304	20.73	30	PASS

##### 802.11n (HT40)

CHANNEL	FREQUENCY (MHz)	PEAK POWER (mW)	PEAK POWER (dBm)	LIMIT (dBm)	PASS/FAIL
3	2422	102.802	20.12	30	PASS
6	2437	101.625	20.07	30	PASS
9	2452	103.276	20.14	30	PASS



A D T

## 4.5 AVERAGE OUTPUT POWER

### 4.5.1 FOR REFERENCE.

### 4.5.2 TEST INSTRUMENTS

DESCRIPTION & MANUFACTURER	MODEL NO.	SERIAL NO.	CALIBRATED DATE	CALIBRATED UNTIL
Power Meter	ML2495A	0824006	May 20, 2013	May 19, 2014
Power Sensor	MA2411B	0738172	May 20, 2013	May 19, 2014

**Note:**

1. The calibration interval of the above test instruments is 12 months and the calibrations are traceable to NML/ROC and NIST/USA.
2. Tested date : Oct. 31, 2013

### 4.5.3 TEST PROCEDURES

Method PM is used to perform output power measurement, trigger and gating function of wide band power meter is enabled to measure max output power of TX on burst. Duty factor is not added to measured value.

### 4.5.4 TEST SETUP

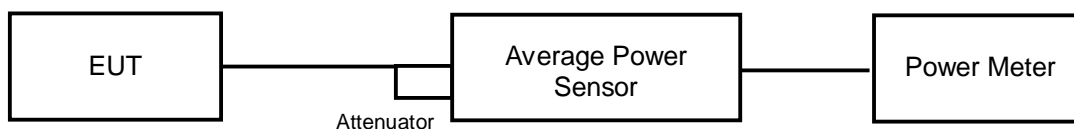

### 4.5.5 EUT OPERATING CONDITIONS

Same as Item 4.3.6



A D T

## 4.5.6 TEST RESULTS

### 802.11b

CHANNEL	FREQUENCY (MHz)	AVERAGE POWER (mW)	AVERAGE POWER (dBm)
1	2412	19.724	12.95
6	2437	20.184	13.05
11	2462	20.941	13.21

### 802.11g

CHANNEL	FREQUENCY (MHz)	AVERAGE POWER (mW)	AVERAGE POWER (dBm)
1	2412	20.845	13.19
6	2437	21.330	13.29
11	2462	20.417	13.10

### 802.11n (HT20)

CHANNEL	FREQUENCY (MHz)	AVERAGE POWER (mW)	AVERAGE POWER (dBm)
1	2412	21.086	13.24
6	2437	20.559	13.13
11	2462	21.429	13.31

### 802.11n (HT40)

CHANNEL	FREQUENCY (MHz)	AVERAGE POWER (mW)	AVERAGE POWER (dBm)
3	2422	20.370	13.09
6	2437	20.559	13.13
9	2452	21.232	13.27

## 4.6 POWER SPECTRAL DENSITY MEASUREMENT

### 4.6.1 LIMITS OF POWER SPECTRAL DENSITY MEASUREMENT

The Maximum of Power Spectral Density Measurement is 8dBm.

### 4.6.2 TEST INSTRUMENTS

DESCRIPTION & MANUFACTURER	MODEL NO.	SERIAL NO.	CALIBRATED DATE	CALIBRATED UNTIL
R&S SPECTRUM ANALYZER	FSP40	100036	Jan. 21, 2013	Jan. 20, 2014

**Note:**

1. The calibration interval of the above test instruments is 12 months and the calibrations are traceable to NML/ROC and NIST/USA.
2. Tested date : Oct. 31, 2013

### 4.6.3 TEST PROCEDURE

1. Set the RBW = 3 kHz, VBW =10 kHz, Detector = peak.
2. Sweep time = auto couple, Trace mode = max hold, allow trace to fully stabilize.
3. Use the peak marker function to determine the maximum amplitude level.

### 4.6.4 DEVIATION FROM TEST STANDARD

No deviation

### 4.6.5 TEST SETUP

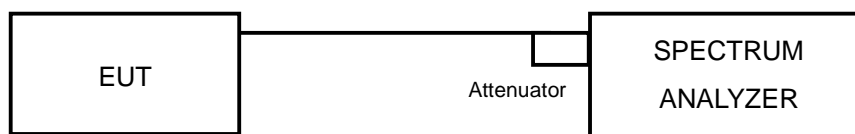

### 4.6.6 EUT OPERATING CONDITION

Same as Item 4.3.6





A D T

#### 4.6.7 TEST RESULTS

##### 802.11b

Channel	FREQUENCY (MHz)	PSD (dBm)	Limit (dBm)	PASS /FAIL
1	2412	-14.24	8	PASS
6	2437	-12.51	8	PASS
11	2462	-12.65	8	PASS

##### 802.11g

Channel	FREQUENCY (MHz)	PSD (dBm)	Limit (dBm)	PASS /FAIL
1	2412	-13.04	8	PASS
6	2437	-12.35	8	PASS
11	2462	-12.40	8	PASS

##### 802.11n (HT20)

Channel	FREQUENCY (MHz)	PSD (dBm)	Limit (dBm)	PASS /FAIL
1	2412	-12.95	8	PASS
6	2437	-12.49	8	PASS
11	2462	-12.24	8	PASS

##### 802.11n (HT40)

Channel	FREQUENCY (MHz)	PSD (dBm)	Limit (dBm)	PASS /FAIL
3	2422	-12.99	8	PASS
6	2437	-12.95	8	PASS
9	2452	-12.77	8	PASS



A D T

### SPECTRUM PLOT OF WORST VALUE

#### 802.11b / CH6

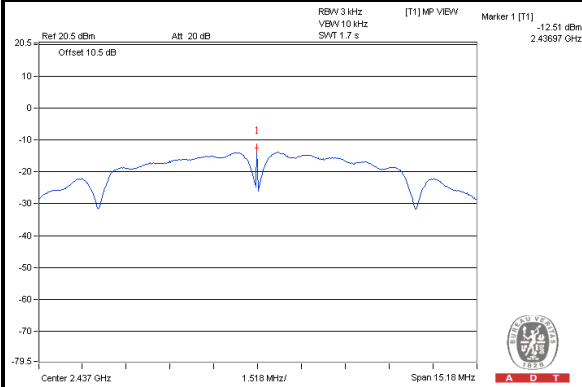

#### 802.11g / CH6

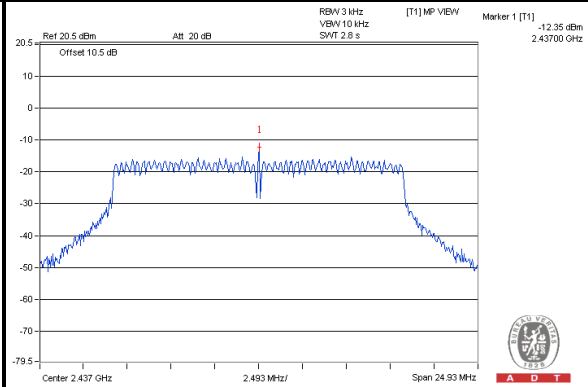

#### 802.11n (HT20) / CH11

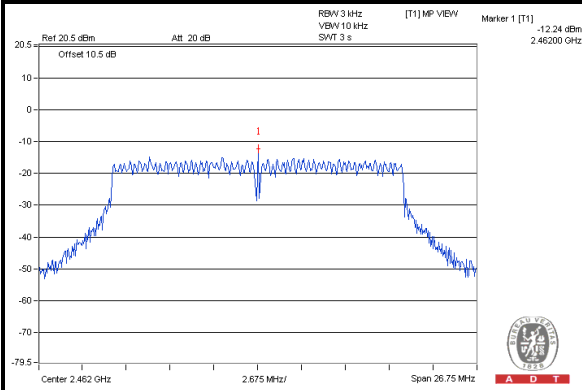

#### 802.11n (HT40) / CH9

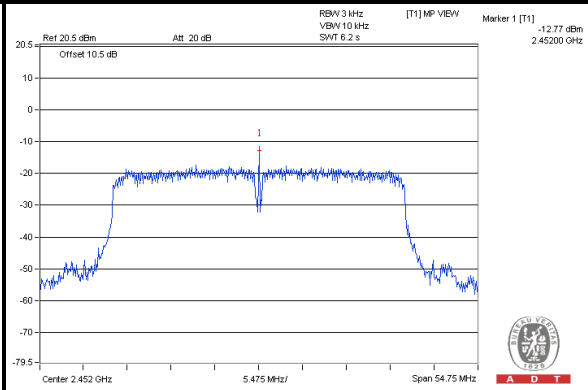



A D T

## 4.7 CONDUCTED OUT-BAND EMISSION MEASUREMENT

### 4.7.1 LIMITS OF CONDUCTED OUT-BAND EMISSION MEASUREMENT

Below 20dB of the highest emission level of operating band (in 100kHz Resolution Bandwidth).

### 4.7.2 TEST INSTRUMENTS

DESCRIPTION & MANUFACTURER	MODEL NO.	SERIAL NO.	CALIBRATED DATE	CALIBRATED UNTIL
R&S SPECTRUM ANALYZER	FSP40	100036	Jan. 21, 2013	Jan. 20, 2014

**Note:**

1. The calibration interval of the above test instruments is 12 months and the calibrations are traceable to NML/ROC and NIST/USA.
2. Tested date : Oct. 31, 2013

### 4.7.3 TEST PROCEDURE

#### Measurement Procedure - Reference Level

1. Set the RBW = 100 kHz.
2. Set the VBW  $\geq$  300 kHz.
3. Detector = peak.
4. Sweep time = auto couple.
5. Trace mode = max hold.
6. Allow trace to fully stabilize.
7. Use the peak marker function to determine the maximum power level in any 100 kHz band segment within the fundamental EBW.

#### Measurement Procedure –Unwanted Emission Level

1. Set RBW = 100 kHz.
2. Set VBW  $\geq$  300 kHz.
3. Set span to encompass the spectrum to be examined
4. Detector = peak.
5. Trace Mode = max hold.
6. Sweep = auto couple.

#### 4.7.4 DEVIATION FROM TEST STANDARD

No deviation

#### 4.7.5 TEST SETUP

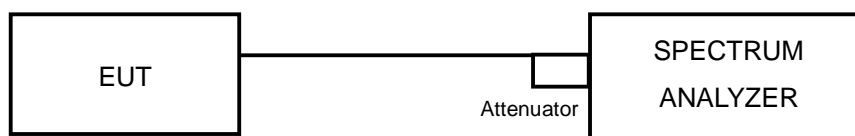

#### 4.7.6 EUT OPERATING CONDITION

Same as Item 4.3.6

#### 4.7.7 TEST RESULTS

The spectrum plots are attached on the following pages. D1 line indicates the highest level, and D2 line indicates the 20dB offset below D1. It shows compliance with the requirement.



A D T

### 802.11b:

#### CH 1

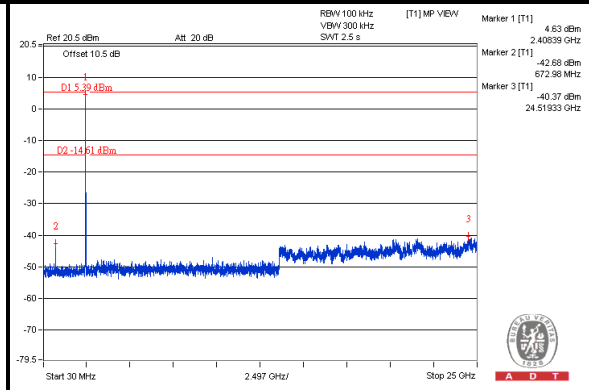
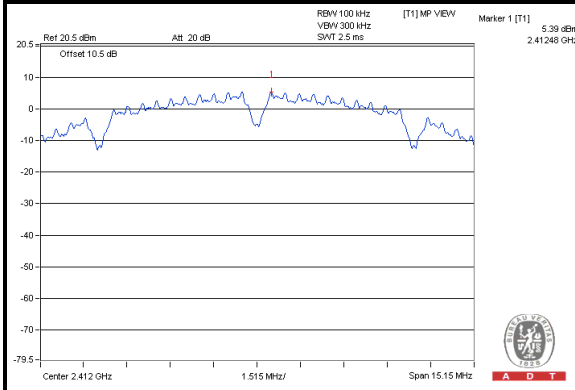

#### CH 6

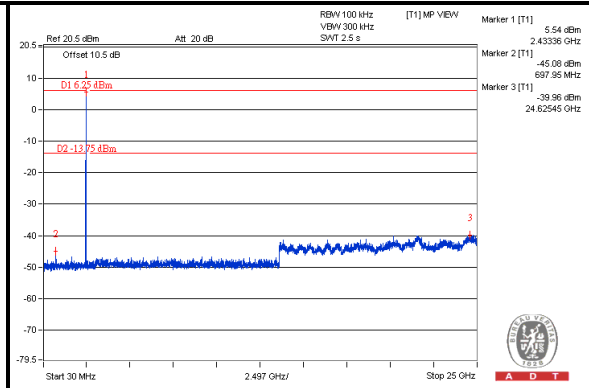
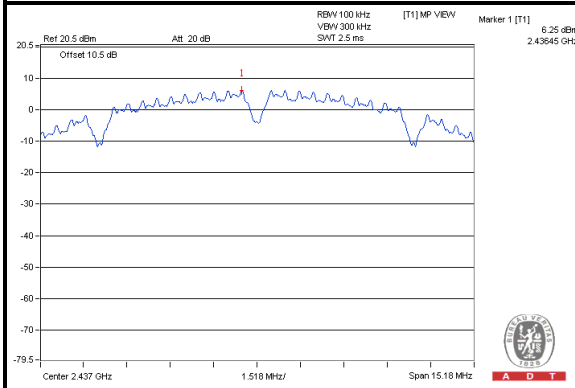

#### CH 11

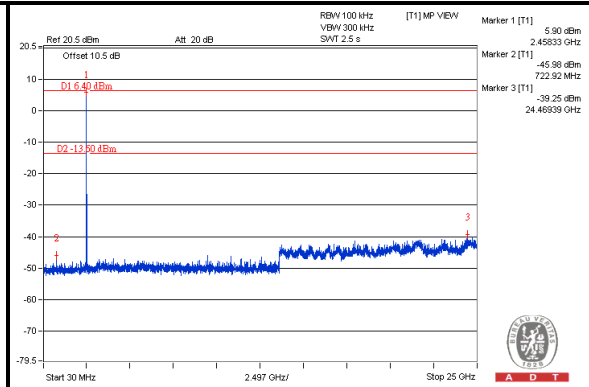
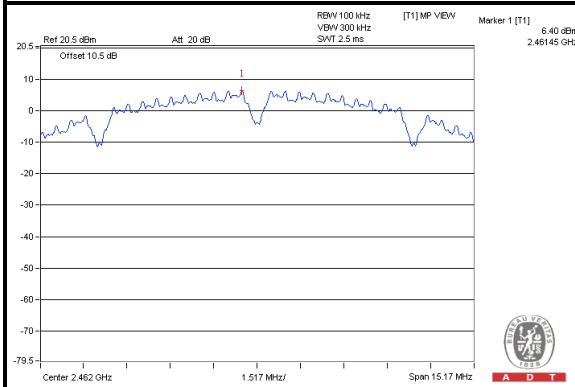

#### CH 1 Band edge

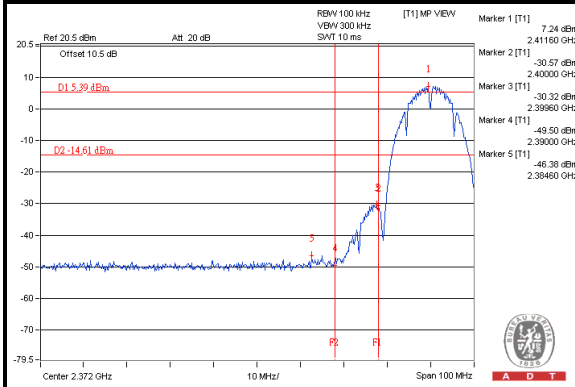

#### CH 11 Band edge

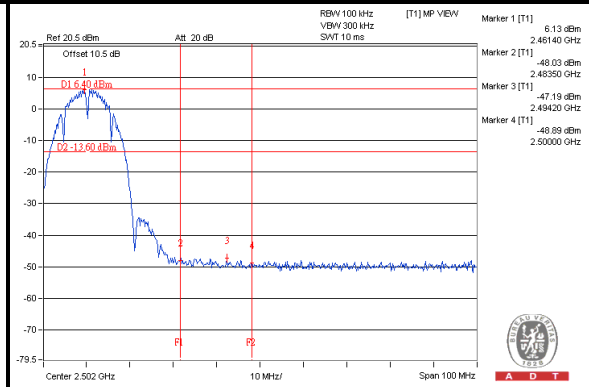



A D T

### 802.11g:

#### CH 1

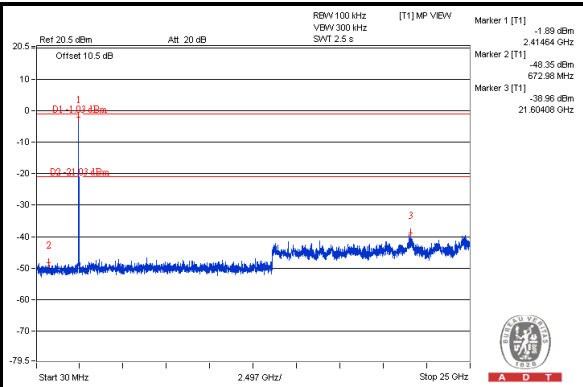
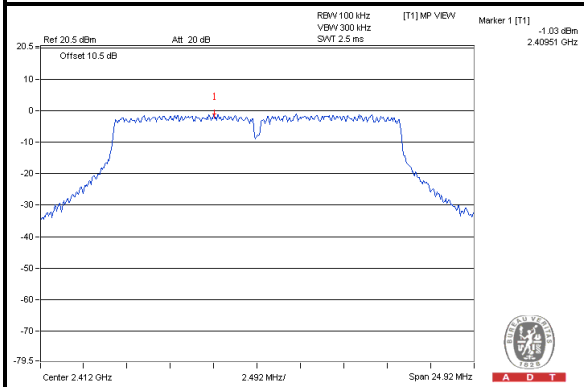

#### CH 6

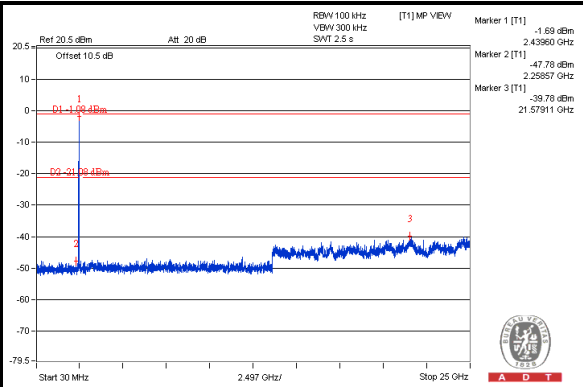
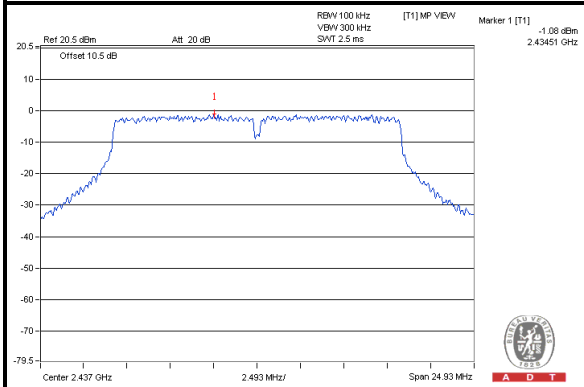

#### CH 11

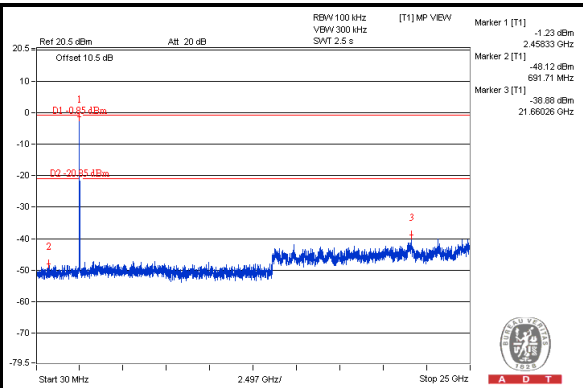
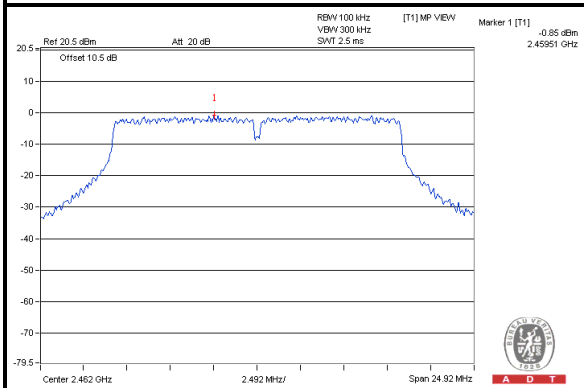

#### CH 1 Band edge

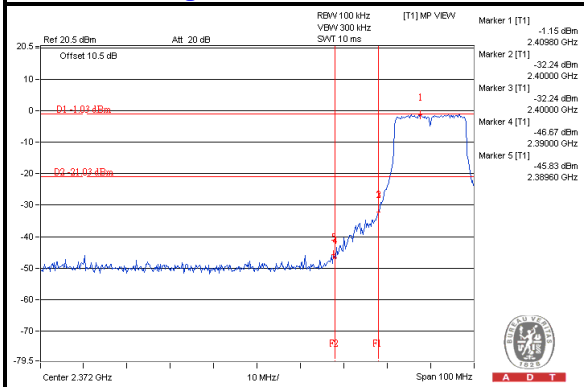

#### CH 11 Band edge

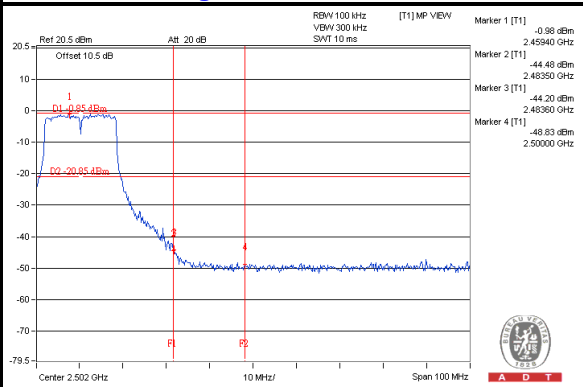



A D T

### 802.11n (HT20):

#### CH 1

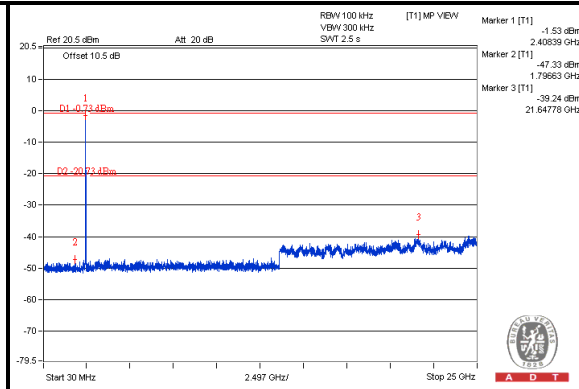
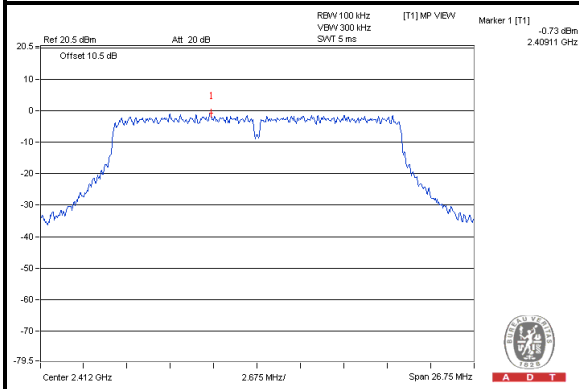

#### CH 6

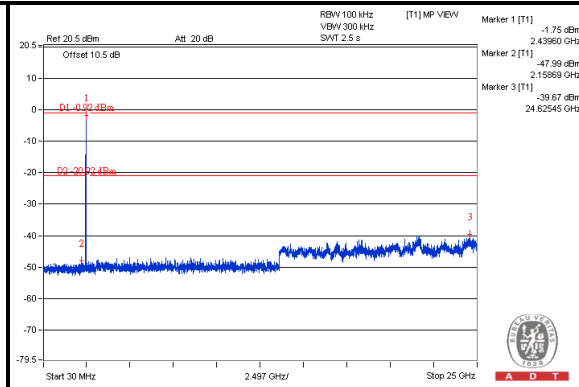
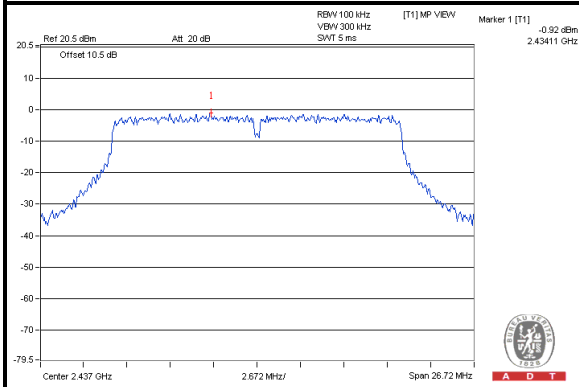

#### CH 11

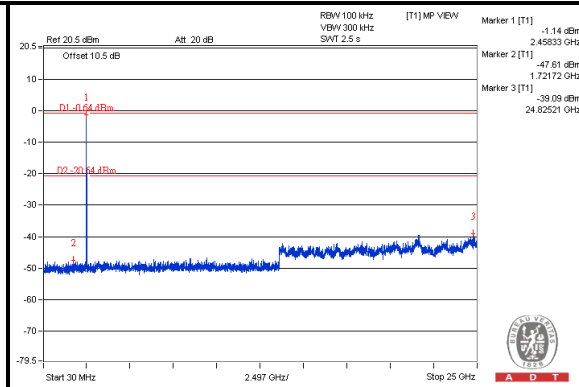
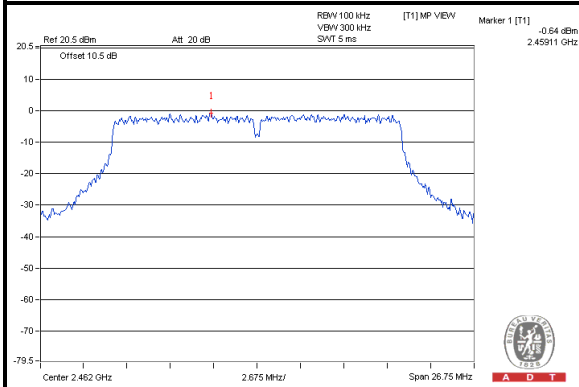

#### CH 1 Band edge

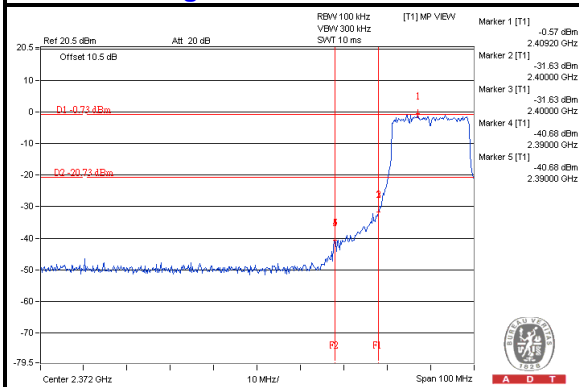

#### CH 11 Band edge

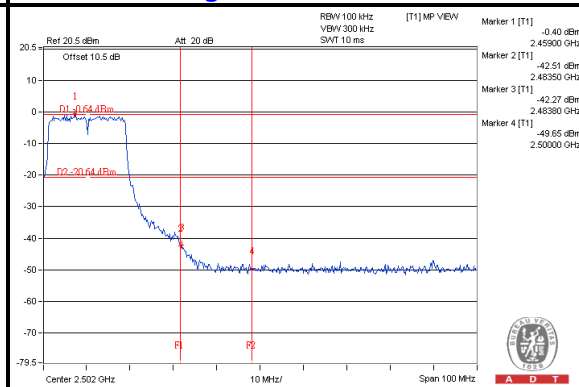



A D T

### 802.11n (HT40):

#### CH 3

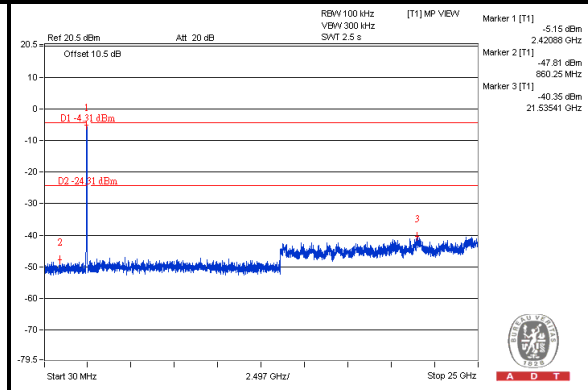
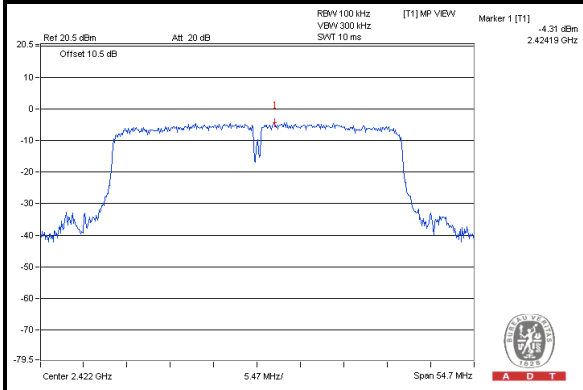

#### CH 6

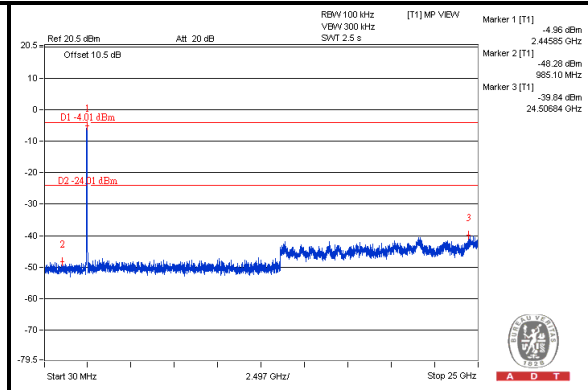
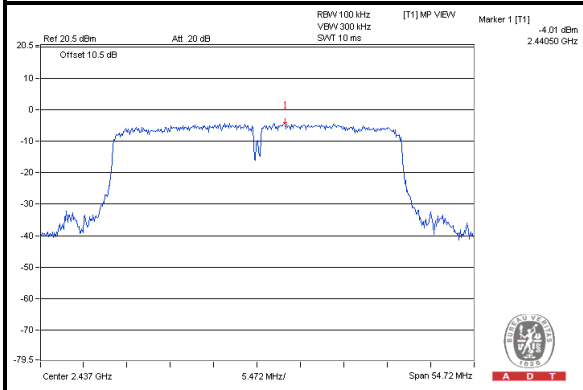

#### CH 9

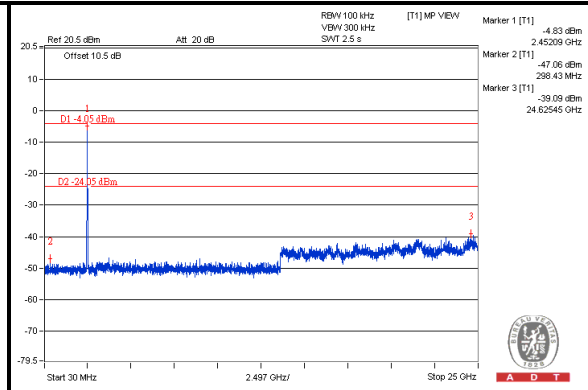
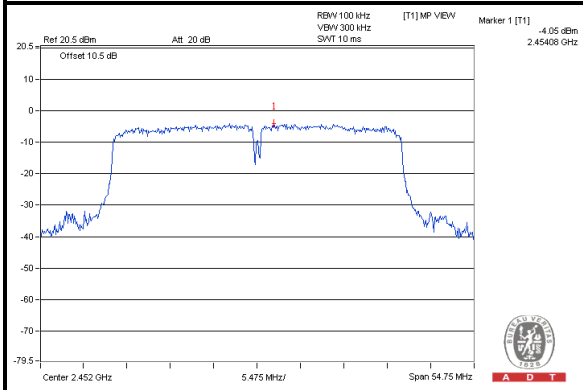

#### CH 3 Band edge

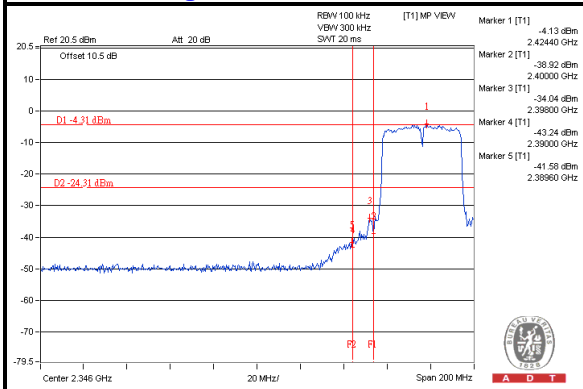

#### CH 9 Band edge

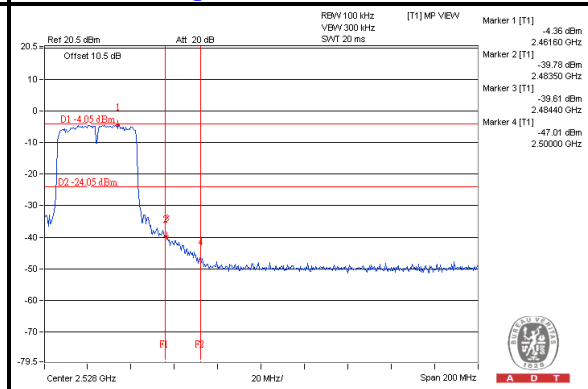



## 5. PHOTOGRAPHS OF THE TEST CONFIGURATION

Please refer to the attached file (Test Setup Photo).



## 6. INFORMATION ON THE TESTING LABORATORIES

We, Bureau Veritas Consumer Products Services (H.K.) Ltd., Taoyuan Branch, were founded in 1988 to provide our best service in EMC, Radio, Telecom and Safety consultation. Our laboratories are accredited and approved according to ISO/IEC 17025.

If you have any comments, please feel free to contact us at the following:

**Linko EMC/RF Lab:**

Tel: 886-2-26052180

Fax: 886-2-26052943

**Hsin Chu EMC/RF Lab:**

Tel: 886-3-5935343

Fax: 886-3-5935342

**Hwa Ya EMC/RF/Safety/Telecom Lab:**

Tel: 886-3-3183232

Fax: 886-3-3270892

**Email:** [service.adt@tw.bureauveritas.com](mailto:service.adt@tw.bureauveritas.com)

**Web Site:** [www.bureauveritas-adt.com](http://www.bureauveritas-adt.com)

The address and road map of all our labs can be found in our web site also.



A D T

## 7. APPENDIX A - MODIFICATIONS RECORDERS FOR ENGINEERING CHANGES TO THE EUT BY THE LAB

No modifications were made to the EUT by the lab during the test.

--- END ---