



FCC TEST REPORT (PART 24)

REPORT NO.: RF130902E05-2

MODEL NO.: xAPT-103PU

FCC ID: MQT-XAPT103PU

RECEIVED: Sep. 02, 2013

TESTED: Sep. 11 to 25, 2013

ISSUED: Oct. 09, 2013

APPLICANT: XAC AUTOMATION CORP.

ADDRESS: 4F, No. 30, INDUSTRY E. RD. IX,
SCIENCE-BASED INDUSTRIAL
PARK,HSINCHU,TAIWAN

ISSUED BY: Bureau Veritas Consumer Products Services (H.K.) Ltd.,
Taoyuan Branch Hsin Chu Laboratory

LAB ADDRESS: No. 81-1, Lu Liao Keng, 9th Ling,Wu Lung Tsuen, Chiung
Lin Hsiang, Hsin Chu Hsien 307, Taiwan, R.O.C.

TEST LOCATION (1) : No. 81-1, Lu Liao Keng, 9th Ling,Wu Lung Tsuen, Chiung
Lin Hsiang, Hsin Chu Hsien 307, Taiwan, R.O.C.

TEST LOCATION (2) : No. 49, Ln. 206, Wende Rd., Shangshan Tsuen, Chiung
Lin Hsiang, Hsin Chu Hsien 307, Taiwan, R.O.C.

This report should not be used by the client to claim product certification, approval, or endorsement by TAF or any government agencies.



This report is for your exclusive use. Any copying or replication of this report to or for any other person or entity, or use of our name or trademark, is permitted only with our prior written permission. This report sets forth our findings solely with respect to the test samples identified herein. The results set forth in this report are not indicative or representative of the quality or characteristics of the lot from which a test sample was taken or any similar or identical product unless specifically and expressly noted. Our report includes all of the tests requested by you and the results thereof based upon the information that you provided to us. You have 60 days from date of issuance of this report to notify us of any material error or omission caused by our negligence, provided, however, that such notice shall be in writing and shall specifically address the issue you wish to raise. A failure to raise such issue within the prescribed time shall constitute your unqualified acceptance of the completeness of this report, the tests conducted and the correctness of the report contents. Unless specific mention, the uncertainty of measurement has been explicitly taken into account to declare the compliance or non-compliance to the specification

TABLE OF CONTENTS

RELEASE CONTROL RECORD	4
1 CERTIFICATION	5
2 SUMMARY OF TEST RESULTS	6
2.1 MEASUREMENT UNCERTAINTY	6
2.2 TEST SITE AND INSTRUMENTS	7
3 GENERAL INFORMATION.....	9
3.1 GENERAL DESCRIPTION OF EUT.....	9
3.2 CONFIGURATION OF SYSTEM UNDER TEST	11
3.3 DESCRIPTION OF SUPPORT UNITS	12
3.4 TEST ITEM AND TEST CONFIGURATION	13
3.5 EUT OPERATING CONDITIONS	14
3.6 GENERAL DESCRIPTION OF APPLIED STANDARDS	14
4 TEST TYPES AND RESULTS.....	15
4.1 OUTPUT POWER MEASUREMENT	15
4.1.1 LIMITS OF OUTPUT POWER MEASUREMENT	15
4.1.2 TEST PROCEDURES	15
4.1.3 TEST SETUP	16
4.1.4 TEST RESULTS	17
4.2 FREQUENCY STABILITY MEASUREMENT	19
4.2.1 LIMITS OF FREQUENCY STABILITY MEASUREMENT	19
4.2.2 TEST PROCEDURE	19
4.2.3 TEST SETUP	19
4.2.4 TEST RESULTS	20
4.3 OCCUPIED BANDWIDTH MEASUREMENT	21
4.3.1 TEST PROCEDURES	21
4.3.2 TEST SETUP	21
4.3.3 TEST RESULTS	22
4.4 PEAK TO AVERAGE RATIO	24
4.4.1 LIMITS OF PEAK TO AVERAGE RATIO MEASUREMENT	24
4.4.2 TEST SETUP	24
4.4.3 TEST PROCEDURES	24
4.4.4 TEST RESULTS	25
4.5 BAND EDGE MEASUREMENT	26
4.5.1 LIMITS OF BAND EDGE MEASUREMENT	26
4.5.2 TEST SETUP	26
4.5.3 TEST PROCEDURES	26
4.5.4 TEST RESULTS	27
4.6 CONDUCTED SPURIOUS EMISSIONS.....	29
4.6.1 LIMITS OF CONDUCTED SPURIOUS EMISSIONS MEASUREMENT	29
4.6.2 TEST PROCEDURE	29
4.6.3 TEST SETUP	29
4.6.4 TEST RESULTS	30
4.7 RADIATED EMISSION MEASUREMENT	33
4.7.1 LIMITS OF RADIATED EMISSION MEASUREMENT	33
4.7.2 TEST PROCEDURES	33
4.7.3 DEVIATION FROM TEST STANDARD	33
4.7.4 TEST SETUP	34
4.7.5 TEST RESULTS	35
5 PHOTOGRAPHS OF THE TEST CONFIGURATION.....	41



A D T

6	INFORMATION ON THE TESTING LABORATORIES	42
7	APPENDIX A – MODIFICATIONS RECORDERS FOR ENGINEERING CHANGES TO THE EUT BY THE LAB.....	43



A D T

RELEASE CONTROL RECORD

ISSUE NO.	REASON FOR CHANGE	DATE ISSUED
RF130902E05-2	Original release	Oct. 09, 2013

1 CERTIFICATION

PRODUCT : Terminal

BRAND NAME : XAC

MODEL NO. : xAPT-103PU

TEST ITEM: ENGINEERING SAMPLE

APPLICANT : XAC AUTOMATION CORP.

TESTED DATE : Sep. 11 to 25, 2013

STANDARDS : FCC Part 24, Subpart E

The above equipment (model: xAPT-103PU) has been tested by **Bureau Veritas Consumer Products Services (H.K.) Ltd., Taoyuan Branch**, and found compliance with the requirement of the above standards. The test record, data evaluation & Equipment Under Test (EUT) configurations represented herein are true and accurate accounts of the measurements of the sample's EMC characteristics under the conditions specified in this report.

PREPARED BY :  , **DATE:** Oct. 09, 2013
(Claire Kuan, Specialist)

APPROVED BY :  , **DATE:** Oct. 09, 2013
(May Chen, Manager)

2 SUMMARY OF TEST RESULTS

The EUT has been tested according to the following specifications:

APPLIED STANDARD: FCC Part 24 & Part 2			
STANDARD SECTION	TEST TYPE	RESULT	REMARK
2.1046 24.232	Equivalent isotropically radiated power	PASS	Meet the requirement of limit.
2.1055 24.235	Frequency Stability	PASS	Meet the requirement of limit.
2.1049 24.238(b)	Occupied Bandwidth	PASS	Meet the requirement of limit.
24.238(b)	Band Edge Measurements	PASS	Meet the requirement of limit.
2.1051 24.238	Conducted Spurious Emissions	PASS	Meet the requirement of limit.
2.1053 24.238	Radiated Spurious Emissions	PASS	Meet the requirement of limit. Minimum passing margin is -10.63dB at 18800MHz.

2.1 MEASUREMENT UNCERTAINTY

Where relevant, the following measurement uncertainty levels have been estimated for tests performed on the EUT as specified in CISPR 16-4-2:

MEASUREMENT	FREQUENCY	UNCERTAINTY
Radiated emissions	30MHz ~ 200MHz	5.46 dB
	200MHz ~ 1000MHz	3.54 dB
	1GHz ~ 18GHz	4.08 dB
	18GHz ~ 40GHz	4.11 dB

This uncertainty represents an expanded uncertainty expressed at approximately the 95% confidence level using a coverage factor of k=2.

2.2 TEST SITE AND INSTRUMENTS

For radiated spurious emissions:

DESCRIPTION & MANUFACTURER	MODEL NO.	SERIAL NO.	CALIBRATED DATE	CALIBRATED UNTIL
Spectrum Analyzer Agilent	E4446A	MY48250253	Aug. 28, 2013	Aug. 27, 2014
MXE EMI Receiver Agilent	N9038A	MY50010156	Jan. 16, 2013	Jan. 15, 2014
Pre-Amplifier Mini-Circuits	ZFL-1000VH2 B	AMP-ZFL-04	Nov. 14, 2012	Nov. 13, 2013
Pre-Amplifier Agilent	8449B	3008A01923	Oct. 30, 2012	Oct. 29, 2013
Pre-Amplifier SPACEK LABS	SLKKa-48-6	9K16	Nov. 14, 2012	Nov. 13, 2013
Trilog Broadband Antenna SCHWARZBECK	VULB 9168	9168-361	Mar. 25, 2013	Mar. 24, 2014
Horn_Antenna AISI	AIH.8018	0000220091110	Nov. 27, 2012	Nov. 26, 2013
Horn_Antenna SCHWARZBECK	BBHA 9170	9170-424	Oct. 12, 2012	Oct. 11, 2013
RF Cable	NA	RF104-205 RF104-207 RF104-202	Dec. 26, 2012	Dec. 25, 2013
RF Cable	NA	CHHCAB_001	Oct. 07, 2012	Oct. 06, 2013
Software	ADT_Radiated _V8.7.05	NA	NA	NA
Antenna Tower & Turn Table CT	NA	NA	NA	NA
Radio Communication Analyzer	Anritsu	MT8820C	May 30, 2013	May 29, 2014
Universal Radio Communication Tester	R&S	CMU200	Oct. 23, 2012	Oct. 22, 2013

Note:

1. The calibration interval of the above test instruments is 12 months and the calibrations are traceable to NML/ROC and NIST/USA.
2. The horn antenna, preamplifier (model: 8449B) are used only for the measurement of emission frequency above 1GHz if tested.
3. The test was performed in 966 Chamber No. H.
4. The FCC Site Registration No. is 797305.
5. The CANADA Site Registration No. is IC 7450H-3.
6. Tested Date: Sep. 11 to 25, 2013



A D T

For other test items:

DESCRIPTION & MANUFACTURER	MODEL NO.	SERIAL NO.	CALIBRATED DATE	CALIBRATED UNTIL
Spectrum Analyzer R&S	FSP 40	100060	May 03, 2013	May 02, 2014
Spectrum Analyzer Agilent	E4446A	MY48250113	Dec. 05, 2012	Dec. 04, 2013
AC Power Source EXTECH Electronics	6502	1140503	NA	NA
Temperature & Humidity Chamber TERCHY	MHU-225AU	911033	Dec. 11, 2012	Dec. 10, 2013
DC Power Supply GOOD WILL INSTRUMENT CO., LTD.	GPC - 3030D	7700087	NA	NA
ESG Vector signal generator Agilent	E4438C	MY47271330 506 602 UNJ	Apr. 30, 2013	Apr. 29, 2014
ESG Vector signal generator Agilent	E4438C	MY45094468/0 05 506 602 UK6 UNJ	Dec. 14, 2012	Dec. 13, 2013
Power meter Anritsu	ML2495A	1014008	Apr. 23, 2013	Apr. 22, 2014
Power sensor Anritsu	MA2411B	0917122	Apr. 23, 2013	Apr. 22, 2014
Power meter Anritsu	ML2495A	0824006	May 20, 2013	May 19, 2014
Power sensor Anritsu	MA2411B	0738172	May 20, 2013	May 19, 2014
Power meter Anritsu	ML2487B	0930006	Nov. 14, 2012	Nov. 13, 2013
Power sensor Anritsu	MA2491A	0845370	Nov. 14, 2012	Nov. 13, 2013
Software	Total Power Measurement Tools V7.1	NA	NA	NA
Software	ADT_RF Test Software V6.6.5.3	NA	NA	NA
Universal Radio Communication Tester	R&S	CMU200	Oct. 23, 2012	Oct. 22, 2013

- NOTE:**
1. The test was performed in Oven room A.
 2. The calibration interval of the above test instruments is 12 months and the calibrations are traceable to NML/ROC and NIST/USA.
 3. Tested Date: Sep. 24, 2013



A D T

3 GENERAL INFORMATION

3.1 GENERAL DESCRIPTION OF EUT

EUT	Terminal	
MODEL NO.	xAPT-103PU	
POWER SUPPLY	DC 7.4V from Battery DC 12V from power adapter	
HW VERSION	B2 (Rev.3)	
SW VERSION	Revision 01.009	
MODULATION TYPE	GPRS	GMSK
	EDGE	8PSK
	WCDMA, HSDPA, HSUPA	BPSK
FREQUENCY RANGE	GPRS, EDGE	1850.2MHz ~ 1909.8MHz
	WCDMA, HSDPA, HSUPA	1852.4MHz ~ 1907.6MHz
MAX. EIRP POWER	GPRS	1548.8mW
	EDGE	707.9mW
	WCDMA	354.8mW
EMISSION DESIGNATOR	GPRS	246KG7W
	EDGE	248KG7W
	WCDMA	4M08F9W
	HSDPA	4M08F9W
	HSUPA	4M08F9W
MULTI-SLOTS CLASS	12	
WCDMA RELEASE VERSION	R7	
ANTENNA TYPE	Refer to NOTE	
I/O PORTS	Refer to users' manual	
DATA CABLE	NA	
ACCESSORY DEVICES	NA	

NOTE:

1. The EUT is a RFID, GSM and WCDMA device.
2. The antennas provided to the EUT, please refer to the following table:

GPRS, EDGE, WCDMA, HSDPA and HSUPA Antenna Spec.					
Brand	Model No.	Antenna Type	Antenna Connector	Gain(dBi)	Frequency range (MHz)
Ethertronics Inc.	T-000084-01	FPCB	NA	0.14	850
				2.57	1900
RFID Antenna Spec.					
Brand	Model No.	Antenna Type	Antenna Connector	Gain(dBi)	Frequency range (MHz)
XAC	PCB ENIG ANT BOARD (W/KEY) 8006(ROHS)	PCB (2 Layer)	NA	13	13.56

3. The EUT could be supplied with DC 7.4V battery or power adapter as the following table:

Item	Brand	Model No.	Spec.
Battery	Foxlink	FD400	DC 7.4V, 2300mAh (17.02Wh)
Adapter	DELTA	ADP-36JH B	AC I/P: 100-240V, 50-60Hz, 1.0A AC input cable: Unshielded, 1.85m DC O/P: 12V, 3A DC output cable: Unshielded, 1.8m with one core

4. The EUT is pre-tested under following test modes :

Pre-test Mode	Description
Mode A	Battery mode
Mode B	Adapter mode

For the above modes, the worse radiated emissions test was found in **Mode B**. Therefore only the test data of the modes were recorded in this report.

5. The EUT inside has one 2G/3G module which FCC ID: QIPEHS5-US.
6. RFID, GSM and WCDMA technology cannot transmit at same time.
7. The above EUT information was declared by manufacturer and for more detailed features description, please refer to the manufacturer's specifications or User's Manual.

3.2 CONFIGURATION OF SYSTEM UNDER TEST

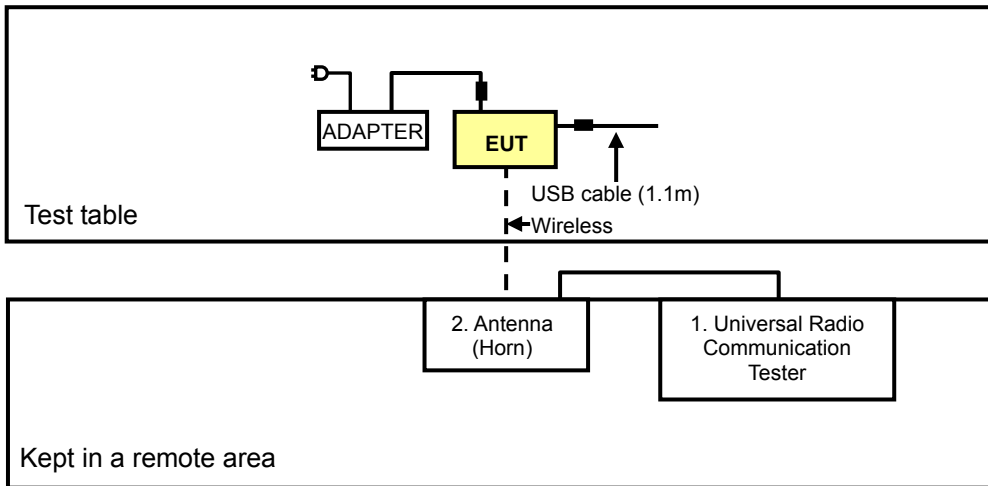

3.3 DESCRIPTION OF SUPPORT UNITS

The EUT has been tested as an independent unit together with other necessary accessories or support units. The following support units or accessories were used to form a representative test configuration during the tests.

NO.	PRODUCT	BRAND	MODEL NO.	SERIAL NO.	FCC ID
1	Universal Radio Communication Tester	R&S	CMU200	121040	NA
2	Antenna (Horn)	ETS.LINDGREN	3115	SN00028262	NA

NO.	SIGNAL CABLE DESCRIPTION OF THE ABOVE SUPPORT UNITS
1	SMA cable (0.6m)
2	NA

NOTE:

1. All power cords of the above support units are non-shielded (1.8m).
2. Items 1-2 act as communication partners to transfer data.



3.4 TEST ITEM AND TEST CONFIGURATION

Following channel(s) was (were) selected for the final test as listed below:

GPRS MODE

TEST ITEM	AVAILABLE CHANNEL	TESTED CHANNEL	MODE
EIRP	512 to 810	512, 661, 810	GPRS, EDGE
FREQUENCY STABILITY	512 to 810	661	GPRS, EDGE
OCCUPIED BANDWIDTH	512 to 810	512, 661, 810	GPRS, EDGE
PEAK TO AVERAGE RATIO	512 to 810	512, 661, 810	GPRS, EDGE
BAND EDGE	512 to 810	512, 810	GPRS, EDGE
CONDCUDED EMISSION	512 to 810	661	GPRS, EDGE
RADIATED EMISSION	512 to 810	661	GPRS, EDGE

WCDMA MODE

TEST ITEM	AVAILABLE CHANNEL	TESTED CHANNEL	MODE
EIRP	9262 to 9538	9262, 9400, 9538	WCDMA
FREQUENCY STABILITY	9262 to 9538	9400	WCDMA
OCCUPIED BANDWIDTH	9262 to 9538	9262, 9400, 9538	WCDMA, HSDPA, HSUPA
PEAK TO AVERAGE RATIO	9262 to 9538	9262, 9400, 9538	WCDMA, HSDPA, HSUPA
BAND EDGE	9262 to 9538	9262, 9538	WCDMA, HSDPA, HSUPA
CONDCUDED EMISSION	9262 to 9538	9400	WCDMA
RADIATED EMISSION	9262 to 9538	9400	WCDMA

TEST CONDITION:

TEST ITEM	ENVIRONMENTAL CONDITIONS	INPUT POWER	TESTED BY
EIRP	25deg. C, 63%RH	7.4Vdc	Rex Huang
FREQUENCY STABILITY	25deg. C, 63%RH	7.4Vdc	Rex Huang
OCCUPIED BANDWIDTH	25deg. C, 63%RH	7.4Vdc	Rex Huang
PEAK TO AVERAGE RATIO	25deg. C, 63%RH	7.4Vdc	Rex Huang
BAND EDGE	25deg. C, 63%RH	7.4Vdc	Rex Huang
CONDCUDED EMISSION	25deg. C, 63%RH	7.4Vdc	Rex Huang
RADIATED EMISSION	25deg. C, 63%RH	120Vac, 60Hz	Rex Huang

3.5 EUT OPERATING CONDITIONS

The EUT makes a call to the communication simulator. The communication simulator station system controlled a EUT to export maximum output power under transmission mode and specific channel frequency

3.6 GENERAL DESCRIPTION OF APPLIED STANDARDS

The EUT is a RF product. According to the specifications of the manufacturer, it must comply with the requirements of the following standards:

FCC 47 CFR Part 2

FCC 47 CFR Part 24

ANSI/TIA/EIA-603-C 2004

NOTE: All test items have been performed and recorded as per the above standards.

4 TEST TYPES AND RESULTS

4.1 OUTPUT POWER MEASUREMENT

4.1.1 LIMITS OF OUTPUT POWER MEASUREMENT

Mobile and portable stations are limited to 2 watts EIRP

4.1.2 TEST PROCEDURES

CONDUCTED POWER MEASUREMENT:

The EUT was set up for the maximum power with GPRS & WCDMA link data modulation and link up with simulator. Set the EUT to transmit under low, middle and high channel and record the power level shown on simulator.

EIRP MEASUREMENT:

- a. All measurements were done at low, middle and high operational frequency range. RBW and VBW is 1MHz for GPRS & EDGE, 5MHz for WCDMA.
- b. Substitution method is used for EIRP measurement. In the semi-anechoic chamber, EUT placed on the 0.8m height of Turn Table, rotated the table around 360 degrees to search the maximum radiation power and receiver antenna shall be rotated vertical and horizontal polarization and moved height from 1m to 4m to find the maximum polar radiated power. The "Read Value" is the spectrum reading the maximum power value.
- c. The substitution horn antenna is substituted for EUT at the same position and signals generator export the CW signal to the substitution antenna via a tx cable. Rotated the Turn Table and moved receiving antenna to find the maximum radiation power. Adjust output power level of S.G to get a Value of spectrum reading equal to "Read Value" of step b. Record the power level of S.G
- d. $EIRP = \text{Output power level of S.G} - \text{TX cable loss} + \text{Antenna gain of substitution horn.}$

4.1.3 TEST SETUP

CONDUCTED POWER MEASUREMENT:



For the actual test configuration, please refer to the attached file (Test Setup Photo).

EIRP MEASUREMENT:

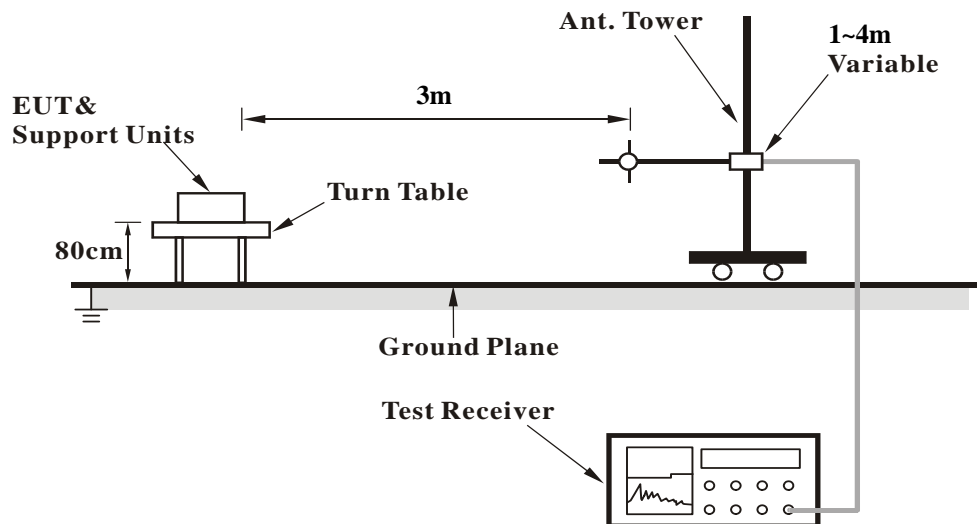

For the actual test configuration, please refer to the attached file (Test Setup Photo).

4.1.4 TEST RESULTS

CONDUCTED OUTPUT POWER (dBm)

Band	GPRS1900		
Channel	512	661	810
Frequency (MHz)	1850.2	1880.0	1909.8
GPRS 8 (1 Uplink)	29.0	28.9	28.8
GPRS 10 (2 Uplink)	26.1	26.0	25.9
GPRS 11 (3 Uplink)	24.3	24.2	24.1
GPRS 12 (4 Uplink)	23.0	22.9	22.8
EDGE 8 (1 Uplink)	25.2	24.8	24.6
EDGE 10 (2 Uplink)	22.8	22.5	22.2
EDGE 11 (3 Uplink)	20.5	20.3	20.0
EDGE 12 (4 Uplink)	19.0	19.1	19.1

Band	WCDMA II		
Channel	9262	9400	9538
Frequency (MHz)	1852.4	1880.0	1907.6
RMC 12.2K	23.9	22.9	22.7
HSDPA Subtest-1	23.5	22.8	22.6
HSDPA Subtest-2	23.6	22.7	22.7
HSDPA Subtest-3	23.5	22.6	22.7
HSDPA Subtest-4	23.6	22.6	22.6
HSUPA Subtest-1	23.5	22.2	22.6
HSUPA Subtest-2	23.4	22.1	22.5
HSUPA Subtest-3	23.6	22.2	22.6
HSUPA Subtest-4	23.6	22.3	22.6
HSUPA Subtest-5	23.4	22.1	22.5



A D T

EIRP POWER (dBm)

GPRS

Plane	Channel	Frequency (MHz)	LVL (dBm)	Correction Factor(dB)	EIRP(dBm)	EIRP(mW)
X	512	1850.2	25.1	6.6	31.7	1479.1
	661	1880.0	25.1	6.7	31.8	1513.6
	810	1909.8	25.2	6.7	31.9	1548.8

EDGE

Plane	Channel	Frequency (MHz)	LVL (dBm)	Correction Factor(dB)	EIRP(dBm)	EIRP(mW)
X	512	1850.2	21.5	6.6	28.1	645.7
	661	1880.0	21.5	6.7	28.2	660.7
	810	1909.8	21.8	6.7	28.5	707.9

WCDMA

Plane	Channel	Frequency (MHz)	LVL (dBm)	Correction Factor(dB)	EIRP(dBm)	EIRP(mW)
X	9262	1852.4	17.9	6.6	24.5	281.8
	9400	1880.0	18.8	6.7	25.5	354.8
	9538	1907.6	18.7	6.7	25.4	346.7

4.2 FREQUENCY STABILITY MEASUREMENT

4.2.1 LIMITS OF FREQUENCY STABILITY MEASUREMENT

The frequency stability shall be sufficient to ensure that the fundamental emission stays within the authorized frequency block.

4.2.2 TEST PROCEDURE

- Device is placed at the oven room. The oven room could control the temperatures and humidity. Power warm up is at least 15 min and power applied should perform before recording frequency error.
- EUT is connected the external power supply to control the DC input power. The test voltage range is from 6.29Vdc to 8.51Vdc working voltage. Each step shall be record the frequency error rate.
- The temperature range step is 10 degrees in this test items. All temperature levels shall be hold the $\pm 0.5^{\circ}\text{C}$ during the measurement testing. The each temperature step shall be at least 0.5 hours, consider the EUT could be test under the stability condition.

NOTE: The frequency error was recorded frequency error from the communication simulator.

4.2.3 TEST SETUP

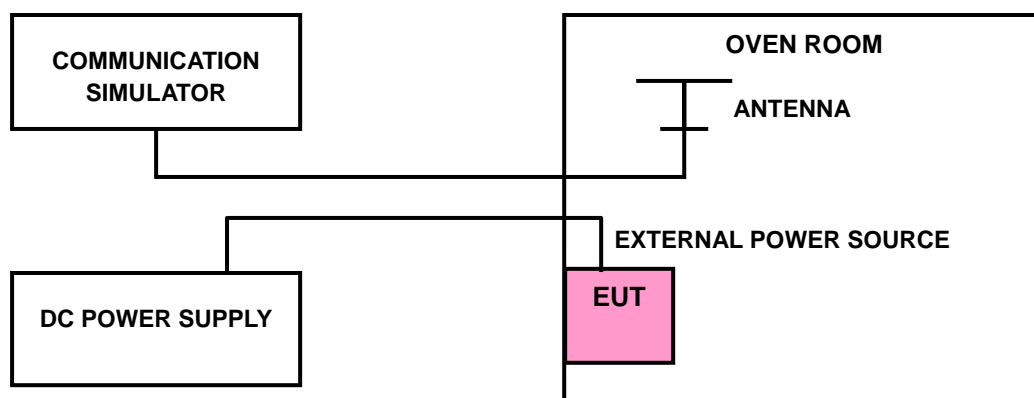

4.2.4 TEST RESULTS

FREQUENCY ERROR VS. VOLTAGE

VOLTAGE (Volts)	FREQUENCY ERROR (ppm)			LIMIT (ppm)
	GPRS	EDGE	WCDMA	
6.29	0.006	0.007	0.008	2.5
8.51	0.007	0.009	0.007	2.5

NOTE: The applicant defined the normal working voltage of the battery is from 6.29Vdc to 8.51Vdc.

FREQUENCY ERROR vs. TEMPERATURE

TEMP. (°C)	FREQUENCY ERROR (ppm)			LIMIT (ppm)
	GPRS	EDGE	WCDMA	
50	0.012	0.014	0.012	2.5
40	0.011	0.013	0.010	2.5
30	0.009	0.012	0.010	2.5
20	0.007	0.011	0.009	2.5
10	0.008	0.010	0.010	2.5
0	0.011	0.011	0.010	2.5
-10	0.013	0.013	0.012	2.5
-20	0.014	0.015	0.013	2.5
-30	0.017	0.016	0.015	2.5

4.3 OCCUPIED BANDWIDTH MEASUREMENT

4.3.1 TEST PROCEDURES

The EUT makes a call to the communication simulator. All measurements were done at low, middle and high operational frequency range. The communication simulator station system controlled a EUT to export maximum output power under transmission mode and specific channel frequency. Use OBW measurement function of Spectrum analyzer to measure 99 % occupied bandwidth.

4.3.2 TEST SETUP

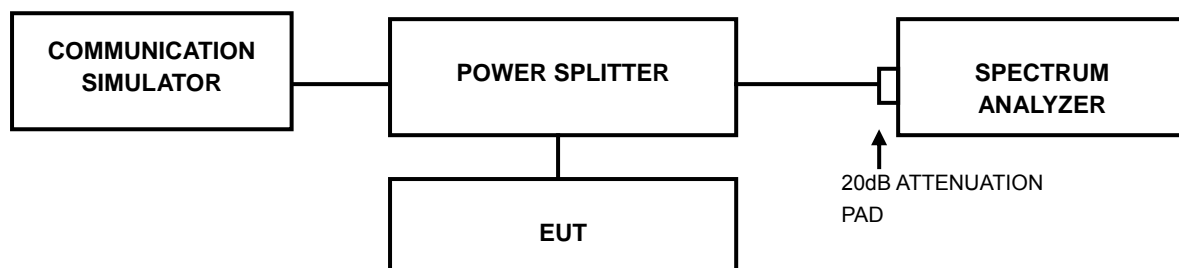

4.3.3 TEST RESULTS

GPRS/EDGE

CHANNEL	FREQUENCY (MHz)	99% OCCUPIED BANDWIDTH (kHz)	
		GPRS	EDGE
512	1850.2	242	248
661	1880.0	246	246
810	1909.8	242	244

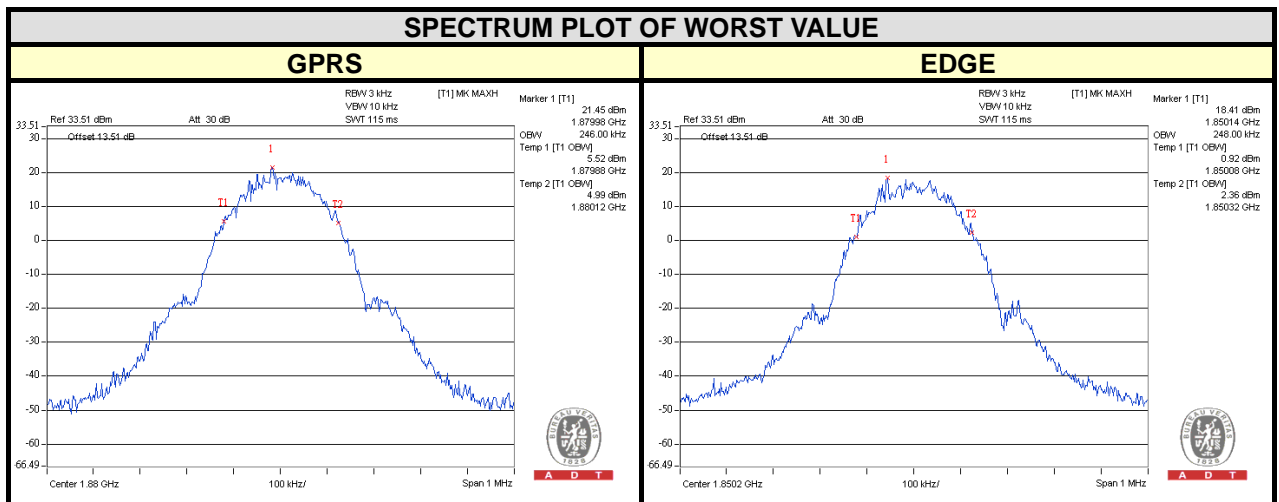



A D T

WCDMA/HSDPA/HSUPA

CHANNEL	FREQUENCY (MHz)	99% OCCUPIED BANDWIDTH (MHz)		
		WCDMA	HSDPA	HSUPA
9262	1852.4	4.06	4.08	4.06
9400	1880.0	4.06	4.06	4.08
9538	1907.6	4.08	4.04	4.06

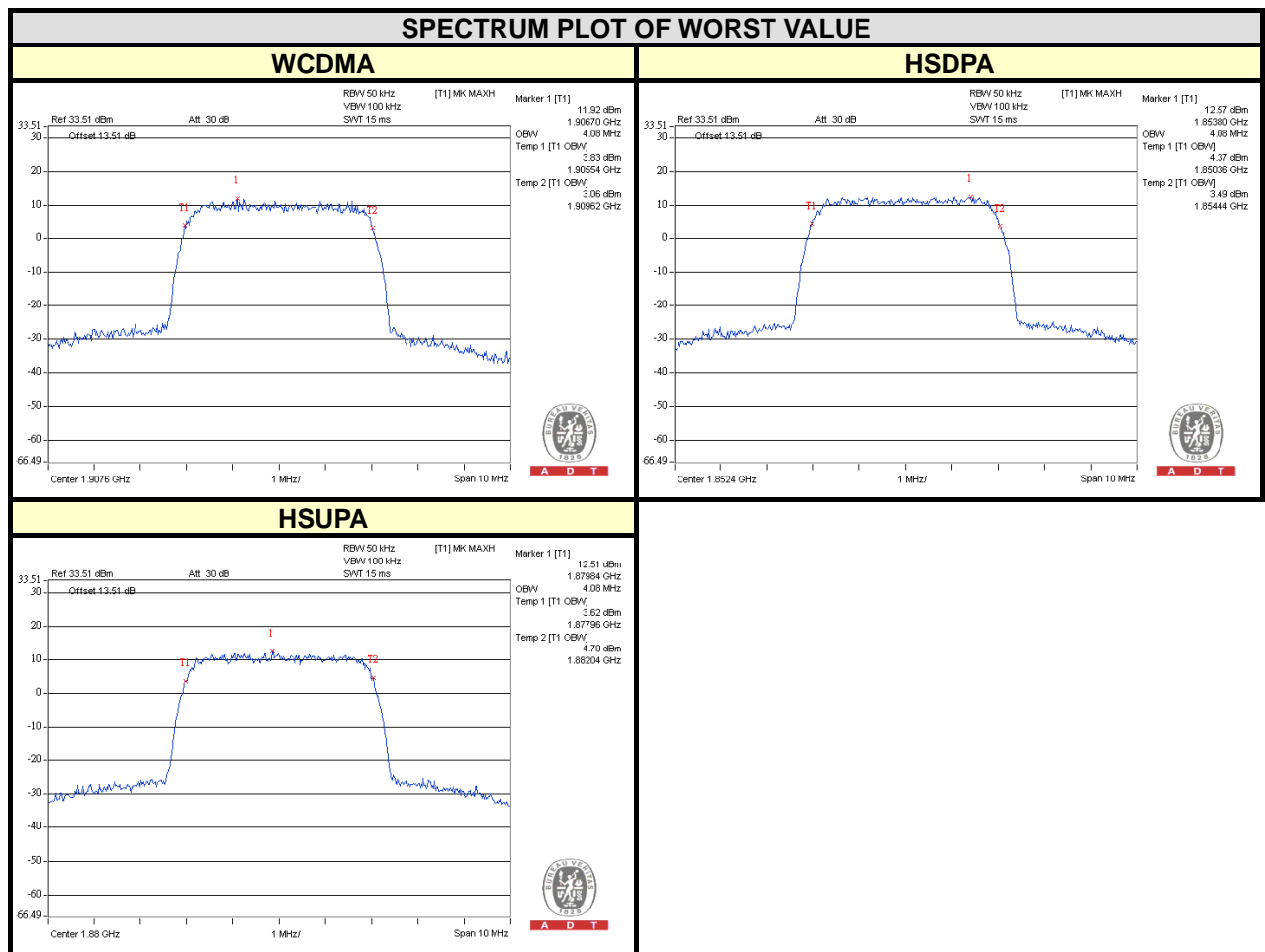

4.4 PEAK TO AVERAGE RATIO

4.4.1 LIMITS OF PEAK TO AVERAGE RATIO MEASUREMENT

In measuring transmissions in this band using an average power technique, the peak to-average ratio (PAR) of the transmission may not exceed 13 dB

4.4.2 TEST SETUP

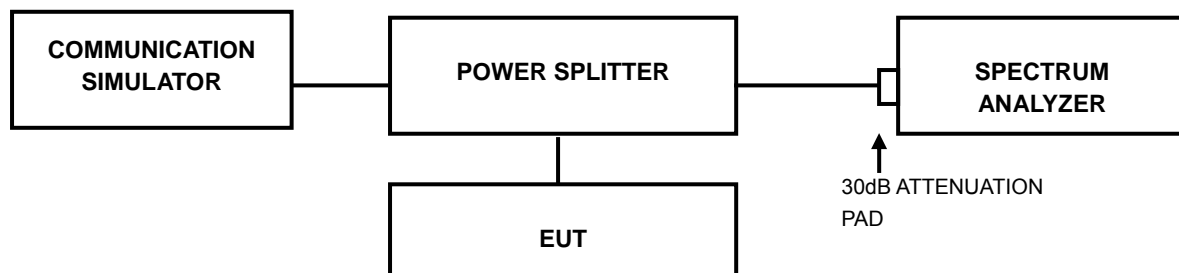

4.4.3 TEST PROCEDURES

1. Set resolution/measurement bandwidth \geq signal's occupied bandwidth;
2. Set the number of counts to a value that stabilizes the measured CCDF curve;
3. Record the maximum PAPR level associated with a probability of 0.1%.



A D T

4.4.4 TEST RESULTS

GPRS			EDGE		
CHANNEL	FREQUENCY (MHz)	PEAK TO AVERAGE RATIO (dB)	CHANNEL	FREQUENCY (MHz)	PEAK TO AVERAGE RATIO (dB)
512	1850.2	0.1	512	1850.2	2.98
661	1880.0	0.1	661	1880.0	3.24
810	1909.8	0.12	810	1909.8	3.23
WCDMA					
CHANNEL		FREQUENCY (MHz)		PEAK TO AVERAGE RATIO (dB)	
9262		1852.4		2.98	
9400		1880.0		3.03	
9538		1907.6		3.09	

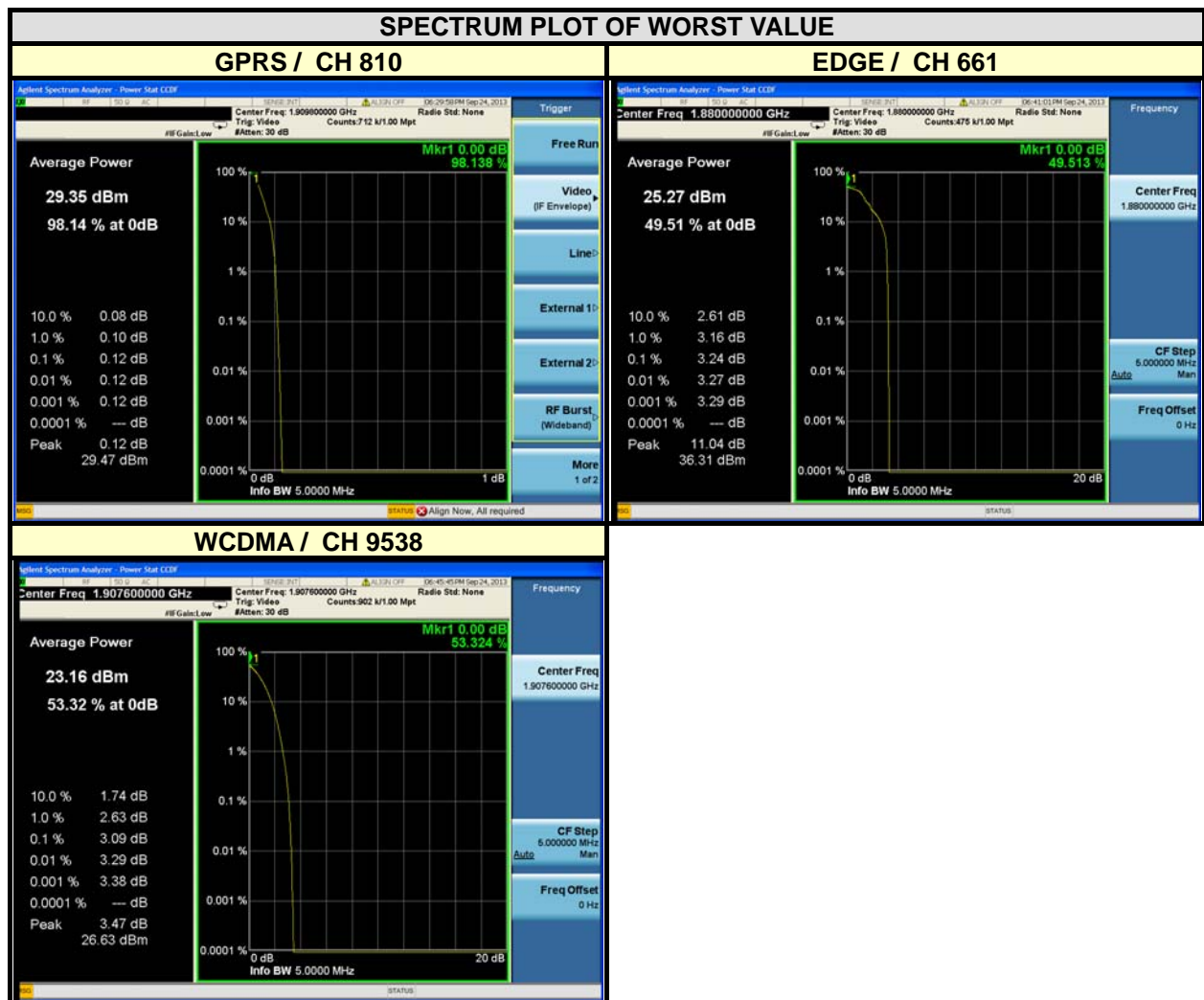

4.5 BAND EDGE MEASUREMENT

4.5.1 LIMITS OF BAND EDGE MEASUREMENT

Power of any emission outside of the authorized operating frequency ranges must be attenuated below the transmitting power (P) by a factor of at least $43 + 10 \log(P)$ dB. In the 1 MHz bands immediately outside and adjacent to the frequency block a resolution bandwidth of at least one percent of the emission bandwidth of the fundamental emission of the transmitter may be employed.

4.5.2 TEST SETUP

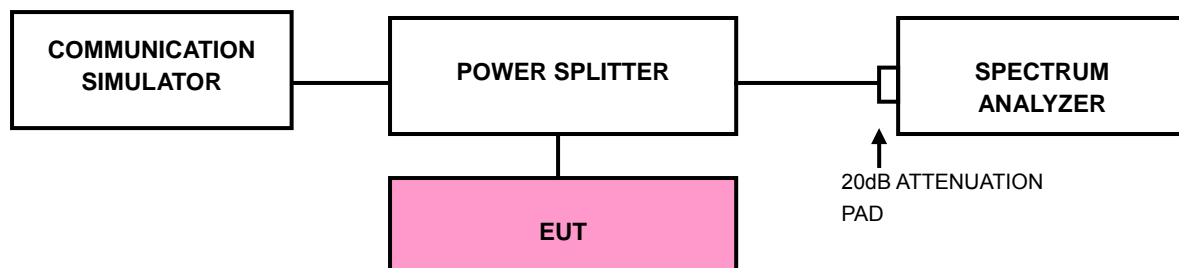

4.5.3 TEST PROCEDURES

- a. All measurements were done at low and high operational frequency range.
- b. The center frequency of spectrum is the band edge frequency and s RB of the spectrum is $>1\%$ OCCUPIED BANDWIDTH and VB of the spectrum is $\geq 3 \cdot RB$.
- c. Record the max trace plot into the test report.



A D T

4.5.4 TEST RESULTS

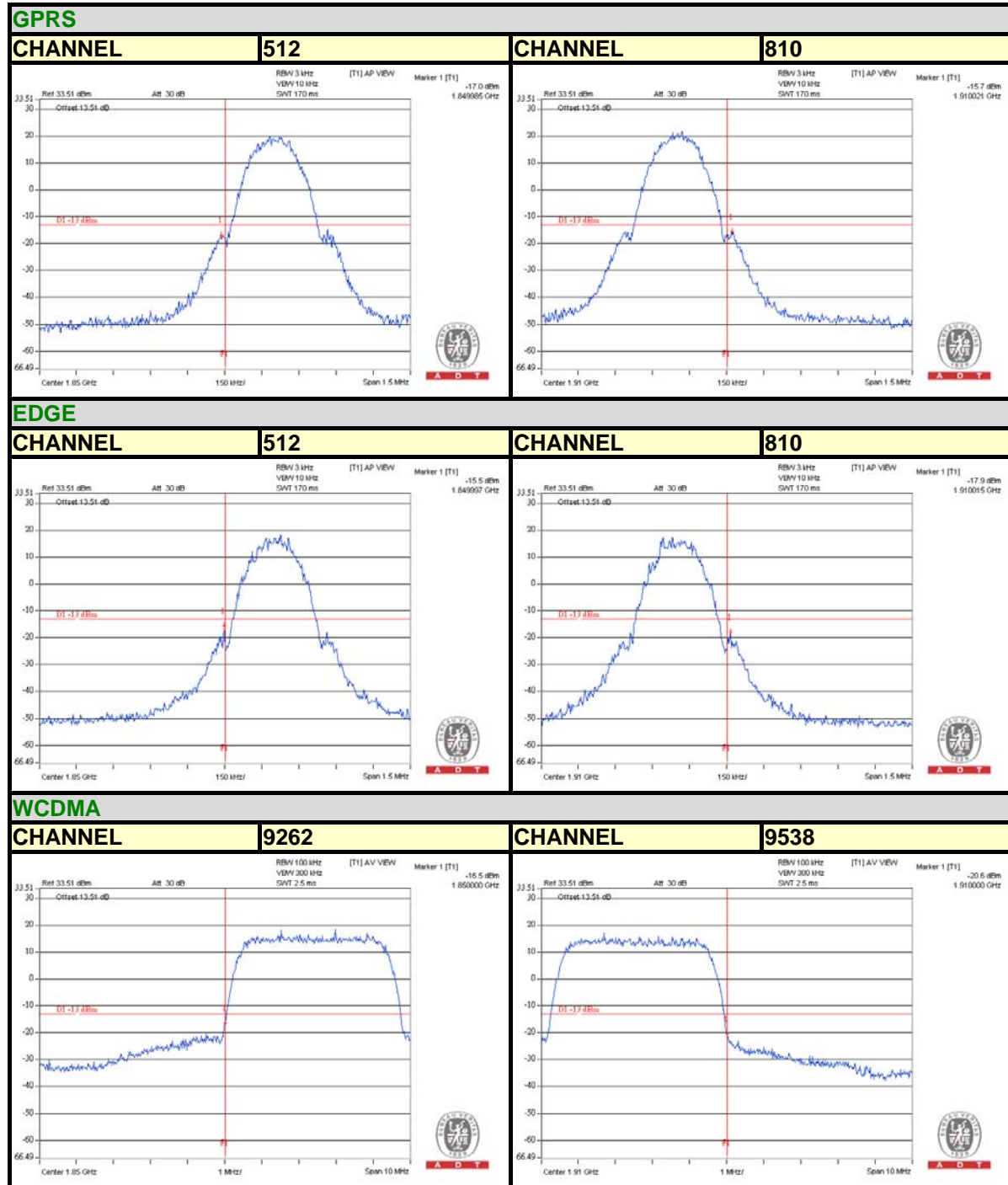



A D T

HSDPA

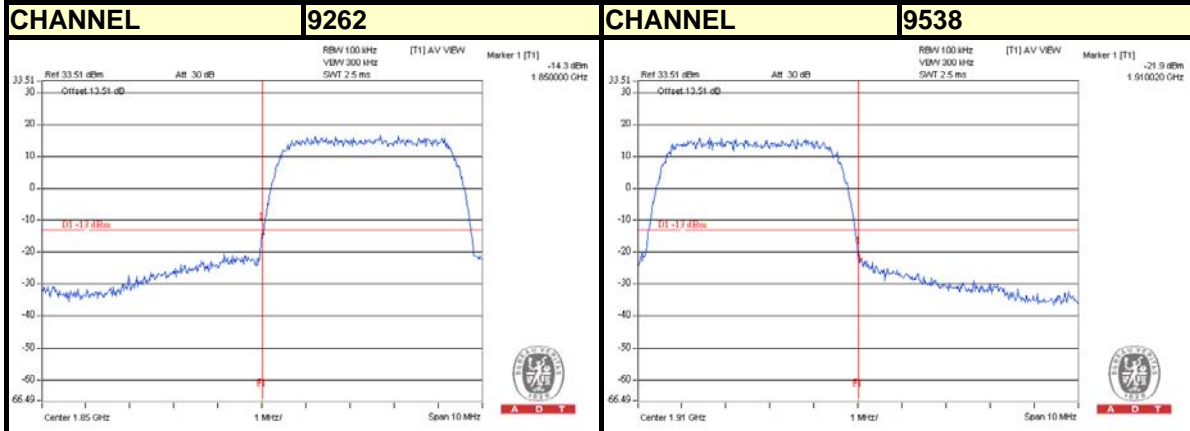

HSUPA

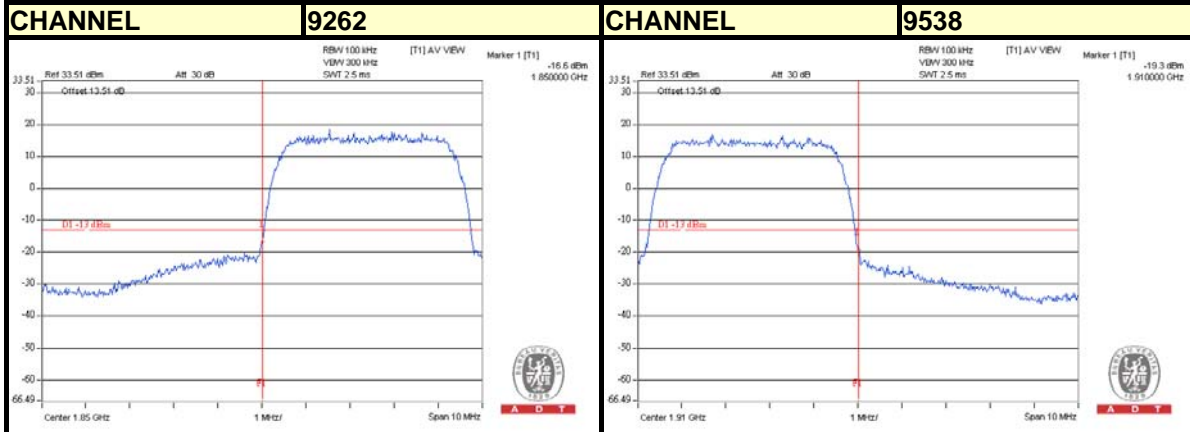

4.6 CONDUCTED SPURIOUS EMISSIONS

4.6.1 LIMITS OF CONDUCTED SPURIOUS EMISSIONS MEASUREMENT

The power of any emission outside of the authorized operating frequency ranges must be attenuated below the transmitting power (P) by a factor of at least $43 + 10 \log(P)$ dB. The emission limit equal to -13dBm .

4.6.2 TEST PROCEDURE

- The EUT makes a phone call to the communication simulator. All measurements were done at low, middle and high operational frequency range.
- Measuring frequency range is from 9kHz to 20GHz. 20dB attenuation pad is connected with spectrum. RBW=1MHz and VBW=3MHz is used for conducted emission measurement.

4.6.3 TEST SETUP

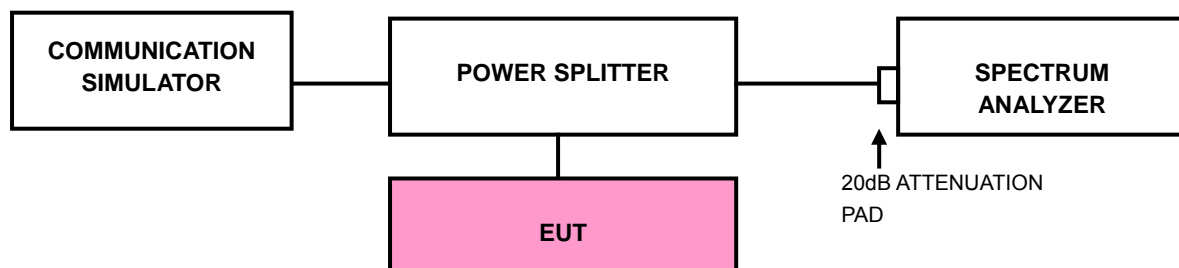



A D T

4.6.4 TEST RESULTS

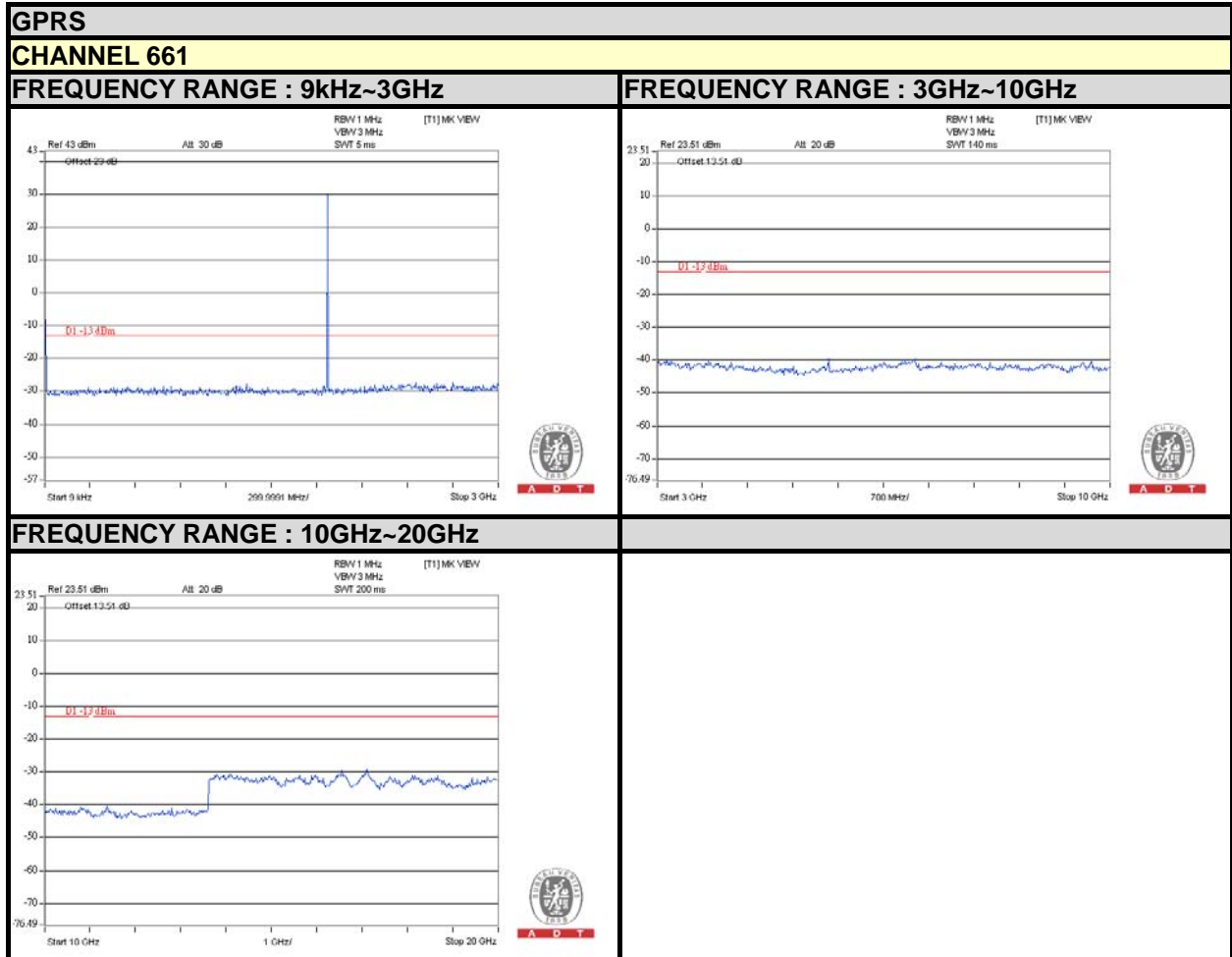



A D T

EDGE

CHANNEL 661

FREQUENCY RANGE : 9kHz~3GHz

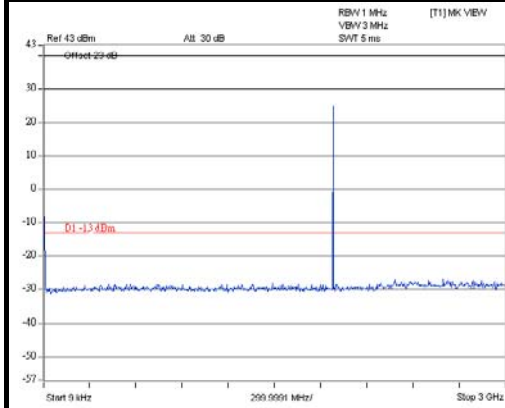

FREQUENCY RANGE : 3GHz~10GHz

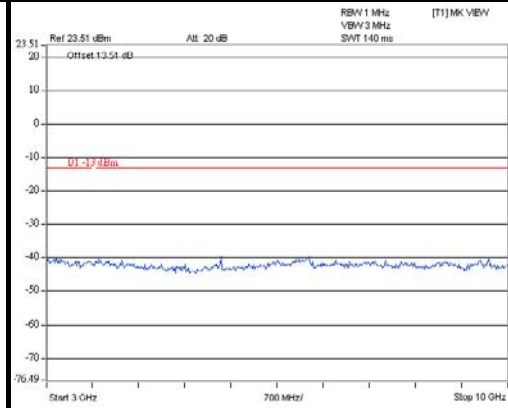

FREQUENCY RANGE : 10GHz~20GHz

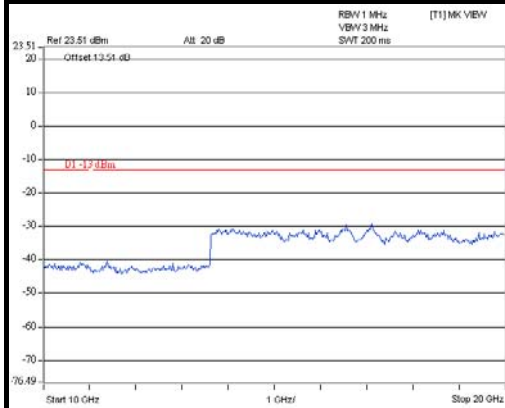



A D T

WCDMA

CHANNEL 9400

FREQUENCY RANGE : 9kHz~3GHz

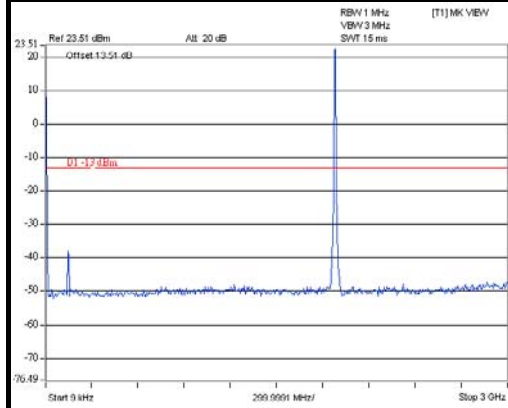

FREQUENCY RANGE : 3GHz~10GHz

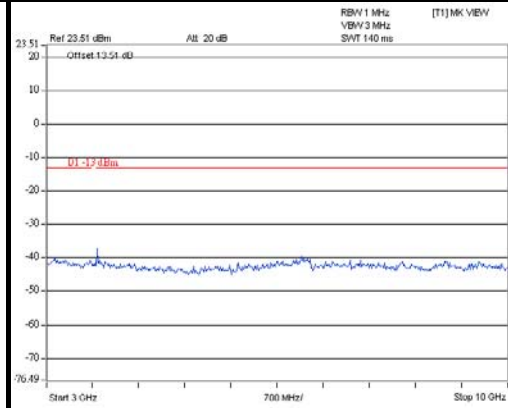

FREQUENCY RANGE : 10GHz~20GHz

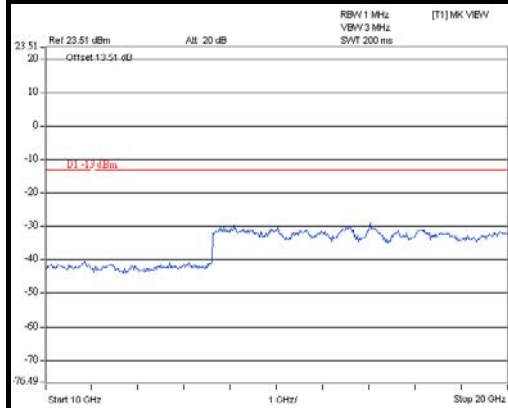

4.7 RADIATED EMISSION MEASUREMENT

4.7.1 LIMITS OF RADIATED EMISSION MEASUREMENT

The power of any emission outside of the authorized operating frequency ranges must be attenuated below the transmitting power (P) by a factor of at least $43 + 10 \log(P)$ dB. The emission limit equal to -13dBm .

4.7.2 TEST PROCEDURES

- a. Substitution method is used for EIRP measurement. In the semi-anechoic chamber, EUT placed on the 0.8m height of Turn Table, rotated the table around 360 degrees to search the maximum radiation power and receiver antenna shall be rotated vertical and horizontal polarization and moved height from 1m to 4m to find the maximum polar radiated power. The “Read Value” is the spectrum reading the maximum power value.
- b. The substitution horn antenna is substituted for EUT at the same position and signals generator export the CW signal to the substitution antenna via a TX cable. Rotated the Turn Table and moved receiving antenna to find the maximum radiation power. Adjust output power level of S.G to get a Value of spectrum reading equal to “Read Value” of step a. Record the power level of S.G
- c. $\text{EIRP} = \text{Output power level of S.G} - \text{TX cable loss} + \text{Antenna gain of substitution horn}$.

NOTE: The resolution bandwidth and video bandwidth of test receiver/spectrum analyzer is 1MHz/3MHz.

4.7.3 DEVIATION FROM TEST STANDARD

No deviation

4.7.4 TEST SETUP

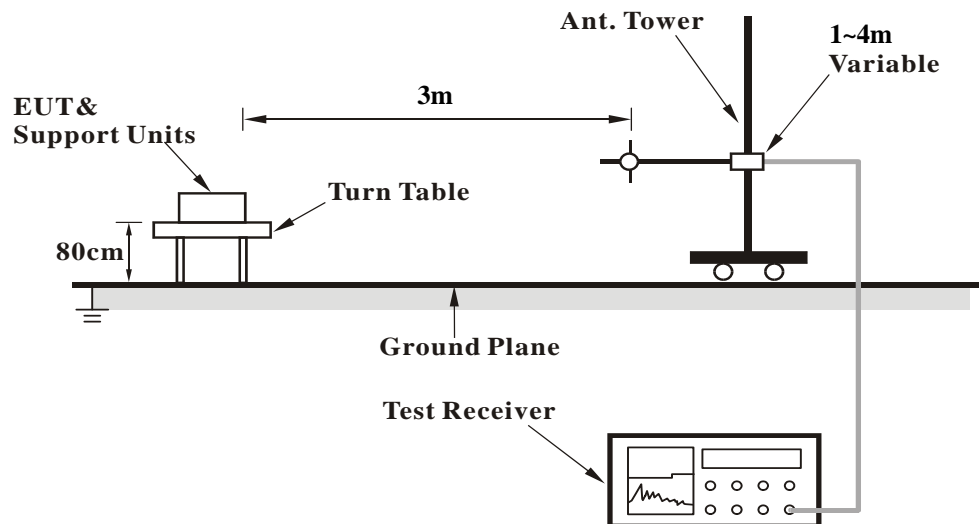

For the actual test configuration, please refer to the attached file (Test Setup Photo).

4.7.5 TEST RESULTS

Below 1GHz

GPRS:

MODE	TX channel 661	FREQUENCY RANGE	Below 1000MHz
-------------	----------------	------------------------	---------------

ANTENNA POLARITY & TEST DISTANCE: HORIZONTAL AT 3 M							
No.	Freq. (MHz)	Reading (dBm)	Limit (dBm)	S.G Power Value (dBm)	Correction Factor (dB)	EIRP (dBm)	Margin (dB)
1	58.82	34.71	-13	-46.98	-7.87	-54.85	-41.85
2	64.3	29.58	-13	-55.12	-6.33	-61.45	-48.45
3	143.94	40.28	-13	-52.53	-1.19	-53.72	-40.72
4	237.12	42.73	-13	-52.63	3.85	-48.78	-35.78
5	281.46	42.60	-13	-52.62	3.83	-48.79	-35.79
6	296.36	40.19	-13	-55.44	3.72	-51.72	-38.72
ANTENNA POLARITY & TEST DISTANCE: VERTICAL AT 3 M							
No.	Freq. (MHz)	Reading (dBm)	Limit (dBm)	S.G Power Value (dBm)	Correction Factor (dB)	EIRP (dBm)	Margin (dB)
1	40.72	35.43	-13	-39.71	-12.28	-51.99	-38.99
2	228.05	39.62	-13	-55.78	3.97	-51.80	-38.80
3	237	41.10	-13	-54.27	3.85	-50.41	-37.41
4	406.8	36.03	-13	-61.87	3.26	-58.61	-45.61
5	798.4	41.46	-13	-57.39	1.57	-55.82	-42.82
6	1000	42.29	-13	-54.18	0.59	-53.59	-40.59

REMARKS:

1. EIRP (dBm) = S.G Power Value (dBm) + Correction Factor (dB).
2. Correction Factor (dB) = Substitution Antenna Gain (dB) + Cable Loss (dB).



A D T

EDGE:

MODE	TX channel 661	FREQUENCY RANGE	Below 1000MHz
-------------	----------------	------------------------	---------------

ANTENNA POLARITY & TEST DISTANCE: HORIZONTAL AT 3 M							
No.	Freq. (MHz)	Reading (dBm)	Limit (dBm)	S.G Power Value (dBm)	Correction Factor (dB)	EIRP (dBm)	Margin (dB)
1	58.82	34.67	-13	-47.02	-7.87	-54.89	-41.89
2	64.3	29.77	-13	-54.93	-6.33	-61.26	-48.26
3	143.94	40.41	-13	-52.40	-1.19	-53.59	-40.59
4	237.12	42.36	-13	-53.00	3.85	-49.15	-36.15
5	281.46	42.38	-13	-52.84	3.83	-49.01	-36.01
6	296.36	40.66	-13	-54.97	3.72	-51.25	-38.25
ANTENNA POLARITY & TEST DISTANCE: VERTICAL AT 3 M							
No.	Freq. (MHz)	Reading (dBm)	Limit (dBm)	S.G Power Value (dBm)	Correction Factor (dB)	EIRP (dBm)	Margin (dB)
1	40.72	35.64	-13	-39.50	-12.28	-51.78	-38.78
2	228.05	39.45	-13	-55.95	3.97	-51.97	-38.97
3	237	41.25	-13	-54.12	3.85	-50.26	-37.26
4	406.8	36.33	-13	-61.57	3.26	-58.31	-45.31
5	798.4	41.36	-13	-57.49	1.57	-55.92	-42.92
6	1000	42.38	-13	-54.09	0.59	-53.50	-40.50

REMARKS:

1. EIRP (dBm) = S.G Power Value (dBm) + Correction Factor (dB).
2. Correction Factor (dB) = Substitution Antenna Gain (dB) + Cable Loss (dB).



A D T

WCDMA:

MODE	TX channel 9400	FREQUENCY RANGE	Below 1000MHz
-------------	-----------------	------------------------	---------------

ANTENNA POLARITY & TEST DISTANCE: HORIZONTAL AT 3 M							
No.	Freq. (MHz)	Reading (dBm)	Limit (dBm)	S.G Power Value (dBm)	Correction Factor (dB)	EIRP (dBm)	Margin (dB)
1	42.32	34.46	-13	-41.26	-11.89	-53.15	-40.15
2	46.2	35.30	-13	-41.83	-10.95	-52.77	-39.77
3	162.9	35.27	-13	-53.74	-0.28	-54.02	-41.02
4	222.2	39.59	-13	-55.83	4.05	-51.78	-38.78
5	251.84	40.23	-13	-54.66	3.91	-50.75	-37.75
6	333.27	39.42	-13	-57.75	3.63	-54.11	-41.11

ANTENNA POLARITY & TEST DISTANCE: VERTICAL AT 3 M							
No.	Freq. (MHz)	Reading (dBm)	Limit (dBm)	S.G Power Value (dBm)	Correction Factor (dB)	EIRP (dBm)	Margin (dB)
1	35.76	34.59	-13	-38.76	-13.49	-52.25	-39.25
2	48.5	33.13	-13	-44.83	-10.38	-55.21	-42.21
3	202.43	36.85	-13	-58.63	4.31	-54.32	-41.32
4	217.3	38.96	-13	-56.47	4.11	-52.36	-39.36
5	251.8	40.13	-13	-54.76	3.91	-50.86	-37.86
6	261.7	39.41	-13	-55.22	3.96	-51.25	-38.25

REMARKS:

1. EIRP (dBm) = S.G Power Value (dBm) + Correction Factor (dB).
2. Correction Factor (dB) = Substitution Antenna Gain (dB) + Cable Loss (dB).



A D T

Above 1GHz

GPRS:

MODE	TX channel 661	FREQUENCY RANGE	Above 1000MHz
-------------	----------------	------------------------	---------------

ANTENNA POLARITY & TEST DISTANCE: HORIZONTAL AT 3 M							
No.	Freq. (MHz)	Reading (dBm)	Limit (dBm)	S.G Power Value (dBm)	Correction Factor (dB)	EIRP (dBm)	Margin (dB)
1	3760	47.00	-13	-57.15	7.68	-49.47	-36.47
2	5640	54.70	-13	-50.04	7.02	-43.02	-30.02
3	7520	56.20	-13	-46.42	4.53	-41.89	-28.89
4	9400	56.3	-13	-45.57	4.21	-41.37	-28.37
5	11280	58	-13	-43.49	3.48	-40.01	-27.01
6	13160	62.4	-13	-38.21	4.06	-34.14	-21.14
7	15040	63.3	-13	-34.05	3.70	-30.35	-17.35
8	16920	66.9	-13	-30.45	3.70	-26.75	-13.75
9	18800	69.7	-13	-27.65	3.70	-23.95	-10.95
ANTENNA POLARITY & TEST DISTANCE: VERTICAL AT 3 M							
No.	Freq. (MHz)	Reading (dBm)	Limit (dBm)	S.G Power Value (dBm)	Correction Factor (dB)	EIRP (dBm)	Margin (dB)
1	3760	48.3	-13	-55.85	7.68	-48.17	-35.17
2	5640	52.3	-13	-52.44	7.02	-45.42	-32.42
3	7520	56.7	-13	-45.92	4.53	-41.39	-28.39
4	9400	56.4	-13	-45.47	4.21	-41.27	-28.27
5	11280	58.5	-13	-42.99	3.48	-39.51	-26.51
6	13160	62	-13	-38.61	4.06	-34.54	-21.54
7	15040	63.2	-13	-34.15	3.70	-30.45	-17.45
8	16920	67.1	-13	-30.25	3.70	-26.55	-13.55
9	18800	69.3	-13	-28.05	3.70	-24.35	-11.35

REMARKS:

1. EIRP (dBm) = S.G Power Value (dBm) + Correction Factor (dB).
2. Correction Factor (dB) = Substitution Antenna Gain (dB) + Cable Loss (dB).



A D T

EDGE:

MODE	TX channel 661	FREQUENCY RANGE	Above 1000MHz
-------------	----------------	------------------------	---------------

ANTENNA POLARITY & TEST DISTANCE: HORIZONTAL AT 3 M

No.	Freq. (MHz)	Reading (dBm)	Limit (dBm)	S.G Power Value (dBm)	Correction Factor (dB)	EIRP (dBm)	Margin (dB)
1	3760	46.57	-13	-57.58	7.68	-49.90	-36.90
2	5640	55.36	-13	-49.38	7.02	-42.36	-29.36
3	7520	57.11	-13	-45.51	4.53	-40.98	-27.98
4	9400	55.37	-13	-46.50	4.21	-42.30	-29.30
5	11280	57.39	-13	-44.10	3.48	-40.62	-27.62
6	13160	63.37	-13	-37.24	4.06	-33.17	-20.17
7	15040	64.22	-13	-33.13	3.70	-29.43	-16.43
8	16920	66.4	-13	-30.95	3.70	-27.25	-14.25
9	18800	69.71	-13	-27.64	3.70	-23.94	-10.94

ANTENNA POLARITY & TEST DISTANCE: VERTICAL AT 3 M

No.	Freq. (MHz)	Reading (dBm)	Limit (dBm)	S.G Power Value (dBm)	Correction Factor (dB)	EIRP (dBm)	Margin (dB)
1	3760	47.46	-13	-56.69	7.68	-49.01	-36.01
2	5640	52.87	-13	-51.87	7.02	-44.85	-31.85
3	7520	56.39	-13	-46.23	4.53	-41.70	-28.70
4	9400	56.07	-13	-45.80	4.21	-41.60	-28.60
5	11280	59.28	-13	-42.21	3.48	-38.73	-25.73
6	13160	62.3	-13	-38.31	4.06	-34.24	-21.24
7	15040	63.68	-13	-33.67	3.70	-29.97	-16.97
8	16920	66.78	-13	-30.57	3.70	-26.87	-13.87
9	18800	70.02	-13	-27.33	3.70	-23.63	-10.63

REMARKS:

1. EIRP (dBm) = S.G Power Value (dBm) + Correction Factor (dB).
2. Correction Factor (dB) = Substitution Antenna Gain (dB) + Cable Loss (dB).



A D T

WCDMA:

MODE	TX channel 9400	FREQUENCY RANGE	Above 1000MHz
------	-----------------	-----------------	---------------

ANTENNA POLARITY & TEST DISTANCE: HORIZONTAL AT 3 M							
No.	Freq. (MHz)	Reading (dBm)	Limit (dBm)	S.G Power Value (dBm)	Correction Factor (dB)	EIRP (dBm)	Margin (dB)
1	3760	54.20	-13	-49.95	7.68	-42.27	-29.27
2	5640	50.10	-13	-54.64	7.02	-47.62	-34.62
3	7520	54.90	-13	-47.72	4.53	-43.19	-30.19
4	9400	55.7	-13	-46.17	4.21	-41.97	-28.97
5	11280	57.6	-13	-43.89	3.48	-40.41	-27.41
6	13160	60.6	-13	-40.01	4.06	-35.94	-22.94
7	15040	61.4	-13	-35.95	3.70	-32.25	-19.25
8	16920	66	-13	-31.35	3.70	-27.65	-14.65
9	18800	68.9	-13	-28.45	3.70	-24.75	-11.75
ANTENNA POLARITY & TEST DISTANCE: VERTICAL AT 3 M							
No.	Freq. (MHz)	Reading (dBm)	Limit (dBm)	S.G Power Value (dBm)	Correction Factor (dB)	EIRP (dBm)	Margin (dB)
1	3760	52.1	-13	-52.05	7.68	-44.37	-31.37
2	5640	50.7	-13	-54.04	7.02	-47.02	-34.02
3	7520	55.4	-13	-47.22	4.53	-42.69	-29.69
4	9400	54.8	-13	-47.07	4.21	-42.87	-29.87
5	11280	57.4	-13	-44.09	3.48	-40.61	-27.61
6	13160	60.8	-13	-39.81	4.06	-35.74	-22.74
7	15040	62.2	-13	-35.15	3.70	-31.45	-18.45
8	16920	65.9	-13	-31.45	3.70	-27.75	-14.75
9	18800	68.3	-13	-29.05	3.70	-25.35	-12.35

REMARKS:

1. EIRP (dBm) = S.G Power Value (dBm) + Correction Factor (dB).
2. Correction Factor (dB) = Substitution Antenna Gain (dB) + Cable Loss (dB).



5 PHOTOGRAPHS OF THE TEST CONFIGURATION

Please refer to the attached file (Test Setup Photo).



6 INFORMATION ON THE TESTING LABORATORIES

We, Bureau Veritas Consumer Products Services (H.K.) Ltd., Taoyuan Branch, were founded in 1988 to provide our best service in EMC, Radio, Telecom and Safety consultation. Our laboratories are accredited and approved according to ISO/IEC 17025.

If you have any comments, please feel free to contact us at the following:

Linko EMC/RF Lab:

Tel: 886-2-26052180

Fax: 886-2-26051924

Hsin Chu EMC/RF Lab:

Tel: 886-3-5935343

Fax: 886-3-5935342

Hwa Ya EMC/RF/Safety/Telecom Lab:

Tel: 886-3-3183232

Fax: 886-3-3270892

Email: service.adt@tw.bureauveritas.com

Web Site: www.bureauveritas-adt.com

The address and road map of all our labs can be found in our web site also.



7 APPENDIX A – MODIFICATIONS RECORDERS FOR ENGINEERING CHANGES TO THE EUT BY THE LAB

No any modifications were made to the EUT by the lab during the test.

---END---