

FCC Test Report

Report No.: RF131029E03H-1

FCC ID: MQT-T103WIFI3GT

Test Model: xAPT-103WiFi.3G

Series Model: xCE_T103WiFi.3G

Received Date: Dec. 14, 2012

Test Date: Jan. 08, 2013; Nov. 16 to 23, 2016

Issued Date: Dec. 07, 2016

Applicant: XAC AUTOMATION CORP.

Address: 4F, No. 30, INDUSTRY E. RD. IX, SCIENCE-BASED INDUSTRIAL
PARK,HSINCHU,TAIWAN

Issued By: Bureau Veritas Consumer Products Services (H.K.) Ltd., Taoyuan Branch
Hsin Chu Laboratory

Lab Address: E-2, No.1, Li Hsin 1st Road, Hsinchu Science Park, Hsinchu City 300,
Taiwan R.O.C.

Test Location (1): E-2, No.1, Li Hsin 1st Road, Hsinchu Science Park, Hsinchu City 300,
Taiwan R.O.C.

Test Location (2): No. 49, Ln. 206, Wende Rd., Shangshan Tsuen, Chiung Lin Hsiang, Hsin
Chu Hsien 307, Taiwan R.O.C.



This report is for your exclusive use. Any copying or replication of this report to or for any other person or entity, or use of our name or trademark, is permitted only with our prior written permission. This report sets forth our findings solely with respect to the test samples identified herein. The results set forth in this report are not indicative or representative of the quality or characteristics of the lot from which a test sample was taken or any similar or identical product unless specifically and expressly noted. Our report includes all of the tests requested by you and the results thereof based upon the information that you provided to us. You have 60 days from date of issuance of this report to notify us of any material error or omission caused by our negligence, provided, however, that such notice shall be in writing and shall specifically address the issue you wish to raise. A failure to raise such issue within the prescribed time shall constitute your unqualified acceptance of the completeness of this report, the tests conducted and the correctness of the report contents. Unless specific mention, the uncertainty of measurement has been explicitly taken into account to declare the compliance or non-compliance to the specification. The report must not be used by the client to claim product certification, approval, or endorsement by TAF or any government agencies.

Table of Contents

| | |
|---|-----------|
| Release Control Record | 3 |
| 1 Certificate of Conformity | 4 |
| 2 Summary of Test Results | 5 |
| 2.1 Measurement Uncertainty | 5 |
| 2.2 Modification Record | 5 |
| 3 General Information | 6 |
| 3.1 General Description of EUT | 6 |
| 3.2 Description of Test Modes | 8 |
| 3.2.1 Test Mode Applicability and Tested Channel Detail | 9 |
| 3.3 Description of Support Units | 11 |
| 3.3.1 Configuration of System under Test | 12 |
| 3.4 General Description of Applied Standards | 14 |
| 4 Test Types and Results | 15 |
| 4.1 Radiated Emission Measurement | 15 |
| 4.1.1 Limits of Radiated Emission Measurement | 15 |
| 4.1.2 Test Instruments | 16 |
| 4.1.3 Test Procedures | 17 |
| 4.1.4 Deviation from Test Standard | 17 |
| 4.1.5 Test Setup | 18 |
| 4.1.6 EUT Operating Conditions | 18 |
| 4.1.7 Test Results | 19 |
| 4.2 Conducted Emission Measurement | 23 |
| 4.2.1 Limits of Conducted Emission Measurement | 23 |
| 4.2.2 Test Instruments | 23 |
| 4.2.3 Test Procedures | 24 |
| 4.2.4 Deviation from Test Standard | 24 |
| 4.2.5 TEST SETUP | 24 |
| 4.2.6 EUT Operating Conditions | 24 |
| 4.2.7 Test Results | 25 |
| 4.3 Frequency Stability | 27 |
| 4.3.1 Limits of Frequency Stability Measurement | 27 |
| 4.3.2 Test Setup | 27 |
| 4.3.3 Test Instruments | 27 |
| 4.3.4 Test Procedure | 28 |
| 4.3.5 Deviation from Test Standard | 28 |
| 4.3.6 EUT Operating Conditions | 28 |
| 4.3.7 Test Result | 29 |
| 4.4 20dB bandwidth | 30 |
| 4.4.1 Limits Of 20dB bandwidth Measurement | 30 |
| 4.4.2 Test Setup | 30 |
| 4.4.3 Test Instruments | 30 |
| 4.4.4 Test Procedures | 30 |
| 4.4.5 Deviation from Test Standard | 30 |
| 4.4.6 EUT Operating Conditions | 30 |
| 4.4.7 Test Results | 31 |
| 5 Pictures of Test Arrangements | 32 |
| Appendix – Information on the Testing Laboratories | 33 |

Release Control Record

| Issue No. | Description | Date Issued |
|----------------|-------------------|---------------|
| RF131029E03H-1 | Original release. | Dec. 07, 2016 |

1 Certificate of Conformity

Product: Terminal

Brand: XAC

Test Model: xAPT-103WiFi.3G

Series Model: xCE_T103WiFi.3G

Sample Status: MASS-PRODUCTION

Applicant: XAC AUTOMATION CORP.

Test Date: Jan. 08, 2013; Nov. 16 to 23, 2016

Standards: 47 CFR FCC Part 15, Subpart C (Section 15.225)
47 CFR FCC Part 15, Subpart C (Section 15.215)
ANSI C63.10:2013

The above equipment has been tested by **Bureau Veritas Consumer Products Services (H.K.) Ltd., Taoyuan Branch**, and found compliance with the requirement of the above standards. The test record, data evaluation & Equipment Under Test (EUT) configurations represented herein are true and accurate accounts of the measurements of the sample's EMC characteristics under the conditions specified in this report.

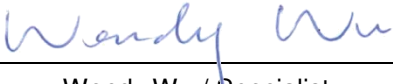
Prepared by :  , **Date:** Dec. 07, 2016
Wendy Wu / Specialist

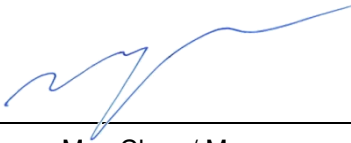
Approved by :  , **Date:** Dec. 07, 2016
May Chen / Manager

2 Summary of Test Results

| 47 CFR FCC Part 15, Subpart C (SECTION 15.225, 15.215) | | | |
|--|--|--------|---|
| FCC Clause | Test Item | Result | Remarks |
| 15.207 | Conducted emission test | PASS | Meet the requirement of limit. Minimum passing margin is -16.50dB at 0.15781MHz. |
| 15.225 (a) | The field strength of any emissions within the band 13.553-13.567 MHz | PASS | Meet the requirement of limit. |
| 15.225 (b) | The field strength of any emissions within the bands 13.410-13.553 MHz and 13.567-13.710 MHz | PASS | Meet the requirement of limit. |
| 15.225 (c) | The field strength of any emissions within the bands 13.110-13.410 MHz and 13.710-14.010 MHz | PASS | Meet the requirement of limit. |
| 15.225 (d) | The field strength of any emissions appearing outside of the 13.110-14.010 MHz band | PASS | Meet the requirement of limit. Minimum passing margin is -0.2dB at 426.68MHz. |
| 15.225 (e) | The frequency tolerance | PASS | Meet the requirement of limit. |
| 15.215 (c) | 20dB Bandwidth | PASS | Meet the requirement of limit. |

2.1 Measurement Uncertainty

Where relevant, the following measurement uncertainty levels have been estimated for tests performed on the EUT as specified in CISPR 16-4-2:

| Measurement | Frequency | Expanded Uncertainty (k=2) (\pm) |
|------------------------------------|----------------|--------------------------------------|
| Conducted Emissions at mains ports | 150kHz ~ 30MHz | 1.83 dB |
| Radiated Emissions up to 1 GHz | 30MHz ~ 1GHz | 3.47 dB |
| | 1GHz ~ 6GHz | 3.65 dB |
| Radiated Emissions above 1 GHz | 6GHz ~ 18GHz | 3.88 dB |
| | 18GHz ~ 40GHz | 4.11 dB |

2.2 Modification Record

There were no modifications required for compliance.

3 General Information

3.1 General Description of EUT

| | |
|---------------------|---------------------------|
| Product | Terminal |
| Brand | XAC |
| Test Model | xAPT-103WiFi.3G |
| Series Model | xCE_T103WiFi.3G |
| Status of EUT | MASS-PRODUCTION |
| Power Supply Rating | DC 12V from power adapter |
| Modulation Type | ASK |
| Operating Frequency | 13.56MHz |
| Number of Channel | 1 |
| Antenna Type | Refer to Note |
| Antenna Connector | Refer to Note |
| Accessory Device | Adapter (Optional) x 1 |
| Data Cable Supplied | NA |

Note:

- All models are listed as below.

| Brand | Model | Difference |
|-------|-----------------|---------------------------|
| XAC | xAPT-103WiFi.3G | For marketing requirement |
| | xCE_T103WiFi.3G | |

From the above models, model: **xAPT-103WiFi.3G** was selected as representative model for the test and its data was recorded in this report.

- The EUT is a WLAN, RFID, GSM and WCDMA device.
- WLAN, RFID, GSM and WCDMA technology cannot transmit at same time.
- The EUT power needs to be supplied from one power adapter, the information is as below table:

| | |
|----------------|---|
| Brand: | DELTA |
| Model No.: | ADP-36PH B |
| Input power : | AC100-240V, 1A, 50-60Hz AC input cable (Unshielded, 1.75m) |
| Output power : | DC 12V, 3A DC output cable (Unshielded, 0.9 m with one core) |

5. The antennas provided to the EUT, please refer to the following table:

| RFID Antenna Spec. | | | | | |
|--|---------------------------------------|--------------|-------------------|--|-----------------|
| Brand | Model No. | Antenna Type | Antenna Connector | Gain(dBi) | Frequency (MHz) |
| XAC | PCB ENIG ANT BOARD (W/KEY) 8006(ROHS) | Loop Antenna | NA | 13 | 13.56 |
| GPRS / WCDMA(UMTS) / HSDPA / EDGE Antenna Spec. | | | | | |
| Brand | Model No. | Antenna Type | Antenna Connector | Gain(dBi) | Frequency (MHz) |
| Ethertronics Inc. | T-000084-01 | FPCB | NA | 0.14 | 850 |
| | | | | 2.57 | 1900 |
| WLAN Antenna Spec. | | | | | |
| Brand | Model No. | Antenna Type | Antenna Connector | Antenna Gain(dBi) <Including cable loss> | Frequency (MHz) |
| ACX | AT3216-T2R4 PAA | Chip | NA | 1.5 | 2400-2500 |

6. The above EUT information is declared by manufacturer and for more detailed features description, please refer to the manufacturer's specifications or user's manual.

3.2 Description of Test Modes

One channel was provided to this EUT:

| Channel | FREQ. (MHz) |
|---------|-------------|
| 1 | 13.56 |

3.2.1 Test Mode Applicability and Tested Channel Detail

| EUT CONFIGURE MODE | APPLICABLE TO | | | | DESCRIPTION |
|--------------------|---------------|-----|----|----|-------------|
| | RE | PLC | FS | EB | |
| - | √ | √ | √ | √ | - |

Where

RE: Radiated Emission

PLC: Power Line Conducted Emission

FS: Frequency Stability

EB: 20dB Bandwidth measurement

RADIATED EMISSION TEST:

- Pre-Scan has been conducted to determine the worst-case mode from all possible combinations between available modulations, data rates and antenna ports (if EUT with antenna diversity architecture).
- Following channel(s) was (were) selected for the final test as listed below.

| AVAILABLE CHANNEL | TESTED CHANNEL | MODULATION TYPE |
|-------------------|----------------|-----------------|
| 1 | 1 | ASK |

POWER LINE CONDUCTED EMISSION TEST:

- Pre-Scan has been conducted to determine the worst-case mode from all possible combinations between available modulations, data rates and antenna ports (if EUT with antenna diversity architecture).
- Following channel(s) was (were) selected for the final test as listed below.

| AVAILABLE CHANNEL | TESTED CHANNEL | MODULATION TYPE |
|-------------------|----------------|-----------------|
| 1 | 1 | ASK |

FREQUENCY STABILITY:

- Pre-Scan has been conducted to determine the worst-case mode from all possible combinations between available modulations, data rates and antenna ports (if EUT with antenna diversity architecture).
- Following channel(s) was (were) selected for the final test as listed below.

| AVAILABLE CHANNEL | TESTED CHANNEL | MODULATION TYPE |
|-------------------|----------------|-----------------|
| 1 | 1 | ASK |

20dB BANDWIDTH:

- This item includes all test value of each mode, but only includes spectrum plot of worst value of each mode.
- Pre-Scan has been conducted to determine the worst-case mode from all possible combinations between available modulations, data rates and antenna ports (if EUT with antenna diversity architecture).
- Following channel(s) was (were) selected for the final test as listed below.

| AVAILABLE CHANNEL | TESTED CHANNEL | MODULATION TYPE |
|-------------------|----------------|-----------------|
| 1 | 1 | ASK |

TEST CONDITION:

| Applicable To | Environmental Conditions | Input Power | Tested By |
|---------------|--------------------------|--------------|-----------|
| RE | 23deg. C, 72%RH | 120Vac, 60Hz | Andy Ho |
| | 25deg. C, 67%RH | | Weiwei Lo |
| PLC | 24deg. C, 71%RH | 120Vac, 60Hz | Andy Ho |
| FS | 25deg. C, 60%RH | 120Vac, 60Hz | Rex Huang |
| EB | 25deg. C, 60%RH | 120Vac, 60Hz | Rex Huang |

3.3 Description of Support Units

The EUT has been tested as an independent unit together with other necessary accessories or support units. The following support units or accessories were used to form a representative test configuration during the tests.

| No. | Product | Brand | Model No. | Serial No. | FCC ID | Remark |
|-----|---------------|---------|------------|--------------|---------|--------------------|
| A | Adapter | DELTA | ADP-36PH B | NA | NA | Supplied by Client |
| B | iPod shuffle | Apple | MC749TA/A | CC4DN25WDFDM | NA | Provided by Lab |
| C | iPod shuffle | Apple | MD778TA/A | CC4JMA9KF4T1 | NA | Provided by Lab |
| D | Laptop | DELL | E6420 | 482T3R1 | FCC DoC | Provided by Lab |
| E | Telephone | WONDER | WD-303 | 7C17KA 05211 | NA | Provided by Lab |
| F | Micro SD Card | SanDisk | 2G | NA | NA | Provided by Lab |

Note:

All power cords of the above support units are non-shielded (1.8m).

| ID | Descriptions | Qty. | Length (m) | Shielding (Yes/No) | Cores (Qty.) | Remarks |
|----|---------------|------|------------|--------------------|--------------|--------------------|
| 1 | DC Cable | 1 | 0.9 | No | 1 | Supplied by client |
| 2 | AC Cable | 1 | 1.75 | No | 0 | Supplied by client |
| 3 | USB Cable | 1 | 0.1 | Yes | 0 | Provided by Lab |
| 4 | USB Cable | 1 | 0.1 | Yes | 0 | Provided by Lab |
| 5 | RJ-45 Cable | 1 | 10 | No | 0 | Provided by Lab |
| 6 | RJ-11 Cable | 1 | 10 | No | 0 | Provided by Lab |
| 7 | Console Cable | 1 | 1.5 | No | 1 | Supplied by client |

Note: The core(s) is(are) originally attached to the cable(s).

3.3.1 Configuration of System under Test

For conducted emission test

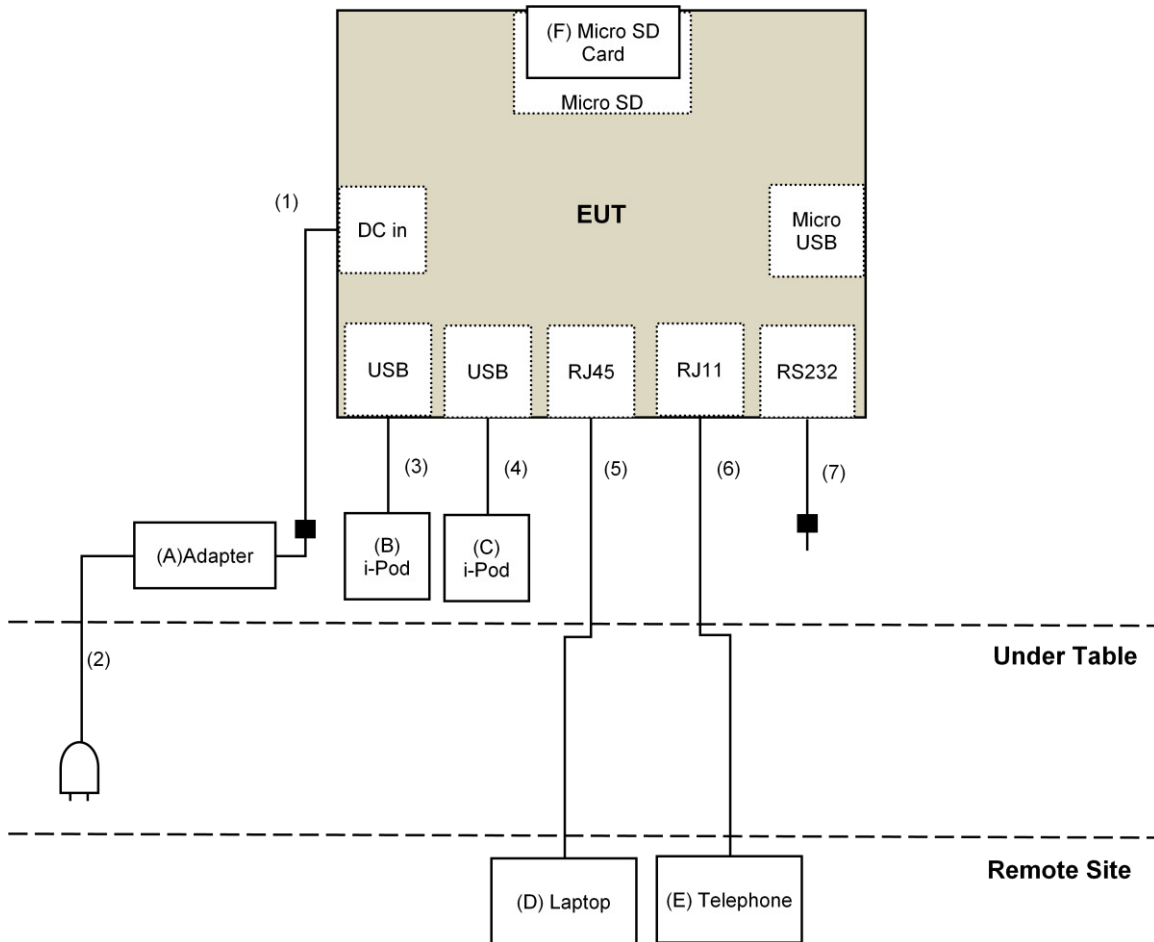

Note: Micro USB port for F/W update.

For radiated emission test

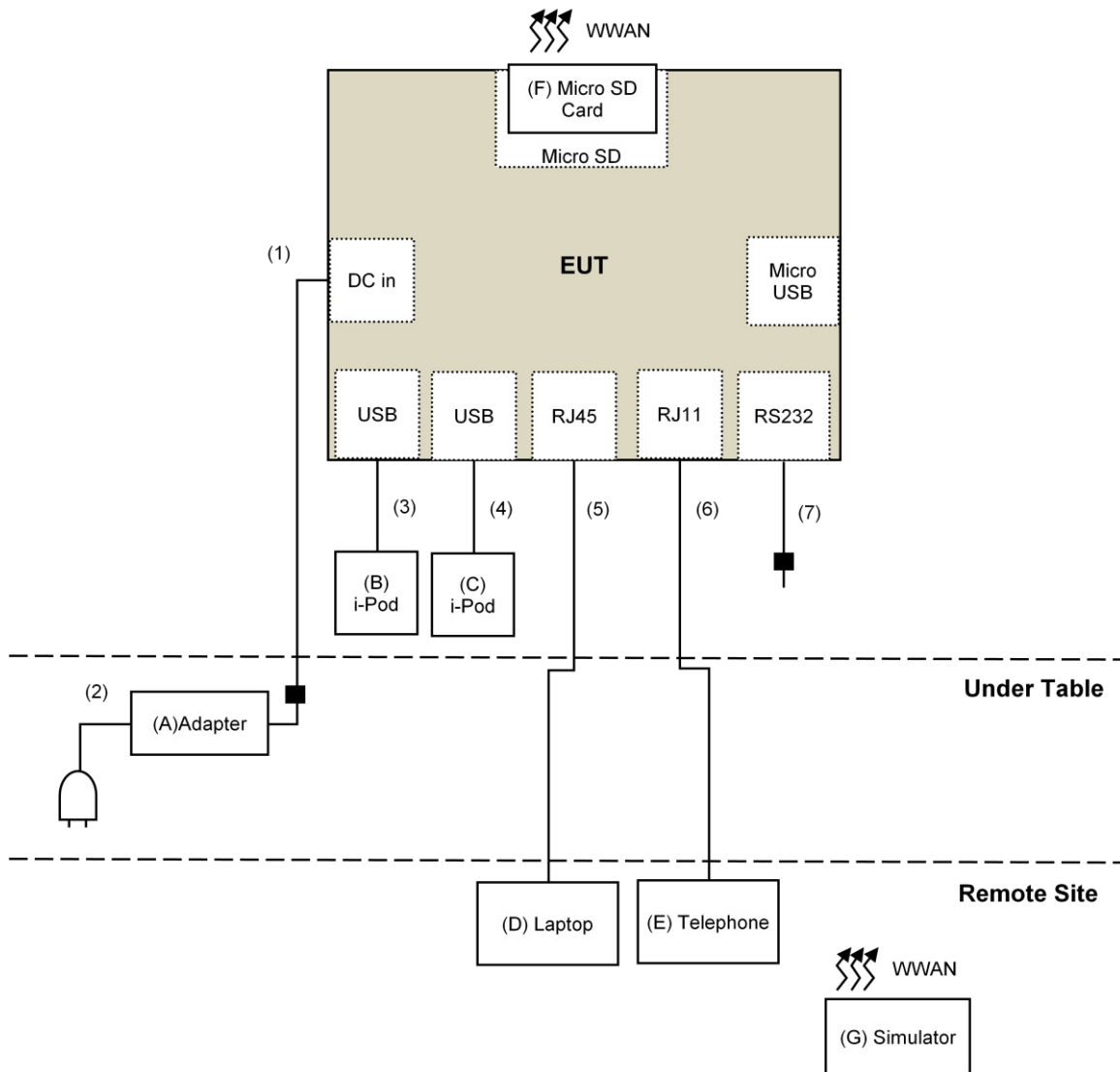

Note: Micro USB port for F/W update.

3.4 General Description of Applied Standards

The EUT is a RF Product. According to the specifications of the manufacturer, it must comply with the requirements of the following standards:

FCC Part 15, Subpart C (15.225)

FCC Part 15, Subpart C (15.215)

ANSI C63.10-2013

All test items have been performed and recorded as per the above standards.

4 Test Types and Results

4.1 Radiated Emission Measurement

4.1.1 Limits of Radiated Emission Measurement

(a) The field strength of any emissions within the band 13.553-13.567 MHz shall not exceed 15,848 microvolts/meter at 30 meters.

(b) Within the bands 13.410-13.553 MHz and 13.567-13.710 MHz, the field strength of any emissions shall not exceed 334 microvolts/meter at 30 meters.

(c) Within the bands 13.110-13.410 MHz and 13.710-14.010 MHz the field strength of any emissions shall not exceed 106 microvolts/meter at 30 meters.

(d) The field strength of any emissions appearing outside of the 13.110-14.010 MHz band shall not exceed the general radiated emission limits in §15.209 as below table:

| Frequencies (MHz) | Field Strength (microvolts/meter) | Measurement Distance (meters) |
|-------------------|-----------------------------------|-------------------------------|
| 0.009 ~ 0.490 | 2400/F(kHz) | 300 |
| 0.490 ~ 1.705 | 24000/F(kHz) | 30 |
| 1.705 ~ 30.0 | 30 | 30 |
| 30 ~ 88 | 100 | 3 |
| 88 ~ 216 | 150 | 3 |
| 216 ~ 960 | 200 | 3 |
| Above 960 | 500 | 3 |

NOTE:

1. The lower limit shall apply at the transition frequencies.
2. Emission level (dBuV/m) = 20 log Emission level (uV/m).
3. For frequencies above 1000MHz, the field strength limits are based on average detector, however, the peak field strength of any emission shall not exceed the maximum permitted average limits, specified above by more than 20dB under any condition of modulation.

4.1.2 Test Instruments

| DESCRIPTION & MANUFACTURER | MODEL NO. | SERIAL NO. | CALIBRATED DATE | CALIBRATED UNTIL |
|--|----------------------|-------------------------------|-----------------|------------------|
| Test Receiver Agilent | N9038A | MY50010156 | Aug. 18, 2016 | Aug. 17, 2017 |
| Pre-Amplifier ^(*) EMCI | EMC001340 | 980142 | Jan. 20, 2016 | Jan. 19, 2018 |
| Loop Antenna ^(*) Electro-Metrics | EM-6879 | 264 | Dec. 16, 2014 | Dec. 15, 2016 |
| RF Cable | NA | LOOPCAB-001 LOOPCAB-002 | Jan. 18, 2016 | Jan. 17, 2017 |
| Pre-Amplifier Mini-Circuits | ZFL-1000VH2B | AMP-ZFL-05 | May 07, 2016 | May 06, 2017 |
| Trilog Broadband Antenna SCHWARZBECK | VULB 9168 | 9168-156 | Jan. 04, 2016 | Jan. 03, 2017 |
| RF Cable | 8D | 966-3-1 966-3-2 966-3-3 | Apr. 02, 2016 | Apr. 01, 2017 |
| Fixed attenuator Mini-Circuits | UNAT-5+ | PAD-3m-3-01 | Oct. 05, 2016 | Oct. 04, 2017 |
| Software | ADT_Radiated_V8.7.08 | NA | NA | NA |
| Antenna Tower & Turn Table Max-Full | MF-7802 | MF780208406 | NA | NA |

Note:

1. The calibration interval of the above test instruments is 12 months and the calibrations are traceable to NML/ROC and NIST/USA.
2. *The calibration interval of the above test instruments is 24 months and the calibrations are traceable to NML/ROC and NIST/USA.
3. The test was performed in 966 Chamber No. 3.
4. The FCC Site Registration No. is 147459
5. Loop antenna was used for all emissions below 30 MHz.
6. The CANADA Site Registration No. is 20331-1
7. Tested Date: Nov. 16 to 23, 2016

4.1.3 Test Procedures

For Radiated emission below 30MHz

- a. The EUT was placed on the top of a rotating table 0.8 meters above the ground at a 3 meter chamber room. The table was rotated 360 degrees to determine the position of the highest radiation.
- b. The EUT was set 3 meters away from the interference-receiving antenna, which was mounted on the top of a variable-height antenna tower.
- c. Both X and Y axes of the antenna are set to make the measurement.
- d. For each suspected emission, the EUT was arranged to its worst case and the rotatable table was turned from 0 degrees to 360 degrees to find the maximum reading.
- e. The test-receiver system was set to Quasi-Peak Detect Function and Specified Bandwidth with Maximum Hold Mode.

NOTE:

1. The resolution bandwidth and video bandwidth of test receiver/spectrum analyzer is 9kHz at frequency below 30MHz.

For Radiated emission above 30MHz

- a. The EUT was placed on the top of a rotating table 0.8 meters (for 30MHz ~ 1GHz) / 1.5 meters (for above 1GHz) above the ground at 3 meter chamber room for test. The table was rotated 360 degrees to determine the position of the highest radiation.
- b. The EUT was set 3 meters away from the interference-receiving antenna, which was mounted on the top of a variable-height antenna tower.
- c. The height of antenna is varied from one meter to four meters above the ground to determine the maximum value of the field strength. Both horizontal and vertical polarizations of the antenna are set to make the measurement.
- d. For each suspected emission, the EUT was arranged to its worst case and then the antenna was tuned to heights from 1 meter to 4 meters and the rotatable table was turned from 0 degrees to 360 degrees to find the maximum reading.
- e. The test-receiver system was set to quasi-peak detect function and specified bandwidth with maximum hold mode when the test frequency is below 1 GHz.
- f. The test-receiver system was set to peak and average detect function and specified bandwidth with maximum hold mode when the test frequency is above 1 GHz. If the peak reading value also meets average limit, measurement with the average detector is unnecessary.

Note:

1. The resolution bandwidth and video bandwidth of test receiver/spectrum analyzer is 120kHz for Quasi-peak detection (QP) at frequency below 1GHz.
2. The resolution bandwidth of test receiver/spectrum analyzer is 1 MHz and the video bandwidth is 3 MHz for Peak detection (PK) at frequency above 1GHz.
3. The resolution bandwidth of test receiver/spectrum analyzer is 1MHz and the video bandwidth is $\geq 1/T$ (Duty cycle < 98%) or 10Hz (Duty cycle $\geq 98\%$) for Average detection (AV) at frequency above 1GHz.
4. All modes of operation were investigated and the worst-case emissions are reported.

4.1.4 Deviation from Test Standard

No deviation.

4.1.5 Test Setup

For Radiated emission below 30MHz

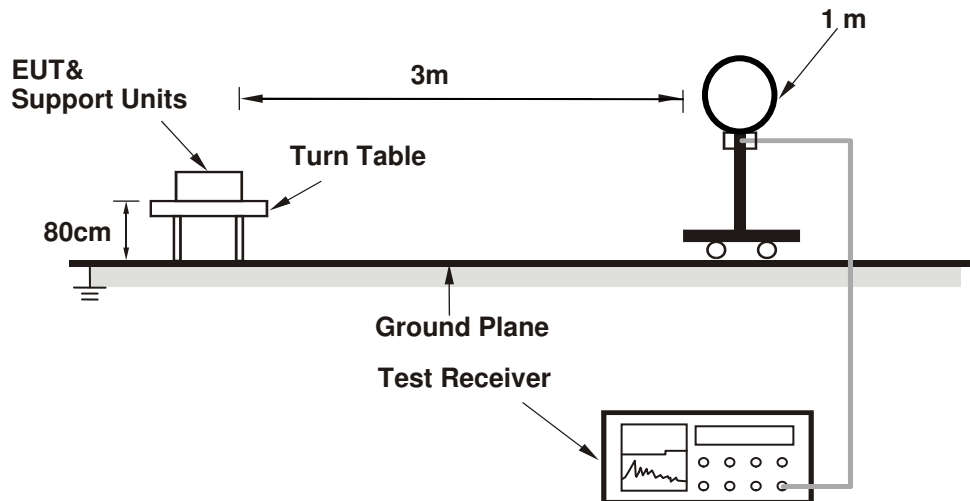

For Radiated emission 30MHz to 1GHz

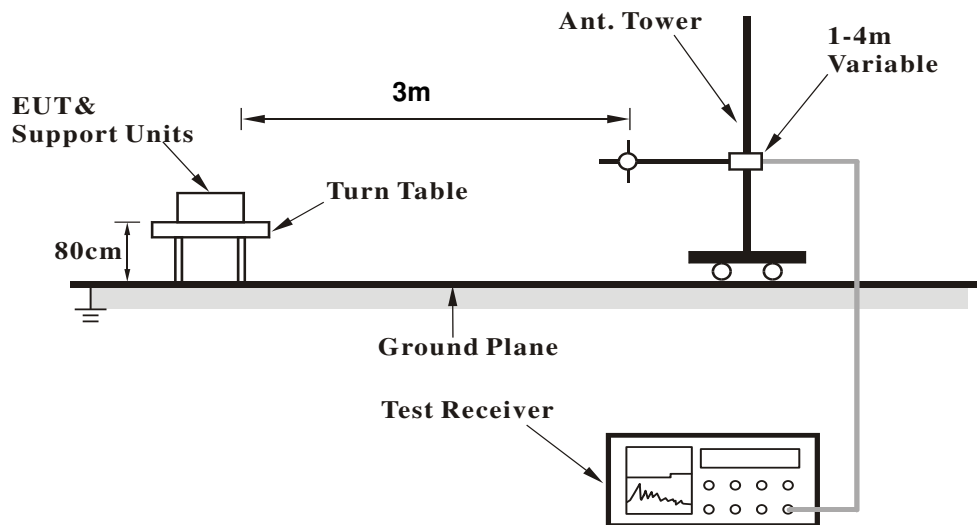

For the actual test configuration, please refer to the attached file (Test Setup Photo).

4.1.6 EUT Operating Conditions

- Placed the EUT on the testing table.
- Set the EUT under transmission condition continuously at specific channel frequency.

4.1.7 Test Results

| | | | |
|-----------------|--------------------|-------------------|------------|
| Frequency Range | 13.110 ~ 14.010MHz | Detector Function | Quasi-Peak |
|-----------------|--------------------|-------------------|------------|

| Antenna Polarity & Test Distance: Loop Antenna Open At 3m | | | | | | | | |
|---|-------------|-------------------------|----------------|-------------|--------------------|----------------------|------------------|--------------------------|
| No. | Freq. (MHz) | Emission Level (dBuV/m) | Limit (dBuV/m) | Margin (dB) | Antenna Height (m) | Table Angle (Degree) | Raw Value (dBuV) | Correction Factor (dB/m) |
| 1 | 13.35 | 55.5 QP | 80.5 | -25.0 | 1.00 | 310 | 58.8 | -3.3 |
| 2 | 13.49 | 60.0 QP | 90.5 | -30.5 | 1.00 | 345 | 63.3 | -3.3 |
| 3 | *13.56 | 81.9 QP | 124.0 | -42.1 | 1.00 | 343 | 85.2 | -3.3 |
| 4 | 13.63 | 60.3 QP | 90.5 | -30.2 | 1.00 | 346 | 63.6 | -3.3 |
| 5 | 13.77 | 58.1 QP | 80.5 | -22.4 | 1.00 | 346 | 61.4 | -3.3 |

- REMARKS:**
1. Emission level(dBuV/m)=Raw Value(dBuV) + Correction Factor(dB/m)
 2. Correction Factor(dB/m) = Antenna Factor (dB/m) + Cable Factor (dB) – Pre-Amplifier Factor(dB)
 3. The other emission levels were very low against the limit.
 4. Margin value = Emission level – Limit value.
 5. Above limits have been translated by the formula
 6. " * ": Fundamental frequency.

The measured field strength was extrapolated to distance 30 meters, using the formula that the limit of field strength varies as the inverse distance square (40dB per decade of distance)

Example:

$$\begin{aligned}
 13.56\text{MHz} &= 15848\mu\text{V/m} && 30\text{m} \\
 &= 84\text{dBuV/m} && 30\text{m} \\
 &= 84+20\log(30/3)^2 && 3\text{m} \\
 &= 124\text{dBuV/m}
 \end{aligned}$$

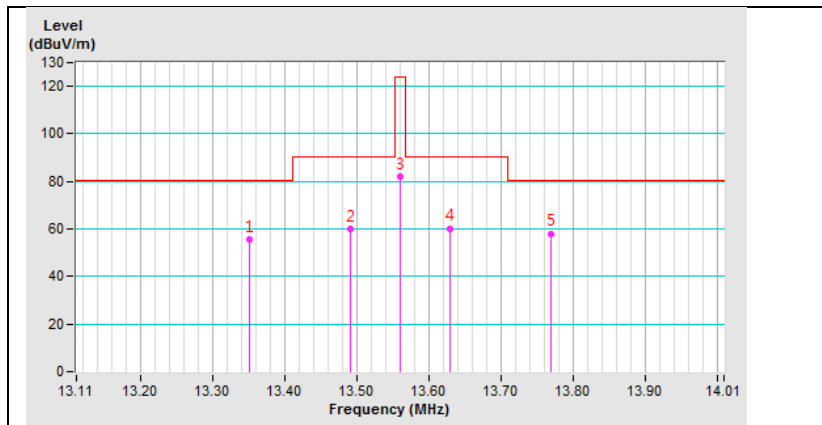

| | | | |
|-----------------|--------------------|-------------------|------------|
| Frequency Range | 13.110 ~ 14.010MHz | Detector Function | Quasi-Peak |
|-----------------|--------------------|-------------------|------------|

| Antenna Polarity & Test Distance: Loop Antenna Close At 3m | | | | | | | | |
|--|-------------|-------------------------|----------------|-------------|--------------------|----------------------|------------------|--------------------------|
| No. | Freq. (MHz) | Emission Level (dBuV/m) | Limit (dBuV/m) | Margin (dB) | Antenna Height (m) | Table Angle (Degree) | Raw Value (dBuV) | Correction Factor (dB/m) |
| 1 | 13.35 | 52.9 QP | 80.5 | -27.6 | 1.00 | 217 | 56.2 | -3.3 |
| 2 | 13.49 | 56.9 QP | 90.5 | -33.6 | 1.00 | 195 | 60.2 | -3.3 |
| 3 | *13.56 | 79.1 QP | 124.0 | -44.9 | 1.00 | 240 | 82.4 | -3.3 |
| 4 | 13.63 | 57.2 QP | 90.5 | -33.3 | 1.00 | 192 | 60.5 | -3.3 |
| 5 | 13.77 | 55.4 QP | 80.5 | -25.1 | 1.00 | 169 | 58.7 | -3.3 |

- REMARKS:**
1. Emission level(dBuV/m)=Raw Value(dBuV) + Correction Factor(dB/m)
 2. Correction Factor(dB/m) = Antenna Factor (dB/m) + Cable Factor (dB) – Pre-Amplifier Factor(dB)
 3. The other emission levels were very low against the limit.
 4. Margin value = Emission level – Limit value.
 5. Above limits have been translated by the formula
 6. " * ": Fundamental frequency.

The measured field strength was extrapolated to distance 30 meters, using the formula that the limit of field strength varies as the inverse distance square (40dB per decade of distance)

Example:

$$\begin{aligned}
 13.56\text{MHz} &= 15848\mu\text{V/m} && 30\text{m} \\
 &= 84\text{dBuV/m} && 30\text{m} \\
 &= 84+20\log(30/3)^2 && 3\text{m} \\
 &= 124\text{dBuV/m}
 \end{aligned}$$

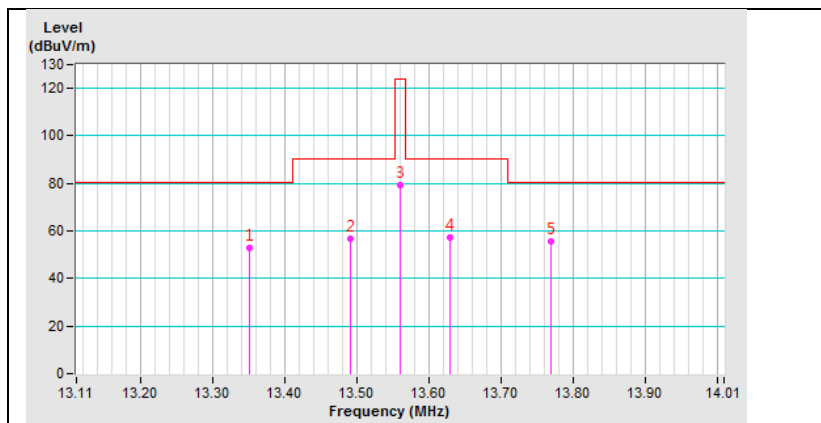

| | | | |
|-----------------|-------------|-------------------|------------|
| Frequency Range | Below 30MHz | Detector Function | Quasi-Peak |
|-----------------|-------------|-------------------|------------|

| Antenna Polarity & Test Distance: Loop Antenna Open At 3m | | | | | | | | |
|---|-------------|-------------------------|----------------|-------------|--------------------|----------------------|------------------|--------------------------|
| NO. | FREQ. (MHz) | EMISSION LEVEL (dBuV/m) | LIMIT (dBuV/m) | MARGIN (dB) | ANTENNA HEIGHT (m) | TABLE ANGLE (Degree) | RAW VALUE (dBuV) | CORRECTION FACTOR (dB/m) |
| 1 | 1.01 | 39.7 QP | 67.5 | -27.8 | 1.00 | 190 | 38.9 | 0.8 |
| 2 | 3.07 | 29.3 QP | 69.5 | -40.2 | 1.00 | 102 | 32.1 | -2.8 |
| 3 | 17.24 | 34.3 QP | 69.5 | -35.2 | 1.00 | 132 | 38.2 | -3.9 |
| 4 | 20.66 | 44.4 QP | 69.5 | -25.1 | 1.00 | 224 | 48.8 | -4.4 |
| 5 | 21.13 | 48.3 QP | 69.5 | -21.2 | 1.00 | 360 | 52.6 | -4.3 |
| 6 | 28.24 | 38.2 QP | 69.5 | -31.3 | 1.00 | 340 | 40.9 | -2.7 |

| Antenna Polarity & Test Distance: Loop Antenna Close At 3m | | | | | | | | |
|--|--------------|-------------------------|----------------|--------------|--------------------|----------------------|------------------|--------------------------|
| NO. | FREQ. (MHz) | EMISSION LEVEL (dBuV/m) | LIMIT (dBuV/m) | MARGIN (dB) | ANTENNA HEIGHT (m) | TABLE ANGLE (Degree) | RAW VALUE (dBuV) | CORRECTION FACTOR (dB/m) |
| 1 | 0.50 | 50.3 QP | 73.6 | -23.3 | 1.00 | 239 | 45.7 | 4.6 |
| 2 | 3.13 | 36.7 QP | 69.5 | -32.8 | 1.00 | 258 | 39.5 | -2.8 |
| 3 | 6.92 | 38.0 QP | 69.5 | -31.5 | 1.00 | 42 | 40.9 | -2.9 |
| 4 | 20.66 | 51.2 QP | 69.5 | -18.3 | 1.00 | 20 | 55.6 | -4.4 |
| 5 | 21.13 | 55.6 QP | 69.5 | -13.9 | 1.00 | 328 | 59.9 | -4.3 |
| 6 | 28.24 | 44.2 QP | 69.5 | -25.3 | 1.00 | 245 | 46.9 | -2.7 |

REMARKS:

1. Emission Level(dBuV/m) = Raw Value(dBuV) + Correction Factor(dB/m)
2. Correction Factor(dB/m) = Antenna Factor(dB/m) + Cable Factor(dB)
– Pre-Amplifier Factor (dB)
3. The other emission levels were very low against the limit.
4. Margin value = Emission Level – Limit value

| | | | |
|-----------------|-----------------|-------------------|------------|
| Frequency Range | 30MHz ~ 1000MHz | Detector Function | Quasi-Peak |
|-----------------|-----------------|-------------------|------------|

| Antenna Polarity & Test Distance: Horizontal At 3 M | | | | | | | | |
|---|-------------|-------------------------|----------------|-------------|--------------------|----------------------|------------------|--------------------------|
| NO. | FREQ. (MHz) | EMISSION LEVEL (dBuV/m) | LIMIT (dBuV/m) | MARGIN (dB) | ANTENNA HEIGHT (m) | TABLE ANGLE (Degree) | RAW VALUE (dBuV) | CORRECTION FACTOR (dB/m) |
| 1 | 108.04 | 37.6 QP | 43.5 | -5.9 | 2.00 H | 300 | 49.3 | -11.7 |
| 2 | 156.00 | 39.9 QP | 43.5 | -3.6 | 2.00 H | 84 | 48.2 | -8.3 |
| 3 | 252.01 | 44.7 QP | 46.0 | -1.3 | 1.00 H | 312 | 54.1 | -9.4 |
| 4 | 266.68 | 45.3 QP | 46.0 | -0.7 | 1.00 H | 302 | 53.9 | -8.6 |
| 5 | 373.33 | 41.8 QP | 46.0 | -4.2 | 1.00 H | 61 | 47.3 | -5.5 |
| 6 | 533.36 | 38.9 QP | 46.0 | -7.1 | 1.50 H | 41 | 40.8 | -1.9 |

| Antenna Polarity & Test Distance: Vertical At 3 M | | | | | | | | |
|---|---------------|-------------------------|----------------|-------------|--------------------|----------------------|------------------|--------------------------|
| NO. | FREQ. (MHz) | EMISSION LEVEL (dBuV/m) | LIMIT (dBuV/m) | MARGIN (dB) | ANTENNA HEIGHT (m) | TABLE ANGLE (Degree) | RAW VALUE (dBuV) | CORRECTION FACTOR (dB/m) |
| 1 | 60.00 | 39.0 QP | 40.0 | -1.0 | 1.00 V | 132 | 47.7 | -8.7 |
| 2 | 180.01 | 38.6 QP | 43.5 | -4.9 | 1.00 V | 201 | 48.1 | -9.5 |
| 3 | 252.00 | 44.8 QP | 46.0 | -1.2 | 1.50 V | 354 | 54.2 | -9.4 |
| 4 | 346.68 | 41.6 QP | 46.0 | -4.4 | 1.50 V | 115 | 48.0 | -6.4 |
| 5 | 426.68 | 45.8 QP | 46.0 | -0.2 | 1.50 V | 73 | 49.8 | -4.0 |
| 6 | 533.33 | 40.3 QP | 46.0 | -5.7 | 1.00 V | 180 | 42.2 | -1.9 |

REMARKS:

1. Emission Level(dBuV/m) = Raw Value(dBuV) + Correction Factor(dB/m)
2. Correction Factor(dB/m) = Antenna Factor(dB/m) + Cable Factor(dB) – Pre-Amplifier Factor(dB)
3. The other emission levels were very low against the limit.
4. Margin value = Emission Level – Limit value

4.2 Conducted Emission Measurement

4.2.1 Limits of Conducted Emission Measurement

| Frequency (MHz) | Conducted Limit (dBuV) | |
|-----------------|------------------------|---------|
| | Quasi-peak | Average |
| 0.15 - 0.5 | 66 - 56 | 56 - 46 |
| 0.50 - 5.0 | 56 | 46 |
| 5.0 - 30.0 | 60 | 50 |

Note: 1. The lower limit shall apply at the transition frequencies.

2. The limit decreases in line with the logarithm of the frequency in the range of 0.15 to 0.50MHz.

4.2.2 Test Instruments

| DESCRIPTION & MANUFACTURER | MODEL NO. | SERIAL NO. | CALIBRATED DATE | CALIBRATED UNTIL |
|--|-------------------------|------------|-----------------|------------------|
| Test Receiver R&S | ESCS 30 | 847124/029 | Oct. 24, 2016 | Oct. 23, 2017 |
| Line-Impedance Stabilization Network (for EUT) R&S | ESH3-Z5 | 848773/004 | Oct. 26, 2016 | Oct. 25, 2017 |
| Line-Impedance Stabilization Network (for Peripheral) R&S | ENV216 | 100072 | June 13, 2016 | June 12, 2017 |
| RF Cable | 5D-FB | COCCAB-001 | Sep. 30, 2016 | Sep. 29, 2017 |
| 10 dB PAD Mini-Circuits | HAT-10+ | CONATT-004 | June 20, 2016 | June 19, 2017 |
| Software BVADT | BVADT_Cond_ V7.3.7.4 | NA | NA | NA |

Note:

1. The calibration interval of the above test instruments are 12 months and the calibrations are traceable to NML/ROC and NIST/USA.
2. The test was performed in Shielded Room No. 1.
- 3 Tested Date:Nov. 24, 2016

4.2.3 Test Procedures

- The EUT was placed 0.4 meters from the conducting wall of the shielded room with EUT being connected to the power mains through a line impedance stabilization network (LISN). Other support units were connected to the power mains through another LISN. The two LISNs provide 50 ohm/ 50uH of coupling impedance for the measuring instrument.
- Both lines of the power mains connected to the EUT were checked for maximum conducted interference.
- The frequency range from 150kHz to 30MHz was searched. Emission levels under (Limit - 20dB) was not recorded.

NOTE: The resolution bandwidth and video bandwidth of test receiver is 9kHz for quasi-peak detection (QP) and average detection (AV) at frequency 0.15MHz-30MHz.

4.2.4 Deviation from Test Standard

No deviation.

4.2.5 TEST SETUP

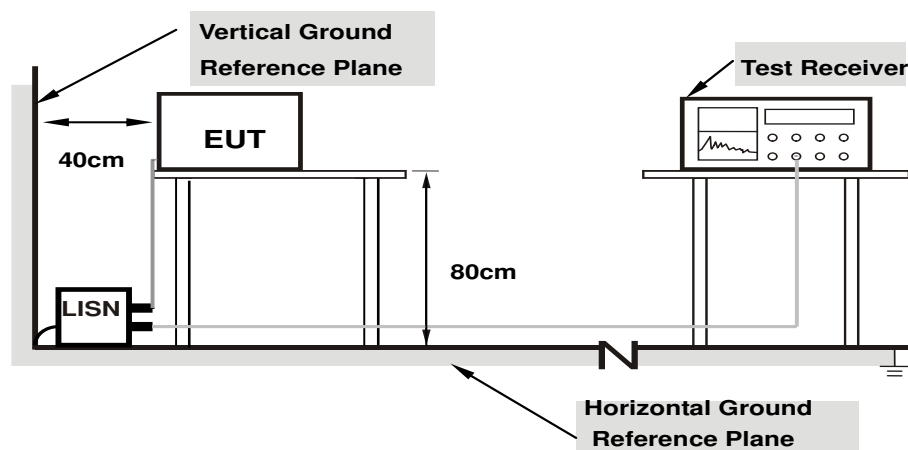

Note: 1.Support units were connected to second LISN.

For the actual test configuration, please refer to the attached file (Test Setup Photo).

4.2.6 EUT Operating Conditions

Same as 4.1.6.

4.2.7 Test Results

| Phase | Line (L) | Detector Function | Quasi-Peak (QP) / Average (AV) |
|-------|----------|-------------------|--------------------------------|
|-------|----------|-------------------|--------------------------------|

| No | Freq. [MHz] | Corr. | Reading Value | | Emission Level | | Limit | | Margin | |
|----|----------------|----------------|---------------|-------|----------------|-------|-----------|-------|--------|--------|
| | | Factor (dB) | [dB (uV)] | | [dB (uV)] | | [dB (uV)] | | (dB) | |
| | | Q.P. | AV. | Q.P. | AV. | Q.P. | AV. | Q.P. | AV. | |
| 1 | 0.15000 | 10.19 | 38.69 | 22.01 | 48.88 | 32.20 | 66.00 | 56.00 | -17.12 | -23.80 |
| 2 | 0.19297 | 10.19 | 32.87 | 16.81 | 43.06 | 27.00 | 63.91 | 53.91 | -20.85 | -26.91 |
| 3 | 0.32578 | 10.21 | 17.76 | 7.37 | 27.97 | 17.58 | 59.56 | 49.56 | -31.59 | -31.98 |
| 4 | 0.38828 | 10.22 | 15.21 | 8.22 | 25.43 | 18.44 | 58.10 | 48.10 | -32.67 | -29.66 |
| 5 | 0.94688 | 10.26 | 0.55 | -5.54 | 10.81 | 4.72 | 56.00 | 46.00 | -45.19 | -41.28 |
| 6 | 28.00391 | 11.45 | 11.62 | 9.01 | 23.07 | 20.46 | 60.00 | 50.00 | -36.93 | -29.54 |

REMARKS:

1. Q.P. and AV. are abbreviations of quasi-peak and average individually.
2. The emission levels of other frequencies were very low against the limit.
3. Margin value = Emission level - Limit value
4. Correction factor = Insertion loss + Cable loss
5. Emission Level = Correction Factor + Reading Value.

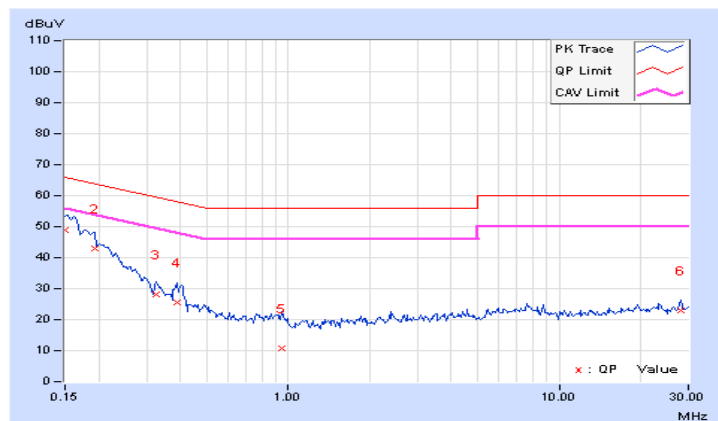

| | | | |
|-------|-------------|-------------------|--------------------------------|
| Phase | Neutral (N) | Detector Function | Quasi-Peak (QP) / Average (AV) |
|-------|-------------|-------------------|--------------------------------|

| No | Freq. [MHz] | Corr. | Reading Value | | Emission Level | | Limit | | Margin | |
|----|----------------|----------------|---------------|-------|----------------|-------|-----------|-------|--------|--------|
| | | Factor (dB) | [dB (uV)] | | [dB (uV)] | | [dB (uV)] | | (dB) | |
| | Q.P. | AV. | Q.P. | AV. | Q.P. | AV. | Q.P. | AV. | Q.P. | AV. |
| 1 | 0.15781 | 10.18 | 38.90 | 23.51 | 49.08 | 33.69 | 65.58 | 55.58 | -16.50 | -21.89 |
| 2 | 0.18125 | 10.17 | 35.03 | 19.39 | 45.20 | 29.56 | 64.43 | 54.43 | -19.23 | -24.87 |
| 3 | 0.20859 | 10.16 | 29.41 | 14.49 | 39.57 | 24.65 | 63.26 | 53.26 | -23.69 | -28.61 |
| 4 | 0.38438 | 10.21 | 19.96 | 11.26 | 30.17 | 21.47 | 58.18 | 48.18 | -28.01 | -26.71 |
| 5 | 5.55078 | 10.25 | 10.16 | 6.19 | 20.41 | 16.44 | 60.00 | 50.00 | -39.59 | -33.56 |
| 6 | 28.00000 | 11.06 | 14.47 | 10.90 | 25.53 | 21.96 | 60.00 | 50.00 | -34.47 | -28.04 |

REMARKS:

1. Q.P. and AV. are abbreviations of quasi-peak and average individually.
2. The emission levels of other frequencies were very low against the limit.
3. Margin value = Emission level - Limit value
4. Correction factor = Insertion loss + Cable loss
5. Emission Level = Correction Factor + Reading Value.

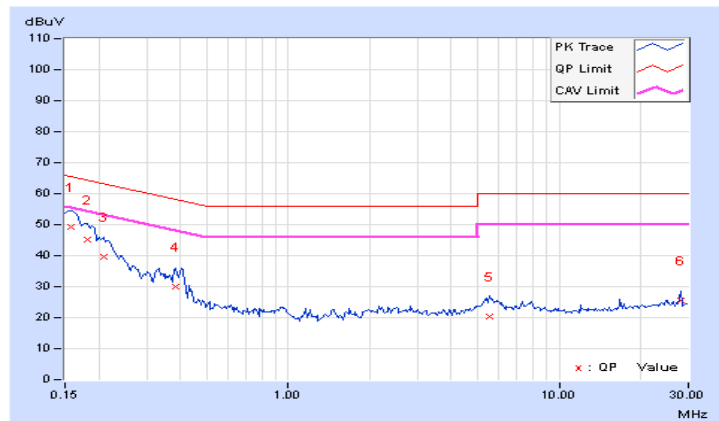

4.3 Frequency Stability

4.3.1 Limits of Frequency Stability Measurement

The frequency tolerance of the carrier signal shall be maintained within +/- 0.01% of the operating frequency over a temperature variation of -20 degrees to 50 degrees C at normal supply voltage, and for a variation in the primary supply voltage from 85% to 115% of the rated supply voltage at a temperature of 20 degrees C.

4.3.2 Test Setup

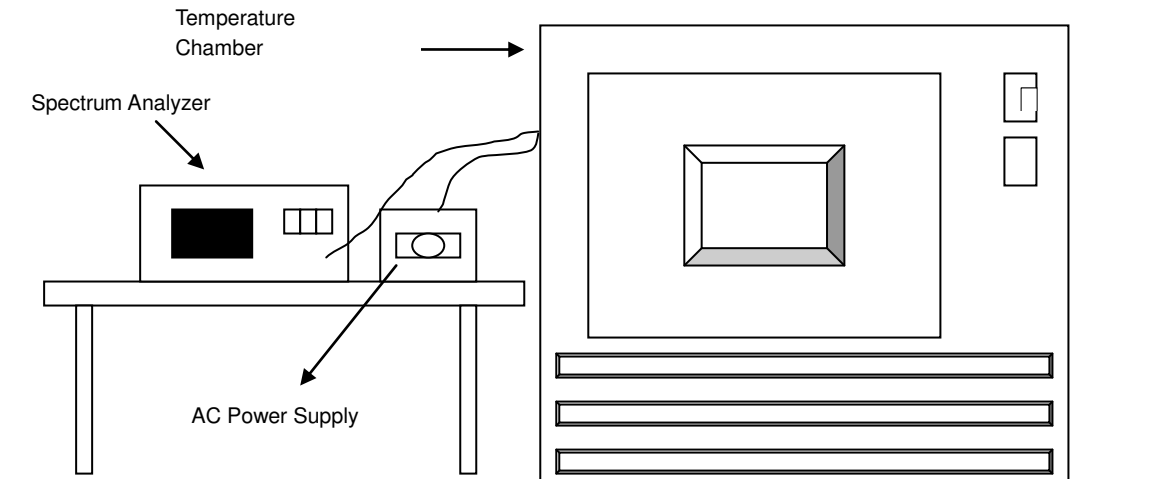

4.3.3 Test Instruments

| DESCRIPTION & MANUFACTURER | MODEL NO. | SERIAL NO. | CALIBRATED DATE | CALIBRATED UNTIL |
|--|----------------------|-------------|-----------------|------------------|
| Spectrum Analyzer R&S | FSV40 | 100964 | June 28, 2016 | June 27, 2017 |
| AC Power Source Extech Electronics | 6205 | 1440452 | NA | NA |
| Temperature & Humidity Chamber Giant Force | GTH-150-40-SP -AR | MAA0812-008 | Jan. 15, 2016 | Jan. 14, 2017 |
| Digital Multimeter FLUKE | 87III | 73680266 | Nov. 10, 2016 | Nov. 09, 2017 |

Note:

1. The calibration interval of the above test instruments is 12 months and the calibrations are traceable to NML/ROC and NIST/USA.
2. Tested date : Nov. 16, 2016

4.3.4 Test Procedure

- a. The EUT was placed inside the environmental test chamber and powered by nominal AC voltage.
- b. Turned the EUT on and coupled its output to a spectrum analyzer.
- c. Turned the EUT off and set the chamber to the highest temperature specified.
- d. Allowed sufficient time (approximately 30 min) for the temperature of the chamber to stabilize then turned the EUT on and measured the operating frequency after 2, 5, and 10 minutes.
- e. Repeated step 2 and 3 with the temperature chamber set to the lowest temperature.
- f. The test chamber was allowed to stabilize at +20 degree C for a minimum of 30 minutes. The supply voltage was then adjusted on the EUT from 85% to 115% and the frequency record.

4.3.5 Deviation from Test Standard

No deviation.

4.3.6 EUT Operating Conditions

Same as Item 4.1.6.

4.3.7 Test Result

| Frequency Stability Versus Temp. | | | | | | | | | |
|----------------------------------|--------------------------|-----------------------|--------------------|-----------------------|--------------------|-----------------------|--------------------|-----------------------|--------------------|
| TEMP. (°C) | Power Supply (Vac) | 0 Minute | | 2 Minute | | 5 Minute | | 10 Minute | |
| | | Measured Frequency | Frequency Drift | Measured Frequency | Frequency Drift | Measured Frequency | Frequency Drift | Measured Frequency | Frequency Drift |
| | | (MHz) | % | (MHz) | % | (MHz) | % | (MHz) | % |
| 50 | 120 | 13.56004 | 0.00029 | 13.56005 | 0.00037 | 13.56005 | 0.00037 | 13.56006 | 0.00044 |
| 40 | 120 | 13.55998 | -0.00015 | 13.55997 | -0.00022 | 13.55997 | -0.00022 | 13.55997 | -0.00022 |
| 30 | 120 | 13.56001 | 0.00007 | 13.56002 | 0.00015 | 13.56001 | 0.00007 | 13.56001 | 0.00007 |
| 20 | 120 | 13.55996 | -0.00029 | 13.55997 | -0.00022 | 13.55997 | -0.00022 | 13.55997 | -0.00022 |
| 10 | 120 | 13.55999 | -0.00007 | 13.55999 | -0.00007 | 13.56 | 0.00000 | 13.55999 | -0.00007 |
| 0 | 120 | 13.55992 | -0.00059 | 13.55993 | -0.00052 | 13.55993 | -0.00052 | 13.55993 | -0.00052 |
| -10 | 120 | 13.56007 | 0.00052 | 13.56007 | 0.00052 | 13.56007 | 0.00052 | 13.56007 | 0.00052 |
| -20 | 120 | 13.56005 | 0.00037 | 13.56005 | 0.00037 | 13.56004 | 0.00029 | 13.56004 | 0.00029 |
| -30 | 120 | 13.56003 | 0.00022 | 13.56003 | 0.00022 | 13.56003 | 0.00022 | 13.56003 | 0.00022 |

| Frequency Stability Versus Voltage | | | | | | | | | |
|------------------------------------|--------------------------|-----------------------|--------------------|-----------------------|--------------------|-----------------------|--------------------|-----------------------|--------------------|
| TEMP. (°C) | Power Supply (Vac) | 0 Minute | | 2 Minute | | 5 Minute | | 10 Minute | |
| | | Measured Frequency | Frequency Drift | Measured Frequency | Frequency Drift | Measured Frequency | Frequency Drift | Measured Frequency | Frequency Drift |
| | | (MHz) | % | (MHz) | % | (MHz) | % | (MHz) | % |
| 20 | 138 | 13.55996 | -0.00029 | 13.55997 | -0.00022 | 13.55997 | -0.00022 | 13.55997 | -0.00022 |
| | 120 | 13.55996 | -0.00029 | 13.55997 | -0.00022 | 13.55997 | -0.00022 | 13.55997 | -0.00022 |
| | 102 | 13.55996 | -0.00029 | 13.55997 | -0.00022 | 13.55997 | -0.00022 | 13.55997 | -0.00022 |

4.4 20dB bandwidth

4.4.1 Limits Of 20dB BANDWIDTH Measurement

The 20dB bandwidth shall be specified in operating frequency band.

4.4.2 Test Setup

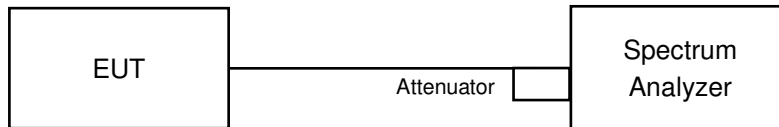

4.4.3 Test Instruments

| DESCRIPTION & MANUFACTURER | MODEL NO. | SERIAL NO. | CALIBRATED DATE | CALIBRATED UNTIL |
|----------------------------|-----------|------------|-----------------|------------------|
| R&S SPECTRUM ANALYZER | FSP40 | 100060 | May 09, 2012 | May 10, 2013 |

Note:

1. The calibration interval of the above test instruments is 12 months and the calibrations are traceable to NML/ROC and NIST/USA.
2. Tested date : Jan. 08, 2013

4.4.4 Test Procedures

The bandwidth of the fundamental frequency was measured by spectrum analyzer with 1kHz RBW and 3kHz VBW. The 20dB bandwidth is defined as the total spectrum the power of which is higher than peak power minus 20dB.

4.4.5 Deviation from Test Standard

No deviation.

4.4.6 EUT Operating Conditions

Same as Item 4.1.6.

4.4.7 Test Results

| 20dBc point (Low) | 20dBc point (High) | Operating frequency band (MHz) | Pass/Fail |
|-------------------|--------------------|--------------------------------|-----------|
| 13.48 MHz | 13.71 MHz | 13.11 – 14.01 | PASS |

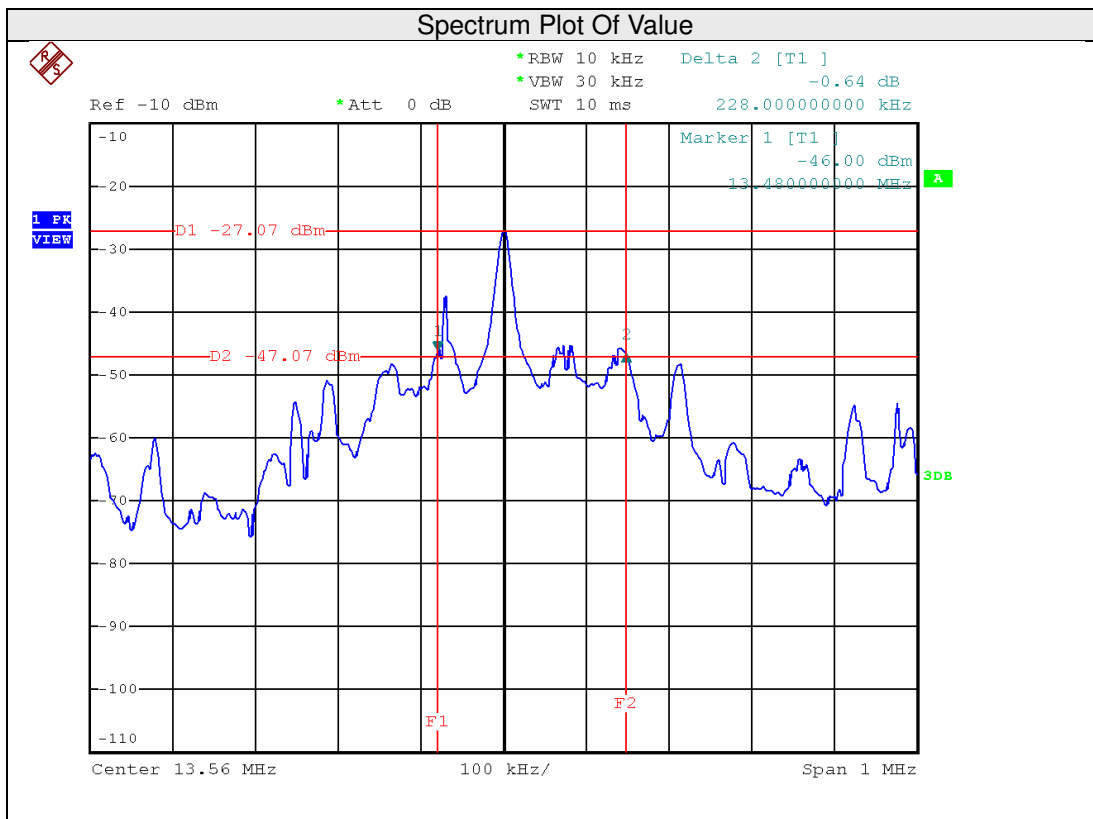

5 Pictures of Test Arrangements

Please refer to the attached file (Test Setup Photo).

Appendix – Information on the Testing Laboratories

We, Bureau Veritas Consumer Products Services (H.K.) Ltd., Taoyuan Branch, were founded in 1988 to provide our best service in EMC, Radio, Telecom and Safety consultation. Our laboratories are accredited and approved according to ISO/IEC 17025.

If you have any comments, please feel free to contact us at the following:

Linko EMC/RF Lab

Tel: 886-2-26052180

Fax: 886-2-26051924

Hsin Chu EMC/RF/Telecom Lab

Tel: 886-3-6668565

Fax: 886-3-6668323

Hwa Ya EMC/RF/Safety Lab

Tel: 886-3-3183232

Fax: 886-3-3270892

Email: service.adt@tw.bureauveritas.com

Web Site: www.bureauveritas-adt.com

The address and road map of all our labs can be found in our web site also.

--- END ---