



A D T

FCC TEST REPORT (Part 22)

REPORT NO.: RF121207E06-1

MODEL NO.: FD-400GT(MC8090)

FCC ID: MQT-FD400GTMC

RECEIVED: Dec. 07, 2012

TESTED: Jan. 08, 2013

ISSUED: Jan. 11, 2013

APPLICANT: XAC AUTOMATION CORP.

ADDRESS: 4F, No. 30, INDUSTRY E. RD. IX, SCIENCE-BASED
INDUSTRIAL PARK,HSINCHU,TAIWAN

ISSUED BY: Bureau Veritas Consumer Products Services (H.K.) Ltd.,
Taoyuan Branch Hsin Chu Laboratory

LAB ADDRESS: No. 81-1, Lu Liao Keng, 9th Ling,Wu Lung Tsuen, Chiung
Lin Hsiang, Hsin Chu Hsien 307, Taiwan, R.O.C.

TEST LOCATION (1): No. 81-1, Lu Liao Keng, 9th Ling,Wu Lung Tsuen, Chiung
Lin Hsiang, Hsin Chu Hsien 307, Taiwan, Taiwan, R.O.C.

TEST LOCATION (2): No.49, Ln. 206, Wende Rd., Shangshan Tsuen, Chiung
Lin Hsiang, Hsin Chu Hsien 307, Taiwan, Taiwan, R.O.C.

This report should not be used by the client to claim product certification, approval, or endorsement by TAF or any government agencies.



This report is for your exclusive use. Any copying or replication of this report to or for any other person or entity, or use of our name or trademark, is permitted only with our prior written permission. This report sets forth our findings solely with respect to the test samples identified herein. The results set forth in this report are not indicative or representative of the quality or characteristics of the lot from which a test sample was taken or any similar or identical product unless specifically and expressly noted. Our report includes all of the tests requested by you and the results thereof based upon the information that you provided to us. You have 60 days from date of issuance of this report to notify us of any material error or omission caused by our negligence, provided, however, that such notice shall be in writing and shall specifically address the issue you wish to raise. A failure to raise such issue within the prescribed time shall constitute your unqualified acceptance of the completeness of this report, the tests conducted and the correctness of the report contents. Unless specific mention, the uncertainty of measurement has been explicitly taken into account to declare the compliance or non-compliance to the specification



TABLE OF CONTENTS

RELEASE CONTROL RECORD	4
1 CERTIFICATION	5
2 SUMMARY OF TEST RESULTS	6
2.1 MEASUREMENT UNCERTAINTY	7
3 GENERAL INFORMATION	8
3.1 GENERAL DESCRIPTION OF EUT	8
3.2 DESCRIPTION OF TEST MODES	10
3.2.1 TEST MODE APPLICABILITY AND TESTED CHANNEL DETAIL	12
3.3 GENERAL DESCRIPTION OF APPLIED STANDARDS	18
3.4 DESCRIPTION OF SUPPORT UNITS.....	19
3.5 CONFIGURATION OF SYSTEM UNDER TEST	20
4 TEST TYPES AND RESULTS	21
4.1 OUTPUT POWER MEASUREMENT	21
4.1.1 LIMITS OF OUTPUT POWER MEASUREMENT	21
4.1.2 TEST INSTRUMENTS.....	22
4.1.3 TEST PROCEDURES	24
4.1.4 TEST SETUP	25
4.1.5 EUT OPERATING CONDITIONS	26
4.1.6 TEST RESULTS	27
4.2 FREQUENCY STABILITY MEASUREMENT	31
4.2.1 LIMITS OF FREQUENCY STABILITY MEASUREMENT	31
4.2.2 TEST INSTRUMENTS.....	31
4.2.3 TEST PROCEDURE.....	32
4.2.4 TEST SETUP	32
4.2.5 TEST RESULTS	33
4.3 OCCUPIED BANDWIDTH MEASUREMENT	35
4.3.1 LIMITS OF OCCUPIED BANDWIDTH MEASUREMENT	35
4.3.2 TEST INSTRUMENTS.....	35
4.3.3 TEST SETUP	35
4.3.4 TEST PROCEDURES	35
4.3.5 EUT OPERATING CONDITION.....	35
4.3.6 TEST RESULTS	36
4.4 BAND EDGE MEASUREMENT	38
4.4.1 LIMITS OF BAND EDGE MEASUREMENT	38
4.4.2 TEST INSTRUMENTS.....	38
4.4.3 TEST SETUP	38
4.4.4 TEST PROCEDURES	39
4.4.5 EUT OPERATING CONDITION.....	39
4.4.6 TEST RESULTS	40
4.5 CONDUCTED SPURIOUS EMISSIONS.....	42
4.5.1 LIMITS OF CONDUCTED SPURIOUS EMISSIONS MEASUREMENT	42
4.5.2 TEST INSTRUMENTS.....	42
4.5.3 TEST PROCEDURE.....	43



4.5.4	TEST SETUP	43
4.5.5	EUT OPERATING CONDITIONS	43
4.5.6	TEST RESULTS	44
4.6	RADIATED EMISSION MEASUREMENT	50
4.6.1	LIMITS OF RADIATED EMISSION MEASUREMENT.....	50
4.6.2	TEST INSTRUMENTS.....	51
4.6.3	TEST PROCEDURES	52
4.6.4	DEVIATION FROM TEST STANDARD.....	52
4.6.5	TEST SETUP	53
4.6.6	EUT OPERATING CONDITIONS	53
4.6.7	TEST RESULTS	54
5	PHOTOGRAPHS OF THE TEST CONFIGURATION.....	66
6	INFORMATION ON THE TESTING LABORATORIES	67
7	APPENDIX A – MODIFICATIONS RECORDERS FOR ENGINEERING CHANGES TO THE EUT BY THE LAB.....	68



A D T

RELEASE CONTROL RECORD

ISSUE NO.	REASON FOR CHANGE	DATE ISSUED
RF121207E06-1	Original release	Jan. 11, 2013



A D T

1 CERTIFICATION

PRODUCT : Portable Terminal
BRAND NAME : XAC
MODEL NO.: FD-400GT(MC8090)
TEST SAMPLE : ENGINEERING SAMPLE
APPLICANT : XAC AUTOMATION CORP.
TESTED : Jan. 08, 2013
STANDARDS : FCC Part 22, Subpart H

The above equipment (model: FD-400GT(MC8090)) has been tested by **Bureau Veritas Consumer Products Services (H.K.) Ltd., Taoyuan Branch**, and found compliance with the requirement of the above standards. The test record, data evaluation & Equipment Under Test (EUT) configurations represented herein are true and accurate accounts of the measurements of the sample's EMC characteristics under the conditions specified in this report.

PREPARED BY : Midoli Peng , **DATE:** Jan. 11, 2013
(Midoli Peng, Specialist)

APPROVED BY : May Chen , **DATE:** Jan. 11, 2013
(May Chen, Deputy Manager)

2 SUMMARY OF TEST RESULTS

The EUT has been tested according to the following specifications:

APPLIED STANDARD: FCC Part 22 & Part 2			
STANDARD SECTION	TEST TYPE	RESULT	REMARK
2.1046 22.913 (a)	Effective radiated power	PASS	Meet the requirement of limit.
2.1055 22.355	Frequency Stability	PASS	Meet the requirement of limit.
2.1049	Occupied Bandwidth	PASS	Meet the requirement of limit.
22.917	Band Edge Measurements	PASS	Meet the requirement of limit.
2.1051 22.917	Conducted Spurious Emissions	PASS	Meet the requirement of limit.
2.1053 22.917	Radiated Spurious Emissions	PASS	Meet the requirement of limit. Minimum passing margin is -35.55dB at 1697.6MHz.

2.1 MEASUREMENT UNCERTAINTY

Where relevant, the following measurement uncertainty levels have been estimated for tests performed on the EUT as specified in CISPR 16-4-2:

This uncertainty represents an expanded uncertainty expressed at approximately the 95% confidence level using a coverage factor of $k=2$.

Measurement	Value
Radiated emissions (30MHz-1GHz)	5.59 dB
Radiated emissions (1GHz -6GHz)	3.56 dB
Radiated emissions (6GHz -18GHz)	4.10 dB
Radiated emissions (18GHz -40GHz)	4.24 dB

3 GENERAL INFORMATION

3.1 GENERAL DESCRIPTION OF EUT

PRODUCT	Portable Terminal
MODEL NO.	FD-400GT(MC8090)
POWER SUPPLY	DC 12V from adapter or DC7.4V from battery
MODULATION TYPE	GMSK, 8PSK (for GPRS / EDGE) BPSK (for WCDMA)
OPERATING FREQUENCY	824.2MHz ~ 848.8MHz (for GPRS / EDGE) 826.4MHz ~ 846.6MHz (for WCDMA)
NUMBER OF CHANNEL	124 (for GPRS / EDGE) 102 (for WCDMA)
MAX. ERP POWER	GPRS Mode: 34.0dBm (2511.9mW) EDGE Mode: 32.9dBm (1949.8mW) WCDMA Mode: 24.8dBm (302.0mW)
ANTENNA TYPE	Please see NOTE
MAX. ANTENNA GAIN	Please see NOTE
DATA CABLE	NA
I/O PORTS	Refer to users' manual
ACCESSORY DEVICES	Adapter x 1, Battery x 1

NOTE:

1. There are RFID, GPRS, EDGE, WCDMA, HSDPA and HSUPA technology used for the EUT. and the functions of EUT listed as below table:

Function	Report No.
RFID	RF121207E06
2G & 3G (Part 22)	RF121207E06-1
2G & 3G (Part 24)	RF121207E06-2

2. The emission of the simultaneous operation (RFID & GPRS, EDGE, WCDMA, HSDPA and HSUPA) has been evaluated and no non-compliance found.



A D T

3. The EUT could be supplied with 7.4V battery or power adapter as the following table:

Item	Brand	Model No.	Spec.
Battery	CHENG UEI PRECISION INDUSTRY CO.,LTD	FD400	DC7.4V, 2300mAh(17.02Wh)
Adapter	DELTA	ADP-36JH B	AC I/P: 100-240V, 50-60Hz, 1.0A AC input cable: Unshielded, 1.85m DC O/P: 12V, 3A DC output cable: Unshielded, 1.8m with one core

4. There are two antennas provided to this EUT, please refer to the following table:

RFID Antenna Spec.					
Brand	Model No.	Antenna Type	Antenna Connector	Gain(dBi)	Frequency range (MHz)
XAC	PCB OSP ANTENNA BOARD FD400 (ROHS)	PCB (2 Layers)	NA	13	13.56
GPRS, EDGE, WCDMA, HSDPA and HSUPA Antenna Spec.					
Brand	Model No.	Antenna Type	Antenna Connector	Gain(dBi)	Frequency range (MHz)
Ethertronics Inc.	T-000084-01	FPCB	NA	1.65	824~894 1850~1990

5. The EUT was pre-tested in chamber under the following modes:

Pre-test Mode	Description
Mode A	Battery mode
Mode B	Adapter mode

From the above modes, the radiated test worst case was found in **Mode A**. Therefore only the test data of the modes were recorded in this report.

6. The above EUT information was declared by manufacturer and for more detailed features description, please refer to the manufacturer's specifications or user's manual.



3.2 DESCRIPTION OF TEST MODES

FOR GPRS & EDGE:

124 channels are provided to this EUT. Therefore, the low, middle and high channels are chosen for testing.

	CHANNEL	FREQUENCY	TX MODE
LOW	128	824.2 MHz	GPRS, EDGE
MIDDLE	190	836.6 MHz	GPRS, EDGE
HIGH	251	848.8 MHz	GPRS, EDGE

NOTE:

1. Below 1 GHz, the channel 128, 190, and 251 were tested individually.
2. Above 1 GHz, the channel 128, 190, and 251 were tested individually.
3. The worst case for final test is chosen when the power control level set 3.
4. The channel space is 0.2MHz.
5. The EUT is a GPRS class 10 device, which provide 2 up-link. After pre-tested both functions, found up-link with 1 time slot is worse, therefore, test results of output power, frequency stability, occupied bandwidth and band edge tests came out from this.
6. The EUT is a EDGE class 12 device, which provide 4 up-link. After pre-tested both functions, found up-link with 1 time slot is worse, therefore, test results of output power, frequency stability, occupied bandwidth and band edge tests came out from this.
7. The EUT has GPRS, EDGE functions. After pre-testing, GPRS function is the worst case for all the emission tests.



A D T

FOR WCDMA:

102 channels are provided to this EUT. Therefore, the low, middle and high channels are chosen for testing.

	CHANNEL	FREQUENCY	TX MODE
LOW	4132	826.4 MHz	WCDMA, HSDPA, HSUPA
MIDDLE	4183	836.4 MHz	WCDMA, HSDPA, HSUPA
HIGH	4233	846.6 MHz	WCDMA, HSDPA, HSUPA

NOTE:

1. Below 1 GHz, the channel 4132, 4183 and 4233 were tested individually.
2. Above 1 GHz, the channel 4132, 4183 and 4233 were tested individually.
3. The channel space is 0.2MHz.
4. The EUT has WCDMA-RMC, HSPDA-RMC, HSDPA & HSUPA functions. After pre-testing, WCDMA-RMC function is the worst case for all the emission tests.

3.2.1 TEST MODE APPLICABILITY AND TESTED CHANNEL DETAIL

FOR GPRS EDGE:

EUT CONFIGURE MODE	APPLICABLE TO							DESCRIPTION
	OP	FS	OB	BE	CE	RE<1G	RE ^{>} 1G	
-	√	√	√	√	√	√	√	-

Where

OP: Output power	FS: Frequency stability
OB: Occupied bandwidth	BE: Band edge
CE: Conducted spurious emissions	RE<1G: Radiated emission below 1GHz
RE^{>}1G: Radiated emission above 1GHz	

NOTE: The EUT had been pre-tested on the positioned of each 3 axis. The worst case was found when positioned on **X-plane**.

OUTPUT POWER MEASUREMENT:

- Pre-Scan has been conducted to determine the worst-case mode from all possible combinations between available modulations, data rates and antenna ports (if EUT with antenna diversity architecture).
- Following channel(s) was (were) selected for the final test as listed below.

AVAILABLE CHANNEL	TESTED CHANNEL	MODULATION TECHNOLOGY
128 to 251	128, 190, 251	GPRS, EDGE

FREQUENCY STABILITY MEASUREMENT:

- Pre-Scan has been conducted to determine the worst-case mode from all possible combinations between available modulations, data rates, and antenna ports (if EUT with antenna diversity architecture).
- Following channel(s) was (were) selected for the final test as listed below.

AVAILABLE CHANNEL	TESTED CHANNEL	MODULATION TECHNOLOGY
128 to 251	190	GPRS

OCCUPIED BANDWIDTH MEASUREMENT:

- Pre-Scan has been conducted to determine the worst-case mode from all possible combinations between available modulations, data rates, and antenna ports (if EUT with antenna diversity architecture).
- Following channel(s) was (were) selected for the final test as listed below.

AVAILABLE CHANNEL	TESTED CHANNEL	MODULATION TECHNOLOGY
128 to 251	128, 190, 251	GPRS, EDGE

BAND EDGE MEASUREMENT:

- Pre-Scan has been conducted to determine the worst-case mode from all possible combinations between available modulations, data rates, and antenna ports (if EUT with antenna diversity architecture).
- Following channel(s) was (were) selected for the final test as listed below.

AVAILABLE CHANNEL	TESTED CHANNEL	MODULATION TECHNOLOGY
128 to 251	128, 251	GPRS, EDGE

CONDUCTED SPURIOUS EMISSIONS MEASUREMENT:

- Pre-Scan has been conducted to determine the worst-case mode from all possible combinations between available modulations, data rates, and antenna ports (if EUT with antenna diversity architecture).
- Following channel(s) was (were) selected for the final test as listed below.

AVAILABLE CHANNEL	TESTED CHANNEL	MODULATION TECHNOLOGY
128 to 251	128, 190, 251	GPRS

RADIATED EMISSION MEASUREMENT (BELOW 1 GHz):

- Pre-Scan has been conducted to determine the worst-case mode from all possible combinations between available modulations, data rates, xyz axis and antenna ports (if EUT with antenna diversity architecture).
- Following channel(s) was (were) selected for the final test as listed below.

AVAILABLE CHANNEL	TESTED CHANNEL	MODULATION TECHNOLOGY
128 to 251	128, 190, 251	GPRS

RADIATED EMISSION MEASUREMENT (ABOVE 1 GHz):

- Pre-Scan has been conducted to determine the worst-case mode from all possible combinations between available modulations, data rates and antenna ports (if EUT with antenna diversity architecture).
- Following channel(s) was (were) selected for the final test as listed below.

AVAILABLE CHANNEL	TESTED CHANNEL	MODULATION TECHNOLOGY
128 to 251	128, 190, 251	GPRS

TEST CONDITION:

APPLICABLE TO	ENVIRONMENTAL CONDITIONS	INPUT POWER	TESTED BY
OP	25deg. C, 63%RH	7.4Vdc from battery	Evan Huang
FS	25deg. C, 63%RH	7.4Vdc from battery	Evan Huang
OB	25deg. C, 63%RH	7.4Vdc from battery	Evan Huang
EM	25deg. C, 63%RH	7.4Vdc from battery	Evan Huang
BE	25deg. C, 63%RH	7.4Vdc from battery	Evan Huang
CE	25deg. C, 63%RH	7.4Vdc from battery	Evan Huang
RE < 1G	25deg. C, 63%RH	7.4Vdc from battery	Robert Cheng
RE ³ 1G	25deg. C, 63%RH	7.4Vdc from battery	Robert Cheng



A D T

FOR WCDMA:

EUT CONFIGURE MODE	APPLICABLE TO							DESCRIPTION
	OP	FS	OB	BE	CE	RE<1G	RE≥1G	
-	√	√	√	√	√	√	√	-

Where **OP**: Output power **FS**: Frequency stability
OB: Occupied bandwidth **BE**: Band edge
CE: Conducted spurious emissions **RE<1G**: Radiated emission below 1GHz
RE≥1G: Radiated emission above 1GHz

NOTE: The EUT had been pre-tested on the positioned of each 3 axis. The worst case was found when positioned on **X-plane**.

OUTPUT POWER MEASUREMENT:

- Pre-Scan has been conducted to determine the worst-case mode from all possible combinations between available modulations and antenna ports (if EUT with antenna diversity architecture).
- Following channel(s) was (were) selected for the final test as listed below.

AVAILABLE CHANNEL	TESTED CHANNEL	MODULATION TECHNOLOGY
4132 to 4233	4132, 4183, 4233	WCDMA, HSDPA, HSUPA

FREQUENCY STABILITY MEASUREMENT:

- Pre-Scan has been conducted to determine the worst-case mode from all possible combinations between available modulations and antenna ports (if EUT with antenna diversity architecture).
- Following channel(s) was (were) selected for the final test as listed below.

AVAILABLE CHANNEL	TESTED CHANNEL	MODULATION TECHNOLOGY
4132 to 4233	4183	WCDMA

OCCUPIED BANDWIDTH MEASUREMENT:

- This item includes all test value of each mode, but only includes spectrum plot of worst value of each mode.
- Pre-Scan has been conducted to determine the worst-case mode from all possible combinations between available modulations and antenna ports (if EUT with antenna diversity architecture).
- Following channel(s) was (were) selected for the final test as listed below.

AVAILABLE CHANNEL	TESTED CHANNEL	MODULATION TECHNOLOGY
4132 to 4233	4132, 4183, 4233	WCDMA, HSDPA, HSUPA



BAND EDGE MEASUREMENT:

- Pre-Scan has been conducted to determine the worst-case mode from all possible combinations between available modulations and antenna ports (if EUT with antenna diversity architecture).
- Following channel(s) was (were) selected for the final test as listed below.

AVAILABLE CHANNEL	TESTED CHANNEL	MODULATION TECHNOLOGY
4132 to 4233	4132, 4233	WCDMA

CONDUCTED SPURIOUS EMISSIONS MEASUREMENT:

- Pre-Scan has been conducted to determine the worst-case mode from all possible combinations between available modulations and antenna ports (if EUT with antenna diversity architecture).
- Following channel(s) was (were) selected for the final test as listed below.

AVAILABLE CHANNEL	TESTED CHANNEL	MODULATION TECHNOLOGY
4132 to 4233	4132, 4183, 4233	WCDMA

RADIATED EMISSION MEASUREMENT (BELOW 1 GHz):

- Pre-Scan has been conducted to determine the worst-case mode from all possible combinations between available modulations and antenna ports (if EUT with antenna diversity architecture).
- Following channel(s) was (were) selected for the final test as listed below.

AVAILABLE CHANNEL	TESTED CHANNEL	MODULATION TECHNOLOGY
4132 to 4233	4132, 4183, 4233	WCDMA

RADIATED EMISSION MEASUREMENT (ABOVE 1 GHz):

- Pre-Scan has been conducted to determine the worst-case mode from all possible combinations between available modulations and antenna ports (if EUT with antenna diversity architecture).
- Following channel(s) was (were) selected for the final test as listed below.

AVAILABLE CHANNEL	TESTED CHANNEL	MODULATION TECHNOLOGY
4132 to 4233	4132, 4183, 4233	WCDMA



A D T

TEST CONDITION:

APPLICABLE TO	ENVIRONMENTAL CONDITIONS	INPUT POWER	TESTED BY
OP	25deg. C, 63%RH	7.4Vdc from battery	Evan Huang
FS	25deg. C, 63%RH	7.4Vdc from battery	Evan Huang
OB	25deg. C, 63%RH	7.4Vdc from battery	Evan Huang
EM	25deg. C, 63%RH	7.4Vdc from battery	Evan Huang
BE	25deg. C, 63%RH	7.4Vdc from battery	Evan Huang
CE	25deg. C, 63%RH	7.4Vdc from battery	Evan Huang
RE < 1G	25deg. C, 63%RH	7.4Vdc from battery	Robert Cheng
RE ³ 1G	25deg. C, 63%RH	7.4Vdc from battery	Robert Cheng

3.3 GENERAL DESCRIPTION OF APPLIED STANDARDS

The EUT is a RF product. According to the specifications of the manufacturer, it must comply with the requirements of the following standards:

FCC 47 CFR Part 2

FCC 47 CFR Part 22

ANSI/TIA/EIA-603-C 2004

All test items have been performed and recorded as per the above standards.

3.4 DESCRIPTION OF SUPPORT UNITS

The EUT has been tested as an independent unit together with other necessary accessories or support units. The following support units or accessories were used to form a representative test configuration during the tests.

No.	Product	Brand	Model No.	Serial No.	FCC ID
1	Universal Radio Communication Tester	R&S	CMU200	121040	NA

No.	Signal cable description
1	NA

NOTE: All power cords of the above support units are non shielded (1.8m).



A D T

3.5 CONFIGURATION OF SYSTEM UNDER TEST

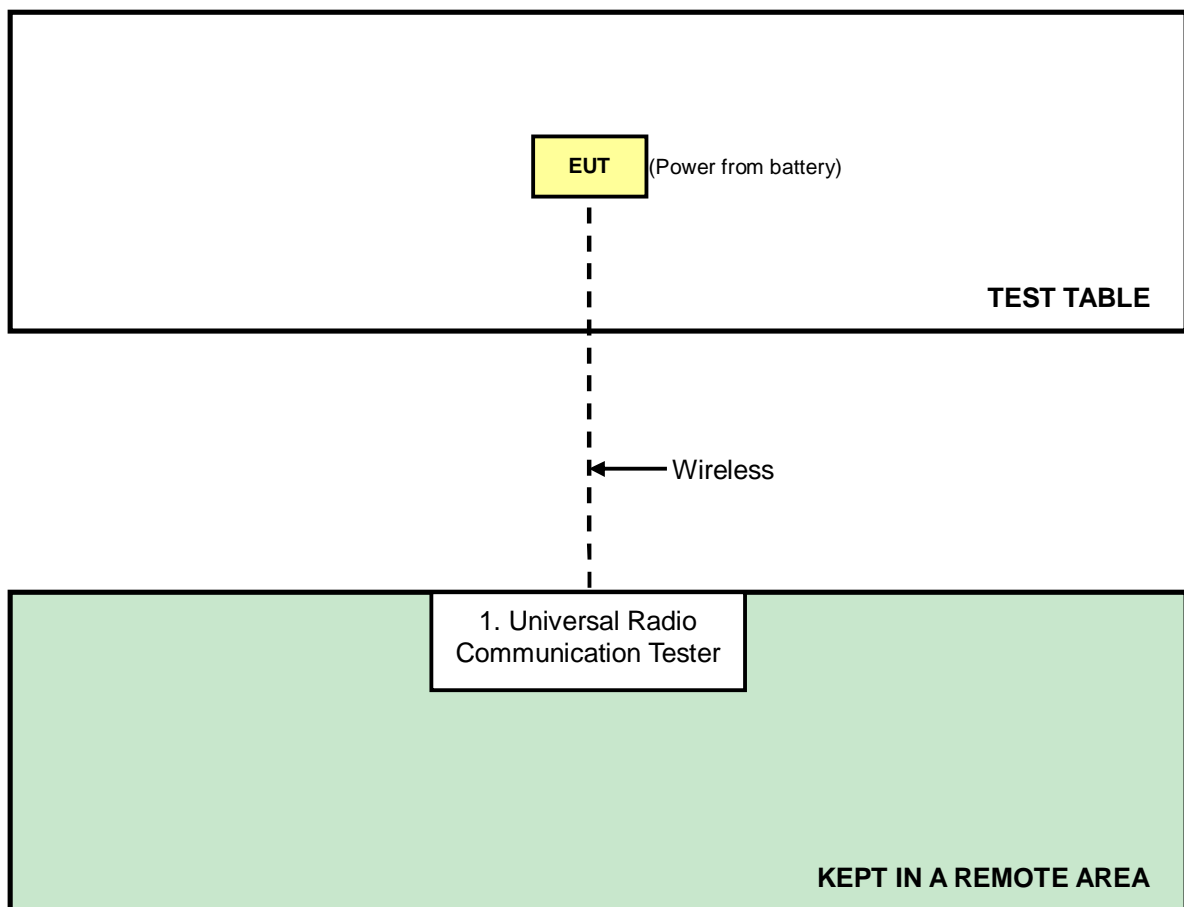

4 TEST TYPES AND RESULTS

4.1 OUTPUT POWER MEASUREMENT

4.1.1 LIMITS OF OUTPUT POWER MEASUREMENT

Mobile / Portable station are limited to 7 watts e.r.p.



A D T

4.1.2 TEST INSTRUMENTS

EIRP POWER MEASUREMENT:

DESCRIPTION & MANUFACTURER	MODEL NO.	SERIAL NO.	CALIBRATED DATE	CALIBRATED UNTIL
Spectrum Analyzer Agilent	E4446A	MY48250254	July 09, 2012	July 08, 2013
Pre-Selector Agilent	N9039A	MY46520311	July 09, 2012	July 08, 2013
Signal Generator Agilent	N5181A	MY49060517	July 09, 2012	July 08, 2013
Pre-Amplifier Mini-Circuits	ZFL-1000VH2 B	AMP-ZFL-03	Nov. 14, 2012	Nov. 13, 2013
Pre-Amplifier Agilent	8449B	3008A02578	June 26, 2012	June 25, 2013
Pre-Amplifier SPACEK LABS	SLKKa-48-6	9K16	Nov. 14, 2012	Nov. 13, 2013
Trilog Broadband Antenna SCHWARZBECK	VULB 9168	9168-360	Apr. 09, 2012	Apr. 08, 2013
Horn_Antenna AISI	AIH.8018	0000320091110	Nov. 22, 2012	Nov. 21, 2013
Horn_Antenna SCHWARZBECK	BBHA 9170	9170-424	Oct. 12, 2012	Oct. 11, 2013
RF Cable	NA	RF104-201 RF104-203 RF104-204	Dec. 26, 2012	Dec. 25, 2013
RF Cable	NA	CHGCAB_001	Oct. 06, 2012	Oct. 05, 2013
Software	ADT_Radiated _V8.7.05	NA	NA	NA
Antenna Tower & Turn Table CT	NA	NA	NA	NA

Note:

1. The calibration interval of the above test instruments is 12 months and the calibrations are traceable to NML/ROC and NIST/USA.
2. The horn antenna, preamplifier (model: 8449B) are used only for the measurement of emission frequency above 1GHz if tested.
3. The test was performed in 966 Chamber No. G.
4. The FCC Site Registration No. is 966073.
5. The VCCI Site Registration No. is G-137.
6. The CANADA Site Registration No. is IC 7450H-2.
7. Tested Date: Jan. 08, 2013



A D T

CONDUCTED POWER MEASUREMENT:

DESCRIPTION & MANUFACTURER	MODEL NO.	SERIAL NO.	CALIBRATED DATE	CALIBRATED UNTIL
R&S SPECTRUM ANALYZER	FSP40	100060	May 09, 2012	May 08, 2013
OVEN	MHU-225AU	911033	Dec. 11, 2012	Dec. 10, 2013
AC POWER SOURCE	6205	1140503	NA	NA

- NOTE:**
1. The calibration interval of the above test instruments is 12 months and the calibrations are traceable to NML/ROC and NIST/USA.
 2. Tested date: Jan. 08, 2013

4.1.3 TEST PROCEDURES

EIRP / ERP MEASUREMENT:

- a. All measurements were done at low, middle and high operational frequency range. RWB and VBW is 1MHz for GPRS & EDGE and 5MHz for WCDMA mode.
- b. Substitution method is used for E.I.R.P measurement. In the semi-anechoic chamber, EUT placed on the 0.8m height of Turn Table, rotated the table around 360 degrees to search the maximum radiation power and receiver antenna shall be rotated vertical and horizontal polarization and moved height from 1m to 4m to find the maximum polar radiated power. The “Read Value” is the spectrum reading the maximum power value.
- c. The substitution horn antenna is substituted for EUT at the same position and signals generator export the CW signal to the substitution antenna via a tx cable. Rotated the Turn Table and moved receiving antenna to find the maximum radiation power. Adjust output power level of S.G to get a Value of spectrum reading equal to “Read Value “ of step b. Record the power level of S.G
- d. $EIRP = \text{Output power level of S.G} - \text{TX cable loss} + \text{Antenna gain of substitution horn.}$
 $E.R.P \text{ power can be calculated form E.I.R.P power by subtracting the gain of dipole, } E.R.P \text{ power} = E.I.P.R \text{ power} - 2.15\text{dBi.}$

CONDUCTED POWER MEASUREMENT:

The EUT was set up for the maximum power with GSM, GPRS, EDGE & WCDMA link data modulation and link up with simulator. Set the EUT to transmit under low, middle and high channel and record the power level shown on simulator.

4.1.4 TEST SETUP

EIRP POWER MEASUREMENT:

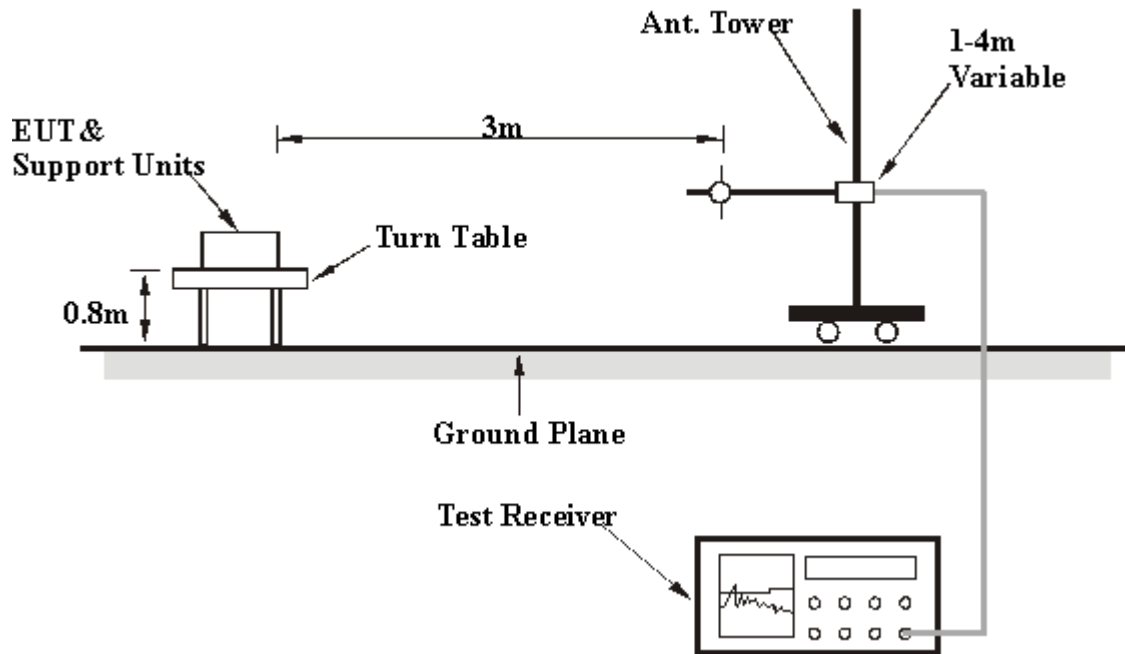

For the actual test configuration, please refer to the attached file (Test Setup Photo).

CONDUCTED POWER MEASUREMENT:

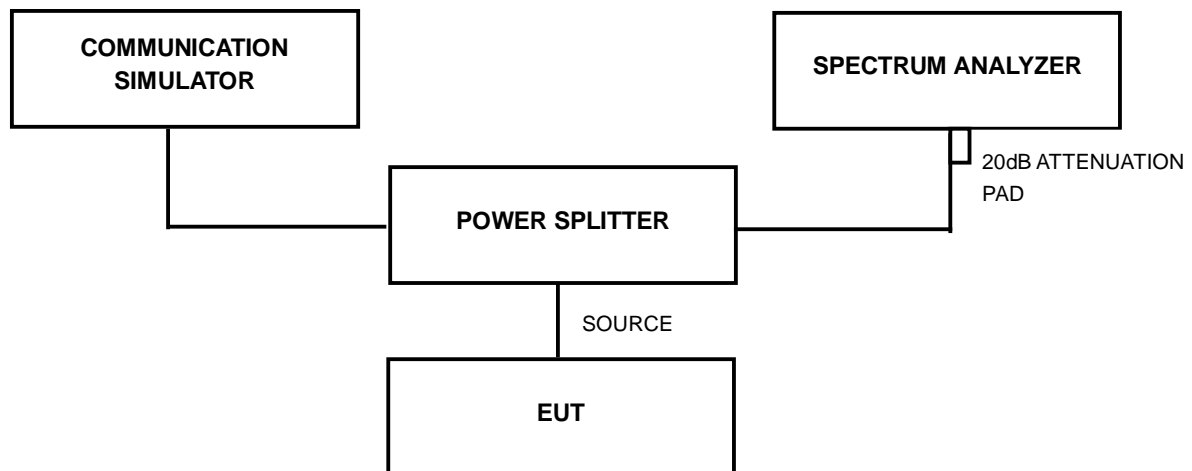

For the actual test configuration, please refer to the related item – Photographs of the Test Configuration.

4.1.5 EUT OPERATING CONDITIONS

- a. The EUT makes a call to the communication simulator.
- b. The communication simulator station system controlled a EUT to export maximum output power under transmission mode and specific channel frequency.



A D T

4.1.6 TEST RESULTS

FOR GPRS & EDGE:

GPRS MODE

CONDUCTED OUTPUT POWER					
CHANNEL NO.	FREQUENCY (MHz)	RAW VALUE (dBm)	CORRECTION FACTOR (dB)	OUTPUT POWER	
				dBm	mW
128	824.2	29.7	2.4	32.1	1621.8
190	836.6	29.8	2.4	32.2	1659.6
251	848.8	29.9	2.4	32.3	1698.2

EDGE MODE

CONDUCTED OUTPUT POWER					
CHANNEL NO.	FREQUENCY (MHz)	RAW VALUE (dBm)	CORRECTION FACTOR (dB)	OUTPUT POWER	
				dBm	mW
128	824.2	29.9	2.4	32.3	1698.2
190	836.6	29.6	2.4	32.0	1584.9
251	848.8	29.7	2.4	32.1	1621.8

REMARKS: 1. Peak Output Power (dBm) = Raw Value (dBm) + Correction Factor (dB).
2. Correction Factor (dB) = Power Splitter Loss (dB) + Cable Loss (dB) + 20dB Pad.



A D T

GPRS MODE

ERP POWER					
CHANNEL NO.	FREQUENCY (MHz)	S.G VALUE (dBm)	CORRECTION FACTOR (dB)	OUTPUT POWER	
				dBm	mW
128	824.2	30.6	1.3	31.9	1548.8
190	836.6	31.4	1.2	32.6	1819.7
251	848.8	33.0	1.0	34.0	2511.9

EDGE MODE

ERP POWER					
CHANNEL NO.	FREQUENCY (MHz)	S.G VALUE (dBm)	CORRECTION FACTOR (dB)	PEAK OUTPUT POWER	
				dBm	mW
128	824.2	30.2	1.3	31.5	1412.5
190	836.6	30.8	1.2	32.0	1584.9
251	848.8	31.9	1.0	32.9	1949.8

REMARKS: 1. Peak Output Power (dBm) = S.G Value (dBm) + Correction Factor (dB).
2. Correction Factor (dB) = substitution Antenna Gain (dBi) + Cable Loss (dB) + Free Space Loss (dB).



A D T

FOR WCDMA:

WCDMA-RMC MODE

CONDUCTED OUTPUT POWER					
CHANNEL NO.	FREQUENCY (MHz)	RAW VALUE (dBm)	CORRECTION FACTOR (dB)	OUTPUT POWER	
				dBm	mW
4132	826.4	21.1	2.4	23.5	223.9
4183	836.4	20.8	2.4	23.2	208.9
4233	846.6	20.9	2.4	23.3	213.8

HSDPA MODE

CONDUCTED OUTPUT POWER					
CHANNEL NO.	FREQUENCY (MHz)	RAW VALUE (dBm)	CORRECTION FACTOR (dB)	OUTPUT POWER	
				dBm	mW
4132	826.4	21.0	2.4	23.4	218.8
4183	836.4	20.5	2.4	22.9	195.0
4233	846.6	20.7	2.4	23.1	204.2

HSUPA MODE

CONDUCTED OUTPUT POWER					
CHANNEL NO.	FREQUENCY (MHz)	RAW VALUE (dBm)	CORRECTION FACTOR (dB)	OUTPUT POWER	
				dBm	mW
4132	826.4	20.7	2.4	23.1	204.2
4183	836.4	20.3	2.4	22.7	186.2
4233	846.6	20.8	2.4	23.2	208.9

REMARKS: 1. Peak Output Power (dBm) = Raw Value (dBm) + Correction Factor (dB).
2. Correction Factor (dB) = Power Splitter Loss (dB) + Cable Loss (dB) + 20dB Pad.



A D T

WCDMA-RMC MODE

ERP POWER					
CHANNEL NO.	FREQUENCY (MHz)	S.G VALUE (dBm)	CORRECTION FACTOR (dB)	OUTPUT POWER	
				dBm	mW
4132	826.4	21.4	1.3	22.7	186.2
4183	836.4	19.8	1.2	21.0	125.9
4233	846.6	23.7	1.1	24.8	302.0

HSDPA MODE

ERP POWER					
CHANNEL NO.	FREQUENCY (MHz)	S.G VALUE (dBm)	CORRECTION FACTOR (dB)	OUTPUT POWER	
				dBm	mW
4132	826.4	21.1	1.3	22.4	173.8
4183	836.4	21.8	1.2	23.0	199.5
4233	846.6	22.5	1.1	23.6	229.1

HSUPA MODE

ERP POWER					
CHANNEL NO.	FREQUENCY (MHz)	S.G VALUE (dBm)	CORRECTION FACTOR (dB)	OUTPUT POWER	
				dBm	mW
4132	826.4	21.0	1.3	22.3	169.8
4183	836.4	21.6	1.2	22.8	190.5
4233	846.6	22.4	1.1	23.5	223.9

- REMARKS:** 1. Peak Output Power (dBm) = S.G Value (dBm) + Correction Factor (dB).
2. Correction Factor (dB) = substitution Antenna Gain (dBi) + Cable Loss (dB) + Free Space Loss (dB).



A D T

4.2 FREQUENCY STABILITY MEASUREMENT

4.2.1 LIMITS OF FREQUENCY STABILITY MEASUREMENT

1.5 ppm is for base and fixed station. 2.5 ppm is for mobile station.

4.2.2 TEST INSTRUMENTS

DESCRIPTION & MANUFACTURER	MODEL NO.	SERIAL NO.	CALIBRATED DATE	CALIBRATED UNTIL
Spectrum Analyzer R&S	FSP 40	100060	May 09, 2012	May 08, 2013
Spectrum Analyzer Agilent	E4446A	MY48250113	Dec. 05, 2012	Dec. 04, 2013
Power meter Anritsu	ML2495A	1014008	Apr. 28, 2012	Apr. 27, 2013
Power sensor Anritsu	MA2411B	0917122	Apr. 28, 2012	Apr. 27, 2013
AC Power Source EXTECH Electronics	6502	1140503	NA	NA
Temperature & Humidity Chamber TERCHY	MHU-225AU	911033	Dec. 11, 2012	Dec. 10, 2013
DC Power Supply GOOD WILL INSTRUMENT CO., LTD.	GPC - 3030D	7700087	NA	NA
ESG Vector signal generator Agilent	E4438C	MY47271330 506 602 UNJ	May 08, 2012	May 07, 2013

- NOTE:**
1. The test was performed in Oven room A.
 2. The calibration interval of the above test instruments is 12 months and the calibrations are traceable to NML/ROC and NIST/USA.
 3. Tested Date: Jan. 08, 2013

4.2.3 TEST PROCEDURE

- a. Device is placed at the oven room. The oven room could control the temperatures and humidity. Power warm up is at least 15 min and power applied should perform before recording frequency error.
- b. EUT is connected the external power supply to control the DC input power. The test voltage range is from minimum to maximum working voltage. Each step shall be record the frequency error rate.
- c. The temperature range step is 10 degrees in this test items. All temperature levels shall be hold the $\pm 0.5^{\circ}\text{C}$ during the measurement testing. The each temperature step shall be at least 0.5 hours, consider the EUT could be test under the stability condition.

4.2.4 TEST SETUP

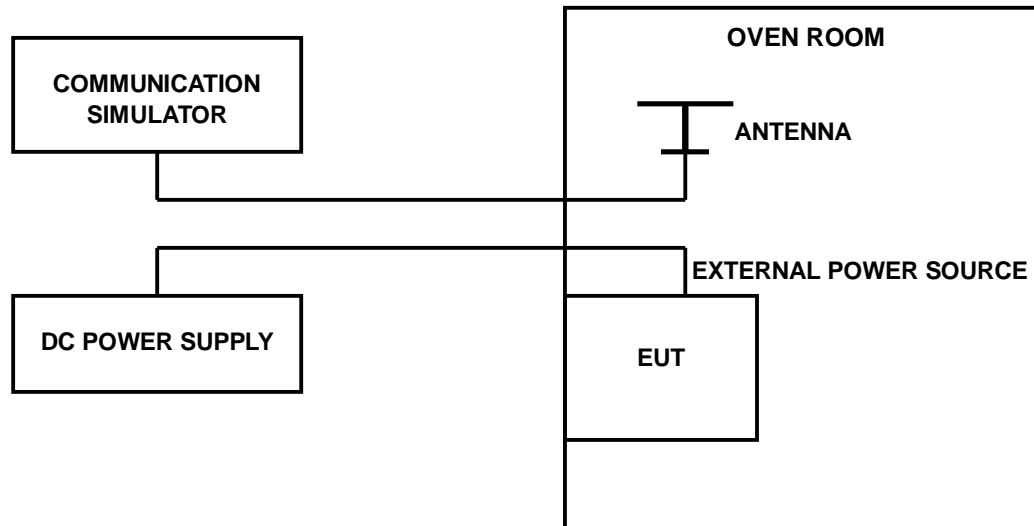



A D T

4.2.5 TEST RESULTS

FOR GPRS:

AFC FREQUENCY ERROR vs. VOLTAGE			
VOLTAGE (Volts)	FREQUENCY ERROR (Hz)	FREQUENCY ERROR (ppm)	LIMIT (ppm)
102	-30	-0.036	2.5
138	-31	-0.037	2.5

AFC FREQUENCY ERROR vs. TEMP.			
TEMP. (°C)	FREQUENCY ERROR (Hz)	FREQUENCY ERROR (ppm)	LIMIT (ppm)
50	-32	-0.038	2.5
40	-31	-0.037	2.5
30	-30	-0.036	2.5
20	-30	-0.036	2.5
10	-31	-0.037	2.5
0	-29	-0.035	2.5
-10	-32	-0.038	2.5
-20	-32	-0.038	2.5
-30	-33	-0.039	2.5



A D T

FOR WCDMA:

AFC FREQUENCY ERROR vs. VOLTAGE			
VOLTAGE (Volts)	FREQUENCY ERROR (Hz)	FREQUENCY ERROR (ppm)	LIMIT (ppm)
102	-27	-0.032	2.5
138	-30	-0.036	2.5

AFC FREQUENCY ERROR vs. TEMP.			
TEMP. (°C)	FREQUENCY ERROR (Hz)	FREQUENCY ERROR (ppm)	LIMIT (ppm)
50	-29	-0.035	2.5
40	-31	-0.037	2.5
30	-25	-0.030	2.5
20	-30	-0.036	2.5
10	-32	-0.038	2.5
0	-32	-0.038	2.5
-10	-31	-0.037	2.5
-20	-31	-0.037	2.5
-30	-30	-0.036	2.5

4.3 OCCUPIED BANDWIDTH MEASUREMENT

4.3.1 LIMITS OF OCCUPIED BANDWIDTH MEASUREMENT

The EUT makes a call to the communication simulator. All measurements were done at low, middle and high operational frequency range. The communication simulator station system controlled a EUT to export maximum output power under transmission mode and specific channel frequency. Use OBW measurement function of Spectrum analyzer to measure 99 % occupied bandwidth.

4.3.2 TEST INSTRUMENTS

DESCRIPTION & MANUFACTURER	MODEL NO.	SERIAL NO.	CALIBRATED DATE	CALIBRATED UNTIL
R&S SPECTRUM ANALYZER	FSP40	100060	May 09, 2012	May 08, 2013
OVEN	MHU-225AU	911033	Dec. 11, 2012	Dec. 10, 2013
AC POWER SOURCE	6205	1140503	NA	NA

- NOTE:**
1. The calibration interval of the above test instruments is 12 months and the calibrations are traceable to NML/ROC and NIST/USA.
 2. Tested date: Jan. 08, 2013

4.3.3 TEST SETUP

Same as Item 4.2.4 (Conducted Power Setup)

4.3.4 TEST PROCEDURES

The EUT makes a call to the communication simulator. All measurements were done at low, middle and high operational frequency range. The communication simulator station system controlled a EUT to export maximum output power under transmission mode and specific channel frequency. Use OBW measurement function of Spectrum analyzer to measure 99 % occupied bandwidth.

4.3.5 EUT OPERATING CONDITION

Same as Item 4.1.5



A D T

4.3.6 TEST RESULTS

CHANNEL	FREQUENCY (MHz)	99% OCCUPIED BANDWIDTH (kHz)	
		GPRS	EDGE
128	824.2	246.0	248.0
190	836.6	242.0	242.0
251	848.8	244.0	242.0

CHANNEL	FREQUENCY (MHz)	99% OCCUPIED BANDWIDTH (MHz)		
		WCDMA	HSDPA	HSUPA
4132	826.4	4.16	4.12	4.14
4183	836.4	4.2	4.26	4.22
4233	846.6	4.16	4.12	4.14



A D T

SPECTRUM PLOT OF WORST VALUE

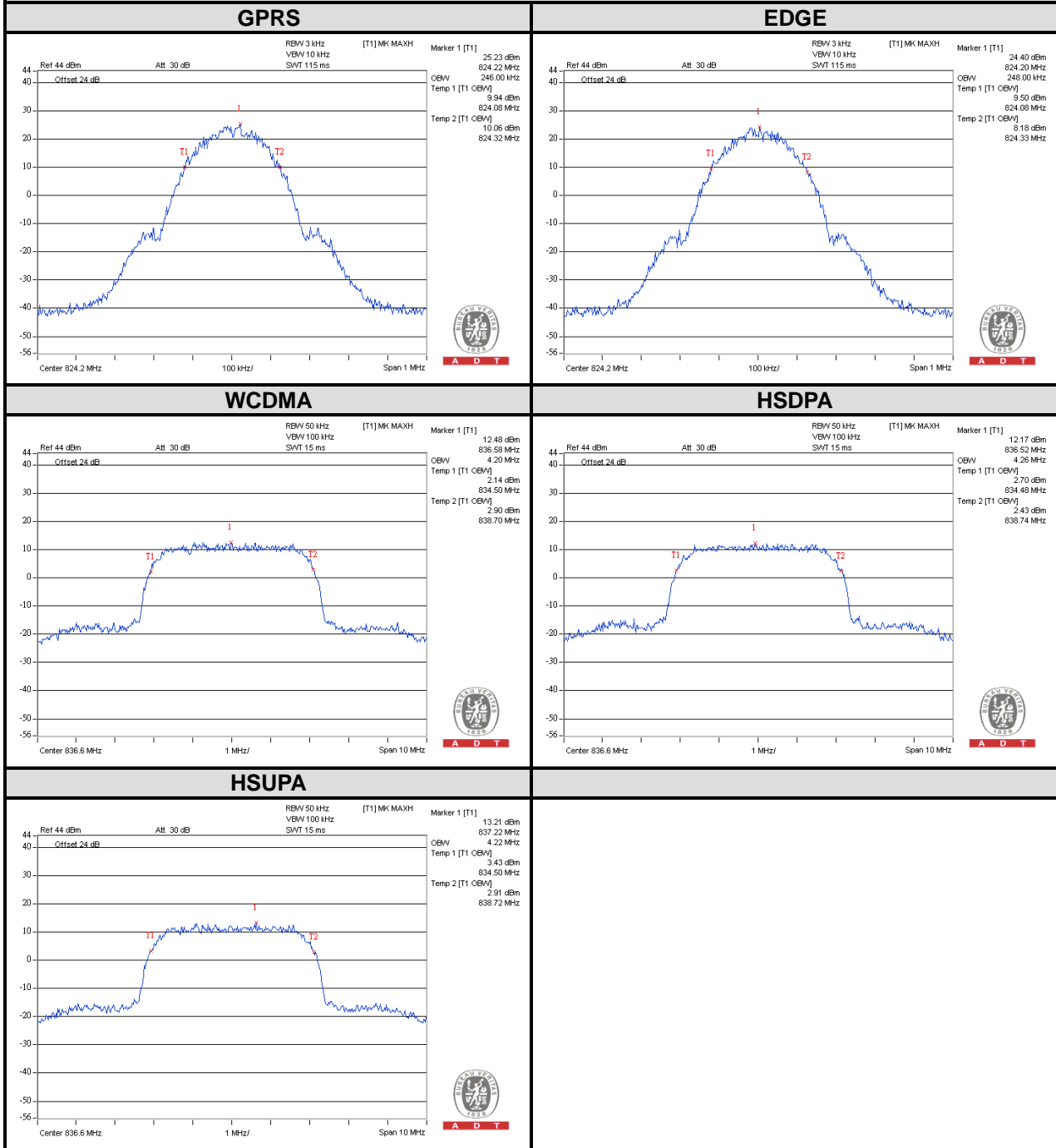



4.4 BAND EDGE MEASUREMENT

4.4.1 LIMITS OF BAND EDGE MEASUREMENT

Power of any emission outside of the authorized operating frequency ranges must be attenuated below the transmitting power (P) by a factor of at least $43 + 10 \log(P)$ dB. In the 1 MHz bands immediately outside and adjacent to the frequency block a resolution bandwidth of at least one percent of the emission bandwidth of the fundamental emission of the transmitter may be employed.

4.4.2 TEST INSTRUMENTS

DESCRIPTION & MANUFACTURER	MODEL NO.	SERIAL NO.	CALIBRATED DATE	CALIBRATED UNTIL
R&S SPECTRUM ANALYZER	FSP40	100060	May 09, 2012	May 08, 2013
OVEN	MHU-225AU	911033	Dec. 11, 2012	Dec. 10, 2013
AC POWER SOURCE	6205	1140503	NA	NA

- NOTE:**
1. The calibration interval of the above test instruments is 12 months and the calibrations are traceable to NML/ROC and NIST/USA.
 2. Tested date: Jan. 08, 2013

4.4.3 TEST SETUP

Same as Item 4.2.4 (Conducted Power Setup)

4.4.4 TEST PROCEDURES

- a. All measurements were done at low and high operational frequency range.
- b. The center frequency of spectrum is the band edge frequency and span is 1.5 MHz. RB of the spectrum is 3kHz and VB of the spectrum is 10kHz (GPRS/ EDGE).
- c. The center frequency of spectrum is the band edge frequency and span is 10MHz. RB of the spectrum is 100kHz and VB of the spectrum is 300kHz (WCDMA).
- d. Record the max trace plot into the test report.

4.4.5 EUT OPERATING CONDITION

Same as Item 4.1.5

4.4.6 TEST RESULTS

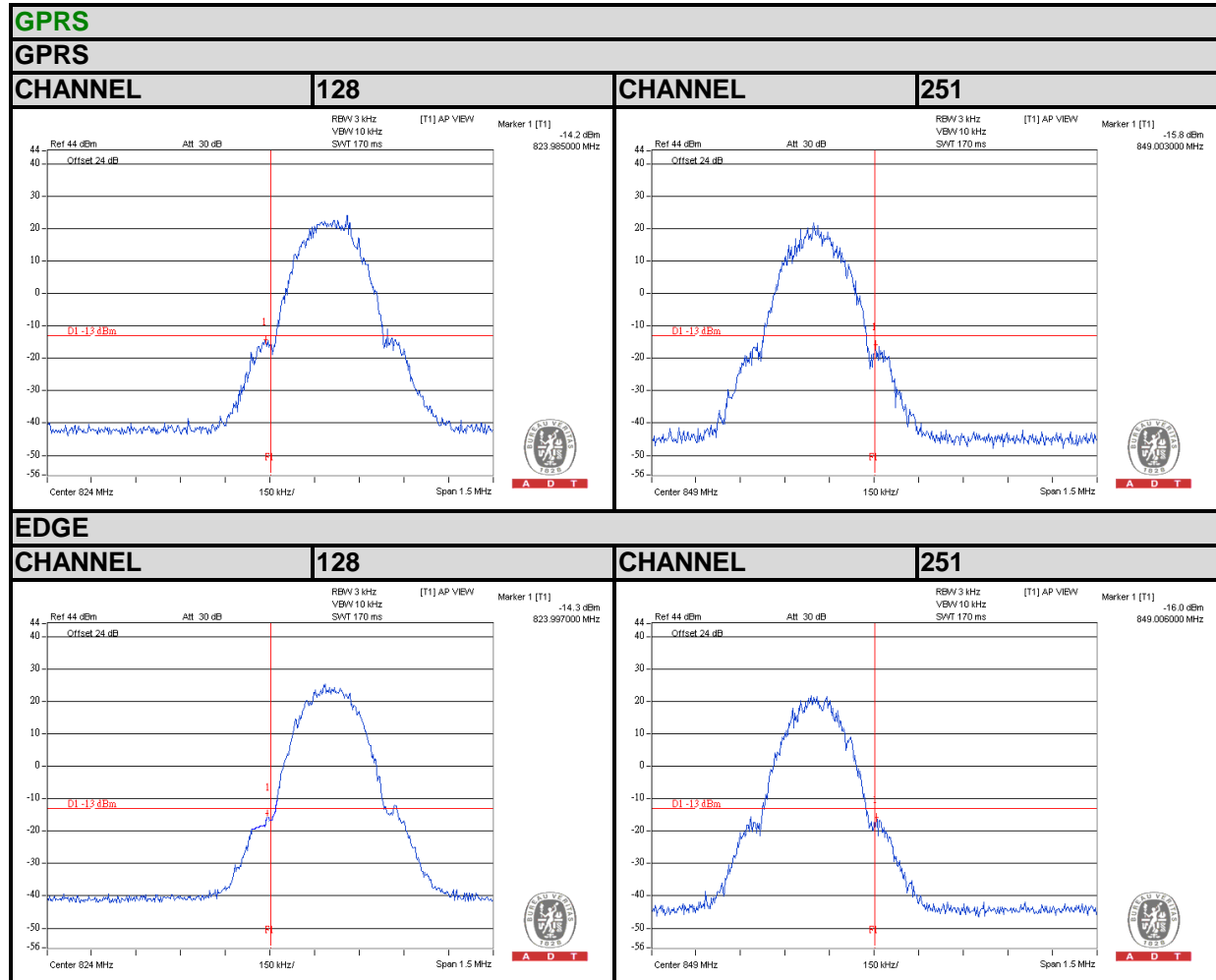



A D T

WCDMA

WCDMA

CHANNEL

4132

CHANNEL

4233

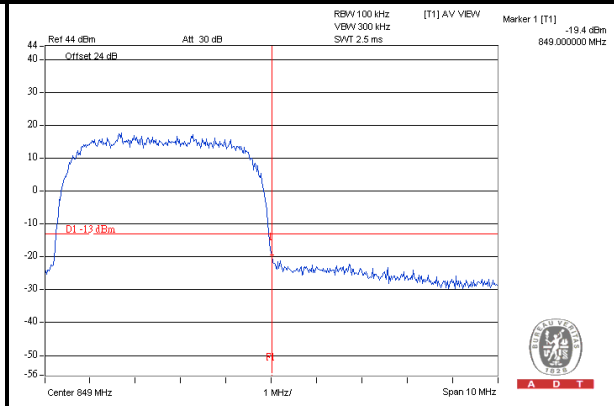
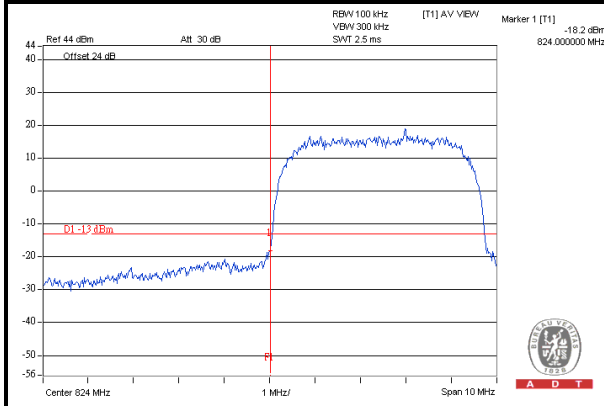

HSDPA

CHANNEL

4132

CHANNEL

4233

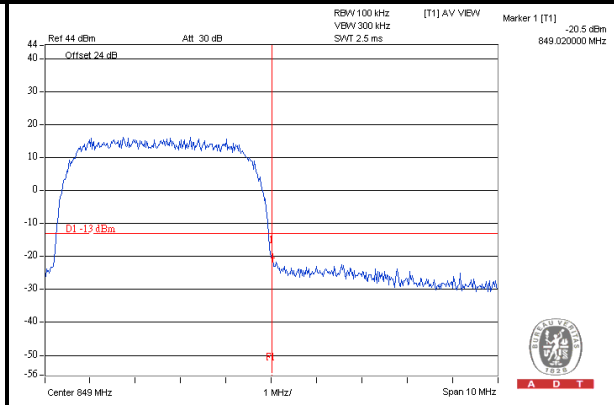
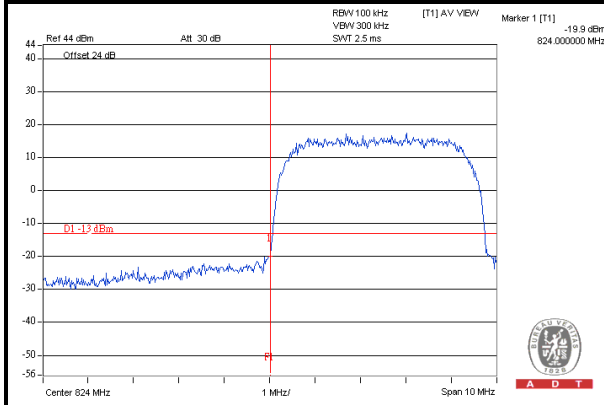

HSUPA

CHANNEL

4132

CHANNEL

4233

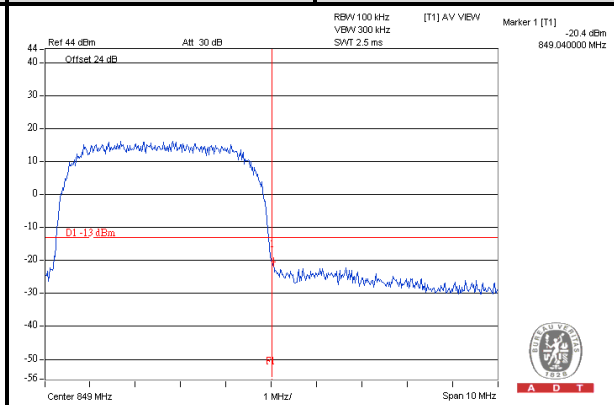
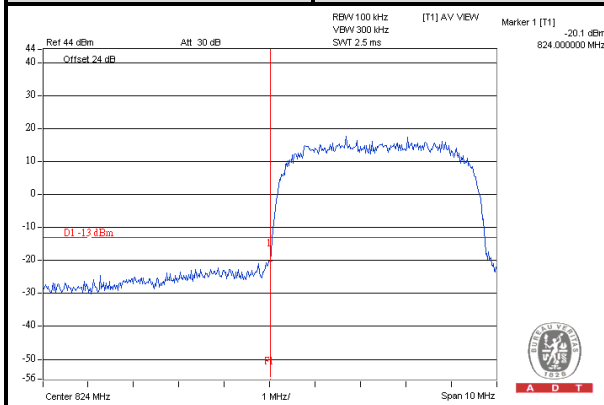



4.5 CONDUCTED SPURIOUS EMISSIONS

4.5.1 LIMITS OF CONDUCTED SPURIOUS EMISSIONS MEASUREMENT

The power of any emission outside of the authorized operating frequency ranges must be attenuated below the transmitting power (P) by a factor of at least $43 + 10 \log(P)$ dB. The emission limit equal to -13dBm .

4.5.2 TEST INSTRUMENTS

DESCRIPTION & MANUFACTURER	MODEL NO.	SERIAL NO.	CALIBRATED DATE	CALIBRATED UNTIL
R&S SPECTRUM ANALYZER	FSP40	100060	May 09, 2012	May 08, 2013
OVEN	MHU-225AU	911033	Dec. 11, 2012	Dec. 10, 2013
AC POWER SOURCE	6205	1140503	NA	NA
Wainwright Instruments Band Reject Filter	WRCG1850/191 0-1830/1930-60/ 10SS	SN1	NA	NA
* Wainwright Instruments High Pass Filter	WHK3.1/18G-10 SS	SN1	NA	NA

- NOTE:**
1. The calibration interval of the above test instruments is 12 months and the calibrations are traceable to NML/ROC and NIST/USA.
 2. Tested date: Jan. 08, 2013

4.5.3 TEST PROCEDURE

- The EUT makes a call to the communication simulator. All measurements were done at low, middle and high operational frequency range.
- Measuring frequency range is from 9 kHz to 9GHz. 20dB attenuation pad is connected with spectrum. RBW=1MHz and VBW=3MHz is used for conducted emission measurement.

4.5.4 TEST SETUP

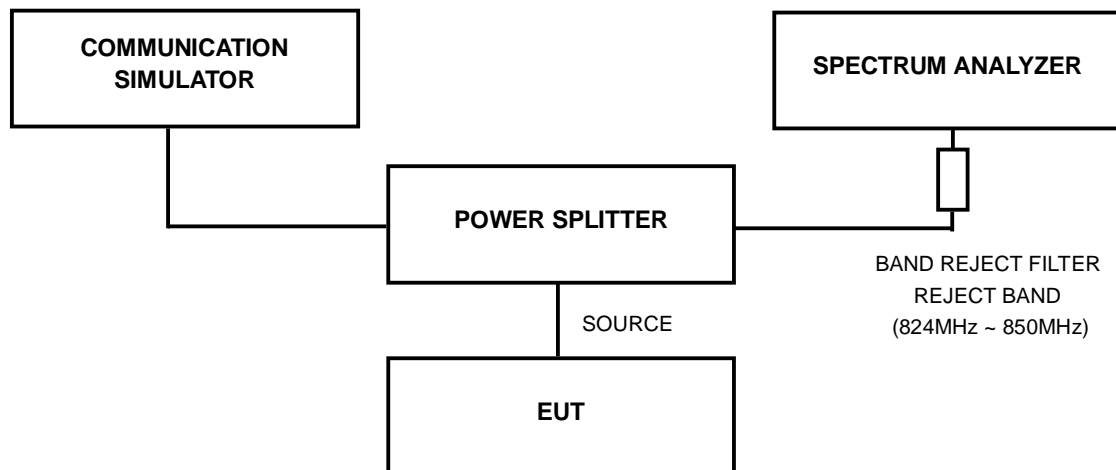

4.5.5 EUT OPERATING CONDITIONS

Same as Item 4.1.5



A D T

4.5.6 TEST RESULTS





A D T

GPRS

CHANNEL 190

FREQUENCY RANGE : 9kHz~1GHz

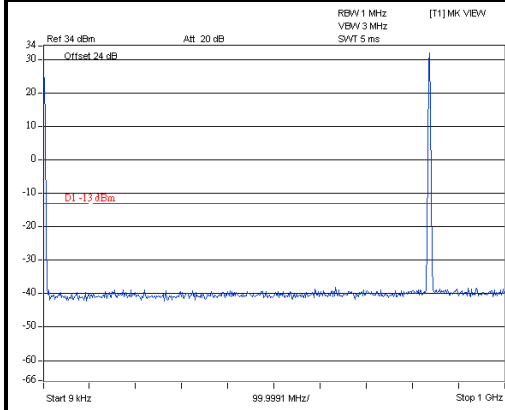

FREQUENCY RANGE : 1GHz~4GHz

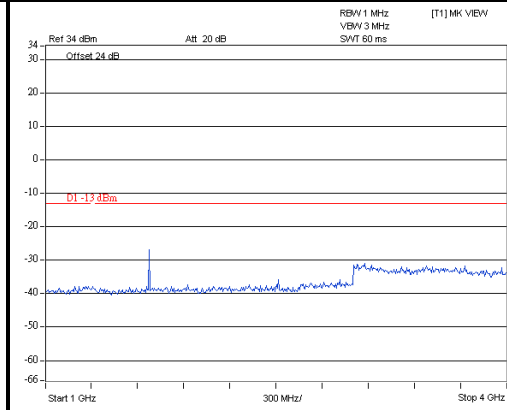

FREQUENCY RANGE : 4GHz~9GHz

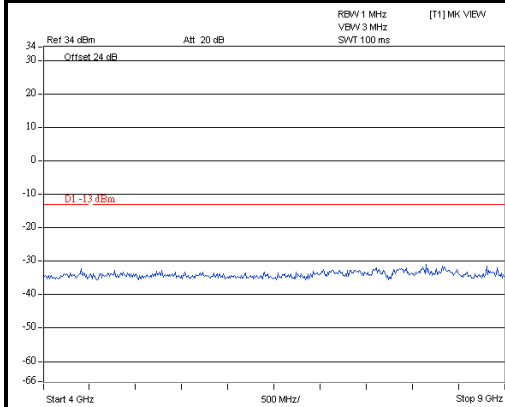



A D T

GPRS

CHANNEL 251

FREQUENCY RANGE : 9kHz~1GHz

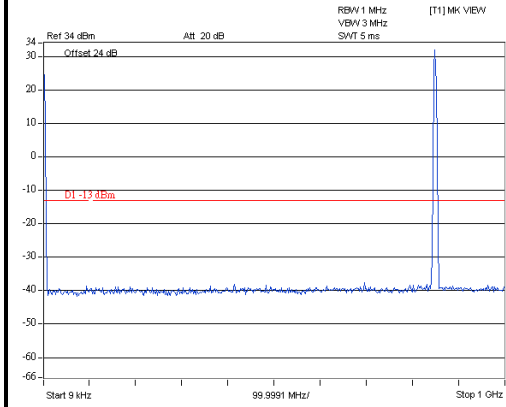

FREQUENCY RANGE : 1GHz~4GHz

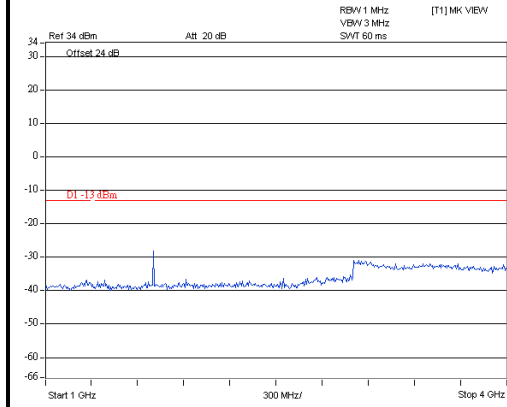

FREQUENCY RANGE : 4GHz~9GHz

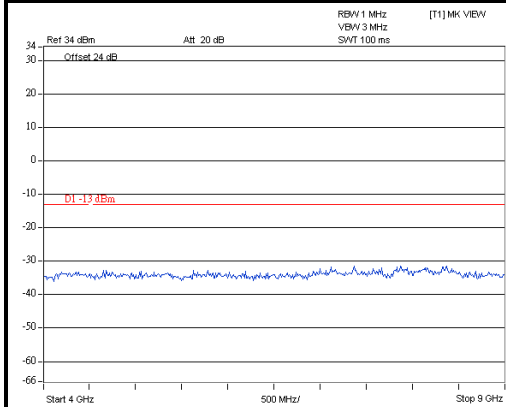



A D T

WCDMA

CHANNEL 4132

FREQUENCY RANGE : 9kHz~1GHz

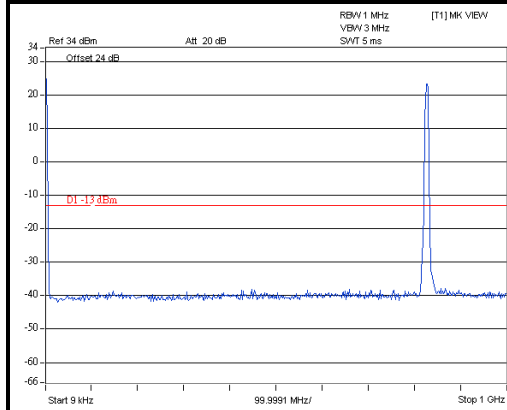

FREQUENCY RANGE : 1GHz~4GHz

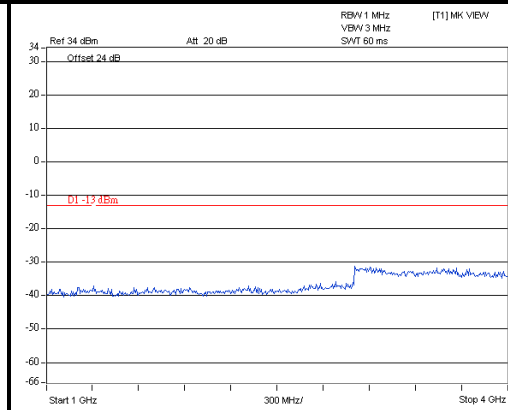

FREQUENCY RANGE : 4GHz~9GHz

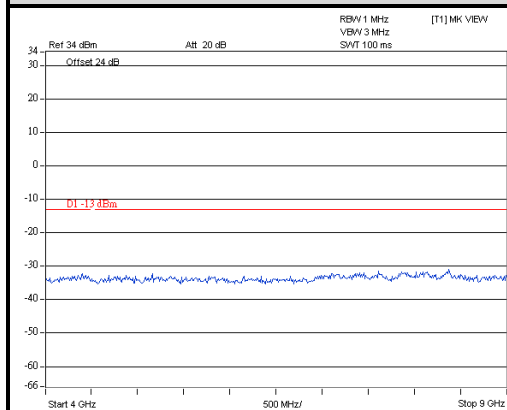



A D T

WCDMA

CHANNEL 4183

FREQUENCY RANGE : 9kHz~1GHz

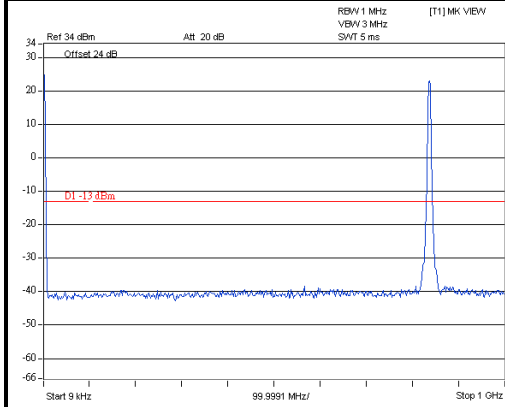

FREQUENCY RANGE : 1GHz~4GHz

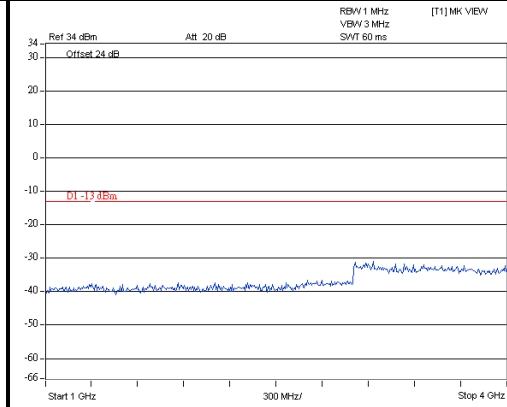

FREQUENCY RANGE : 4GHz~9GHz

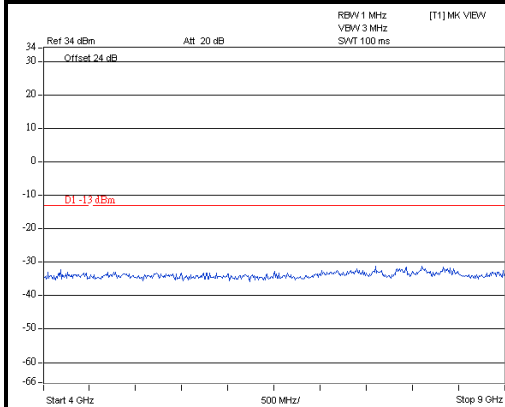



A D T

WCDMA

CHANNEL 4233

FREQUENCY RANGE : 9kHz~1GHz

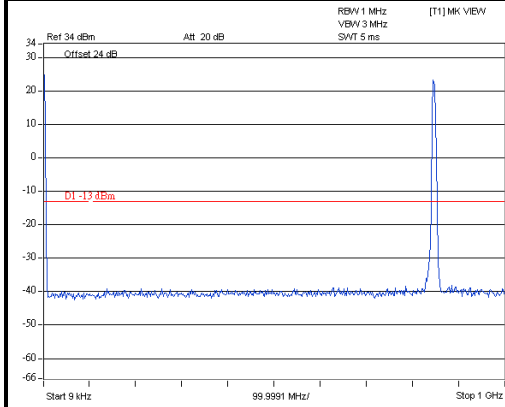

FREQUENCY RANGE : 1GHz~4GHz

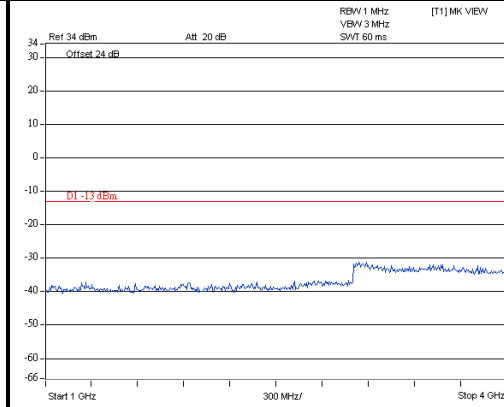

FREQUENCY RANGE : 4GHz~9GHz

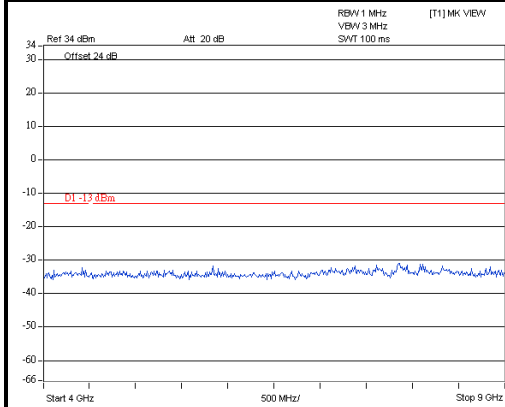

4.6 RADIATED EMISSION MEASUREMENT

4.6.1 LIMITS OF RADIATED EMISSION MEASUREMENT

The power of any emission outside of the authorized operating frequency ranges must be attenuated below the transmitting power (P) by a factor of at least $43 + 10 \log(P)$ dB. The emission limit equal to -13dBm .



A D T

4.6.2 TEST INSTRUMENTS

DESCRIPTION & MANUFACTURER	MODEL NO.	SERIAL NO.	CALIBRATED DATE	CALIBRATED UNTIL
Spectrum Analyzer Agilent	E4446A	MY48250254	July 09, 2012	July 08, 2013
Pre-Selector Agilent	N9039A	MY46520311	July 09, 2012	July 08, 2013
Signal Generator Agilent	N5181A	MY49060517	July 09, 2012	July 08, 2013
Pre-Amplifier Mini-Circuits	ZFL-1000VH2 B	AMP-ZFL-03	Nov. 14, 2012	Nov. 13, 2013
Pre-Amplifier Agilent	8449B	3008A02578	June 26, 2012	June 25, 2013
Pre-Amplifier SPACEK LABS	SLKKa-48-6	9K16	Nov. 14, 2012	Nov. 13, 2013
Trilog Broadband Antenna SCHWARZBECK	VULB 9168	9168-360	Apr. 09, 2012	Apr. 08, 2013
Horn_Antenna AISI	AIH.8018	0000320091110	Nov. 22, 2012	Nov. 21, 2013
Horn_Antenna SCHWARZBECK	BBHA 9170	9170-424	Oct. 12, 2012	Oct. 11, 2013
RF Cable	NA	RF104-201 RF104-203 RF104-204	Dec. 26, 2012	Dec. 25, 2013
RF Cable	NA	CHGCAB_001	Oct. 06, 2012	Oct. 05, 2013
Software	ADT_Radiated _V8.7.05	NA	NA	NA
Antenna Tower & Turn Table CT	NA	NA	NA	NA

Note:

1. The calibration interval of the above test instruments is 12 months and the calibrations are traceable to NML/ROC and NIST/USA.
2. The horn antenna, preamplifier (model: 8449B) are used only for the measurement of emission frequency above 1GHz if tested.
3. The test was performed in 966 Chamber No. G.
4. The FCC Site Registration No. is 966073.
5. The VCCI Site Registration No. is G-137.
6. The CANADA Site Registration No. is IC 7450H-2.
7. Tested Date: Jan. 08, 2013

4.6.3 TEST PROCEDURES

- a. Substitution method is used for E.I.R.P measurement. In the semi-anechoic chamber, EUT placed on the 0.8m height of Turn Table, rotated the table around 360 degrees to search the maximum radiation power and receiver antenna shall be rotated vertical and horizontal polarization and moved height from 1m to 4m to find the maximum polar radiated power. The “Read Value” is the spectrum reading the maximum power value.
- b. The substitution antenna is substituted for EUT at the same position and signals generator export the CW signal to the substitution antenna via a TX cable. Rotated the Turn Table and moved receiving antenna to find the maximum radiation power. Adjust output power level of S.G to get a Value of spectrum reading equal to “Read Value “ of step a. Record the power level of S.G
- c. $EIRP = \text{Output power level of S.G} - \text{TX cable loss} + \text{Antenna gain of substitution horn.}$
- d. E.R.P power can be calculated form E.I.R.P power by subtracting the gain of dipole, $E.R.P \text{ power} = E.I.P.R \text{ power} - 2.15\text{dBi.}$

NOTE: The resolution bandwidth and video bandwidth of test receiver/spectrum analyzer is 1MHz/3MHz.

4.6.4 DEVIATION FROM TEST STANDARD

No deviation

4.6.5 TEST SETUP

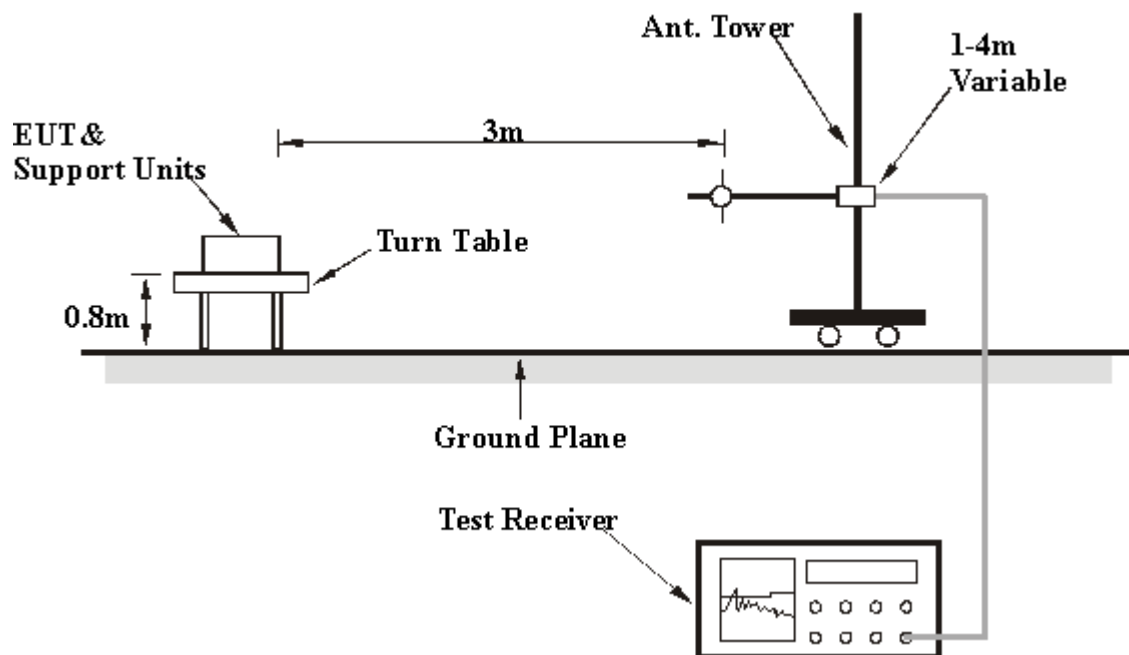

For the actual test configuration, please refer to the attached file (Test Setup Photo).

4.6.6 EUT OPERATING CONDITIONS

Same as Item 4.1.5



4.6.7 TEST RESULTS

BELOW 1GHz DATA

GPRS

CHANNEL	TX Channel 128	FREQUENCY RANGE	Below 1GHz
----------------	----------------	------------------------	------------

ANTENNA POLARITY & TEST DISTANCE: HORIZONTAL AT 3 M						
No.	Freq. (MHz)	Emission Level (dBuV)	Limit (dBm)	S.G Power Value (dBm)	Correction Factor (dB)	Power Value (dBm)
1	223.71	34.25	-13	-61.16	4.03	-57.13
2	433.61	31.34	-13	-66.78	2.98	-63.80
3	461.06	31.33	-13	-66.32	2.82	-63.50
4	488.3	32.46	-13	-63.70	2.87	-60.83
5	515.41	37.56	-13	-57.78	2.78	-55.00
6	895.1	33.47	-13	-64.86	0.55	-64.32
ANTENNA POLARITY & TEST DISTANCE: VERTICAL AT 3 M						
No.	Freq. (MHz)	Emission Level (dBuV)	Limit (dBm)	S.G Power Value (dBm)	Correction Factor (dB)	Power Value (dBm)
1	147.59	35.67	-13	-56.09	-1.08	-57.17
2	214.27	32.24	-13	-63.20	4.15	-59.05
3	242.92	32.43	-13	-62.81	3.84	-58.97
4	461.36	31.25	-13	-66.38	2.83	-63.56
5	488.18	34.44	-13	-61.73	2.87	-58.86
6	515.41	35.65	-13	-59.69	2.78	-56.91

REMARKS:

1. Output Power (dBm) = S.G Value (dBm) + Correction Factor (dB).
2. Correction Factor (dB) = Substitution Antenna Gain (dB) + Cable Loss (dB).



A D T

CHANNEL	TX Channel 190	FREQUENCY RANGE	Below 1GHz
----------------	----------------	------------------------	------------

ANTENNA POLARITY & TEST DISTANCE: HORIZONTAL AT 3 M						
No.	Freq. (MHz)	Emission Level (dBuV)	Limit (dBm)	S.G Power Value (dBm)	Correction Factor (dB)	Power Value (dBm)
1	223.71	34.57	-13	-60.84	4.03	-56.81
2	433.61	31.22	-13	-66.90	2.98	-63.92
3	461.06	31.45	-13	-66.20	2.82	-63.38
4	488.3	32.45	-13	-63.71	2.87	-60.84
5	515.41	37.56	-13	-57.78	2.78	-55.00
6	895.1	33.65	-13	-64.68	0.55	-64.14

ANTENNA POLARITY & TEST DISTANCE: VERTICAL AT 3 M						
No.	Freq. (MHz)	Emission Level (dBuV)	Limit (dBm)	S.G Power Value (dBm)	Correction Factor (dB)	Power Value (dBm)
1	147.59	35.45	-13	-56.31	-1.08	-57.39
2	214.27	32.65	-13	-62.79	4.15	-58.64
3	242.92	32.43	-13	-62.81	3.84	-58.97
4	461.36	31.35	-13	-66.28	2.83	-63.46
5	488.18	34.68	-13	-61.49	2.87	-58.62
6	515.41	35.44	-13	-59.90	2.78	-57.12

REMARKS:

1. Output Power (dBm) = S.G Value (dBm) + Correction Factor (dB).
2. Correction Factor (dB) = Substitution Antenna Gain (dB) + Cable Loss (dB).



A D T

CHANNEL	TX Channel 251	FREQUENCY RANGE	Below 1GHz
----------------	----------------	------------------------	------------

ANTENNA POLARITY & TEST DISTANCE: HORIZONTAL AT 3 M						
No.	Freq. (MHz)	Emission Level (dBuV)	Limit (dBm)	S.G Power Value (dBm)	Correction Factor (dB)	Power Value (dBm)
1	223.71	34.57	-13	-60.84	4.03	-56.81
2	433.61	31.21	-13	-66.91	2.98	-63.93
3	461.06	31.27	-13	-66.38	2.82	-63.56
4	488.3	32.54	-13	-63.62	2.87	-60.75
5	515.41	37.45	-13	-57.89	2.78	-55.11
6	895.1	33.24	-13	-65.09	0.55	-64.55

ANTENNA POLARITY & TEST DISTANCE: VERTICAL AT 3 M						
No.	Freq. (MHz)	Emission Level (dBuV)	Limit (dBm)	S.G Power Value (dBm)	Correction Factor (dB)	Power Value (dBm)
1	147.59	35.46	-13	-56.30	-1.08	-57.38
2	214.27	32.46	-13	-62.98	4.15	-58.83
3	242.92	32.67	-13	-62.57	3.84	-58.73
4	461.36	31.68	-13	-65.95	2.83	-63.13
5	488.18	34.25	-13	-61.92	2.87	-59.05
6	515.41	35.61	-13	-59.73	2.78	-56.95

REMARKS:

1. Output Power (dBm) = S.G Value (dBm) + Correction Factor (dB).
2. Correction Factor (dB) = Substitution Antenna Gain (dB) + Cable Loss (dB).



A D T

WCDMA

CHANNEL	TX Channel 4132	FREQUENCY RANGE	Below 1GHz
----------------	-----------------	------------------------	------------

ANTENNA POLARITY & TEST DISTANCE: HORIZONTAL AT 3 M						
No.	Freq. (MHz)	Emission Level (dBuV)	Limit (dBm)	S.G Power Value (dBm)	Correction Factor (dB)	Power Value (dBm)
1	223.71	34.67	-13	-60.74	4.03	-56.71
2	433.61	31.45	-13	-66.67	2.98	-63.69
3	461.06	31.22	-13	-66.43	2.82	-63.61
4	488.3	32.46	-13	-63.70	2.87	-60.83
5	515.41	37.89	-13	-57.45	2.78	-54.67
6	895.1	33.54	-13	-64.79	0.55	-64.25
ANTENNA POLARITY & TEST DISTANCE: VERTICAL AT 3 M						
No.	Freq. (MHz)	Emission Level (dBuV)	Limit (dBm)	S.G Power Value (dBm)	Correction Factor (dB)	Power Value (dBm)
1	147.59	35.65	-13	-56.11	-1.08	-57.19
2	214.27	32.44	-13	-63.00	4.15	-58.85
3	242.92	32.67	-13	-62.57	3.84	-58.73
4	461.36	32.13	-13	-65.50	2.83	-62.68
5	488.18	34.66	-13	-61.51	2.87	-58.64
6	515.41	35.65	-13	-59.69	2.78	-56.91

REMARKS:

1. Output Power (dBm) = S.G Value (dBm) + Correction Factor (dB).
2. Correction Factor (dB) = Substitution Antenna Gain (dB) + Cable Loss (dB).



A D T

CHANNEL	TX Channel 4183	FREQUENCY RANGE	Below 1GHz
----------------	-----------------	------------------------	------------

ANTENNA POLARITY & TEST DISTANCE: HORIZONTAL AT 3 M						
No.	Freq. (MHz)	Emission Level (dBuV)	Limit (dBm)	S.G Power Value (dBm)	Correction Factor (dB)	Power Value (dBm)
1	223.71	34.67	-13	-60.74	4.03	-56.71
2	433.61	31.22	-13	-66.90	2.98	-63.92
3	461.06	31.21	-13	-66.44	2.82	-63.62
4	488.3	32.45	-13	-63.71	2.87	-60.84
5	515.41	37.84	-13	-57.50	2.78	-54.72
6	895.1	33.74	-13	-64.59	0.55	-64.05
ANTENNA POLARITY & TEST DISTANCE: VERTICAL AT 3 M						
No.	Freq. (MHz)	Emission Level (dBuV)	Limit (dBm)	S.G Power Value (dBm)	Correction Factor (dB)	Power Value (dBm)
1	147.59	35.66	-13	-56.10	-1.08	-57.18
2	214.27	32.68	-13	-62.76	4.15	-58.61
3	242.92	32.67	-13	-62.57	3.84	-58.73
4	461.36	31.44	-13	-66.19	2.83	-63.37
5	488.18	34.25	-13	-61.92	2.87	-59.05
6	515.41	35.46	-13	-59.88	2.78	-57.10

REMARKS:

1. Output Power (dBm) = S.G Value (dBm) + Correction Factor (dB).
2. Correction Factor (dB) = Substitution Antenna Gain (dB) + Cable Loss (dB).



A D T

CHANNEL	TX Channel 4233	FREQUENCY RANGE	Below 1GHz
----------------	-----------------	------------------------	------------

ANTENNA POLARITY & TEST DISTANCE: HORIZONTAL AT 3 M						
No.	Freq. (MHz)	Emission Level (dBuV)	Limit (dBm)	S.G Power Value (dBm)	Correction Factor (dB)	Power Value (dBm)
1	223.71	34.51	-13	-60.90	4.03	-56.87
2	433.61	31.11	-13	-67.01	2.98	-64.03
3	461.06	31.62	-13	-66.03	2.82	-63.21
4	488.3	32.41	-13	-63.75	2.87	-60.88
5	515.41	37.83	-13	-57.51	2.78	-54.73
6	895.1	33.52	-13	-64.81	0.55	-64.27

ANTENNA POLARITY & TEST DISTANCE: VERTICAL AT 3 M						
No.	Freq. (MHz)	Emission Level (dBuV)	Limit (dBm)	S.G Power Value (dBm)	Correction Factor (dB)	Power Value (dBm)
1	147.59	35.47	-13	-56.29	-1.08	-57.37
2	214.27	32.76	-13	-62.68	4.15	-58.53
3	242.92	32.47	-13	-62.77	3.84	-58.93
4	461.36	31.76	-13	-65.87	2.83	-63.05
5	488.18	34.51	-13	-61.66	2.87	-58.79
6	515.41	35.87	-13	-59.47	2.78	-56.69

REMARKS:

1. Output Power (dBm) = S.G Value (dBm) + Correction Factor (dB).
2. Correction Factor (dB) = Substitution Antenna Gain (dB) + Cable Loss (dB).



A D T

ABOVE 1GHz DATA

GPRS

CHANNEL	TX Channel 128	FREQUENCY RANGE	1GHz ~ 9GHz
----------------	----------------	------------------------	-------------

ANTENNA POLARITY & TEST DISTANCE: HORIZONTAL AT 3 M						
No.	Freq. (MHz)	Emission Level (dBuV)	Limit (dBm)	S.G Power Value (dBm)	Correction Factor (dB)	Power Value (dBm)
1	1648.4	57.10	-13	-45.65	6.26	-39.39
2	2472.6	50.60	-13	-47.98	6.66	-41.32

ANTENNA POLARITY & TEST DISTANCE: VERTICAL AT 3 M						
No.	Freq. (MHz)	Emission Level (dBuV)	Limit (dBm)	S.G Power Value (dBm)	Correction Factor (dB)	Power Value (dBm)
1	1648.4	53.30	-13	-49.45	6.26	-43.19
2	2472.6	46.60	-13	-51.98	6.66	-45.32

REMARKS:

1. $ERP(dBm) = S.G \text{ Power Value (dBm)} + \text{Correction Factor (dB)}$.
2. Correction Factor = gain of substitution antenna + cable loss



A D T

CHANNEL	TX Channel 190	FREQUENCY RANGE	1GHz ~ 9GHz
----------------	----------------	------------------------	-------------

ANTENNA POLARITY & TEST DISTANCE: HORIZONTAL AT 3 M

No.	Freq. (MHz)	Emission Level (dBuV)	Limit (dBm)	S.G Power Value (dBm)	Correction Factor (dB)	Power Value (dBm)
1	1673.2	59.50	-13	-43.13	6.31	-36.82
2	2509.8	53.60	-13	-44.92	6.66	-38.26

ANTENNA POLARITY & TEST DISTANCE: VERTICAL AT 3 M

No.	Freq. (MHz)	Emission Level (dBuV)	Limit (dBm)	S.G Power Value (dBm)	Correction Factor (dB)	Power Value (dBm)
1	1673.2	57.00	-13	-45.63	6.31	-39.32
2	2509.8	46.60	-13	-51.92	6.66	-45.26

REMARKS:

1. $ERP(dBm) = S.G \text{ Power Value (dBm)} + \text{Correction Factor (dB)}$.
2. Correction Factor = gain of substitution antenna + cable loss



A D T

CHANNEL	TX Channel 251	FREQUENCY RANGE	1GHz ~ 9GHz
----------------	----------------	------------------------	-------------

ANTENNA POLARITY & TEST DISTANCE: HORIZONTAL AT 3 M						
No.	Freq. (MHz)	Emission Level (dBuV)	Limit (dBm)	S.G Power Value (dBm)	Correction Factor (dB)	Power Value (dBm)
1	1697.6	60.60	-13	-41.91	6.35	-35.55
2	2546.4	52.30	-13	-46.53	6.69	-39.83

ANTENNA POLARITY & TEST DISTANCE: VERTICAL AT 3 M						
No.	Freq. (MHz)	Emission Level (dBuV)	Limit (dBm)	S.G Power Value (dBm)	Correction Factor (dB)	Power Value (dBm)
1	1697.6	58.00	-13	-44.51	6.35	-38.15
2	2546.4	48.20	-13	-50.63	6.69	-43.93

REMARKS:

1. $ERP(dBm) = S.G \text{ Power Value (dBm)} + \text{Correction Factor (dB)}$.
2. Correction Factor = gain of substitution antenna + cable loss



A D T

WCDMA

CHANNEL	TX Channel 4132	FREQUENCY RANGE	1GHz ~ 9GHz
----------------	-----------------	------------------------	-------------

ANTENNA POLARITY & TEST DISTANCE: HORIZONTAL AT 3 M						
No.	Freq. (MHz)	Emission Level (dBuV)	Limit (dBm)	S.G Power Value (dBm)	Correction Factor (dB)	Power Value (dBm)
1	1652.8	37.00	-13	-65.73	6.27	-59.46
2	2479.2	39.60	-13	-58.95	6.66	-52.29

ANTENNA POLARITY & TEST DISTANCE: VERTICAL AT 3 M						
No.	Freq. (MHz)	Emission Level (dBuV)	Limit (dBm)	S.G Power Value (dBm)	Correction Factor (dB)	Power Value (dBm)
1	1652.8	37.10	-13	-65.63	6.27	-59.36
2	2479.2	39.10	-13	-59.45	6.66	-52.79

REMARKS:

1. ERP(dBm) = S.G Power Value (dBm) + Correction Factor (dB).
2. Correction Factor = gain of substitution antenna + cable loss



A D T

CHANNEL	TX Channel 4183	FREQUENCY RANGE	1GHz ~ 9GHz
----------------	-----------------	------------------------	-------------

ANTENNA POLARITY & TEST DISTANCE: HORIZONTAL AT 3 M

No.	Freq. (MHz)	Emission Level (dBuV)	Limit (dBm)	S.G Power Value (dBm)	Correction Factor (dB)	Power Value (dBm)
1	1672.8	37.20	-13	-65.43	6.31	-59.12
2	2509.2	39.90	-13	-58.62	6.66	-51.96

ANTENNA POLARITY & TEST DISTANCE: VERTICAL AT 3 M

No.	Freq. (MHz)	Emission Level (dBuV)	Limit (dBm)	S.G Power Value (dBm)	Correction Factor (dB)	Power Value (dBm)
1	1672.8	36.70	-13	-65.93	6.31	-59.62
2	2509.2	39.40	-13	-59.12	6.66	-52.46

REMARKS:

1. $ERP(dBm) = S.G \text{ Power Value (dBm)} + \text{Correction Factor (dB)}$.
2. Correction Factor = gain of substitution antenna + cable loss



A D T

CHANNEL	TX Channel 4233	FREQUENCY RANGE	1GHz ~ 9GHz
----------------	-----------------	------------------------	-------------

ANTENNA POLARITY & TEST DISTANCE: HORIZONTAL AT 3 M

No.	Freq. (MHz)	Emission Level (dBuV)	Limit (dBm)	S.G Power Value (dBm)	Correction Factor (dB)	Power Value (dBm)
1	1693.2	37.30	-13	-65.23	6.34	-58.88
2	2539.8	39.80	-13	-58.97	6.69	-52.28

ANTENNA POLARITY & TEST DISTANCE: VERTICAL AT 3 M

No.	Freq. (MHz)	Emission Level (dBuV)	Limit (dBm)	S.G Power Value (dBm)	Correction Factor (dB)	Power Value (dBm)
1	1693.2	36.50	-13	-66.03	6.34	-59.68
2	2539.8	39.70	-13	-59.07	6.69	-52.38

REMARKS:

1. $ERP(dBm) = S.G \text{ Power Value (dBm)} + \text{Correction Factor (dB)}$.
2. Correction Factor = gain of substitution antenna + cable loss



A D T

5 PHOTOGRAPHS OF THE TEST CONFIGURATION

Please refer to the attached file (Test Setup Photo).





6 INFORMATION ON THE TESTING LABORATORIES

We, Bureau Veritas Consumer Products Services (H.K.) Ltd., Taoyuan Branch, were founded in 1988 to provide our best service in EMC, Radio, Telecom and Safety consultation. Our laboratories are accredited and approved according to ISO/IEC 17025.

If you have any comments, please feel free to contact us at the following:

Linko EMC/RF Lab:

Tel: 886-2-26052180

Fax: 886-2-26052943

Hsin Chu EMC/RF Lab:

Tel: 886-3-5935343

Fax: 886-3-5935342

Hwa Ya EMC/RF/Safety/Telecom Lab:

Tel: 886-3-3183232

Fax: 886-3-3270892

Email: service.adt@tw.bureauveritas.com

Web Site: www.bureauveritas-adt.com

The address and road map of all our labs can be found in our web site also.



A D T

7 APPENDIX A – MODIFICATIONS RECORDERS FOR ENGINEERING CHANGES TO THE EUT BY THE LAB

No modifications were made to the EUT by the lab during the test.

---END---