



A D T

FCC TEST REPORT (PART 22)

REPORT NO.: RF110726E01-1

MODEL NO.: FD-400GT

FCC ID: MQT-FD400GT

RECEIVED: July 26, 2011

TESTED: Aug. 23 to 29, 2011

ISSUED: Sep. 05, 2011

APPLICANT: XAC AUTOMATION CORP.

ADDRESS: 4F, No. 30, INDUSTRY E. RD. IX, SCIENCE-BASED INDUSTRIAL PARK, HSINCHU, TAIWAN

ISSUED BY: Bureau Veritas Consumer Products Services (H.K.) Ltd., Taoyuan Branch Hsin Chu Laboratory

LAB ADDRESS : No. 81-1, Lu Liao Keng, 9th Ling, Wu Lung Tsuen, Chiung Lin Hsiang, Hsin Chu Hsien 307, Taiwan

This test report consists of 79 pages in total. It may be duplicated completely for legal use with the approval of the applicant. It should not be reproduced except in full, without the written approval of our laboratory. The client should not use it to claim product endorsement by TAF or any government agencies. The test results in the report only apply to the tested sample.





TABLE OF CONTENTS

RELEASE CONTROL RECORD	4
1 CERTIFICATION	5
2 SUMMARY OF TEST RESULTS	6
2.1 MEASUREMENT UNCERTAINTY	7
3 GENERAL INFORMATION	8
3.1 GENERAL DESCRIPTION OF EUT	8
3.2 DESCRIPTION OF TEST MODES	10
3.2.1 TEST MODE APPLICABILITY AND TESTED CHANNEL DETAIL	12
3.3 GENERAL DESCRIPTION OF APPLIED STANDARDS	18
3.4 DESCRIPTION OF SUPPORT UNITS.....	19
3.5 CONFIGURATION OF SYSTEM UNDER TEST	20
4 TEST TYPES AND RESULTS	21
4.1 OUTPUT POWER MEASUREMENT	21
4.1.1 LIMITS OF OUTPUT POWER MEASUREMENT	21
4.1.2 TEST INSTRUMENTS.....	22
4.1.3 TEST PROCEDURES	23
4.1.4 TEST SETUP	24
4.1.5 EUT OPERATING CONDITIONS	25
4.1.6 TEST RESULTS	26
4.2 FREQUENCY STABILITY MEASUREMENT	31
4.2.1 LIMITS OF FREQUENCY STABILITY MEASUREMENT	31
4.2.2 TEST INSTRUMENTS.....	31
4.2.3 TEST PROCEDURE.....	32
4.2.4 TEST SETUP	32
4.2.5 TEST RESULTS	33
4.3 OCCUPIED BANDWIDTH MEASUREMENT	35
4.3.1 LIMITS OF OCCUPIED BANDWIDTH MEASUREMENT	35
4.3.2 TEST INSTRUMENTS.....	35
4.3.3 TEST SETUP	35
4.3.4 TEST PROCEDURES	36
4.3.5 EUT OPERATING CONDITION.....	36
4.3.6 TEST RESULTS	37
4.4 BAND EDGE MEASUREMENT	41
4.4.1 LIMITS OF BAND EDGE MEASUREMENT	41
4.4.2 TEST INSTRUMENTS.....	41
4.4.3 TEST SETUP	41
4.4.4 TEST PROCEDURES	42
4.4.5 EUT OPERATING CONDITION.....	42
4.4.6 TEST RESULTS	43
4.5 CONDUCTED SPURIOUS EMISSIONS.....	47
4.5.1 LIMITS OF CONDUCTED SPURIOUS EMISSIONS MEASUREMENT	47
4.5.2 TEST INSTRUMENTS.....	47
4.5.3 TEST PROCEDURE.....	48



4.5.4	TEST SETUP	48
4.5.5	EUT OPERATING CONDITIONS	48
4.5.6	TEST RESULTS	49
4.6	RADIATED EMISSION MEASUREMENT (BELOW 1GHZ)	61
4.6.1	LIMITS OF RADIATED EMISSION MEASUREMENT.....	61
4.6.2	TEST INSTRUMENTS.....	62
4.6.3	TEST PROCEDURES	63
4.6.4	DEVIATION FROM TEST STANDARD	64
4.6.5	TEST SETUP	64
4.6.6	EUT OPERATING CONDITIONS	64
4.6.7	TEST RESULTS	65
4.7	RADIATED EMISSION MEASUREMENT (ABOVE 1GHZ)	67
4.7.1	LIMITS OF RADIATED EMISSION MEASUREMENT.....	67
4.7.2	TEST INSTRUMENTS.....	68
4.7.3	TEST PROCEDURES	69
4.7.4	DEVIATION FROM TEST STANDARD	69
4.7.5	TEST SETUP	70
4.7.6	EUT OPERATING CONDITIONS	70
4.7.7	TEST RESULTS	71
5	PHOTOGRAPHS OF THE TEST CONFIGURATION.....	77
6	INFORMATION ON THE TESTING LABORATORIES	78
7	APPENDIX A – MODIFICATIONS RECORDERS FOR ENGINEERING CHANGES TO THE EUT BY THE LAB	79



A D T

RELEASE CONTROL RECORD

ISSUE NO.	REASON FOR CHANGE	DATE ISSUED
RF110726E01-1	Original release	Sep. 05, 2011



A D T

1 CERTIFICATION

PRODUCT : Portable Terminal
BRAND NAME : First Data
MODEL NO.: FD-400GT
TEST SAMPLE : R&D SAMPLE
APPLICANT : XAC AUTOMATION CORP.
TESTED : Aug. 23 to 29, 2011
STANDARDS : **FCC Part 22, Subpart H**
ANSI C63.4-2003

The above equipment (model: FD-400GT) has been tested by **Bureau Veritas Consumer Products Services (H.K.) Ltd., Taoyuan Branch**, and found compliance with the requirement of the above standards. The test record, data evaluation & Equipment Under Test (EUT) configurations represented herein are true and accurate accounts of the measurements of the sample's EMC characteristics under the conditions specified in this report.

PREPARED BY :  , **DATE:** Sep. 05, 2011
(Claire Kuan, Specialist)

APPROVED BY :  , **DATE:** Sep. 05, 2011
(May Chen, Deputy Manager)

2 SUMMARY OF TEST RESULTS

The EUT has been tested according to the following specifications:

APPLIED STANDARD: FCC Part 22 & Part 2			
STANDARD SECTION	TEST TYPE AND LIMIT	RESULT	REMARK
2.1046 22.913 (a)	Maximum Peak Output Power Limit: max. 7 watts e.r.p peak power	PASS	Meet the requirement of limit.
2.1055	Frequency Stability AFC Freq. Error vs. Voltage AFC Freq. Error vs. Temperature Limit: max. ± 2.5 ppm	PASS	Meet the requirement of limit.
2.1049 (h)	Occupied Bandwidth	PASS	Meet the requirement of limit.
22.917	Band Edge Measurements	PASS	Meet the requirement of limit.
2.1051 22.917	Conducted Spurious Emissions	PASS	Meet the requirement of limit.
2.1053 22.917	Radiated Spurious Emissions	PASS	Meet the requirement of limit.

2.1 MEASUREMENT UNCERTAINTY

Where relevant, the following measurement uncertainty levels have been estimated for tests performed on the EUT as specified in CISPR 16-4-2:

This uncertainty represents an expanded uncertainty expressed at approximately the 95% confidence level using a coverage factor of $k=2$.

Measurement	Value
Radiated emissions (30MHz-1GHz)	4 dB
Radiated emissions (1GHz -18GHz)	2.49 dB
Radiated emissions (18GHz -40GHz)	2.70 dB

3 GENERAL INFORMATION

3.1 GENERAL DESCRIPTION OF EUT

PRODUCT	Portable Terminal
MODEL NO.	FD-400GT
FCC ID	MQT-FD400GT
POWER SUPPLY	DC 12V from adapter or DC7.4V from battery
MODULATION TYPE	GMSK, 8PSK (for GPRS / E-GPRS) BPSK (for WCDMA)
OPERATING FREQUENCY	824.2MHz ~ 848.8MHz (for GPRS / E-GPRS) 826.4MHz ~ 846.6MHz (for WCDMA)
NUMBER OF CHANNEL	124 (for GPRS / E-GPRS) 102 (for WCDMA)
MAX. ERP POWER	GPRS Mode: 31.0dBm (1.2589Watts) E-GPRS Mode: 30.9dBm (1.2303Watts) WCDMA Mode: 21.1dBm (0.1288Watts)
ANTENNA TYPE	Please see note
MAX. ANTENNA GAIN	Please see note
DATA CABLE	NA
I/O PORTS	USB port x 1
ACCESSORY DEVICES	Adapter x 1

NOTE:

1. There are RFID, GPRS, WCDMA(UMTS), HSDPA and E-GPRS technology used for the EUT. and the functions of EUT listed as below table:

Function	Report No.
RFID	RF110726E01
2G & 3G (Part 22)	RF110726E01-1
2G & 3G (Part 24)	RF110726E01-2

2. The emission of the simultaneous operation (RFID & GPRS, WCDMA(UMTS), HSDPA and E-GPRS) has been evaluated and no non-compliance found.



A D T

3. The EUT could be supplied with 7.4V battery or power adapter as the following table:

Item	Brand	Model No.	Spec.
Battery	CHENG UEI PRECISION INDUSTRY CO.,LTD	FD400	DC7.4V, 2300mAh(17.02Wh)
Adapter	LITEON	PA-1041-0	AC I/P: 100-240V, 50/60Hz, 0.2A AC input cable: Unshielded, 1.9m DC O/P: 5V, 0.1A DC output cable: Unshielded, 1.55m with one core

4. There are two antennas provided to this EUT, please refer to the following table:

RFID Antenna Spec.					
Brand	Model No.	Antenna Type	Antenna Connector	Gain(dBi)	Frequency range (MHz)
XAC	PCB OSP ANTENNA BOARD FD400 (ROHS)	PCB (2 Layers)	NA	13	13.56
GPRS / WCDMA(UMTS) / HSDPA / E-GPRS Antenna Spec.					
Brand	Model No.	Antenna Type	Antenna Connector	Gain(dBi)	Frequency range (MHz to MHz)
Ethertronics Inc.	T-000084-01	FPCB	NA	1.65	824~894 1850~1990

5. The EUT was pre-tested in chamber under the following modes

Pre-test Mode	Description
Mode A	Battery mode
Mode B	Adapter mode

From the above modes, the worst case was found in **Mode A**. Therefore only the test data of the modes were recorded in this report.

6. The communicated functions of EUT listed as below:

		GPRS/EDGE (850&1900MHz)	WCDMA (850&1900MHz)
2G	GPRS	√	
	EDGE	√	
3G	WCDMA		√
	Release 5 HSDPA		√

7. The above EUT information was declared by manufacturer and for more detailed features description, please refer to the manufacturer's specifications or user's manual.

3.2 DESCRIPTION OF TEST MODES

FOR GPRS & E-GPRS:

124 channels are provided to this EUT. Therefore, the low, middle and high channels are chosen for testing.

	CHANNEL	FREQUENCY	TX MODE
LOW	128	824.2 MHz	GPRS, E-GPRS
MIDDLE	190	836.6 MHz	GPRS, E-GPRS
HIGH	251	848.8 MHz	GPRS, E-GPRS

NOTE:

1. Below 1 GHz, the channel 128, 190, and 251 were pre-tested in chamber. The channel 190 was chosen for final test.
2. Above 1 GHz, the channel 128, 190, and 251 were tested individually.
3. The worst case for final test is chosen when the power control level set 3.
4. The channel space is 0.2MHz.
5. The EUT is a GPRS, E-GPRS class 12 device, which provide 4 up-link. After pre-tested both functions, found up-link with 1 time slot is worse, therefore, test results of output power, frequency stability, occupied bandwidth and band edge tests came out from this.
6. The EUT has GPRS, E-GPRS functions. After pre-testing, GPRS function is the worst case for all the emission tests.



A D T

FOR WCDMA:

102 channels are provided to this EUT. Therefore, the low, middle and high channels are chosen for testing.

	CHANNEL	FREQUENCY	TX MODE
LOW	4132	826.4 MHz	WCDMA, HSDPA
MIDDLE	4182	836.4 MHz	WCDMA, HSDPA
HIGH	4233	846.6 MHz	WCDMA, HSDPA

NOTE:

1. Below 1 GHz, the channel 4132, 4182 and 4233 were pre-tested in chamber. The channel 4182 was chosen for final test.
2. Above 1 GHz, the channel 4132, 4182 and 4233 were tested individually.
3. The channel space is 0.2MHz.
4. The EUT has WCDMA-RMC & HSDPA functions. After pre-testing, WCDMA-RMC function is the worst case for all the emission tests.

3.2.1 TEST MODE APPLICABILITY AND TESTED CHANNEL DETAIL

FOR GPRS, E-GPRS:

EUT CONFIGURE MODE	APPLICABLE TO							DESCRIPTION
	OP	FS	OB	BE	CE	RE<1G	RE ^{>} 1G	
-	√	√	√	√	√	√	√	-

Where

OP: Output power	FS: Frequency stability
OB: Occupied bandwidth	BE: Band edge
CE: Conducted spurious emissions	RE<1G: Radiated emission below 1GHz
RE^{>}1G: Radiated emission above 1GHz	

OUTPUT POWER MEASUREMENT:

- Pre-Scan has been conducted to determine the worst-case mode from all possible combinations between available modulations, data rates, xyz axis and antenna ports (if EUT with antenna diversity architecture).
- Following channel(s) was (were) selected for the final test as listed below.

AVAILABLE CHANNEL	TESTED CHANNEL	MODULATION TECHNOLOGY
128 to 251	128, 190, 251	GPRS, E-GPRS

FREQUENCY STABILITY MEASUREMENT:

- Pre-Scan has been conducted to determine the worst-case mode from all possible combinations between available modulations, data rates, and antenna ports (if EUT with antenna diversity architecture).
- Following channel(s) was (were) selected for the final test as listed below.

AVAILABLE CHANNEL	TESTED CHANNEL	MODULATION TECHNOLOGY
128 to 251	190	GPRS

OCCUPIED BANDWIDTH MEASUREMENT:

- Pre-Scan has been conducted to determine the worst-case mode from all possible combinations between available modulations, data rates, and antenna ports (if EUT with antenna diversity architecture).
- Following channel(s) was (were) selected for the final test as listed below.

AVAILABLE CHANNEL	TESTED CHANNEL	MODULATION TECHNOLOGY
128 to 251	128, 190, 251	GPRS, E-GPRS

BAND EDGE MEASUREMENT:

- Pre-Scan has been conducted to determine the worst-case mode from all possible combinations between available modulations, data rates, and antenna ports (if EUT with antenna diversity architecture).
- Following channel(s) was (were) selected for the final test as listed below.

AVAILABLE CHANNEL	TESTED CHANNEL	MODULATION TECHNOLOGY
128 to 251	128, 251	GPRS, E-GPRS

CONDUCTED SPURIOUS EMISSIONS MEASUREMENT:

- Pre-Scan has been conducted to determine the worst-case mode from all possible combinations between available modulations, data rates, and antenna ports (if EUT with antenna diversity architecture).
- Following channel(s) was (were) selected for the final test as listed below.

AVAILABLE CHANNEL	TESTED CHANNEL	MODULATION TECHNOLOGY
128 to 251	128, 190, 251	GPRS

RADIATED EMISSION MEASUREMENT (BELOW 1 GHz):

- Pre-Scan has been conducted to determine the worst-case mode from all possible combinations between available modulations, data rates, xyz axis and antenna ports (if EUT with antenna diversity architecture).
- Following channel(s) was (were) selected for the final test as listed below.

AVAILABLE CHANNEL	TESTED CHANNEL	MODULATION TECHNOLOGY
128 to 251	190	GPRS

RADIATED EMISSION MEASUREMENT (ABOVE 1 GHz):

- Pre-Scan has been conducted to determine the worst-case mode from all possible combinations between available modulations, data rates, xyz axis and antenna ports (if EUT with antenna diversity architecture).
- Following channel(s) was (were) selected for the final test as listed below.

AVAILABLE CHANNEL	TESTED CHANNEL	MODULATION TECHNOLOGY
128 to 251	128, 190, 251	GPRS

TEST CONDITION:

APPLICABLE TO	ENVIRONMENTAL CONDITIONS	INPUT POWER	TESTED BY
OP	25deg. C, 63%RH	7.4Vdc from battery	Wen Yu
FS	25deg. C, 63%RH	7.4Vdc from battery	Wen Yu
OB	25deg. C, 63%RH	7.4Vdc from battery	Wen Yu
EM	25deg. C, 63%RH	7.4Vdc from battery	Wen Yu
BE	25deg. C, 63%RH	7.4Vdc from battery	Wen Yu
CE	25deg. C, 63%RH	7.4Vdc from battery	Wen Yu
RE < 1G	25deg. C, 63%RH	7.4Vdc from battery	Evan Huang
RE ³ 1G	25deg. C, 63%RH	7.4Vdc from battery	Evan Huang



A D T

FOR WCDMA:

EUT CONFIGURE MODE	APPLICABLE TO							DESCRIPTION
	OP	FS	OB	BE	CE	RE<1G	RE>1G	
-	√	√	√	√	√	√	√	-

Where **OP:** Output power **FS:** Frequency stability
OB: Occupied bandwidth **BE:** Band edge
CE: Conducted spurious emissions **RE<1G:** Radiated emission below 1GHz
RE>1G: Radiated emission above 1GHz

NOTE: Speed mode worst enable during the test

OUTPUT POWER MEASUREMENT:

- Pre-Scan has been conducted to determine the worst-case mode from all possible combinations between available modulations and antenna ports (if EUT with antenna diversity architecture).
- Following channel(s) was (were) selected for the final test as listed below.

AVAILABLE CHANNEL	TESTED CHANNEL	MODULATION TECHNOLOGY
4132 to 4233	4132, 4182, 4233	WCDMA, HSDPA

FREQUENCY STABILITY MEASUREMENT:

- Pre-Scan has been conducted to determine the worst-case mode from all possible combinations between available modulations and antenna ports (if EUT with antenna diversity architecture).
- Following channel(s) was (were) selected for the final test as listed below.

AVAILABLE CHANNEL	TESTED CHANNEL	MODULATION TECHNOLOGY
4132 to 4233	4182	WCDMA

OCCUPIED BANDWIDTH MEASUREMENT:

- This item includes all test value of each mode, but only includes spectrum plot of worst value of each mode.
- Pre-Scan has been conducted to determine the worst-case mode from all possible combinations between available modulations and antenna ports (if EUT with antenna diversity architecture).
- Following channel(s) was (were) selected for the final test as listed below.

AVAILABLE CHANNEL	TESTED CHANNEL	MODULATION TECHNOLOGY
4132 to 4233	4132, 4182, 4233	WCDMA, HSDPA



A D T

BAND EDGE MEASUREMENT:

- Pre-Scan has been conducted to determine the worst-case mode from all possible combinations between available modulations and antenna ports (if EUT with antenna diversity architecture).
- Following channel(s) was (were) selected for the final test as listed below.

AVAILABLE CHANNEL	TESTED CHANNEL	MODULATION TECHNOLOGY
4132 to 4233	4132, 4233	WCDMA, HSDPA

CONDUCTED SPURIOUS EMISSIONS MEASUREMENT:

- Pre-Scan has been conducted to determine the worst-case mode from all possible combinations between available modulations and antenna ports (if EUT with antenna diversity architecture).
- Following channel(s) was (were) selected for the final test as listed below.

AVAILABLE CHANNEL	TESTED CHANNEL	MODULATION TECHNOLOGY
4132 to 4233	4132, 4182, 4233	WCDMA

RADIATED EMISSION MEASUREMENT (BELOW 1 GHz):

- Pre-Scan has been conducted to determine the worst-case mode from all possible combinations between available modulations and antenna ports (if EUT with antenna diversity architecture).
- Following channel(s) was (were) selected for the final test as listed below.

AVAILABLE CHANNEL	TESTED CHANNEL	MODULATION TECHNOLOGY
4132 to 4233	4182	WCDMA

RADIATED EMISSION MEASUREMENT (ABOVE 1 GHz):

- Pre-Scan has been conducted to determine the worst-case mode from all possible combinations between available modulations and antenna ports (if EUT with antenna diversity architecture).
- Following channel(s) was (were) selected for the final test as listed below.

AVAILABLE CHANNEL	TESTED CHANNEL	MODULATION TECHNOLOGY
4132 to 4233	4132, 4182, 4233	WCDMA



A D T

TEST CONDITION:

APPLICABLE TO	ENVIRONMENTAL CONDITIONS	INPUT POWER	TESTED BY
OP	25deg. C, 63%RH	7.4Vdc from battery	Wen Yu
FS	25deg. C, 63%RH	7.4Vdc from battery	Wen Yu
OB	25deg. C, 63%RH	7.4Vdc from battery	Wen Yu
EM	25deg. C, 63%RH	7.4Vdc from battery	Wen Yu
BE	25deg. C, 63%RH	7.4Vdc from battery	Wen Yu
CE	25deg. C, 63%RH	7.4Vdc from battery	Wen Yu
RE < 1G	25deg. C, 63%RH	7.4Vdc from battery	Evan Huang
RE ³ 1G	25deg. C, 63%RH	7.4Vdc from battery	Evan Huang

3.3 GENERAL DESCRIPTION OF APPLIED STANDARDS

The EUT is a RF product. According to the specifications of the manufacturer, it must comply with the requirements of the following standards:

FCC 47 CFR Part 2

FCC 47 CFR Part 22

ANSI C63.4-2003

ANSI/TIA/EIA-603-C 2004

NOTE: All test items have been performed and recorded as per the above standards.

3.4 DESCRIPTION OF SUPPORT UNITS

The EUT has been tested as an independent unit together with other necessary accessories or support units. The following support units or accessories were used to form a representative test configuration during the tests.

NO.	PRODUCT	BRAND	MODEL NO.	SERIAL NO.	FCC ID
1	iPod	Apple	MC749TA/A	CC4DMFJUDFDM	FCC DoC
2	Universal Radio Communication Tester	R&S	CMU200	1100.0008.02	NA

NO.	SIGNAL CABLE DESCRIPTION OF THE ABOVE SUPPORT UNITS
1	5cm, USB Cable.
2	NA

NOTE: All power cords of the above support units are non shielded (1.8m).

3.5 CONFIGURATION OF SYSTEM UNDER TEST

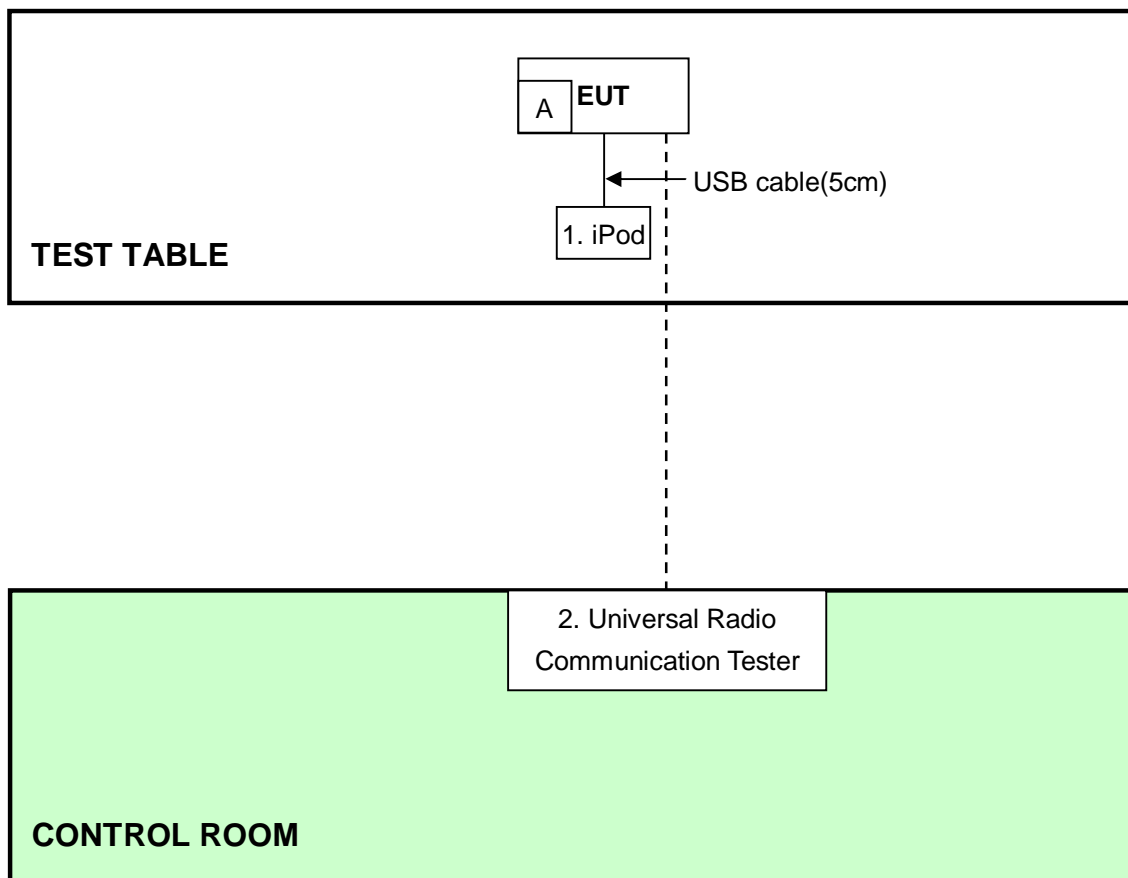

Note: The item A is battery.

4 TEST TYPES AND RESULTS

4.1 OUTPUT POWER MEASUREMENT

4.1.1 LIMITS OF OUTPUT POWER MEASUREMENT

The radiated output power shall be according to the specific rule Part 22.913 (a) that “Mobile / Portable station are limited to 7 watts e.r.p”.



A D T

4.1.2 TEST INSTRUMENTS

Test date: Aug. 23, 2011

DESCRIPTION & MANUFACTURER	MODEL NO.	SERIAL NO.	CALIBRATED DATE	CALIBRATED UNTIL
ROHDE & SCHWARZ Spectrum Analyzer	FSP40	100036	Dec. 08, 2010	Dec. 07, 2011
Agilent PSA Spectrum Analyzer	E4446A	MY48250113	Nov. 30, 2010	Nov. 29, 2011
HP Pre_Amplifier	8449B	300801923	Nov. 01, 2010	Oct. 31, 2011
ROHDE & SCHWARZ Test Receiver	ESCS30	847124/029	Sep. 03, 2010	Sep. 02, 2011
SCHWARZBECK TRILOG Broadband Antenna	VULB 9168	138	Apr. 14, 2011	Apr. 13, 2012
Schwarzbeck Horn_Antenna	BBHA9120	D124	Dec. 17, 2010	Dec. 16, 2011
Schwarzbeck Horn_Antenna	BBHA 9170	BBHA9170153	Jan. 17, 2011	Jan. 16, 2012
RF Switches	EMH-011	1001	NA	NA
RF CABLE (Chaintek)	Sucoflex 106	RF106-102	Jan. 27, 2011	Jan. 26, 2012
RF Cable	8DFB	STCCAB-30M-1GHz	NA	NA
Software	ADT_Radiated_V7.6.15.9.2	NA	NA	NA
CT Antenna Tower & Turn Table	NA	NA	NA	NA
Agilent signal generator	E8257C	MY43321031	Aug. 23, 2011	Aug. 22, 2012

- Note: 1. The calibration interval of the above test instruments is 12 months and the calibrations are traceable to NML/ROC and NIST/USA.
2. The horn antenna, preamplifier (model: 8449B) and Spectrum Analyzer (model: FSP40) are used only for the measurement of emission frequency above 1GHz if tested.
3. The test was performed in Open Site No. C.
4. The FCC Site Registration No. is 656396.
5. The VCCI Site Registration No. is R-1626.
6. The CANADA Site Registration No. is IC 7450G-3.

4.1.3 TEST PROCEDURES

- a. The power was measured with R&S Spectrum Analyzer. All measurements were done at 3 channels, 128, 190 and 251 (GPRS & E-GPRS) / 4132, 4182 and 4233 (WCDMA) (low, middle and high operational frequency range.)
- b. The conducted output power used the power splitter via EUT RF power connector between simulation base station and spectrum analyzer. The path loss included the splitter loss, cable loss and 20dB pad loss. The spectrum set RB/VB 1MHz (GPRS & E-GPRS) and 5MHz (WCDMA), then read power value and record to the test. (All transmitted path loss shall be considered in the test report data.)
- c. Substitution method is used for E.I.R.P measurement. In the semi-anechoic chamber, EUT placed on the 0.8m height of Turn Table, rotated the table around 360 degrees to search the maximum radiation power and receiver antenna shall be rotated vertical and horizontal polarization and moved height from 1m to 4m to find the maximum polar radiated power. The “Read Value” is the spectrum reading the maximum power value.
- d. The substitution horn antenna is substituted for EUT at the same position and signals generator export the CW signal to the substitution antenna via a tx cable . Rotated the Turn Table and moved receiving antenna to find the maximum radiation power. Adjust output power level of S.G to get a Value of spectrum reading equal to “Read Value “ of step c. Record the power level of S.G
- e. $EIRP = \text{Output power level of S.G} - \text{TX cable loss} + \text{Antenna gain of substitution horn.}$
- f. ERP power can be calculated form EIRP power by subtracting the gain of dipole,
 $ERP \text{ power} = EIPR \text{ power} - 2.15\text{dBi.}$

4.1.4 TEST SETUP

EIRP POWER MEASUREMENT:

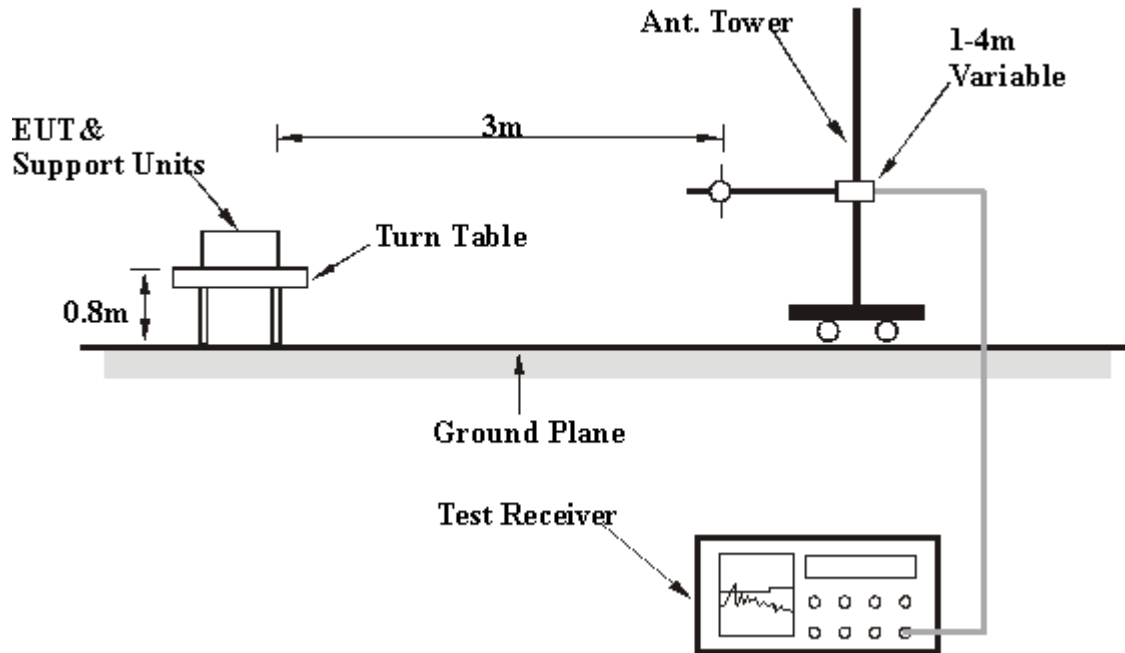

For the actual test configuration, please refer to the attached file (Test Setup Photo).

CONDUCTED POWER MEASUREMENT:

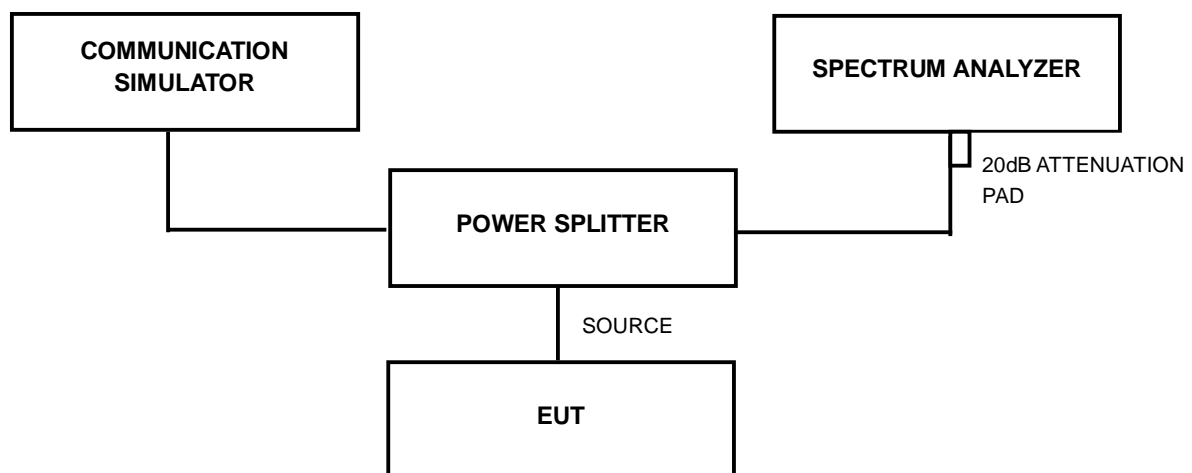

For the actual test configuration, please refer to the related item – Photographs of the Test Configuration.



A D T

4.1.5 EUT OPERATING CONDITIONS

- a. The EUT makes a call to the communication simulator.
- b. The communication simulator station system controlled a EUT to export maximum output power under transmission mode and specific channel frequency.



A D T

4.1.6 TEST RESULTS

FOR GPRS & E-GPRS:

GPRS MODE

CONDUCTED OUTPUT POWER					
CHANNEL NO.	FREQUENCY (MHz)	RAW VALUE (dBm)	CORRECTION FACTOR (dB)	OUTPUT POWER	
				dBm	mW
128	824.2	29.9	2.40	32.3	1698.2
190	836.6	30.0	2.40	32.4	1737.8
251	848.8	29.7	2.40	32.1	1621.8

REMARKS: 1. Peak Output Power (dBm) = Raw Value (dBm) + Correction Factor (dB).
2. Correction Factor (dB) = Power Splitter Loss (dB) + Cable Loss (dB) + 20dB Pad.

E-GPRS MODE

CONDUCTED OUTPUT POWER					
CHANNEL NO.	FREQUENCY (MHz)	RAW VALUE (dBm)	CORRECTION FACTOR (dB)	OUTPUT POWER	
				dBm	mW
128	824.2	29.9	2.4	32.3	1698.2
190	836.6	30.0	2.4	32.4	1737.8
251	848.8	29.6	2.4	32.0	1584.9

REMARKS: 1. Peak Output Power (dBm) = Raw Value (dBm) + Correction Factor (dB).
2. Correction Factor (dB) = Power Splitter Loss (dB) + Cable Loss (dB) + 20dB Pad.



A D T

GPRS MODE

ERP POWER					
CHANNEL NO.	FREQUENCY (MHz)	S.G VALUE (dBm)	CORRECTION FACTOR (dB)	OUTPUT POWER	
				dBm	mW
128	824.2	29.6	1.3	30.9	1230.3
190	836.6	29.8	1.2	31.0	1258.9
251	848.8	29.6	1.0	30.6	1148.2

REMARKS: 1. Peak Output Power (dBm) = S.G Value (dBm) + Correction Factor (dB).
2. Correction Factor (dB) = substitution Antenna Gain (dBi) + Cable Loss (dB) + Free Space Loss (dB).

E-GPRS MODE

ERP POWER					
CHANNEL NO.	FREQUENCY (MHz)	S.G VALUE (dBm)	CORRECTION FACTOR (dB)	OUTPUT POWER	
				dBm	mW
128	824.2	29.5	1.3	30.8	1202.3
190	836.6	29.7	1.2	30.9	1230.3
251	848.8	29.5	1.0	30.5	1122.0

REMARKS: 1. Peak Output Power (dBm) = S.G Value (dBm) + Correction Factor (dB).
2. Correction Factor (dB) = substitution Antenna Gain (dBi) + Cable Loss (dB) + Free Space Loss (dB).



A D T

FOR WCDMA:**WCDMA-RMC MODE**

CONDUCTED OUTPUT POWER					
CHANNEL NO.	FREQUENCY (MHz)	RAW VALUE (dBm)	CORRECTION FACTOR (dB)	OUTPUT POWER	
				dBm	mW
4132	826.4	19.4	2.4	21.8	151.4
4182	836.4	20.3	2.4	22.7	186.2
4233	846.6	19.6	2.4	22.0	158.5

REMARKS: 1. Peak Output Power (dBm) = Raw Value (dBm) + Correction Factor (dB).
2. Correction Factor (dB) = Power Splitter Loss (dB) + Cable Loss (dB) + 20dB Pad.

HSDPA-RMC

CONDUCTED OUTPUT POWER					
CHANNEL NO.	FREQUENCY (MHz)	RAW VALUE (dBm)	CORRECTION FACTOR (dB)	OUTPUT POWER	
				dBm	mW
4132	826.4	19.2	2.4	21.6	144.5
4182	836.4	20.1	2.4	22.5	177.8
4233	846.6	19.4	2.4	21.8	151.4

REMARKS: 1. Peak Output Power (dBm) = Raw Value (dBm) + Correction Factor (dB).
2. Correction Factor (dB) = Power Splitter Loss (dB) + Cable Loss (dB) + 20dB Pad.

HSDPA MODE- Subtest 1

CONDUCTED OUTPUT POWER					
CHANNEL NO.	FREQUENCY (MHz)	RAW VALUE (dBm)	CORRECTION FACTOR (dB)	OUTPUT POWER	
				dBm	mW
4132	826.4	19.2	2.4	21.6	144.5
4182	836.4	20.1	2.4	22.5	177.8
4233	846.6	19.3	2.4	21.7	147.9

REMARKS: 1. Peak Output Power (dBm) = Raw Value (dBm) + Correction Factor (dB).
2. Correction Factor (dB) = Power Splitter Loss (dB) + Cable Loss (dB) + 20dB Pad.



A D T

HSDPA MODE- Subtest 2

CONDUCTED OUTPUT POWER					
CHANNEL NO.	FREQUENCY (MHz)	RAW VALUE (dBm)	CORRECTION FACTOR (dB)	OUTPUT POWER	
				dBm	mW
4132	826.4	19.1	2.4	21.5	141.3
4182	836.4	20.0	2.4	22.4	173.8
4233	846.6	19.3	2.4	21.7	147.9

REMARKS: 1. Peak Output Power (dBm) = Raw Value (dBm) + Correction Factor (dB).
2. Correction Factor (dB) = Power Splitter Loss (dB) + Cable Loss (dB) + 20dB Pad.

HSDPA MODE- Subtest 3

CONDUCTED OUTPUT POWER					
CHANNEL NO.	FREQUENCY (MHz)	RAW VALUE (dBm)	CORRECTION FACTOR (dB)	OUTPUT POWER	
				dBm	mW
4132	826.4	19.0	2.4	21.4	138.0
4182	836.4	20.0	2.4	22.4	173.8
4233	846.6	19.3	2.4	21.7	147.9

REMARKS: 1. Peak Output Power (dBm) = Raw Value (dBm) + Correction Factor (dB).
2. Correction Factor (dB) = Power Splitter Loss (dB) + Cable Loss (dB) + 20dB Pad.

HSDPA MODE- Subtest 4

CONDUCTED OUTPUT POWER					
CHANNEL NO.	FREQUENCY (MHz)	RAW VALUE (dBm)	CORRECTION FACTOR (dB)	OUTPUT POWER	
				dBm	mW
4132	826.4	19.0	2.4	21.4	138.0
4182	836.4	19.9	2.4	22.3	169.8
4233	846.6	19.2	2.4	21.6	144.5

REMARKS: 1. Peak Output Power (dBm) = Raw Value (dBm) + Correction Factor (dB).
2. Correction Factor (dB) = Power Splitter Loss (dB) + Cable Loss (dB) + 20dB Pad.



A D T

WCDMA-RMC MODE

ERP POWER					
CHANNEL NO.	FREQUENCY (MHz)	S.G VALUE (dBm)	CORRECTION FACTOR (dB)	OUTPUT POWER	
				dBm	mW
4132	826.4	19.2	1.3	20.5	112.2
4182	836.4	19.9	1.2	21.1	128.8
4233	846.6	19.4	1.1	20.5	112.2

REMARKS: 1. Peak Output Power (dBm) = S.G Value (dBm) + Correction Factor (dB).
2. Correction Factor (dB) = substitution Antenna Gain (dBi) + Cable Loss (dB) + Free Space Loss (dB).

HSDPA MODE

ERP POWER					
CHANNEL NO.	FREQUENCY (MHz)	S.G VALUE (dBm)	CORRECTION FACTOR (dB)	OUTPUT POWER	
				dBm	mW
4132	826.4	19.0	1.3	20.3	107.2
4182	836.4	19.7	1.2	20.9	123.0
4233	846.6	19.3	1.1	20.4	109.6

REMARKS: 1. Peak Output Power (dBm) = S.G Value (dBm) + Correction Factor (dB).
2. Correction Factor (dB) = substitution Antenna Gain (dBi) + Cable Loss (dB) + Free Space Loss (dB).

4.2 FREQUENCY STABILITY MEASUREMENT

4.2.1 LIMITS OF FREQUENCY STABILITY MEASUREMENT

According to the FCC part 22.863 shall be tested the frequency stability. The rule is defined that” The frequency stability shall be sufficient to ensure that the fundamental emission stays within the authorized frequency block.” The frequency error rate is according to the JTC standard that the frequency error rate shall be accurate to within 2.5ppm of the received frequency from the base station. The test extreme voltage is according to the 2.1055(d)(1) Vary primary supply voltage from 85 to 115 percent of the nominal value for other than hand carried battery equipment and the extreme temperature rule is comply with the 2.1055(a)(1) $-30^{\circ}\text{C} \sim 50^{\circ}\text{C}$.

4.2.2 TEST INSTRUMENTS

Test date: Aug. 23, 2011

DESCRIPTION & MANUFACTURER	MODEL NO.	SERIAL NO.	CALIBRATED DATE	CALIBRATED UNTIL
R&S SPECTRUM ANALYZER	FSP40	100037	Sep. 08, 2010	Sep. 07, 2011
OVEN	MHU-225AU	911033	Dec. 17, 2010	Dec. 16, 2011
HUBER+SUHNER	SUCOFLEX104	222686/4	Jan. 10, 2011	Jan. 09, 2012
AC POWER SOURCE	6205	1140503	NA	NA

NOTE: The calibration interval of the above test instruments is 12 months. And the calibrations are traceable to NML/ROC and NIST/USA.

4.2.3 TEST PROCEDURE

- a. Because of the measure the carrier frequency under the condition of the AFC lock, it shall be used the mobile station in the GPRS/WCDMA link mode. This is accomplished with the use of the R&S CMU200 simulator station. The oven room could control the temperatures and humidity. The GPRS link channel is the 190 and the WCDMA link channel is the 4182.
- b. Power must be removed when changing from one temperature to another or one voltage to another voltage. Power warm up is at least 15 min and power applied should perform before recording frequency error.
- c. EUT is connected the external power supply to control the AC input power. The various Volts from the minimum 102 Volts to 138 Volts. Each step shall be record the frequency error rate.
- d. The temperature range step is 10 degrees in this test items. All temperature levels shall be hold the $\pm 0.5^{\circ}\text{C}$ during the measurement testing.
- e. The each temperature step shall be at least 0.5 hours, consider the EUT could be test under the stability condition.

4.2.4 TEST SETUP

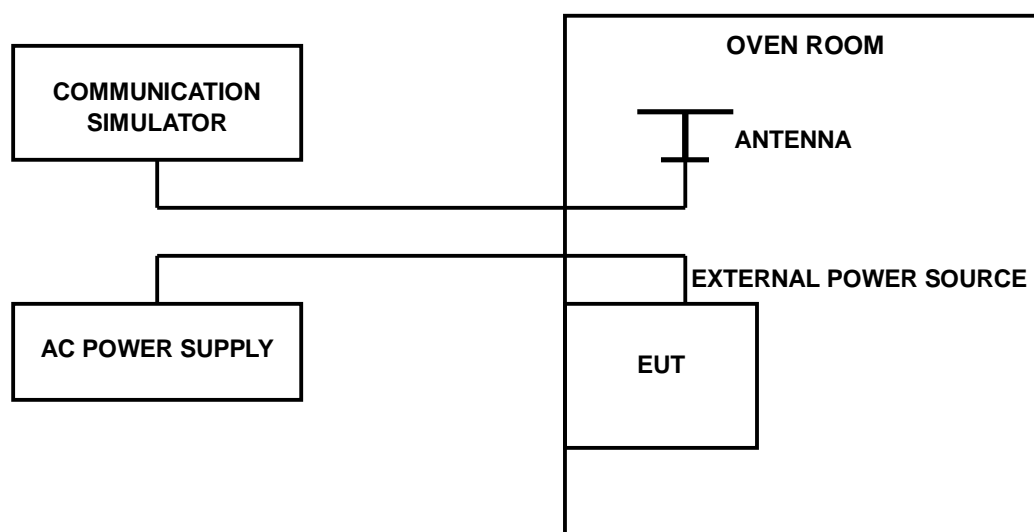



A D T

4.2.5 TEST RESULTS

FOR GPRS:

AFC FREQUENCY ERROR vs. VOLTAGE			
VOLTAGE (Volts)	FREQUENCY ERROR (Hz)	FREQUENCY ERROR (ppm)	LIMIT (ppm)
102	-40	-0.048	2.5
138	-44	-0.053	2.5

AFC FREQUENCY ERROR vs. TEMP.			
TEMP. (°C)	FREQUENCY ERROR (Hz)	FREQUENCY ERROR (ppm)	LIMIT (ppm)
50	-56	-0.067	2.5
40	-48	-0.057	2.5
30	-43	-0.051	2.5
20	-44	-0.053	2.5
10	-42	-0.050	2.5
0	-38	-0.045	2.5
-10	-39	-0.047	2.5
-20	-42	-0.050	2.5
-30	-51	-0.061	2.5



A D T

FOR WCDMA:

AFC FREQUENCY ERROR vs. VOLTAGE			
VOLTAGE (Volts)	FREQUENCY ERROR (Hz)	FREQUENCY ERROR (ppm)	LIMIT (ppm)
102	22	0.026	2.5
138	26	0.031	2.5

AFC FREQUENCY ERROR vs. TEMP.			
TEMP. (°C)	FREQUENCY ERROR (Hz)	FREQUENCY ERROR (ppm)	LIMIT (ppm)
50	33	0.039	2.5
40	31	0.037	2.5
30	30	0.036	2.5
20	25	0.030	2.5
10	26	0.031	2.5
0	28	0.033	2.5
-10	32	0.038	2.5
-20	36	0.043	2.5
-30	39	0.047	2.5



4.3 OCCUPIED BANDWIDTH MEASUREMENT

4.3.1 LIMITS OF OCCUPIED BANDWIDTH MEASUREMENT

According to FCC 2.1049 (h) specified that emission bandwidth is defined as the width of the signal between two points, one below the carrier center frequency and one above the carrier center frequency, outside of which all emissions are attenuated at least 26 dB below the transmitter power.

4.3.2 TEST INSTRUMENTS

Test date: Aug. 23, 2011

DESCRIPTION & MANUFACTURER	MODEL NO.	SERIAL NO.	CALIBRATED DATE	CALIBRATED UNTIL
R&S SPECTRUM ANALYZER	FSP40	100037	Sep. 08, 2010	Sep. 07, 2011
OVEN	MHU-225AU	911033	Dec. 17, 2010	Dec. 16, 2011
HUBER+SUHNER	SUCOFLEX104	222686/4	Jan. 10, 2011	Jan. 09, 2012
AC POWER SOURCE	6205	1140503	NA	NA

NOTE: The calibration interval of the above test instruments is 12 months. And the calibrations are traceable to NML/ROC and NIST/USA.

4.3.3 TEST SETUP

Same as Item 4.2.4 (Conducted Power Setup)

4.3.4 TEST PROCEDURES

- a. The EUT makes a call to the communication simulator. The power was measured with R&S Spectrum Analyzer. All measurements were done at 3 channels, 128, 190 and 251 (GPRS & E-GPRS) / 4132, 4182 and 4233 (WCDMA & HSDPA) (low, middle and high operational frequency range.)
- b. The conducted occupied bandwidth used the power splitter via EUT RF power connector between simulation base station and spectrum analyzer.
- c. The communication simulator station system controlled a EUT to export maximum output power under transmission mode and specific channel frequency. Use OBW measurement function of Spectrum analyzer to measure 99 % occupied bandwidth.

4.3.5 EUT OPERATING CONDITION

Same as Item 4.1.5



A D T

4.3.6 TEST RESULTS

FOR GPRS & E-GPRS:

GPRS MODE

CHANNEL	FREQUENCY (MHz)	99% OCCUPIED BANDWIDTH (kHz)
128	824.2	244.0
190	836.6	248.0
251	848.8	246.0

CH 190

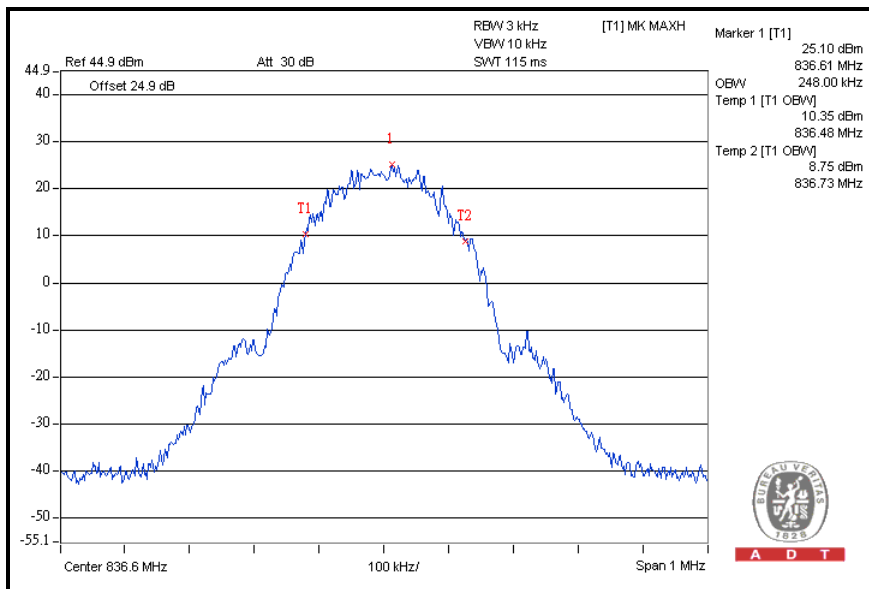



A D T

E-GPRS MODE

CHANNEL	FREQUENCY (MHz)	99% OCCUPIED BANDWIDTH (kHz)
128	824.2	244.0
190	836.6	244.0
251	848.8	248.0

CH 251

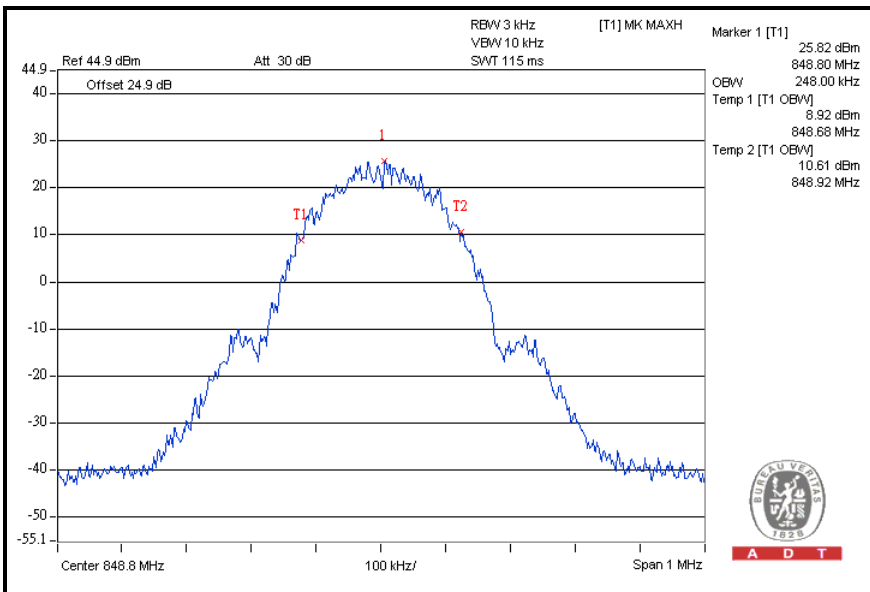



A D T

FOR WCDMA:

WCDMA:

CHANNEL	FREQUENCY (MHz)	99% OCCUPIED BANDWIDTH (MHz)
4132	826.4	4.18
4182	836.4	4.20
4233	846.6	4.20

CH 4182

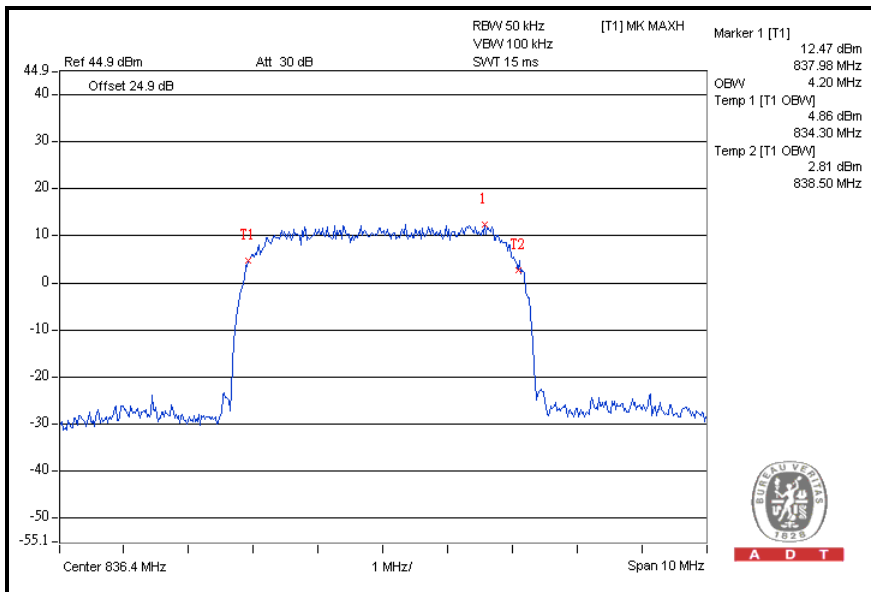

A D T



A D T

HSDPA:

CHANNEL	FREQUENCY (MHz)	99% OCCUPIED BANDWIDTH (MHz)
4132	826.4	4.18
4182	836.4	4.18
4233	846.6	4.18

CH 4182

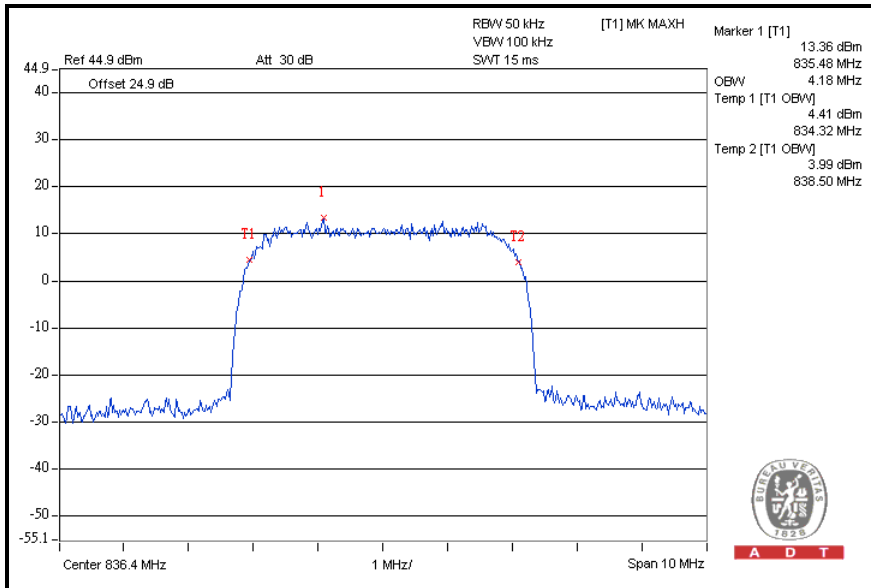

4.4 BAND EDGE MEASUREMENT

4.4.1 LIMITS OF BAND EDGE MEASUREMENT

According to FCC 22.917 specified that power of any emission outside of the authorized operating frequency ranges must be attenuated below the transmitting power (P) by a factor of at least $43 + 10 \log(P)$ dB. In the 1 MHz bands immediately outside and adjacent to the frequency block a resolution bandwidth of at least one percent of the emission bandwidth of the fundamental emission of the transmitter may be employed.

4.4.2 TEST INSTRUMENTS

Test date: Aug. 23, 2011

DESCRIPTION & MANUFACTURER	MODEL NO.	SERIAL NO.	CALIBRATED DATE	CALIBRATED UNTIL
R&S SPECTRUM ANALYZER	FSP40	100037	Sep. 08, 2010	Sep. 07, 2011
OVEN	MHU-225AU	911033	Dec. 17, 2010	Dec. 16, 2011
HUBER+SUHNER	SUCOFLEX104	222686/4	Jan. 10, 2011	Jan. 09, 2012
AC POWER SOURCE	6205	1140503	NA	NA

NOTE: The calibration interval of the above test instruments is 12 months. And the calibrations are traceable to NML/ROC and NIST/USA.

4.4.3 TEST SETUP

Same as Item 4.2.4 (Conducted Power Setup)

4.4.4 TEST PROCEDURES

- a. The EUT makes a call to the communication simulator. The power was measured with R&S Spectrum Analyzer. All measurements were done at 2 channels, 128 and 251 (GPRS & E-GPRS) /4132 and 4233 (WCDMA & HSDPA) (low and high operational frequency range.)
- b. The band edge measurement used the power splitter via EUT RF power connector between simulation base station and spectrum analyzer.
- c. The center frequency of spectrum is the band edge frequency and span is 1.5 MHz. RB of the spectrum is 3kHz and VB of the spectrum is 10kHz (GPRS/ E-GPRS).
- d. The center frequency of spectrum is the band edge frequency and span is 10MHz. RB of the spectrum is 100kHz and VB of the spectrum is 300kHz (WCDMA).

4.4.5 EUT OPERATING CONDITION

Same as Item 4.1.5



A D T

4.4.6 TEST RESULTS

FOR GPRS / E-GPRS:

GPRS MODE

LOWER BAND EDGE

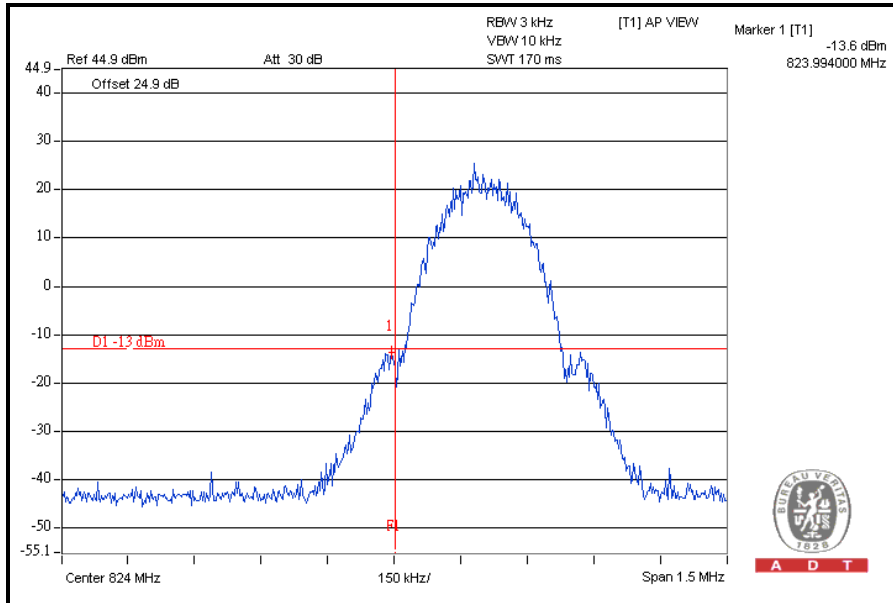

HIGHER BAND EDGE

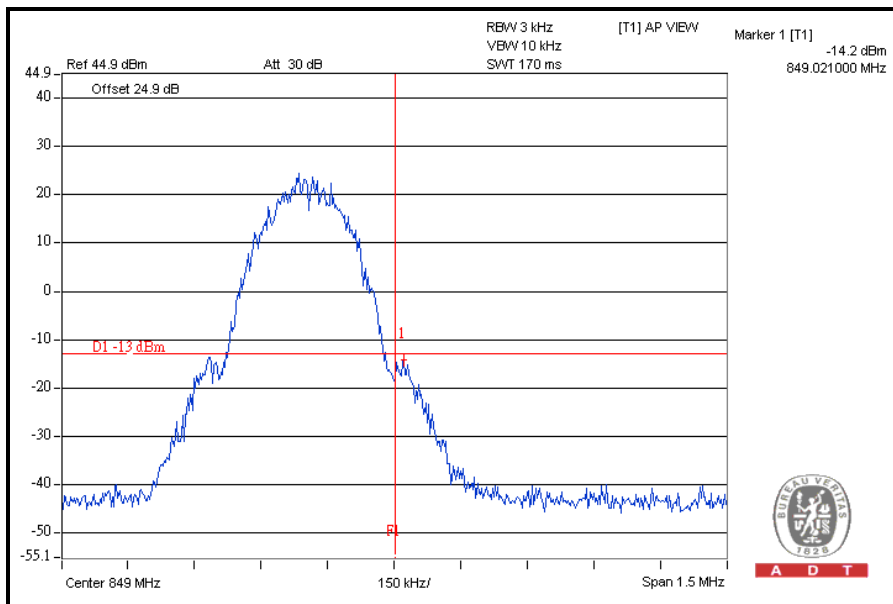



A D T

E-GPRS MODE

LOWER BAND EDGE

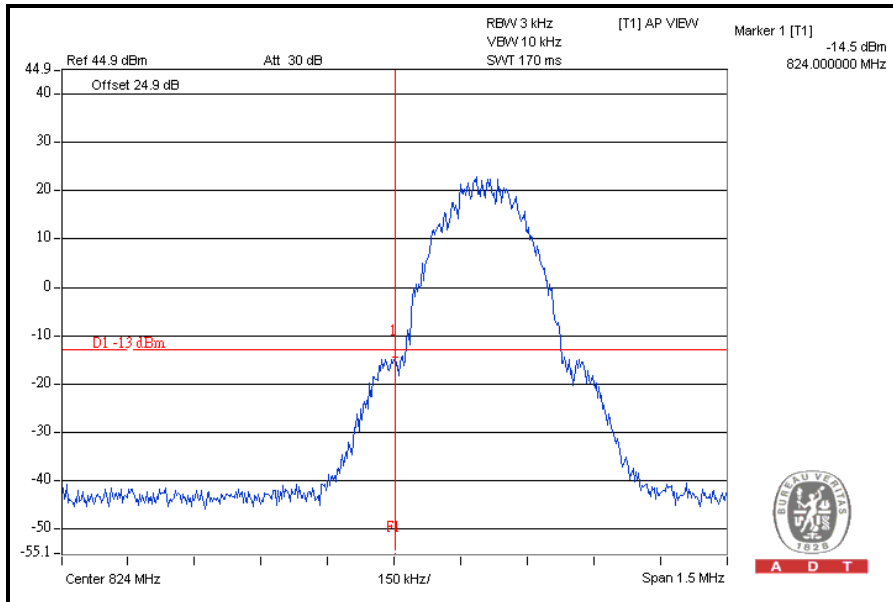

HIGHER BAND EDGE

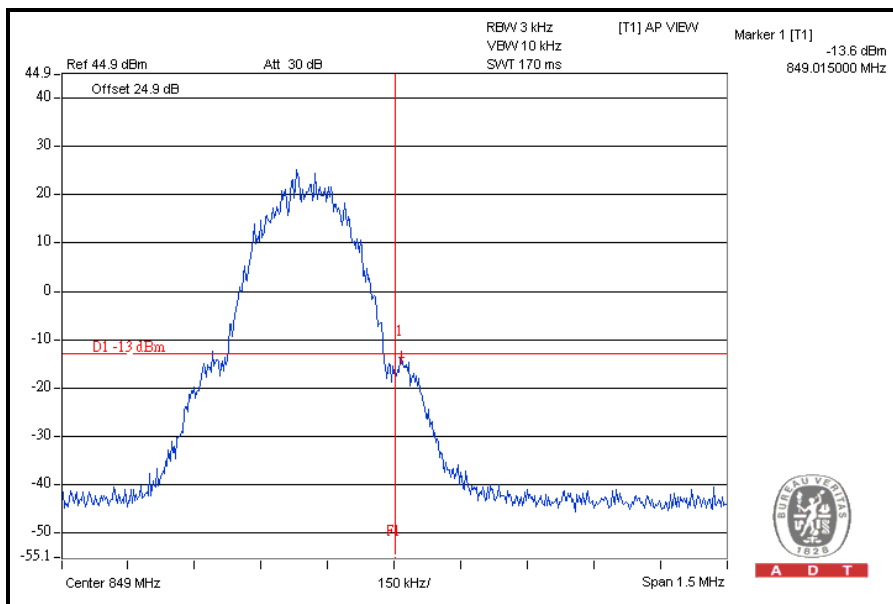



A D T

FOR WCDMA:

WCDMA MODE

LOWER BAND EDGE

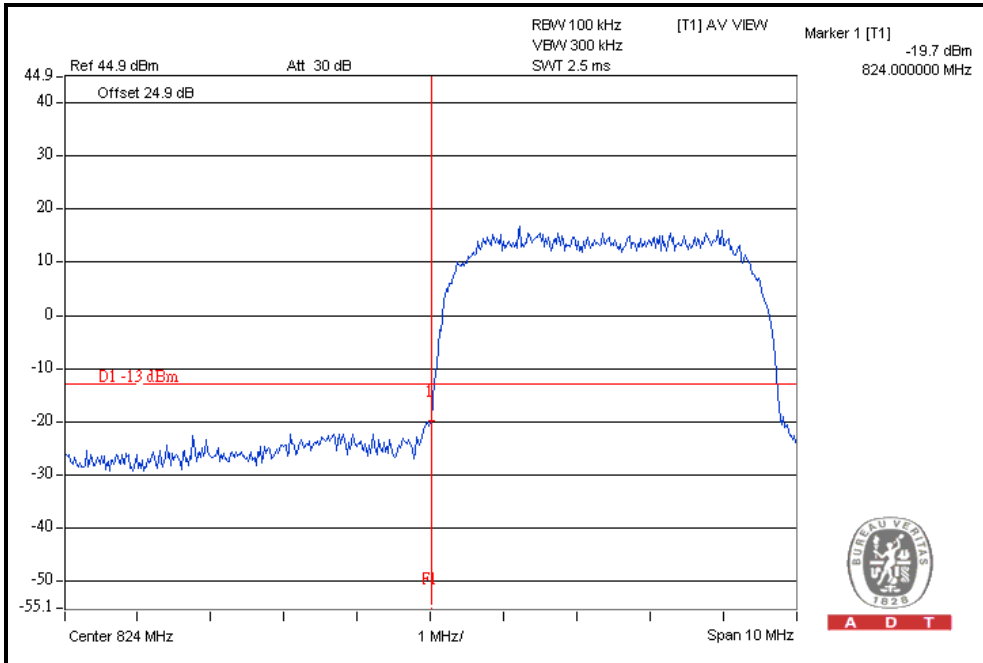

HIGHER BAND EDGE

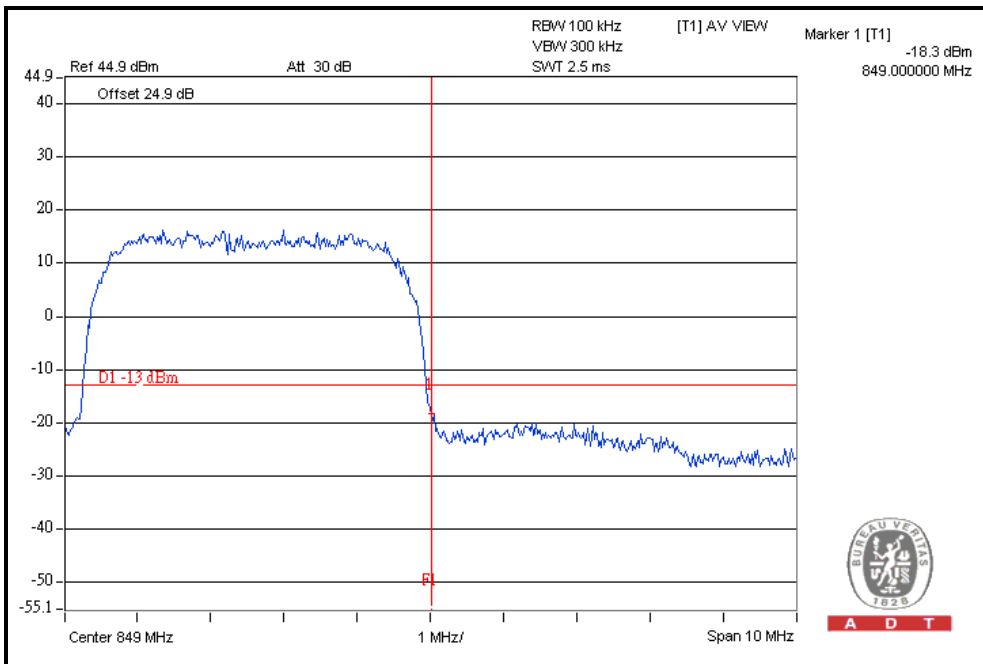



A D T

HSDPA MODE

LOWER BAND EDGE

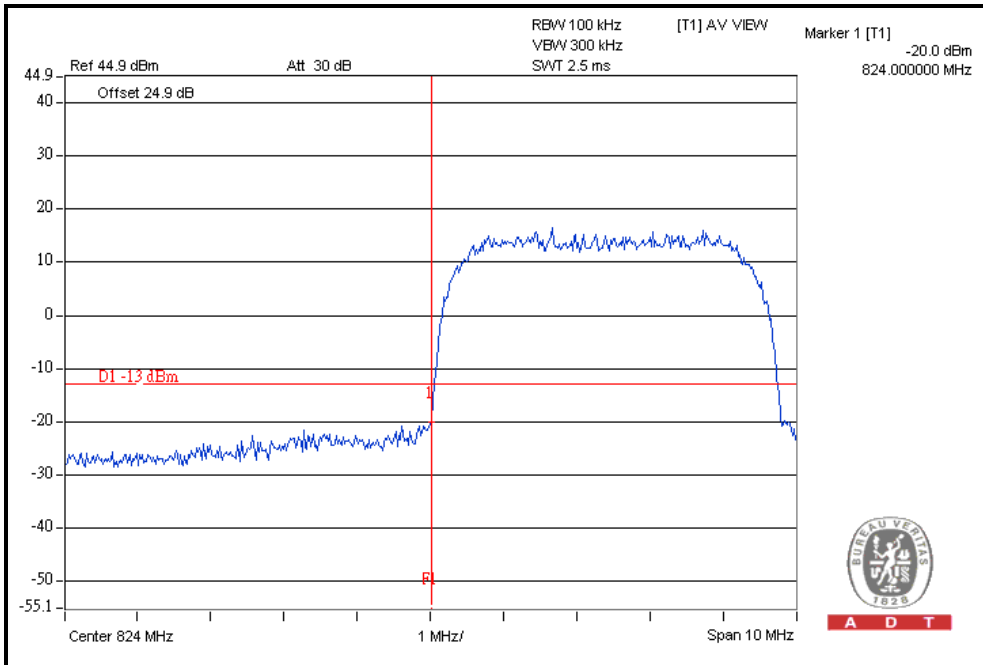

HIGHER BAND EDGE

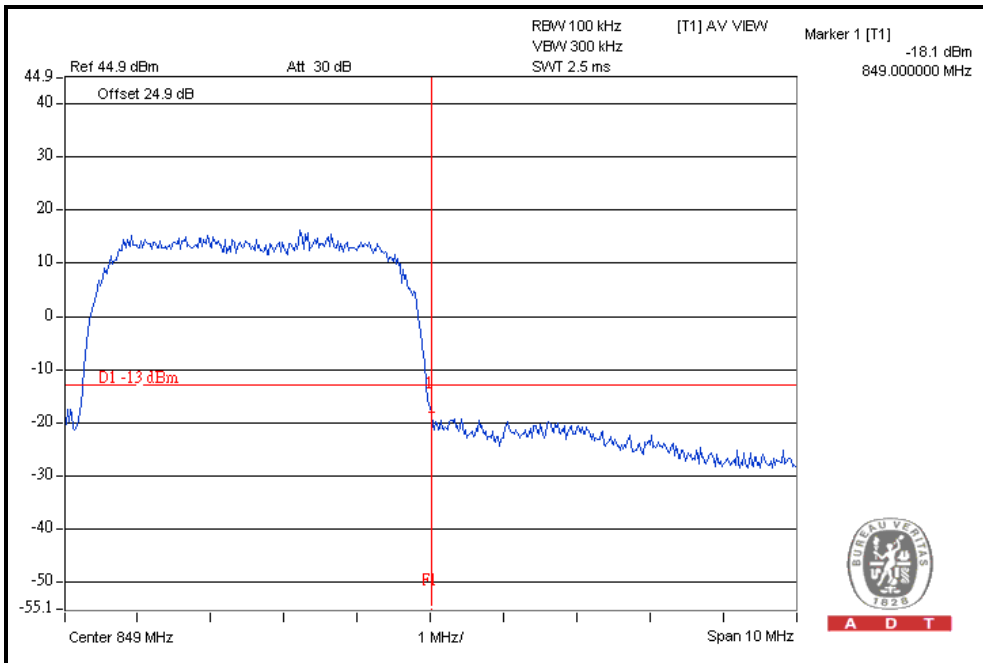



A D T

4.5 CONDUCTED SPURIOUS EMISSIONS

4.5.1 LIMITS OF CONDUCTED SPURIOUS EMISSIONS MEASUREMENT

In the FCC 22.917(a), the power of any emission outside of the authorized operating frequency ranges must be attenuated below the transmitting power (P) by at least $43 + 10 \log (P)$ dB. The limit of emission equal to -13dBm .

4.5.2 TEST INSTRUMENTS

Test date: Aug. 23, 2011

DESCRIPTION & MANUFACTURER	MODEL NO.	SERIAL NO.	CALIBRATED DATE	CALIBRATED UNTIL
R&S SPECTRUM ANALYZER	FSP40	100037	Sep. 08, 2010	Sep. 07, 2011
OVEN	MHU-225AU	911033	Dec. 17, 2010	Dec. 16, 2011
HUBER+SUHNER	SUCOFLEX104	222686/4	Jan. 10, 2011	Jan. 09, 2012
AC POWER SOURCE	6205	1140503	NA	NA
Wainwright Instruments Band Reject Filter	WRCG1850/191 0-1830/1930-60/ 10SS	SN1	NA	NA
* Wainwright Instruments High Pass Filter	WHK3.1/18G-10 SS	SN1	NA	NA

NOTE: The calibration interval of the above test instruments is 12 months. And the calibrations are traceable to NML/ROC and NIST/USA.

4.5.3 TEST PROCEDURE

- a. The EUT makes a phone call to the communication simulator. The power was measured with R&S Spectrum Analyzer. All measurements were done at 3 channels, 128, 190 and 251 (GPRS) / 4132, 4182 and 4233 (WCDMA) (low, middle and high operational frequency range.)
- b. The conducted spurious emission used the power splitter via EUT RF power connector between simulation base station and spectrum analyzer. This splitter loss and cable loss are the worst loss 6dB in the transmitted path track.
- c. When the spectrum scanned from 9kHz to 1GHz, it shall be connected to the band reject filter attenuated the carried frequency. The spectrum set RB=1MHz, VB=3MHz.
- d. When the spectrum scanned from 1GHz to 9GHz, it shall be connected to the high pass filter attenuated the carried frequency. The spectrum set RB=1MHz, VB=3MHz.

4.5.4 TEST SETUP

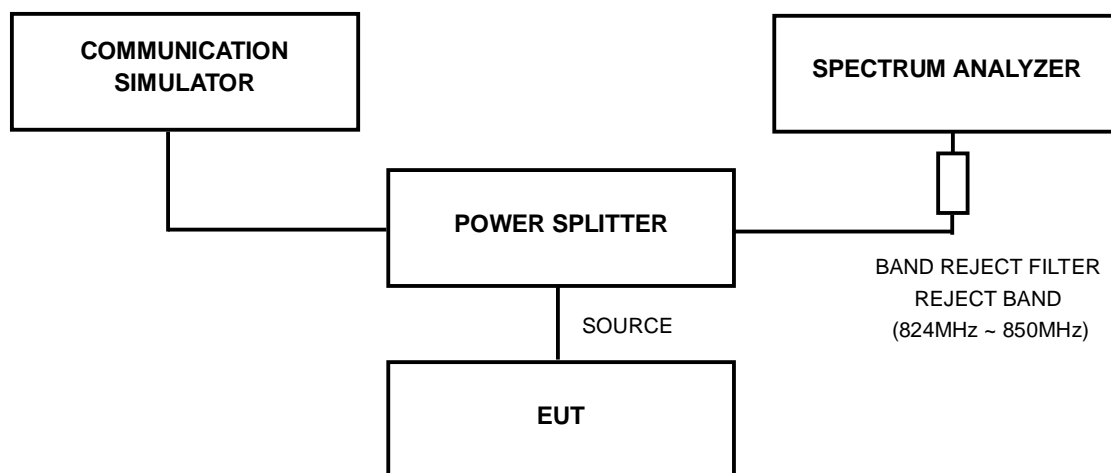

4.5.5 EUT OPERATING CONDITIONS

Same as Item 4.1.5

4.5.6 TEST RESULTS

FOR GPRS:

CH 128: 9kHz ~ 1GHz

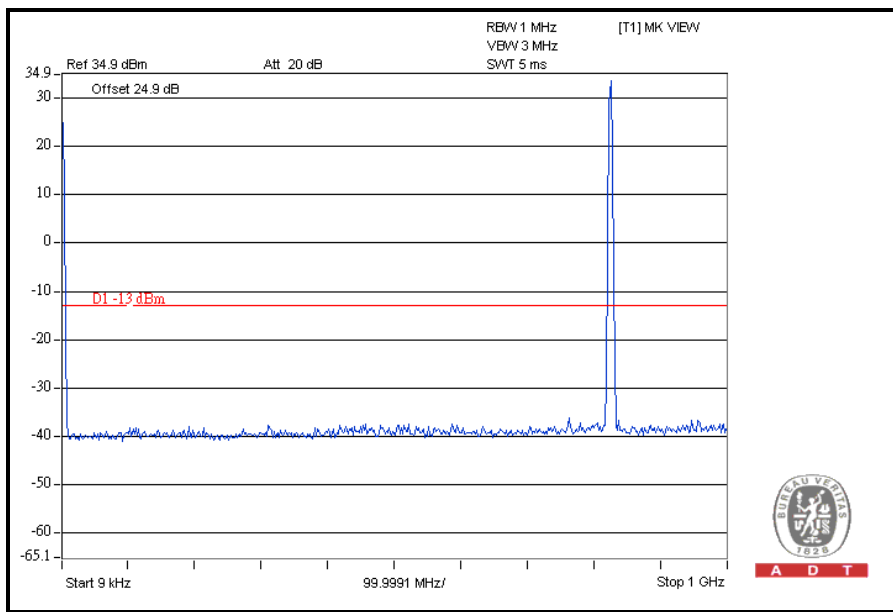

1GHz ~ 4GHz

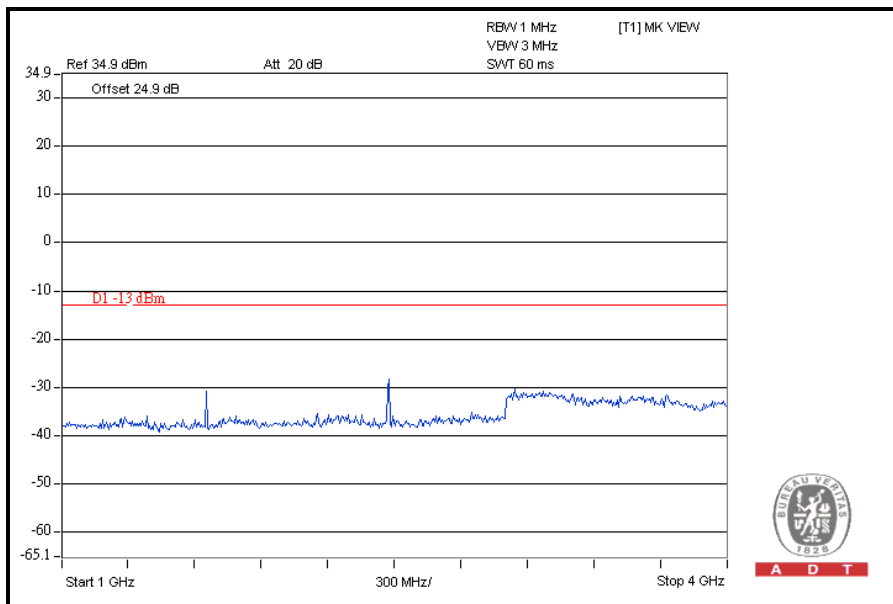



A D T

4GHz ~ 9GHz

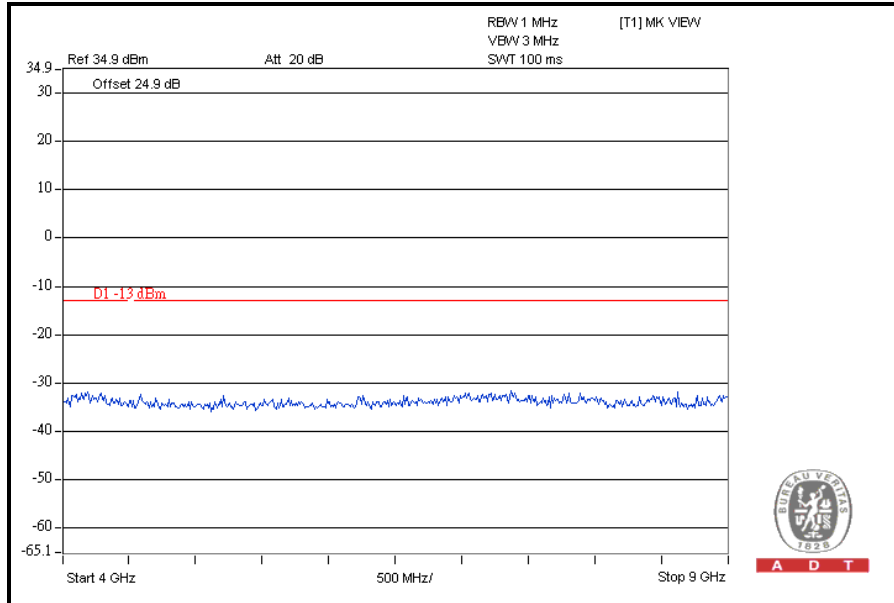



A D T

CH 190: 9kHz ~ 1GHz

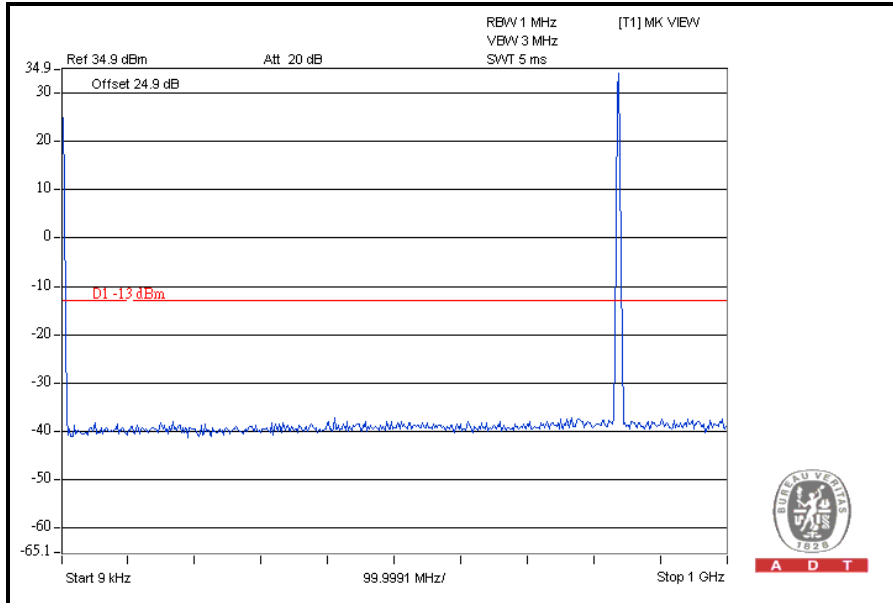

1GHz ~ 4GHz

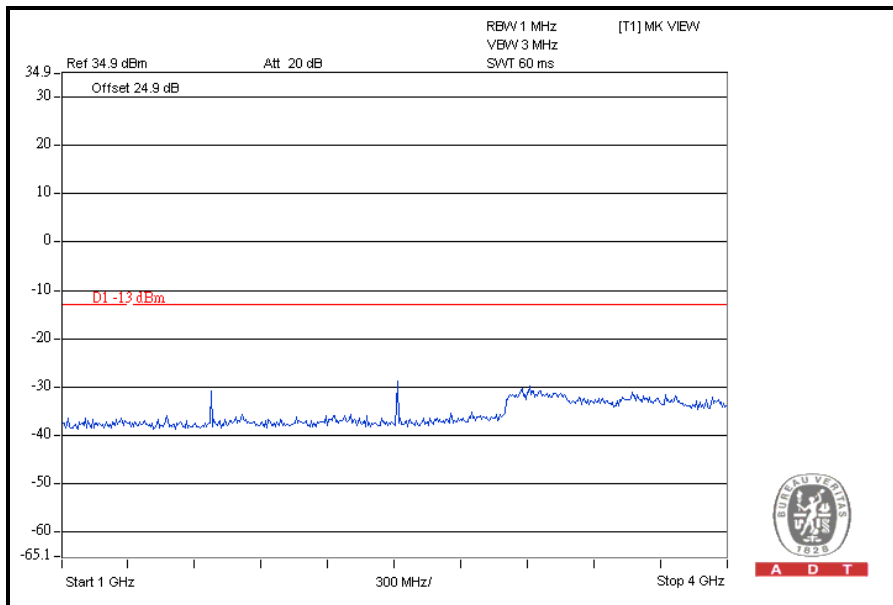



A D T

4GHz ~ 9GHz

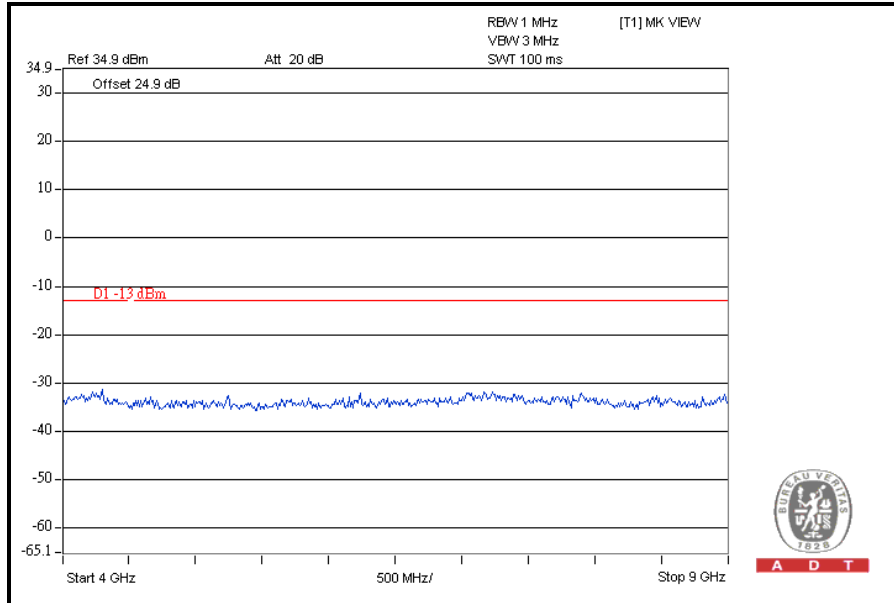



A D T

CH 251: 9kHz ~ 1GHz

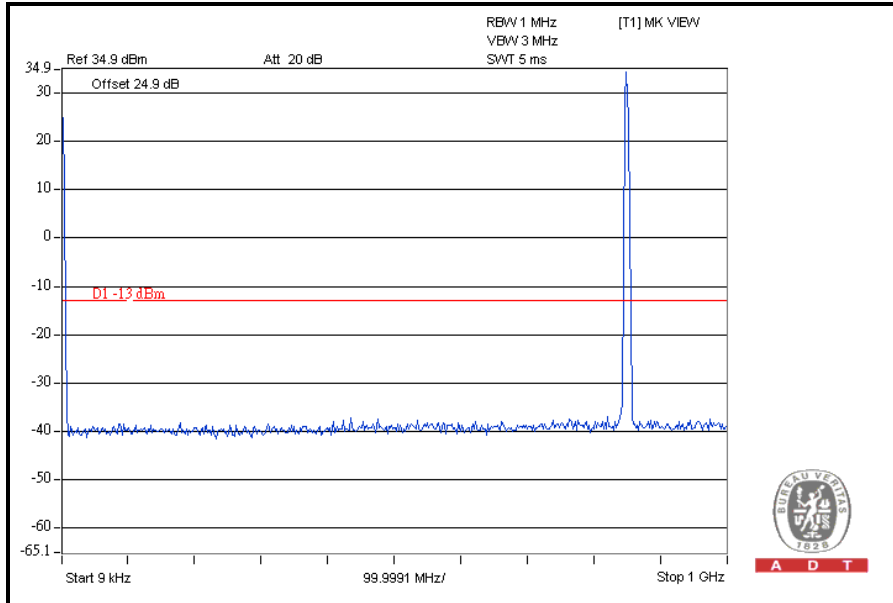

1GHz ~ 4GHz

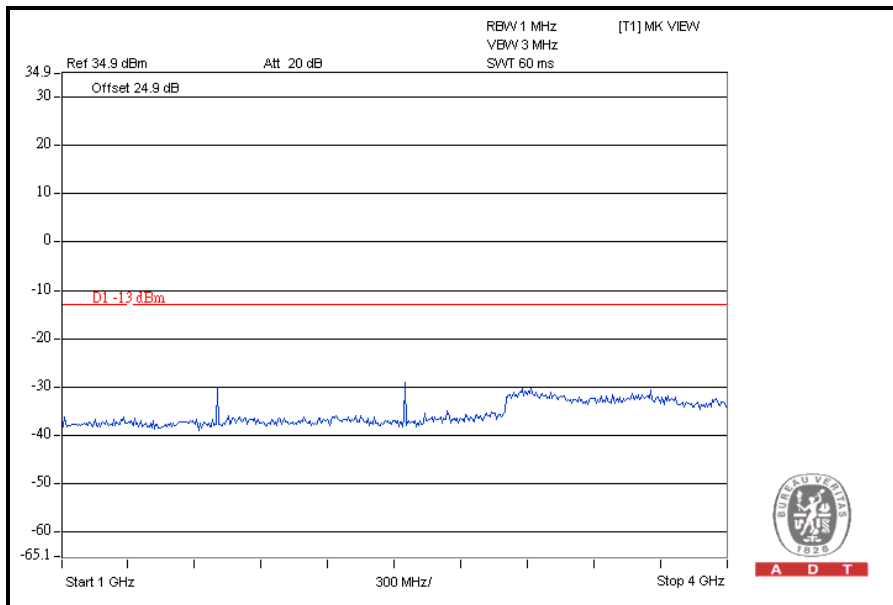



A D T

4GHz ~ 9GHz

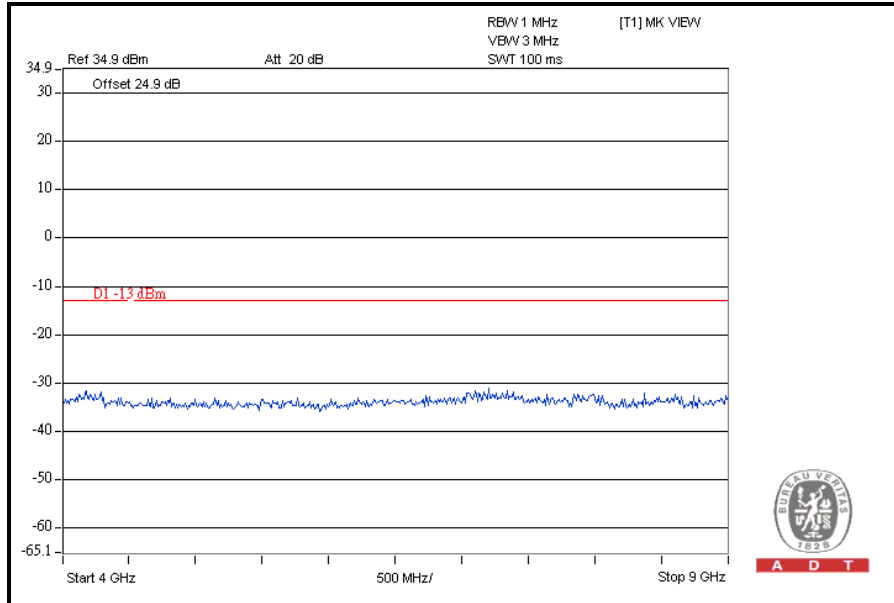



A D T

FOR WCDMA:

CH 4132: 9kHz ~ 1GHz

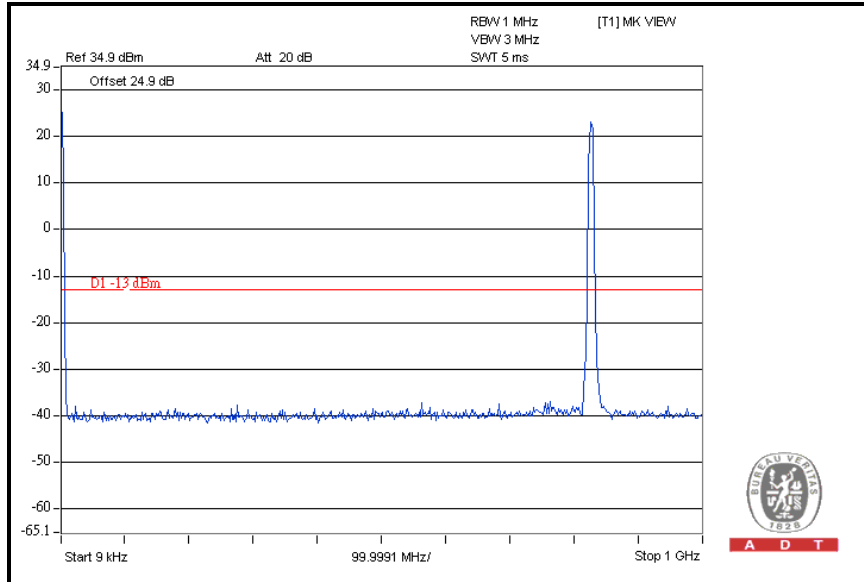

1GHz ~ 4GHz

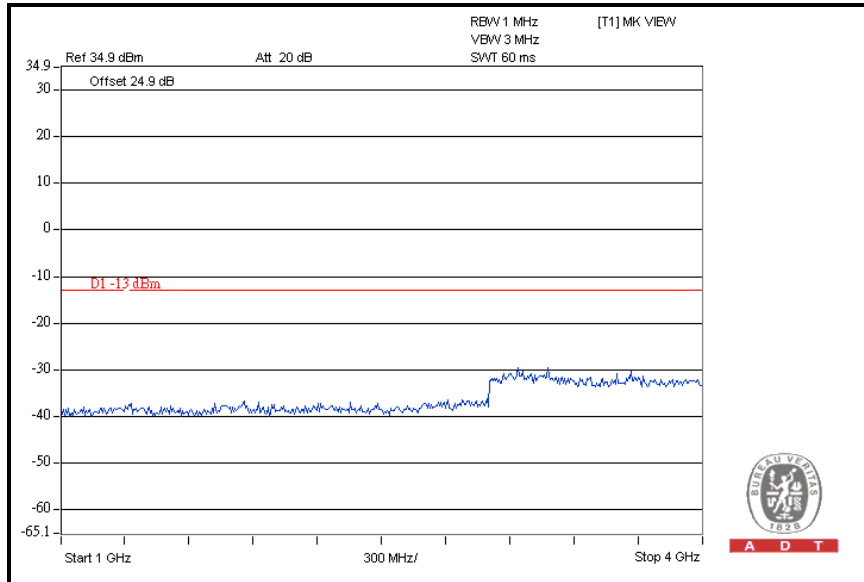



A D T

4GHz ~ 9GHz

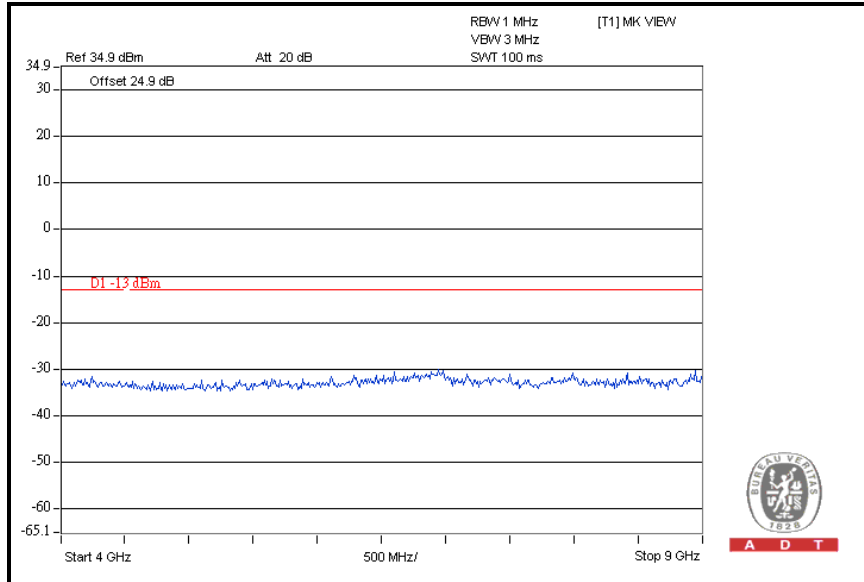



A D T

CH 4182: 9kHz ~ 1GHz

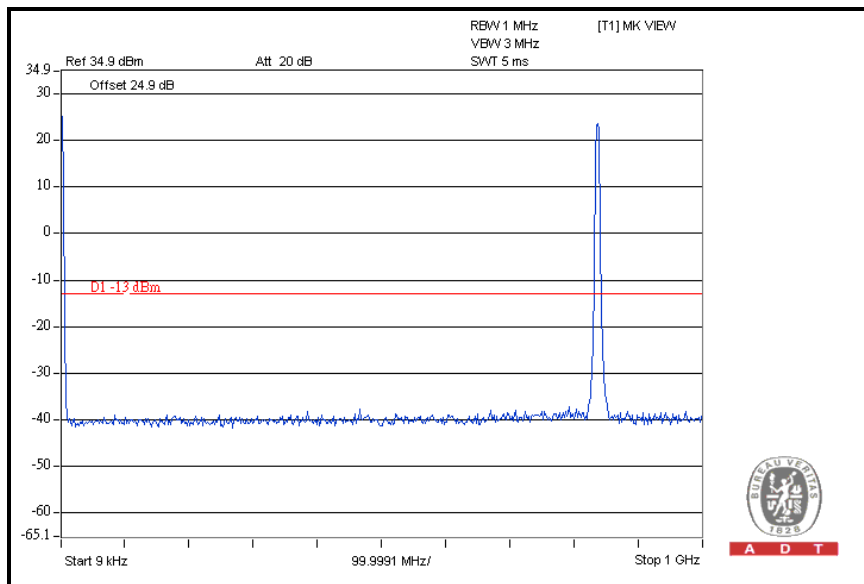

1GHz ~ 4GHz

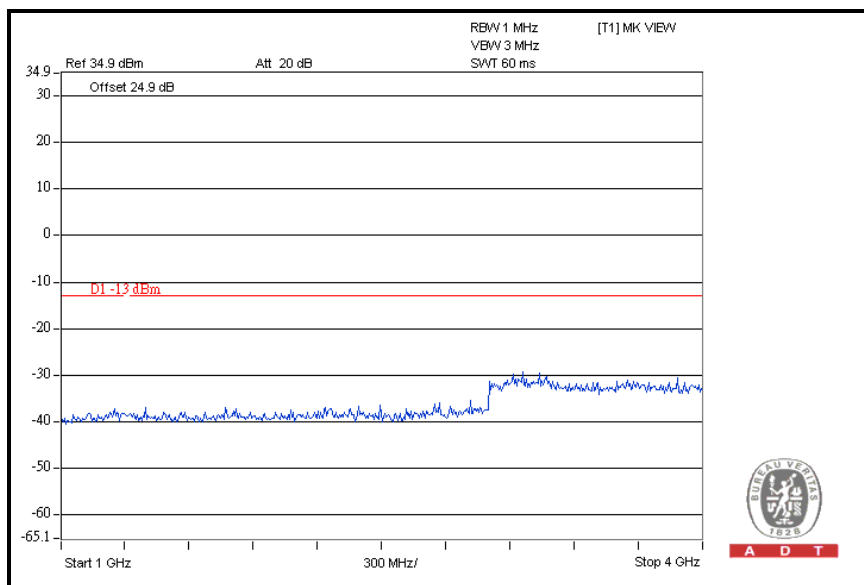



A D T

4GHz ~ 9GHz

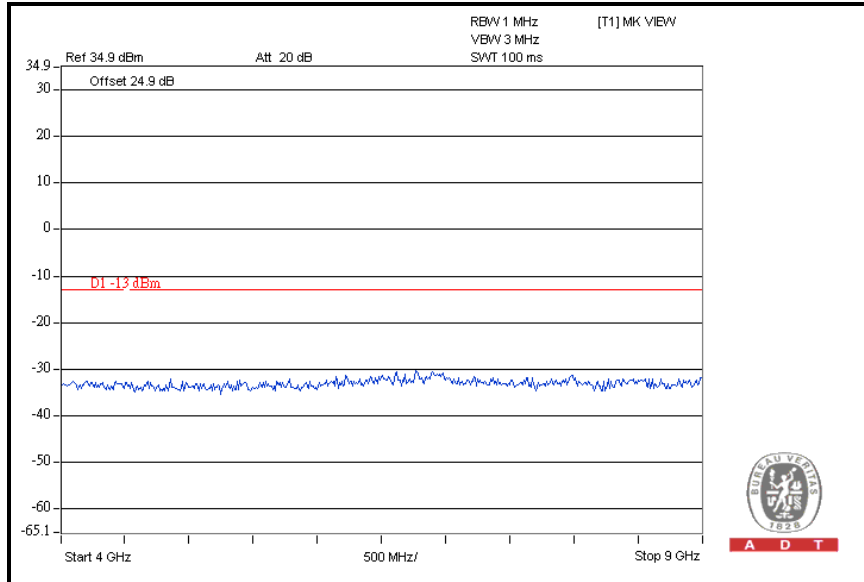



A D T

CH 4233: 9kHz ~ 1GHz

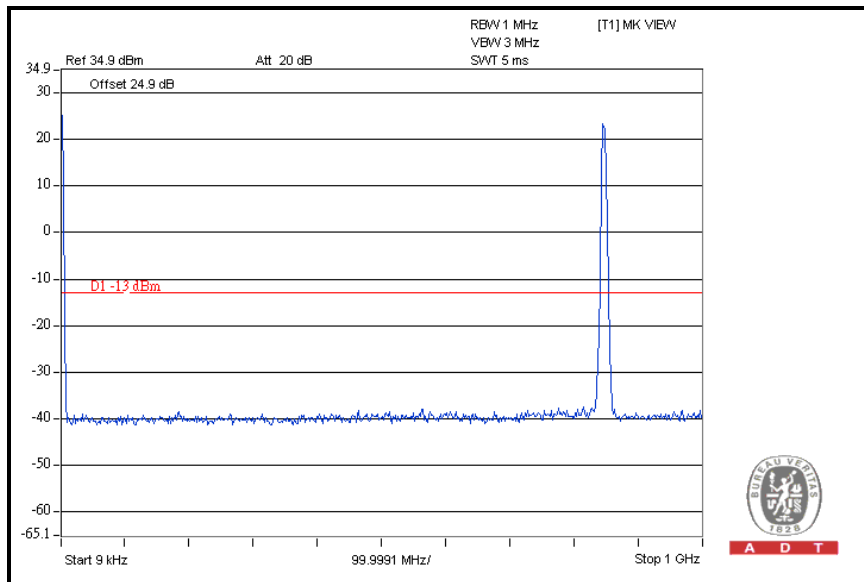

1GHz ~ 4GHz

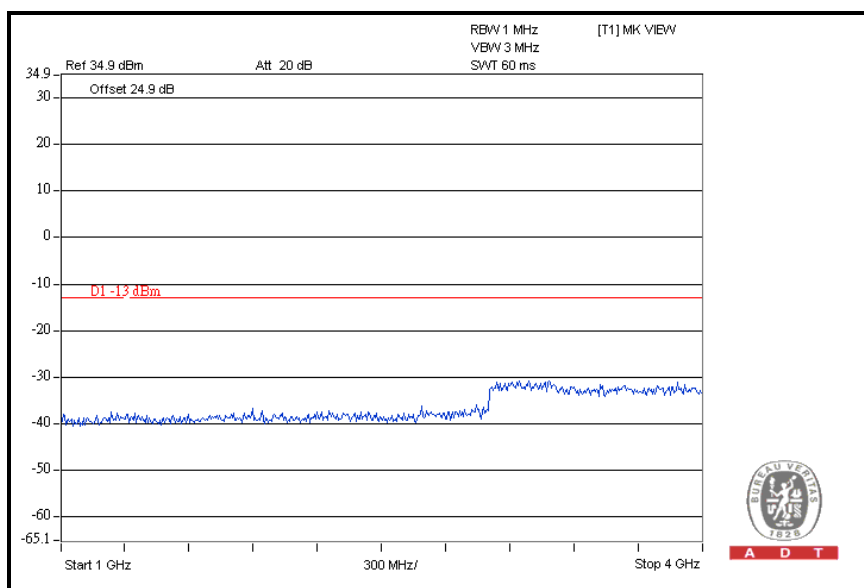



A D T

4GHz ~ 9GHz

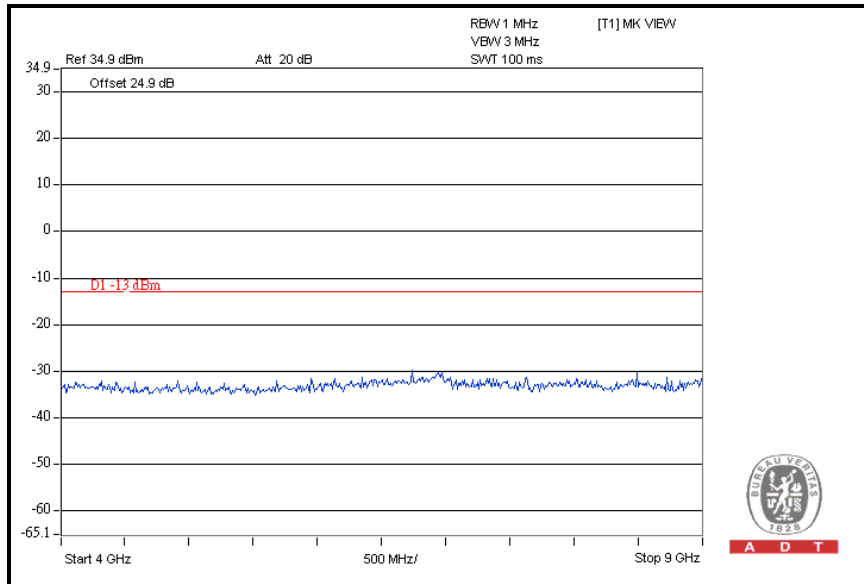

4.6 RADIATED EMISSION MEASUREMENT (BELOW 1GHz)

4.6.1 LIMITS OF RADIATED EMISSION MEASUREMENT

In the FCC 22.917(a), the power of any emission outside of the authorized operating frequency ranges must be attenuated below the transmitting power (P) by at least 43 +10 log (P) dB. The limit of emission equal to -13dBm. So the limit of emission is the same absolute specified line.

LIMIT (dBm)	EQUIVALENT FIELD STRENGTH AT 3m (dBuV/m) (NOTE)
-13	82.22

NOTE: The following formula is used to convert the equipment radiated power to field strength.

$$E = [1000000\sqrt{(30P)}] / 3 \text{ uV/m, where P is Watts.}$$



A D T

4.6.2 TEST INSTRUMENTS

Test date: Aug. 23, 2011

DESCRIPTION & MANUFACTURER	MODEL NO.	SERIAL NO.	CALIBRATED DATE	CALIBRATED UNTIL
ROHDE & SCHWARZ Spectrum Analyzer	FSP40	100036	Dec. 08, 2010	Dec. 07, 2011
Agilent PSA Spectrum Analyzer	E4446A	MY48250113	Nov. 30 , 2010	Nov. 29 , 2011
HP Pre_Amplifier	8449B	300801923	Nov. 01, 2010	Oct. 31, 2011
ROHDE & SCHWARZ Test Receiver	ESCS30	847124/029	Sep. 03, 2010	Sep. 02, 2011
SCHWARZBECK TRILOG Broadband Antenna	VULB 9168	138	Apr. 14, 2011	Apr. 13, 2012
Schwarzbeck Horn_Antenna	BBHA9120	D124	Dec. 17, 2010	Dec. 16, 2011
Schwarzbeck Horn_Antenna	BBHA 9170	BBHA9170153	Jan. 17, 2011	Jan. 16, 2012
RF Switches	EMH-011	1001	NA	NA
RF CABLE (Chaintek)	Sucoflex 106	RF106-102	Jan. 27, 2011	Jan. 26, 2012
RF Cable	8DFB	STCCAB-30M-1GHz	NA	NA
Software	ADT_Radiated_V7.6.15.9.2	NA	NA	NA
CT Antenna Tower & Turn Table	NA	NA	NA	NA
Agilent signal generator	E8257C	MY43321031	Aug. 23, 2011	Aug. 22, 2012

- Note: 1. The calibration interval of the above test instruments is 12 months and the calibrations are traceable to NML/ROC and NIST/USA.
2. The horn antenna, preamplifier (model: 8449B) and Spectrum Analyzer (model: FSP40) are used only for the measurement of emission frequency above 1GHz if tested.
3. The test was performed in Open Site No. C.
4. The FCC Site Registration No. is 656396.
5. The VCCI Site Registration No. is R-1626.
6. The CANADA Site Registration No. is IC 7450G-3.

4.6.3 TEST PROCEDURES

- a. Substitution method is used for EIRP measurement. In the open site, EUT placed on the 0.8m height of Turn Table, rotated the table around 360 degrees to search the maximum radiation power and receiver antenna shall be rotated vertical and horizontal polarization and moved height from 1m to 4m to find the maximum polar radiated power. The “Read Value” is the spectrum reading the maximum power value.
- b. The substitution horn antenna is substituted for EUT at the same position and signals generator export the CW signal to the substitution antenna via a TX cable. Rotated the Turn Table and moved receiving antenna to find the maximum radiation power. Adjust output power level of S.G to get a Value of spectrum reading equal to “Read Value “ of step a. Record the power level of S.G
- c. $EIRP = \text{Output power level of S.G} - \text{TX cable loss} + \text{Antenna gain of substitution horn.}$
- d. ERP power can be calculated form EIRP power by subtracting the gain of dipole,
 $ERP \text{ power} = EIPR \text{ power} - 2.15\text{dBi.}$

NOTE: The resolution bandwidth of spectrum analyzer is 1 MHz and the video bandwidth is 3 MHz.

4.6.4 DEVIATION FROM TEST STANDARD

No deviation

4.6.5 TEST SETUP

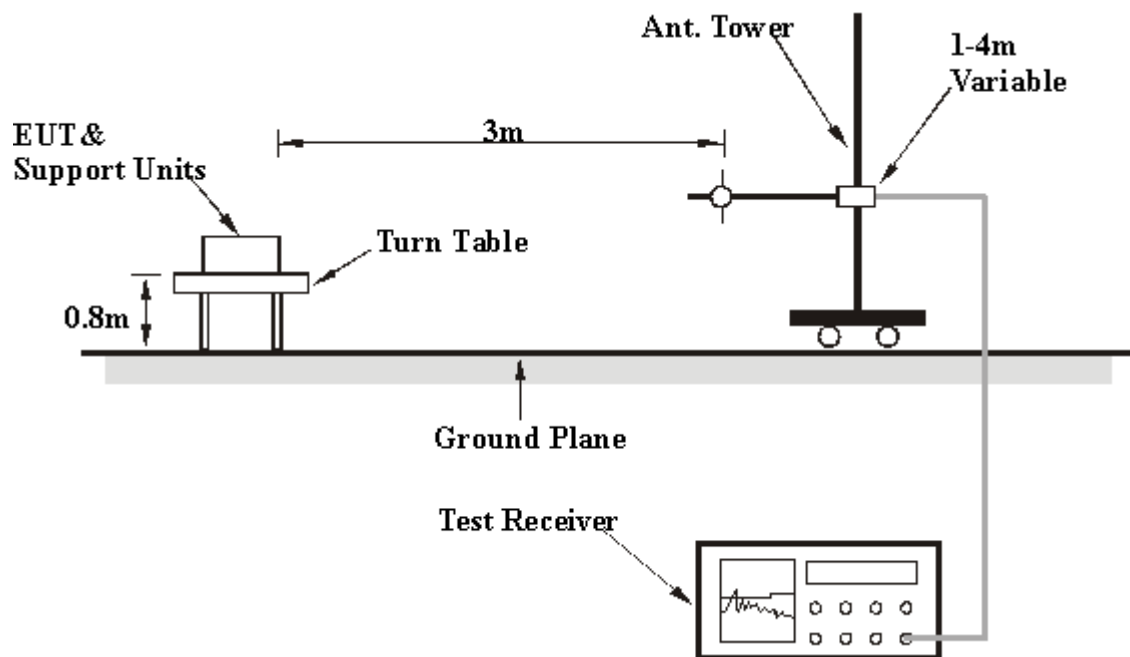

For the actual test configuration, please refer to the attached file (Test Setup Photo).

4.6.6 EUT OPERATING CONDITIONS

Same as Item 4.1.5



A D T

4.6.7 TEST RESULTS

FOR GPRS:

MODE	TX channel 190	FREQUENCY RANGE	Below 1000 MHz
ENVIRONMENTAL CONDITIONS	25deg. C, 63%RH	INPUT POWER	120Vac, 60 Hz
TESTED BY	Evan Huang		

ANTENNA POLARITY & TEST DISTANCE: HORIZONTAL AT 3 M						
No.	Freq. (MHz)	Emission Level (dBuV)	Limit (dBm)	S.G Power Value (dBm)	Correction Factor (dB)	Power Value (dBm)
1	109.92	37.40	-13	-52.74	-0.90	-53.64
2	116.94	40.94	-13	-48.82	-1.10	-49.92
3	123.42	38.96	-13	-51.38	-1.20	-52.58
4	132.06	44.31	-13	-47.91	-1.26	-49.17
5	176.88	38.91	-13	-54.02	1.74	-52.28
6	196.86	37.71	-13	-57.51	4.00	-53.51
7	209.82	38.42	-13	-57.04	4.21	-52.83
8	948.2	37.30	-13	-60.89	0.35	-60.54
9	956.6	36.98	-13	-60.96	0.37	-60.59
10	993	35.52	-13	-61.19	0.56	-60.63

ANTENNA POLARITY & TEST DISTANCE: VERTICAL AT 3 M						
No.	Freq. (MHz)	Emission Level (dBuV)	Limit (dBm)	S.G Power Value (dBm)	Correction Factor (dB)	Power Value (dBm)
1	130.44	38.12	-13	-53.74	-1.25	-54.99
2	132.06	58.30	-13	-33.92	-1.26	-35.18
3	175.8	41.99	-13	-50.63	1.58	-49.05
4	209.82	35.68	-13	-59.78	4.21	-55.57
5	216.84	37.38	-13	-58.05	4.12	-53.93
6	305.6	44.76	-13	-51.26	3.70	-47.56
7	336.4	38.72	-13	-58.58	3.63	-54.95
8	363.4	43.52	-13	-54.33	3.52	-50.81
9	526.8	37.21	-13	-57.99	2.69	-55.30
10	799.8	41.91	-13	-56.80	1.55	-55.25

NOTE: Power Value (dBm) = S.G Power Value (dBm) + Correction Factor (dB).



A D T

FOR WCDMA:

MODE	TX channel 4182	FREQUENCY RANGE	Below 1000 MHz
ENVIRONMENTAL CONDITIONS	25deg. C, 63%RH	INPUT POWER	120Vac, 60 Hz
TESTED BY	Evan Huang		

ANTENNA POLARITY & TEST DISTANCE: HORIZONTAL AT 3 M

No.	Freq. (MHz)	Emission Level (dBuV)	Limit (dBm)	S.G Power Value (dBm)	Correction Factor (dB)	Power Value (dBm)
1	109.92	37.56	-13	-52.58	-0.90	-53.48
2	116.94	40.78	-13	-48.98	-1.10	-50.08
3	123.42	38.59	-13	-51.75	-1.20	-52.95
4	132.06	44.52	-13	-47.70	-1.26	-48.96
5	176.88	38.75	-13	-54.17	1.74	-52.44
6	196.86	37.48	-13	-57.75	4.00	-53.74
7	209.82	38.69	-13	-56.77	4.21	-52.56
8	948.2	37.55	-13	-60.64	0.35	-60.29
9	956.6	36.86	-13	-61.09	0.37	-60.71
10	993	35.87	-13	-60.84	0.56	-60.28

ANTENNA POLARITY & TEST DISTANCE: VERTICAL AT 3 M

No.	Freq. (MHz)	Emission Level (dBuV)	Limit (dBm)	S.G Power Value (dBm)	Correction Factor (dB)	Power Value (dBm)
1	130.44	38.52	-13	-53.34	-1.25	-54.59
2	132.06	58.45	-13	-33.77	-1.26	-35.03
3	175.8	41.85	-13	-50.77	1.58	-49.19
4	209.82	35.64	-13	-59.82	4.21	-55.61
5	216.84	37.48	-13	-57.95	4.12	-53.83
6	305.6	44.69	-13	-51.33	3.70	-47.63
7	336.4	38.65	-13	-58.65	3.63	-55.02
8	363.4	43.58	-13	-54.28	3.52	-50.75
9	526.8	37.48	-13	-57.72	2.69	-55.03
10	799.8	41.58	-13	-57.13	1.55	-55.58

NOTE: Power Value (dBum) = S.G Power Value (dBm) + Correction Factor (dB).

4.7 RADIATED EMISSION MEASUREMENT (ABOVE 1GHz)

4.7.1 LIMITS OF RADIATED EMISSION MEASUREMENT

In the FCC 22.917(a), the power of any emission outside of the authorized operating frequency ranges must be attenuated below the transmitting power (P) by at least $43 + 10 \log (P)$ dB. The limit of emission equal to -13dBm .



A D T

4.7.2 TEST INSTRUMENTS

Test date: Aug. 23, 2011

DESCRIPTION & MANUFACTURER	MODEL NO.	SERIAL NO.	CALIBRATED DATE	CALIBRATED UNTIL
ROHDE & SCHWARZ Spectrum Analyzer	FSP40	100036	Dec. 08, 2010	Dec. 07, 2011
Agilent PSA Spectrum Analyzer	E4446A	MY48250113	Nov. 30 , 2010	Nov. 29 , 2011
HP Pre_Amplifier	8449B	300801923	Nov. 01, 2010	Oct. 31, 2011
ROHDE & SCHWARZ Test Receiver	ESCS30	847124/029	Sep. 03, 2010	Sep. 02, 2011
SCHWARZBECK TRILOG Broadband Antenna	VULB 9168	138	Apr. 14, 2011	Apr. 13, 2012
Schwarzbeck Horn_Antenna	BBHA9120	D124	Dec. 17, 2010	Dec. 16, 2011
Schwarzbeck Horn_Antenna	BBHA 9170	BBHA9170153	Jan. 17, 2011	Jan. 16, 2012
RF Switches	EMH-011	1001	NA	NA
RF CABLE (Chaintek)	Sucoflex 106	RF106-102	Jan. 27, 2011	Jan. 26, 2012
RF Cable	8DFB	STCCAB-30M-1GHz	NA	NA
Software	ADT_Radiated_V7.6.15.9.2	NA	NA	NA
CT Antenna Tower & Turn Table	NA	NA	NA	NA
Agilent signal generator	E8257C	MY43321031	Aug. 23, 2011	Aug. 22, 2012

- Note: 1. The calibration interval of the above test instruments is 12 months and the calibrations are traceable to NML/ROC and NIST/USA.
2. The horn antenna, preamplifier (model: 8449B) and Spectrum Analyzer (model: FSP40) are used only for the measurement of emission frequency above 1GHz if tested.
3. The test was performed in Open Site No. C.
4. The FCC Site Registration No. is 656396.
5. The VCCI Site Registration No. is R-1626.
6. The CANADA Site Registration No. is IC 7450G-3.

4.7.3 TEST PROCEDURES

- a. Substitution method is used for EIRP measurement. In the open site, EUT placed on the 0.8m height of Turn Table, rotated the table around 360 degrees to search the maximum radiation power and receiver antenna shall be rotated vertical and horizontal polarization and moved height from 1m to 4m to find the maximum polar radiated power. The “Read Value” is the spectrum reading the maximum power value.
- b. The substitution horn antenna is substituted for EUT at the same position and signals generator export the CW signal to the substitution antenna via a TX cable. Rotated the Turn Table and moved receiving antenna to find the maximum radiation power. Adjust output power level of S.G to get a Value of spectrum reading equal to “Read Value “ of step a. Record the power level of S.G
- c. $EIRP = \text{Output power level of S.G} - \text{TX cable loss} + \text{Antenna gain of substitution horn.}$
- d. ERP power can be calculated form EIRP power by subtracting the gain of dipole,
 $ERP \text{ power} = EIPR \text{ power} - 2.15\text{dBi.}$

NOTE: The resolution bandwidth of spectrum analyzer is 1 MHz and the video bandwidth is 3 MHz.

4.7.4 DEVIATION FROM TEST STANDARD

No deviation

4.7.5 TEST SETUP

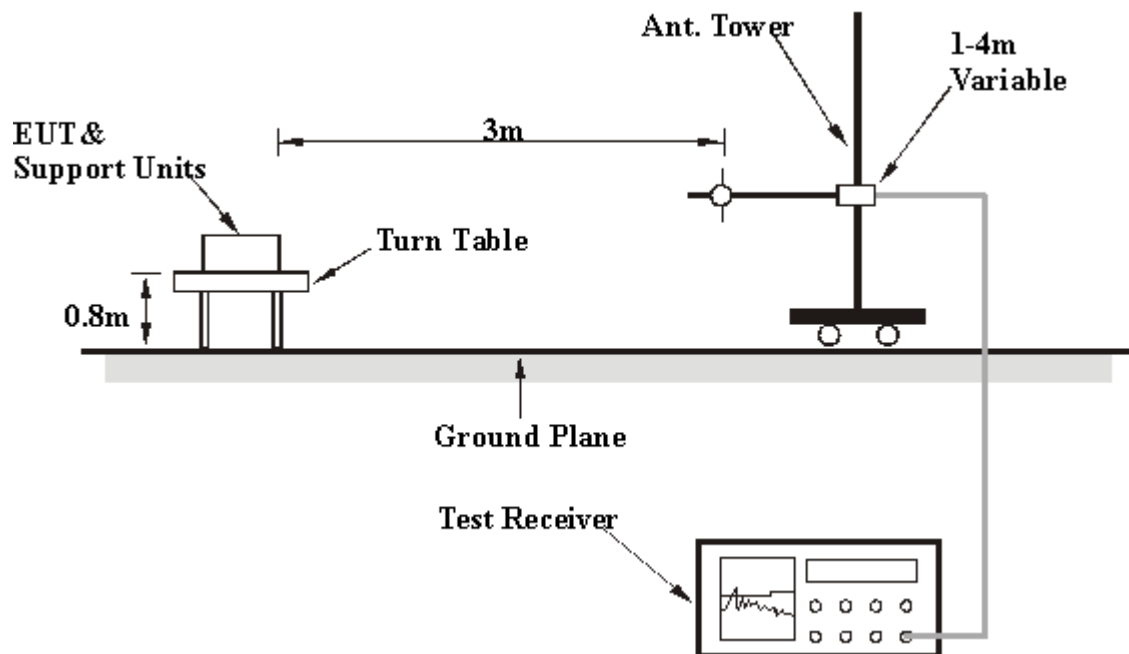

For the actual test configuration, please refer to the attached file (Test Setup Photo).

4.7.6 EUT OPERATING CONDITIONS

Same as Item 4.1.5



A D T

4.7.7 TEST RESULTS

FOR GPRS BAND:

MODE	TX channel 128	FREQUENCY RANGE	Above 1000 MHz
ENVIRONMENTAL CONDITIONS	25deg. C, 63%RH	INPUT POWER	120Vac, 60 Hz
TESTED BY	Evan Huang		

ANTENNA POLARITY & TEST DISTANCE: HORIZONTAL AT 3 M						
No.	Freq. (MHz)	Emission Level (dBuV)	Limit (dBm)	S.G Power Value (dBm)	Correction Factor (dB)	Power Value (dBm)
1	1648.4	80.93	-13	-21.82	6.26	-15.56
2	2472.6	65.77	-13	-32.81	6.66	-26.15

ANTENNA POLARITY & TEST DISTANCE: VERTICAL AT 3 M						
No.	Freq. (MHz)	Emission Level (dBuV)	Limit (dBm)	S.G Power Value (dBm)	Correction Factor (dB)	Power Value (dBm)
1	1648.4	67.95	-13	-34.80	6.26	-28.54
2	2472.6	63.86	-13	-34.72	6.66	-28.06

NOTE: Power Value (dBum) = S.G Power Value (dBm) + Correction Factor (dB).



A D T

MODE	TX channel 190	FREQUENCY RANGE	Above 1000 MHz
ENVIRONMENTAL CONDITIONS	25deg. C, 63%RH	INPUT POWER	120Vac, 60 Hz
TESTED BY	Evan Huang		

ANTENNA POLARITY & TEST DISTANCE: HORIZONTAL AT 3 M						
No.	Freq. (MHz)	Emission Level (dBuV)	Limit (dBm)	S.G Power Value (dBm)	Correction Factor (dB)	Power Value (dBm)
1	1673.2	79.48	-13	-23.15	6.31	-16.84
2	2509.8	65.44	-13	-33.08	6.66	-26.42

ANTENNA POLARITY & TEST DISTANCE: VERTICAL AT 3 M						
No.	Freq. (MHz)	Emission Level (dBuV)	Limit (dBm)	S.G Power Value (dBm)	Correction Factor (dB)	Power Value (dBm)
1	1673.2	67.64	-13	-34.99	6.31	-28.68
2	2509.8	65.25	-13	-33.27	6.66	-26.61

NOTE: Power Value (dBum) = S.G Power Value (dBm) + Correction Factor (dB).



A D T

MODE	TX channel 251	FREQUENCY RANGE	Above 1000 MHz
ENVIRONMENTAL CONDITIONS	25deg. C, 63%RH	INPUT POWER	120Vac, 60 Hz
TESTED BY	Evan Huang		

ANTENNA POLARITY & TEST DISTANCE: HORIZONTAL AT 3 M						
No.	Freq. (MHz)	Emission Level (dBuV)	Limit (dBm)	S.G Power Value (dBm)	Correction Factor (dB)	Power Value (dBm)
1	1697.6	75.90	-13	-26.60	6.35	-20.25
2	2546.4	64.72	-13	-34.10	6.69	-27.41

ANTENNA POLARITY & TEST DISTANCE: VERTICAL AT 3 M						
No.	Freq. (MHz)	Emission Level (dBuV)	Limit (dBm)	S.G Power Value (dBm)	Correction Factor (dB)	Power Value (dBm)
1	1697.6	65.57	-13	-36.93	6.35	-30.58
2	2546.4	65.67	-13	-33.15	6.69	-26.46

NOTE: Power Value (dBum) = S.G Power Value (dBm) + Correction Factor (dB).



A D T

FOR WCDMA BAND:

MODE	TX channel 4132	FREQUENCY RANGE	Above 1000 MHz
ENVIRONMENTAL CONDITIONS	25deg. C, 63%RH	INPUT POWER	120Vac, 60 Hz
TESTED BY	Evan Huang		

ANTENNA POLARITY & TEST DISTANCE: HORIZONTAL AT 3 M

No.	Freq. (MHz)	Emission Level (dBuV)	Limit (dBm)	S.G Power Value (dBm)	Correction Factor (dB)	Power Value (dBm)
1	1652.8	45.25	-13	-57.48	6.27	-51.21
2	2479.2	44.92	-13	-53.63	6.66	-46.97

ANTENNA POLARITY & TEST DISTANCE: VERTICAL AT 3 M

No.	Freq. (MHz)	Emission Level (dBuV)	Limit (dBm)	S.G Power Value (dBm)	Correction Factor (dB)	Power Value (dBm)
1	1652.8	47.34	-13	-55.39	6.27	-49.12
2	2479.2	45.84	-13	-52.71	6.66	-46.05

NOTE: Power Value (dBum) = S.G Power Value (dBm) + Correction Factor (dB).



A D T

MODE	TX channel 4182	FREQUENCY RANGE	Above 1000 MHz
ENVIRONMENTAL CONDITIONS	25deg. C, 63%RH	INPUT POWER	120Vac, 60 Hz
TESTED BY	Evan Huang		

ANTENNA POLARITY & TEST DISTANCE: HORIZONTAL AT 3 M						
No.	Freq. (MHz)	Emission Level (dBuV)	Limit (dBm)	S.G Power Value (dBm)	Correction Factor (dB)	Power Value (dBm)
1	1672.8	44.67	-13	-57.96	6.31	-51.65
2	2509.2	44.06	-13	-54.46	6.66	-47.80

ANTENNA POLARITY & TEST DISTANCE: VERTICAL AT 3 M						
No.	Freq. (MHz)	Emission Level (dBuV)	Limit (dBm)	S.G Power Value (dBm)	Correction Factor (dB)	Power Value (dBm)
1	1672.8	43.45	-13	-59.18	6.31	-52.87
2	2509.2	42.15	-13	-56.37	6.66	-49.71

NOTE: Power Value (dBum) = S.G Power Value (dBm) + Correction Factor (dB).



A D T

MODE	TX channel 4233	FREQUENCY RANGE	Above 1000 MHz
ENVIRONMENTAL CONDITIONS	25deg. C, 63%RH	INPUT POWER	120Vac, 60 Hz
TESTED BY	Evan Huang		

ANTENNA POLARITY & TEST DISTANCE: HORIZONTAL AT 3 M						
No.	Freq. (MHz)	Emission Level (dBuV)	Limit (dBm)	S.G Power Value (dBm)	Correction Factor (dB)	Power Value (dBm)
1	1693.2	46.19	-13	-56.33	6.34	-49.99
2	2539.8	44.86	-13	-53.91	6.69	-47.22

ANTENNA POLARITY & TEST DISTANCE: VERTICAL AT 3 M						
No.	Freq. (MHz)	Emission Level (dBuV)	Limit (dBm)	S.G Power Value (dBm)	Correction Factor (dB)	Power Value (dBm)
1	1693.2	47.02	-13	-55.50	6.34	-49.16
2	2539.8	45.62	-13	-53.15	6.69	-46.46

NOTE: Power Value (dBum) = S.G Power Value (dBm) + Correction Factor (dB).



A D T

5 PHOTOGRAPHS OF THE TEST CONFIGURATION

Please refer to the attached file (Test Setup Photo).





6 INFORMATION ON THE TESTING LABORATORIES

We, Bureau Veritas Consumer Products Services (H.K.) Ltd., Taoyuan Branch, were founded in 1988 to provide our best service in EMC, Radio, Telecom and Safety consultation. Our laboratories are accredited and approved according to ISO/IEC 17025.

Copies of accreditation certificates of our laboratories obtained from approval agencies can be downloaded from our web site: www.adt.com.tw/index.5.phtml.
If you have any comments, please feel free to contact us at the following:

Linko EMC/RF Lab:

Tel: 886-2-26052180
Fax: 886-2-26052943

Hsin Chu EMC/RF Lab:

Tel: 886-3-5935343
Fax: 886-3-5935342

Hwa Ya EMC/RF/Safety/Telecom Lab:

Tel: 886-3-3183232
Fax: 886-3-3185050

Email: service.adt@tw.bureauveritas.com

Web Site: www.adt.com.tw

The address and road map of all our labs can be found in our web site also.

7 APPENDIX A – MODIFICATIONS RECORDERS FOR ENGINEERING CHANGES TO THE EUT BY THE LAB

No any modifications are made to the EUT by the lab during the test.

---END---