

FCC 47 CFR PART 22H and 24E

Product Type : Portable Terminal

Applicant : XAC Automation Corporation

Address : 4F., NO.30, INDUSTRY E. RD. IX, SCIENCE-BASED
INDUSTRIAL PARK, HSIN-CHU, Taiwan, R.O.C.

Trade Name : FDC

Model Number : FD-400eTi

Test Specification : FCC 47 CFR PART 22H: Oct., 2009
FCC 47 CFR PART 24E: Oct., 2009
ANSI/TIA-603-C 2004

Issue Date : Aug. 09, 2010

Issue by

A Test Lab Techno Corp.
No. 140-1, Changan Street, Bade City,
Taoyuan County 334, Taiwan R.O.C.
Tel : +886-3-2710188 / Fax : +886-3-2710190



Taiwan Accreditation Foundation accreditation number: 1330

Note: This report shall not be reproduced except in full, without the written approval of A Test Lab Techno Corp. This document may be altered or revised by A Test Lab Techno Corp. personnel only, and shall be noted in the revision section of the document. The client should not use it to claim product endorsement by TAF, or any government agencies. The test results in the report only apply to the tested sample.

Revision History

Rev.	Issue Date	Revisions	Revised By
00	Aug. 09, 2010	Initial Issue	

Verification of Compliance

Issued Date: 2010/08/09

Product Type : Portable Terminal
Applicant : XAC Automation Corporation
Address : 4F., NO.30, INDUSTRY E. RD. IX, SCIENCE-BASED
INDUSTRIAL PARK, HSIN-CHU, Taiwan, R.O.C.
Trade Name : FDC
Model Number : FD-400eTi
FCC ID : MQT-FD400ETI
EUT Rated Voltage : DC 12.0V, 2.0A
Test Voltage : 120 Vac / 60 Hz
Applicable : FCC 47 CFR PART 22H: Oct., 2009
Standard : FCC 47 CFR PART 24E: Oct., 2009
ANSI/TIA-603-C 2004

Test Result : Complied

Performing Lab. : A Test Lab Techno Corp.
No. 140-1, Changan Street, Bade City
Taoyuan County 334, Taiwan R.O.C.
Tel : +886-3-2710188 / Fax : +886-3-2710190



Taiwan Accreditation Foundation accreditation number:
1330

<http://www.atl-lab.com.tw/e-index.htm>

The above equipment was tested by A Test Lab Techno Corp. The test data, data evaluation, test procedures, and equipment configurations shown in this report were made in accordance with the procedures given in ANSI C63.4: 2003 and the energy emitted by the sample tested as described in this report is in compliance with the requirements of FCC Rules Part 22H, Part 24E.
The test results of this report relate only to the tested sample identified in this report.

Approved By : 
(Manager) (Miller Lee)

Reviewed By : 
(Testing Engineer) (Gary Wu)

TABLE OF CONTENTS

1	General Information	6
	1.1. EUT Description.....	6
	1.2. Mode of Operation.....	7
	1.3. EUT Exercise Software.....	7
	1.4. Configuration of Test System Details.....	7
	1.5. Test Site Environment.....	8
	1.6. Summary of Test Result	8
2	RF Output Power Test.....	9
	2.1. Limit	9
	2.2. Test Instruments	9
	2.3. Test Setup.....	9
	2.4. Test Procedure.....	9
	2.5. Uncertainty.....	10
	2.6. Test Result.....	10
3	Effective Radiated Power / Equivalent Isotropic Radiated Power Test	11
	3.1. Limit	11
	3.2. Test Instruments	11
	3.3. Setup	12
	3.4. Test Procedure.....	12
	3.5. Uncertainty.....	13
	3.6. Test Result.....	14
4	Occupied Bandwidth Test	15
	4.1. Limit	15
	4.2. Test Instruments	15
	4.3. Setup	15
	4.4. Test Procedure.....	16
	4.5. Uncertainty.....	16
	4.6. Test Result.....	17
5	Conducted Emission Test	23
	5.1. Limit	23
	5.2. Test Instruments	23
	5.3. Setup	23
	5.4. Test Procedure.....	24
	5.5. Uncertainty.....	24
	5.6. Test Result.....	24

6	Field Strength of Spurious Radiation Test	52
6.1.	Limit	52
6.2.	Test Instruments	52
6.3.	Setup	52
6.4.	Test Procedure.....	53
6.5.	Uncertainty.....	53
6.6.	Test Result.....	54
7	Frequency Stability (Temperature Variation) Test.....	60
7.1.	Limit	60
7.2.	Test Instruments	60
7.3.	Setup	60
7.4.	Test Procedure.....	61
7.5.	Uncertainty.....	61
7.6.	Test Result.....	62
8	Frequency Stability (Voltage Variation) Test.....	63
8.1.	Limit	63
8.2.	Test Instruments	63
8.3.	Setup	63
8.4.	Test Procedure.....	63
8.5.	Uncertainty.....	64
8.6.	Test Result.....	64
9	AC Power Conducted Emissions Test	65
9.1.	Limit	65
9.2.	Test Instruments	65
9.3.	Setup	65
9.4.	Test Procedure.....	66
9.5.	Uncertainty.....	66
9.6.	Test Result.....	67

1 General Information

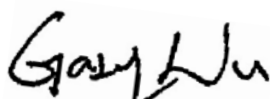
1.1. EUT Description

Applicant		XAC Automation Corporation			
Applicant Address		4F., NO.30, INDUSTRY E. RD. IX, SCIENCE-BASED INDUSTRIAL PARK, HSIN-CHU, Taiwan, R.O.C.			
Manufacturer		XAC Automation Corporation			
Manufacturer Address		4F., NO.30, INDUSTRY E. RD. IX, SCIENCE-BASED INDUSTRIAL PARK, HSIN-CHU, Taiwan, R.O.C.			
Product Type		Portable Terminal			
Trade Name		FDC			
Model Number		FD-400eTi			
FCC ID		MQT-FD400ETI			
Module Used		WWAN Module: Cinterion, TC63i			
Mode	GPRS	Band	UL Frequency (MHz)	DL Frequency (MHz)	Modulation
		850	824.2 ~ 848.8	869.2 ~ 893.8	GMSK/8PSK
		1900	1850.2 ~ 1909.8	1930.2 ~ 1989.8	GMSK/8PSK
Channel Control		Auto			
Type of Antenna		FPCB Type			
Antenna Gain (dBi)		GPRS 850: 2.7 dBi GPRS 1900: 1.3 dBi			
Max. RF Output power		GPRS 850: 32.60 dBm / 1.820 W GPRS 1900: 29.20 dBm / 0.832 W			
Max. ERP/EIRP		GPRS 850: 23.26 dBm / 0.212 W GPRS 1900: 26.11 dBm / 0.408 W			
Emission Designator		GPRS 850: 250KGXW GPRS 1900: 247KGXW			
Component					
Battery		CHENG UEI PRECISION INDUSTRY CO., LTD., FD400 DC 7.4V, 2300mAh			
Power Adapter		LI SHIN, LSE0107A1240 Input: 100-240Vac, 50/60Hz, 1A Output: 12.0 Vdc, 3.33A Cable in: Non-Shielded, 1.75 m, Cable out: Non-Shielded, 1.45 m with a core			
Car Charger		EDAC, ED1025 Input: 11~16 Vdc, 5A Output: 12.0 Vdc, 2.5A Cable in: Non-Shielded, 0.05 m, Cable out: Non-Shielded, 1.15 m with a core			

1.2. Mode of Operation

ATL has verified the construction and function in typical operation. All the test modes were carried out with the EUT in normal operation, which was shown in this test report and defined as:

Test Mode
Mode 1: GPRS 850 Link
Mode 2: GPRS 1900 Link

Note: Regards to the frequency band operation: the lowest, middle and highest frequency of channel were selected to perform the test, then shown on this report.

Tested System Details

The types for all equipments, plus descriptions of all cables used in the tested system (including inserted cards) are:

	Product	Manufacturer	Model Number	Serial Number	Power Cord
1.	Universal Radio Communication Tester	R&S	CMU200	109369	N/A

1.3. EUT Exercise Software

1.	Setup the EUT and Base Station (CMU200) as shown on 1.4.
2.	Turn on the power of all equipment.

1.4. Configuration of Test System Details

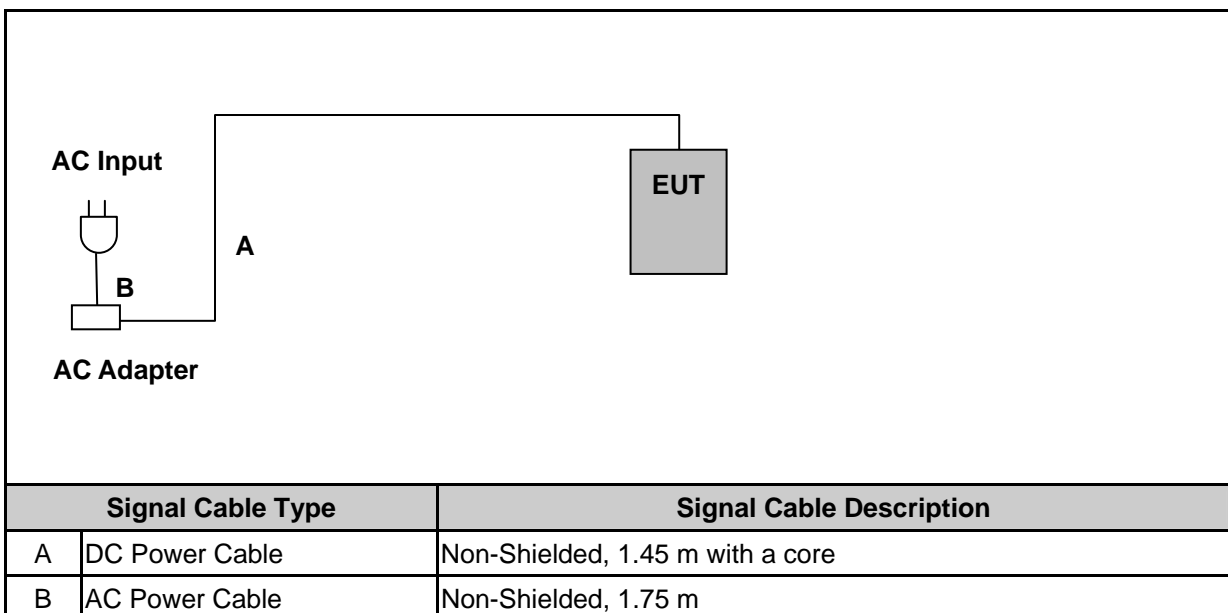

1.5. Test Site Environment

Items	Required (IEC 68-1)	Actual
Temperature (°C)	15-35	25
Humidity (%RH)	25-75	50
Barometric pressure (mbar)	860-1060	950

1.6. Summary of Test Result

Description	FCC Rule	IC Rule	Limit	Result
Conducted Output Power	§2.1046	N/A	N/A	Pass
Effective Radiated Power	§22.913(a)(2)	RSS-132(4.4) SRSP-503(5.1.3)	< 7 Watts for FCC (<6.3 Watts for IC)	Pass
Equivalent Isotropic Radiated Power	§24.232(c)	RSS-133 (6.4) SRSP-510(5.1.2)	< 2 Watts	Pass
Occupied Bandwidth	§2.1049 §22.917(a) §24.238(a)	N/A	N/A	Pass
Band Edge Measurement	§2.1051 §22.917(a) §24.238(a)	RSS-132 (4.5.1)RSS-133 (6.5.1)	< 43+10log ₁₀ (P[Watts])	Pass
Conducted Emission	§2.1051 §22.917(a) §24.238(a)	RSS-132 (4.5.1) RSS-133 (6.5.1)	< 43+10log ₁₀ (P[Watts])	Pass
Field Strength of Spurious Radiation	§2.1053 §22.917(a) §24.238(a)	RSS-132 (4.5.1) RSS-133 (6.5.1)	< 43+10log ₁₀ (P[Watts])	Pass
Frequency Stability for Temperature & Voltage	§2.1055 §22.355 §24.235	RSS-132(4.3) RSS-133(6.3)	< 2.5 ppm	Pass

2 RF Output Power Test

2.1. Limit

N/A

2.2. Test Instruments

Describe	Manufacturer	Model No.	Serial No.	Cal. Date	Remark
Universal Radio Communication Tester	ROHDE & SCHWARZ	CMU200	109369	07/29/2009	(2)
Single Channel PK Power Sensor	Agilent	N1911A	MY45101619	07/19/2010	(1)
Wideband Power Meter	Agilent	N1921A	MY45241957	07/19/2010	(1)
Test Site	ATL	TE02	TE02	N.C.R.	-----

Remark: ⁽¹⁾ Calibration period 1 year. ⁽²⁾ Calibration period 2 years.

NOTE: N.C.R. = No Calibration Request.

2.3. Test Setup

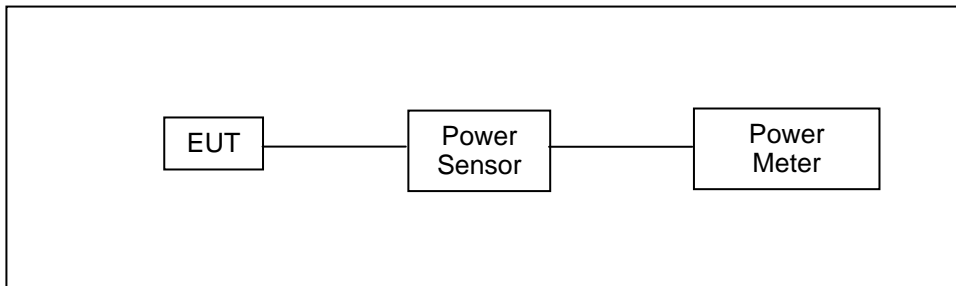

2.4. Test Procedure

The measurement is made according to ANSI/TIA-603-C-2004 as follows:

1. The transmitter output was connected to power meter and base station through power divider.
2. Set base station for EUT at GSM 850: PCL=5 and PCS 1900: PCL=0.
3. Set base station for EUT at WCDMA Band V and WCDMA Band II, power level was set to maximum.
4. Select lowest, middle, and highest channels for each band.

2.5. Uncertainty

The measurement uncertainty is defined as for RF output power measurement is 1.2 dB.

2.6. Test Result

Model Number	FD-400eTi					
Test Item	RF Output Power					
Date of Test	07/28/2010			Test Site	TE02	
Bands	Data Rate	Frequency (MHz)	Average Power		Peak Power	
			(dBm)	(W)	(dBm)	(W)
GRRS 850	4Down1Up	824.2	23.21	0.209	32.50	1.778
		836.4	23.11	0.205	32.40	1.738
		848.8	23.31	0.214	32.60	1.820
	3Down2Up	824.2	24.87	0.307	31.20	1.318
		836.4	24.77	0.300	31.10	1.288
		848.8	24.87	0.307	31.20	1.318
GRRS 1900	4Down1Up	1850.20	19.91	0.098	29.20	0.832
		1880.00	19.81	0.096	29.20	0.832
		1909.80	19.71	0.094	29.10	0.813
	3Down2Up	1850.20	21.07	0.128	27.50	0.562
		1880.00	21.07	0.128	27.50	0.562
		1909.80	20.97	0.125	27.30	0.537

Note: The peak power testing result was used peak detector.

3 Effective Radiated Power / Equivalent Isotropic Radiated Power Test

3.1. Limit

For FCC Part 22.913(a)(2): The ERP of mobile transmitters and auxiliary test transmitters must not exceed 7 Watts.

For FCC Part 24.232(b): The EIRP of mobile transmitters and auxiliary test transmitters must not exceed 2 Watts.

3.2. Test Instruments

3 Meter Chamber					
Equipment	Manufacturer	Model Number	Serial Number	Cal. Date	Remark
RF Pre-selector	Agilent	N9039A	MY46520256	01/07/2009	(2)
Spectrum Analyzer	Agilent	E4446A	MY46180578	02/24/2010	(2)
Pre Amplifier	Agilent	8449B	3008A02237	02/24/2010	(1)
Pre Amplifier	Agilent	8447D	2944A10961	02/24/2010	(1)
Bi-log Antenna	SCHWARZBECK MESS-ELEKTRONIK	VULB9163	9163-270	08/02/2010	(2)
Horn Antenna	SCHWARZBECK MESS-ELEKTRONIK	BBHA9120D	9120D-550	06/29/2010	(2)
Horn Antenna	SCHWARZBECK MESS-ELEKTRONIK	BBHA9170	9170-320	06/29/2010	(2)
Test Site	ATL	TE01	888001	07/30/2010	(1)

Remark: ⁽¹⁾ Calibration period 1 year. ⁽²⁾ Calibration period 2 years.

NOTE: N.C.R. = No Calibration Request.

3.3. Setup

Below 1 GHz

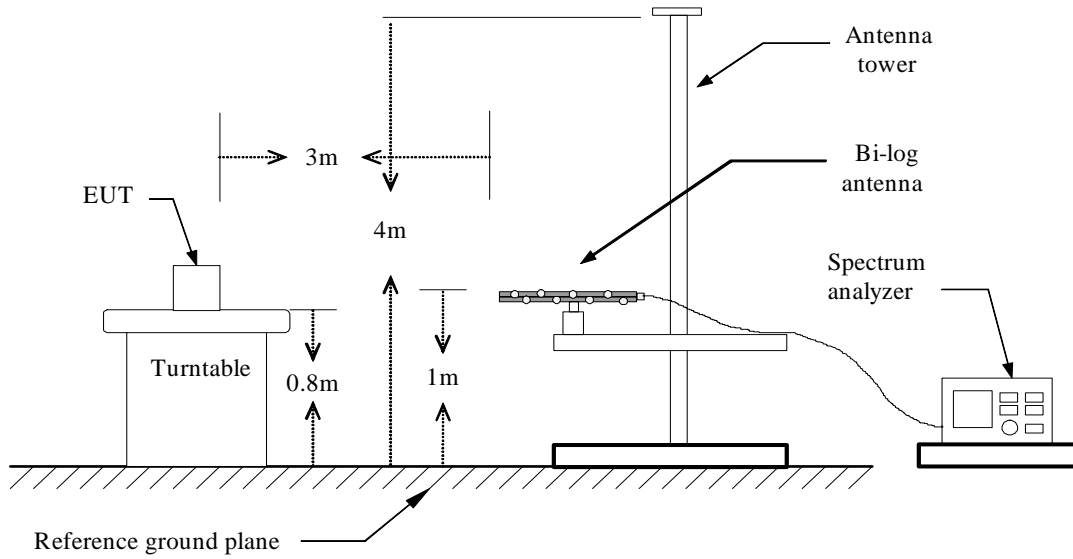

Above 1 GHz

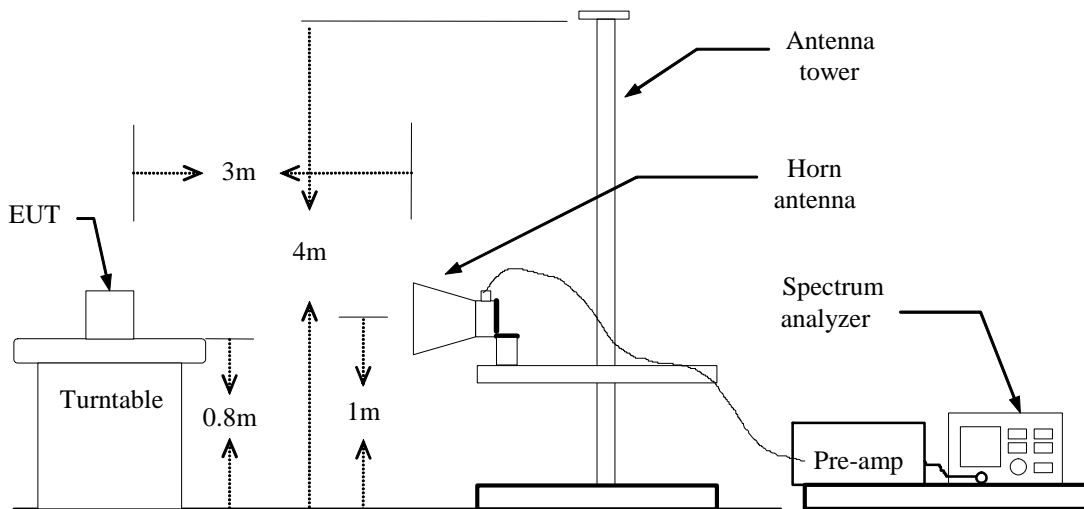

For Substituted Method Test Set-UP

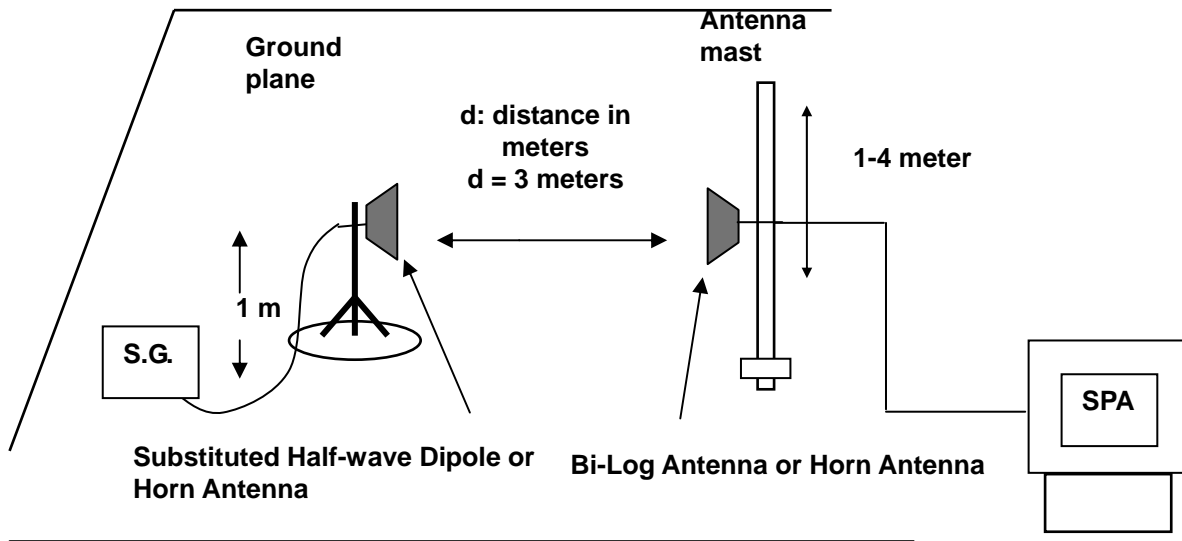

3.4. Test Procedure

The measurement is made according to ANSI/TIA-603-C-2004 as follows:

The EUT was placed on a non-conductive turntable using a non-conductive support. The radiated emission at the fundamental frequency was measured at 3 m with a test antenna and EMI spectrum analyzer.

During the measurement of the EUT, the resolution bandwidth was set to 3MHz and the average bandwidth was set to 3MHz. The highest emission was recorded with the rotation of the turntable and the lowering of the test antenna. The reading was recorded and the field strength (E in dBuV/m) was calculated.

ERP in frequency band 824-849MHz, and EIRP in frequency band 1851.25 –1910MHz were measured using a substitution method. The EUT was replaced by half-wave dipole (824-849MHz) or horn antenna (1851.25-1910MHz) connected to a signal generator. The spectrum analyzer reading was recorded and ERP/EIRP was calculated as follows:

$$\text{ERP} = \text{S.G. output (dBm)} + \text{Antenna Gain (dBd)} - \text{Cable (dB)}$$

$$\text{EIRP} = \text{S.G. output (dBm)} + \text{Antenna Gain (dBi)} - \text{Cable (dB)}$$

3.5. Uncertainty

The measurement uncertainty is defined as for Field Strength of Spurious Radiation measurement is ± 3.072 dB.

3.6. Test Result

Model Number	FD-400eTi						
Test Item	ERP/EIRP						
Test Mode	Mode 1: GPRS 850 Link						
Date of Test	08/05/2010				Test Site	TE01	
Bands	Frequency (MHz)	Ant. Polar.	Read Level (dBm)	Correction factor (dBm)	ERP		Limit
					(dBm)	(W)	
GSM 850	824.2	H	11.85	8.66	20.51	0.112	< 7W
		V	2.91	7.84	10.75	0.012	< 7W
	836.4	H	11.73	10.26	21.99	0.158	< 7W
		V	3.30	7.96	11.26	0.013	< 7W
	848.8	H	11.63	11.63	23.26	0.212	< 7W
		V	4.92	7.86	12.78	0.019	< 7W

Model Number	Smartphone						
Test Item	ERP/EIRP						
Test Mode	Mode 2: GPRS 1900 Link						
Date of Test	08/02/2010				Test Site	TE01	
Bands	Frequency (MHz)	Ant. Polar.	Read Level (dBm)	Correction factor (dBm)	EIRP		Limit
					(dBm)	(W)	
GSM 1900	1850.20	H	15.35	10.42	25.77	0.378	< 2W
		V	11.93	8.26	20.19	0.104	< 2W
	1880.00	H	13.96	10.44	24.40	0.275	< 2W
		V	11.78	8.50	20.28	0.107	< 2W
	1909.80	H	15.68	10.43	26.11	0.408	< 2W
		V	12.14	8.72	20.86	0.122	< 2W

Note: 1. ERP/EIRP = Read Level + Correction factor.

2. For WCDMA signals, a peak detector is used with RBW = VBW = 5MHz.

3. For AMPS, GSM, and NADC TDMA signals, a peak detector is used, with RBW = VBW= 1 MHz.

4 Occupied Bandwidth Test

4.1. Limit

The Occupied Bandwidth Limit:

N/A.

The Band Edge Limit:

The power of any emission outside of the authorized operating frequency ranges must be attenuated below the transmitting power (P) by a factor of at least $43 + 10\log(P)$ dB.

4.2. Test Instruments

Describe	Manufacturer	Model No.	Serial No.	Cal. Date	Remark
Spectrum Analyzer	Agilent	E4445A	MY46181986	05/14/2009	(2)
Universal Radio Communication Tester	ROHDE & SCHWARZ	CMU200	109369	07/29/2009	(2)
Attenuator	RADIALL	R41572000	0603033073	N.C.R.	-----
Power divider	Agilent	87302C	3239A00760	N.C.R.	-----
Test Site	ATL	TE02	TE02	N.C.R.	-----

Remark: ⁽¹⁾ Calibration period 1 year. ⁽²⁾ Calibration period 2 years.

NOTE: N.C.R. = No Calibration Request.

4.3. Setup

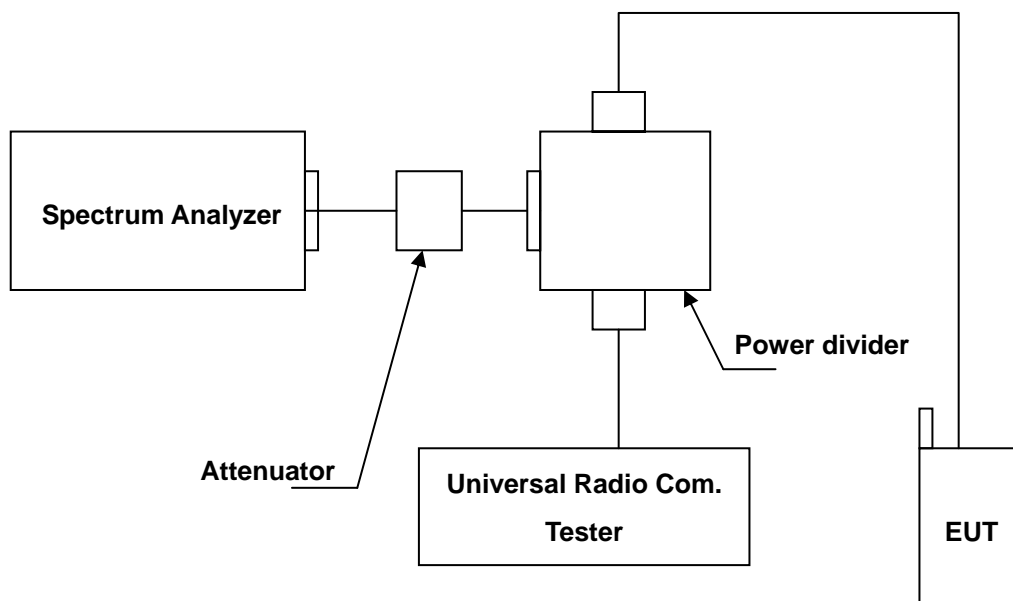

4.4. Test Procedure

The measurement is made according to FCC rules part 22 and 24:

1. The EUT was connected to Spectrum Analyzer and Base Station via power divider.
2. The occupied bandwidth of middle channel for the highest and lowest RF powers was measured.
3. The band edge of low and high channels for the highest RF powers within the transmitting frequency band were measured. Setting RBW as roughly BW/100.
4. The band edge setting:
 - a. RB=3 kHz; VB=3 kHz for GSM 850 and PCS 1900.
 - b. RB=100 kHz; VB=100 kHz for WCDMA Band V and WCDMA Band II.

4.5. Uncertainty

The measurement uncertainty is defined as $\pm 10\text{Hz}$

4.6. Test Result

99% Occupied Bandwidth

Model Number	FD-400eTi		
Test Item	Occupied Bandwidth		
Test Mode	Mode 1: GPRS 850 Link		
Date of Test	08/02/2010	Test Site	TE02
Channel No.	Frequency (MHz)	99% Bandwidth (kHz)	Note
128	824.2	244.8748	RBW:3KHz , VBW:10KHz
190	836.4	249.4038	RBW:3KHz , VBW:10KHz
251	848.8	242.3199	RBW:3KHz , VBW:10KHz

Channel 128

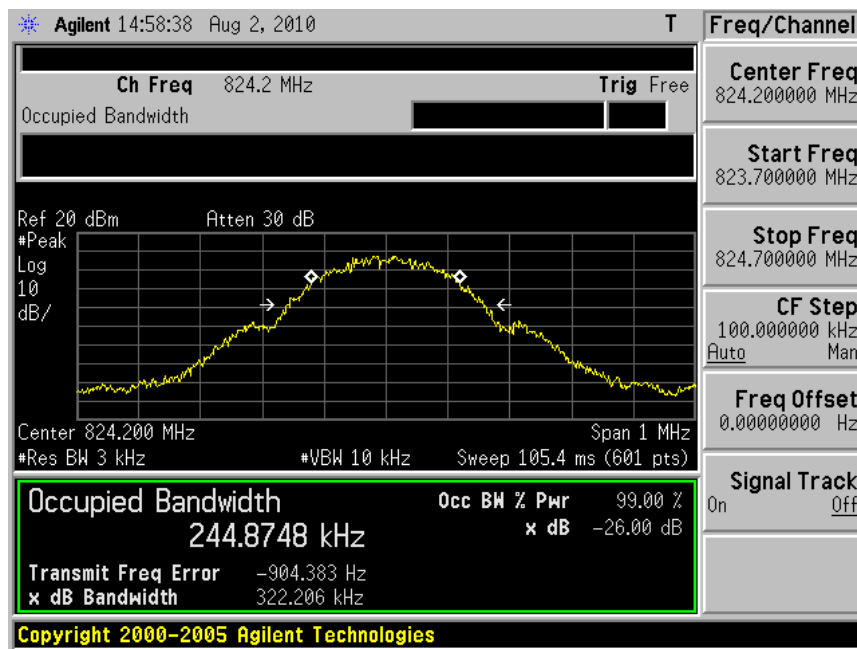

Channel 190

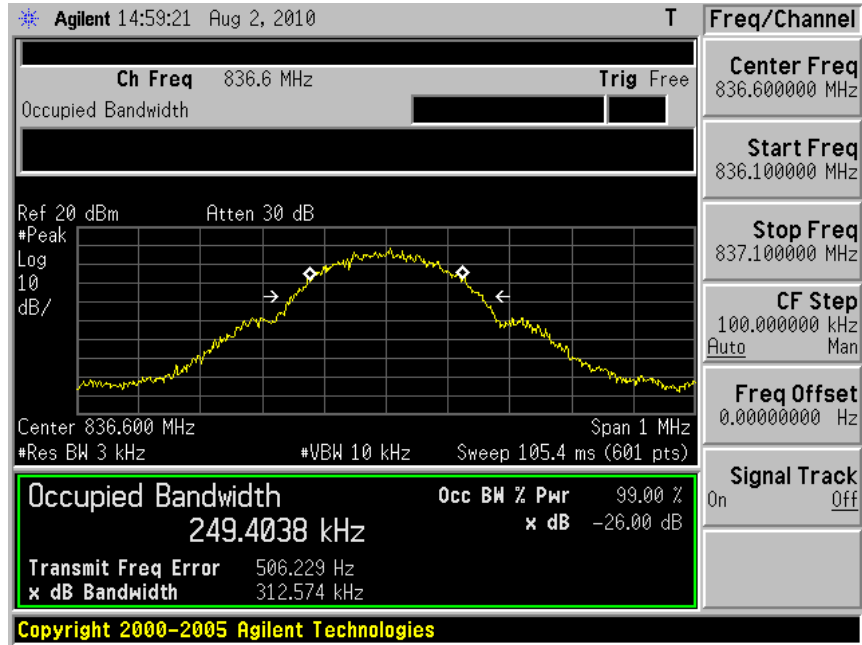

Channel 251

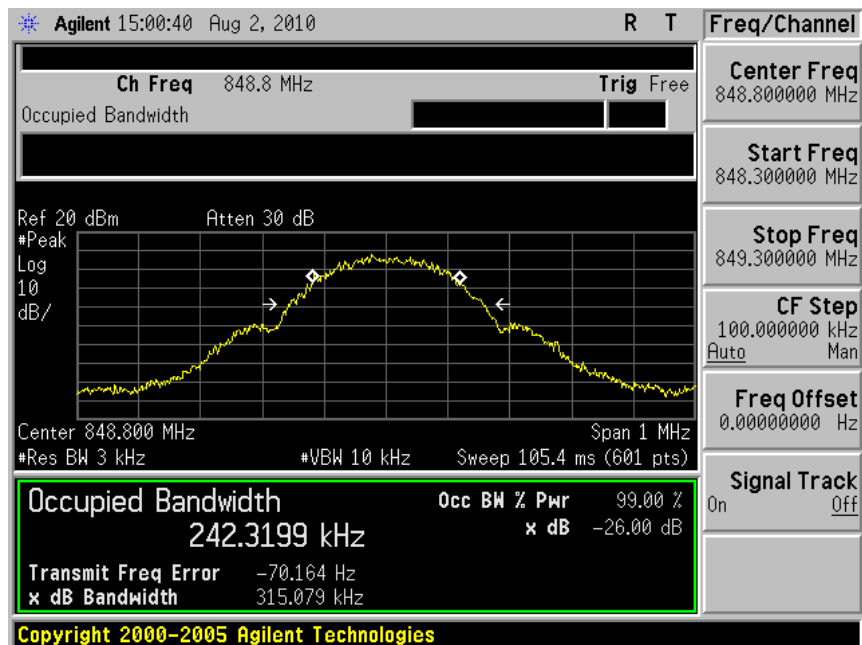

Model Number	FD-400eTi		
Test Item	Occupied Bandwidth		
Test Mode	Mode 2: GPRS 1900 Link		
Date of Test	08/02/2010	Test Site	TE02
Channel No.	Frequency (MHz)	99% Bandwidth (kHz)	Note
512	1850.20	245.0303	RBW:3KHz , VBW:10KHz
661	1880.00	246.6046	RBW:3KHz , VBW:10KHz
810	1909.80	246.9660	RBW:3KHz , VBW:10KHz

Channel 512

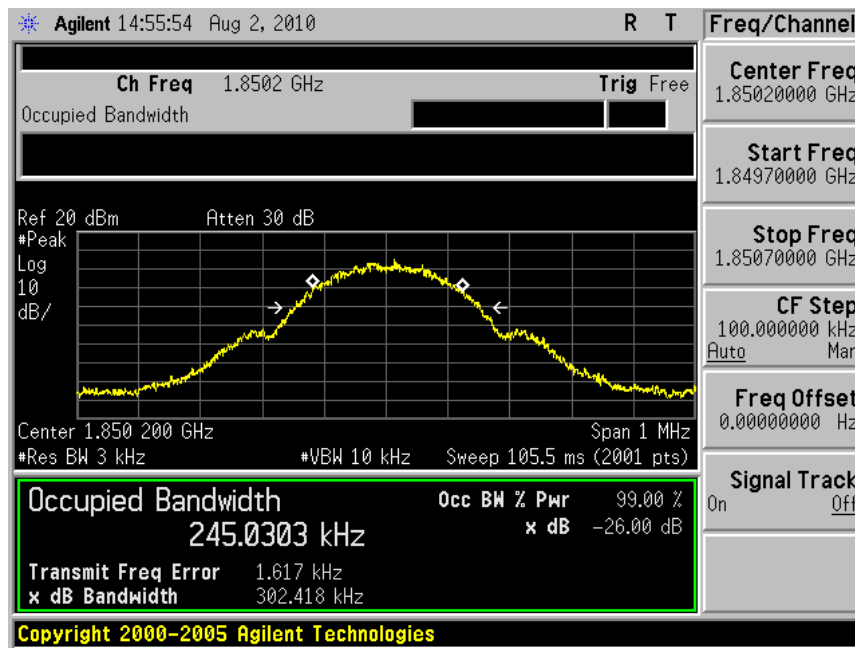

Channel 661

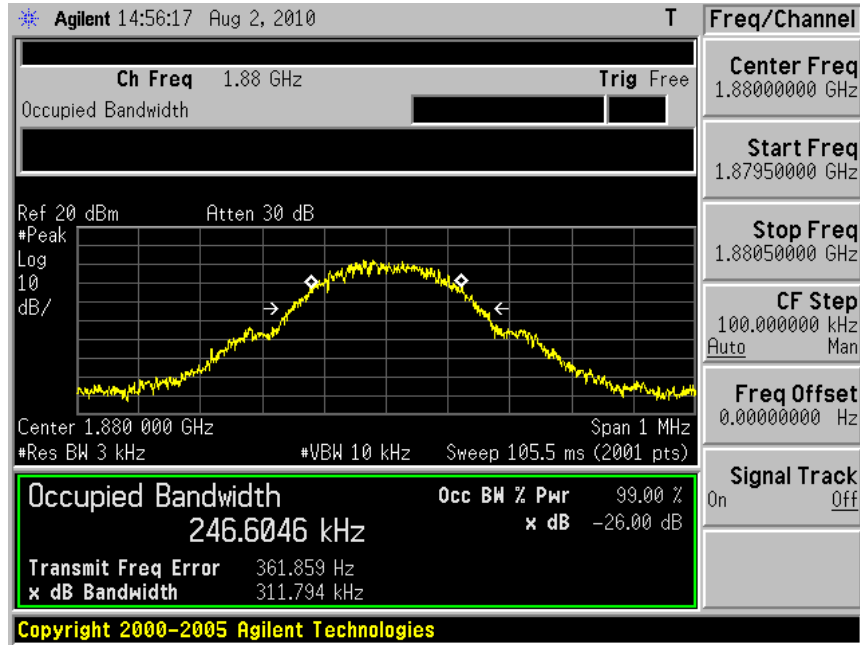

Channel 810

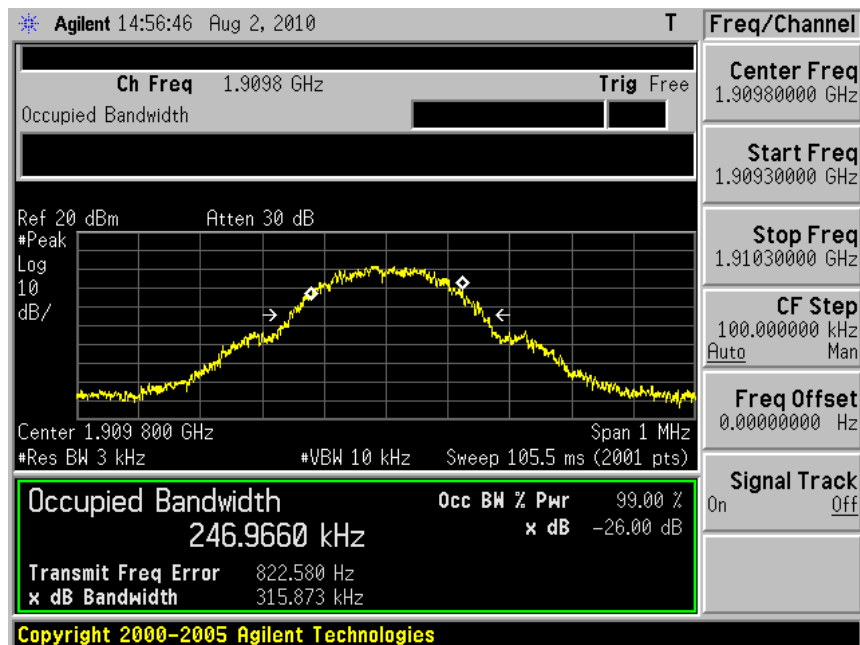

Band Edge

Model Number	FD-400eTi				
Test Item	Band Edge				
Test Mode	Mode 1: GPRS 850 Link				
Date of Test	08/03/2010		Test Site	TE02	
Band	Channel	Frequency (MHz)	Bandwidth (dBm)	Limit (dBm)	Result
Lower	128	824.0000	-14.11	-13	Pass
Higher	251	849.0000	-18.31	-13	Pass

Lower Band

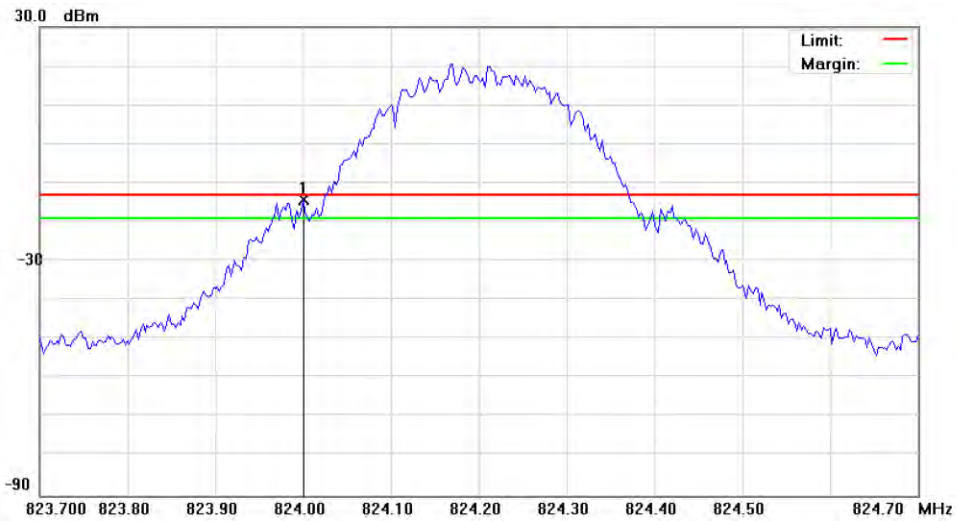

Higher Band

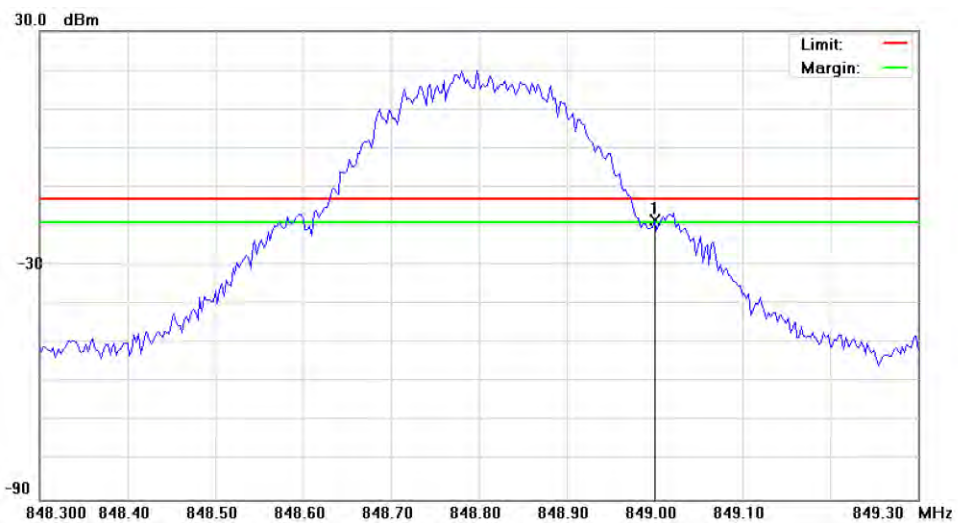

Model Number	FD-400eTi				
Test Item	Band Edge				
Test Mode	Mode 2: GPRS 1900 Link				
Date of Test	08/03/2010		Test Site	TE02	
Band	Channel	Frequency (MHz)	Bandwidth (dBm)	Limit (dBm)	Result
Lower	512	1850.000	-22.83	-13	Pass
Higher	810	1910.000	-22.08	-13	Pass

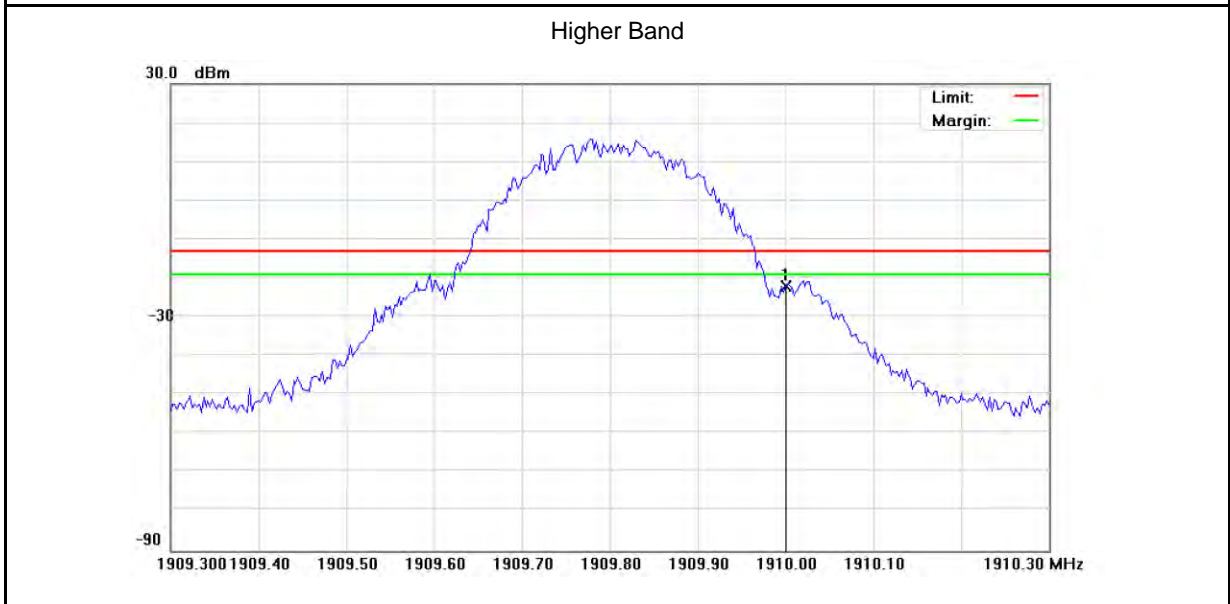
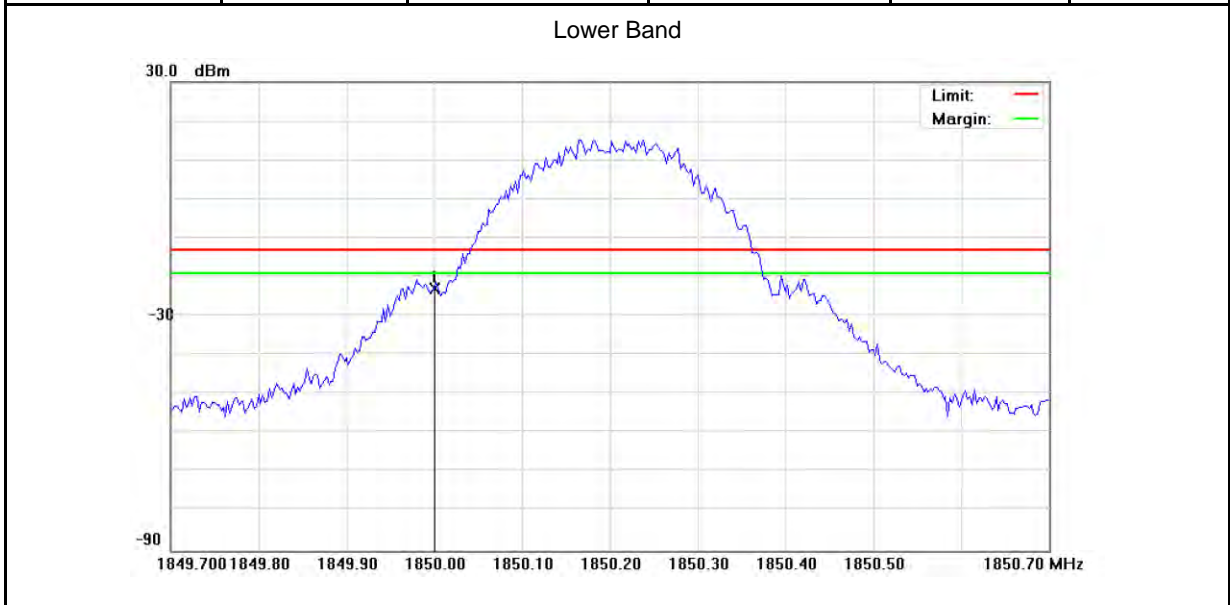

5 Conducted Emission Test

5.1. Limit

The power of any emission outside of the authorized operating frequency ranges must be attenuated below the transmitting power (P) by a factor of at least $43 + 10\log(P)$ dB.

5.2. Test Instruments

Describe	Manufacturer	Model No.	Serial No.	Cal. Date	Remark
Spectrum Analyzer	Agilent	E4445A	MY46181986	05/14/2009	(2)
Universal Radio Communication Tester	ROHDE & SCHWARZ	CMU200	109369	07/29/2009	(2)
Attenuator	RADIALL	R41572000	0603033073	N.C.R.	-----
Power divider	Agilent	87302C	3239A00760	N.C.R.	-----
Test Site	ATL	TE02	TE02	N.C.R.	-----

Remark: ⁽¹⁾ Calibration period 1 year. ⁽²⁾ Calibration period 2 years.

NOTE: N.C.R. = No Calibration Request.

5.3. Setup

Below 2.8GHz

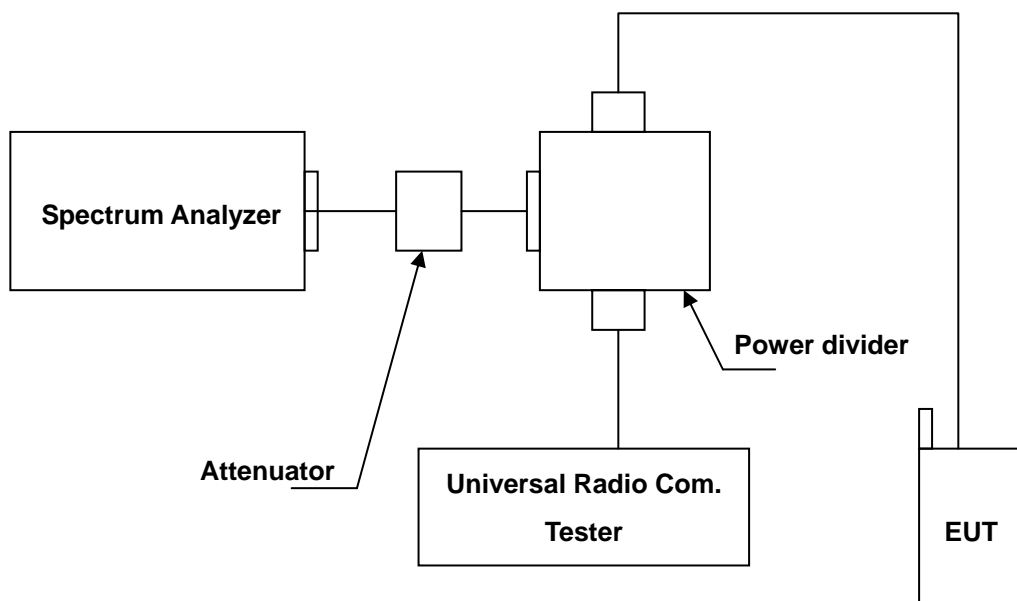

Above 2.8GHz

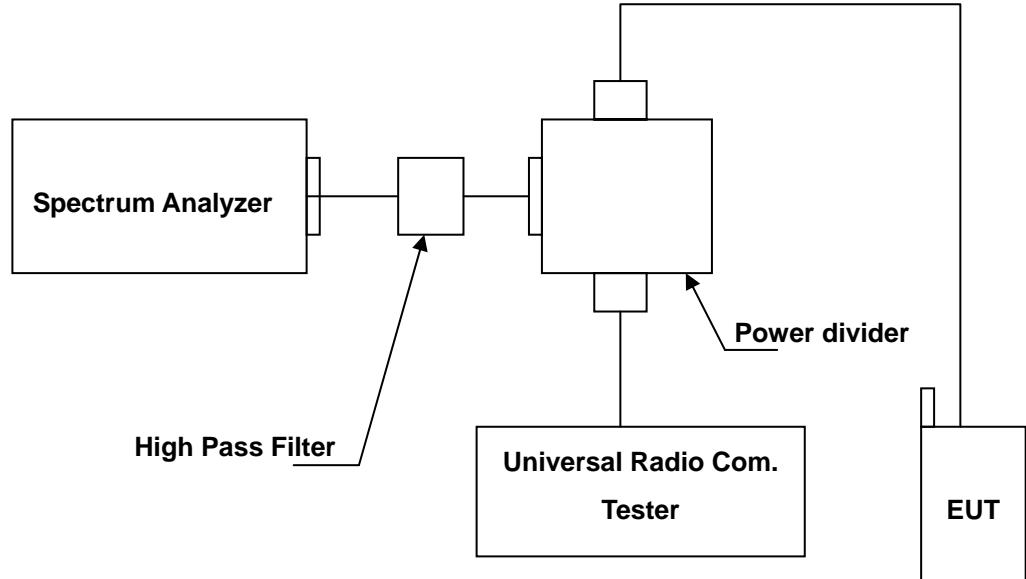

5.4. Test Procedure

1. The EUT was connected to Spectrum Analyzer and Base Station via power divider.
2. The middle channel for the highest RF power within the transmitting frequency was measured.
3. The conducted spurious emission for the whole frequency range was taken.
4. Test setting at GSM 850 RB>100 kHz, VB>100 kHz; PCS 1900 RB>1MHz, VB>1MHz.

5.5. Uncertainty

The measurement uncertainty is evaluated as ± 2.24 dB.

5.6. Test Result

Model Number	FD-400eTi		
Test Item	Conducted Emission		
Mode	Mode 1: GPRS 850 Link Mode 2: GPRS 1900 Link		
Date of Test	08/03/2010	Test Site	TE02

File:FD-400eTi(CH128) Data :#1 Date: 2010/8/3 Time: PM 07:54:38

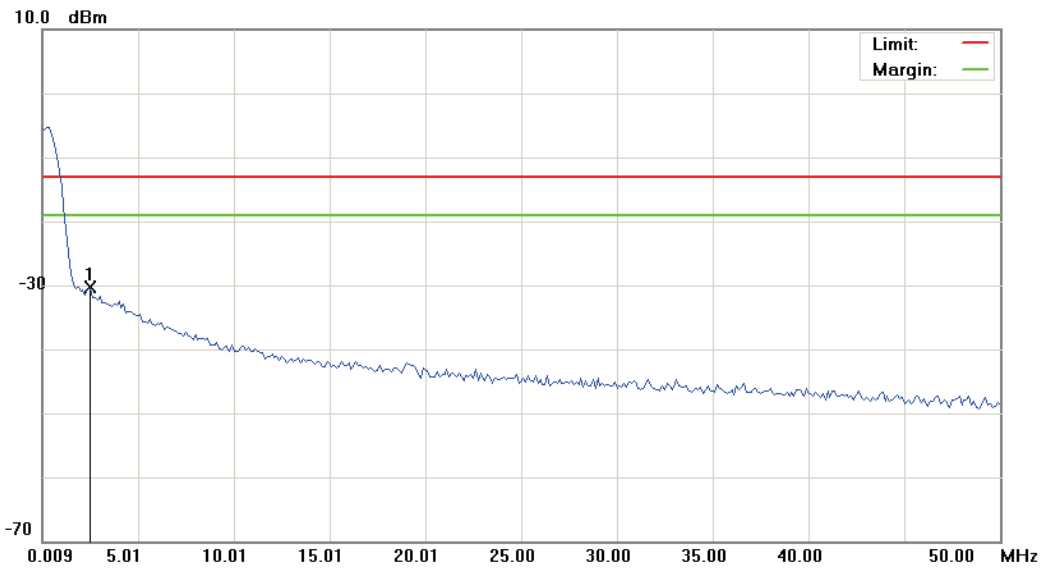

Site: : RF Conducted	Polarization: <i>Conducted po</i>	Temperature: 26 °C
Limit: FCC Part 22 conducted(9k-12.75G)	Power: AC 120V/60Hz	Humidity: 55 %
EUT: Portable Terminal	Distance:	RBW: 1000 KHz VBW: 1000 KHz
M/N: FD-400eTi		
Mode: GSM850		
Note: CH128(824.2MHz)		

No.	Mk.	Freq. MHz	Reading Level dBm	Correct Factor dB	Measure- ment dBm	Limit dBm	Over dB	Detector	Antenna Height cm	Table Degree degree	Comment
1	*	2.5086	-60.97	30.68	-30.29	-13.00	-17.29	peak			

*:Maximum data x:Over limit !:over margin

File:FD-400eTi(CH128) Data :#2 Date: 2010/8/3 Time: PM 07:54:57

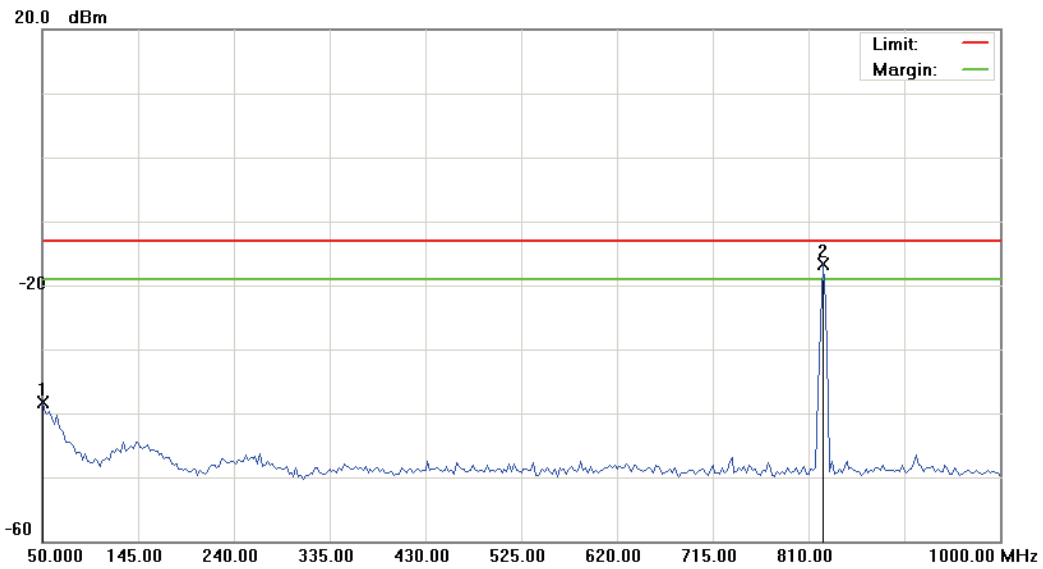

Site: : RF Conducted	Polarization: <i>Conducted po</i>	Temperature: 26 °C
Limit: FCC Part 22 conducted(9k-12.75G)	Power: AC 120V/60Hz	Humidity: 55 %
EUT: Portable Terminal	Distance:	RBW: 1000 KHz VBW: 1000 KHz
M/N: FD-400eTi		
Mode: GSM850		
Note: CH128(824.2MHz)		

No.	Mk.	Freq. MHz	Reading Level dBm	Correct Factor dB	Measure- ment dBm	Limit dBm	Over dB	Antenna Height cm	Table Degree degree	Comment
1		50.0000	-53.03	14.69	-38.34	-13.00	-25.34	peak		
2	*	824.2500	-20.44	3.84	-16.60	-13.00	-3.60	peak		Tx

*:Maximum data x:Over limit !:over margin

File:FD-400eTi(CH128) Data :#3 Date: 2010/8/3 Time: PM 08:18:28

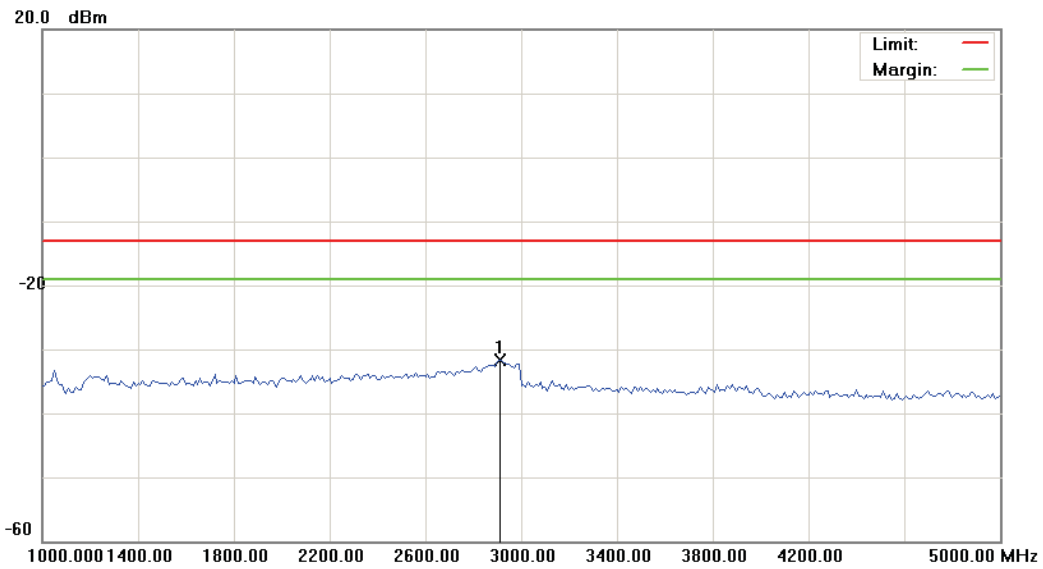

Site: : RF Conducted	Polarization: <i>Conducted po</i>	Temperature: 26 °C
Limit: FCC Part 22 conducted(9k-12.75G)	Power: AC 120V/60Hz	Humidity: 55 %
EUT: Portable Terminal	Distance:	RBW: 1000 KHz VBW: 1000 KHz
M/N: FD-400eTi		
Mode: GSM850		
Note: CH128(824.2MHz)		

No.	Mk.	Freq. MHz	Reading Level dBm	Correct Factor dB	Measure- ment dBm	Limit dBm	Over dB	Detector	Antenna Height cm	Table Degree degree	Comment
1	*	2910.000	-36.45	4.72	-31.73	-13.00	-18.73	peak			

*:Maximum data x:Over limit !:over margin

File:FD-400eTi(CH128) Data :#4 Date: 2010/8/3 Time: PM 08:18:49

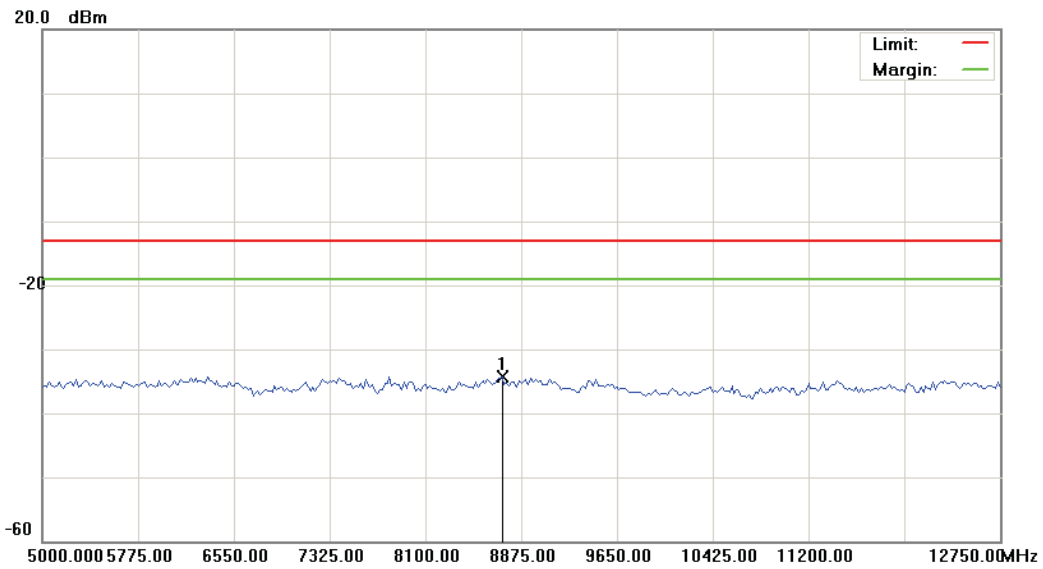

Site: : RF Conducted	Polarization: <i>Conducted po</i>	Temperature: 26 °C
Limit: FCC Part 22 conducted(9k-12.75G)	Power: AC 120V/60Hz	Humidity: 55 %
EUT: Portable Terminal	Distance:	RBW: 1000 KHz VBW: 1000 KHz
M/N: FD-400eTi		
Mode: GSM850		
Note: CH128(824.2MHz)		

No.	Mk.	Freq. MHz	Reading Level dBm	Correct Factor dB	Measure- ment dBm	Limit dBm	Over dB	Antenna Height cm	Table Degree degree	Comment
1	*	8720.000	-39.48	5.18	-34.30	-13.00	-21.30	peak		

*:Maximum data x:Over limit !:over margin

File:FD-400eTi(CH190) Data :#1 Date: 2010/8/3 Time: PM 07:56:14

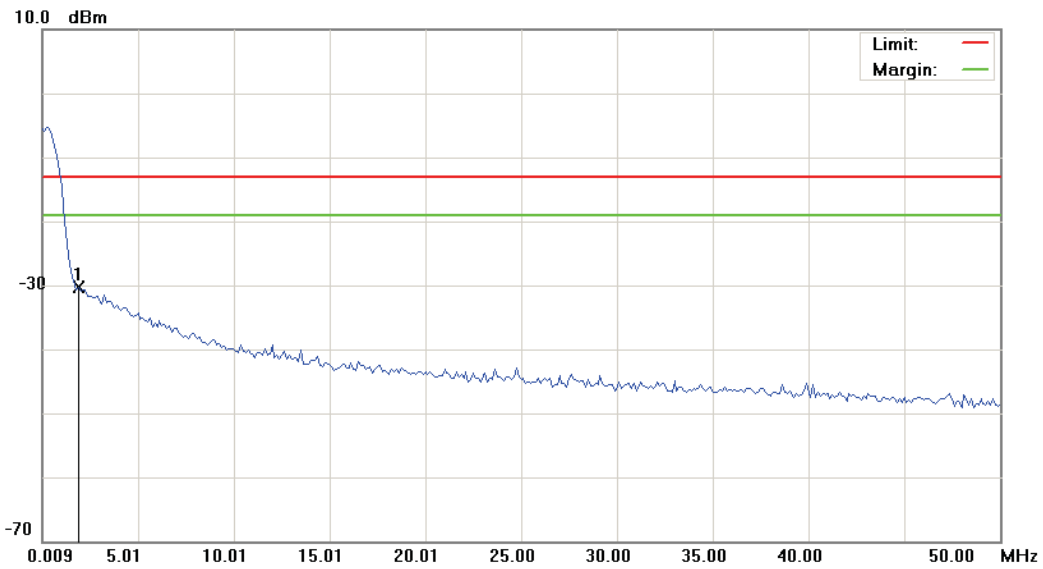

Site: : RF Conducted	Polarization: <i>Conducted po</i>	Temperature: 26 °C
Limit: FCC Part 22 conducted(9k-12.75G)	Power: AC 120V/60Hz	Humidity: 55 %
EUT: Portable Terminal	Distance:	RBW: 1000 KHz VBW: 1000 KHz
M/N: FD-400eTi		
Mode: GSM850		
Note: CH190(836.6MHz)		

No.	Mk.	Freq. MHz	Reading Level dBm	Correct Factor dB	Measure- ment dBm	Limit dBm	Over dB	Detector	Antenna Height cm	Table Degree	Comment
1	*	1.8837	-61.47	31.17	-30.30	-13.00	-17.30	peak		degree	

*:Maximum data x:Over limit !:over margin

File:FD-400eTi(CH190) Data :#2 Date: 2010/8/3 Time: PM 07:56:33

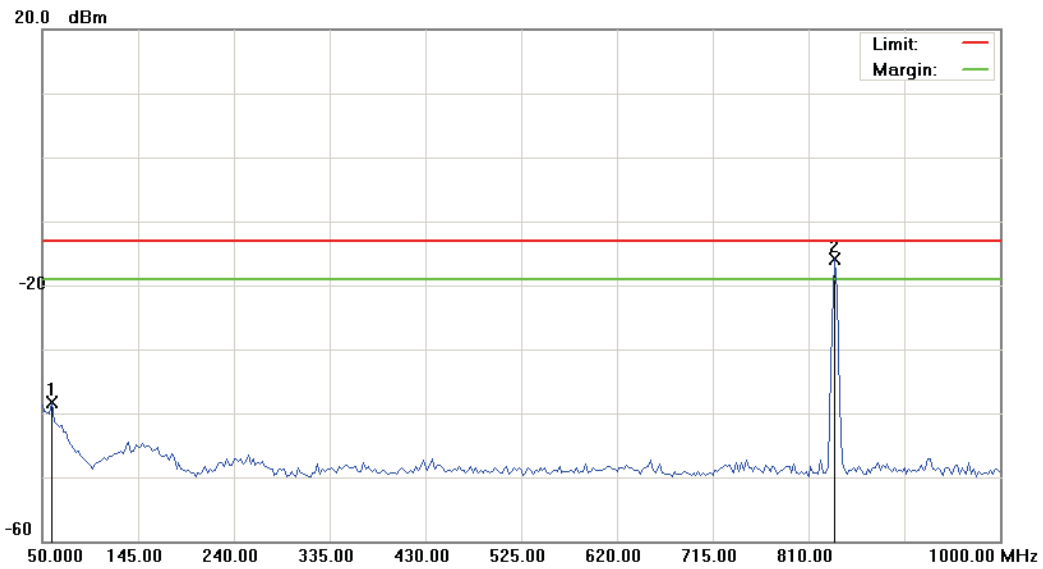

Site: : RF Conducted	Polarization: <i>Conducted po</i>	Temperature: 26 °C
Limit: FCC Part 22 conducted(9k-12.75G)	Power: AC 120V/60Hz	Humidity: 55 %
EUT: Portable Terminal	Distance:	RBW: 1000 KHz VBW: 1000 KHz
M/N: FD-400eTi		
Mode: GSM850		
Note: CH190(836.6MHz)		

No.	Mk.	Freq. MHz	Reading Level dBm	Correct Factor dB	Measure- ment dBm	Limit dBm	Over dB	Detector	Antenna Height cm	Table Degree degree	Comment
1		59.5000	-51.24	12.97	-38.27	-13.00	-25.27	peak			
2	*	836.1250	-19.92	3.96	-15.96	-13.00	-2.96	peak			Tx

*:Maximum data x:Over limit !:over margin

File:FD-400eTi(CH190) Data :#3 Date: 2010/8/3 Time: PM 08:17:04

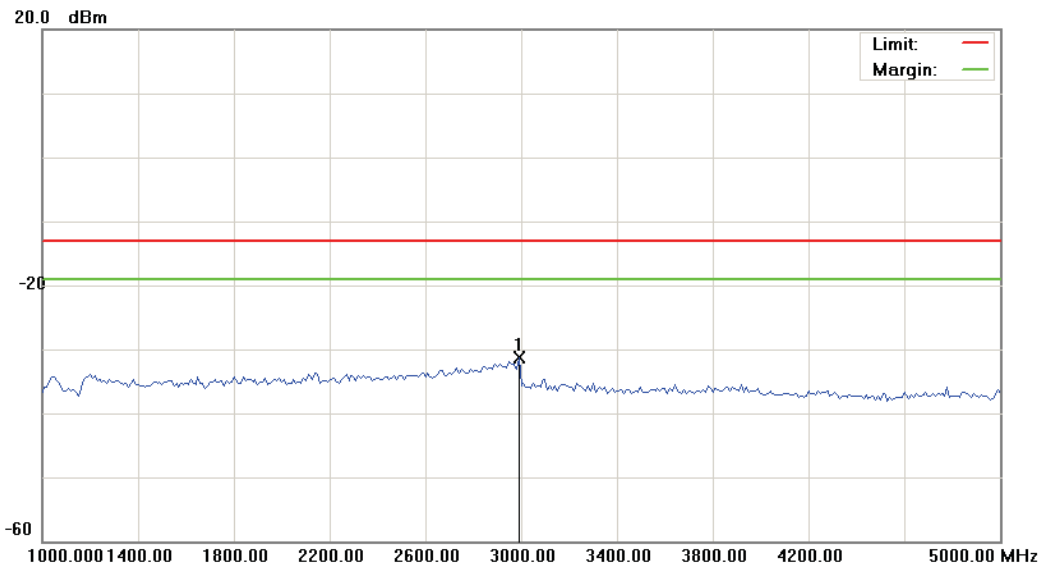

Site: : RF Conducted	Polarization: <i>Conducted po</i>	Temperature: 26 °C
Limit: FCC Part 22 conducted(9k-12.75G)	Power: AC 120V/60Hz	Humidity: 55 %
EUT: Portable Terminal	Distance:	RBW: 1000 KHz VBW: 1000 KHz
M/N: FD-400eTi		
Mode: GSM850		
Note: CH190(836.6MHz)		

No.	Mk.	Freq. MHz	Reading Level dBm	Correct Factor dB	Measure- ment dBm	Limit dBm	Over dB	Antenna Height cm	Table Degree degree	Comment
1	*	2990.000	-35.87	4.53	-31.34	-13.00	-18.34			peak

*:Maximum data x:Over limit !:over margin

File:FD-400eTi(CH190) Data :#4 Date: 2010/8/3 Time: PM 08:17:25

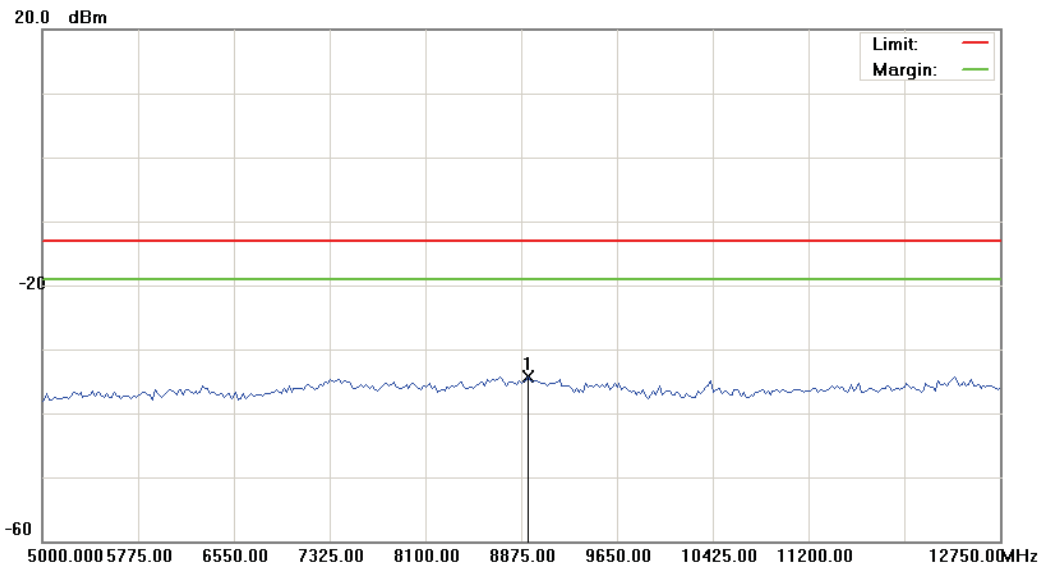

Site: : RF Conducted	Polarization: <i>Conducted po</i>	Temperature: 26 °C
Limit: FCC Part 22 conducted(9k-12.75G)	Power: AC 120V/60Hz	Humidity: 55 %
EUT: Portable Terminal	Distance:	RBW: 1000 KHz VBW: 1000 KHz
M/N: FD-400eTi		
Mode: GSM850		
Note: CH190(836.6MHz)		

No.	Mk.	Freq. MHz	Reading Level dBm	Correct Factor dB	Measure- ment dBm	Limit dBm	Over dB	Antenna Height cm	Table Degree degree	Comment
1	*	8933.125	-39.71	5.48	-34.23	-13.00	-21.23	peak		

*:Maximum data x:Over limit !:over margin

File:FD-400eTi(CH251) Data :#1 Date: 2010/8/3 Time: PM 07:57:28

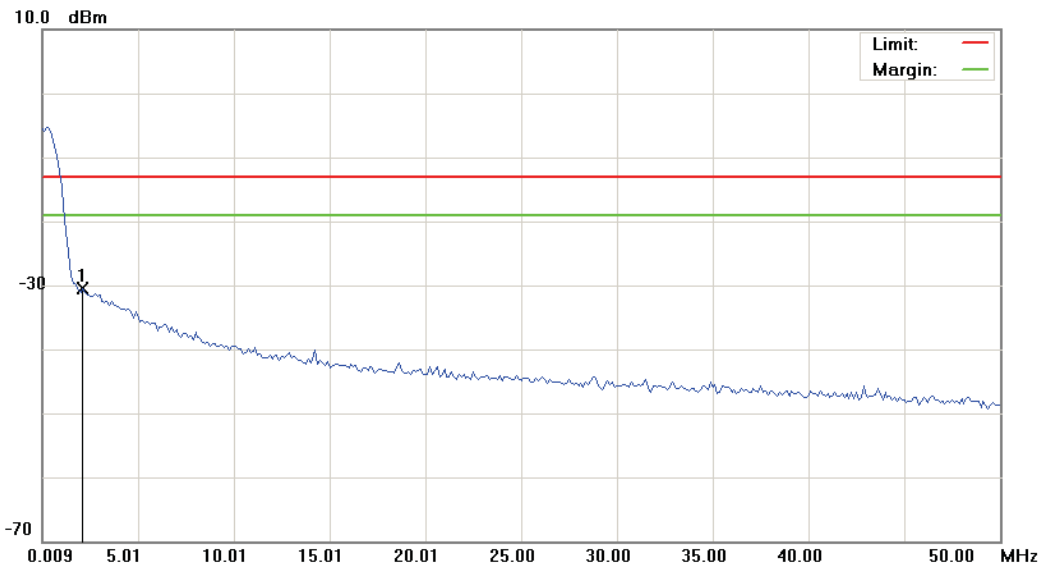

Site: : RF Conducted	Polarization: <i>Conducted po</i>	Temperature: 26 °C
Limit: FCC Part 22 conducted(9k-12.75G)	Power: AC 120V/60Hz	Humidity: 55 %
EUT: Portable Terminal	Distance:	RBW: 1000 KHz VBW: 1000 KHz
M/N: FD-400eTi		
Mode: GSM850		
Note: CH251(848.8MHz)		

No.	Mk.	Freq. MHz	Reading Level dBm	Correct Factor dB	Measure- ment dBm	Limit dBm	Over dB	Detector	Antenna Height cm	Table Degree degree	Comment
1	*	2.1336	-62.06	31.47	-30.59	-13.00	-17.59	peak			

*:Maximum data x:Over limit !:over margin

File:FD-400eTi(CH251) Data :#2 Date: 2010/8/3 Time: PM 07:57:47

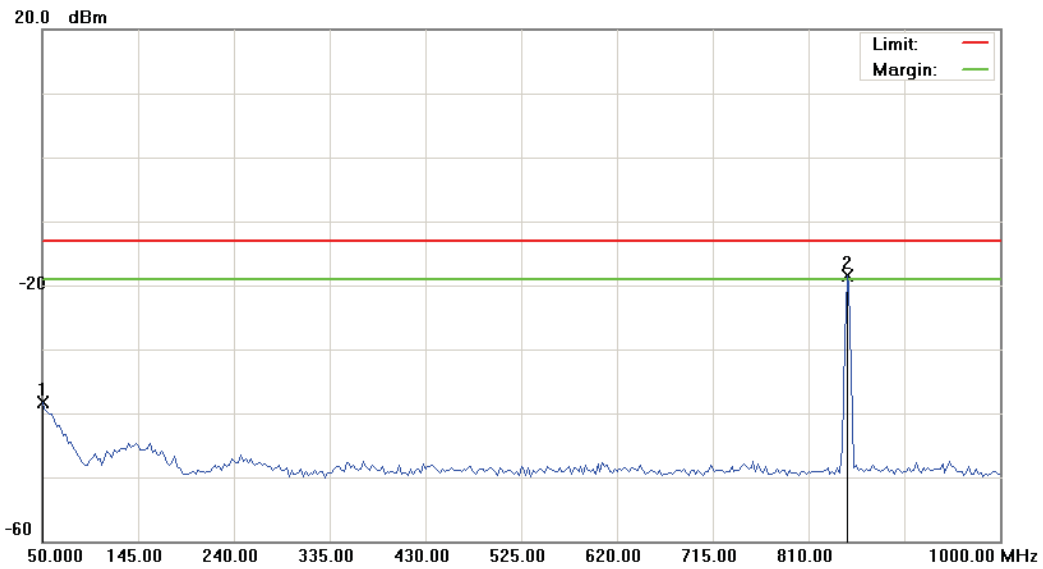

Site: : RF Conducted	Polarization: <i>Conducted po</i>	Temperature: 26 °C
Limit: FCC Part 22 conducted(9k-12.75G)	Power: AC 120V/60Hz	Humidity: 55 %
EUT: Portable Terminal	Distance:	RBW: 1000 KHz VBW: 1000 KHz
M/N: FD-400eTi		
Mode: GSM850		
Note: CH251(848.8MHz)		

No.	Mk.	Freq. MHz	Reading Level dBm	Correct Factor dB	Measure- ment dBm	Limit dBm	Over dB	Antenna Height cm	Table Degree degree	Comment
1		50.0000	-53.06	14.69	-38.37	-13.00	-25.37	peak		
2	*	848.0000	-22.42	3.98	-18.44	-13.00	-5.44	peak		Tx

*:Maximum data x:Over limit !:over margin

File:FD-400eTi(CH251) Data :#3 Date: 2010/8/3 Time: PM 08:15:53

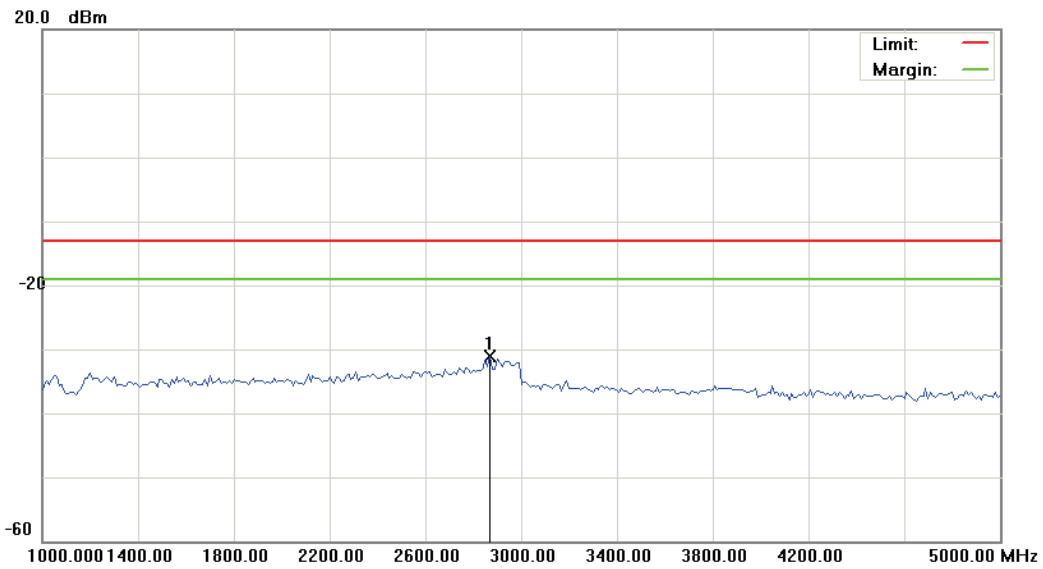

Site: : RF Conducted	Polarization: <i>Conducted po</i>	Temperature: 26 °C
Limit: FCC Part 22 conducted(9k-12.75G)	Power: AC 120V/60Hz	Humidity: 55 %
EUT: Portable Terminal	Distance:	RBW: 1000 KHz VBW: 1000 KHz
M/N: FD-400eTi		
Mode: GSM850		
Note: CH251(848.8MHz)		

No.	Mk.	Freq. MHz	Reading Level dBm	Correct Factor dB	Measure- ment dBm	Limit dBm	Over dB	Antenna Height cm	Table Degree degree	Comment
1	*	2870.000	-35.68	4.60	-31.08	-13.00	-18.08	peak		

*:Maximum data x:Over limit !:over margin

File:FD-400eTi(CH251) Data :#4 Date: 2010/8/3 Time: PM 08:16:14

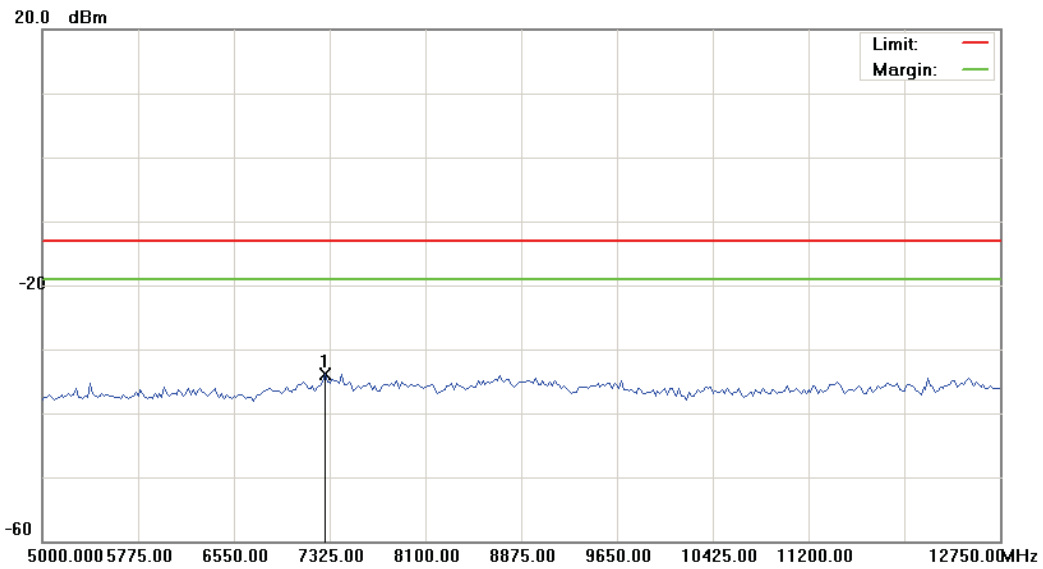

Site: : RF Conducted	Polarization: <i>Conducted po</i>	Temperature: 26 °C
Limit: FCC Part 22 conducted(9k-12.75G)	Power: AC 120V/60Hz	Humidity: 55 %
EUT: Portable Terminal	Distance:	RBW: 1000 KHz VBW: 1000 KHz
M/N: FD-400eTi		
Mode: GSM850		
Note: CH251(848.8MHz)		

No.	Mk.	Freq. MHz	Reading Level dBm	Correct Factor dB	Measure- ment dBm	Limit dBm	Over dB	Antenna Height cm	Table Degree degree	Comment
1	*	7286.250	-38.90	5.06	-33.84	-13.00	-20.84	peak		

*:Maximum data x:Over limit !:over margin

File:FD-400eTi(CH512) Data :#1 Date: 2010/8/3 Time: PM 07:37:25

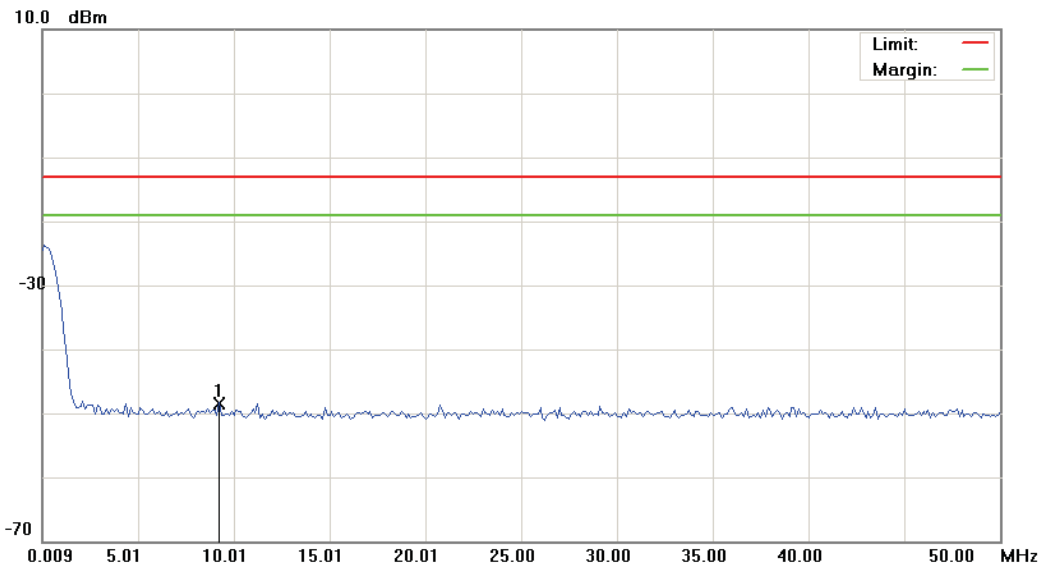

Site: : RF Conducted	Polarization: <i>Conducted po</i>	Temperature: 26 °C
Limit: FCC Part 24 conducted(9k-12.75G)	Power: AC 120V/60Hz	Humidity: 55 %
EUT: Portable Terminal	Distance:	RBW: 1000 KHz VBW: 1000 KHz
M/N: FD-400eTi		
Mode: PCS1900		
Note: CH512(1850.2MHz)		

No.	Mk.	Freq. MHz	Reading Level dBm	Correct Factor dB	Measure- ment dBm	Limit dBm	Over dB	Antenna Height cm	Table Degree	Comment
1	*	9.2573	-61.69	13.29	-48.40	-13.00	-35.40	peak		

*:Maximum data x:Over limit !:over margin

File:FD-400eTi(CH512) Data :#2 Date: 2010/8/3 Time: PM 07:37:44

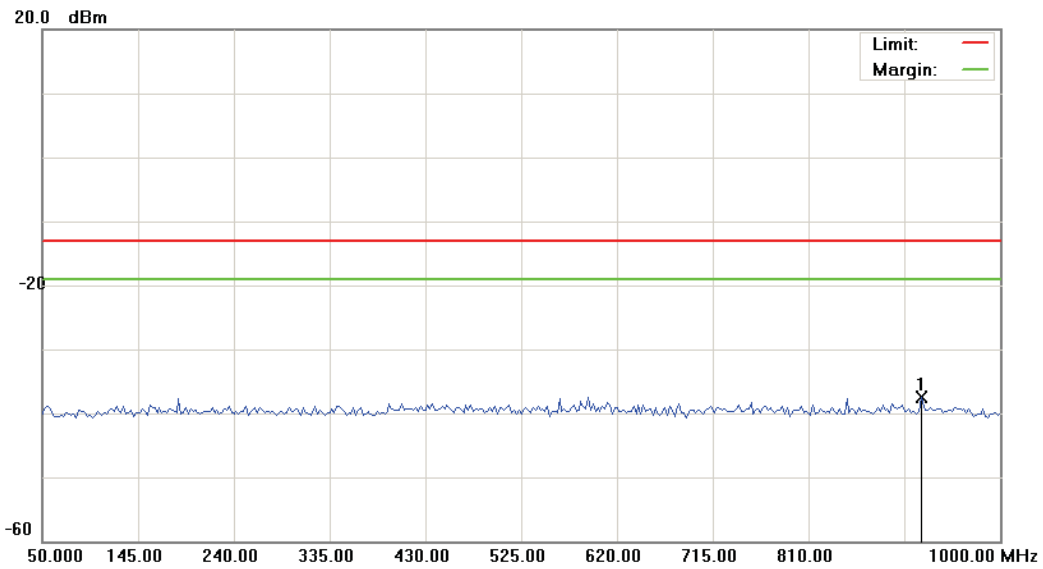

Site: : RF Conducted	Polarization: <i>Conducted po</i>	Temperature: 26 °C
Limit: FCC Part 24 conducted(9k-12.75G)	Power: AC 120V/60Hz	Humidity: 55 %
EUT: Portable Terminal	Distance:	RBW: 1000 KHz VBW: 1000 KHz
M/N: FD-400eTi		
Mode: PCS1900		
Note: CH512(1850.2MHz)		

No.	Mk.	Freq. MHz	Reading Level dBm	Correct Factor dB	Measure- ment dBm	Limit dBm	Over dB	Antenna Height cm	Table Degree degree	Comment
1	*	921.6250	-50.73	13.20	-37.53	-13.00	-24.53	peak		

*:Maximum data x:Over limit !:over margin

File:FD-400eTi(CH512) Data :#3 Date: 2010/8/3 Time: PM 07:46:36

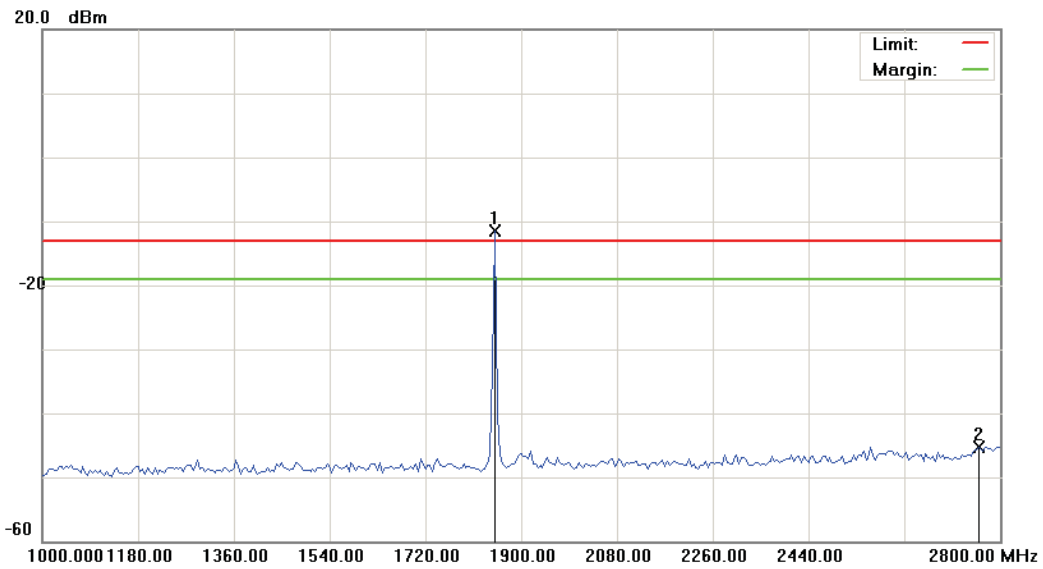

Site: : RF Conducted	Polarization: <i>Conducted po</i>	Temperature: 26 °C
Limit: FCC Part 24 conducted(9k-12.75G)	Power: AC 120V/60Hz	Humidity: 55 %
EUT: Portable Terminal	Distance:	RBW: 1000 KHz VBW: 1000 KHz
M/N: FD-400eTi		
Mode: PCS1900		
Note: CH512(1850.2MHz)		

No.	Mk.	Freq. MHz	Reading Level dBm	Correct Factor dB	Measure- ment dBm	Limit dBm	Over dB	Detector	Antenna Height cm	Table Degree degree	Comment
1	*	1850.500	-15.71	4.26	-11.45	-13.00	1.55	peak			Tx
2		2759.500	-50.81	5.59	-45.22	-13.00	-32.22	peak			

*:Maximum data x:Over limit !:over margin

File:FD-400eTi(CH512) Data :#4 Date: 2010/8/3 Time: PM 08:20:24

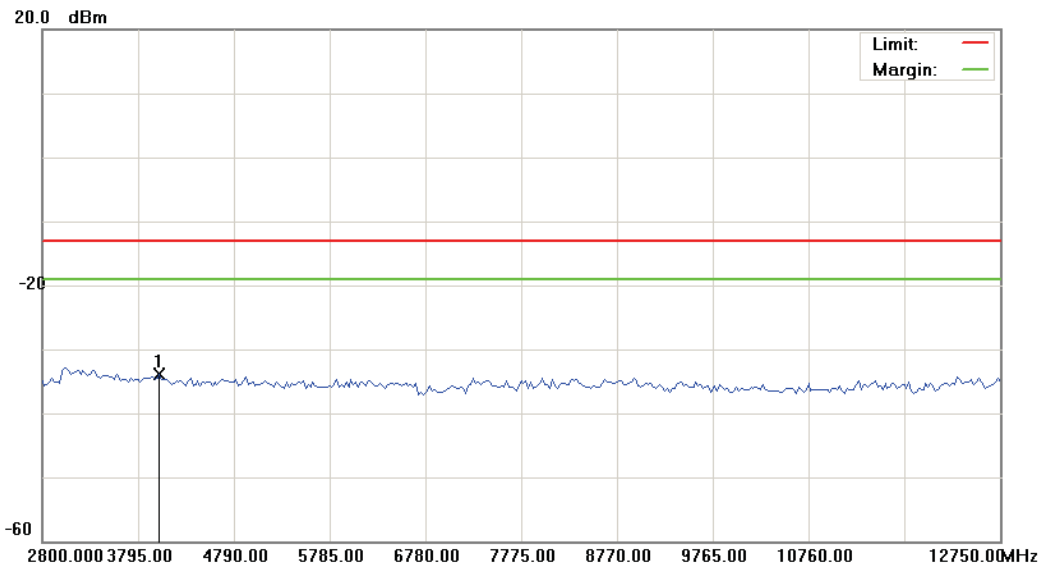

Site: : RF Conducted	Polarization: <i>Conducted po</i>	Temperature: 26 °C
Limit: FCC Part 24 conducted(9k-12.75G)	Power: AC 120V/60Hz	Humidity: 55 %
EUT: Portable Terminal	Distance:	RBW: 1000 KHz VBW: 1000 KHz
M/N: FD-400eTi		
Mode: PCS1900		
Note: CH512(1850.2MHz)		

No.	Mk.	Freq. MHz	Reading Level dBm	Correct Factor dB	Measure- ment dBm	Limit dBm	Over dB	Antenna Height cm	Table Degree degree	Comment
1	*	4018.875	-38.85	4.92	-33.93	-13.00	-20.93	peak		

*:Maximum data x:Over limit !:over margin

File:FD-400eTi(CH512) Data :#5 Date: 2010/8/3 Time: PM 08:20:45

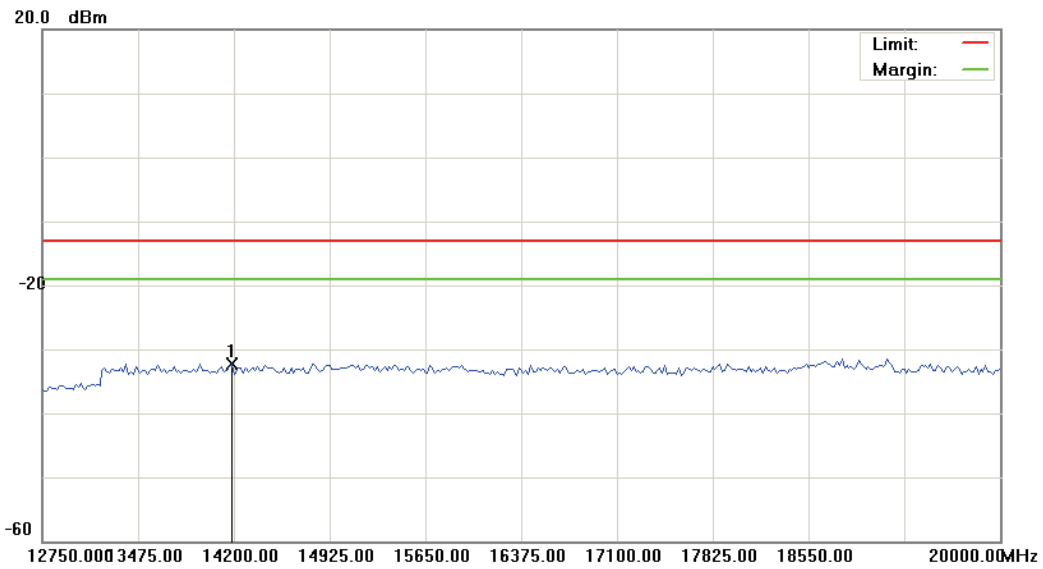

Site: : RF Conducted	Polarization: <i>Conducted po</i>	Temperature: 26 °C
Limit: FCC Part 24 conducted(9k-12.75G)	Power: AC 120V/60Hz	Humidity: 55 %
EUT: Portable Terminal	Distance:	RBW: 1000 KHz VBW: 1000 KHz
M/N: FD-400eTi		
Mode: PCS1900		
Note: CH512(1850.2MHz)		

No.	Mk.	Freq. MHz	Reading Level dBm	Correct Factor dB	Measure- ment dBm	Limit dBm	Over dB	Antenna Height cm	Table Degree degree	Comment
1	*	14181.875	-38.01	5.78	-32.23	-13.00	-19.23	peak		

*:Maximum data x:Over limit !:over margin

File:FD-400eTi(CH661)

Data :#1

Date: 2010/8/3

Time: PM 07:38:33

10.0 dBm

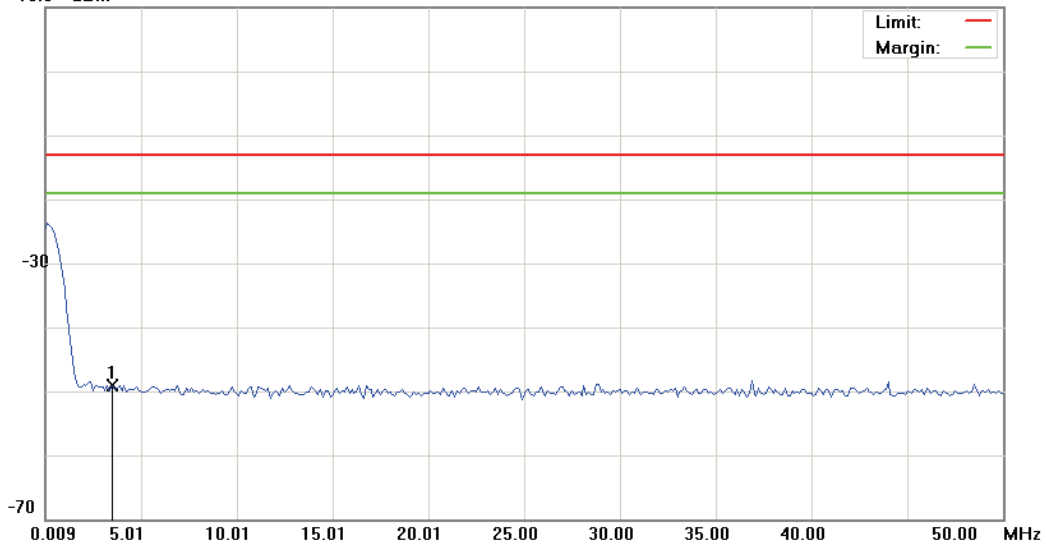

Site: : RF Conducted	Polarization: <i>Conducted po</i>	Temperature: 26 °C
Limit: FCC Part 24 conducted(9k-12.75G)	Power: AC 120V/60Hz	Humidity: 55 %
EUT: Portable Terminal	Distance:	RBW: 1000 KHz VBW: 1000 KHz
M/N: FD-400eTi		
Mode: PCS1900		
Note: CH661(1880MHz)		

No.	Mk.	Freq. MHz	Reading Level dBm	Correct Factor dB	Measure- ment dBm	Limit dBm	Over dB	Detector	Antenna Height cm	Table Degree	Comment
1	*	3.5084	-62.17	13.13	-49.04	-13.00	-36.04	peak		degree	

*:Maximum data x:Over limit !:over margin

File:FD-400eTi(CH661) Data :#2 Date: 2010/8/3 Time: PM 07:38:52

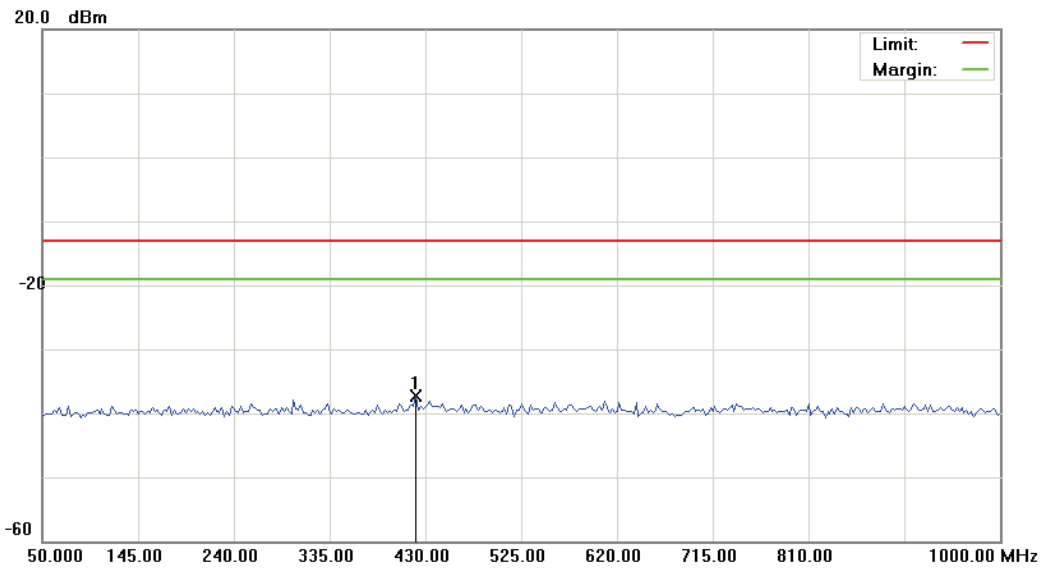

Site: : RF Conducted	Polarization: <i>Conducted po</i>	Temperature: 26 °C
Limit: FCC Part 24 conducted(9k-12.75G)	Power: AC 120V/60Hz	Humidity: 55 %
EUT: Portable Terminal	Distance:	RBW: 1000 KHz VBW: 1000 KHz
M/N: FD-400eTi		
Mode: PCS1900		
Note: CH661(1880MHz)		

No.	Mk.	Freq. MHz	Reading Level dBm	Correct Factor dB	Measure- ment dBm	Limit dBm	Over dB	Antenna Height cm	Table Degree degree	Comment
1	*	420.5000	-50.51	13.24	-37.27	-13.00	-24.27	peak		

*:Maximum data x:Over limit !:over margin

File:FD-400eTi(CH661) Data :#3 Date: 2010/8/3 Time: PM 07:48:30

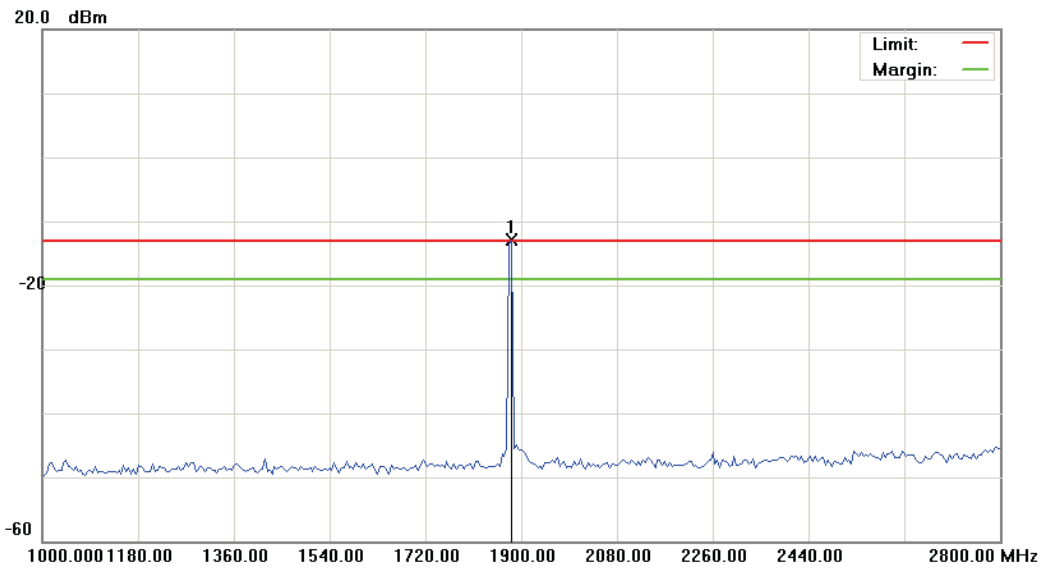

Site: : RF Conducted	Polarization: <i>Conducted po</i>	Temperature: 26 °C
Limit: FCC Part 24 conducted(9k-12.75G)	Power: AC 120V/60Hz	Humidity: 55 %
EUT: Portable Terminal	Distance:	RBW: 1000 KHz VBW: 1000 KHz
M/N: FD-400eTi		
Mode: PCS1900		
Note: CH661(1880MHz)		

No.	Mk.	Freq. MHz	Reading Level dBm	Correct Factor dB	Measure- ment dBm	Limit dBm	Over dB	Detector	Antenna Height cm	Table Degree degree	Comment
1	*	1882.000	-17.73	4.83	-12.90	-13.00	0.10	peak			TX

*:Maximum data x:Over limit !:over margin

File:FD-400eTi(CH661) Data :#4 Date: 2010/8/3 Time: PM 08:21:23

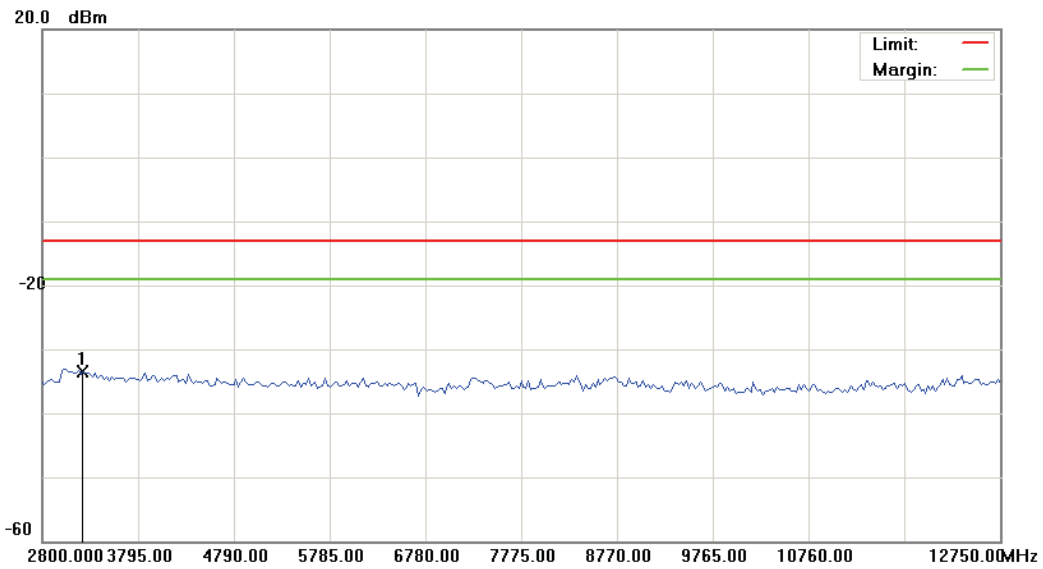

Site: : RF Conducted	Polarization: <i>Conducted po</i>	Temperature: 26 °C
Limit: FCC Part 24 conducted(9k-12.75G)	Power: AC 120V/60Hz	Humidity: 55 %
EUT: Portable Terminal	Distance:	RBW: 1000 KHz VBW: 1000 KHz
M/N: FD-400eTi		
Mode: PCS1900		
Note: CH661(1880MHz)		

No.	Mk.	Freq. MHz	Reading Level dBm	Correct Factor dB	Measure- ment dBm	Limit dBm	Over dB	Detector	Antenna Height cm	Table Degree degree	Comment
1	*	3222.875	-38.75	5.17	-33.58	-13.00	-20.58	peak			

*:Maximum data x:Over limit !:over margin

File:FD-400eTi(CH661) Data :#5 Date: 2010/8/3 Time: PM 08:21:45

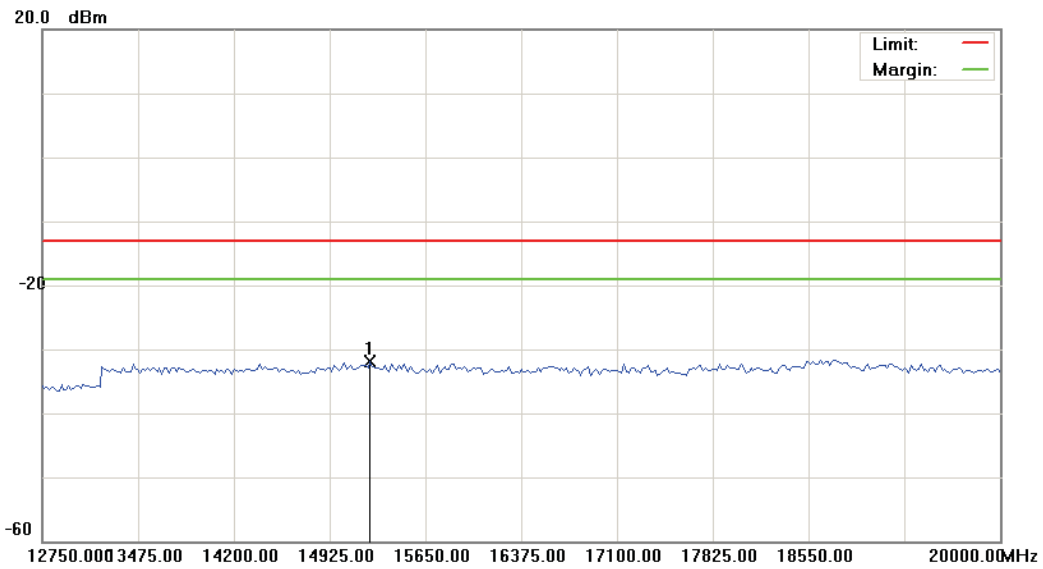

Site: : RF Conducted	Polarization: <i>Conducted po</i>	Temperature: 26 °C
Limit: FCC Part 24 conducted(9k-12.75G)	Power: AC 120V/60Hz	Humidity: 55 %
EUT: Portable Terminal	Distance:	RBW: 1000 KHz VBW: 1000 KHz
M/N: FD-400eTi		
Mode: PCS1900		
Note: CH661(1880MHz)		

No.	Mk.	Freq. MHz	Reading Level dBm	Correct Factor dB	Measure- ment dBm	Limit dBm	Over dB	Antenna Height cm	Table Degree degree	Comment
1	*	15233.125	-37.98	6.08	-31.90	-13.00	-18.90	peak		

*:Maximum data x:Over limit !:over margin

File:FD-400eTi(CH810) Data :#1 Date: 2010/8/3 Time: PM 07:40:01

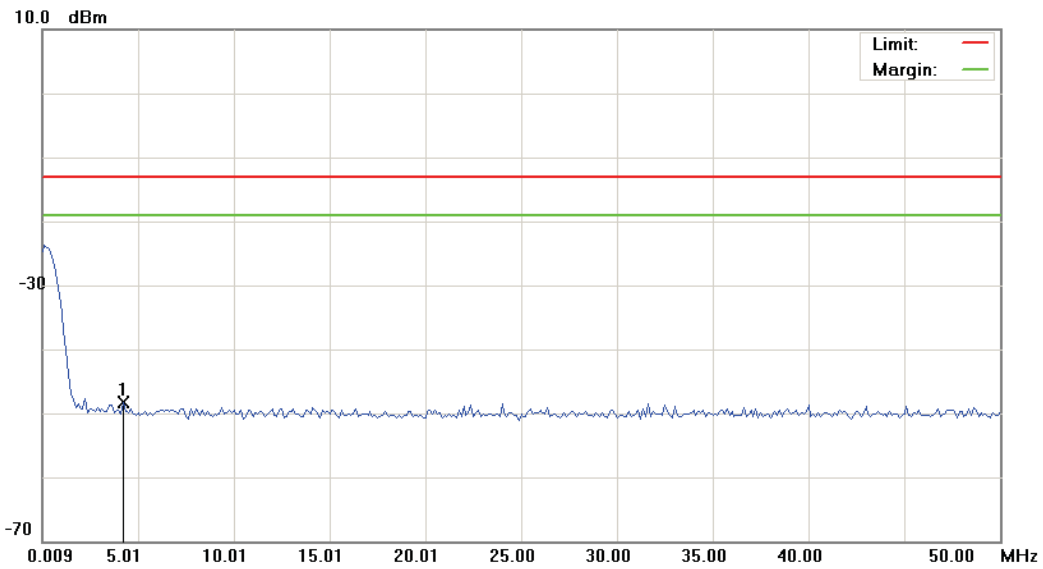

Site: : RF Conducted	Polarization: <i>Conducted po</i>	Temperature: 26 °C
Limit: FCC Part 24 conducted(9k-12.75G)	Power: AC 120V/60Hz	Humidity: 55 %
EUT: Portable Terminal	Distance:	RBW: 1000 KHz VBW: 1000 KHz
M/N: FD-400eTi		
Mode: PCS1900		
Note: CH810(1909.8MHz)		

No.	Mk.	Freq. MHz	Reading Level dBm	Correct Factor dB	Measure- ment dBm	Limit dBm	Over dB	Detector	Antenna Height cm	Table Degree	Comment
1	*	4.2582	-61.57	13.24	-48.33	-13.00	-35.33	peak		degree	

*:Maximum data x:Over limit !:over margin

File:FD-400eTi(CH810) Data :#2 Date: 2010/8/3 Time: PM 07:40:20

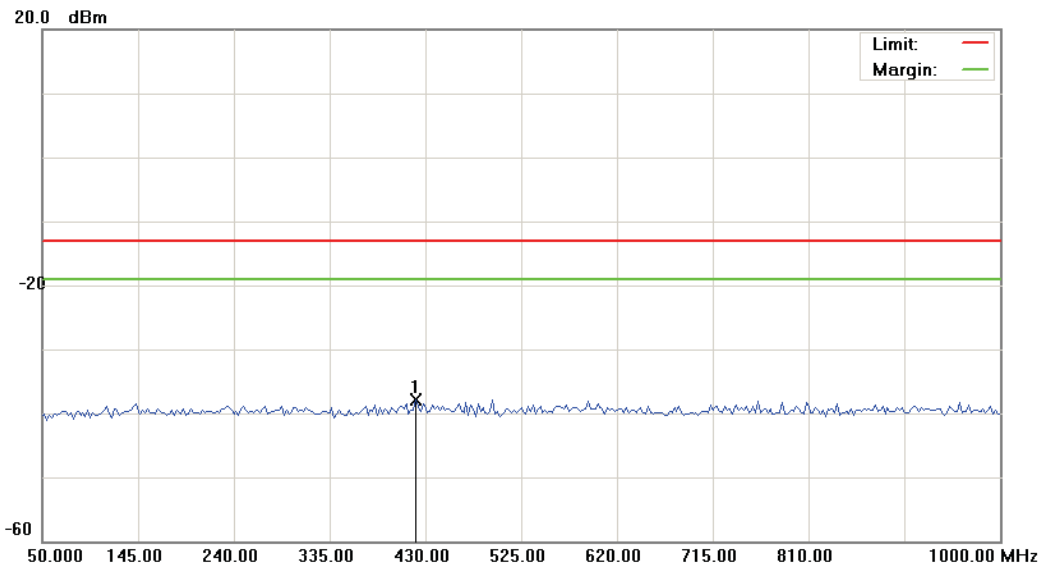

Site: : RF Conducted	Polarization: <i>Conducted po</i>	Temperature: 26 °C
Limit: FCC Part 24 conducted(9k-12.75G)	Power: AC 120V/60Hz	Humidity: 55 %
EUT: Portable Terminal	Distance:	RBW: 1000 KHz VBW: 1000 KHz
M/N: FD-400eTi		
Mode: PCS1900		
Note: CH810(1909.8MHz)		

No.	Mk.	Freq. MHz	Reading Level dBm	Correct Factor dB	Measure- ment dBm	Limit dBm	Over dB	Antenna Height cm	Table Degree degree	Comment
1	*	420.5000	-51.19	13.24	-37.95	-13.00	-24.95	peak		

*:Maximum data x:Over limit !:over margin

File:FD-400eTi(CH810) Data :#3 Date: 2010/8/3 Time: PM 07:49:31

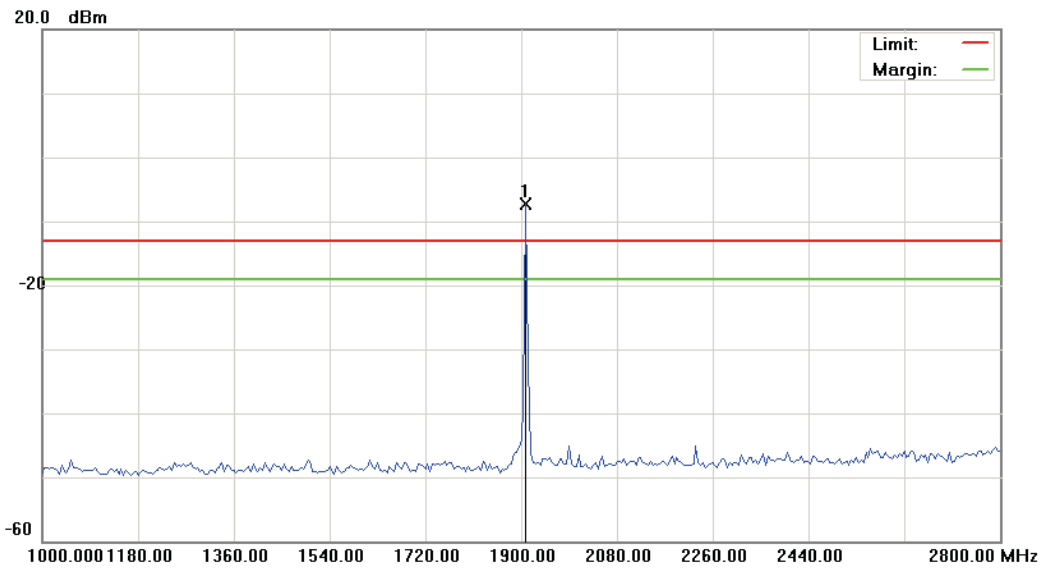

Site: : RF Conducted	Polarization: <i>Conducted po</i>	Temperature: 26 °C
Limit: FCC Part 24 conducted(9k-12.75G)	Power: AC 120V/60Hz	Humidity: 55 %
EUT: Portable Terminal	Distance:	RBW: 1000 KHz VBW: 1000 KHz
M/N: FD-400eTi		
Mode: PCS1900		
Note: CH810(1909.8MHz)		

No.	Mk.	Freq. MHz	Reading Level dBm	Correct Factor dB	Measure- ment dBm	Limit dBm	Over dB	Antenna Height cm	Table Degree degree	Comment
1	*	1909.000	-13.02	5.80	-7.22	-13.00	5.78	peak		TX

*:Maximum data x:Over limit !:over margin

File:FD-400eTi(CH810) Data :#4 Date: 2010/8/3 Time: PM 08:22:28

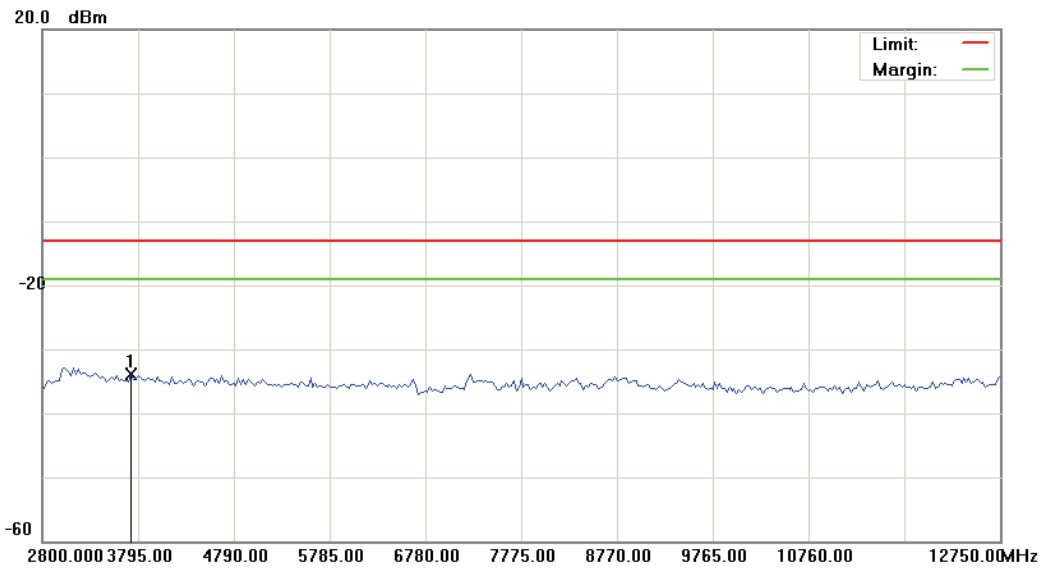

Site: : RF Conducted	Polarization: <i>Conducted po</i>	Temperature: 26 °C
Limit: FCC Part 24 conducted(9k-12.75G)	Power: AC 120V/60Hz	Humidity: 55 %
EUT: Portable Terminal	Distance:	RBW: 1000 KHz VBW: 1000 KHz
M/N: FD-400eTi		
Mode: PCS1900		
Note: CH810(1909.8MHz)		

No.	Mk.	Freq. MHz	Reading Level dBm	Correct Factor dB	Measure- ment dBm	Limit dBm	Over dB	Antenna Height cm	Table Degree degree	Comment
1	*	3720.375	-38.83	4.88	-33.95	-13.00	-20.95	peak		

*:Maximum data x:Over limit !:over margin

File:FD-400eTi(CH810) Data :#5 Date: 2010/8/3 Time: PM 08:22:50

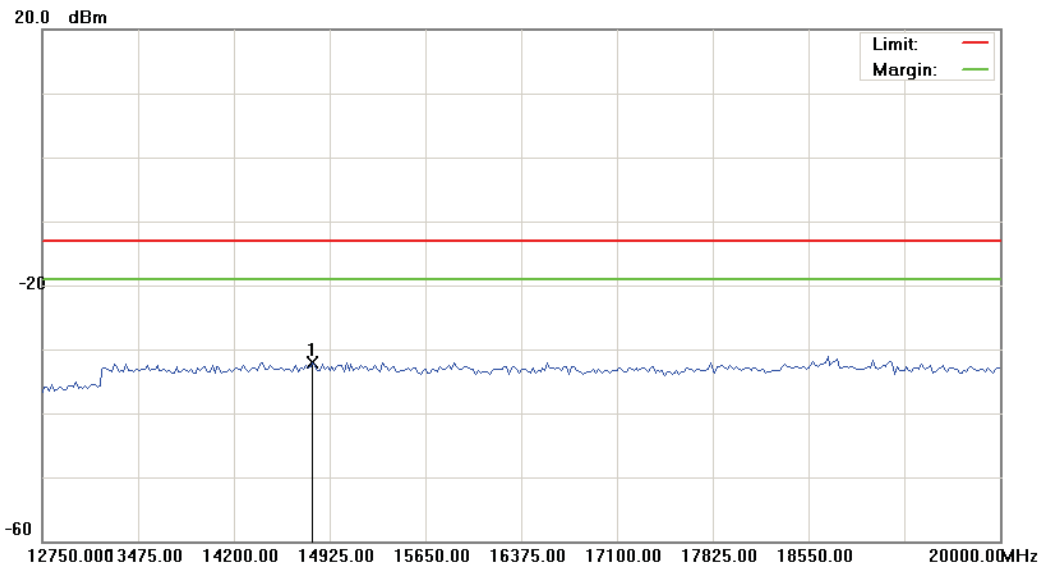

Site: : RF Conducted	Polarization: <i>Conducted po</i>	Temperature: 26 °C
Limit: FCC Part 24 conducted(9k-12.75G)	Power: AC 120V/60Hz	Humidity: 55 %
EUT: Portable Terminal	Distance:	RBW: 1000 KHz VBW: 1000 KHz
M/N: FD-400eTi		
Mode: PCS1900		
Note: CH810(1909.8MHz)		

No.	Mk.	Freq. MHz	Reading Level dBm	Correct Factor dB	Measure- ment dBm	Limit dBm	Over dB	Antenna Height cm	Table Degree degree	Comment
1	*	14798.125	-38.01	5.95	-32.06	-13.00	-19.06	peak		

*:Maximum data x:Over limit !:over margin

6 Field Strength of Spurious Radiation Test

6.1. Limit

The power of any emission outside of the authorized operating frequency ranges must be attenuated below the transmitting power (P) by a factor of at least $43 + 10\log(P)$ dB.

It is measured by means of a calibrated spectrum analyzer and scanned from 30 MHz up to a frequency including its 10th harmonic.

6.2. Test Instruments

3 Meter Chamber					
Equipment	Manufacturer	Model No.	Serial No.	Cal. Date	Remark
RF Pre-selector	Agilent	N9039A	MY46520256	01/07/2009	(2)
Spectrum Analyzer	Agilent	E4446A	MY46180578	02/24/2010	(2)
Pre Amplifier	Agilent	8449B	3008A02237	02/24/2010	(1)
Pre Amplifier	Agilent	8447D	2944A10961	02/24/2010	(1)
Broadband Antenna (30MHz~1GHz)	SCHWARZBECK MESS-ELEKTRONIK	VULB9163	9163-270	08/02/2010	(2)
Horn Antenna (1~18GHz)	SCHWARZBECK MESS-ELEKTRONIK	BBHA9120D	9120D-550	06/29/2010	(2)
Horn Antenna (18~40GHz)	SCHWARZBECK MESS-ELEKTRONIK	BBHA9170	9170-320	06/29/2010	(2)
Test Site	ATL	TE01	888001	07/30/2010	(1)

Remark: ⁽¹⁾ Calibration period 1 year. ⁽²⁾ Calibration period 2 years.

NOTE: N.C.R. = No Calibration Request.

6.3. Setup

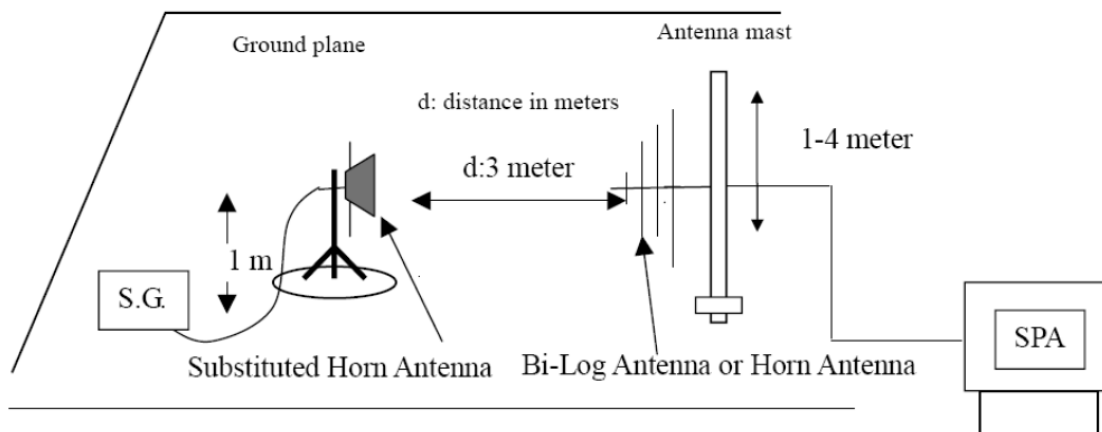

6.4. Test Procedure

The measurement is made according to ANSI/TIA-603-C-2004 as follows:

The equipment under test is placed inside the semi-anechoic chamber on a wooden table at the turntable center. For each spurious frequency, the antenna mast is raised and lowered from 1 to 4 meters and the turntable is rotated 360 degrees to obtain a maximum reading on the spectrum analyzer. This is repeated for both horizontal and vertical polarizations of the receive antenna.

The equipment under test is then replaced with a substitution antenna fed by a signal generator. With the signal generator tuned to a particular spurious frequency, the antenna mast is raised and lowered from 1 to 4 meters to obtain a maximum reading at the spectrum analyzer. The output of the signal generator is then adjusted until a reading identical to that obtained with the actual transmitter is achieved.

The power in dBm of each spurious emission is calculated by correcting the signal generator level for cable loss and gain of the substitution antenna referenced to a dipole. A fully charged battery was used for the supply voltage.

The settings of the receiver were as follows:

Units	dBm
Resolution Bandwidth	1 MHz
Video Bandwidth	Auto
Sweep Time	Auto

The field strength of spurious emission was measured in the following position: EUT stand-up position (Z axis), lie-down position (X, Y axis). The worst emission was **found in lie-down position (X axis) and** the worst case was recorded.

6.5. Uncertainty

The measurement uncertainty is defined as for Field Strength of Spurious Radiation measurement is ± 3.072 dB.

6.6. Test Result

Standard:	FCC Part 22	Test Distance:	3m
Test item:	Radiated Emission	Power:	AC 120V/60Hz
Model Number:	FD-400eTi	Temp.(°C)/Hum.(%RH):	26(°C)/60%RH
Mode:	Mode 1	Date:	2010/08/03
Frequency:	824.2 MHz	Test By:	Gary Wu

No.	Frequency (MHz)	Reading (dBm)	Correct Factor(dB)	Result (dBm)	Limit (dBm)	Margin (dB)	Remark	Ant.Polar. H / V
1	264.0000	-55.95	-4.93	-60.88	-13.00	-47.88	peak	H
2	360.0000	-58.93	-2.14	-61.07	-13.00	-48.07	peak	H
3	456.0000	-74.01	7.93	-66.08	-13.00	-53.08	peak	H
4	733.0000	-66.17	3.77	-62.40	-13.00	-49.40	peak	H
5	873.5000	-55.36	14.06	-41.30	-13.00	-28.30	peak	H
6	915.5000	-75.43	16.40	-59.03	-13.00	-46.03	peak	H
7	1648.400	-44.32	10.39	-33.93	-13.00	-20.93	peak	H
8	2472.200	-50.00	11.91	-38.09	-13.00	-25.09	peak	H
1	264.0000	-73.63	5.82	-67.81	-13.00	-54.81	peak	V
2	288.0000	-74.97	5.84	-69.13	-13.00	-56.13	peak	V
3	533.5000	-62.27	1.78	-60.49	-13.00	-47.49	peak	V
4	848.5000	-70.34	7.88	-62.46	-13.00	-49.46	peak	V
5	873.5000	-51.99	8.03	-43.96	-13.00	-30.96	peak	V
6	916.0000	-73.73	9.01	-64.72	-13.00	-51.72	peak	V
7	1648.400	-50.76	6.71	-44.05	-13.00	-31.05	peak	V
8	2472.600	-52.77	11.98	-40.79	-13.00	-27.79	peak	V

Standard:	FCC Part 22	Test Distance:	3m
Test item:	Radiated Emission	Power:	AC 120V/60Hz
Model Number:	FD-400eTi	Temp.(°C)/Hum.(%RH):	26(°C)/60%RH
Mode:	Mode 1	Date:	2010/08/03
Frequency:	836.4 MHz	Test By:	Gary Wu

No.	Frequency (MHz)	Reading (dBm)	Correct Factor(dB)	Result (dBm)	Limit (dBm)	Margin (dB)	Remark	Ant.Polar. H / V
1	264.0000	-55.84	-4.93	-60.77	-13.00	-47.77	peak	H
2	336.0000	-61.30	-1.58	-62.88	-13.00	-49.88	peak	H
3	360.0000	-59.20	-2.14	-61.34	-13.00	-48.34	peak	H
4	743.5000	-67.77	4.38	-63.39	-13.00	-40.39	peak	H
5	873.5000	-54.92	14.06	-40.86	-13.00	-27.86	peak	H
6	929.5000	-74.18	15.85	-58.33	-13.00	-45.33	peak	H
7	1673.200	-49.85	10.39	-39.46	-13.00	-26.46	peak	H
8	2509.800	-56.37	12.03	-44.34	-13.00	-31.34	peak	H
1	264.0000	-74.01	5.82	-68.19	-13.00	-55.19	peak	V
2	288.0000	-73.42	5.84	-67.58	-13.00	-54.58	peak	V
3	336.0000	-76.63	3.61	-73.02	-13.00	-60.02	peak	V
4	533.5000	-61.92	1.78	-60.14	-13.00	-47.14	peak	V
5	873.5000	-53.24	8.03	-45.21	-13.00	-32.21	peak	V
6	929.5000	-76.85	9.30	-67.55	-13.00	-54.55	peak	V
7	1673.200	-51.75	6.89	-44.86	-13.00	-31.86	peak	V
8	2509.800	-50.45	12.21	-38.24	-13.00	-25.24	peak	V

Standard:	FCC Part 22	Test Distance:	3m
Test item:	Radiated Emission	Power:	AC 120V/60Hz
Model Number:	FD-400eTi	Temp.(°C)/Hum.(%RH):	26(°C)/60%RH
Mode:	Mode 1	Date:	2010/08/03
Frequency:	848.8 MHz	Test By:	Gary Wu

No.	Frequency (MHz)	Reading (dBm)	Correct Factor(dB)	Result (dBm)	Limit (dBm)	Margin (dB)	Remark	Ant.Polar. H / V
1	264.0000	-56.18	-4.93	-61.11	-13.00	-48.11	peak	H
2	360.0000	-58.95	-2.14	-61.09	-13.00	-48.09	peak	H
3	432.0000	-71.24	5.57	-65.67	-13.00	-52.67	peak	H
4	873.5000	-54.96	14.06	-40.90	-13.00	-27.90	peak	H
5	893.5000	-56.52	16.07	-40.45	-13.00	-27.45	peak	H
6	943.0000	-75.27	15.15	-60.12	-13.00	-47.12	peak	H
7	1697.600	-50.55	10.39	-40.16	-13.00	-27.16	peak	H
8	2546.400	-52.84	12.15	-40.69	-13.00	-27.69	peak	H
1	264.0000	-73.10	5.82	-67.28	-13.00	-54.28	peak	V
2	288.0000	-74.25	5.84	-68.41	-13.00	-55.41	peak	V
3	533.5000	-61.56	1.78	-59.78	-13.00	-46.78	peak	V
4	873.5000	-51.72	8.03	-43.69	-13.00	-30.69	peak	V
5	894.0000	-54.90	8.48	-46.42	-13.00	-33.42	peak	V
6	943.0000	-76.03	9.61	-66.42	-13.00	-53.42	peak	V
7	1697.600	-52.92	7.08	-45.84	-13.00	-32.84	peak	V
8	2546.400	-49.56	12.50	-37.06	-13.00	-24.06	peak	V

Standard:	FCC Part 24	Test Distance:	3m
Test item:	Radiated Emission	Power:	AC 120V/60Hz
Model Number:	FD-400eTi	Temp.(°C)/Hum.(%RH):	26(°C)/60%RH
Mode:	Mode 2	Date:	2010/08/03
Frequency:	1850.2 MHz	Test By:	Gary Wu

No.	Frequency (MHz)	Reading (dBm)	Correct Factor(dB)	Result (dBm)	Limit (dBm)	Margin (dB)	Remark	Ant.Polar. H / V
1	336.0000	-61.45	-1.58	-63.03	-13.00	-50.03	peak	H
2	384.0000	-63.69	0.49	-63.20	-13.00	-50.20	peak	H
3	456.0000	-71.52	7.93	-63.59	-13.00	-50.59	peak	H
4	533.5000	-69.83	6.89	-62.94	-13.00	-49.94	peak	H
5	876.5000	-60.42	14.33	-46.09	-13.00	-33.09	peak	H
6	974.0000	-62.39	13.43	-48.96	-13.00	-35.96	peak	H
7	3700.400	-55.73	15.75	-39.98	-13.00	-26.98	peak	H
8	5550.600	-59.07	21.82	-37.25	-13.00	-24.25	peak	H
1	533.5000	-59.69	1.78	-57.91	-13.00	-44.91	peak	V
2	552.0000	-68.34	2.39	-65.95	-13.00	-52.95	peak	V
3	632.0000	-71.91	6.96	-64.95	-13.00	-51.95	peak	V
4	666.5000	-70.19	8.46	-61.73	-13.00	-48.73	peak	V
5	876.5000	-60.70	8.10	-52.60	-13.00	-39.60	peak	V
6	974.0000	-68.35	10.43	-57.92	-13.00	-44.92	peak	V
7	3700.400	-59.06	19.81	-39.25	-13.00	-26.25	peak	V
8	5550.600	-60.09	23.41	-36.68	-13.00	-23.68	peak	V

Standard:	FCC Part 24	Test Distance:	3m
Test item:	Radiated Emission	Power:	AC 120V/60Hz
Model Number:	FD-400eTi	Temp.(°C)/Hum.(%RH):	26(°C)/60%RH
Mode:	Mode 2	Date:	2010/08/03
Frequency:	1880.0 MHz	Test By:	Gary Wu

No.	Frequency (MHz)	Reading (dBm)	Correct Factor(dB)	Result (dBm)	Limit (dBm)	Margin (dB)	Remark	Ant.Polar. H / V
1	336.0000	-61.77	-1.58	-63.35	-13.00	-50.35	peak	H
2	384.0000	-64.00	0.49	-63.51	-13.00	-50.51	peak	H
3	456.0000	-70.93	7.93	-63.00	-13.00	-50.00	peak	H
4	480.0000	-75.44	11.71	-63.73	-13.00	-50.73	peak	H
5	890.5000	-62.76	15.75	-47.01	-13.00	-34.01	peak	H
6	989.5000	-63.35	12.69	-50.66	-13.00	-37.66	peak	H
7	3760.000	-54.82	15.89	-38.93	-13.00	-25.93	peak	H
8	5640.000	-61.07	22.04	-39.03	-13.00	-26.03	peak	H
1	268.5000	-72.12	5.97	-66.15	-13.00	-53.15	peak	V
2	533.5000	-59.56	1.78	-57.78	-13.00	-44.78	peak	V
3	684.0000	-70.57	9.02	-61.55	-13.00	-48.55	peak	V
4	880.0000	-65.15	8.18	-56.97	-13.00	-43.97	peak	V
5	890.5000	-61.16	8.40	-52.76	-13.00	-39.76	peak	V
6	989.5000	-68.87	10.95	-57.92	-13.00	-44.92	peak	V
7	3760.000	-60.59	19.98	-40.61	-13.00	-27.61	peak	V
8	5460.000	-61.20	23.47	-37.73	-13.00	-24.73	peak	V

Standard:	FCC Part 24	Test Distance:	3m
Test item:	Radiated Emission	Power:	AC 120V/60Hz
Model Number:	FD-400eTi	Temp.(°C)/Hum.(%RH):	26(°C)/60%RH
Mode:	Mode 2	Date:	2010/08/03
Frequency:	1909.8 MHz	Test By:	Gary Wu

No.	Frequency (MHz)	Reading (dBm)	Correct Factor(dB)	Result (dBm)	Limit (dBm)	Margin (dB)	Remark	Ant.Polar. H / V
1	264.0000	-58.86	-4.93	-63.79	-13.00	-50.79	peak	H
2	336.0000	-61.45	-1.58	-63.03	-13.00	-50.03	peak	H
3	384.0000	-63.69	0.49	-63.20	-13.00	-50.20	peak	H
4	533.5000	-69.83	6.89	-62.94	-13.00	-49.94	peak	H
5	876.5000	-60.42	14.33	-46.09	-13.00	-33.09	peak	H
6	974.0000	-62.39	13.43	-48.96	-13.00	-35.96	peak	H
7	3819.600	-56.09	16.03	-40.06	-13.00	-27.06	peak	H
8	5729.400	-59.51	22.27	-37.24	-13.00	-24.24	peak	H
1	107.0000	-62.87	-3.11	-65.98	-13.00	-62.98	peak	V
2	268.5000	-62.12	5.97	-56.15	-13.00	-53.15	peak	V
3	355.5000	-62.30	3.02	-59.28	-13.00	-56.28	peak	V
4	533.5000	-49.56	1.78	-47.78	-13.00	-44.78	peak	V
5	890.5000	-51.16	8.40	-42.76	-13.00	-39.76	peak	V
6	989.5000	-58.87	10.95	-47.92	-13.00	-44.92	peak	V
7	3819.600	-59.41	20.13	-39.28	-13.00	-26.28	peak	V
8	5729.400	-61.82	23.10	-38.72	-13.00	-25.72	peak	V

7 Frequency Stability (Temperature Variation) Test

7.1. Limit

The frequency stability shall be measured by variation of ambient temperature and variation of primary supply voltage to ensure that the fundamental emission stays within the authorized frequency block. The frequency stability of the transmitter shall be maintained within $\pm 0.00025\%$ ($\pm 2.5\text{ppm}$) of the center frequency.

7.2. Test Instruments

Describe	Manufacturer	Model No.	Serial No.	Cal. Date	Remark
Universal Radio Communication Tester	ROHDE & SCHWARZ	CMU200	109369	07/29/2009	(2)
Temperature & Humidity Chamber	TAICHY	MHU-225LA	980729	08/26/2009	(2)
Test Site	ATL	TE02	TE02	N.C.R.	-----

Remark: ⁽¹⁾ Calibration period 1 year. ⁽²⁾ Calibration period 2 years.

NOTE: N.C.R. = No Calibration Request.

7.3. Setup

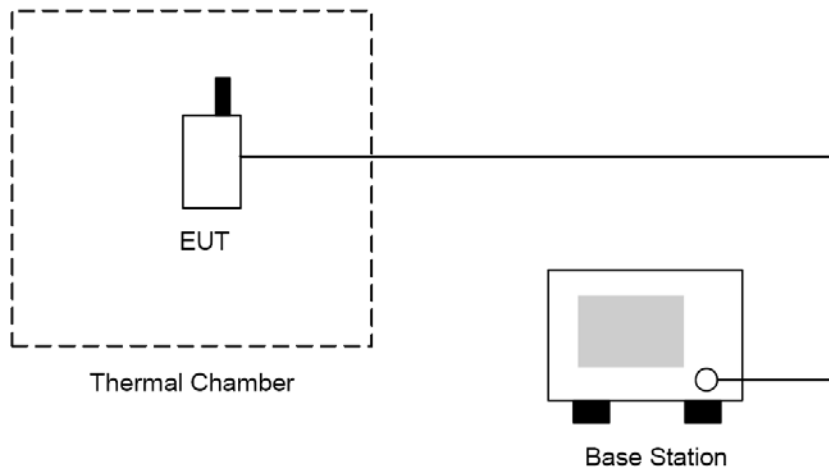

7.4. Test Procedure

The measurement is made according to FCC rules part 22 and 24:

1. The EUT and test equipment were set up as shown on the following section.
2. With all power removed, the temperature was decreased to -30°C and permitted to stabilize for three hours. Power was applied and the maximum change in frequency was note within one minute.
3. With power OFF, the temperature was raised in 10°C steps. The sample was permitted to stabilize at each step for at least one-half hour. Power was applied and the maximum frequency change was noted within one minute.
4. The temperature tests were performed for the worst case.
5. Test data was recorded.

7.5. Uncertainty

The measurement uncertainty is defined as for Frequency Stability (Temperature Variation) measurement is $\pm 10\text{Hz}$.

7.6. Test Result

Model Number	FD-400eTi			
Test Item	Frequency Stability (Temperature Variation)			
Test Mode	Mode 1: GPRS 850 Link			
Date of Test	08/03/2010		Test Site	TE02
Temperature (°C)	Deviation (Hz)	Deviation (ppm)	Limit (ppm)	Result
-30	22.31	0.027	±2.5	Pass
-20	25.69	0.031	±2.5	Pass
-10	21.47	0.026	±2.5	Pass
0	20.78	0.025	±2.5	Pass
10	20.2	0.024	±2.5	Pass
20	25.36	0.030	±2.5	Pass
30	29.54	0.035	±2.5	Pass
40	27.72	0.033	±2.5	Pass
50	22.14	0.026	±2.5	Pass

Model Number	FD-400eTi			
Test Item	Frequency Stability (Temperature Variation)			
Test Mode	Mode 2: GPRS 1900 Link			
Date of Test	08/03/2010		Test Site	TE02
Temperature (°C)	Deviation (Hz)	Deviation (ppm)	Limit (ppm)	Result
-30	36.54	0.019	±2.5	Pass
-20	30.12	0.016	±2.5	Pass
-10	25.47	0.014	±2.5	Pass
0	21.24	0.011	±2.5	Pass
10	22.36	0.012	±2.5	Pass
20	27.43	0.015	±2.5	Pass
30	25.41	0.014	±2.5	Pass
40	22.98	0.012	±2.5	Pass
50	23.01	0.012	±2.5	Pass

8 Frequency Stability (Voltage Variation) Test

8.1. Limit

The frequency stability shall be measured by variation of ambient temperature and variation of primary supply voltage to ensure that the fundamental emission stays within the authorized frequency block. The frequency stability of the transmitter shall be maintained within $\pm 0.00025\%$ ($\pm 2.5\text{ppm}$) of the center frequency.

8.2. Test Instruments

Describe	Manufacturer	Model No.	Serial No.	Cal. Date	Remark
Universal Radio Communication Tester	ROHDE & SCHWARZ	CMU200	109369	07/29/2009	(2)
Temperature & Humidity Chamber	TAICHY	MHU-225LA	980729	08/26/2009	(2)
Test Site	ATL	TE02	TE02	N.C.R.	-----

Remark: ⁽¹⁾ Calibration period 1 year. ⁽²⁾ Calibration period 2 years.

NOTE: N.C.R. = No Calibration Request.

8.3. Setup

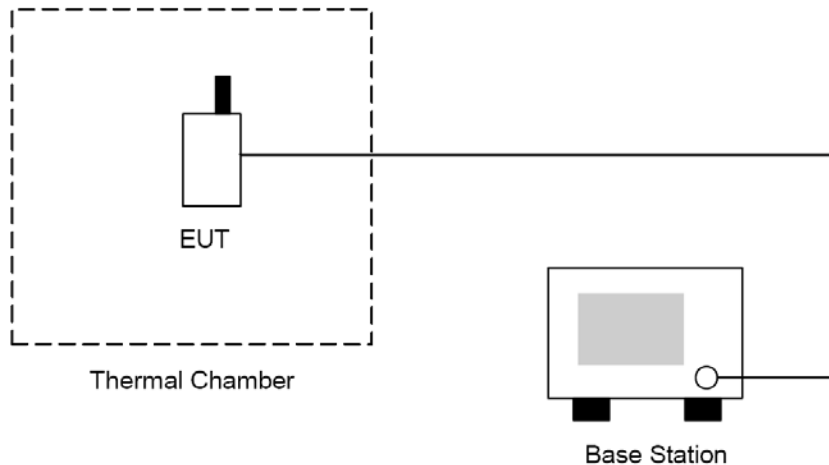

8.4. Test Procedure

1. The EUT was placed in a temperature chamber at $25 \pm 5 \text{ }^\circ\text{C}$ and connected as the following section.
2. The power supply voltage to the EUT was varied from BEP to 115% of the nominal value measured at the input to the EUT.
3. The variation in frequency was measured for the worst case.

8.5. Uncertainty

The measurement uncertainty is defined as for Frequency Stability (Voltage Variation) measurement is $\pm 10\text{Hz}$.

8.6. Test Result

Model Number	FD-400eTi				
Test Item	Frequency Stability (Voltage Variation)				
Test Mode	Mode 1: GPRS 850 Link				
Date of Test	08/03/2010		Test Site	TE02	
Level	Voltage [Vdc]	Deviation [Hz]	Deviation [ppm]	Limit [ppm]	Result
Battery full point	8.14	23.45	0.028	± 2.5	Pass
Normal	7.40	29.36	0.035	± 2.5	Pass
Battery cut-off point	6.66	27.14	0.032	± 2.5	Pass

Model Number	FD-400eTi				
Test Item	Frequency Stability (Voltage Variation)				
Test Mode	Mode 2: GPRS 1900 Link				
Date of Test	08/03/2010		Test Site	TE02	
Level	Voltage [Vdc]	Deviation [Hz]	Deviation [ppm]	Limit [ppm]	Result
Battery full point	8.14	25.36	0.013	± 2.5	Pass
Normal	7.40	27.95	0.015	± 2.5	Pass
Battery cut-off point	6.66	25.46	0.014	± 2.5	Pass

9 AC Power Conducted Emissions Test

9.1. Limit

Frequency range (MHz)	Limits (dBuV)	
	Quasi-peak	Average
0.15 to 0.50	66 to 56	56 to 46
0.50 to 5.0	56	46
5.0 to 30	60	50

9.2. Test Instruments

Describe	Manufacturer	Model No.	Serial No.	Cal. Date	Remark
Test Receiver	R&S	ESCI	100367	07/01/2010	(1)
LISN	R&S	ENV216	101040	03/02/2010	(1)
LISN	R&S	ENV216	101041	03/02/2010	(1)
Test Site	ATL	TE02	TE02	N.C.R.	-----

Remark: ⁽¹⁾ Calibration period 1 year. ⁽²⁾ Calibration period 2 years.

NOTE: N.C.R. = No Calibration Request.

9.3. Setup

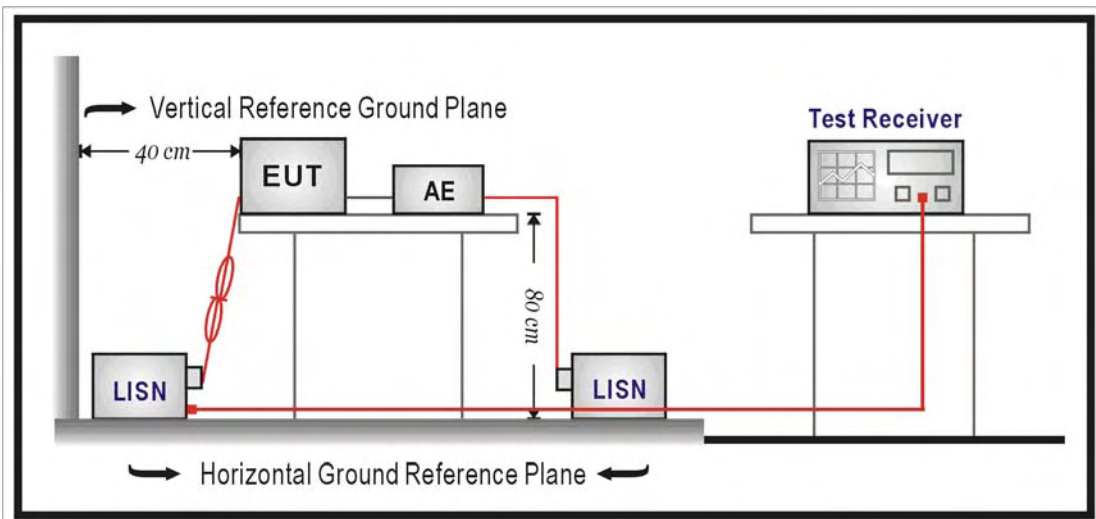

9.4. Test Procedure

The measurement is made according to FCC rules 15.207:

The power line conducted emission measurements were performed in a shielded enclosure. The EUT was assembled on a wooden table which is 80 centimeters high, was placed 40 centimeters from the back wall and at least 1 meter from the sidewall.

Power was fed to the EUT from the public utility power grid through a line filter and EMCO Model 3162/2 SH Line Impedance Stabilization Networks (LISN). The LISN housing, measuring instrumentation case, ground plane, etc., were electrically bonded together at the same RF potential. The Spectrum analyzer was connected to the AC line through an isolation transformer. The 50-ohm output of the LISN was connected to the spectrum analyzer directly. Conducted emission levels were in the CISPR quasi-peak detection mode. The analyzer's 6 dB bandwidth was set to 9 KHz. No post-detector video filter was used.

The spectrum was scanned from 150 KHz to 30 MHz. The physical arrangement of the test system and associated cabling was varied (within the scope of arrangements likely to be encountered in actual use) to determine the effect on the unit's emanations in amplitude and frequency. All spurious emission frequencies were observed. The highest emission amplitudes relative to the appropriate limit were measured and have been recorded in section 10.6.

9.5. Uncertainty

The measurement uncertainty is defined as for AC power conducted emission measurement is ± 2.24 dB.

9.6. Test Result

Standard:	FCC Part 22H	Line:	L1
Test item:	Conducted Emission	Power:	AC 120V/60Hz
Model Number:	FD-400eTi	Temp.(°C)/Hum.(%RH):	26(°C)/60%RH
Mode:	Mode 1	Date:	2010/07/28
		Test By:	Gary Wu
Description:		EUT with AC adapter	

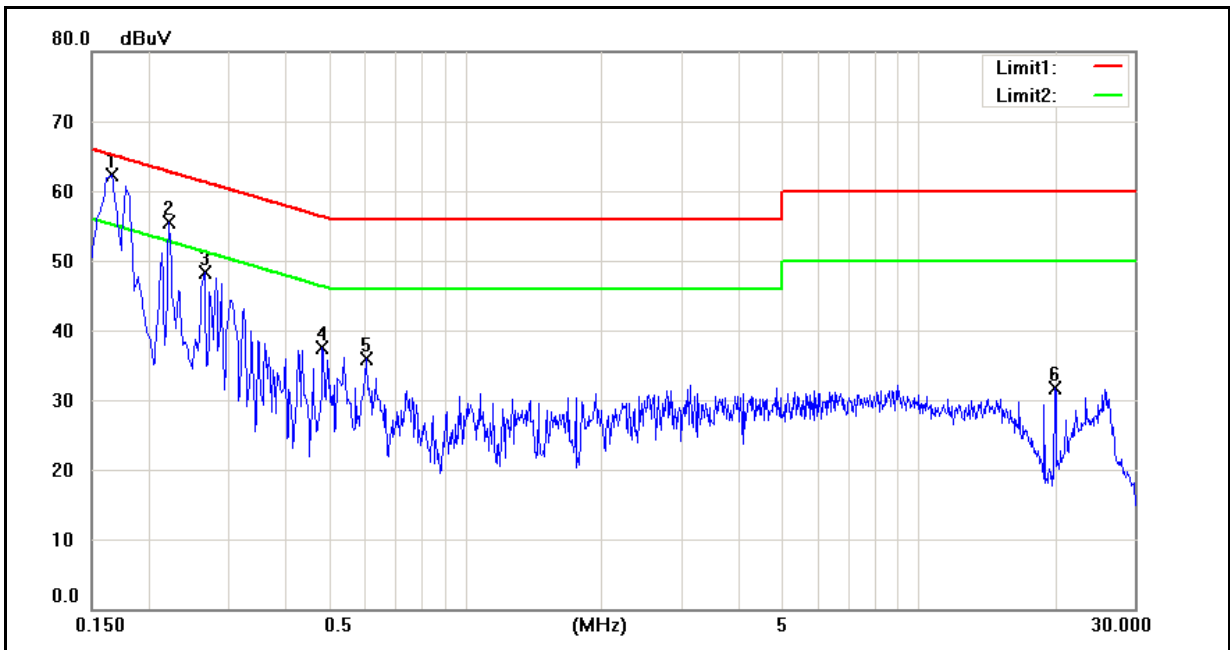

No.	Frequency (MHz)	QP reading (dBuV)	AVG reading (dBuV)	Correction factor (dB)	QP result (dBuV)	AVG result (dBuV)	QP limit (dBuV)	AVG limit (dBuV)	QP margin (dB)	AVG margin (dB)	Remark
1	0.1660	50.29	32.18	9.60	59.89	41.78	65.16	55.16	-5.27	-13.38	Pass
2	0.2220	41.75	23.17	9.59	51.34	32.76	62.74	52.74	-11.40	-19.98	Pass
3	0.2660	36.03	15.17	9.59	45.62	24.76	61.24	51.24	-15.62	-26.48	Pass
4	0.4860	25.63	15.52	9.59	35.22	25.11	56.24	46.24	-21.02	-21.13	Pass
5	0.6060	25.34	16.49	9.59	34.93	26.08	56.00	46.00	-21.07	-19.92	Pass
6	20.0540	21.56	21.08	9.82	31.38	30.90	60.00	50.00	-28.62	-19.10	Pass

Standard:	FCC Part 22H	Line:	N
Test item:	Conducted Emission	Power:	AC 120V/60Hz
Model Number:	FD-400eTi	Temp.(°C)/Hum.(%RH):	26(°C)/60%RH
Mode:	Mode 1	Date:	2010/07/28
		Test By:	Gary Wu
Description:		EUT with AC adapter	

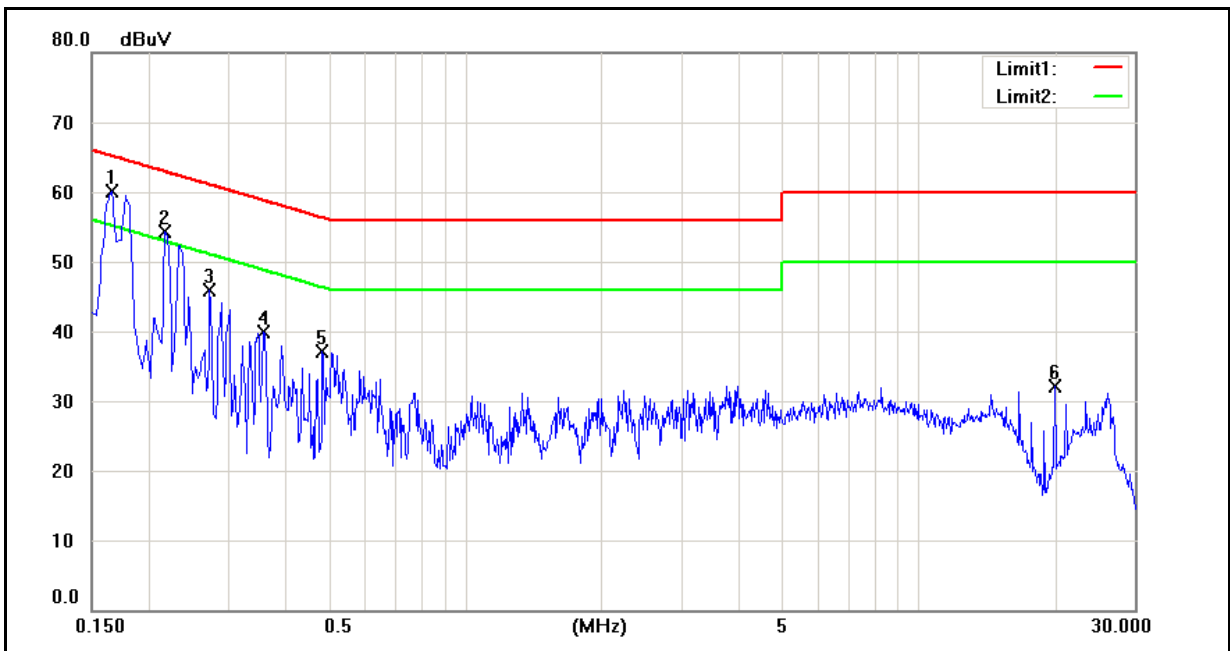

No.	Frequency (MHz)	QP reading (dBuV)	AVG reading (dBuV)	Correction factor (dB)	QP result (dBuV)	AVG result (dBuV)	QP limit (dBuV)	AVG limit (dBuV)	QP margin (dB)	AVG margin (dB)	Remark
1	0.1780	47.53	32.02	9.58	57.11	41.60	64.58	54.58	-7.47	-12.98	Pass
2	0.2260	39.48	21.35	9.58	49.06	30.93	62.60	52.60	-13.54	-21.67	Pass
3	0.2740	33.37	12.61	9.58	42.95	22.19	61.00	51.00	-18.05	-28.81	Pass
4	0.3940	22.00	9.57	9.59	31.59	19.16	57.98	47.98	-26.39	-28.82	Pass
5	20.0500	20.49	20.05	9.91	30.40	29.96	60.00	50.00	-29.60	-20.04	Pass
6	26.4540	10.59	5.32	10.03	20.62	15.35	60.00	50.00	-39.38	-34.65	Pass

Standard:	FCC Part 24E	Line:	L1
Test item:	Conducted Emission	Power:	AC 120V/60Hz
Model Number:	FD-400eTi	Temp.(°C)/Hum.(%RH):	26(°C)/60%RH
Mode:	Mode 2	Date:	2010/07/28
		Test By:	Gary Wu
Description:		EUT with AC adapter	

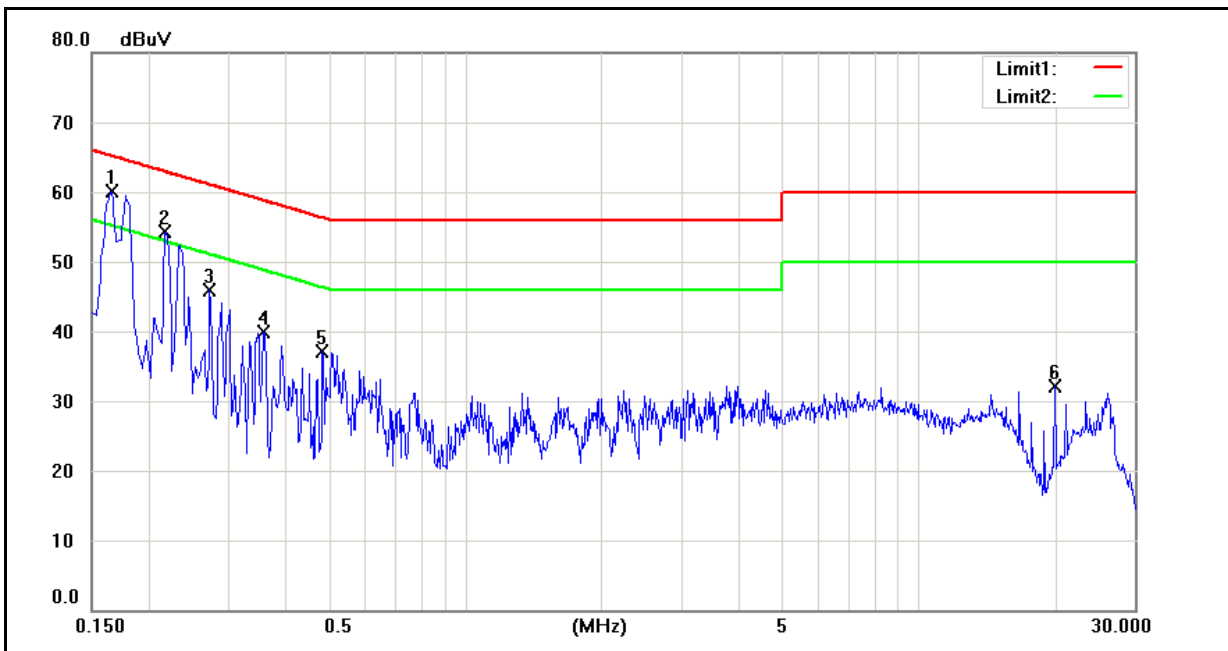

No.	Frequency (MHz)	QP reading (dBuV)	AVG reading (dBuV)	Correction factor (dB)	QP result (dBuV)	AVG result (dBuV)	QP limit (dBuV)	AVG limit (dBuV)	QP margin (dB)	AVG margin (dB)	Remark
1	0.1660	48.99	29.82	9.60	58.59	39.42	65.16	55.16	-6.57	-15.74	Pass
2	0.2180	41.42	20.98	9.59	51.01	30.57	62.89	52.89	-11.88	-22.32	Pass
3	0.2740	34.02	14.21	9.59	43.61	23.80	61.00	51.00	-17.39	-27.20	Pass
4	0.3580	26.31	11.68	9.59	35.90	21.27	58.77	48.77	-22.87	-27.50	Pass
5	0.4860	21.39	8.04	9.59	30.98	17.63	56.24	46.24	-25.26	-28.61	Pass
6	20.0500	21.06	20.66	9.82	30.88	30.48	60.00	50.00	-29.12	-19.52	Pass

Standard:	FCC Part 24E	Line:	N
Test item:	Conducted Emission	Power:	AC 120V/60Hz
Model Number:	FD-400eTi	Temp.(°C)/Hum.(%RH):	26(°C)/60%RH
Mode:	Mode 2	Date:	2010/07/28
		Test By:	Gary Wu
Description:		EUT with AC adapter	

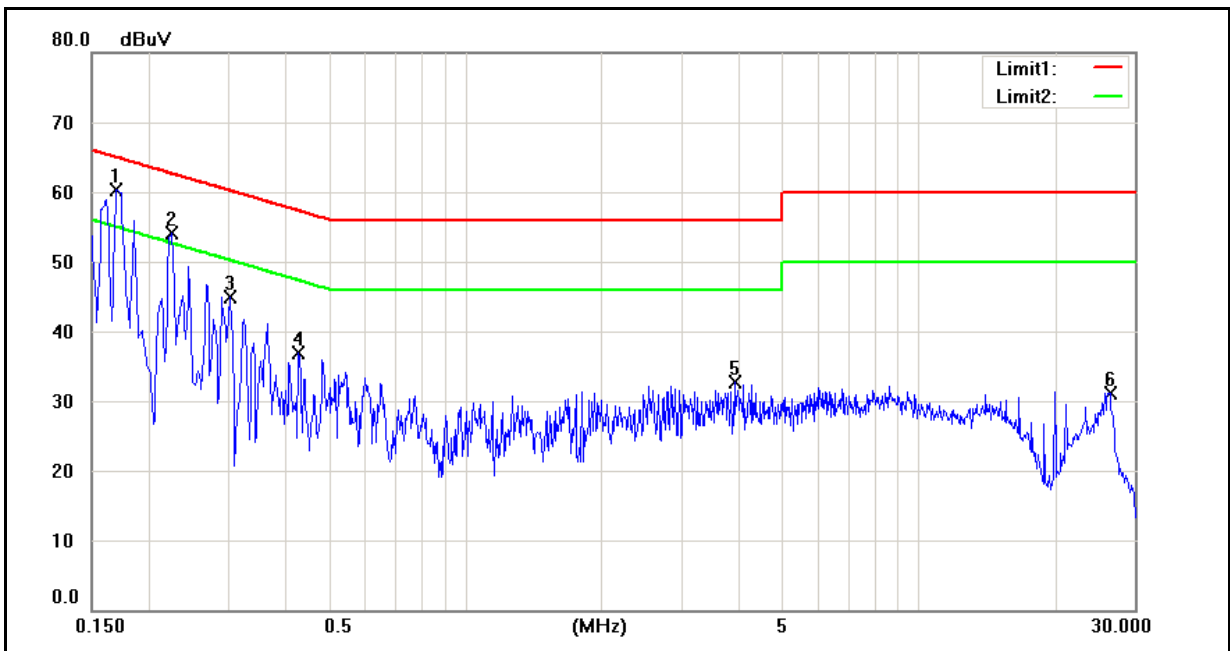

No.	Frequency (MHz)	QP reading (dBuV)	AVG reading (dBuV)	Correction factor (dB)	QP result (dBuV)	AVG result (dBuV)	QP limit (dBuV)	AVG limit (dBuV)	QP margin (dB)	AVG margin (dB)	Remark
1	0.1700	47.77	29.22	9.59	57.36	38.81	64.96	54.96	-7.60	-16.15	Pass
2	0.2260	39.79	20.68	9.58	49.37	30.26	62.60	52.60	-13.23	-22.34	Pass
3	0.3020	33.41	14.63	9.59	43.00	24.22	60.19	50.19	-17.19	-25.97	Pass
4	0.4300	21.15	8.36	9.59	30.74	17.95	57.25	47.25	-26.51	-29.30	Pass
5	3.9380	20.73	11.91	9.62	30.35	21.53	56.00	46.00	-25.65	-24.47	Pass
6	26.5140	12.64	4.35	10.03	22.67	14.38	60.00	50.00	-37.33	-35.62	Pass