

FCC 47 CFR PART 22H and 24E

Product Type : Portable Terminal

Applicant : XAC AUTOMATION CORPORATION

Address : 4F., NO.30, INDUSTRY E. RD. IX, SCIENCE-BASED
INDUSTRIAL PARK, HSIN-CHU, Taiwan, R.O.C.

Trade name : FDC

Model No. : FD-400 , FD-400(MC8790)

Test Specification : FCC 47 CFR PART 22H: May, 2006
ANSI/TIA-603-2007

Issue Date : Nov. 30, 2009

Issue by

A Test Lab Techno Corp.
No. 140-1, Changan Street, Bade City,
Taoyuan Country 334, Taiwan R.O.C.
Tel : +86-3-2710188 / Fax : +86-3-2710190



Taiwan Accreditation Foundation accreditation number: 1330

Note: This report shall not be reproduced except in full, without the written approval of A Test Lab Techno Corp. This document may be altered or revised by A Test Lab Techno Corp. personnel only, and shall be noted in the revision section of the document. The client should not use it to claim product endorsement by TAF, or any government agencies. The test results in the report only apply to the tested sample.

Revision History

Rev.	Issue Date	Revisions	Revised By
00	Nov. 30, 2009	Initial Issue	

Test Report Certification

Issued Date: 2009/11/30

Product Type : Portable Terminal
Applicant : XAC AUTOMATION CORPORATION
Address : 4F., NO.30, INDUSTRY E. RD. IX, SCIENCE-BASED
INDUSTRIAL PARK, HSIN-CHU, Taiwan, R.O.C.
Trade Name : FDC
Model No. : FD-400 , FD-400(MC8790)
EUT Rated Voltage : AC 100-240V, 50-60Hz, 1A
Test Voltage : 120 Vac / 60 Hz
Applicable : FCC 47 CFR PART 22H: May, 2006
Standard : ANSI/TIA-603-2007

Test Result : Complied
Performed Lab. : A Test Lab Techno Corp.

No. 140-1, Changan Street, Bade City
Taoyuan Country 334, Taiwan R.O.C.

Tel : +86-3-2710188 / Fax : +86-3-2710190

Taiwan Accreditation Foundation accreditation number:
1330

<http://www.atl-lab.com.tw/e-index.htm>



The above equipment has been tested by A Test Lab Techno Corp., and found compliance with the requirements set forth in the Electromagnetic Compatibility Directive 2004/108/EC and technical standards mentioned above. The results of testing in this report apply only to the product/system, which was tested. Other similar equipment will not necessarily produce the same results due to production tolerance and measurement uncertainties.

Approved By

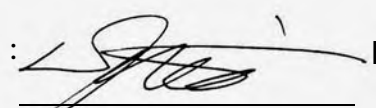
(Director)

(Kevin Wang)

Reviewed By

(Manager)

(Miller Lee)

TABLE OF CONTENTS

1	General Information.....	6
1.1.	EUT Description	6
1.2.	Mode of Operation	7
1.3.	EUT Exercise Software	9
1.4.	Configuration of Test System Details	9
1.5.	Test Site Environment	9
1.6.	Summary of Test Result	10
2	RF Output Power Test	11
2.1.	Limit.....	11
2.2.	Test Instruments.....	11
2.3.	Test Setup	11
2.4.	Test Procedure	11
2.5.	Uncertainty	12
2.6.	Test Result	12
3	Effective Radiated Power / Equivalent Isotropic Radiated Power Test.....	14
3.1.	Limit.....	14
3.2.	Test Instruments.....	14
3.3.	Test Setup	15
3.4.	Test Procedure	15
3.5.	Uncertainty	18
3.6.	Test Result	19
4	Occupied Bandwidth Test.....	21
4.1.	Limit.....	21
4.2.	Test Instruments.....	21
4.3.	Setup.....	21
4.4.	Test Procedure	22
4.5.	Uncertainty	22
4.6.	Test Result	23
5	Conducted Emission Test.....	39
5.1.	Limit.....	39
5.2.	Test Instruments.....	39
5.3.	Setup.....	40
5.4.	Test Procedure	41
5.5.	Uncertainty	41
5.6.	Test Result	41
5.7.	Test Photograph.....	69
6	Field Strength of Spurious Radiation Test.....	70
6.1.	Limit.....	70
6.2.	Test Instruments.....	70
6.3.	Setup.....	70
6.4.	Test Procedure	71
6.5.	Uncertainty	71
6.6.	Test Result	72
6.7.	Test Photograph.....	96

7	Frequency Stability (Temperature Variation) Test	98
7.1.	Limit.....	98
7.2.	Test Instruments.....	98
7.3.	Setup.....	98
7.4.	Test Procedure.....	99
7.5.	Uncertainty	99
7.6.	Test Result	100
8	Frequency Stability (Voltage Variation) Test	102
8.1.	Limit.....	102
8.2.	Test Instruments.....	102
8.3.	Setup.....	102
8.4.	Test Procedure.....	103
8.5.	Uncertainty	103
8.6.	Test Result	104
9	AC Power Conducted Emissions Test.....	105
9.1.	Limit.....	105
9.2.	Test Instruments.....	105
9.3.	Setup.....	105
9.4.	Test Procedure.....	106
9.5.	Uncertainty	106
9.6.	Test Result	107
9.7.	Test Photograph.....	118

1 General Information

1.1. EUT Description

Applicant		XAC Automation Corporation			
Applicant Address		4F., NO.30, INDUSTRY E. RD. IX, SCIENCE-BASED INDUSTRIAL PARK, HSIN-CHU, Taiwan, R.O.C.			
Manufacturer		XAC Automation Corporation			
Manufacturer Address		4F., NO.30, INDUSTRY E. RD. IX, SCIENCE-BASED INDUSTRIAL PARK, HSIN-CHU, Taiwan, R.O.C.			
Product Type		Portable Terminal			
Trade Name		FDC			
Model Number		FD-400 , FD-400(MC8790)			
Mode	GPRS & EGPRS	Band	UL Frequency (MHz)	DL Frequency (MHz)	Modulation
		850	824.2 ~ 848.8	869.2 ~ 893.8	8PSK
		1900	1850.2 ~ 1909.8	1930.2 ~ 1989.8	8PSK
	WCDMA & HSDPA	Band	UL Frequency (MHz)	DL Frequency (MHz)	Modulation
		II	1852.4 ~ 1907.6	1932.4 ~ 1987.6	QPSK
V	826.4 ~ 846.6	871.4 ~ 891.6	QPSK		
Channel Control		Auto			
Type of Antenna		External Type			
Antenna Gain (dBi)		GSM/GPRS/EGPRS 850: 2.7 dBi GPRS/EGPRS 1900: 1.3 dBi WCDMA/HSDPA Band II: 1.3 dBi WCDMA/HSDPA Band V: 2.7 dBi			
Hardware version		C01			
Software version		00431214			
Component					
Power Adapter		LSE, LSE0107A1240 Input: 100-240Vac, 1A, 50/60Hz Output: 12Vdc, 3.33A Cable in: Shielded, 1.72 m Cable out: Non-Shielded, 1.47 m			

1.2. Mode of Operation

ATL has verified the construction and function in typical operation. All the test modes were carried out with the EUT in normal operation, which was shown in this test report and defined as:

Test Mode
Mode 1: GPRS850 Link
Mode 2: GPRS1900 Link
Mode 3: EGPRS850 Link
Mode 4: EGPRS1900 Link
Mode 5: WCDMA Band II Link
Mode 6: WCDMA Band V Link
Mode 7: HSDPA Band II Link
Mode 8: HSDPA Band V Link

Note: Regards to the frequency band operation: the lowest, middle and highest frequency of channel were selected to perform the test, then shown on this report.

Preliminary tests were performed in different mode to find the worst case. The mode shown in the table below is the worst-case. Investigation has been done on all the possible configurations for searching the worst cases. The following table is a list of the test modes shown in this test report.

Mode	Multi-Class	Frequency (MHz)	Conducted Power (dBm)	Worst Case
GPRS850	3Down2up	824.2	31.60	■
		836.4	31.50	□
		848.8	31.50	□
GSRS1900	3Down2up	1850.20	29.20	■
		1880.00	29.00	□
		1909.80	28.90	□
EGPRS850	3Down2up	824.2	24.12	□
		836.4	24.04	□
		848.8	24.72	□
EGSRS1900	3Down2up	1850.20	23.15	□
		1880.00	23.23	□
		1909.80	23.71	□

Note: The EGPRS only test RF output power, EIRP/ERP and occupied bandwidth.

Mode	Data Rate / Sub-Test	Frequency (MHz)	Conducted Power (dBm)	Worst Case
WCDMA Band II	-----	1852.4	26.20	<input checked="" type="checkbox"/>
		1880.0	26.10	<input type="checkbox"/>
		1907.6	26.00	<input type="checkbox"/>
WCDMA Band V	-----	826.4	25.80	<input checked="" type="checkbox"/>
		836.4	25.80	<input checked="" type="checkbox"/>
		846.4	25.60	<input type="checkbox"/>
HSDPA Band II	1	1852.4	24.96	<input type="checkbox"/>
		1880.0	25.60	<input type="checkbox"/>
		1907.6	25.50	<input type="checkbox"/>
	2	1852.4	24.58	<input type="checkbox"/>
		1880.0	25.43	<input type="checkbox"/>
		1907.6	25.08	<input type="checkbox"/>
	3	1852.4	24.73	<input type="checkbox"/>
		1880.0	24.67	<input type="checkbox"/>
		1907.6	25.01	<input type="checkbox"/>
	4	1852.4	24.25	<input type="checkbox"/>
		1880.0	24.58	<input type="checkbox"/>
		1907.6	24.67	<input type="checkbox"/>
HSDPA Band V	1	826.4	25.01	<input type="checkbox"/>
		836.4	25.22	<input type="checkbox"/>
		846.4	25.03	<input type="checkbox"/>
	2	826.4	24.53	<input type="checkbox"/>
		836.4	24.68	<input type="checkbox"/>
		846.4	24.48	<input type="checkbox"/>
	3	826.4	24.59	<input type="checkbox"/>
		836.4	24.72	<input type="checkbox"/>
		846.4	24.52	<input type="checkbox"/>
	4	826.4	23.98	<input type="checkbox"/>
		836.4	24.20	<input type="checkbox"/>
		846.4	23.98	<input type="checkbox"/>

Note: The HSDPA only test RF output power.

Tested System Details

The types for all equipments, plus descriptions of all cables used in the tested system (including inserted cards) are:

	Product	Manufacturer	Model No.	Serial No.	Power Cord
1.	Universal Radio Communication Tester	R&S	CMU200	109369	N/A

1.3. EUT Exercise Software

1.	Setup the EUT and Base Station (CMU200) as shown on 3.3.
2.	Turn on the power of all equipment.
3.	EUT run test program can reads and writes data into and from USB storage.

1.4. Configuration of Test System Details

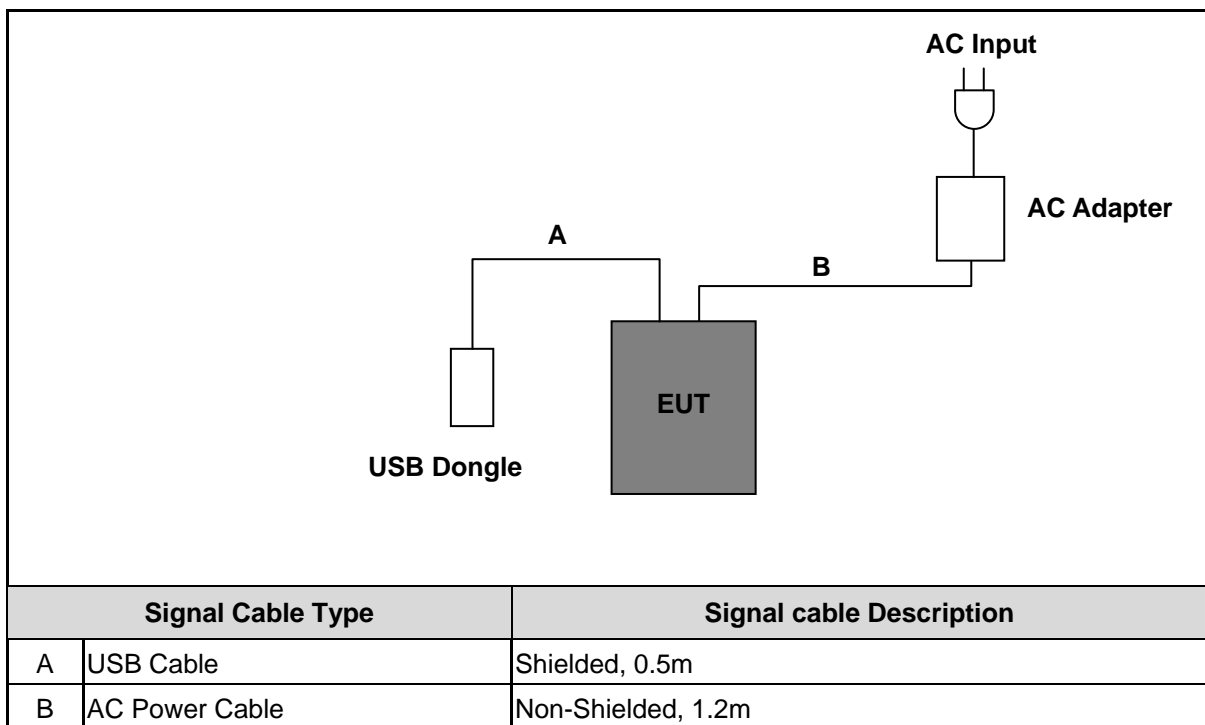

Devices Description				
Product	Manufacturer	Model No.	Serial No.	Power Cord
1. USB	Transcend	JF V60	--	--

1.5. Test Site Environment

Items	Required (IEC 68-1)	Actual
Temperature (°C)	15-35	25
Humidity (%RH)	25-75	50
Barometric pressure (mbar)	860-1060	950-1000

1.6. Summary of Test Result

Description	FCC Rule	IC Rule	Limit	Result
Conducted Output Power	§2.1046	N/A	N/A	Pass
Effective Radiated Power	§22.913(a)(2)	RSS-132(4.4) SRSP-503(5.1.3)	< 7 Watts for FCC (<6.3 Watts for IC)	Pass
Equivalent Isotropic Radiated Power	§24.232(c)	RSS-133 (6.4) SRSP-510(5.1.2)	< 2 Watts	Pass
Occupied Bandwidth	§2.1049 §22.917(a) §24.238(a)	N/A	N/A	Pass
Band Edge Measurement	§2.1051 §22.917(a) §24.238(a)	RSS-132 (4.5.1)RSS-133 (6.5.1)	< 43+10log ₁₀ (P[Watts])	Pass
Conducted Emission	§2.1051 §22.917(a) §24.238(a)	RSS-132 (4.5.1) RSS-133 (6.5.1)	< 43+10log ₁₀ (P[Watts])	Pass
Field Strength of Spurious Radiation	§2.1053 §22.917(a) §24.238(a)	RSS-132 (4.5.1) RSS-133 (6.5.1)	< 43+10log ₁₀ (P[Watts])	Pass
Frequency Stability for Temperature & Voltage	§2.1055 §22.355 §24.235	RSS-132(4.3) RSS-133(6.3)	< 2.5 ppm	Pass

2 RF Output Power Test

2.1. Limit

N/A

2.2. Test Instruments

Describe	Manufacturer	Model No.	Serial No.	Cal. Date
Universal Radio Communication Tester	ROHDE & SCHWARZ	CMU200	109369	07/29/2009
Test Site	ATL	TE02	TE02	N.C.R.

NOTE: N.C.R. = No Calibration Request.

2.3. Test Setup

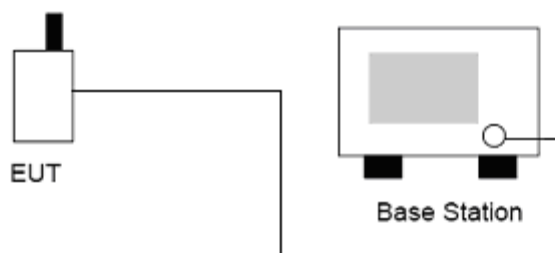

2.4. Test Procedure

The measurement is made according to ANSI/TIA-603-C-2004 as follows:

1. The transmitter output was connected to power meter and base station through power divider.
2. Set base station for EUT at GPRS/EGPRS: PCL=5 and GPRS/EGPRS 1900: PCL=0.
3. Set base station for EUT at WCDMA Band V and WCDMA Band II, power level was set to maximum.
4. Select lowest, middle, and highest channels for each band.

2.5. Uncertainty

The measurement uncertainty is defined as for RF output power measurement is 1.2 dB.

2.6. Test Result

Product	Portable Terminal		
Test Item	RF Output Power		
Date of Test	11/21/2009	Test Site	TE02

Bands	Frequency (MHz)	Conducted Power		Result
		(dBm)	(W)	
GPRS 850	824.2	31.60	1.445	Pass
	836.4	31.50	1.413	Pass
	848.8	31.50	1.413	Pass

Bands	Frequency (MHz)	Conducted Power		Result
		(dBm)	(W)	
GPRS 1900	1850.20	29.20	0.832	Pass
	1880.00	29.00	0.794	Pass
	1909.80	28.90	0.776	Pass

Bands	Frequency (MHz)	Conducted Power		Result
		(dBm)	(W)	
EGPRS 850	824.2	24.12	0.258	Pass
	836.4	24.04	0.254	Pass
	848.8	24.72	0.296	Pass

Bands	Frequency (MHz)	Conducted Power		Result
		(dBm)	(W)	
EGPRS 1900	1850.20	23.15	0.207	Pass
	1880.00	23.23	0.210	Pass
	1909.80	23.71	0.235	Pass

Bands	Frequency (MHz)	Conducted Power		Result
		(dBm)	(W)	
WCDMA Band II	1852.4	26.20	0.417	Pass
	1880.0	26.10	0.407	Pass
	1907.6	26.00	0.398	Pass

Bands	Frequency (MHz)	Conducted Power		Result
		(dBm)	(W)	
WCDMA Band V	826.4	25.80	0.380	Pass
	836.4	25.80	0.380	Pass
	846.4	25.60	0.363	Pass

Bands	Frequency (MHz)	Conducted Power		Result
		(dBm)	(W)	
HSDPA Band II (Sub-test 1)	1852.4	24.96	0.313	Pass
	1880.0	25.60	0.363	Pass
	1907.6	25.50	0.355	Pass

Bands	Frequency (MHz)	Conducted Power		Result
		(dBm)	(W)	
HSDPA Band V (Sub-test 1)	826.4	25.01	0.317	Pass
	836.4	25.22	0.333	Pass
	846.4	25.03	0.318	Pass

Note: The testing result was used peak detector.

3 Effective Radiated Power / Equivalent Isotropic Radiated Power Test

3.1. Limit

For FCC Part 22.913(a)(2): The ERP of mobile transmitters and auxiliary test transmitters must not exceed 7 Watts.

For FCC Part 24.232(b): The EIRP of mobile transmitters and auxiliary test transmitters must not exceed 2 Watts.

3.2. Test Instruments

Describe	Manufacturer	Model No.	Serial No.	Cal. Date
Universal Radio Communication Tester	ROHDE & SCHWARZ	CMU200	109369	07/29/2009
Spectrum Analyzer	Agilent	E4445A	MY45300744	12/22/2008
Loop Dipole	ETS-Lindgren	3127-1880	00064239	02/05/2009
Loop Dipole	ETS-Lindgren	3127-836	00064352	02/19/2009
Sleeve Dipole	ETS-Lindgren	3126-1845	00083335	03/18/2009
Sleeve Dipole	ETS-Lindgren	3126-880	00052705	11/05/2009
Circularly Polarized Communication Antennas	EMCO	3102	00051714	NCR
Antenna Positioner Controller	EMCO	2090	00052447	NCR
MAPS Positioner	EMCO	2010/2015	NA	NCR
Pattern Measurement Software	ETS-Lindgren	EMQuest™ EMQ-100	NA	NCR
Desktop Computer with Windows XP	DELL	Dell Computers	NA	NCR
Anechoic Chamber	ETS-Lindgren	AMS 8500	102165	NCR

NOTE: N.C.R. = No Calibration Request.

3.3. Test Setup

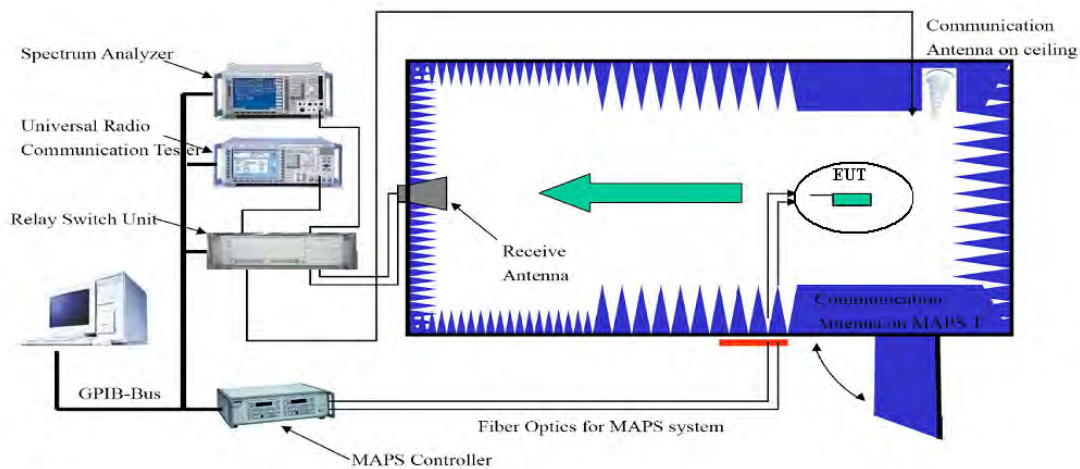

3.4. Test Procedure

The phone was tested in an anechoic chamber with a 3-axis position system that permits taking complete spherical scans of the EUT's 3-axis radiation patterns. For all tests, the phone was supported in a free space type environment, vertically oriented in the chamber. Tests were done for GPRS/EGPRS 850 three frequencies (824.2, 836.6 and 848.8 MHz) and GPRS/EGPRS 1900 three frequencies (1850.2, 1880.00, and 1909.80 MHz).

GSM measurements were made with the phone placed in a call using the CMU200 mobile station test set. The phone was weakly coupled to the test set and configured to transmit in full data rate mode.

The radiated power was measured using ETS-LINDGREN OTA Chamber in "Peak" mode. From these measurements, the software calculates the angle at which maximum radiated power occurs for each case, and the radiated power at this angle was extracted from the data.

Each individual data point in a radiated power or sensitivity measurement is referred to as the effective isotropic radiated power or effective isotropic sensitivity. That is, the desired information is how the measured quantity relates to the same quantity from an isotropic radiator. Thus, the reference measurement must relate the power received or transmitted at the EUT test equipment (spectrum analyzer or communication tester) back to the power transmitted or received at a theoretical isotropic radiator. The total path loss then, is just the difference in dB between the power transmitted or received at the isotropic radiator and that seen at the test equipment (see follow Figure 1).

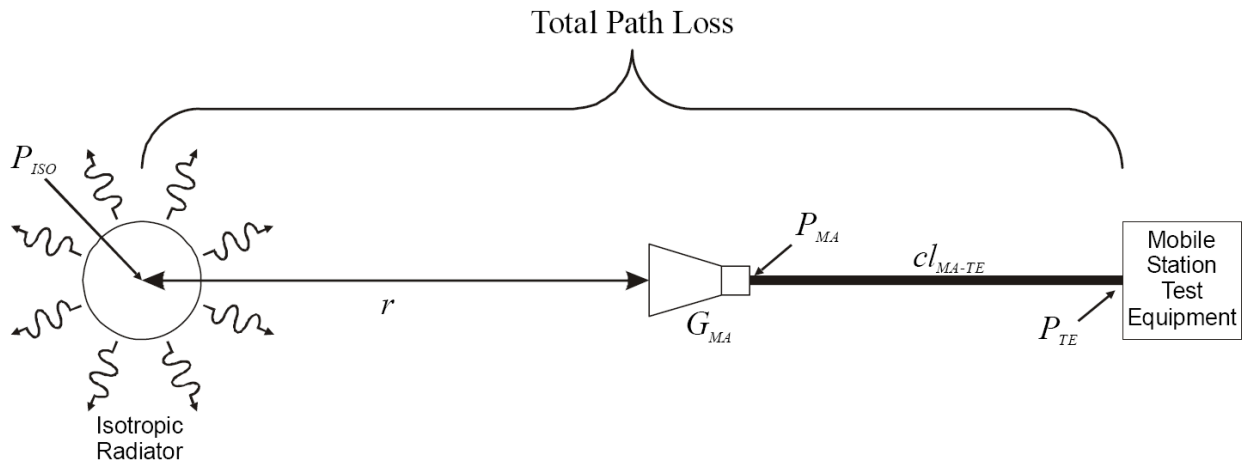

Figure 1. THEORETICAL CASE FOR DETERMINING PATH LOSS

In equation form, this becomes:

Equation 1

$$PL = P_{ISO} - P_{TE}$$

where PL is the total path loss, P_{ISO} is the power radiated by the theoretical isotropic radiator, and P_{TE} is the power received at the test equipment port. As can be seen in Figure 1, this quantity includes the range path loss due to the range length r , the gain of the measurement antenna, and any loss terms associated with the cabling, connections, amplifiers, splitters, etc. between the measurement antenna and the test equipment port.

Figure 2 shows a typical real world configuration for measuring the path loss. In this case, a reference antenna with known gain is used in place of the theoretical isotropic source. The path loss may then be determined from the power into the reference antenna by adding the gain of the reference antenna.

That is:

Equation 2

$$P_{ISO} = P_{RA} + G_{RA}$$

where P_{RA} is the power radiated by reference antenna, and G_{RA} is the gain of the reference antenna, so that:

Equation 3

$$PL = P_{RA} + G_{RA} - P_{TE}$$

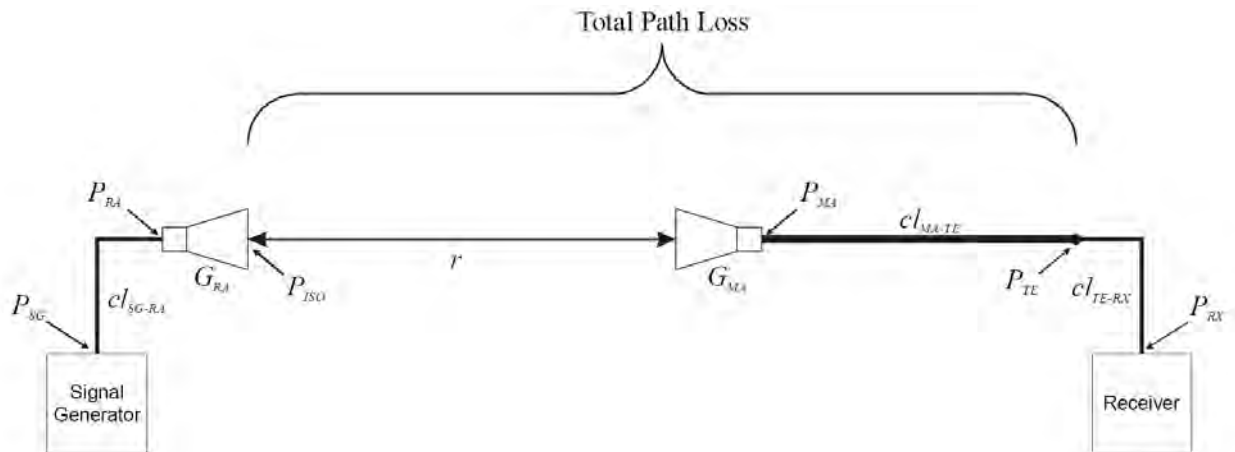

Figure 2. TYPICAL CONFIGURATION FOR MEASURING PATH LOSS

In order to determine P_{RA} , it is necessary to perform a cable reference measurement to remove the effects of the cable loss between signal generator and reference antenna, and between the test equipment port and the receiver. This establishes a reference point at the input to the reference antenna. Figure 3 illustrates the cable reference measurement configuration. Assuming the power level at the signal generator is fixed, it is easy to show that the difference between P_{RA} and P_{TE} in Figure 2 is given by:

Equation 4

$$P_{RA} - P_{TE} = P_{RX}' - P_{RX}$$

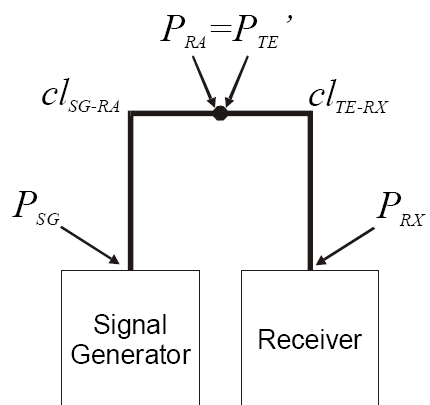

Figure 3. CABLE REFERENCE CALIBRATION CONFIGURATION

Where P_{RX} is the power measured at the receiver during the cable reference test, and P_{RX} is the power measured at the receiver during the range path loss measurement in Figure 2. Thus, the path loss is then just given by:

Equation 5

$$PL = G_{RA} + P_{RX} - P_{RX}$$

$$EIRP = P_t + P_L$$

P_t = Often referred to as antenna output power

3.5. Uncertainty

The measurement uncertainty is defined as for Radiated Power measurement list below:

Band	Uncertainty
Cell	1.08 dB
PCS	1.42 dB
GPRS	1.44 dB

3.6. Test Result

Product	Portable Terminal		
Test Item	ERP/EIRP		
Date of Test	11/25/2009	Test Site	TC03

Bands	Frequency (MHz)	Read Level (dBm)	Correction factor (dBm)	ERP		Result
				(dBm)	(W)	
GPRS 850	824.2	81.30	-49.50	31.80	1.514	Pass
	836.4	81.06	-49.70	31.36	1.368	Pass
	848.8	81.22	-49.70	31.52	1.419	Pass

Bands	Frequency (MHz)	Read Level (dBm)	Correction factor (dBm)	EIRP		Result
				(dBm)	(W)	
GPRS 1900	1850.20	85.81	-55.40	30.41	1.099	Pass
	1880.00	85.55	-55.60	29.95	0.989	Pass
	1909.80	85.57	-55.70	29.87	0.971	Pass

Bands	Frequency (MHz)	Read Level (dBm)	Correction factor (dBm)	ERP		Result
				(dBm)	(W)	
EGPRS 850	824.2	72.04	-49.50	22.54	0.179	Pass
	836.4	72.33	-49.70	22.63	0.183	Pass
	848.8	72.21	-49.70	22.51	0.178	Pass

Bands	Frequency (MHz)	Read Level (dBm)	Correction factor (dBm)	EIRP		Result
				(dBm)	(W)	
EGPRS 1900	1850.20	78.85	-55.40	23.45	0.221	Pass
	1880.00	79.21	-55.60	23.61	0.230	Pass
	1909.80	79.59	-55.70	23.89	0.245	Pass

Bands	Frequency (MHz)	Read Level (dBm)	Correction factor (dBm)	EIRP		Result
				(dBm)	(W)	
WCDMA Band II	1852.4	82.89	-55.40	27.49	0.561	Pass
	1880.0	82.81	-55.60	27.21	0.526	Pass
	1907.6	82.83	-55.70	27.13	0.516	Pass

Bands	Frequency (MHz)	Read Level (dBm)	Correction factor (dBm)	ERP		Result
				(dBm)	(W)	
WCDMA Band V	826.4	75.47	-49.50	25.97	0.395	Pass
	836.4	75.79	-49.70	26.09	0.406	Pass
	846.4	75.84	-49.70	26.14	0.411	Pass

Bands	Frequency (MHz)	Read Level (dBm)	Correction factor (dBm)	EIRP		Result
				(dBm)	(W)	
HSDPA Band II (Sub-test 1)	1852.4	82.43	-55.40	27.03	0.505	Pass
	1880.0	82.84	-55.60	27.24	0.529	Pass
	1907.6	82.82	-55.70	27.12	0.515	Pass

Bands	Frequency (MHz)	Read Level (dBm)	Correction factor (dBm)	ERP		Result
				(dBm)	(W)	
HSDPA Band V (Sub-test 1)	826.4	73.41	-49.50	23.91	0.246	Pass
	836.4	73.77	-49.70	24.07	0.255	Pass
	846.4	73.70	-49.70	24.00	0.251	Pass

Note: 1. ERP/EIRP = Read Level + Correction factor.

2. For WCDMA signals, a peak detector is used with RBW = VBW = 5MHz.

3. For AMPS, GSM, and NADC TDMA signals, a peak detector is used, with RBW = VBW= 1 MHz.

4 Occupied Bandwidth Test

4.1. Limit

The Occupied Bandwidth Limit:

N/A.

The Band Edge Limit:

The power of any emission outside of the authorized operating frequency ranges must be attenuated below the transmitting power (P) by a factor of at least $43 + 10\log(P)$ dB.

4.2. Test Instruments

Describe	Manufacturer	Model No.	Serial No.	Cal. Date
Spectrum Analyzer	Agilent	E4445A	MY46181986	05/14/2009
Universal Radio Communication Tester	ROHDE & SCHWARZ	CMU200	109369	07/29/2009
Attenuator	RADIALL	R41572000	0603033073	N.C.R.
Power divider	Agilent	87302C	3239A00760	N.C.R.
Test Site	ATL	TE02	TE02	N.C.R.

4.3. Setup

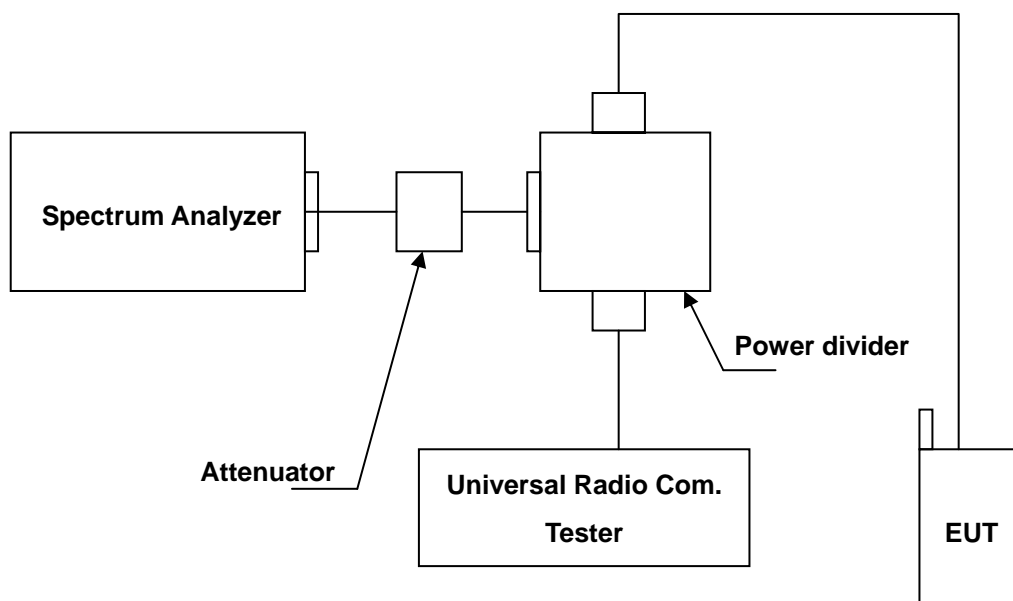

4.4. Test Procedure

The measurement is made according to FCC rules part 22 and 24:

1. The EUT was connected to Spectrum Analyzer and Base Station via power divider.
2. The occupied bandwidth of middle channel for the highest and lowest RF powers was measured.
3. The band edge of low and high channels for the highest RF powers within the transmitting frequency band were measured. Setting RBW as roughly BW/100.
4. The band edge setting:
 - a. RB=3 kHz; VB=3 kHz for GPRS/EGPRS 850 and GPRS/EGPRS 1900.
 - b. RB=100 kHz; VB=100 kHz for WCDMA Band V and WCDMA Band II.

4.5. Uncertainty

The measurement uncertainty is defined as $\pm 10\text{Hz}$

4.6. Test Result
99% Occupied Bandwidth

Product	Portable Terminal		
Test Item	Occupied Bandwidth		
Test Mode	Mode 1: GPRS850 Link		
Date of Test	11/22/2009	Test Site	TE02

Channel No.	Frequency (MHz)	-26dB Bandwidth (kHz)	Note
128	824.2	242.9616	RBW:3KHz , VBW:10KHz
190	836.4	244.6378	RBW:3KHz , VBW:10KHz
251	848.8	243.3535	RBW:3KHz , VBW:10KHz

Figure Channel 128

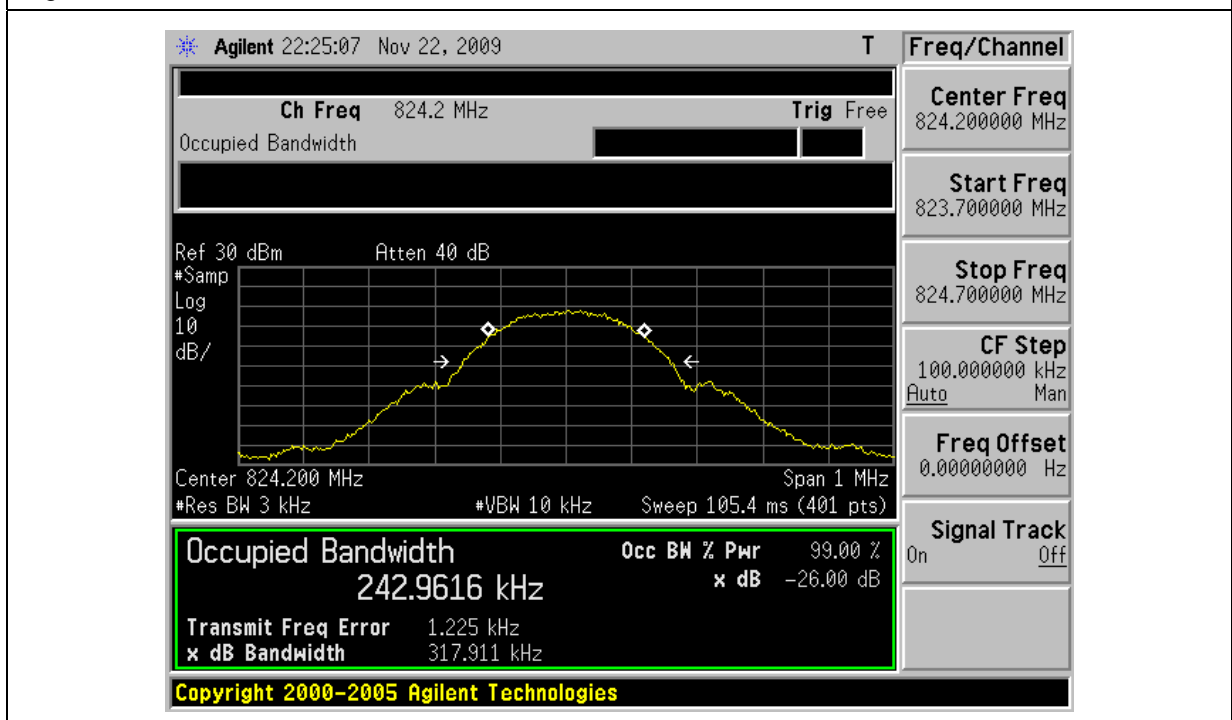

Figure Channel 190

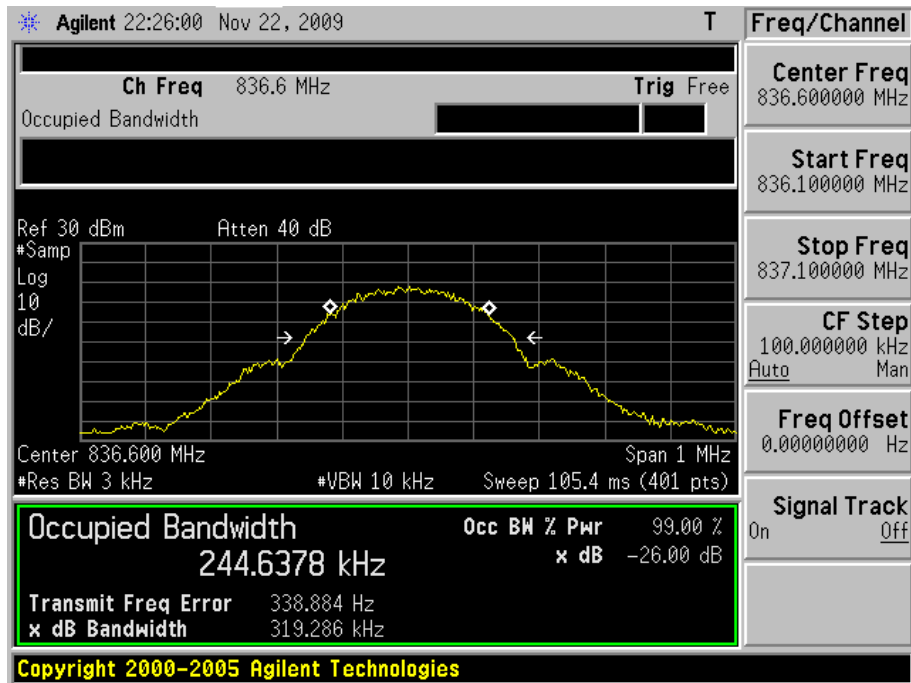
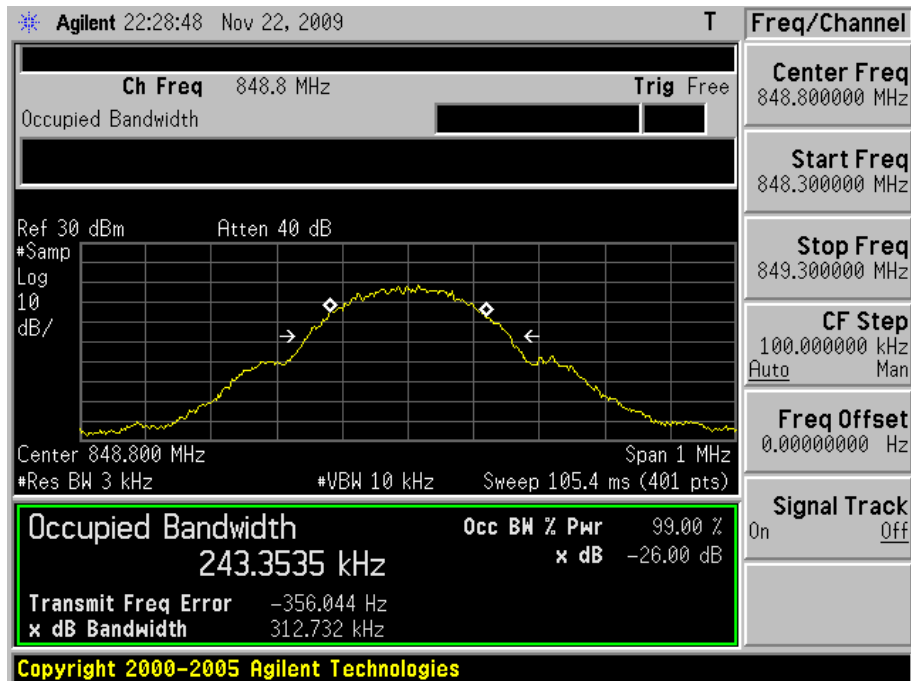

Figure Channel 251



Product	Portable Terminal		
Test Item	Occupied Bandwidth		
Test Mode	Mode 2: GPRS1900 Link		
Date of Test	11/22/2009	Test Site	TE02

Channel No.	Frequency (MHz)	-26dB Bandwidth (kHz)	Note
512	1850.20	246.4691	RBW:3KHz , VBW:10KHz
661	1880.00	245.2698	RBW:3KHz , VBW:10KHz
810	1909.80	246.8138	RBW:3KHz , VBW:10KHz

Figure Channel 512

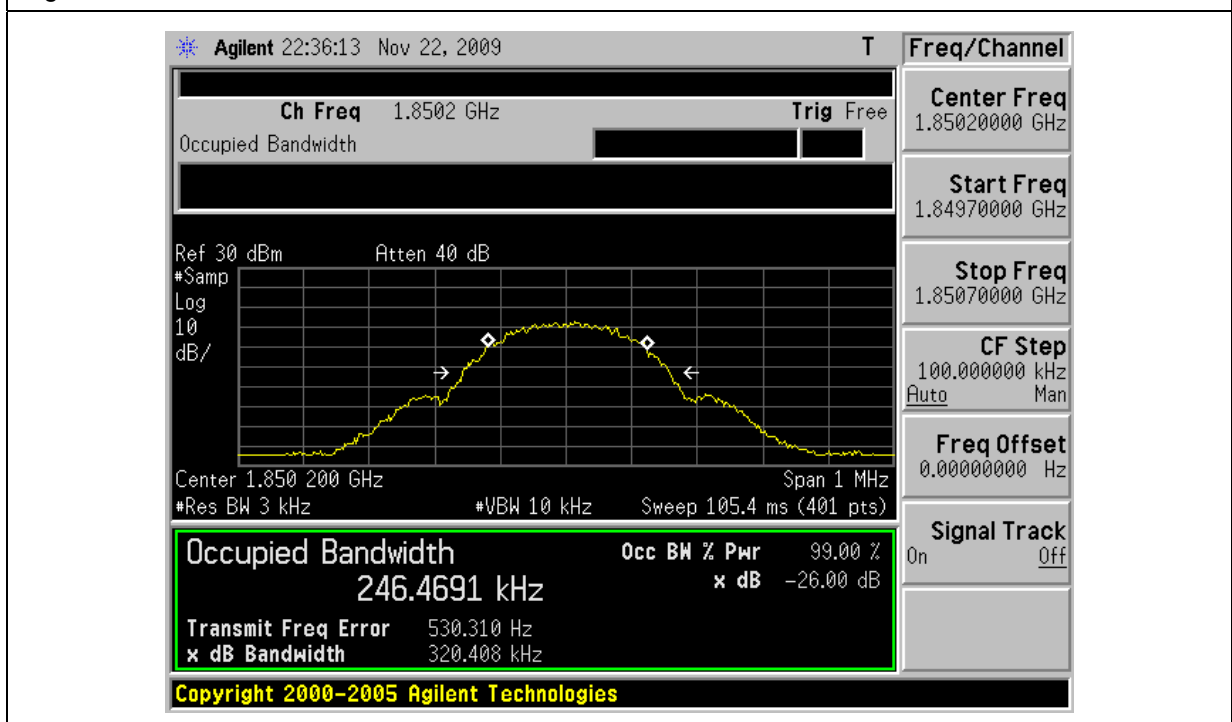

Figure Channel 661

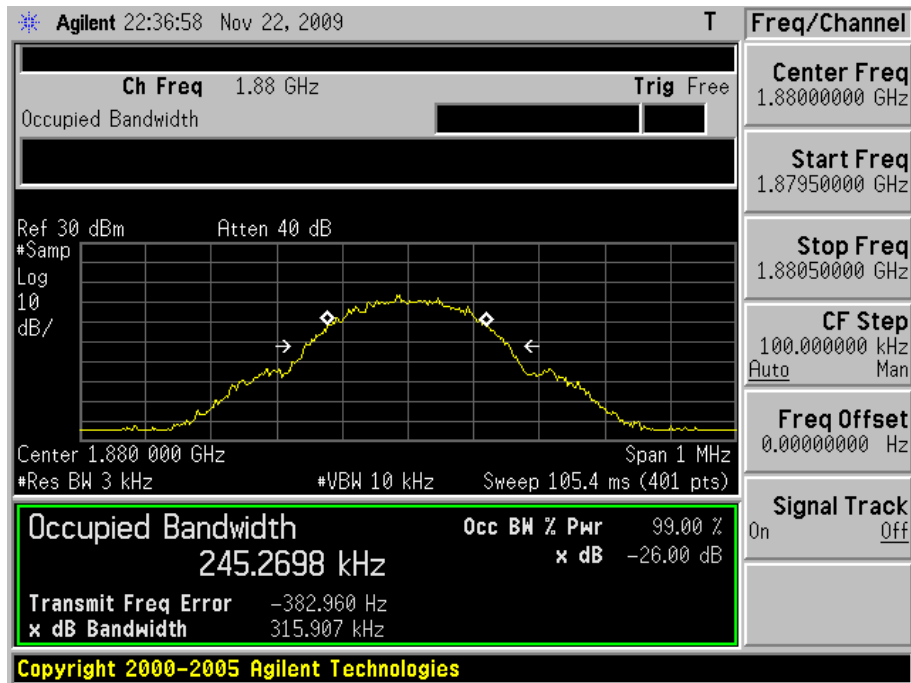
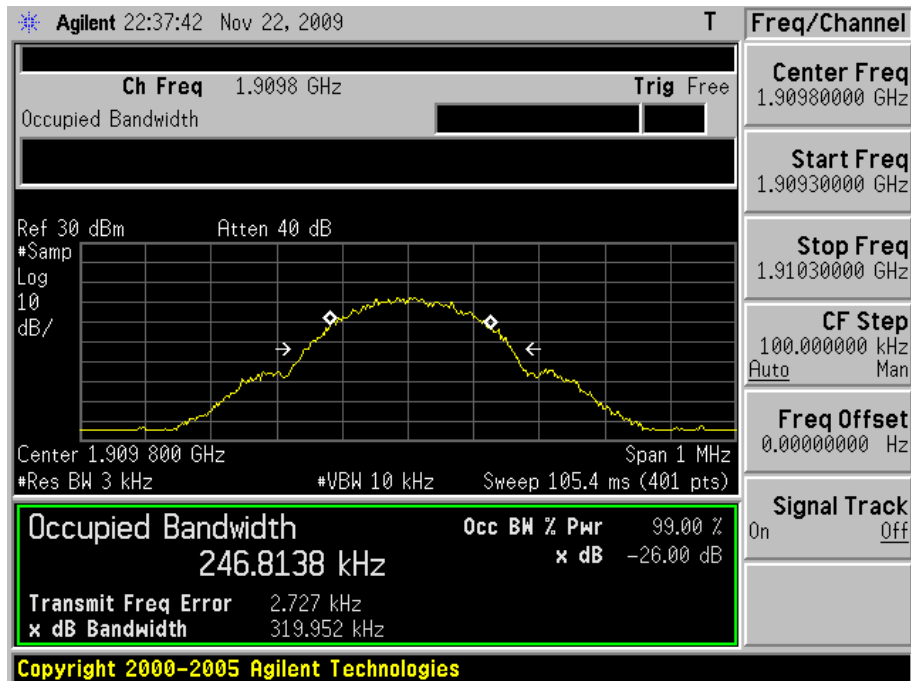

Figure Channel 810



Product	Portable Terminal		
Test Item	Occupied Bandwidth		
Test Mode	Mode 3: EGPRS850 Link		
Date of Test	11/13/2009	Test Site	TE02

Channel No.	Frequency (MHz)	-26dB Bandwidth (kHz)	Note
128	824.2	245.2115	RBW:3KHz , VBW:10KHz
190	836.4	248.2065	RBW:3KHz , VBW:10KHz
251	848.8	243.1903	RBW:3KHz , VBW:10KHz

Figure Channel 128

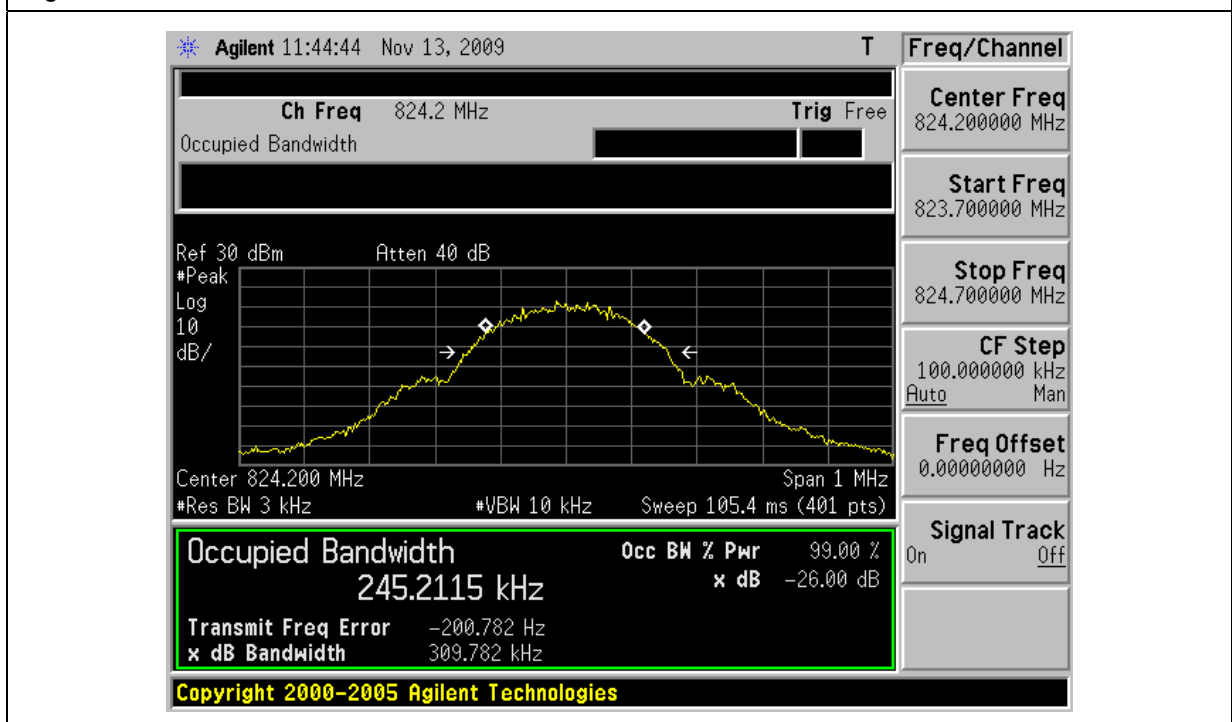

Figure Channel 190

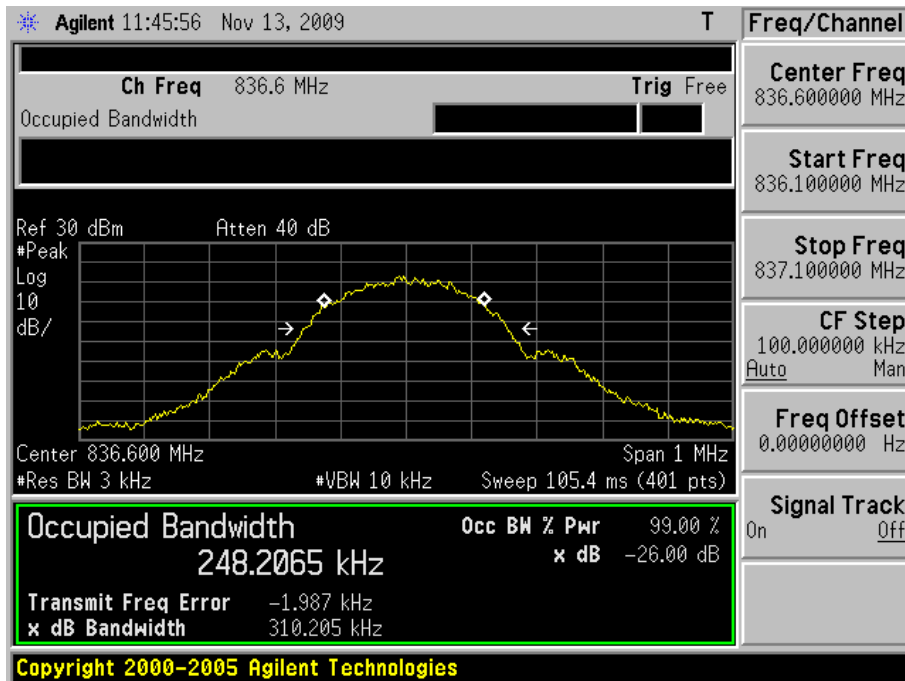
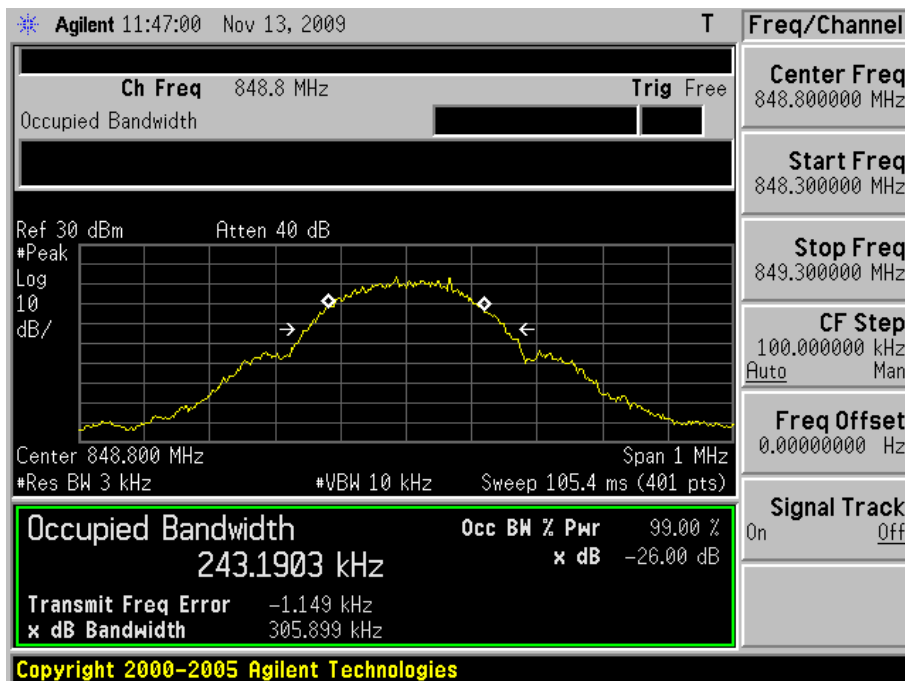

Figure Channel 251



Product	Portable Terminal		
Test Item	Occupied Bandwidth		
Test Mode	Mode 4: EGPRS1900 Link		
Date of Test	11/13/2009	Test Site	TE02

Channel No.	Frequency (MHz)	-26dB Bandwidth (kHz)	Note
512	1850.20	244.2323	RBW:3KHz , VBW:10KHz
661	1880.00	246.7343	RBW:3KHz , VBW:10KHz
810	1909.80	248.2080	RBW:3KHz , VBW:10KHz

Figure Channel 512

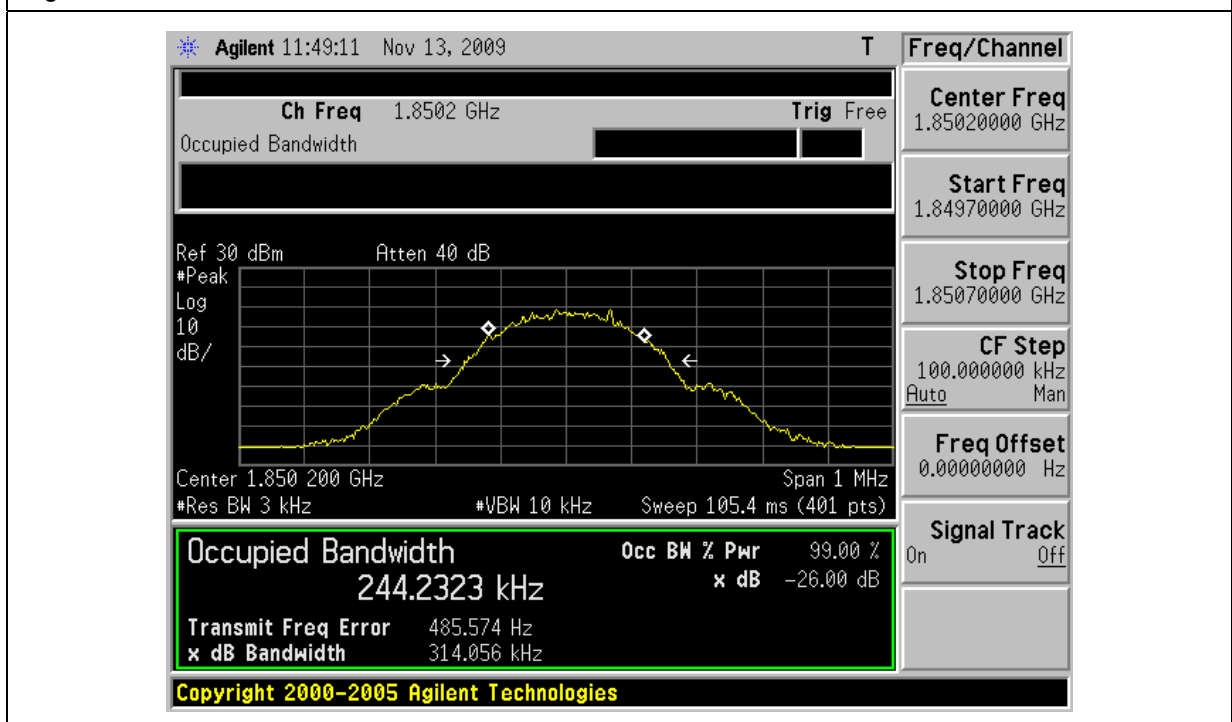

Figure Channel 661

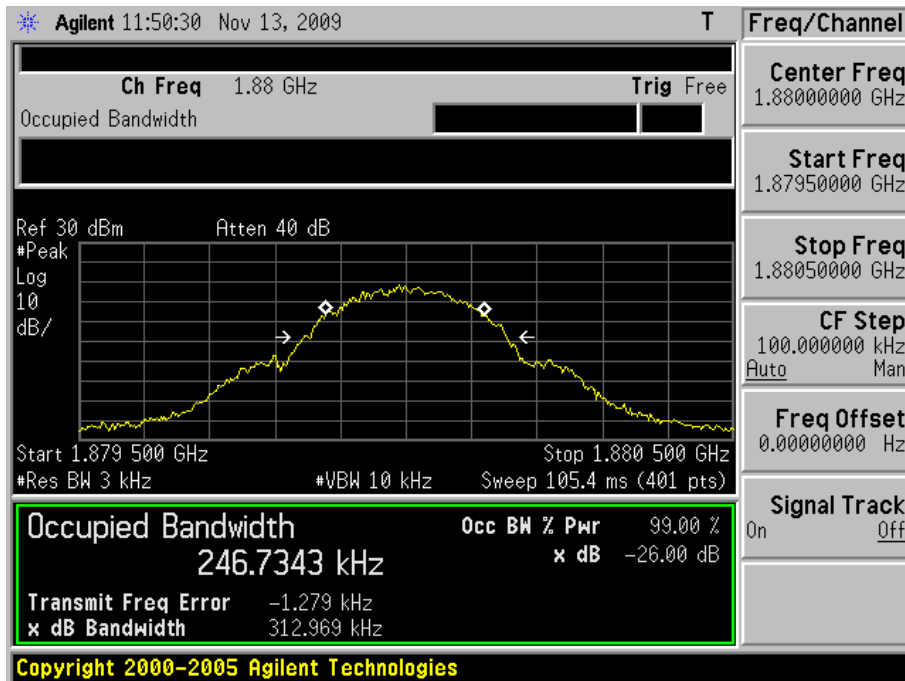
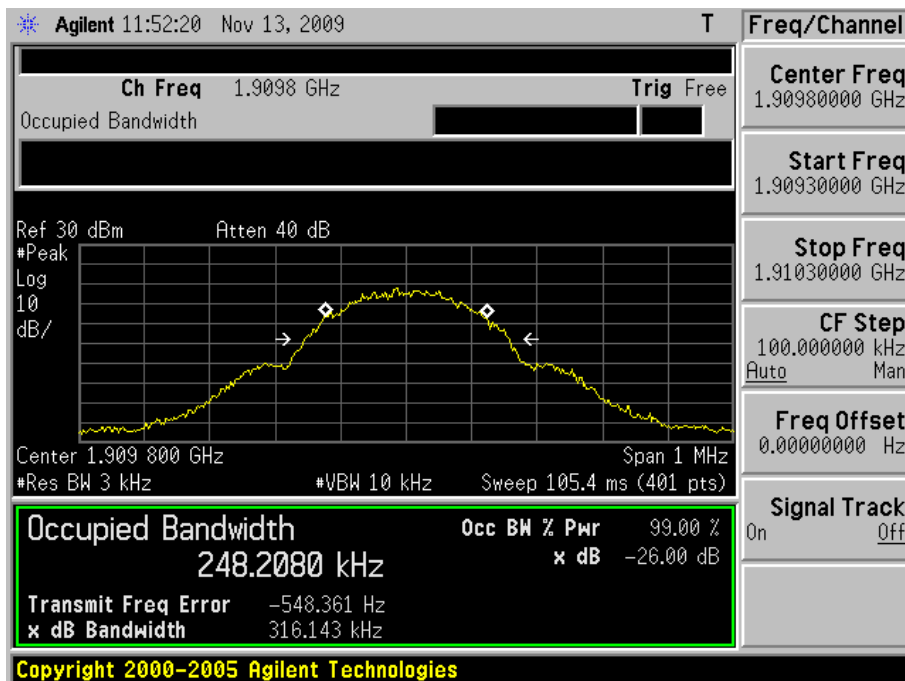

Figure Channel 810



Product	Portable Terminal		
Test Item	Occupied Bandwidth		
Test Mode	Mode 5: WCDMA Band II Link		
Date of Test	11/22/2009	Test Site	TE02

Channel No.	Frequency (MHz)	-26dB Bandwidth (kHz)	Note
9262	1852.4	4171.6	RBW:30KHz , VBW:300KHz
9400	1880.0	4176.3	RBW:30KHz , VBW:300KHz
9538	1907.6	4171.1	RBW:30KHz , VBW:300KHz

Figure Channel 9262

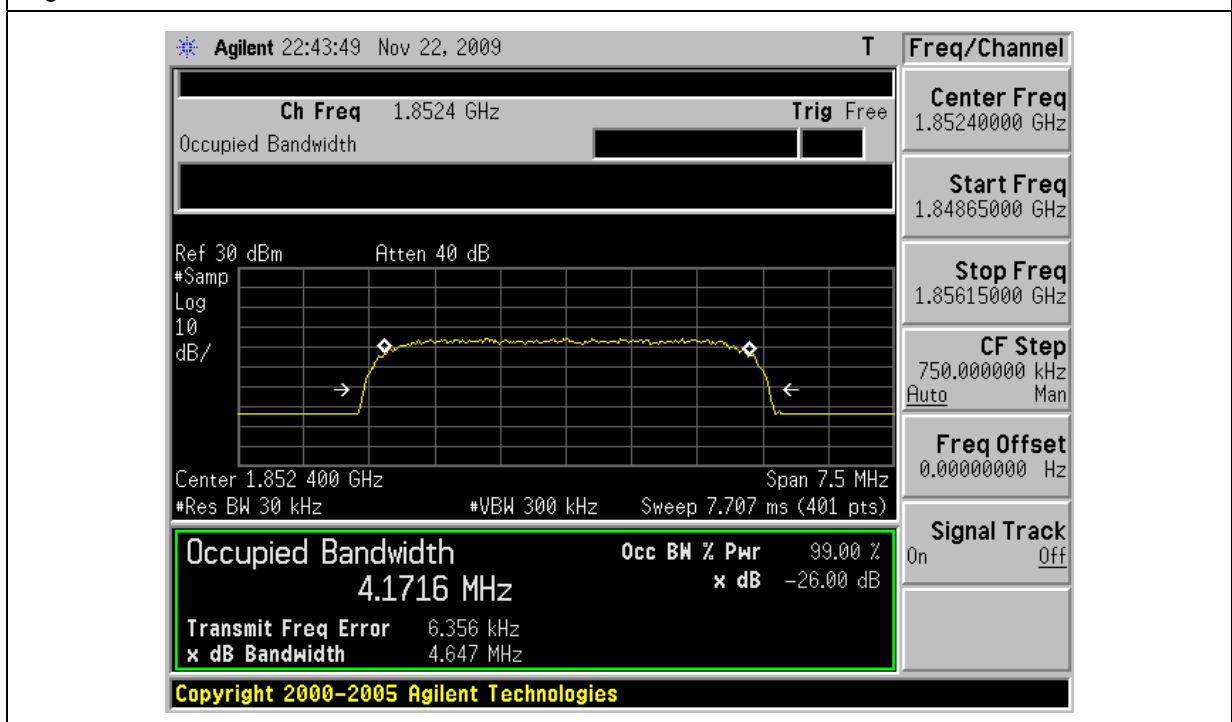

Figure Channel 9400

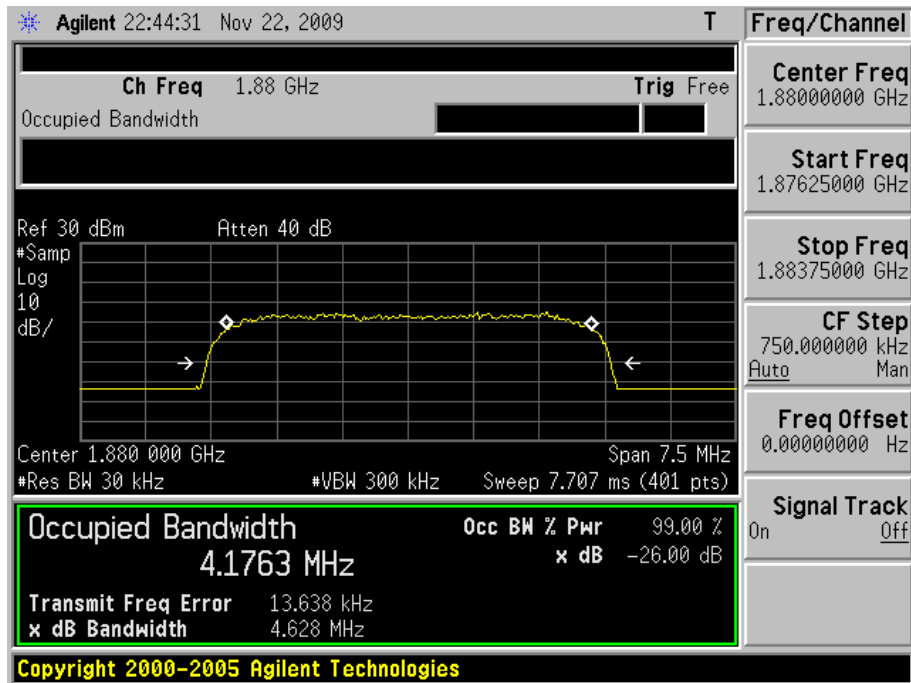
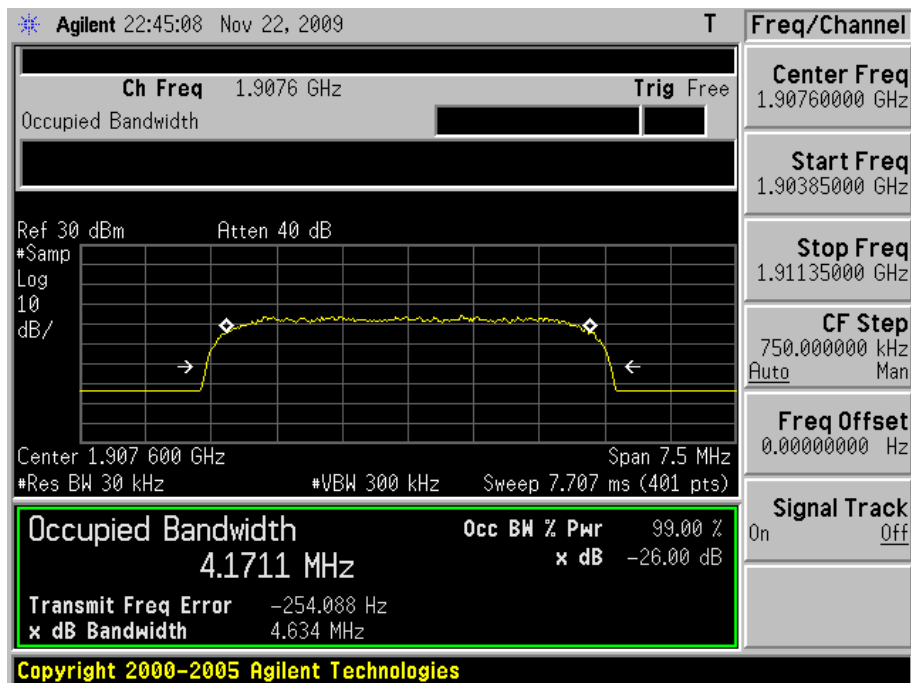

Figure Channel 9538



Product	Portable Terminal		
Test Item	Occupied Bandwidth		
Test Mode	Mode 6: WCDMA Band V Link		
Date of Test	11/22/2009	Test Site	TE02

Channel No.	Frequency (MHz)	-26dB Bandwidth (kHz)	Note
4132	826.4	4167.6	RBW:30KHz , VBW:300KHz
4182	836.4	4159.7	RBW:30KHz , VBW:300KHz
4233	846.4	4177.1	RBW:30KHz , VBW:300KHz

Figure Channel 4132

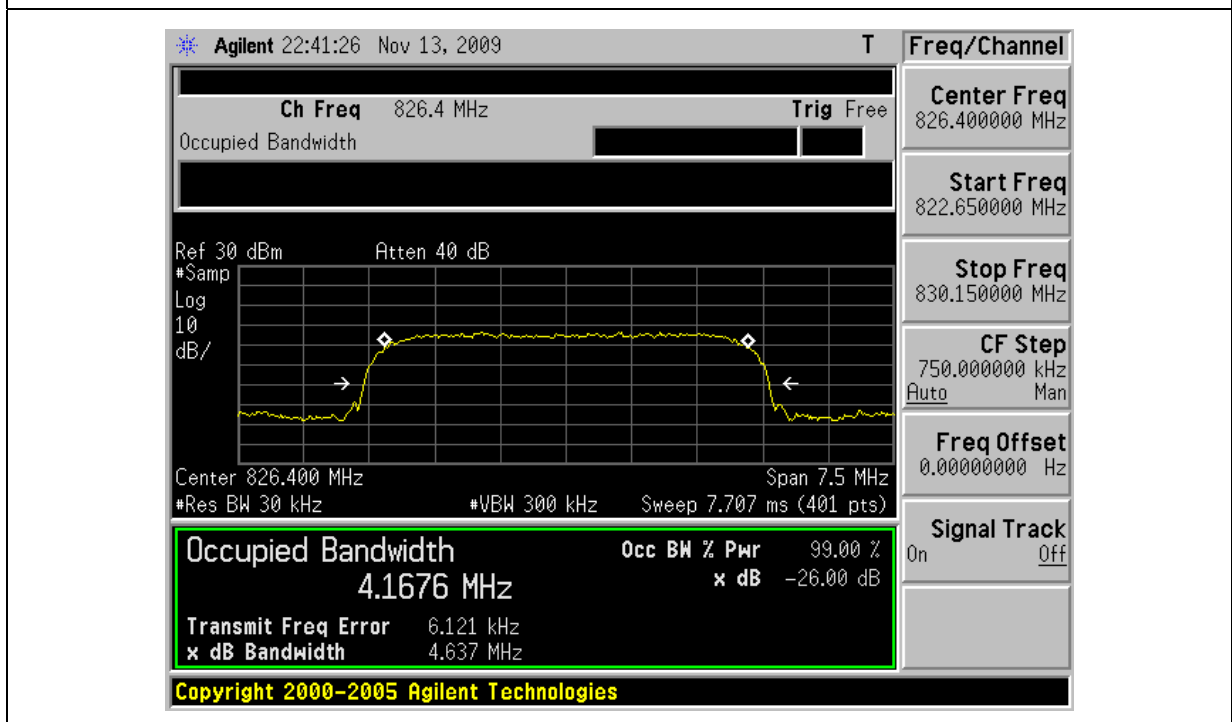

Figure Channel 4182

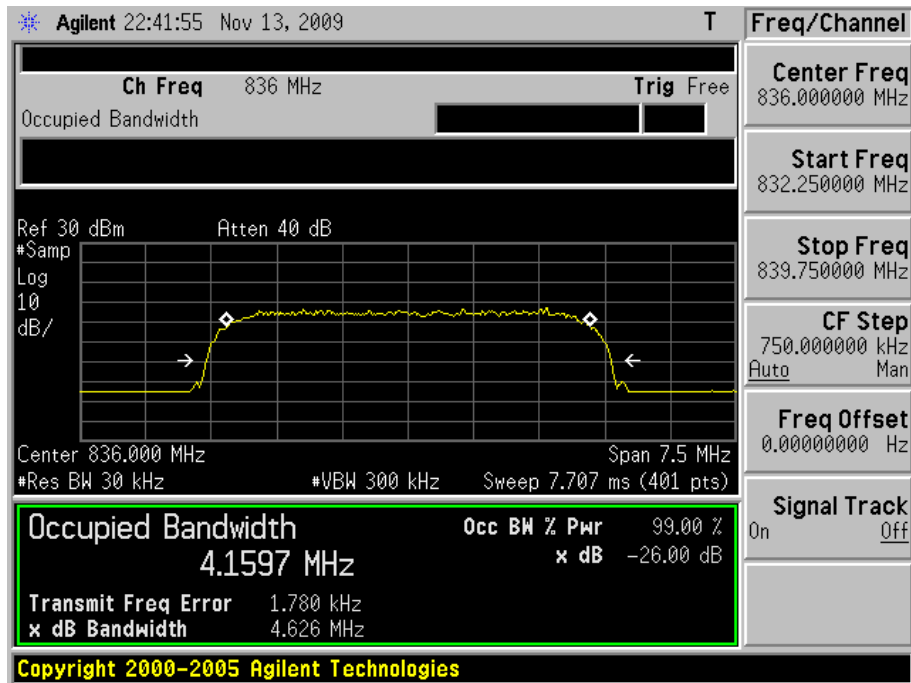
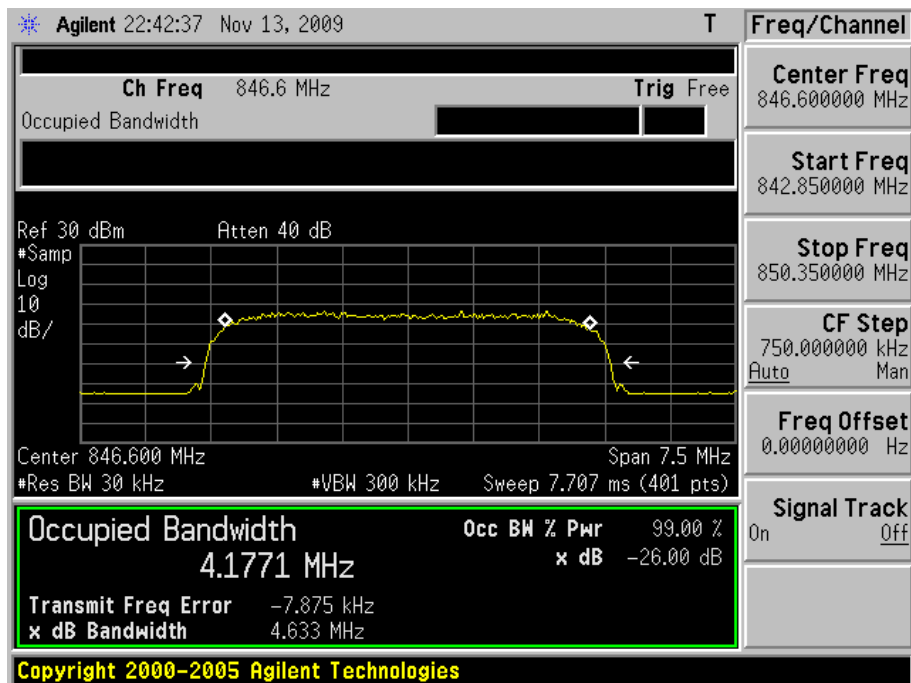

Figure Channel 4233



Band Edge

Product	Portable Terminal		
Test Item	Band Edge		
Test Mode	Mode 1: GPRS850 Link		
Date of Test	11/23/2009	Test Site	TE02

Band	Channel	Frequency (MHz)	Bandwidth (dBm)	Limit (dBm)	Result
Lower	128	824.0000	-19.14	-13	Pass
Higher	251	849.0000	-19.64	-13	Pass

Lower Band

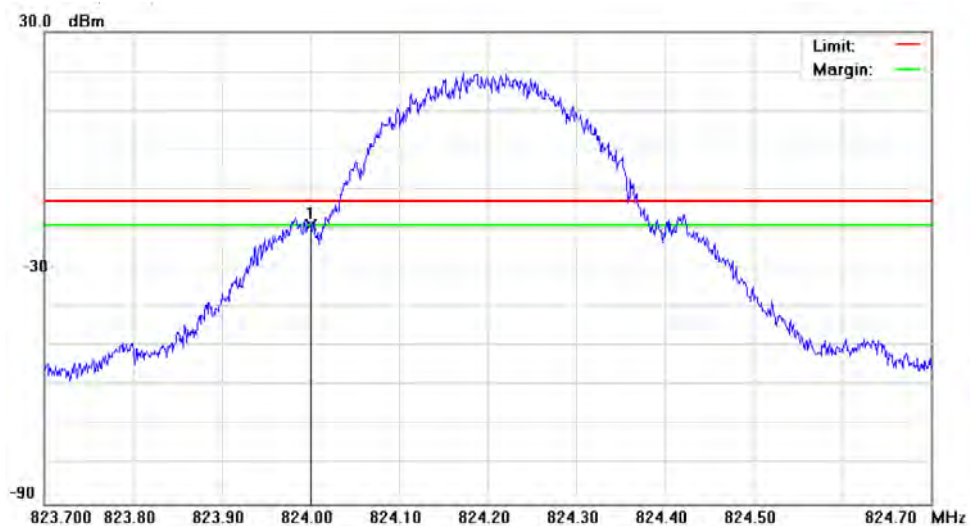

Higher Band

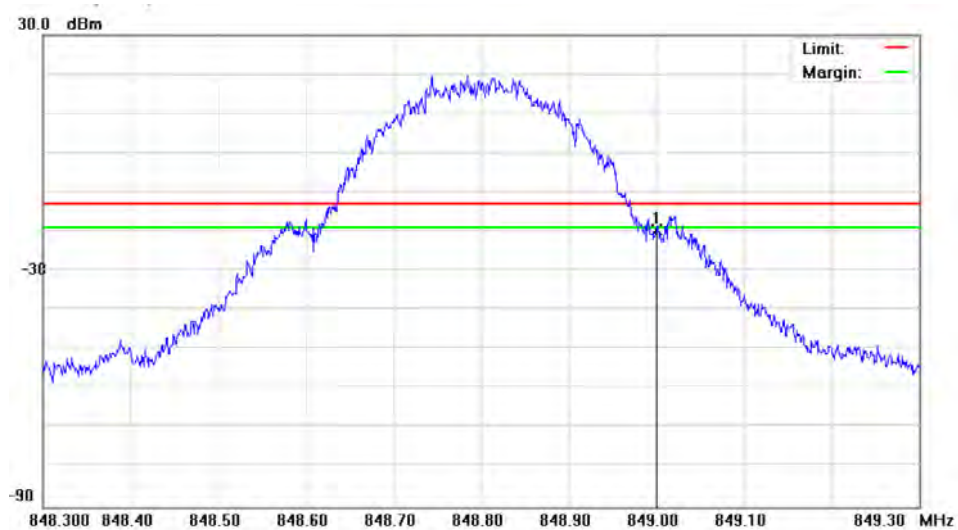

Product	Portable Terminal		
Test Item	Band Edge		
Test Mode	Mode 2: GPRS1900 Link		
Date of Test	11/23/2009	Test Site	TE02

Band	Channel	Frequency (MHz)	Bandwidth (dBm)	Limit (dBm)	Result
Lower	512	1850.000	-29.10	-13	Pass
Higher	810	1910.000	-24.17	-13	Pass

Lower Band

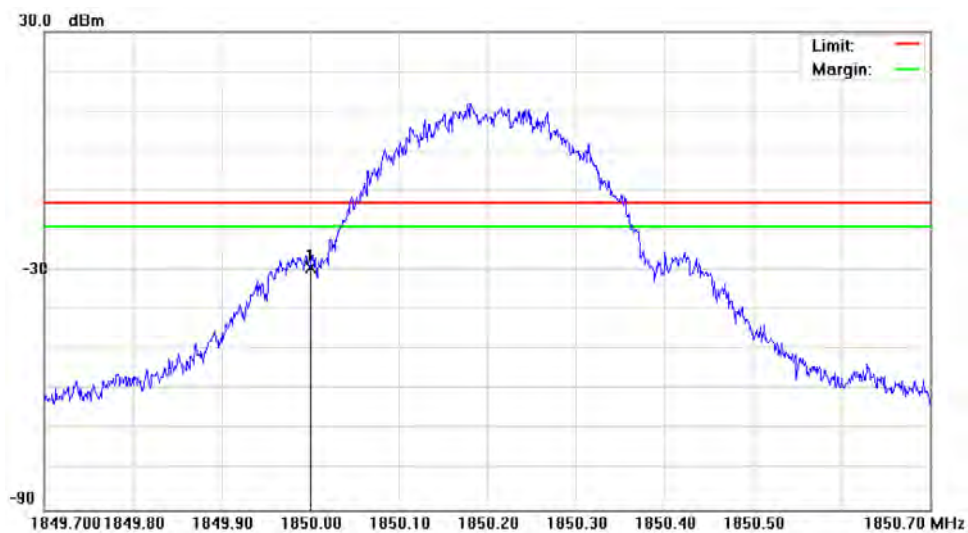

Higher Band

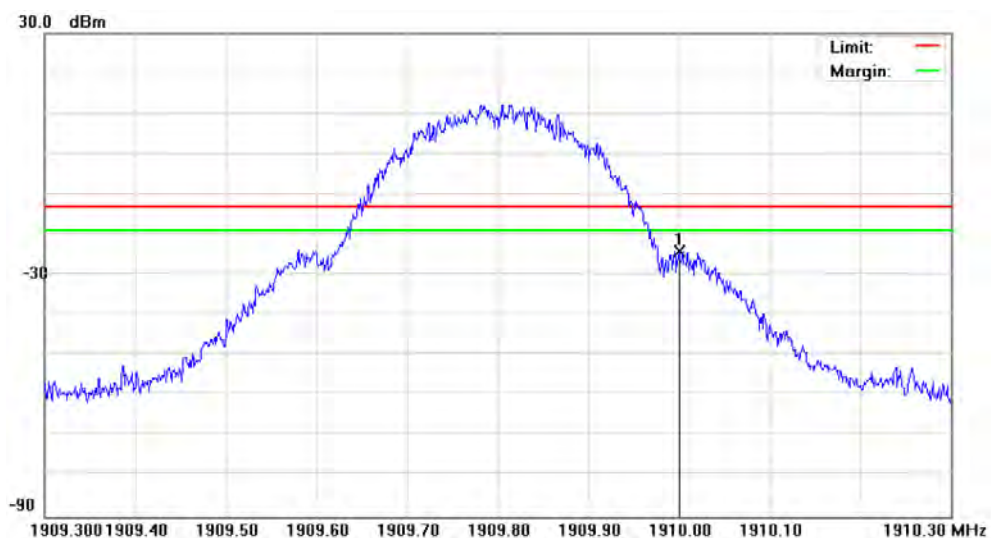

Product	Portable Terminal		
Test Item	Band Edge		
Test Mode	Mode 5: WCDMA Band II Link		
Date of Test	11/23/2009	Test Site	TE02

Band	Channel	Frequency (MHz)	Bandwidth (dBm)	Limit (dBm)	Result
Lower	9262	1850.000	-45.37	-13	Pass
Higher	9538	1910.000	-43.97	-13	Pass

Lower Band

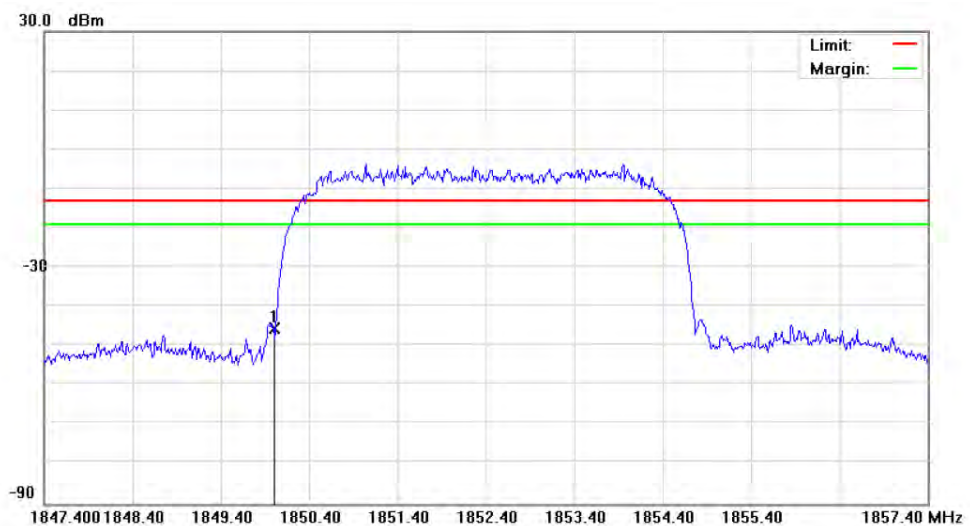

Higher Band

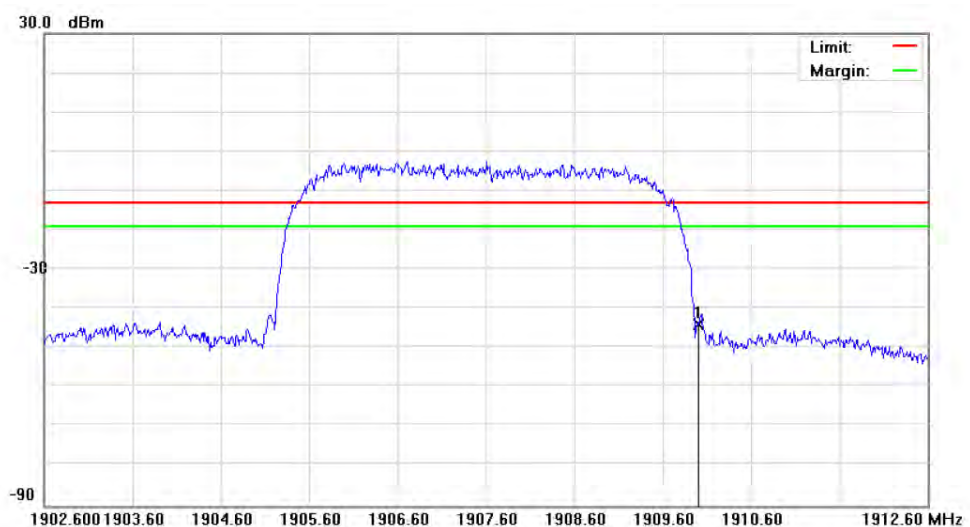

Product	Portable Terminal		
Test Item	Band Edge		
Test Mode	Mode 6: WCDMA Band V Link		
Date of Test	11/23/2009	Test Site	TE02

Band	Channel	Frequency (MHz)	Bandwidth (dBm)	Limit (dBm)	Result
Lower	4132	824.0000	-37.72	-13	Pass
Higher	4233	849.0000	-38.92	-13	Pass

Lower Band

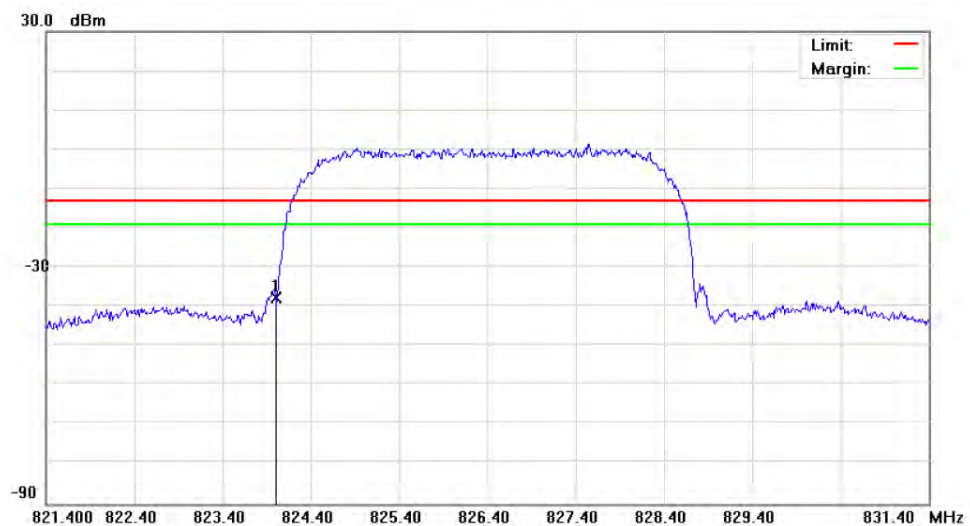

Higher Band

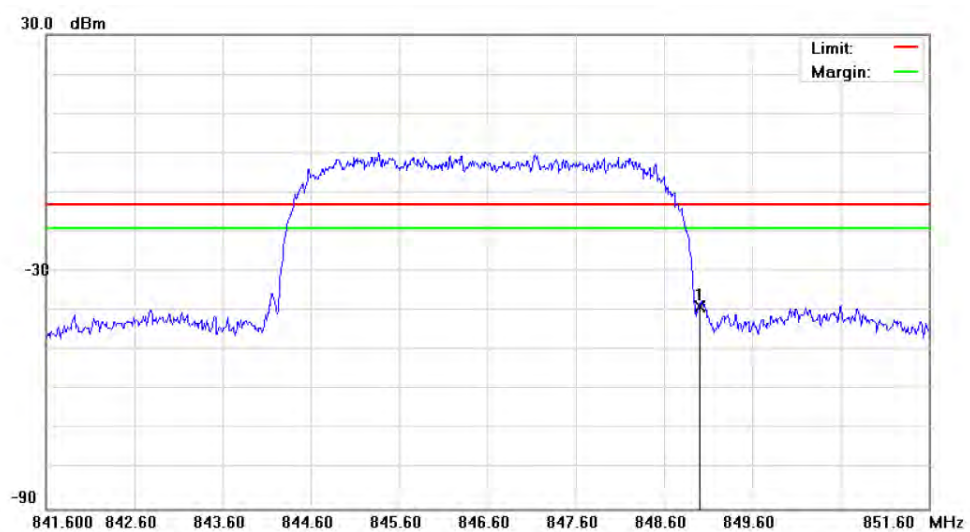

5 Conducted Emission Test

5.1. Limit

The power of any emission outside of the authorized operating frequency ranges must be attenuated below the transmitting power (P) by a factor of at least $43 + 10\log(P)$ dB.

5.2. Test Instruments

Describe	Manufacturer	Model No.	Serial No.	Cal. Date
Spectrum Analyzer	Agilent	E4445A	MY46181986	05/14/2009
Universal Radio Communication Tester	ROHDE & SCHWARZ	CMU200	109369	07/29/2009
Attenuator	RADIALL	R41572000	0603033073	N.C.R.
Power divider	Agilent	87302C	3239A00760	N.C.R.
Test Site	ATL	TE02	TE02	N.C.R.

5.3. Setup

Below 2.8GHz

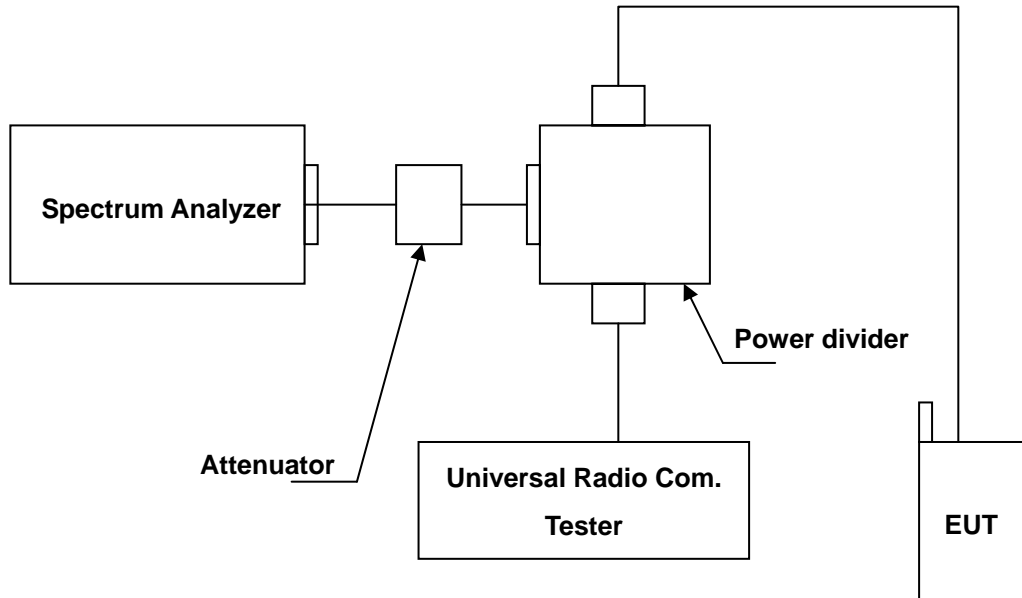

Above 2.8GHz

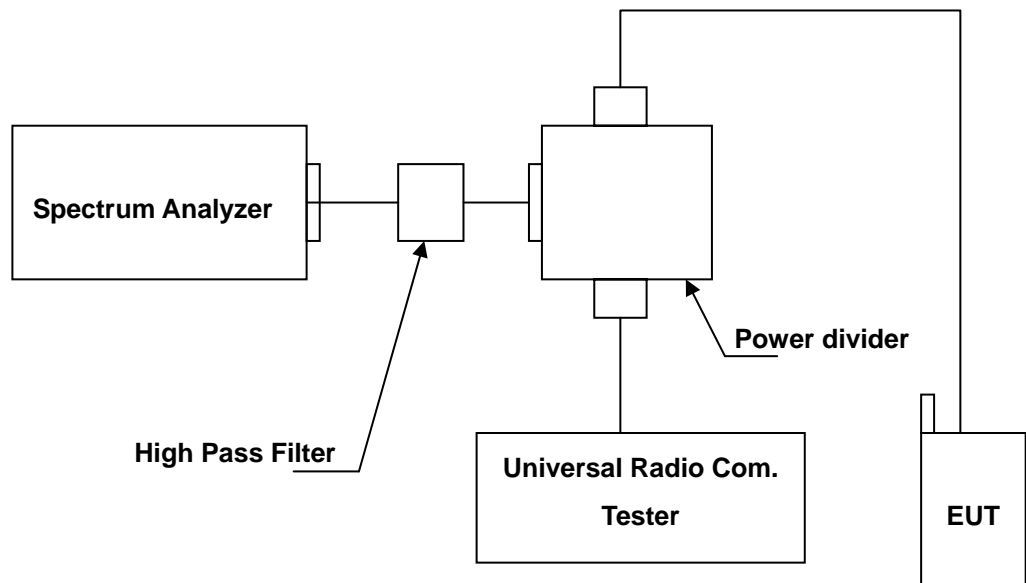

5.4. Test Procedure

1. The EUT was connected to Spectrum Analyzer and Base Station via power divider.
2. The middle channel for the highest RF power within the transmitting frequency was measured.
3. The conducted spurious emission for the whole frequency range was taken.
4. Test setting at GPRS/EGPRS 850 RB>100 kHz, VB>100 kHz; GPRS/EGPRS 1900 RB>1MHz, VB>1MHz.

5.5. Uncertainty

The measurement uncertainty is evaluated as ± 2.24 dB.

5.6. Test Result

Product	Portable Terminal		
Test Item	Conducted Emission		
Mode	Mode 1: GPRS850 Link Mode 2: GPRS1900 Link Mode 5: WCDMA Band II Link Mode 6: WCDMA Band V Link		
Date of Test	11/23 ~ 11/24/2009	Test Site	TE02

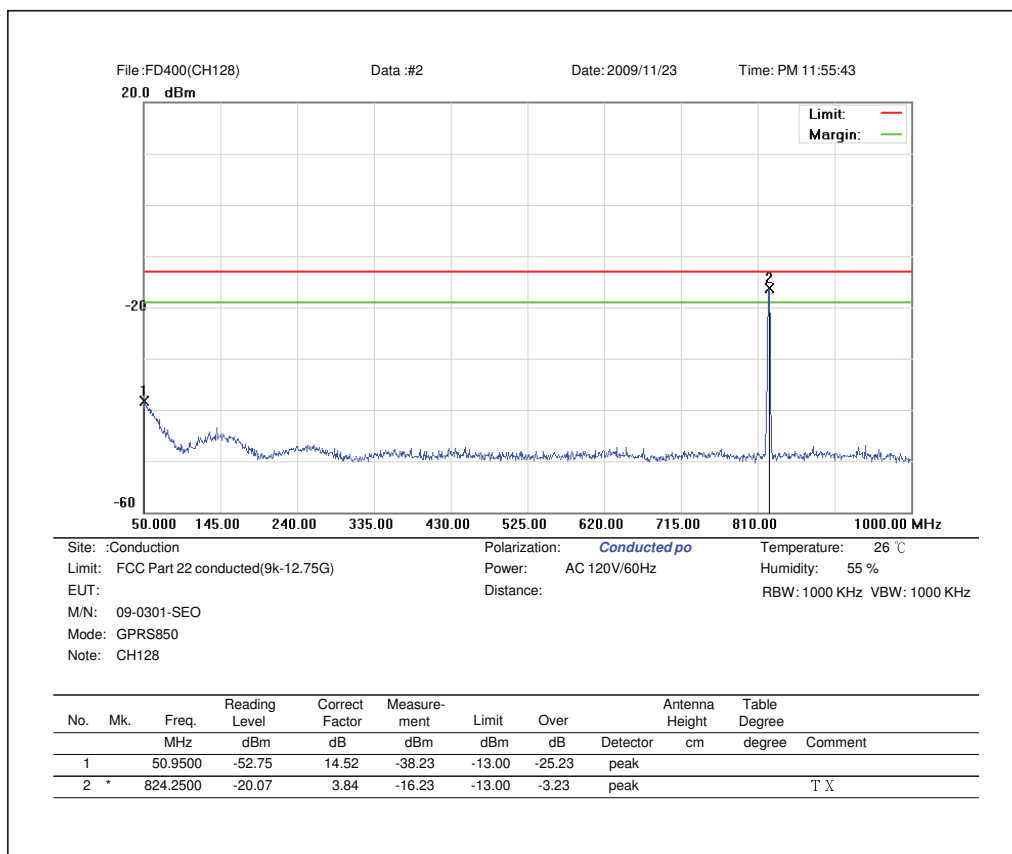
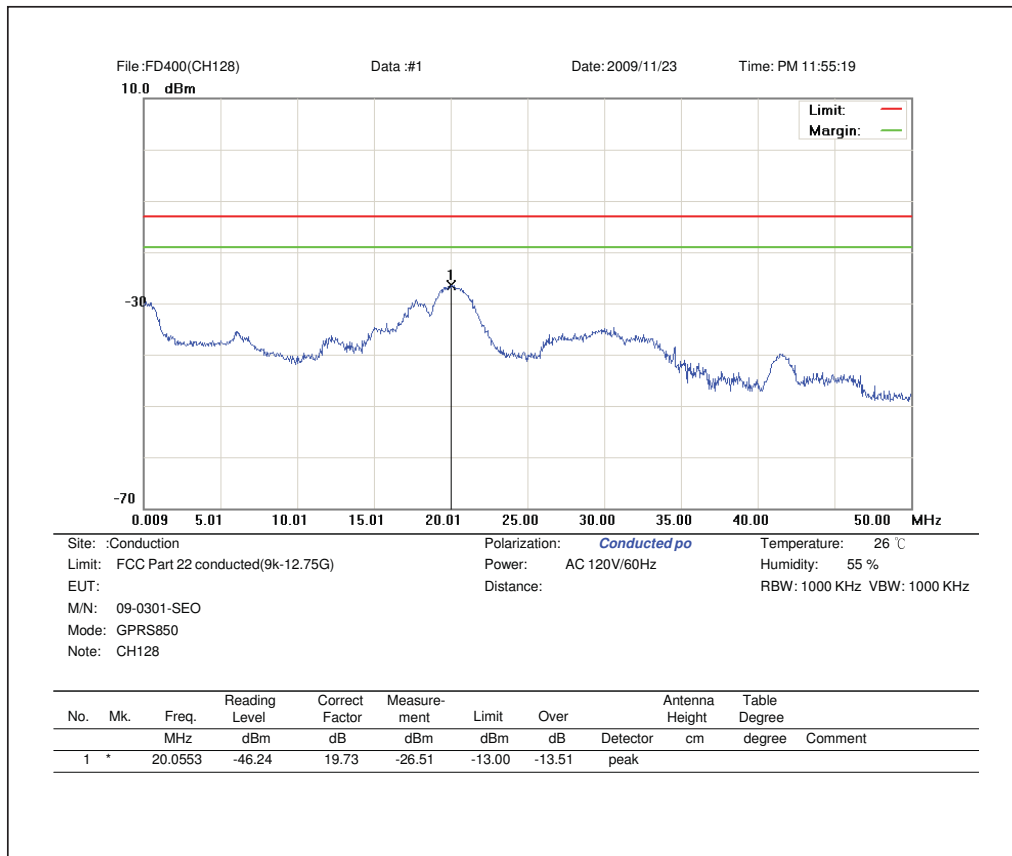

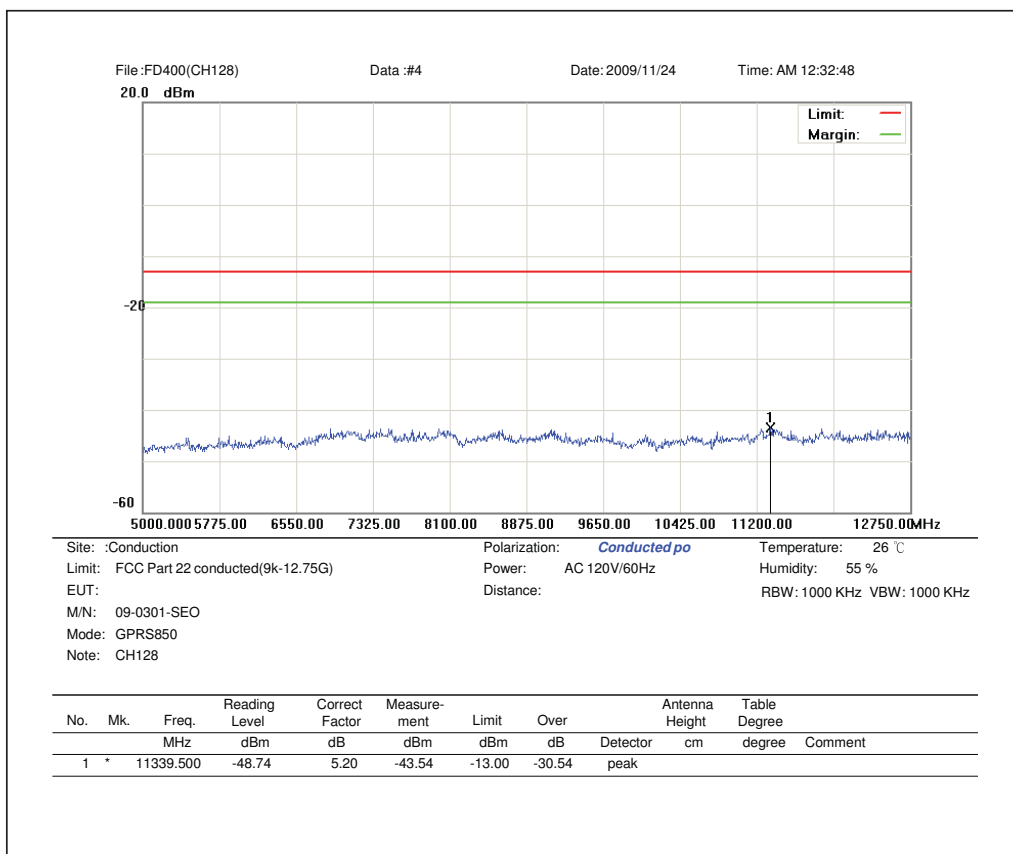
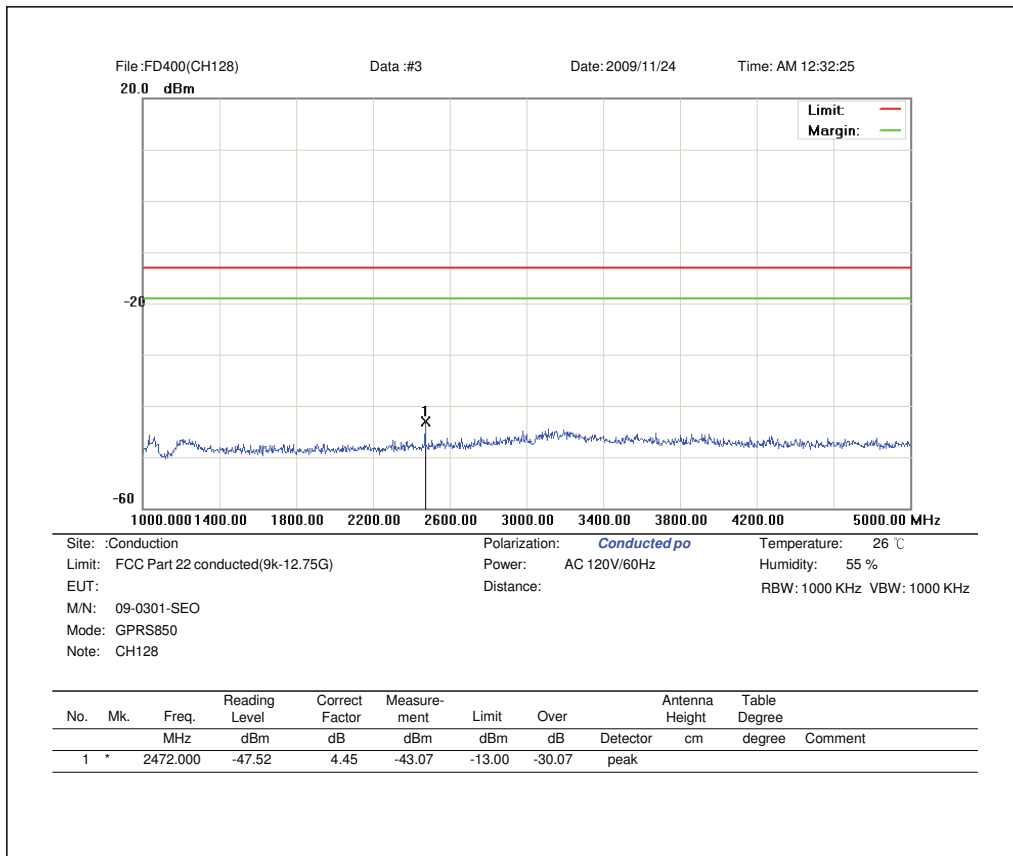

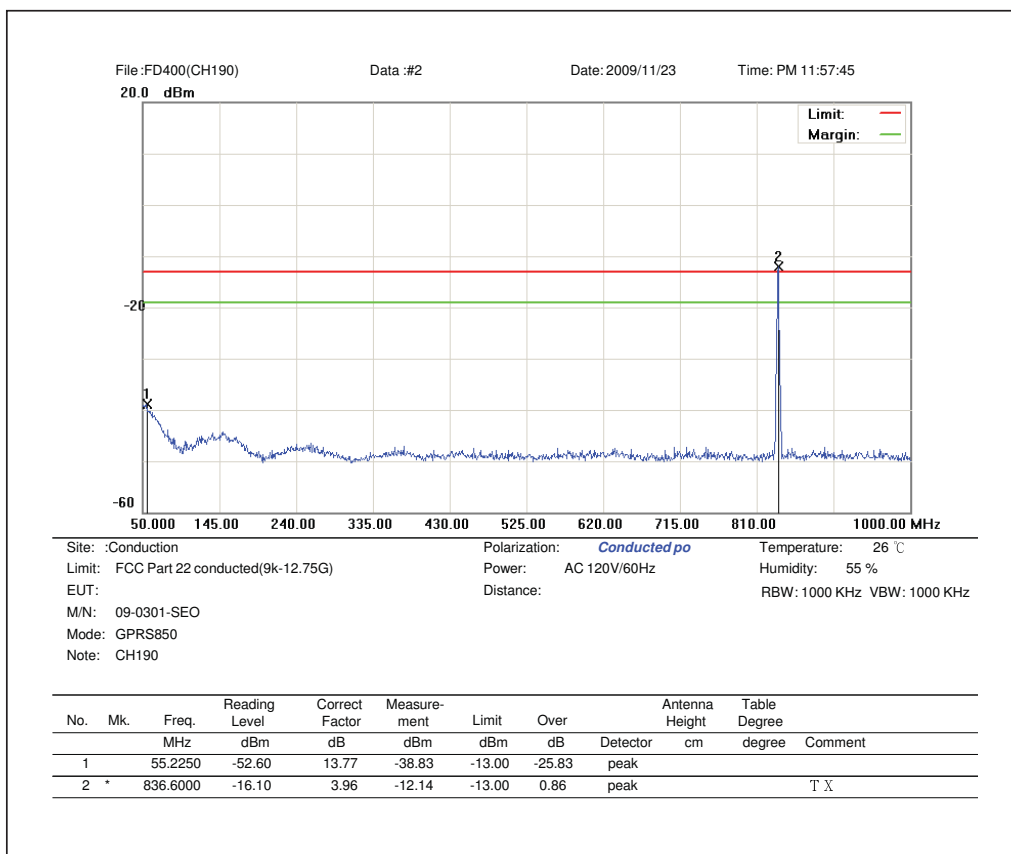
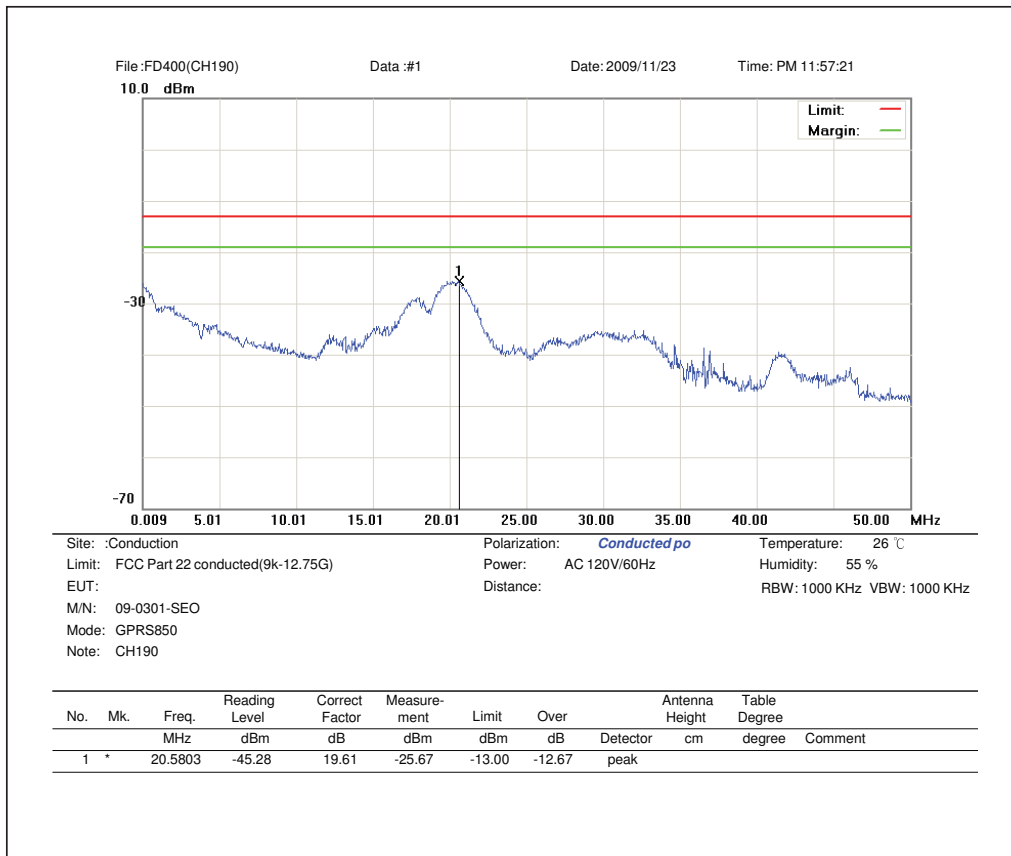

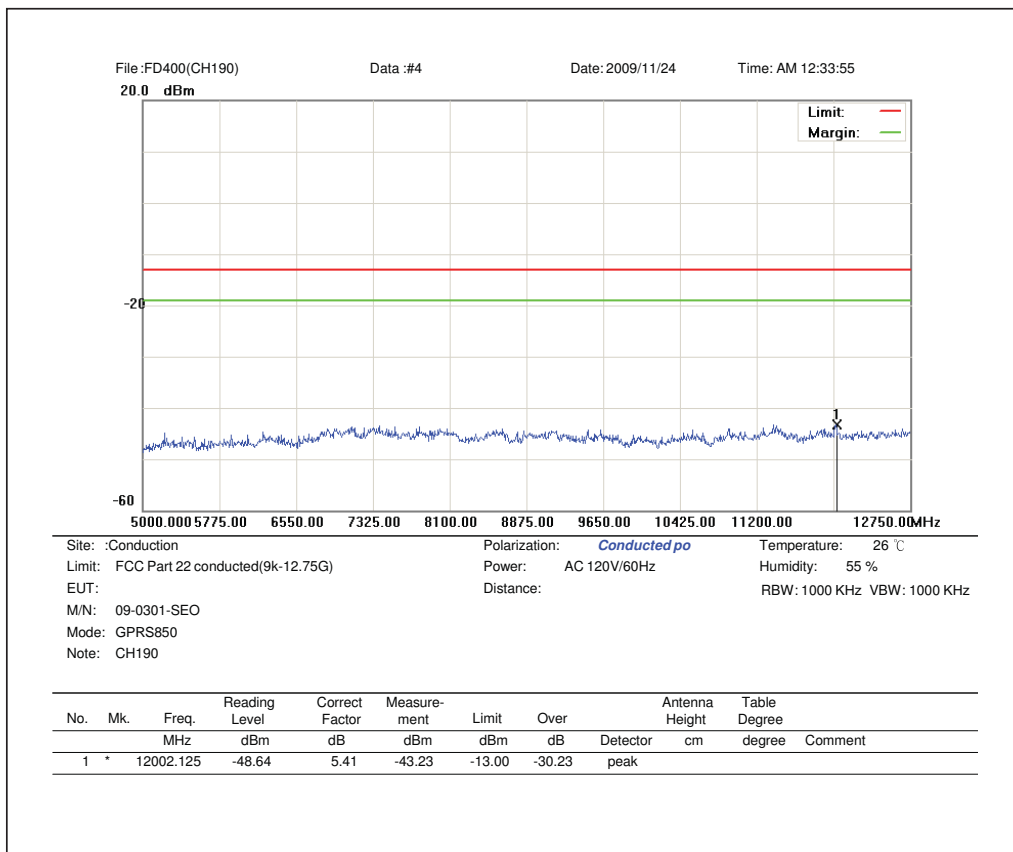
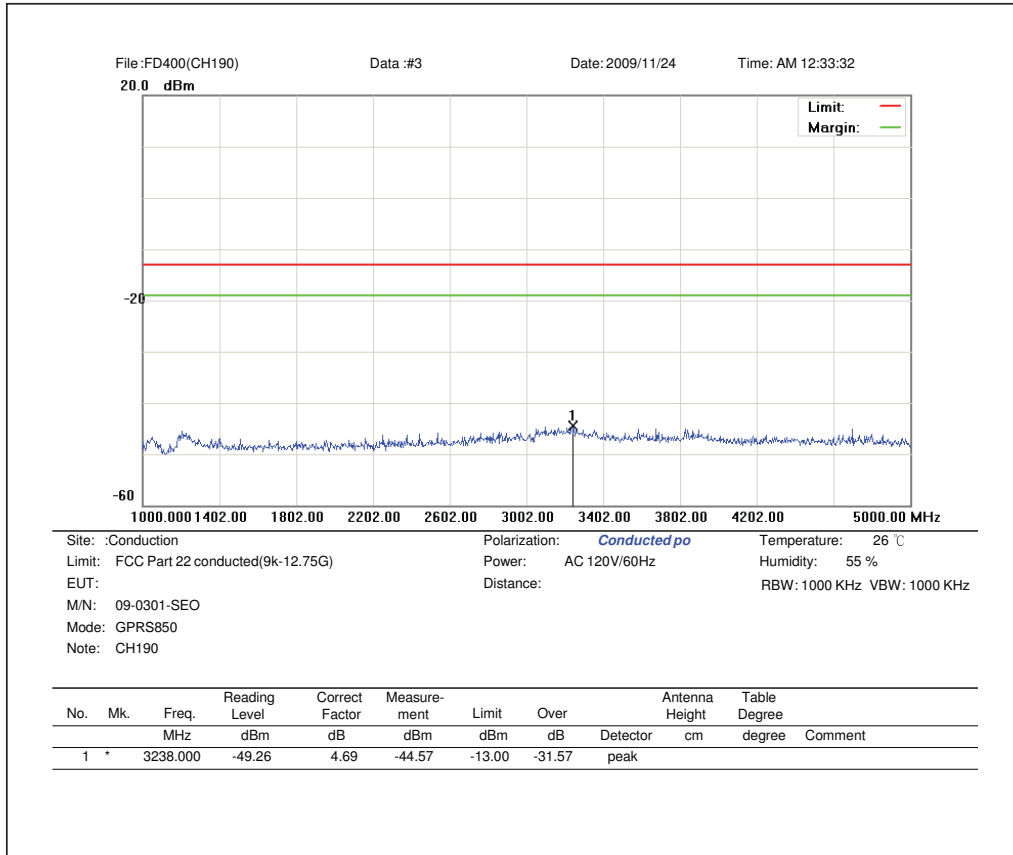

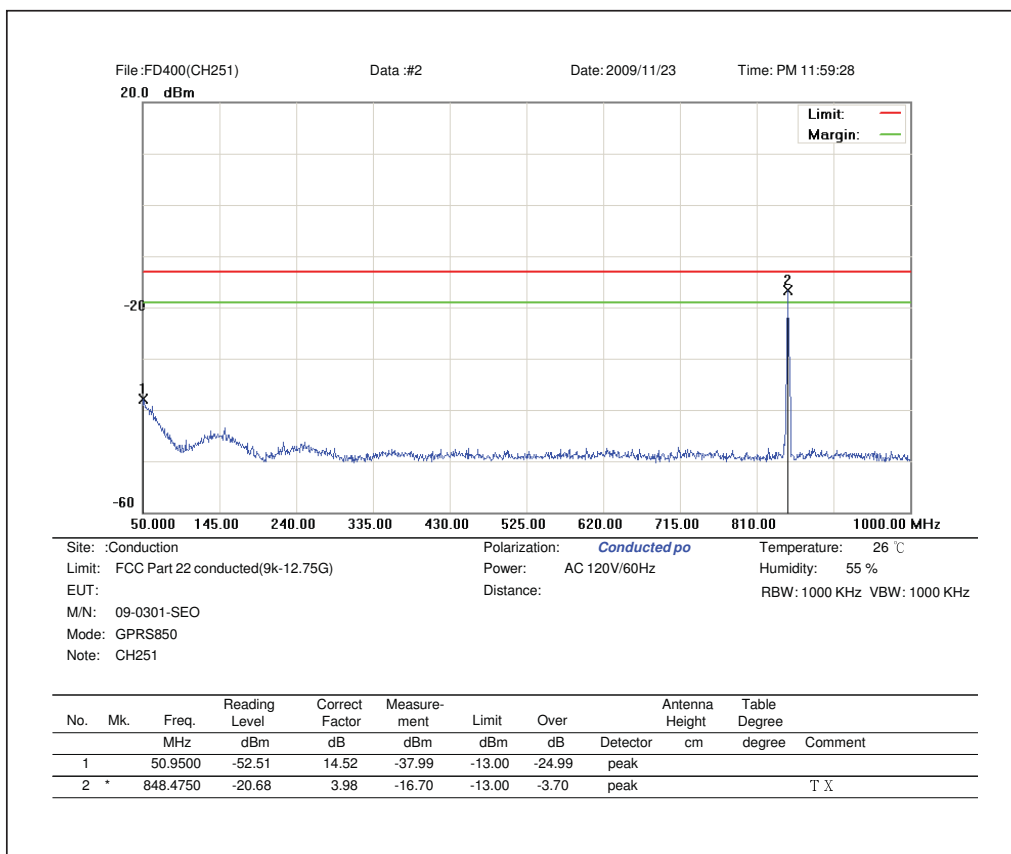
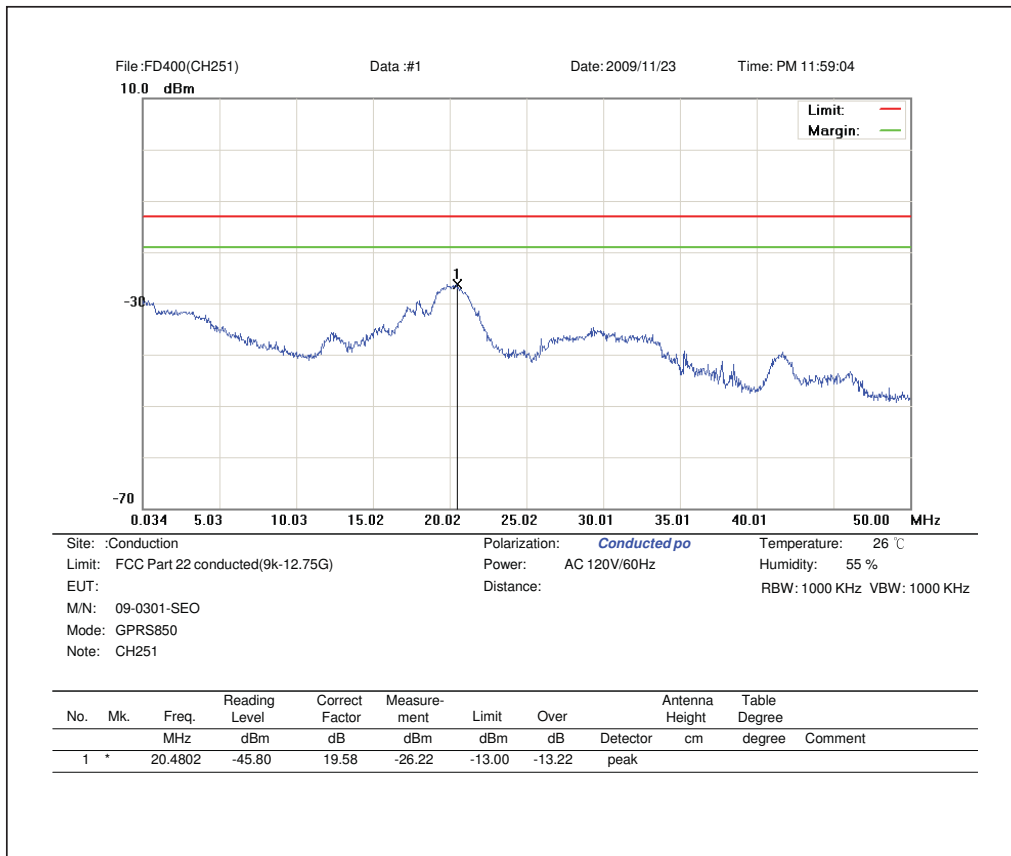

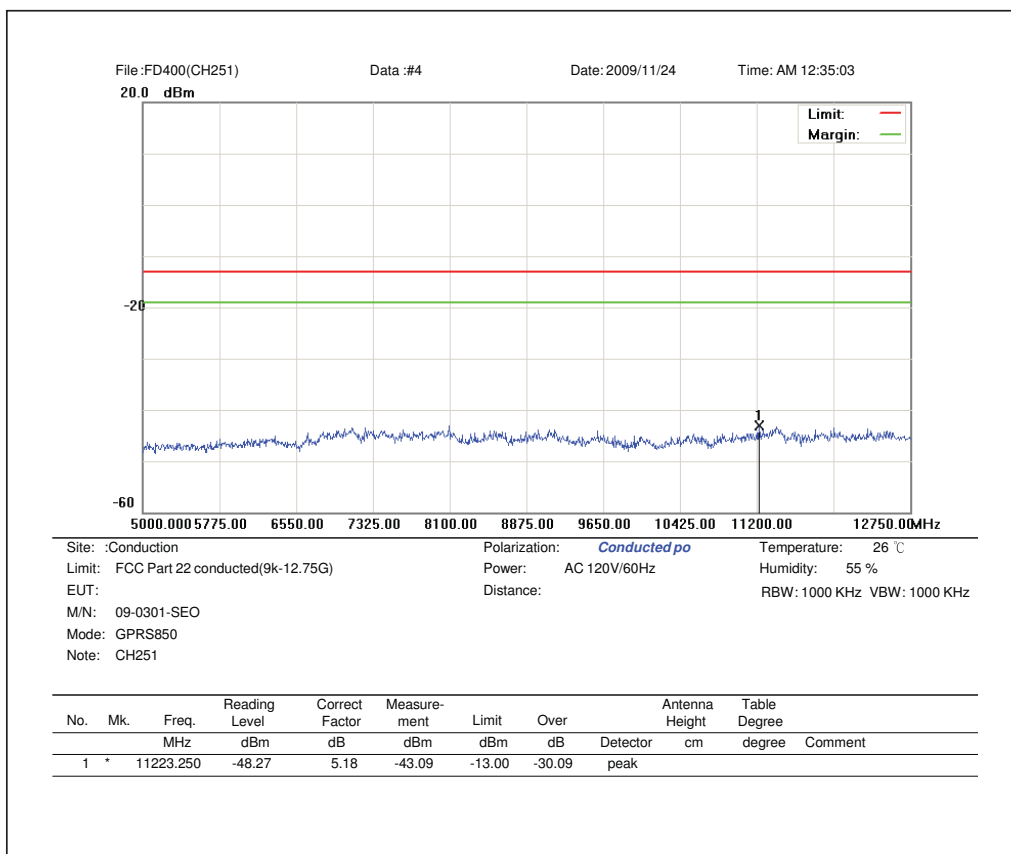
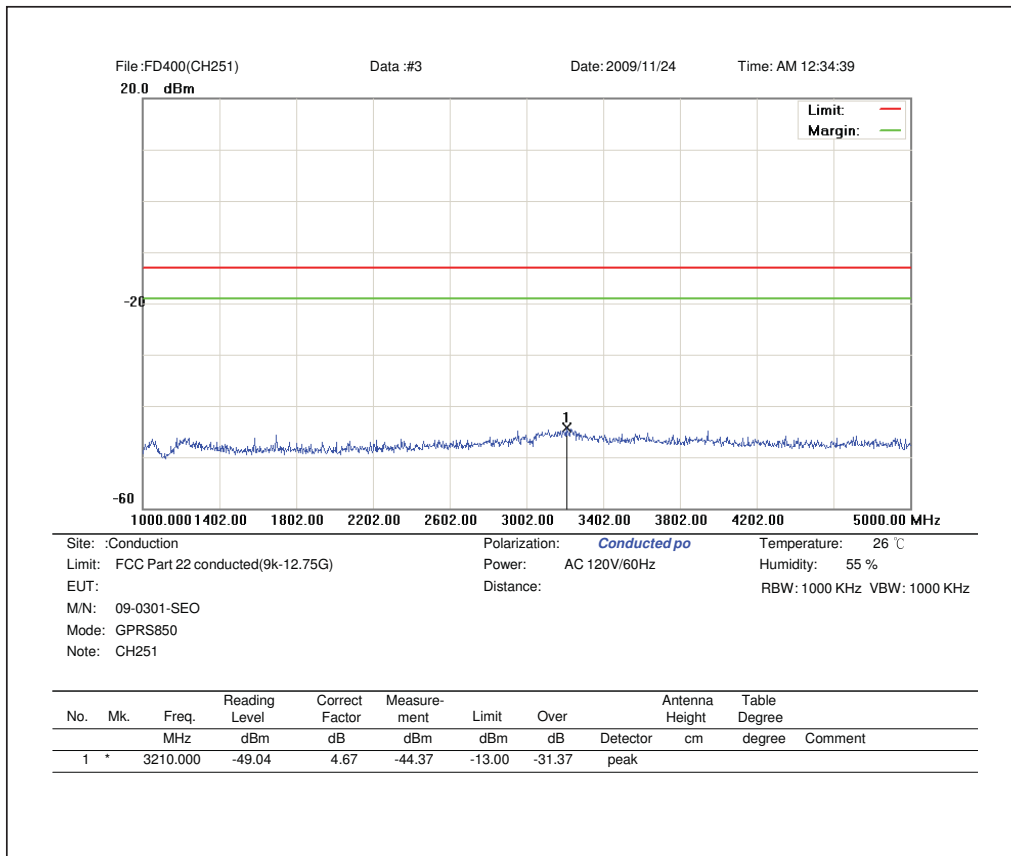

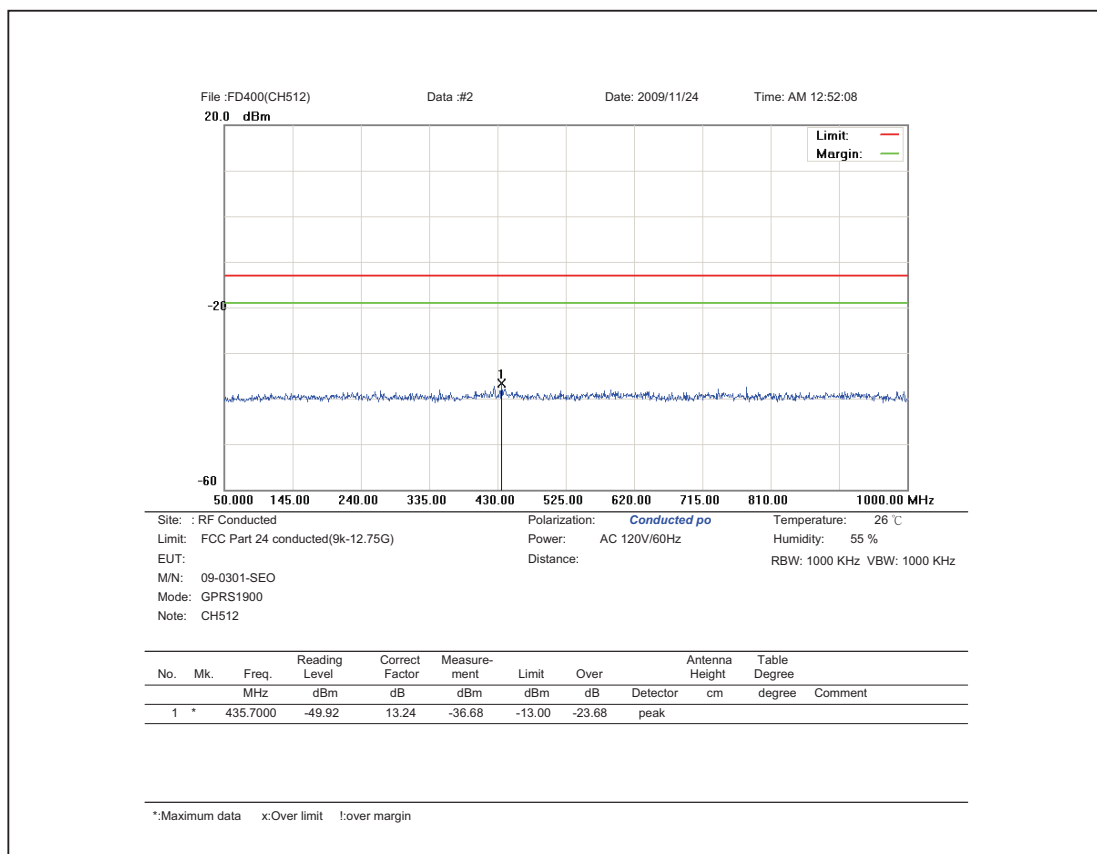
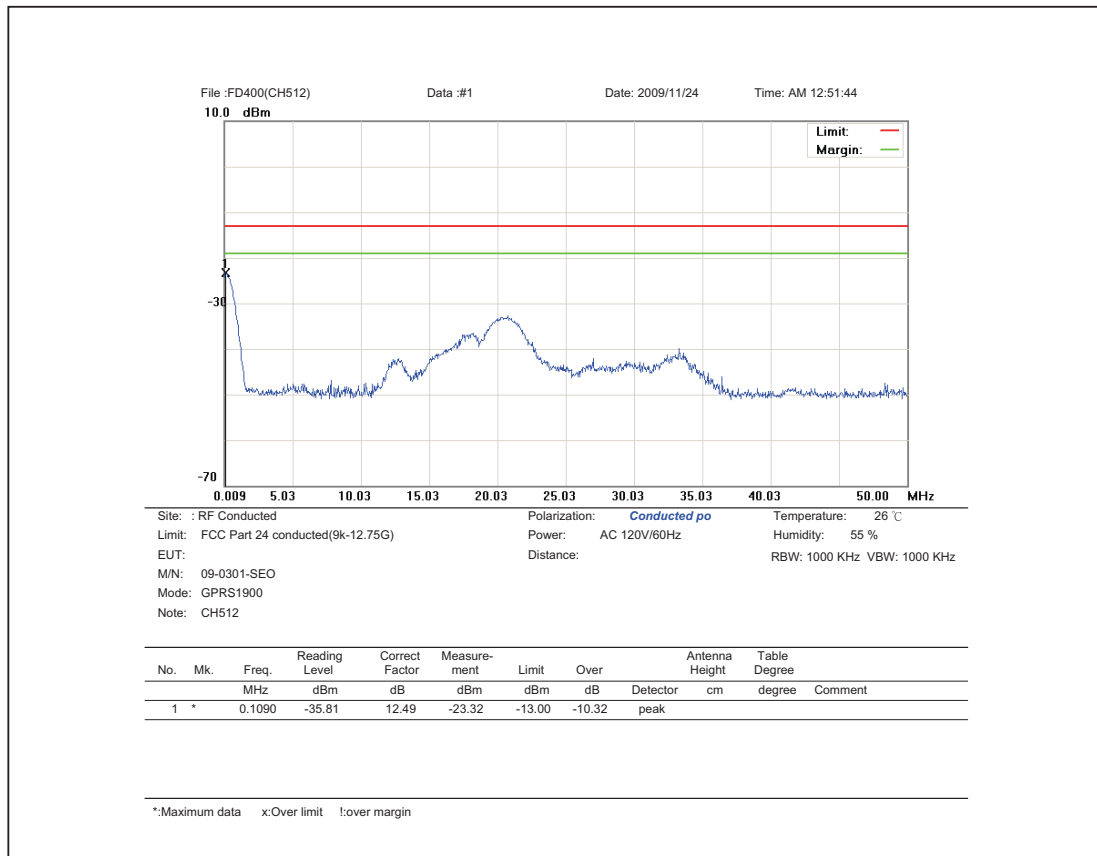

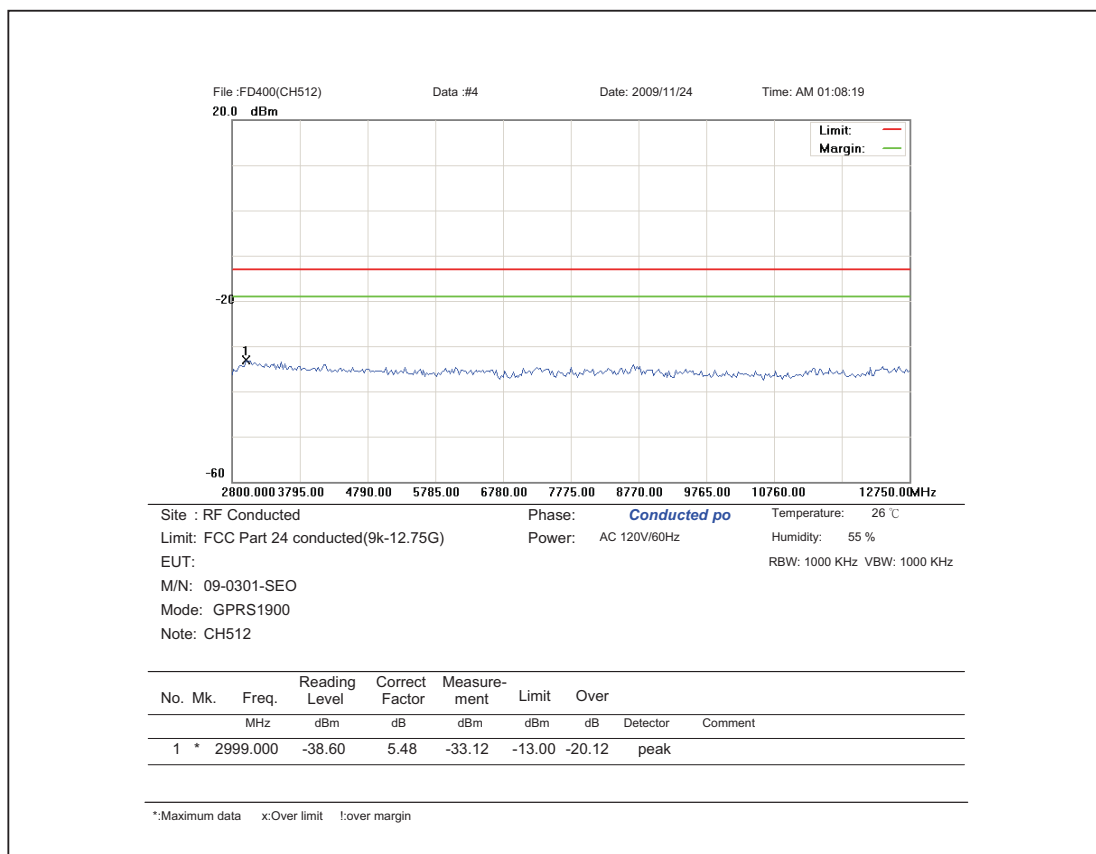
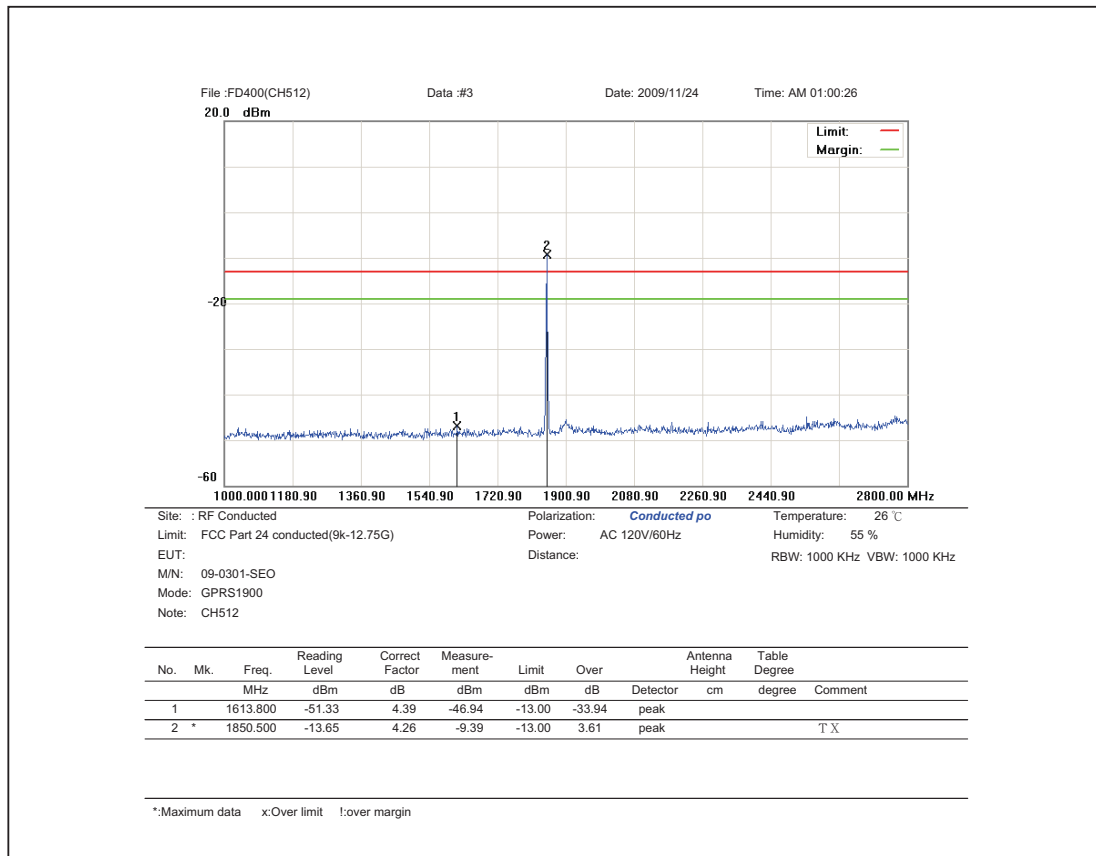

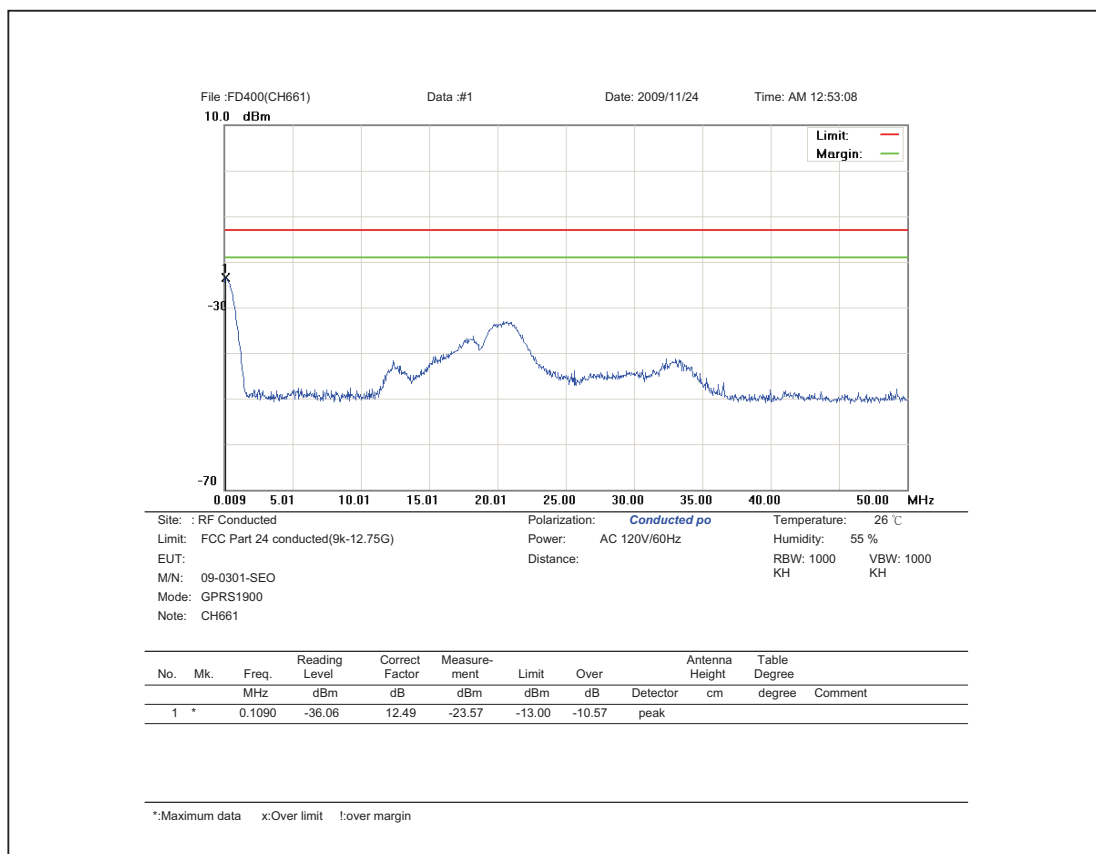

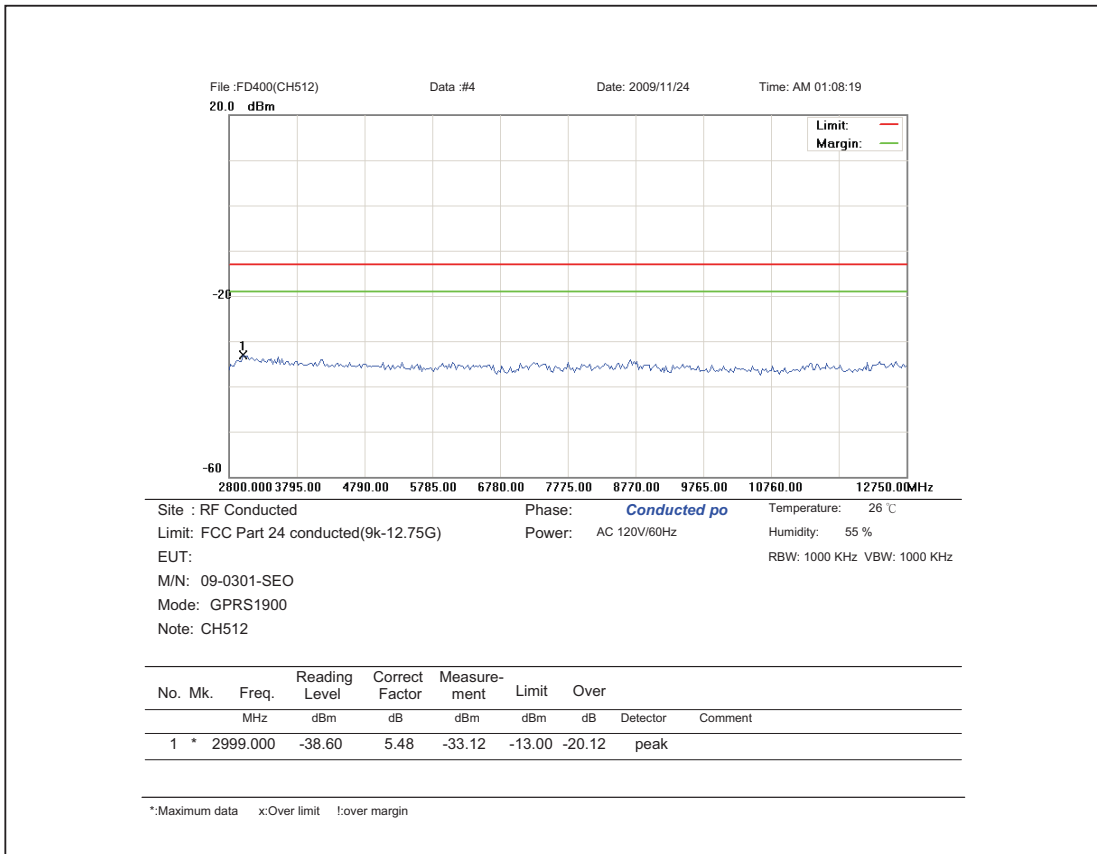
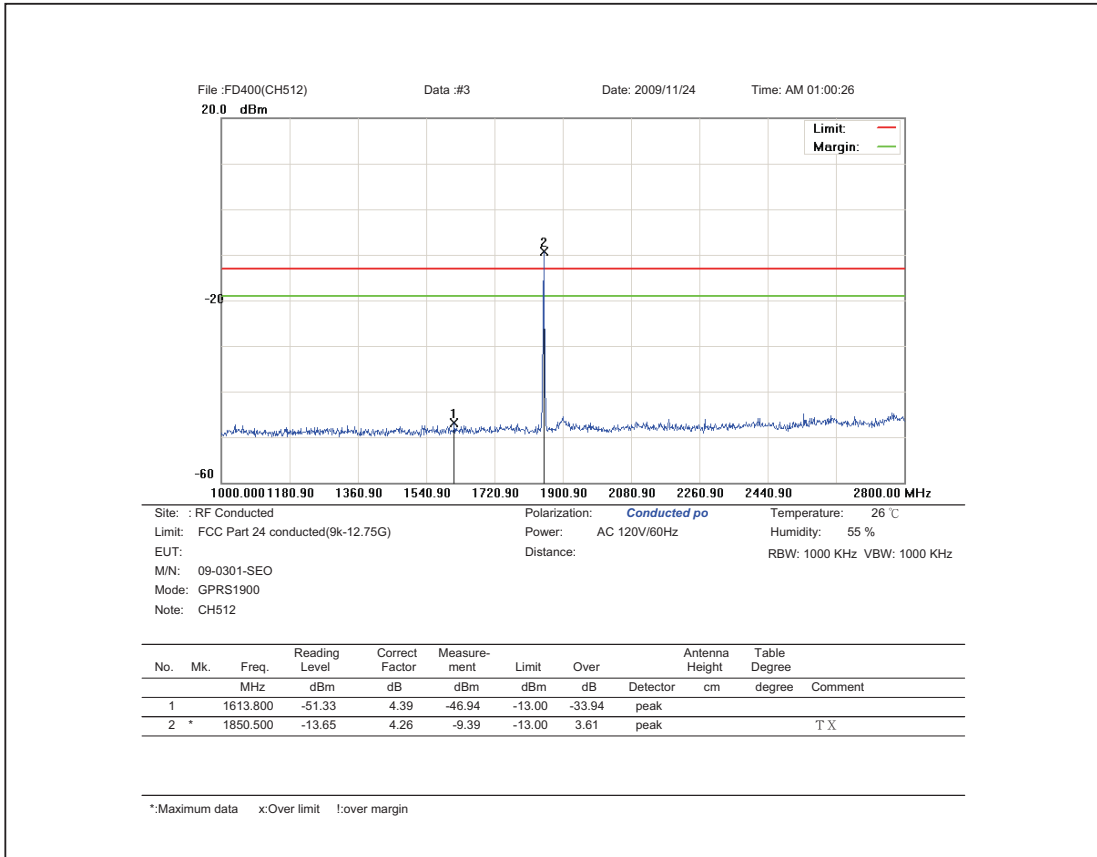

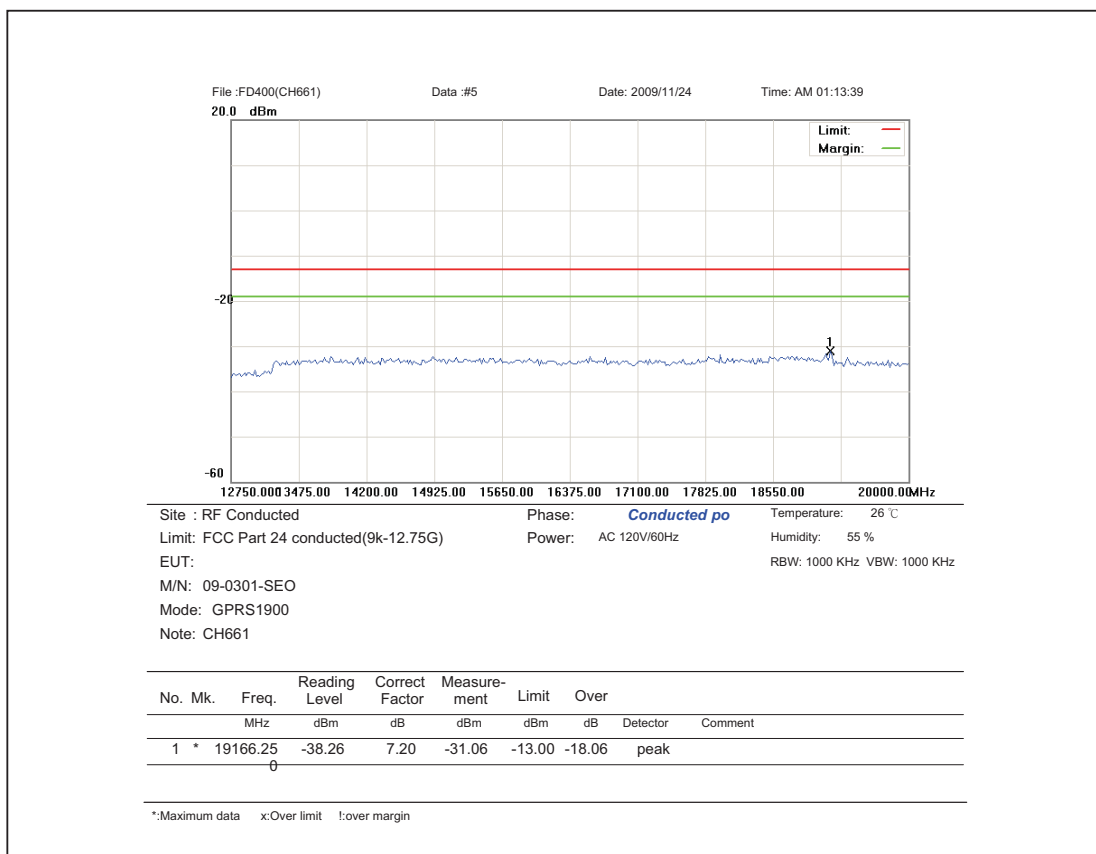
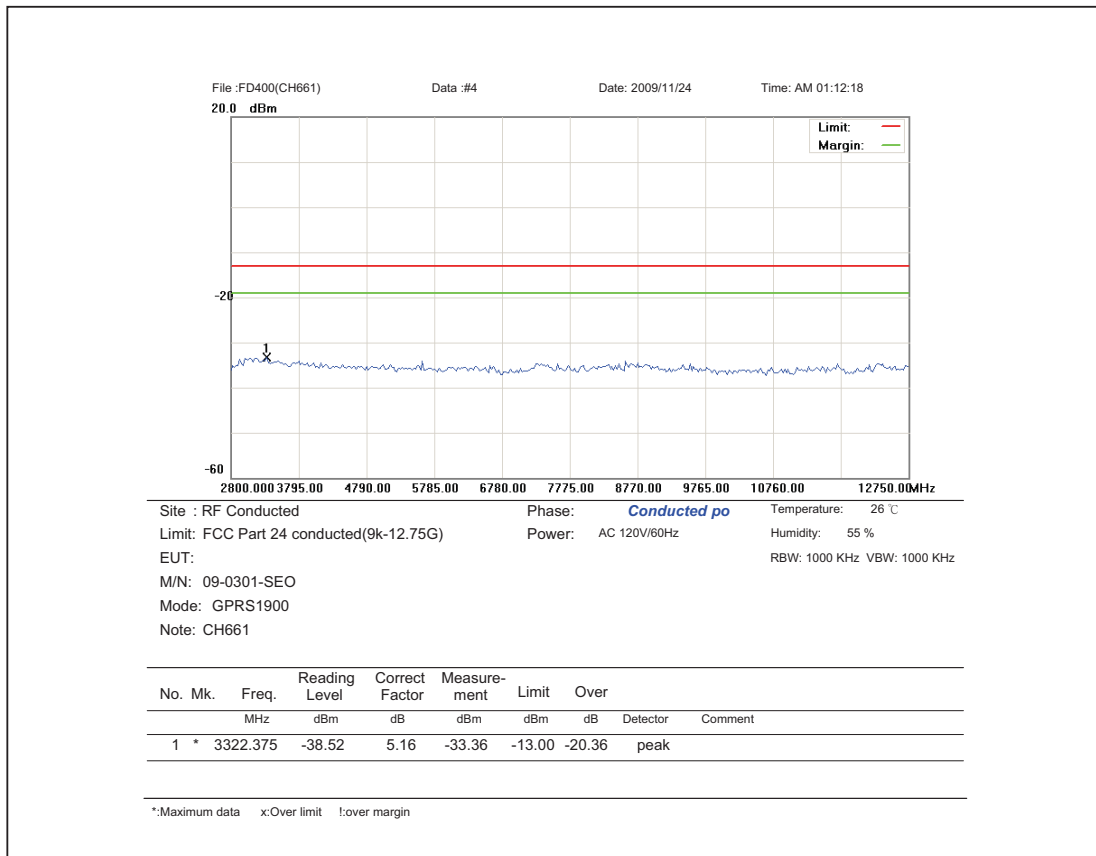

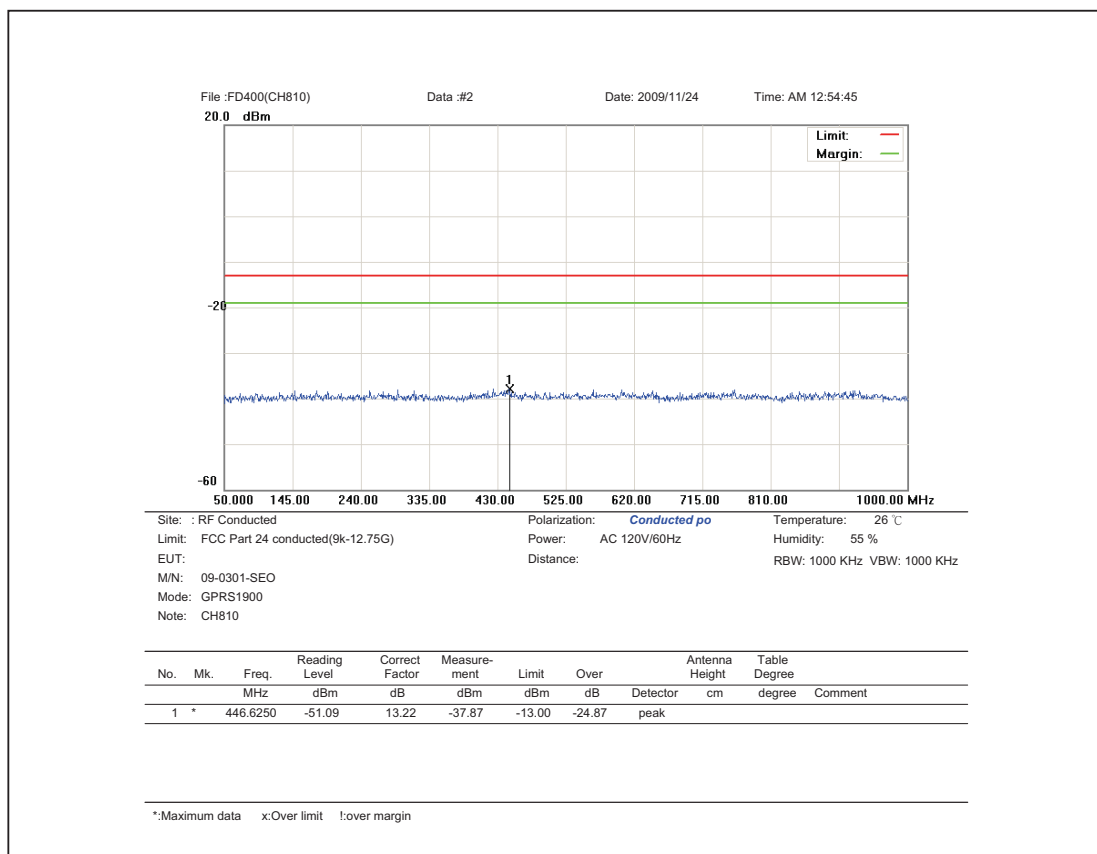
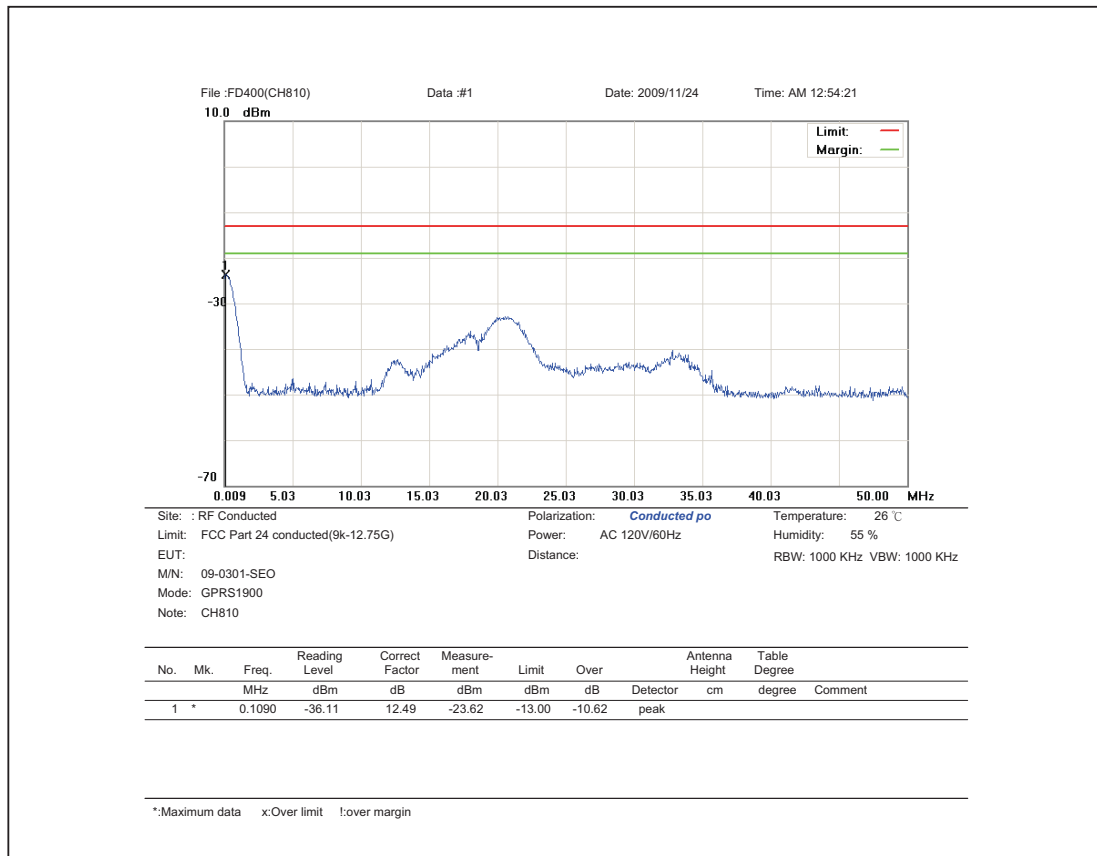

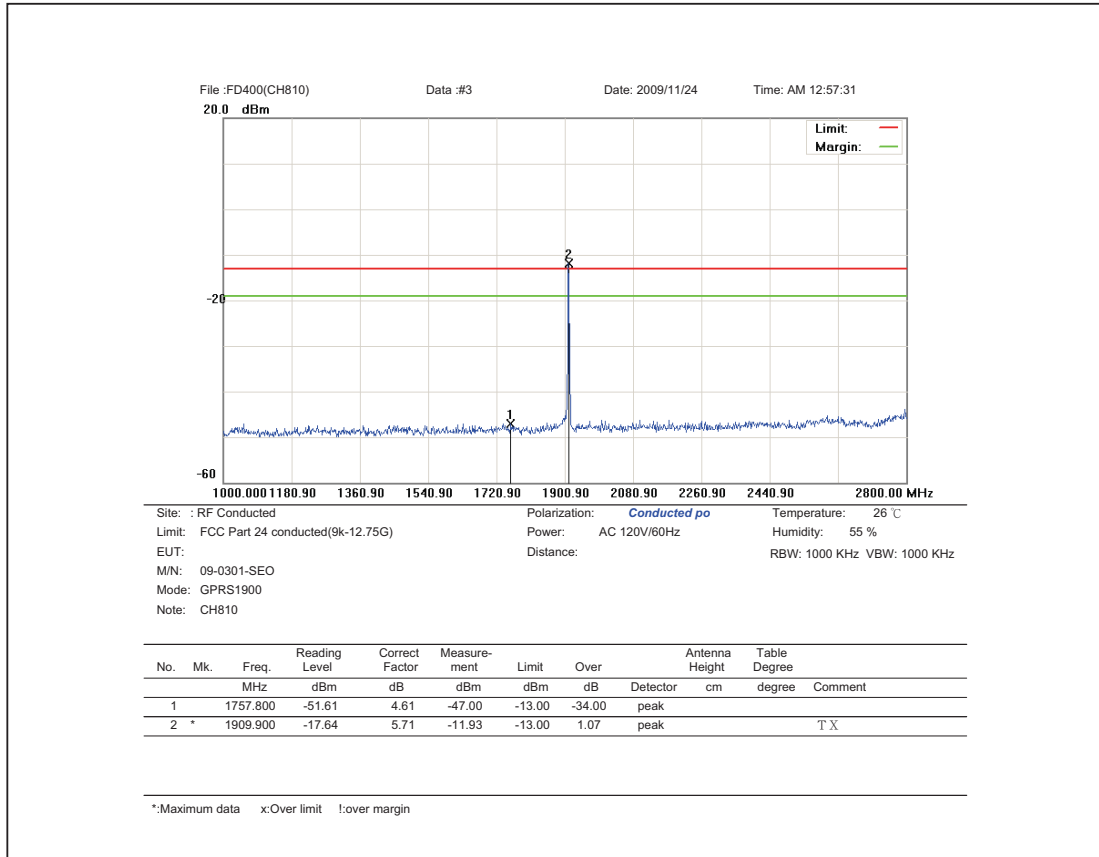

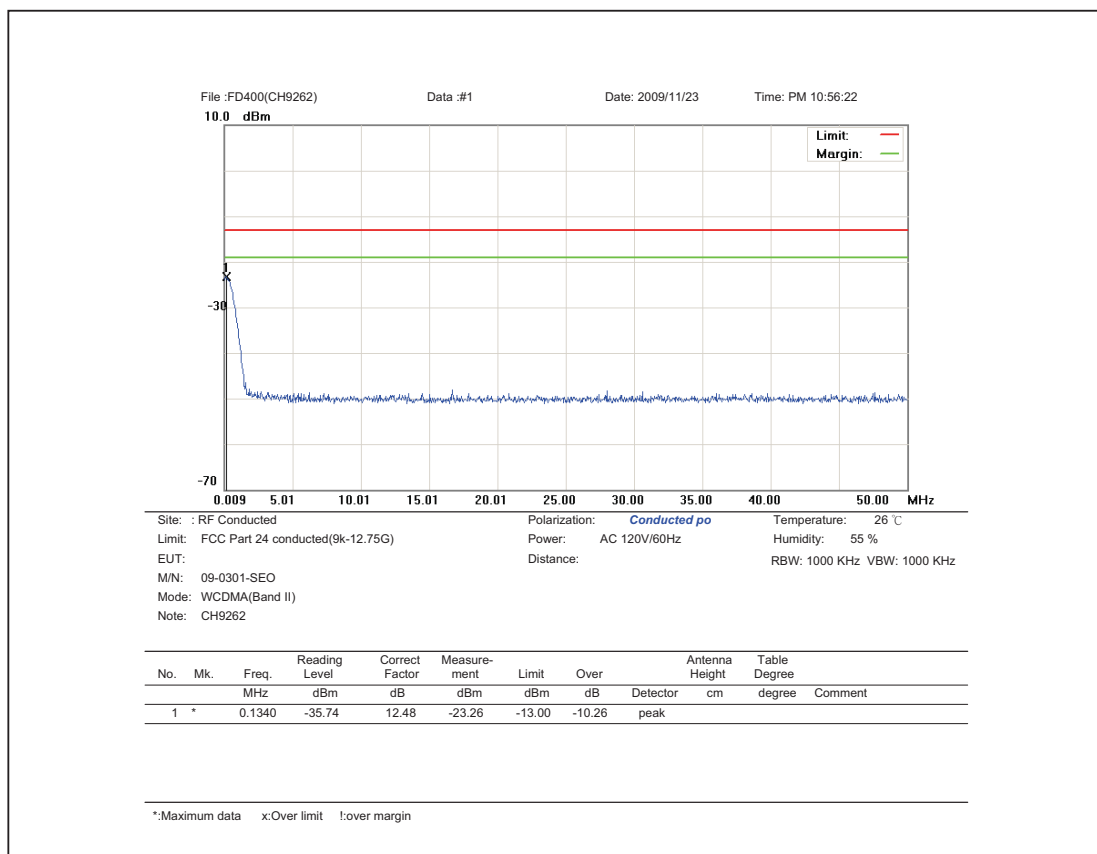
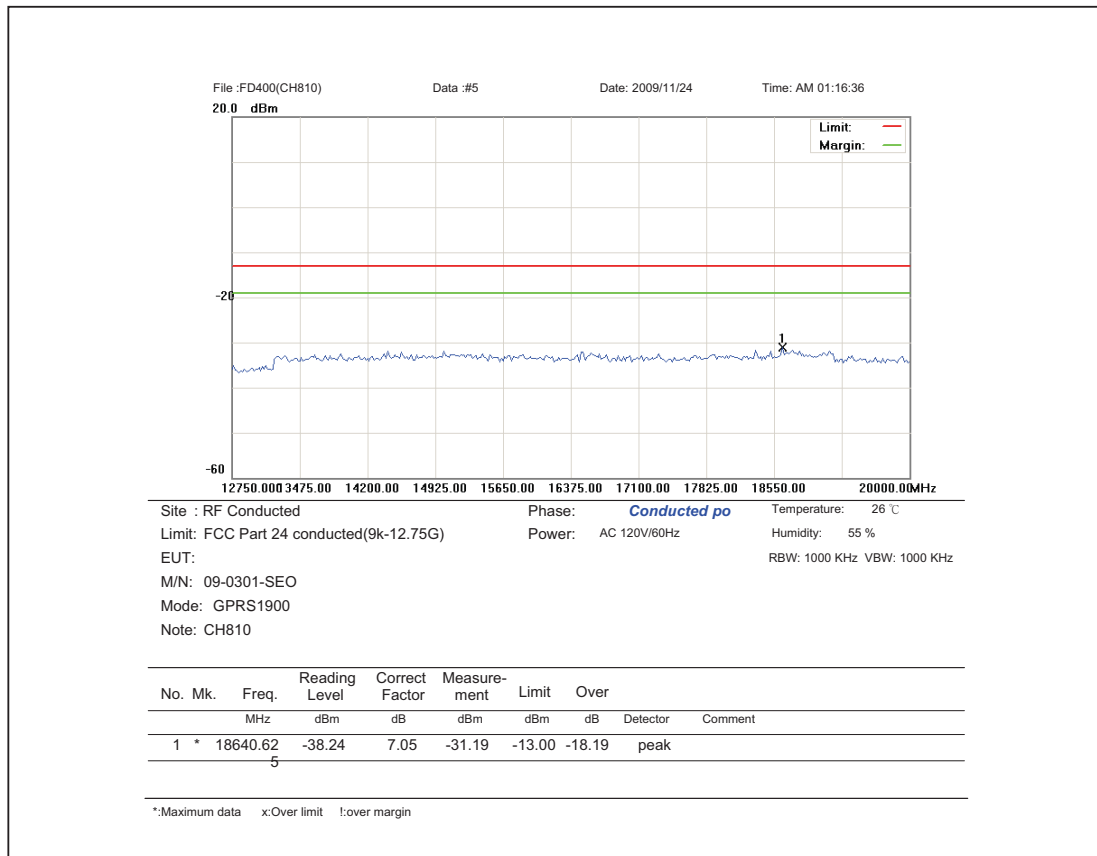

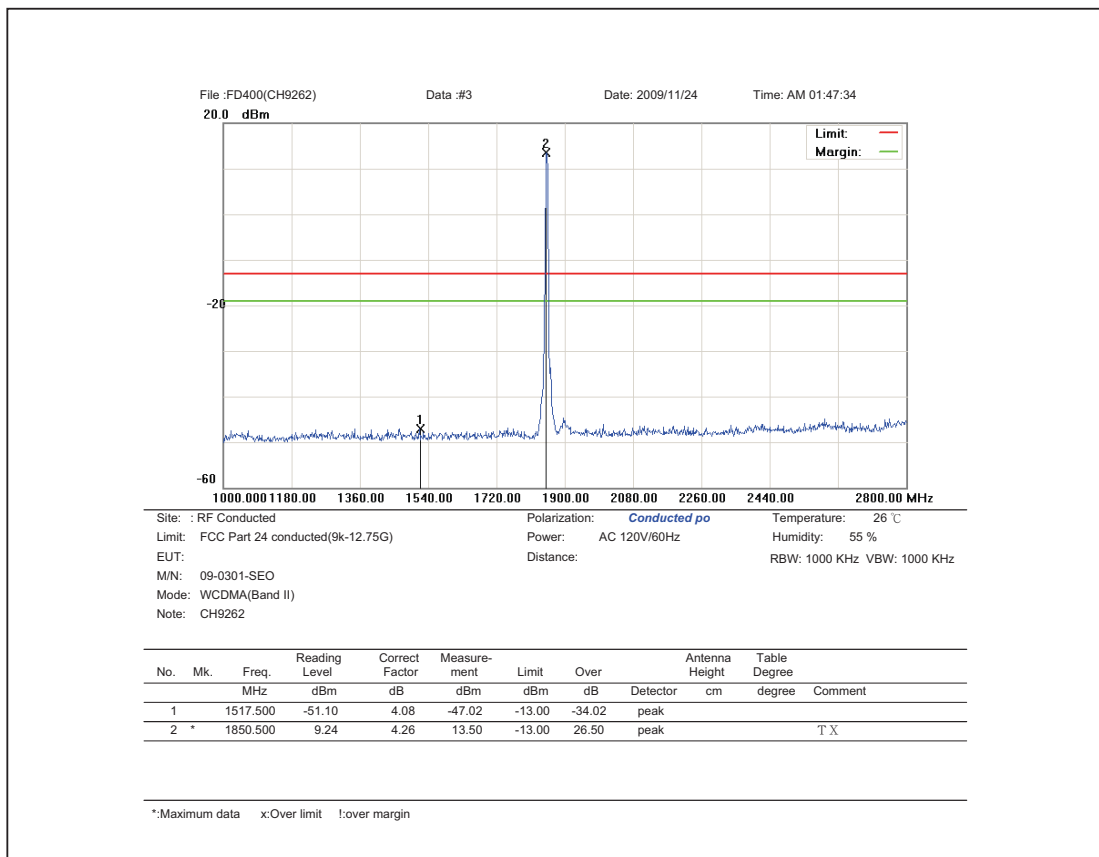
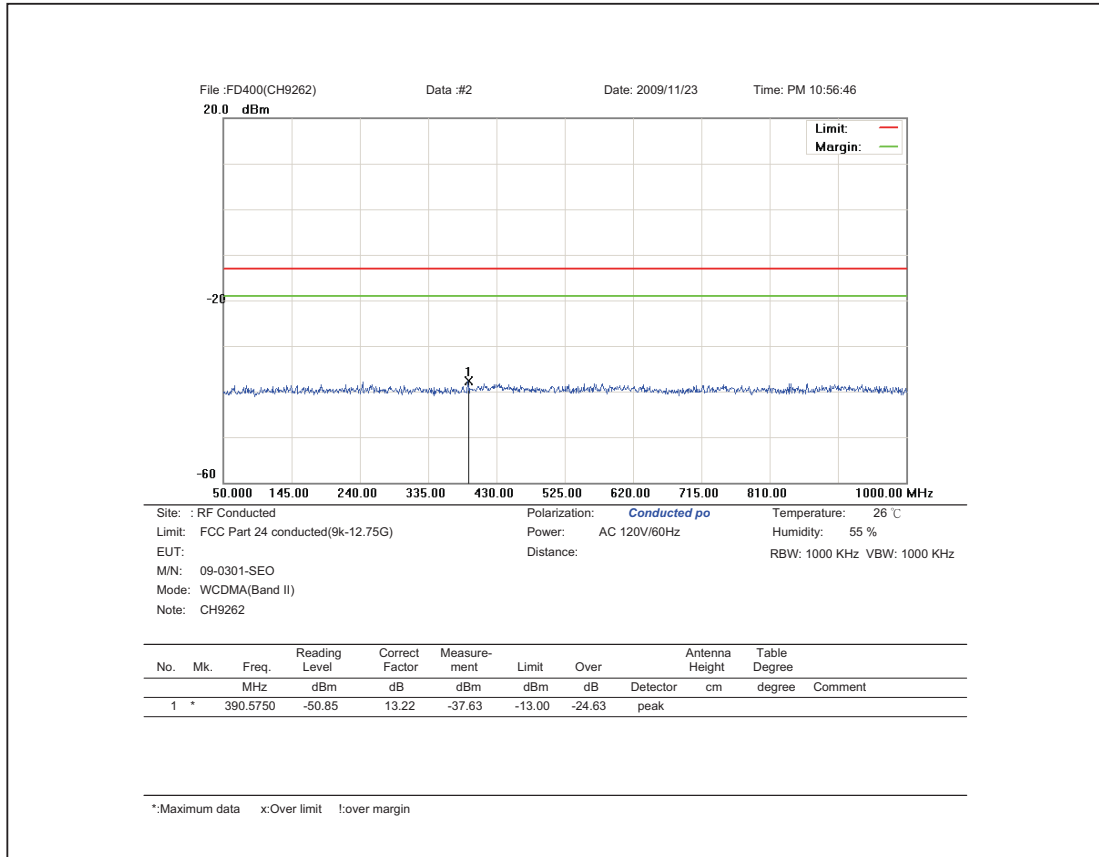



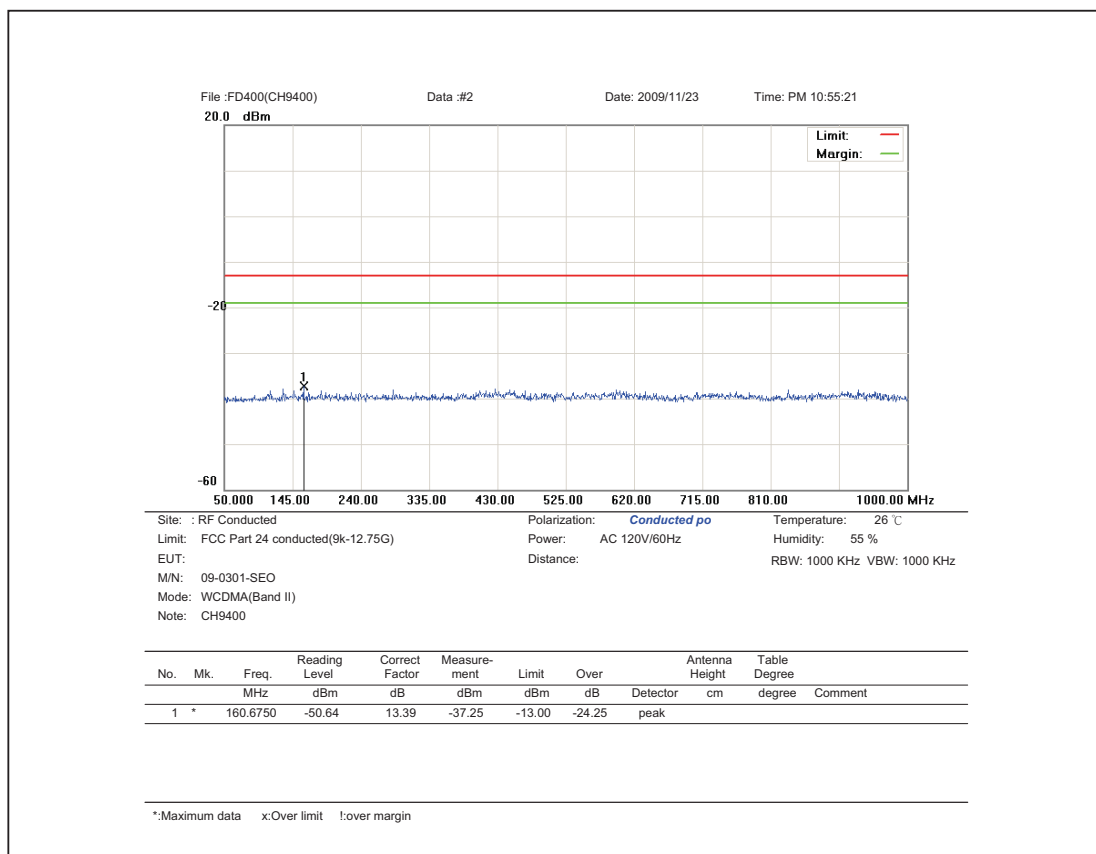
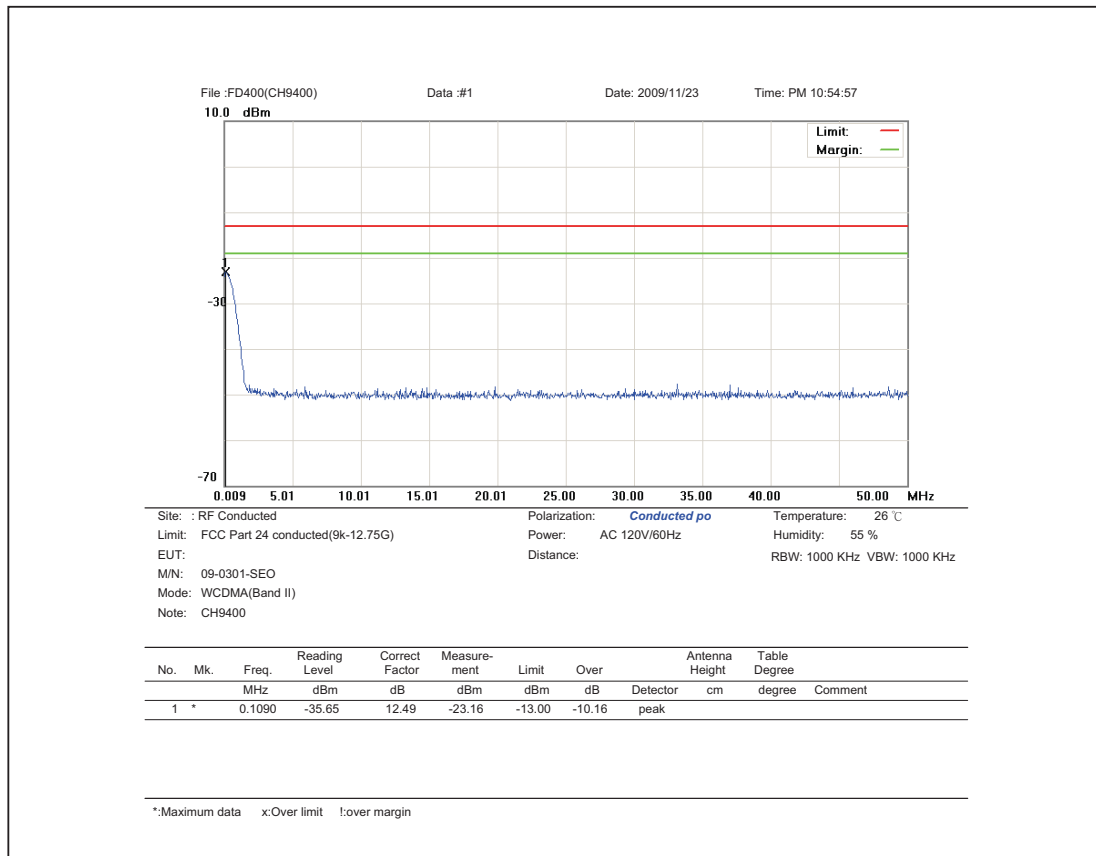

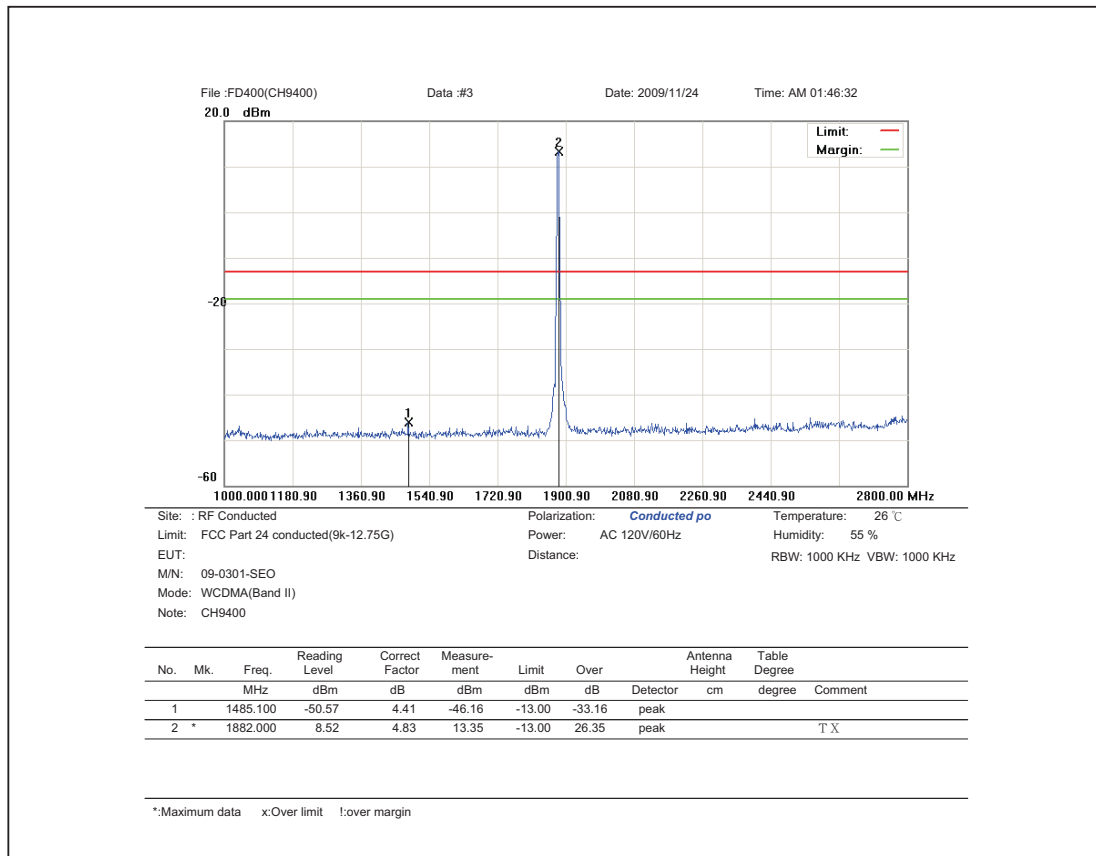

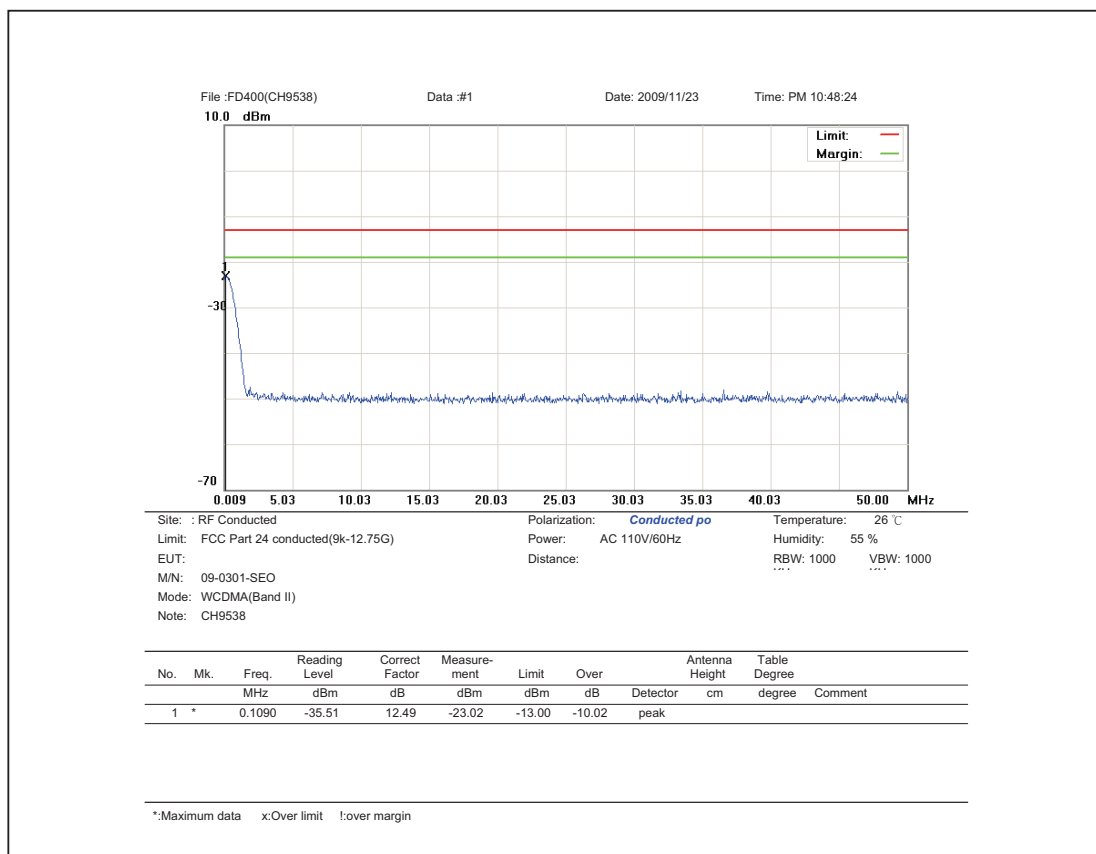
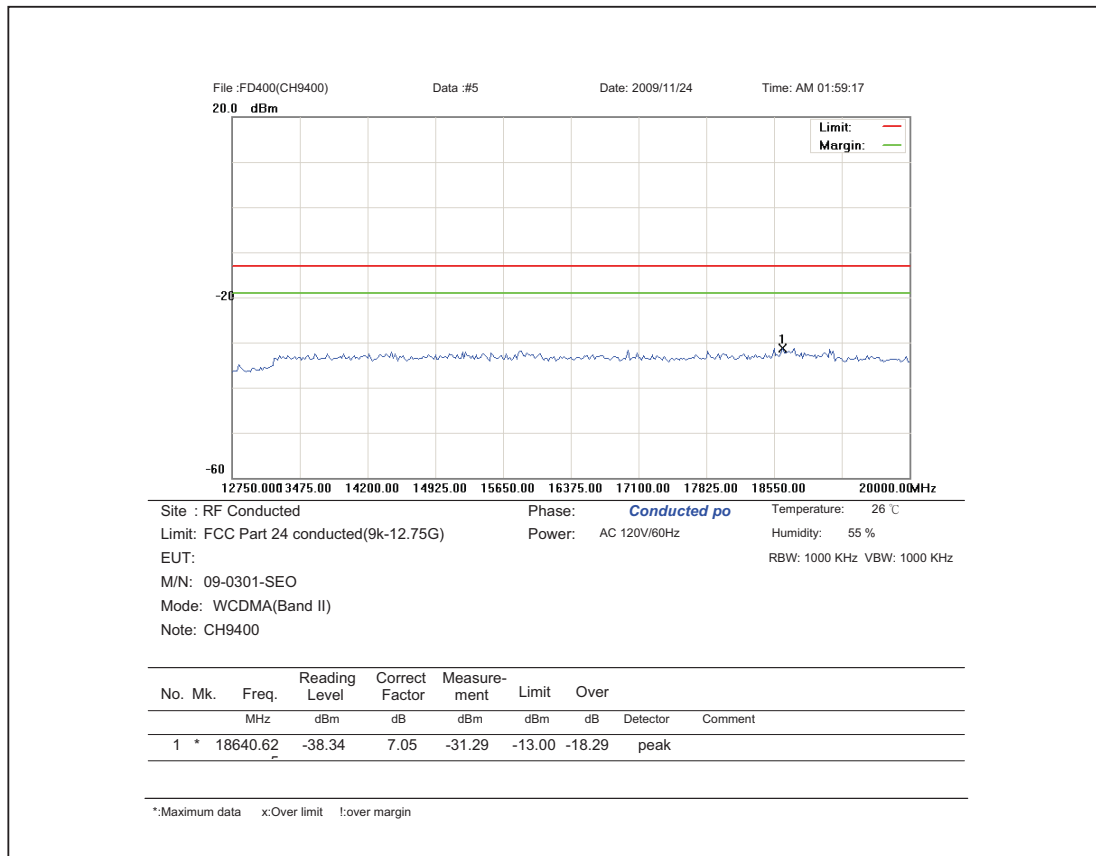

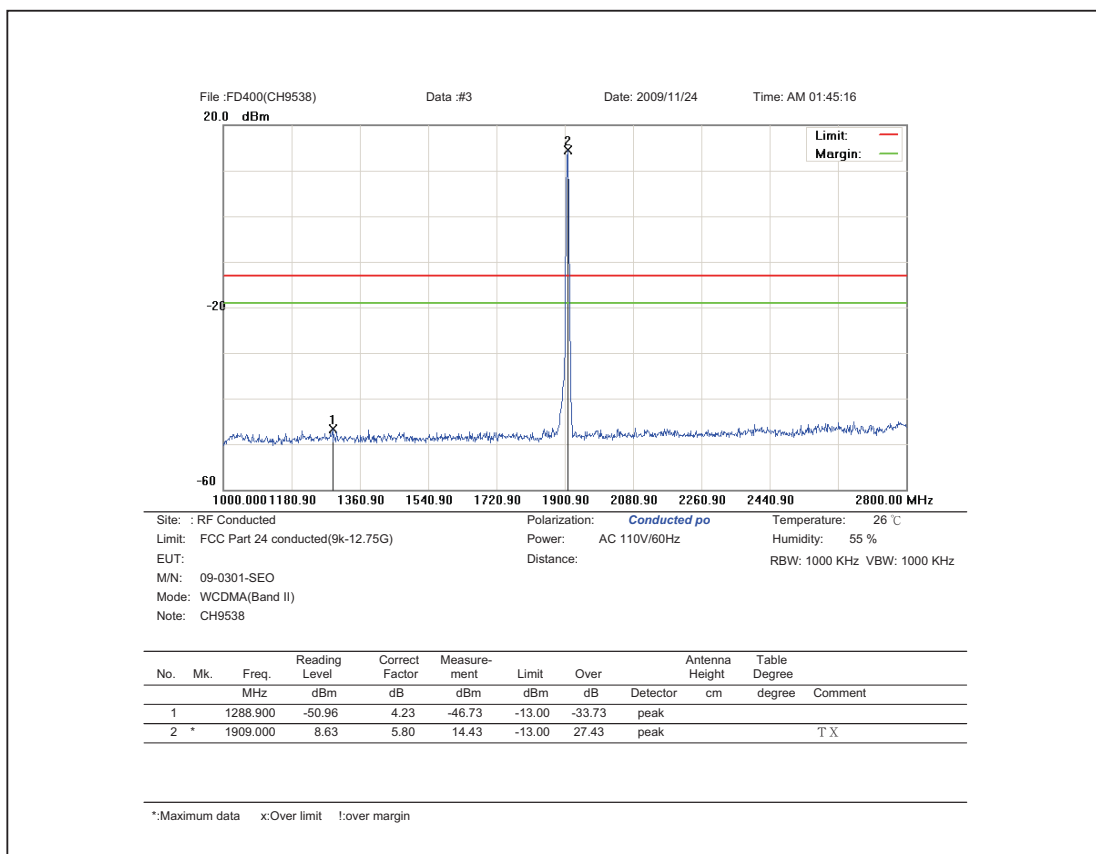
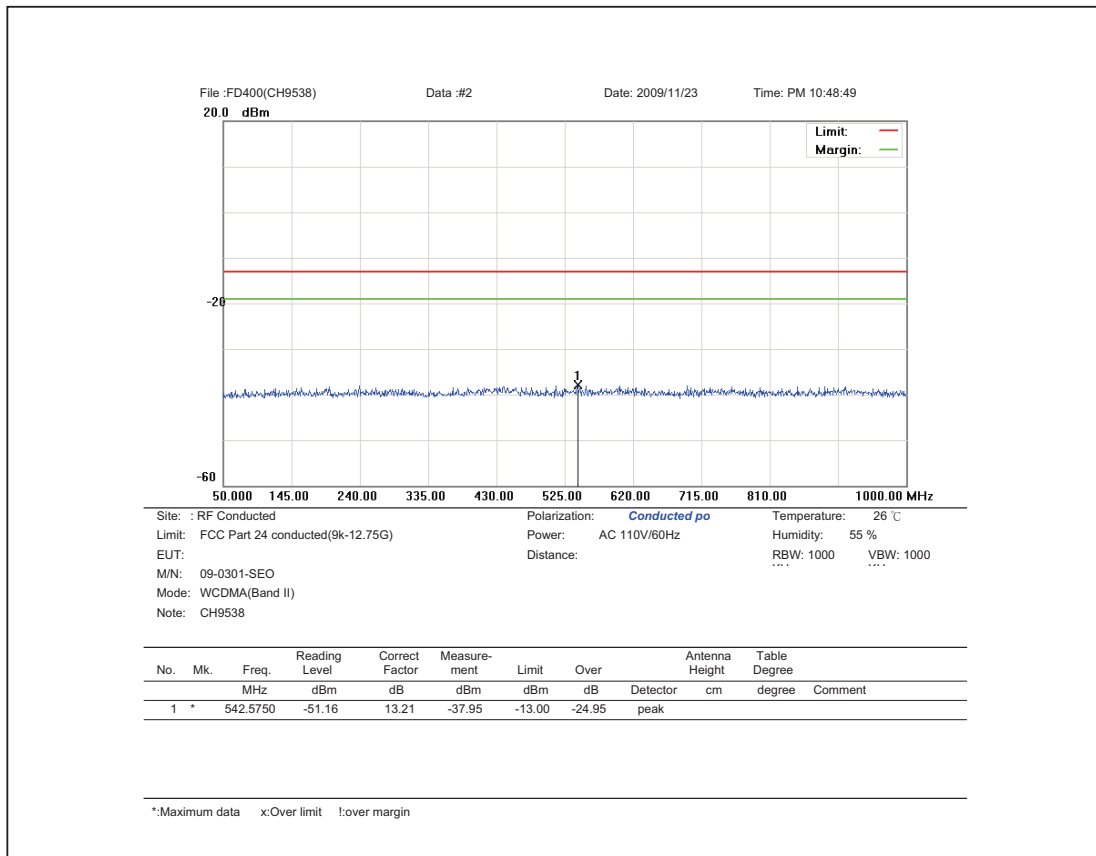

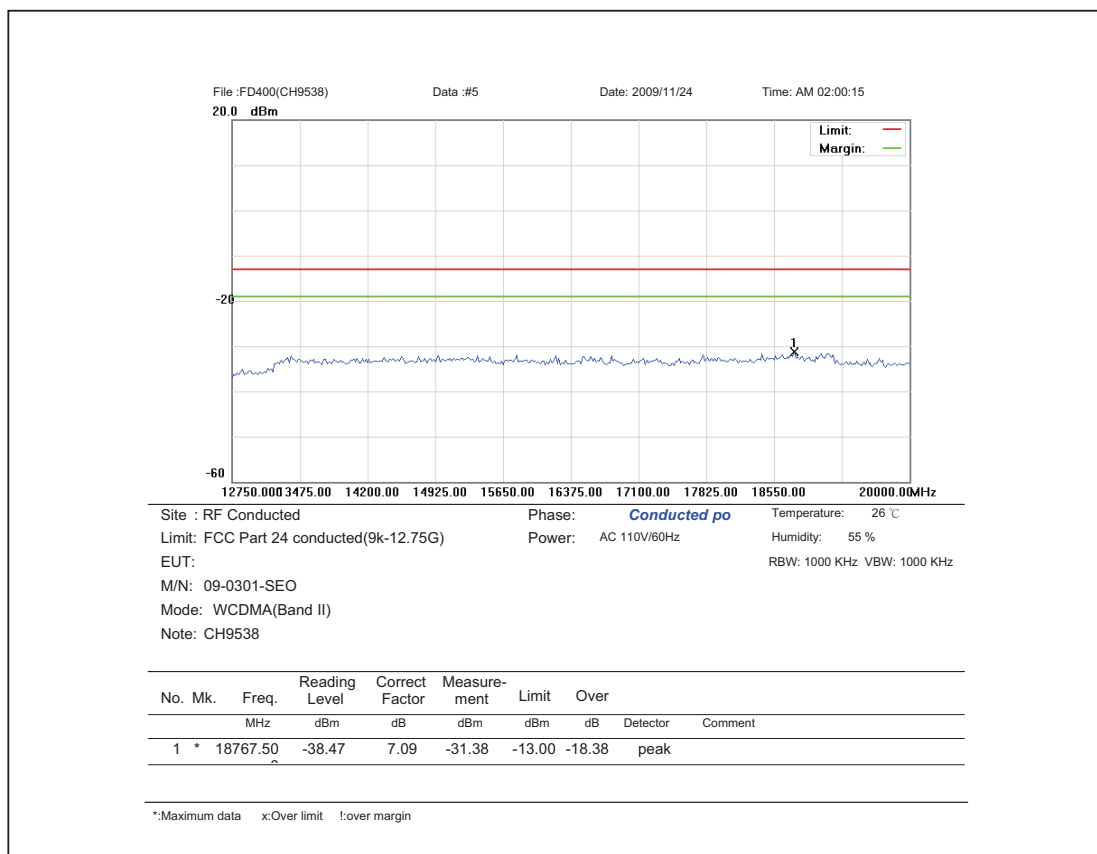
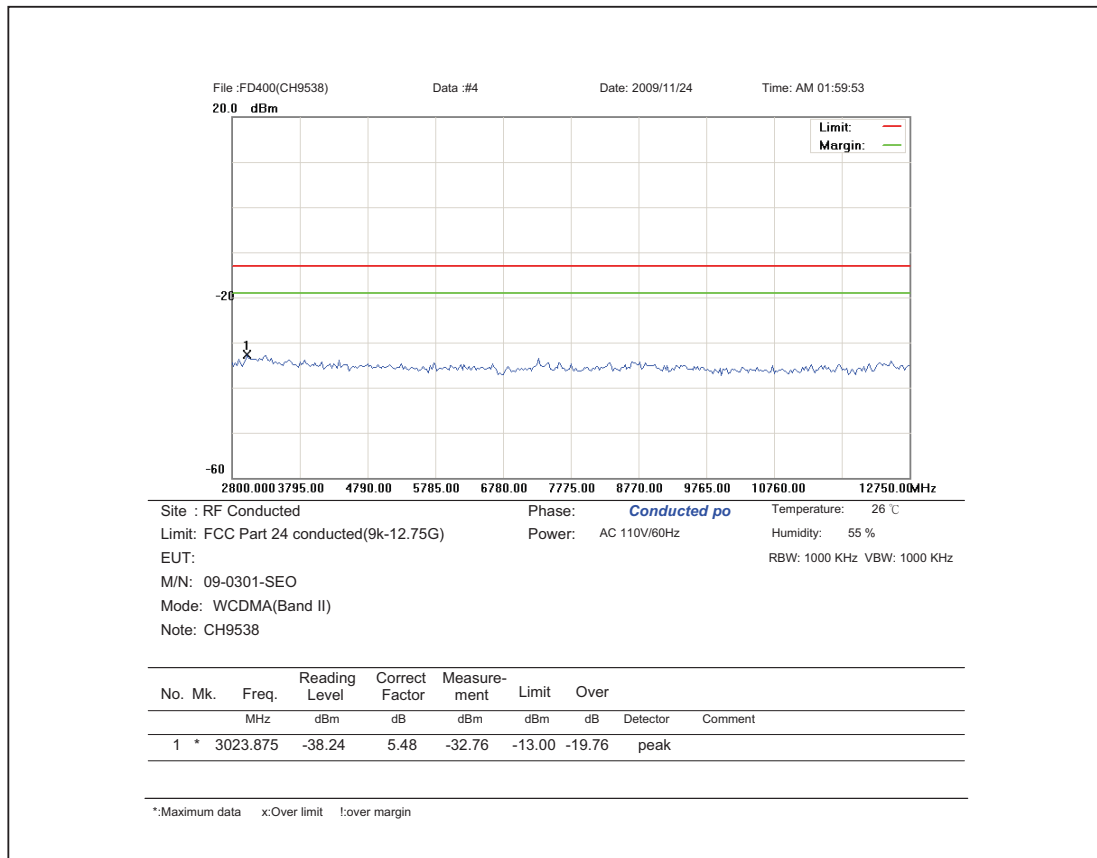

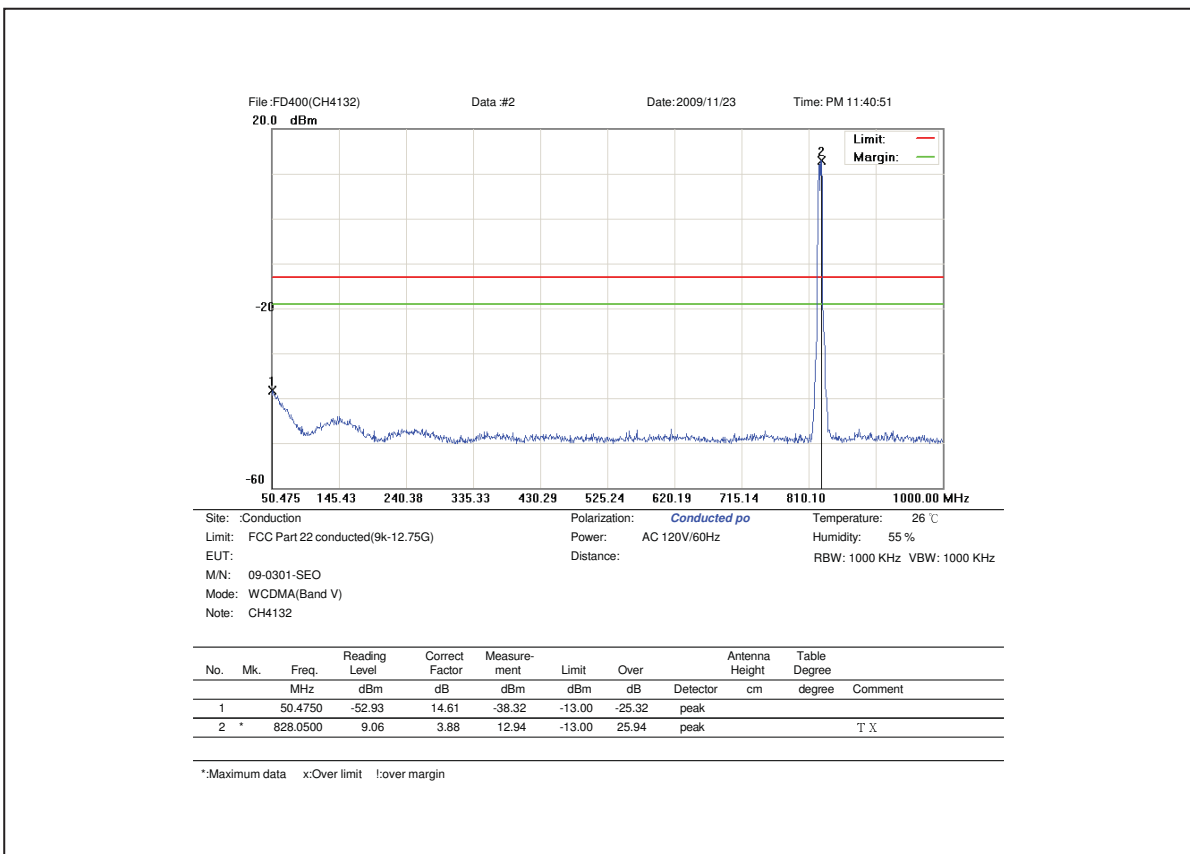
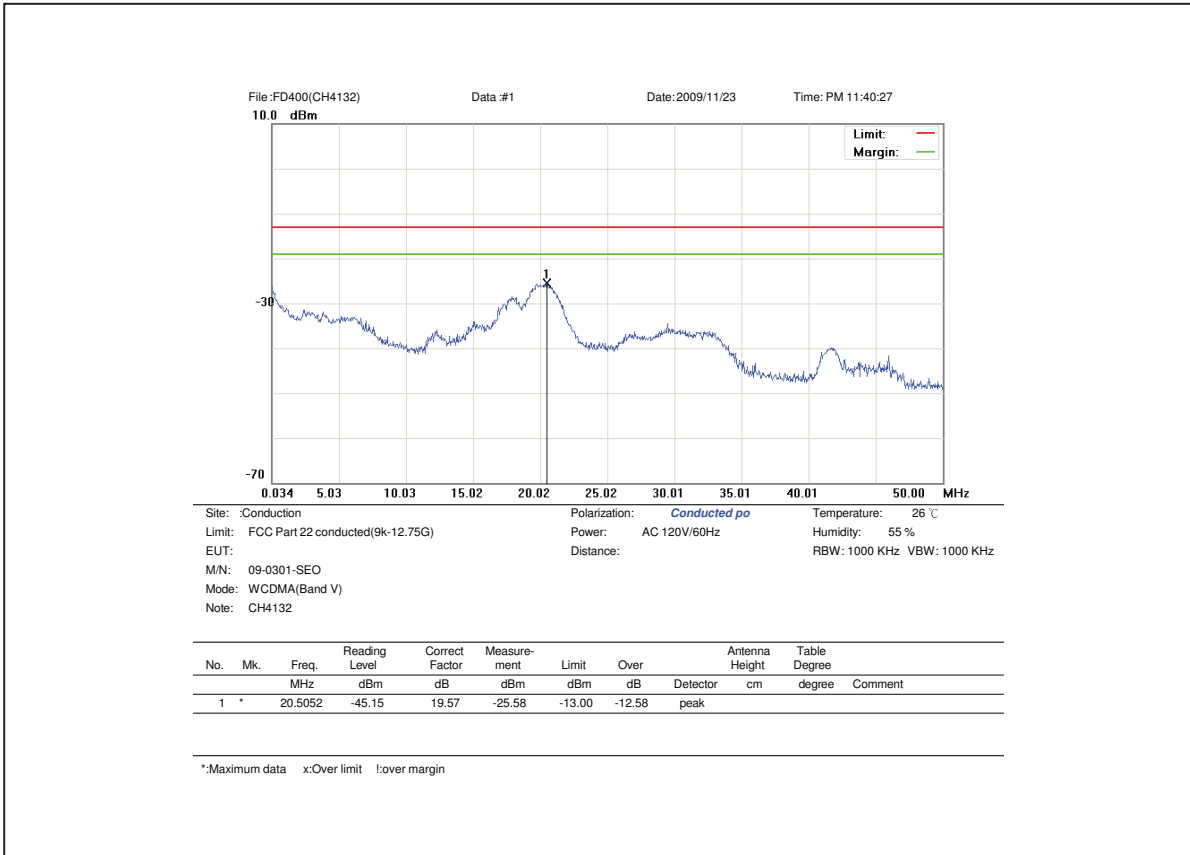

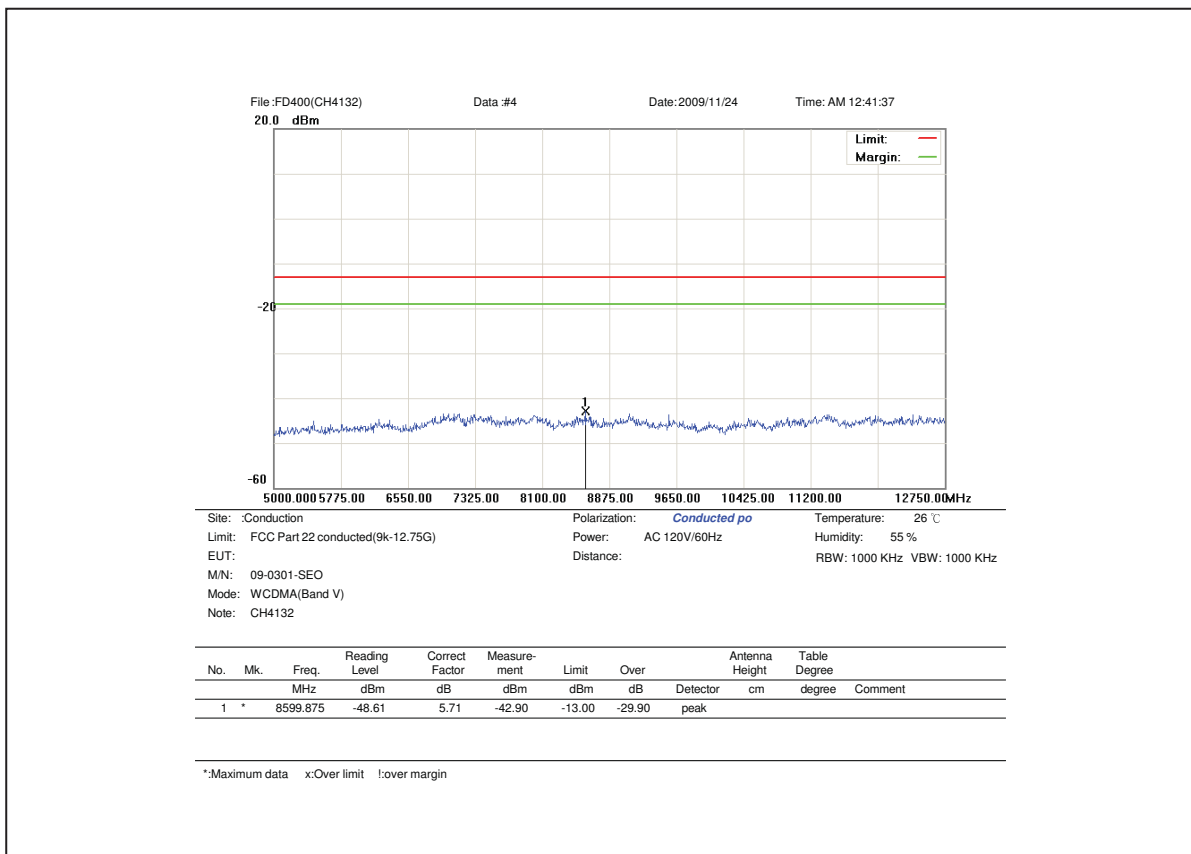
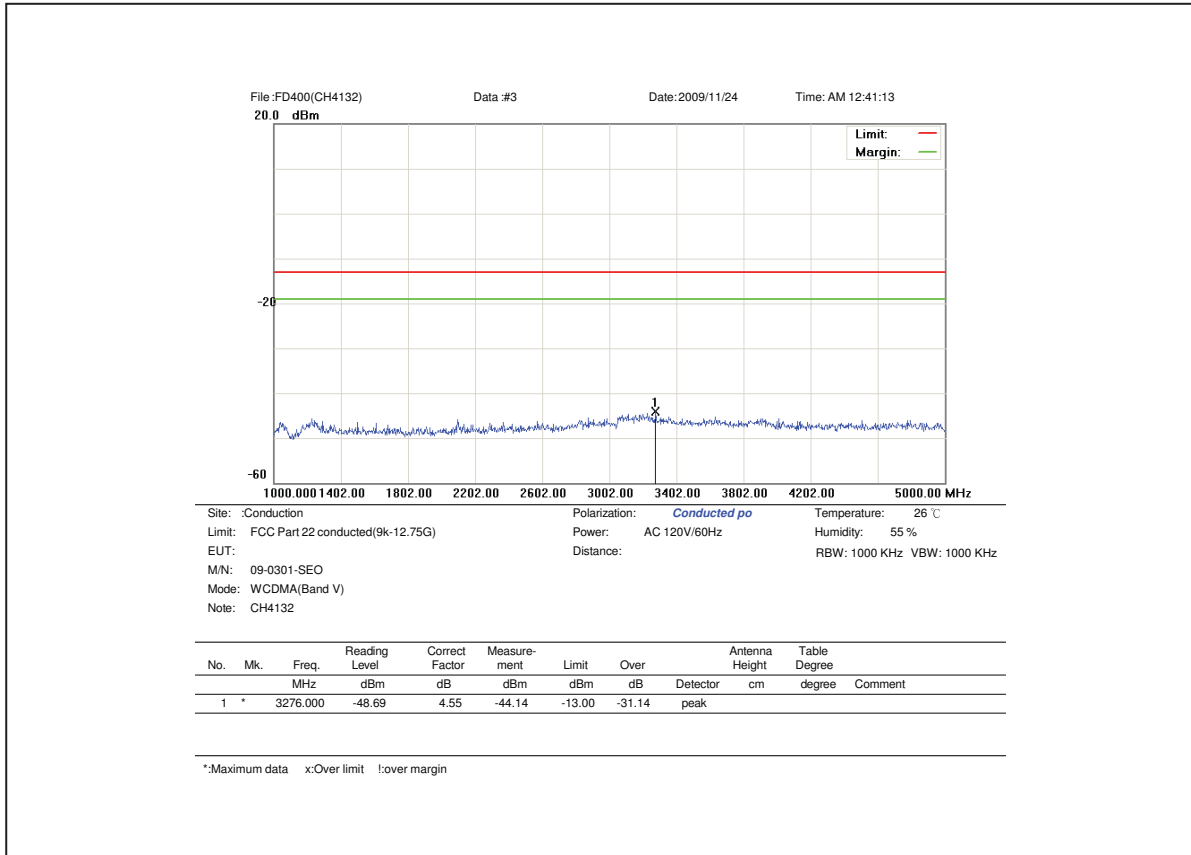

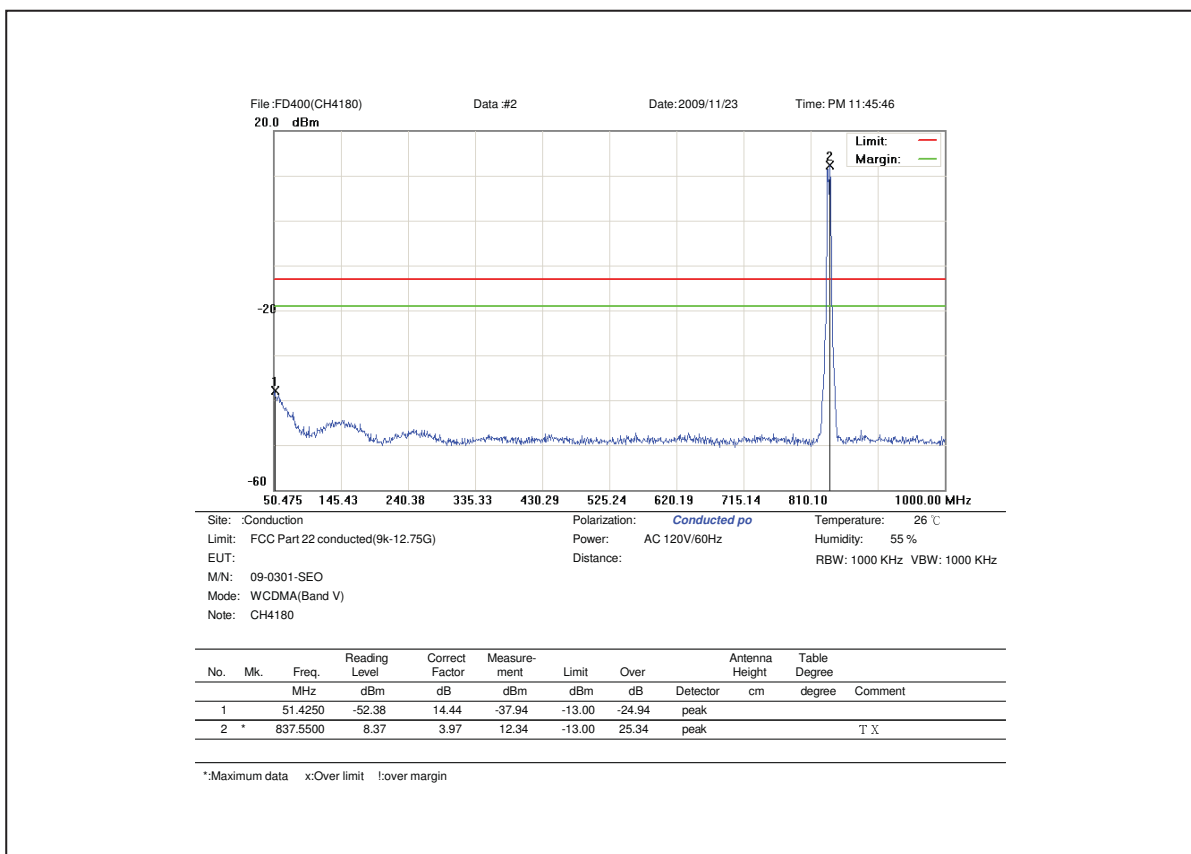
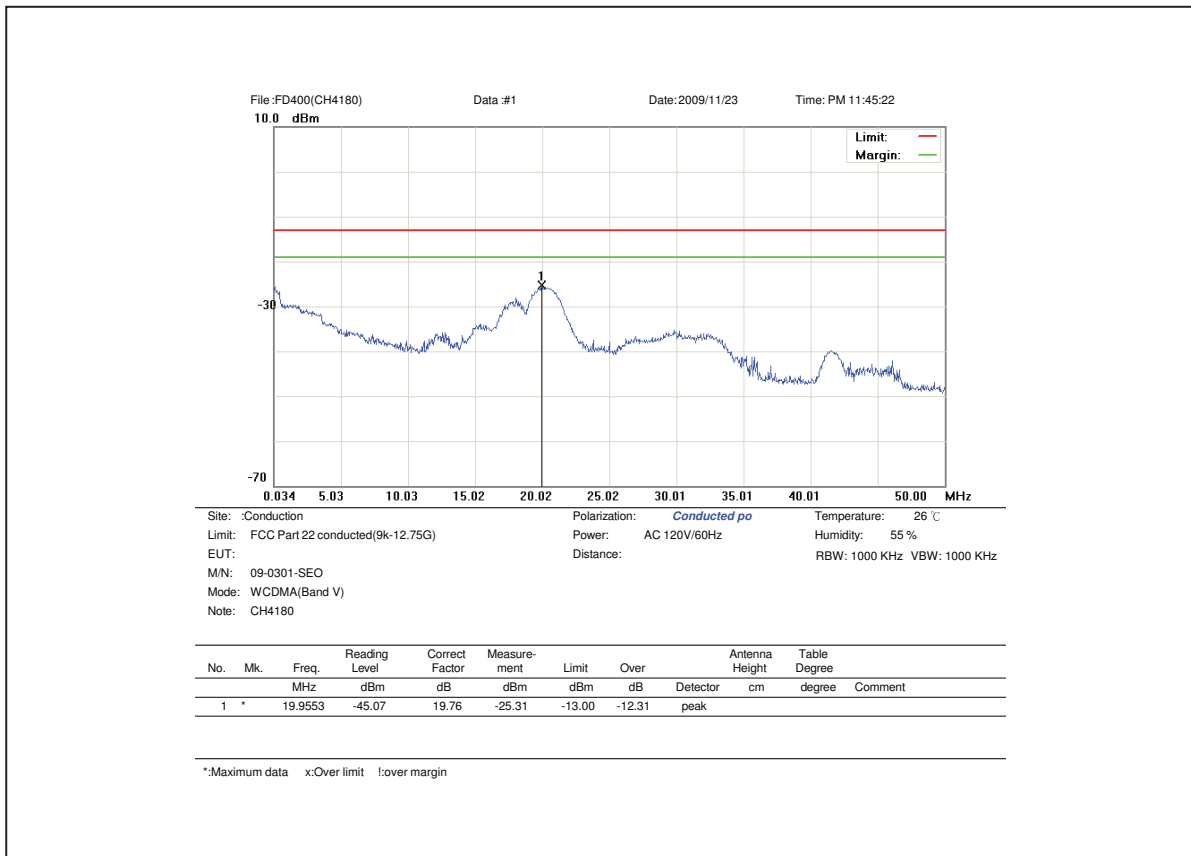

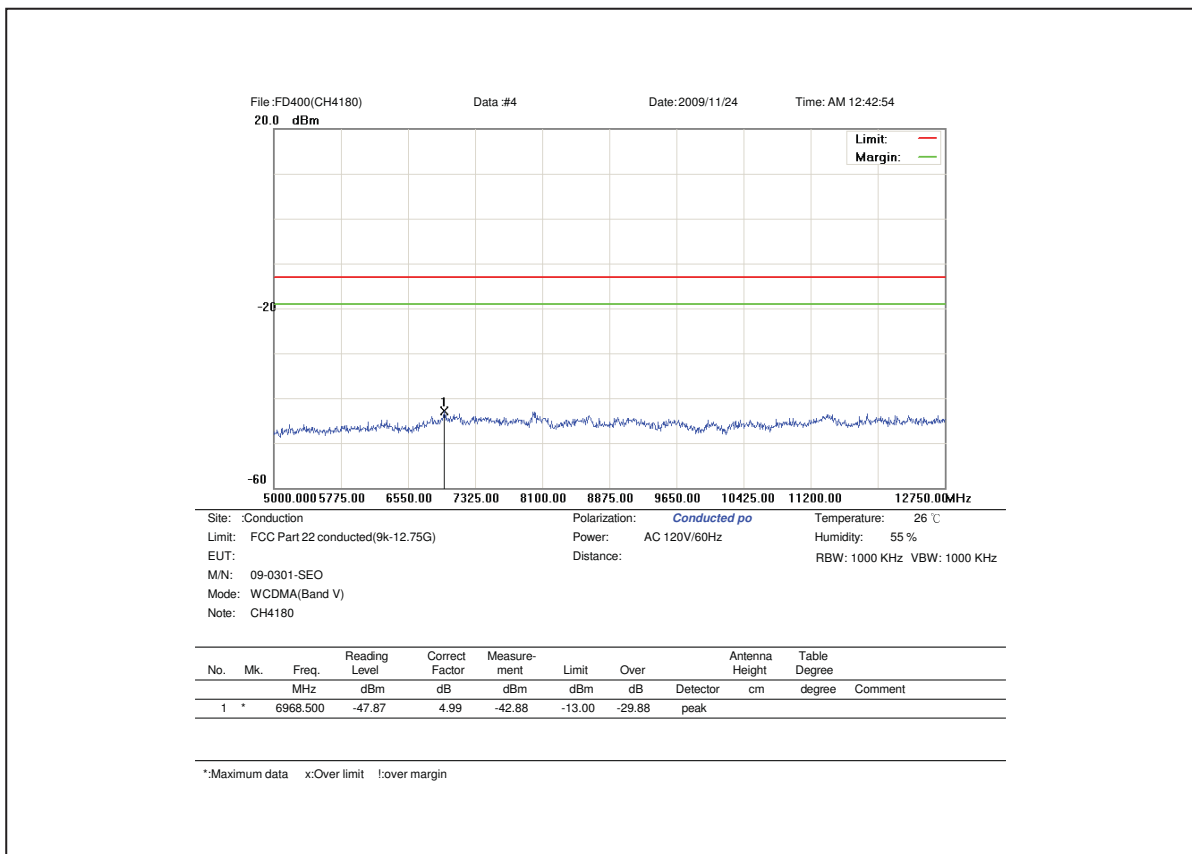
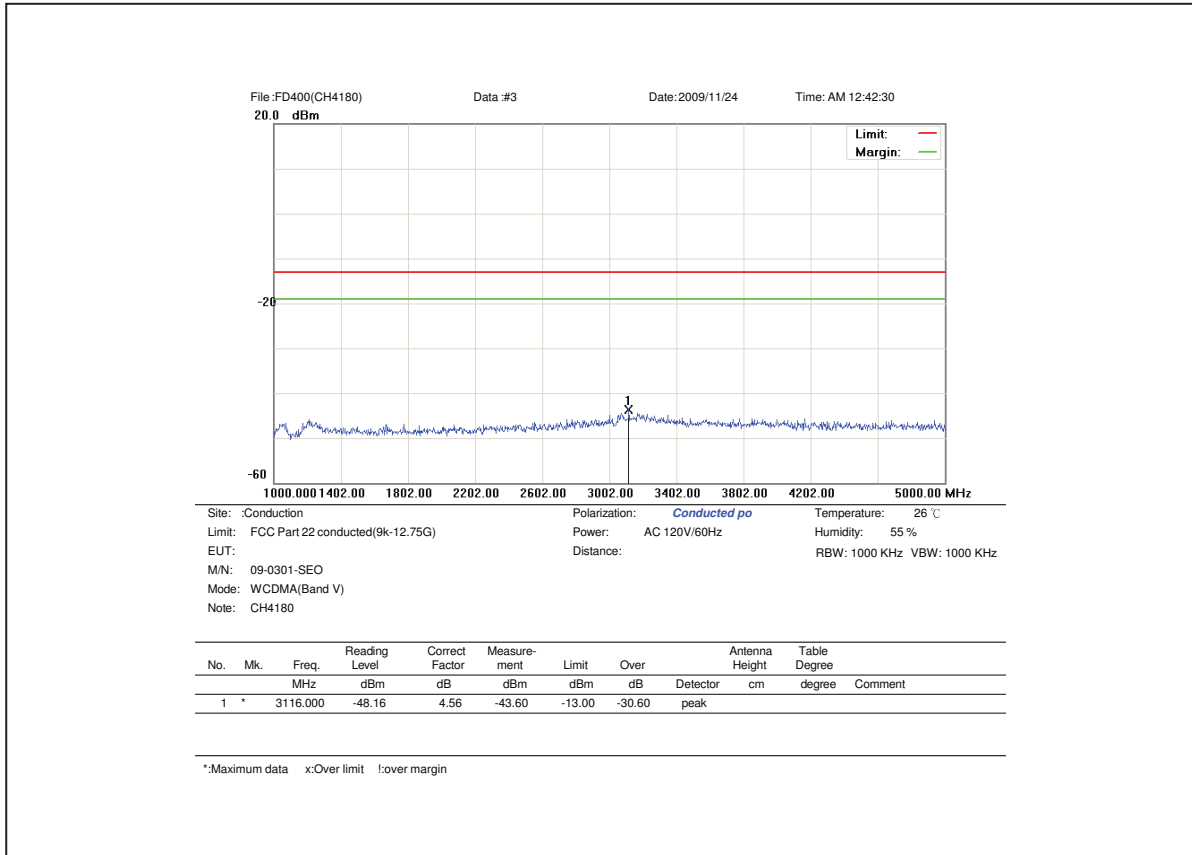

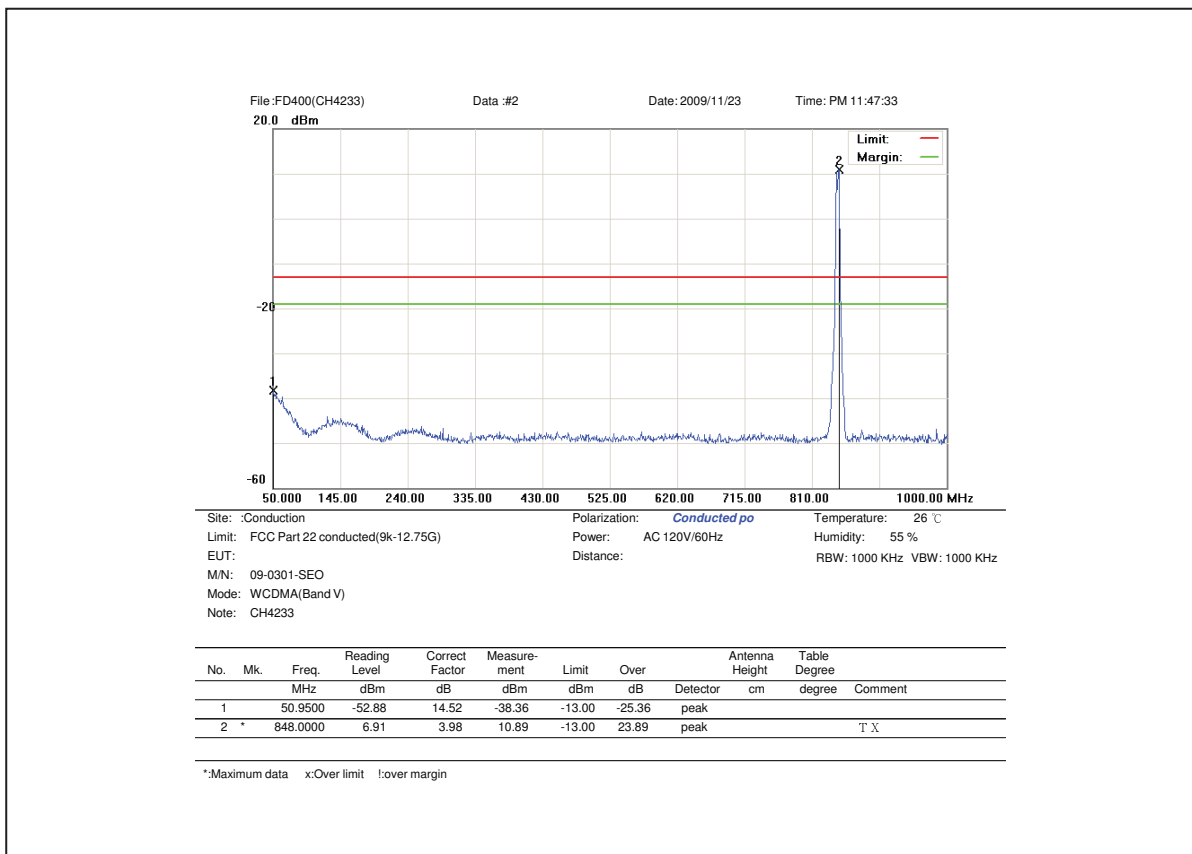
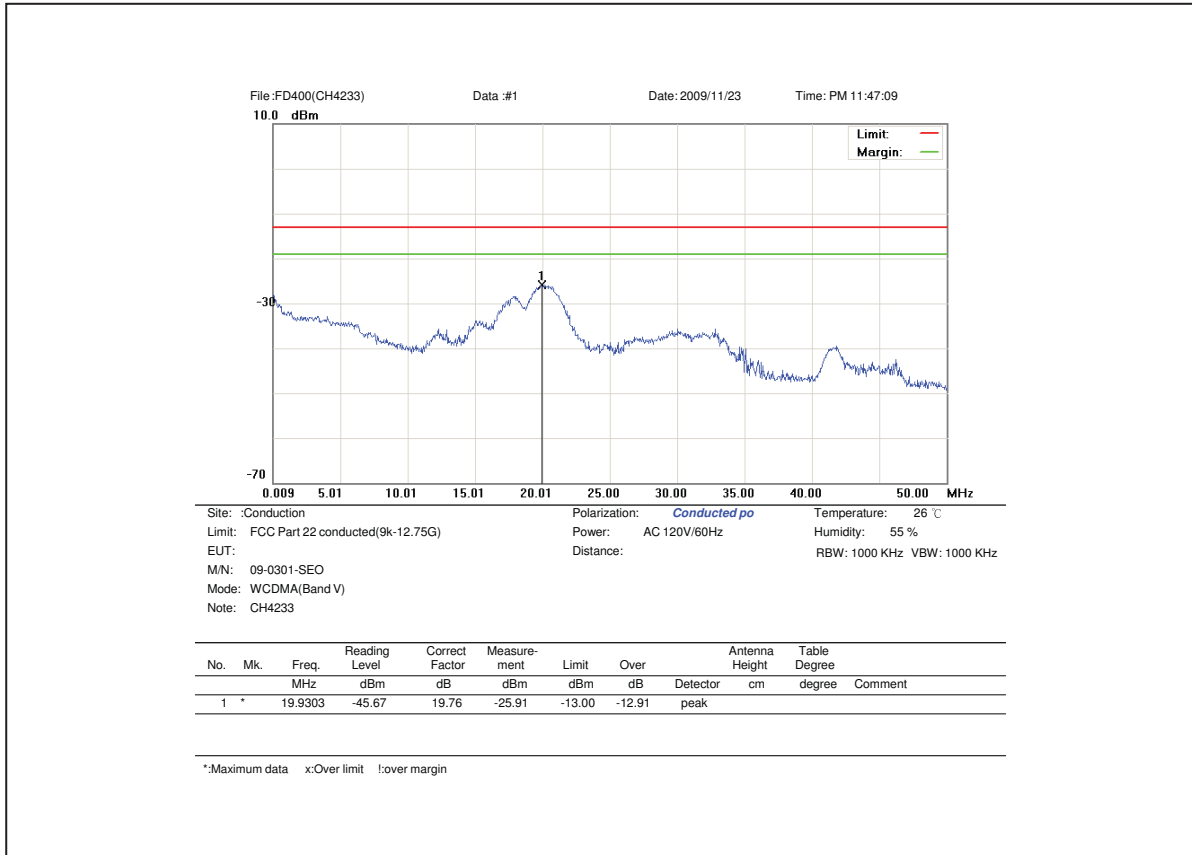

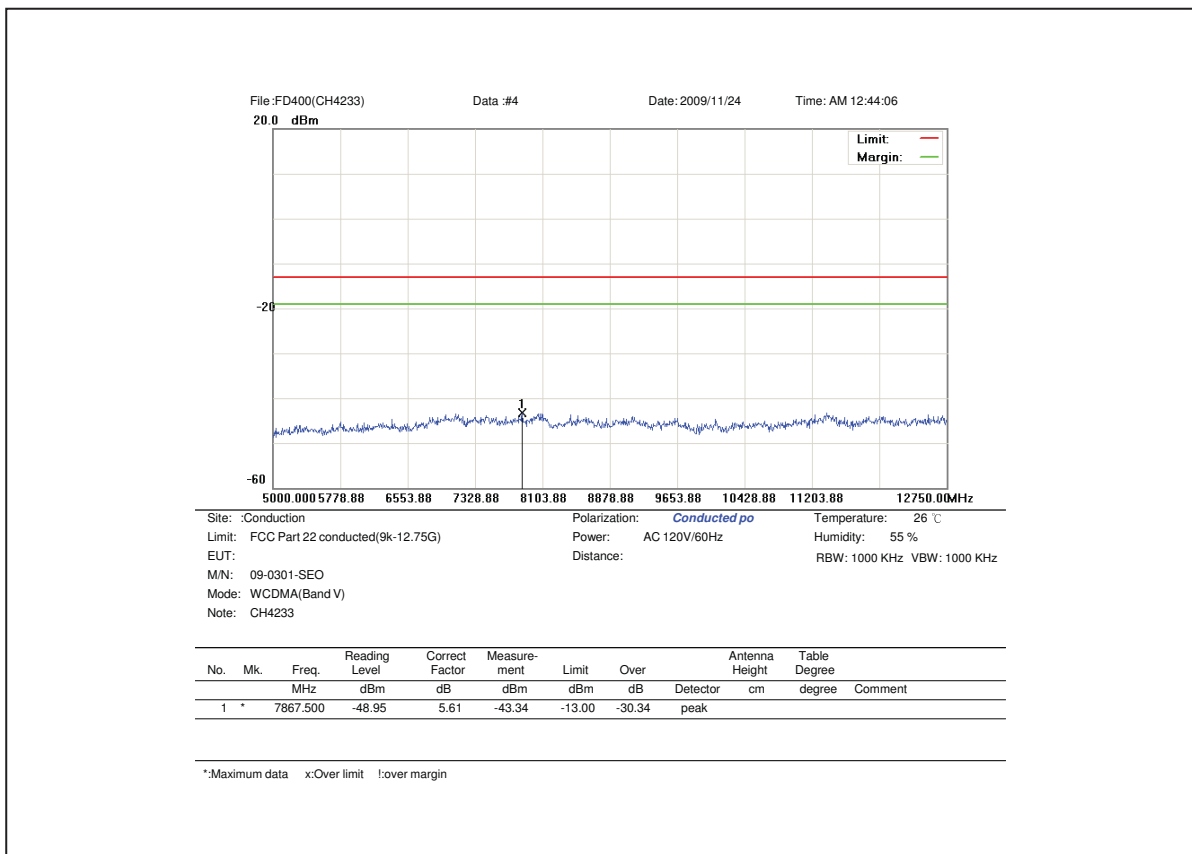
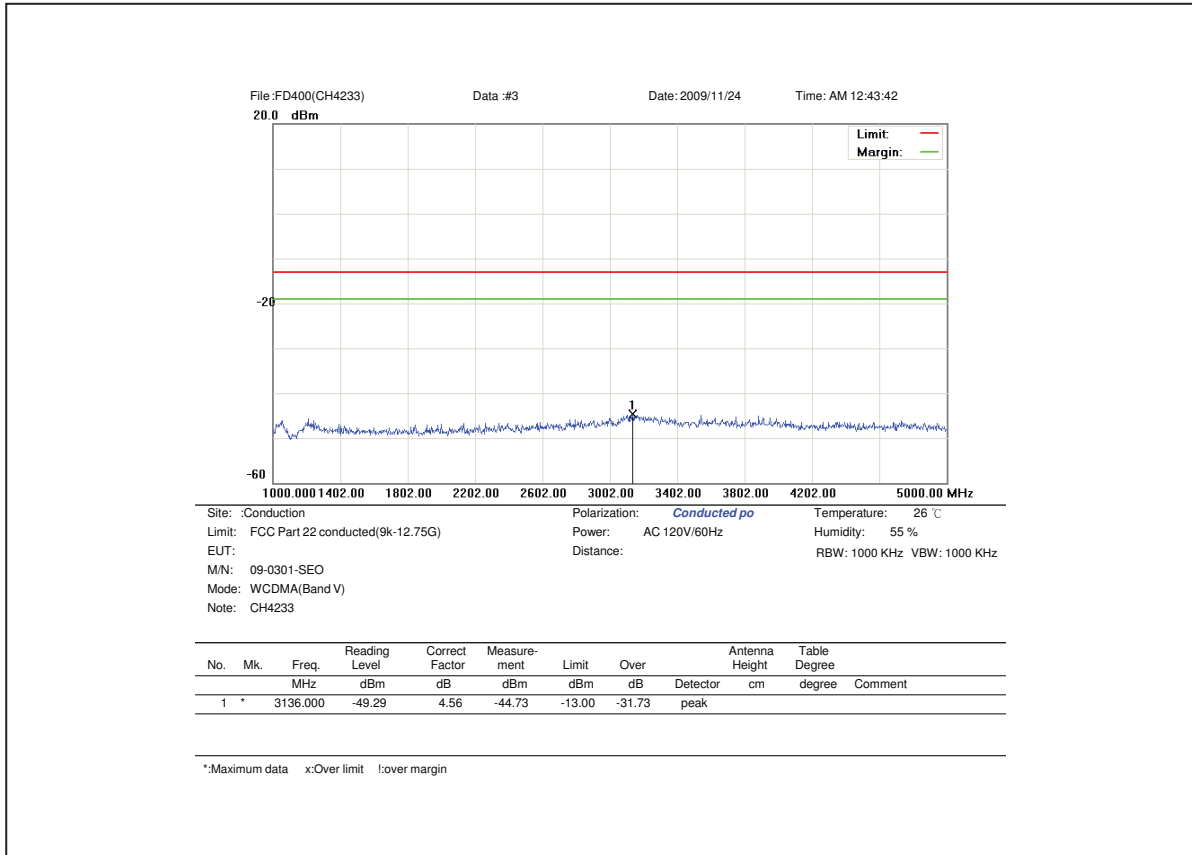

5.7. Test Photograph

Description : Front View of Conducted Emission Test



Description : Back View of Conducted Emission Test

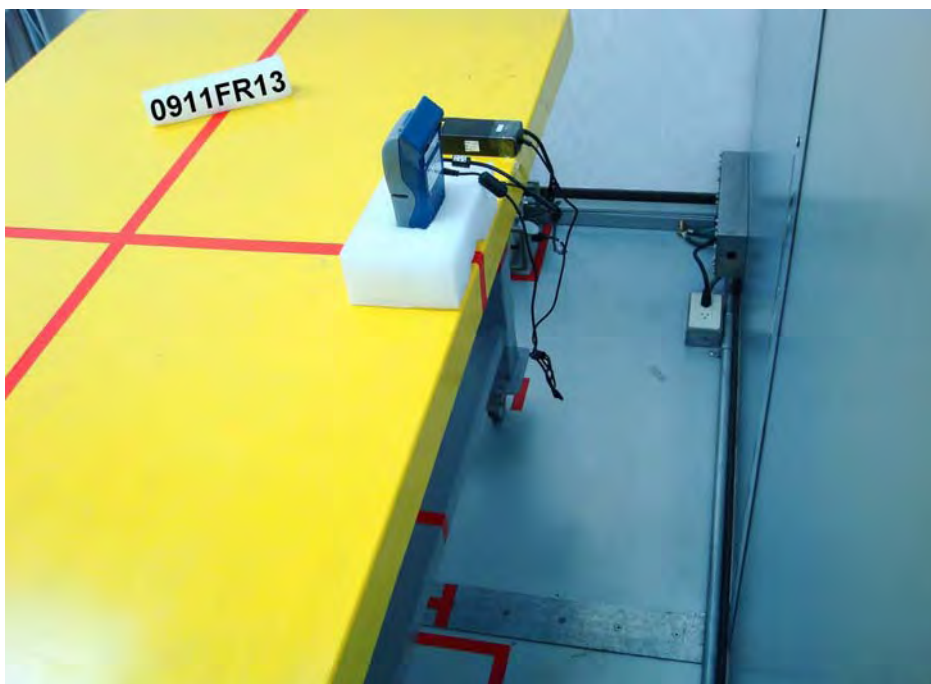

6 Field Strength of Spurious Radiation Test

6.1. Limit

The power of any emission outside of the authorized operating frequency ranges must be attenuated below the transmitting power (P) by a factor of at least $43 + 10\log(P)$ dB.

It is measured by means of a calibrated spectrum analyzer and scanned from 30 MHz up to a frequency including its 10th harmonic.

6.2. Test Instruments

3 Meter Chamber				
Equipment	Manufacturer	Model No.	Serial No.	Cal. Date
Spectrum Analyzer	Agilent	E4408B	MY45107753	06/23/2009
Pre Amplifier	Agilent	8449B	3008A02237	07/01/2009
Pre Amplifier	Agilent	8447D	2944A10961	06/30/2009
Test Receiver	R&S	ESCI	100367	07/01/2009
Biconilog Antenna	SCHWARZBECK MESS-ELEKTRONIK	VULB9163	9163-270	06/23/2009
Horn Antenna	SCHWARZBECK MESS-ELEKTRONIK	BBHA9120D	9120D-550	07/01/2009
Horn Antenna	SCHWARZBECK MESS-ELEKTRONIK	BBHA9170	9170-320	06/30/2009
Test Site	ATL	TE01	888001	08/06/2009

6.3. Setup

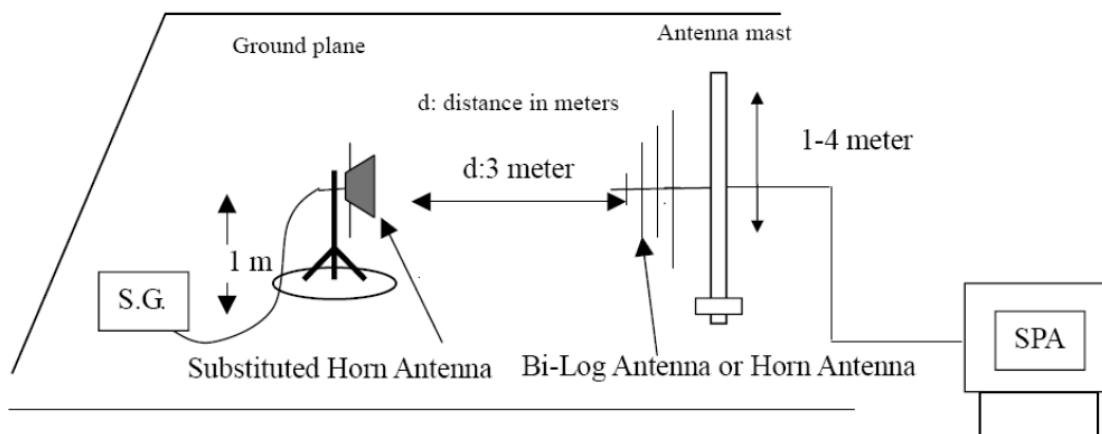

6.4. Test Procedure

The measurement is made according to ANSI/TIA-603-C-2004 as follows:

The equipment under test is placed inside the semi-anechoic chamber on a wooden table at the turntable center. For each spurious frequency, the antenna mast is raised and lowered from 1 to 4 meters and the turntable is rotated 360 degrees to obtain a maximum reading on the spectrum analyzer. This is repeated for both horizontal and vertical polarizations of the receive antenna.

The equipment under test is then replaced with a substitution antenna fed by a signal generator. With the signal generator tuned to a particular spurious frequency, the antenna mast is raised and lowered from 1 to 4 meters to obtain a maximum reading at the spectrum analyzer. The output of the signal generator is then adjusted until a reading identical to that obtained with the actual transmitter is achieved.

The power in dBm of each spurious emission is calculated by correcting the signal generator level for cable loss and gain of the substitution antenna referenced to a dipole. A fully charged battery was used for the supply voltage.

The settings of the receiver were as follows:

Units	dBm
Resolution Bandwidth	1 MHz
Video Bandwidth	Auto
Sweep Time	Auto

6.5. Uncertainty

The measurement uncertainty is defined as for Field Strength of Spurious Radiation measurement is ± 3.072 dB.

6.6. Test Result

Product	Portable Terminal		
Test Item	Field Strength of Spurious Radiation		
Test Mode	Mode 1: GPRS850 Link / CH128	Polarization	Horizontal
Date of Test	11/23/2009	Test Site	TE01

Harmonic	Frequency (MHz)	Polarization	FCC Max. Limit (dBm)	S.G Power (dBm)	Substitution Antenna Gain (dBi)	Cable Loss (dBm)	Peak Output Power (dBm)
2nd	1648.8	H	-13	-52.63	10.72	0.56	-42.47
3rd	2473.2	H	-13	-52.13	10.66	0.62	-42.09
4th	3297.6	H	-13	-54.68	10.78	0.74	-44.64
5th	4122.0	H	-13	*	*	*	*
6th	4946.4	H	-13	*	*	*	*
7th	5770.8	H	-13	*	*	*	*
8th	6595.2	H	-13	*	*	*	*
9th	7419.6	H	-13	*	*	*	*
10th	8244.0	H	-13	*	*	*	*

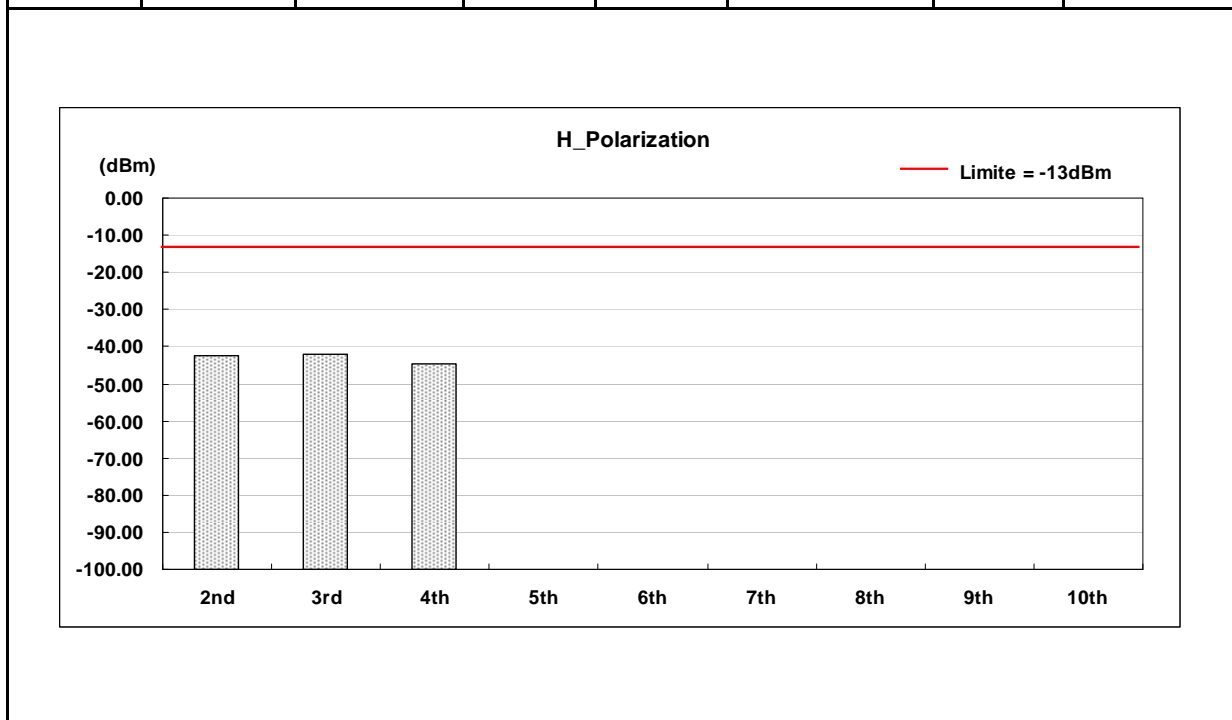

Product	Portable Terminal		
Test Item	Field Strength of Spurious Radiation		
Test Mode	Mode 1: GPRS850 Link / CH128	Polarization	Vertical
Date of Test	11/23/2009	Test Site	TE01

Harmonic	Frequency (MHz)	Polarization	FCC Max. Limit (dBm)	S.G Power (dBm)	Substitution Antenna Gain (dBi)	Cable Loss (dBm)	Peak Output Power (dBm)
2nd	1648.8	V	-13	-43.86	10.72	0.56	-33.70
3rd	2473.2	V	-13	-53.11	10.66	0.62	-43.07
4th	3297.6	V	-13	-54.20	10.78	0.74	-44.16
5th	4122.0	V	-13	*	*	*	*
6th	4946.4	V	-13	*	*	*	*
7th	5770.8	V	-13	*	*	*	*
8th	6595.2	V	-13	*	*	*	*
9th	7419.6	V	-13	*	*	*	*
10th	8244.0	V	-13	*	*	*	*

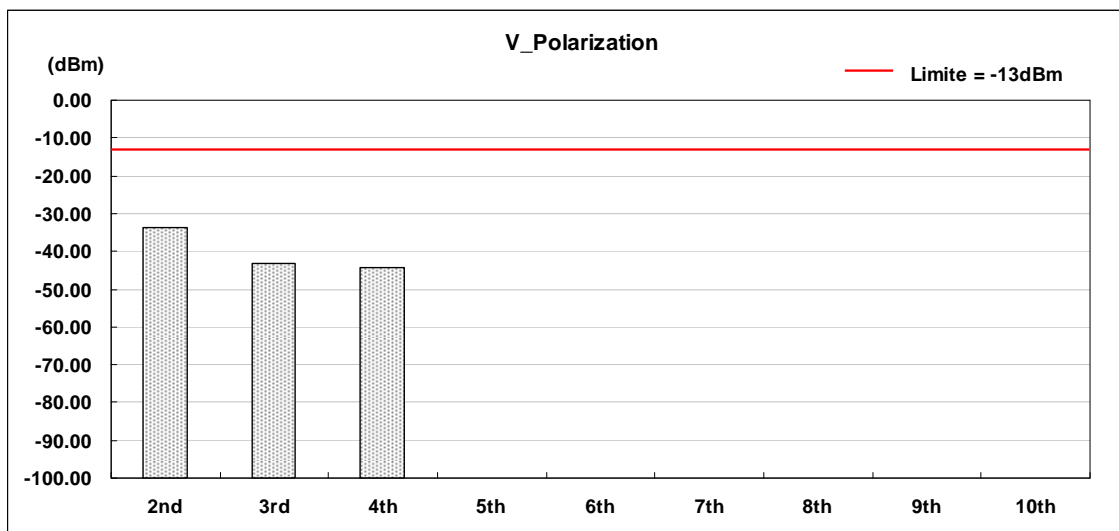

Product	Portable Terminal		
Test Item	Field Strength of Spurious Radiation		
Test Mode	Mode 1: GPRS850 Link / CH190	Polarization	Horizontal
Date of Test	11/23/2009	Test Site	TE01

Harmonic	Frequency (MHz)	Polarization	FCC Max. Limit (dBm)	S.G Power (dBm)	Substitution Antenna Gain (dBi)	Cable Loss (dBm)	Peak Output Power (dBm)
2nd	1673.2	H	-13	-54.41	10.72	0.56	-44.25
3rd	2509.8	H	-13	-55.20	10.66	0.62	-45.16
4th	3346.4	H	-13	-55.08	10.78	0.74	-45.04
5th	4183.0	H	-13	*	*	*	*
6th	5019.6	H	-13	*	*	*	*
7th	5856.2	H	-13	*	*	*	*
8th	6692.8	H	-13	*	*	*	*
9th	7529.4	H	-13	*	*	*	*
10th	8366.0	H	-13	*	*	*	*

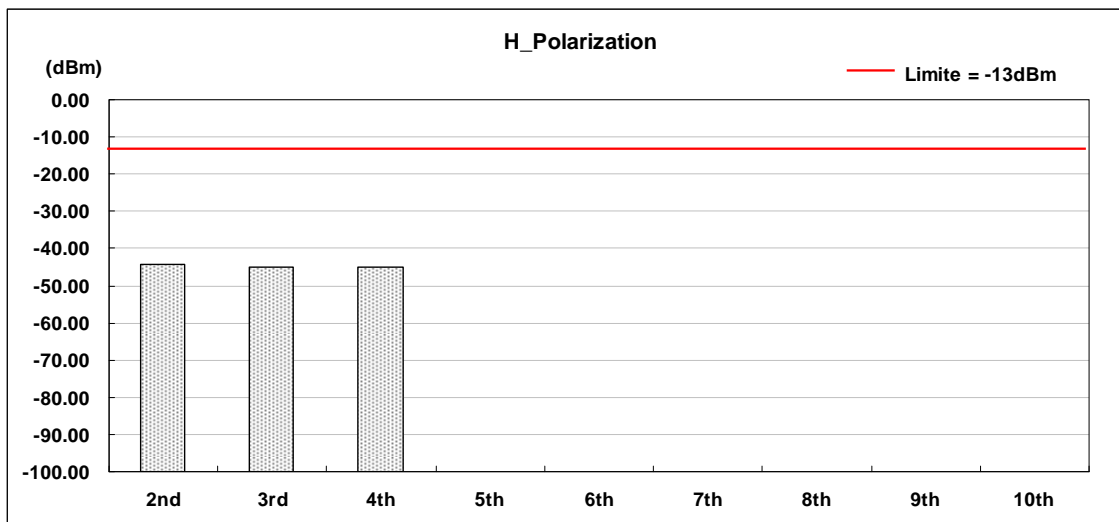

Product	Portable Terminal		
Test Item	Field Strength of Spurious Radiation		
Test Mode	Mode 1: GPRS850 Link / CH190	Polarization	Vertical
Date of Test	11/23/2009	Test Site	TE01

Harmonic	Frequency (MHz)	Polarization	FCC Max. Limit (dBm)	S.G Power (dBm)	Substitution Antenna Gain (dBi)	Cable Loss (dBm)	Peak Output Power (dBm)
2nd	1673.2	V	-13	-43.50	10.72	0.56	-33.34
3rd	2509.8	V	-13	-54.46	10.66	0.62	-44.42
4th	3346.4	V	-13	-55.04	10.78	0.74	-45.00
5th	4183.0	V	-13	*	*	*	*
6th	5019.6	V	-13	*	*	*	*
7th	5856.2	V	-13	*	*	*	*
8th	6692.8	V	-13	*	*	*	*
9th	7529.4	V	-13	*	*	*	*
10th	8366.0	V	-13	*	*	*	*

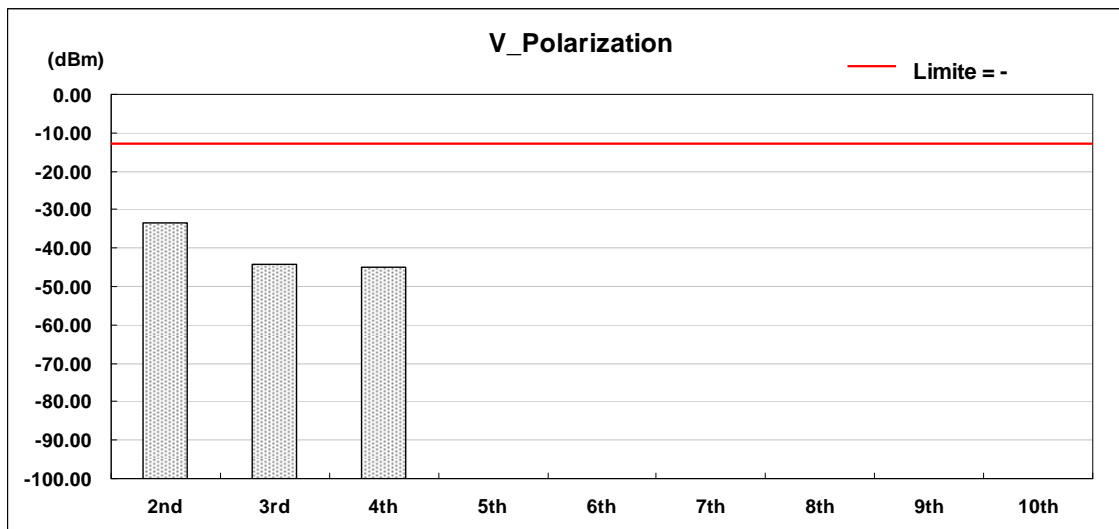

Product	Portable Terminal		
Test Item	Field Strength of Spurious Radiation		
Test Mode	Mode 1: GPRS850 Link / CH251	Polarization	Horizontal
Date of Test	11/23/2009	Test Site	TE01

Harmonic	Frequency (MHz)	Polarization	FCC Max. Limit (dBm)	S.G Power (dBm)	Substitution Antenna Gain (dBi)	Cable Loss (dBm)	Peak Output Power (dBm)
2nd	1697.6	H	-13	-52.61	10.72	0.56	-42.45
3rd	2546.4	H	-13	-53.20	10.66	0.62	-43.16
4th	3395.2	H	-13	-51.19	10.78	0.74	-41.15
5th	4244.0	H	-13	*	*	*	*
6th	5092.8	H	-13	*	*	*	*
7th	5941.6	H	-13	*	*	*	*
8th	6790.4	H	-13	*	*	*	*
9th	7639.2	H	-13	*	*	*	*
10th	8488.0	H	-13	*	*	*	*

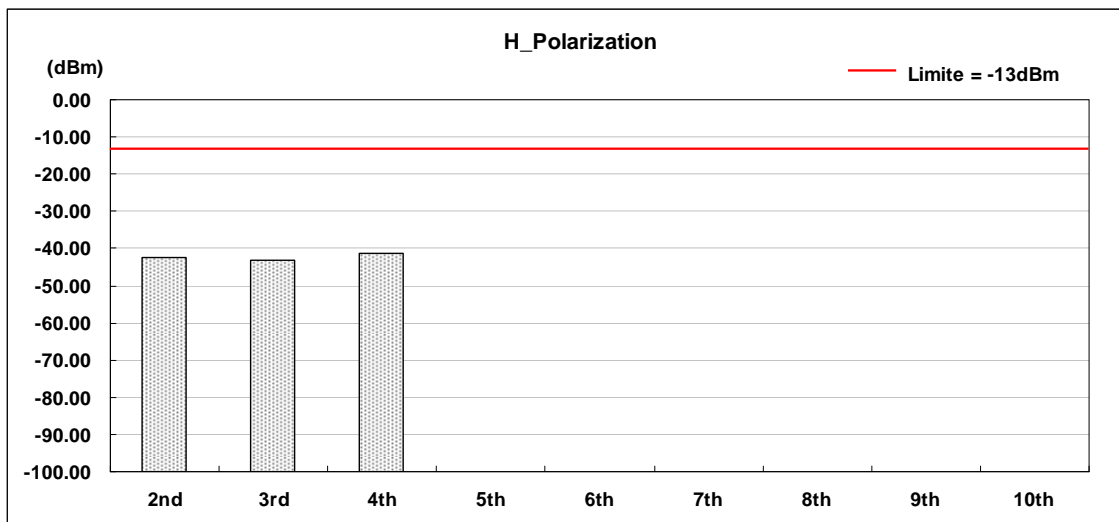

Product	Portable Terminal		
Test Item	Field Strength of Spurious Radiation		
Test Mode	Mode 1: GPRS850 Link / CH251	Polarization	Vertical
Date of Test	11/23/2009	Test Site	TE01

Harmonic	Frequency (MHz)	Polarization	FCC Max. Limit (dBm)	S.G Power (dBm)	Substitution Antenna Gain (dBi)	Cable Loss (dBm)	Peak Output Power (dBm)
2nd	1697.6	V	-13	-44.09	10.72	0.56	-33.93
3rd	2546.4	V	-13	-54.21	10.66	0.62	-44.17
4th	3395.2	V	-13	-55.09	10.78	0.74	-45.05
5th	4244.0	V	-13	*	*	*	*
6th	5092.8	V	-13	*	*	*	*
7th	5941.6	V	-13	*	*	*	*
8th	6790.4	V	-13	*	*	*	*
9th	7639.2	V	-13	*	*	*	*
10th	8488.0	V	-13	*	*	*	*

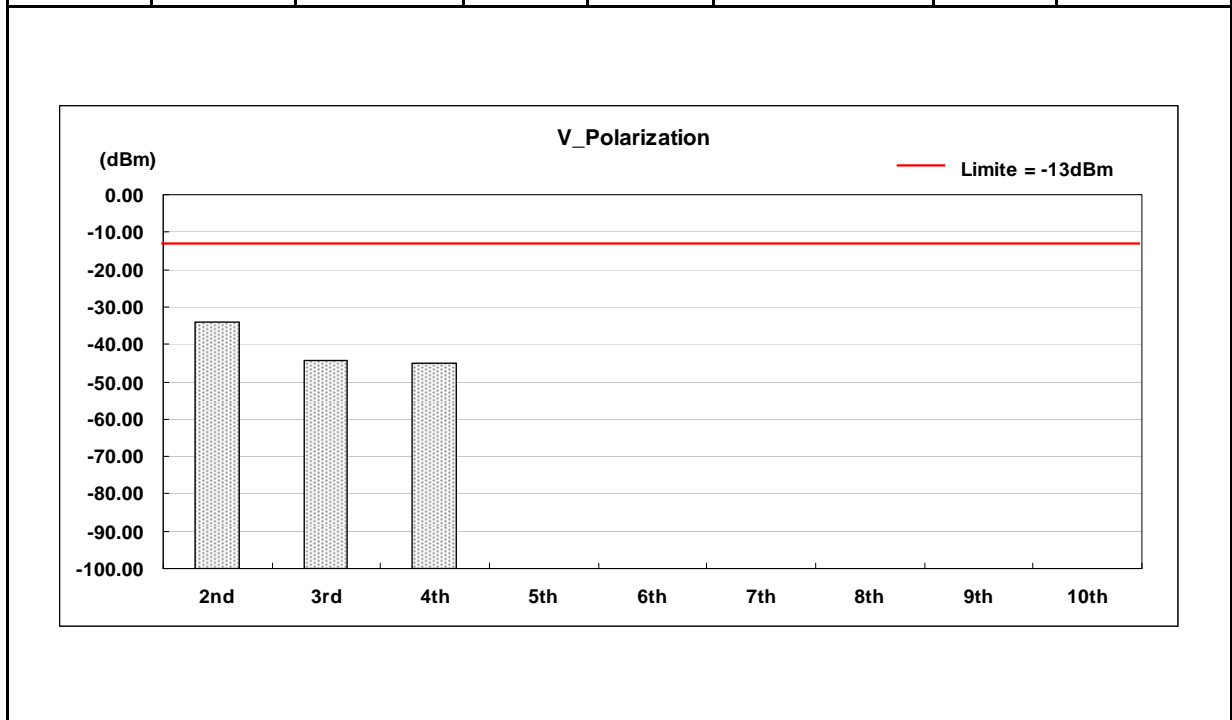

Product	Portable Terminal		
Test Item	Field Strength of Spurious Radiation		
Test Mode	Mode 2: GPRS1900 Link / CH512	Polarization	Horizontal
Date of Test	11/23/2009	Test Site	TE01

Harmonic	Frequency (MHz)	Polarization	FCC Max. Limit (dBm)	S.G Power (dBm)	Substitution Antenna Gain (dBi)	Cable Loss (dBm)	Peak Output Power (dBm)
2nd	3700.4	H	-13	-51.16	10.72	0.56	-41.00
3rd	5550.6	H	-13	-49.02	10.66	0.62	-38.98
4th	7400.8	H	-13	-43.29	10.78	0.74	-33.25
5th	9251.0	H	-13	*	*	*	*
6th	11101.2	H	-13	*	*	*	*
7th	12951.4	H	-13	*	*	*	*
8th	14801.6	H	-13	*	*	*	*
9th	16651.8	H	-13	*	*	*	*
10th	18502.0	H	-13	*	*	*	*

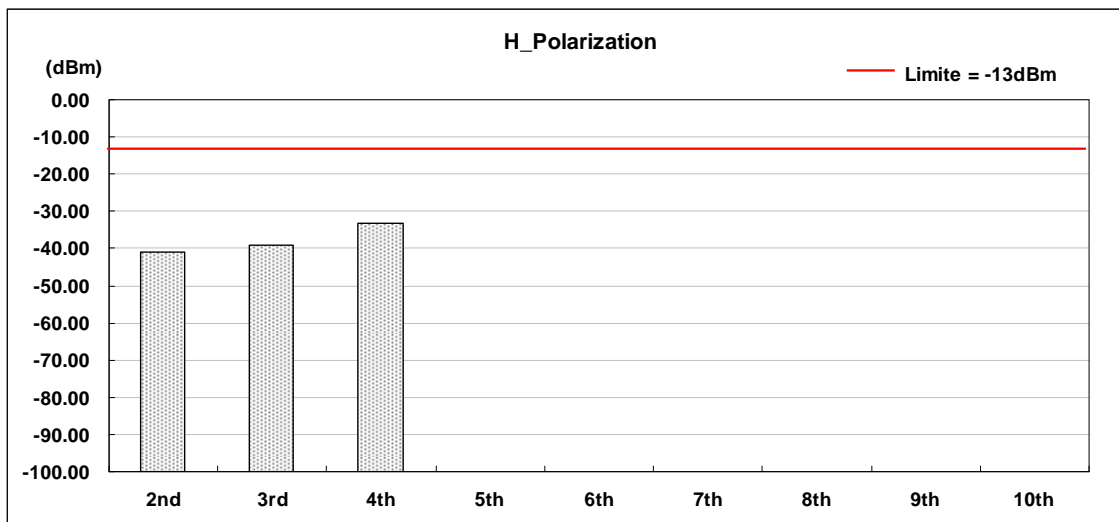

Product	Portable Terminal		
Test Item	Field Strength of Spurious Radiation		
Test Mode	Mode 2: GPRS1900 Link / CH512	Polarization	Vertical
Date of Test	11/23/2009	Test Site	TE01

Harmonic	Frequency (MHz)	Polarization	FCC Max. Limit (dBm)	S.G Power (dBm)	Substitution Antenna Gain (dBi)	Cable Loss (dBm)	Peak Output Power (dBm)
2nd	3700.4	V	-13	-51.53	10.72	0.56	-41.37
3rd	5550.6	V	-13	-48.51	10.66	0.62	-38.47
4th	7400.8	V	-13	-43.87	10.78	0.74	-33.83
5th	9251.0	V	-13	*	*	*	*
6th	11101.2	V	-13	*	*	*	*
7th	12951.4	V	-13	*	*	*	*
8th	14801.6	V	-13	*	*	*	*
9th	16651.8	V	-13	*	*	*	*
10th	18502.0	V	-13	*	*	*	*

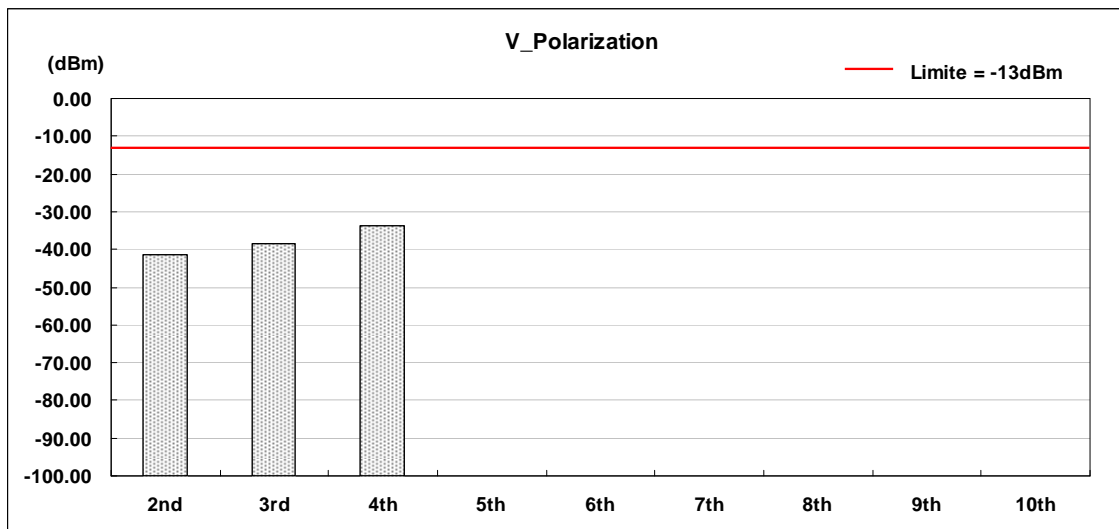

Product	Portable Terminal		
Test Item	Field Strength of Spurious Radiation		
Test Mode	Mode 2: GPRS1900 Link / CH661	Polarization	Horizontal
Date of Test	11/23/2009	Test Site	TE01

Harmonic	Frequency (MHz)	Polarization	FCC Max. Limit (dBm)	S.G Power (dBm)	Substitution Antenna Gain (dBi)	Cable Loss (dBm)	Peak Output Power (dBm)
2nd	3760.0	H	-13	-53.89	10.72	0.56	-43.73
3rd	5640.0	H	-13	-49.24	10.66	0.62	-39.20
4th	7520.0	H	-13	-42.70	10.78	0.74	-32.66
5th	9400.0	H	-13	*	*	*	*
6th	11280.0	H	-13	*	*	*	*
7th	13160.0	H	-13	*	*	*	*
8th	15040.0	H	-13	*	*	*	*
9th	16920.0	H	-13	*	*	*	*
10th	18800.0	H	-13	*	*	*	*

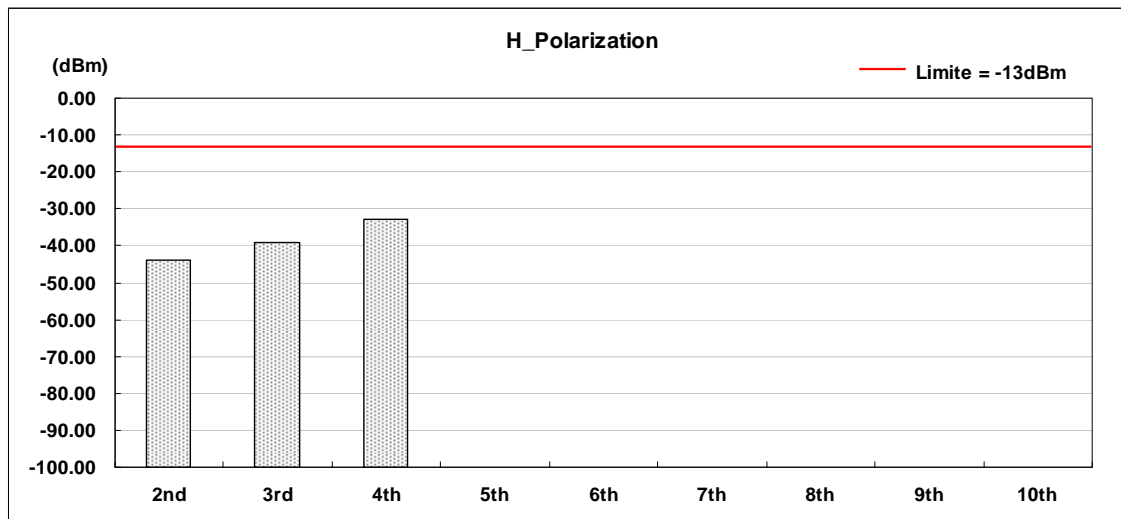

Product	Portable Terminal		
Test Item	Field Strength of Spurious Radiation		
Test Mode	Mode 2: GPRS1900 Link / CH661	Polarization	Vertical
Date of Test	11/23/2009	Test Site	TE01

Harmonic	Frequency (MHz)	Polarization	FCC Max. Limit (dBm)	S.G Power (dBm)	Substitution Antenna Gain (dBi)	Cable Loss (dBm)	Peak Output Power (dBm)
2nd	3760.0	V	-13	-53.47	10.72	0.56	-43.31
3rd	5640.0	V	-13	-49.47	10.66	0.62	-39.43
4th	7520.0	V	-13	-43.33	10.78	0.74	-33.29
5th	9400.0	V	-13	*	*	*	*
6th	11280.0	V	-13	*	*	*	*
7th	13160.0	V	-13	*	*	*	*
8th	15040.0	V	-13	*	*	*	*
9th	16920.0	V	-13	*	*	*	*
10th	18800.0	V	-13	*	*	*	*

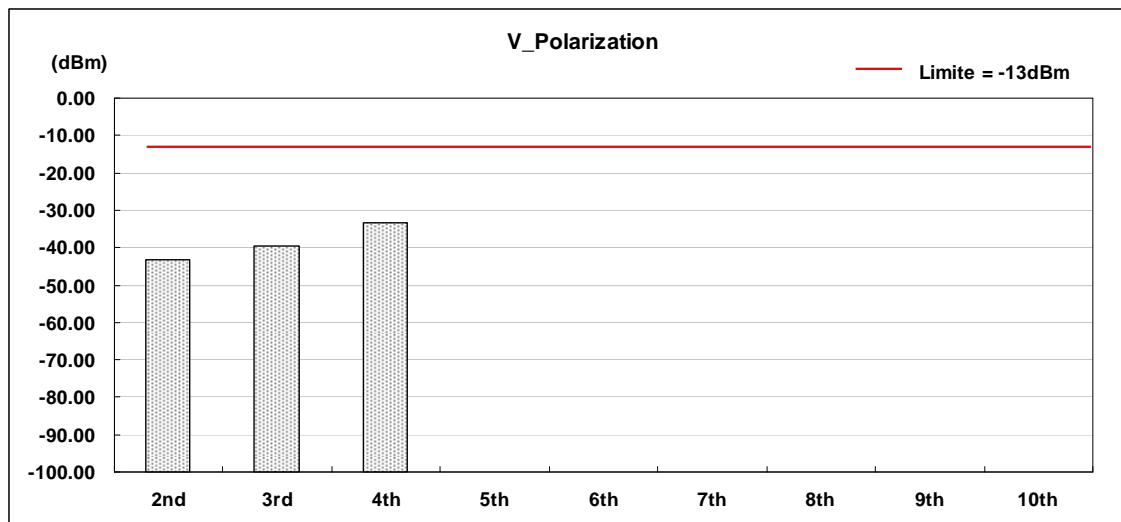

Product	Portable Terminal		
Test Item	Field Strength of Spurious Radiation		
Test Mode	Mode 2: GPRS1900 Link / CH810	Polarization	Horizontal
Date of Test	11/23/2009	Test Site	TE01

Harmonic	Frequency (MHz)	Polarization	FCC Max. Limit (dBm)	S.G Power (dBm)	Substitution Antenna Gain (dBi)	Cable Loss (dBm)	Peak Output Power (dBm)
2nd	3819.6	H	-13	-51.92	10.72	0.56	-41.76
3rd	5729.4	H	-13	-49.97	10.66	0.62	-39.93
4th	7639.2	H	-13	-43.33	10.78	0.74	-33.29
5th	9549.0	H	-13	*	*	*	*
6th	11458.8	H	-13	*	*	*	*
7th	13368.6	H	-13	*	*	*	*
8th	15278.4	H	-13	*	*	*	*
9th	17188.2	H	-13	*	*	*	*
10th	19098.0	H	-13	*	*	*	*

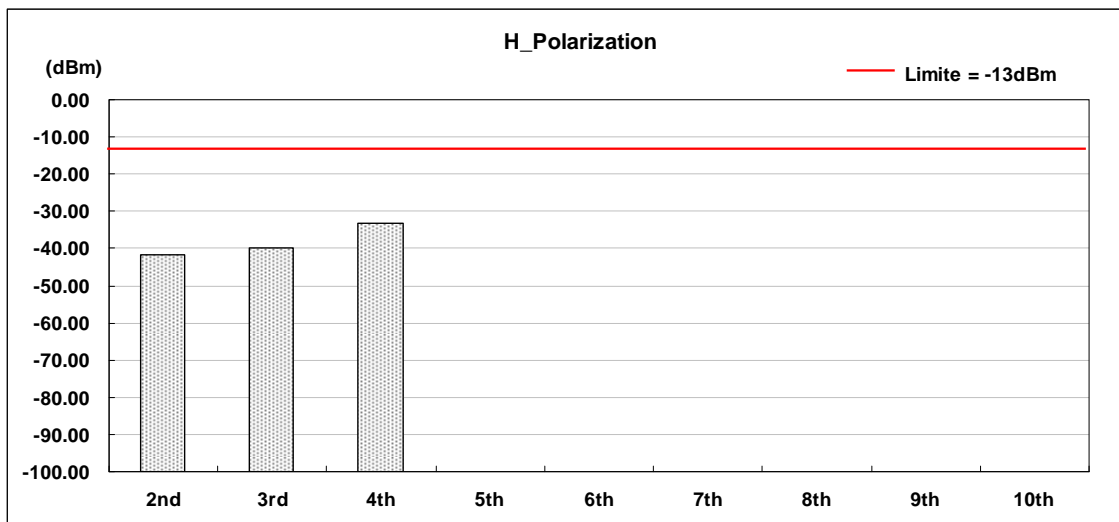

Product	Portable Terminal		
Test Item	Field Strength of Spurious Radiation		
Test Mode	Mode 2: GPRS1900 Link / CH810	Polarization	Vertical
Date of Test	11/23/2009	Test Site	TE01

Harmonic	Frequency (MHz)	Polarization	FCC Max. Limit (dBm)	S.G Power (dBm)	Substitution Antenna Gain (dBi)	Cable Loss (dBm)	Peak Output Power (dBm)
2nd	3819.6	V	-13	-51.43	10.72	0.56	-41.27
3rd	5729.4	V	-13	-49.27	10.66	0.62	-39.23
4th	7639.2	V	-13	-43.21	10.78	0.74	-33.17
5th	9549.0	V	-13	*	*	*	*
6th	11458.8	V	-13	*	*	*	*
7th	13368.6	V	-13	*	*	*	*
8th	15278.4	V	-13	*	*	*	*
9th	17188.2	V	-13	*	*	*	*
10th	19098.0	V	-13	*	*	*	*

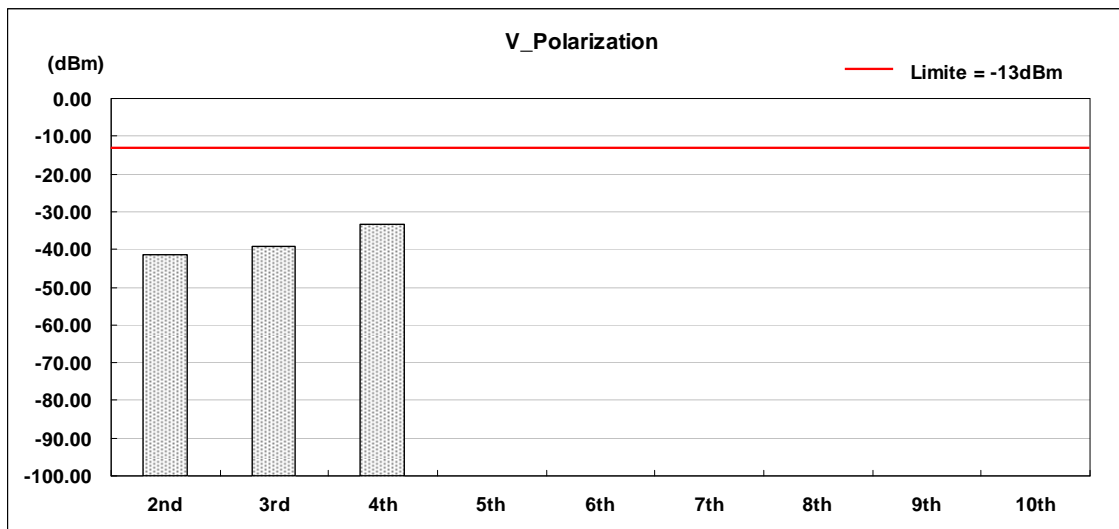

Product	Portable Terminal		
Test Item	Field Strength of Spurious Radiation		
Test Mode	Mode 5: WCDMA Band II Link / CH9262	Polarization	Horizontal
Date of Test	11/23/2009	Test Site	TE01

Harmonic	Frequency (MHz)	Polarization	FCC Max. Limit (dBm)	S.G Power (dBm)	Substitution Antenna Gain (dBi)	Cable Loss (dBm)	Peak Output Power (dBm)
2nd	3704.8	H	-13	-50.15	10.79	0.58	-39.94
3rd	5557.2	H	-13	-48.89	10.71	0.63	-38.81
4th	7409.6	H	-13	-43.66	10.81	0.78	-33.63
5th	9262.0	H	-13	*	*	*	*
6th	11114.4	H	-13	*	*	*	*
7th	12966.8	H	-13	*	*	*	*
8th	14819.2	H	-13	*	*	*	*
9th	16671.6	H	-13	*	*	*	*
10th	18524.0	H	-13	*	*	*	*

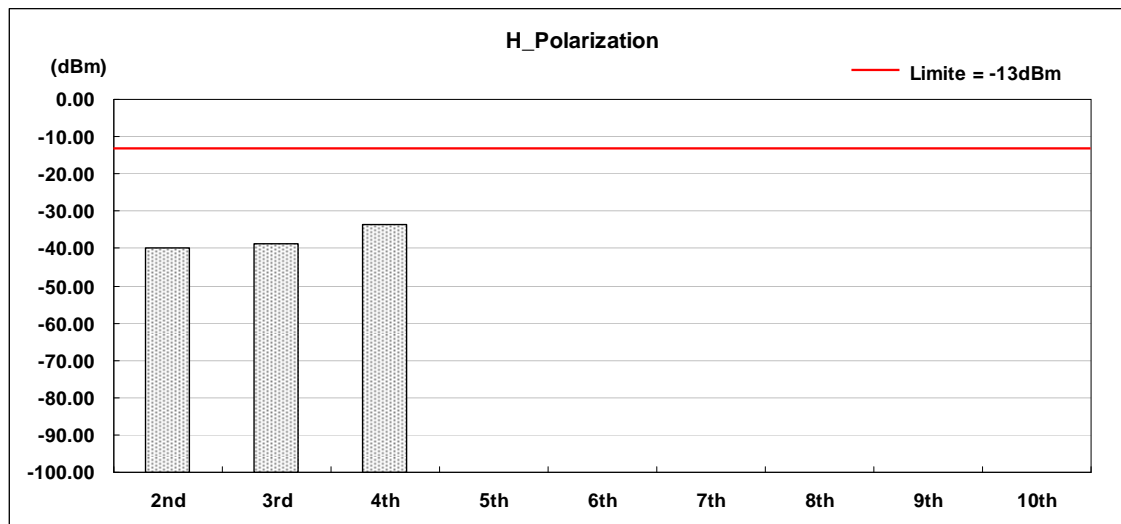

Product	Portable Terminal		
Test Item	Field Strength of Spurious Radiation		
Test Mode	Mode 5: WCDMA Band II Link / CH9262	Polarization	Vertical
Date of Test	11/23/2009	Test Site	TE01

Harmonic	Frequency (MHz)	Polarization	FCC Max. Limit (dBm)	S.G Power (dBm)	Substitution Antenna Gain (dBi)	Cable Loss (dBm)	Peak Output Power (dBm)
2nd	3704.8	V	-13	-52.34	10.79	0.58	-42.13
3rd	5557.2	V	-13	-49.38	10.71	0.63	-39.30
4th	7409.6	V	-13	-43.16	10.81	0.78	-33.13
5th	9262.0	V	-13	*	*	*	*
6th	11114.4	V	-13	*	*	*	*
7th	12966.8	V	-13	*	*	*	*
8th	14819.2	V	-13	*	*	*	*
9th	16671.6	V	-13	*	*	*	*
10th	18524.0	V	-13	*	*	*	*

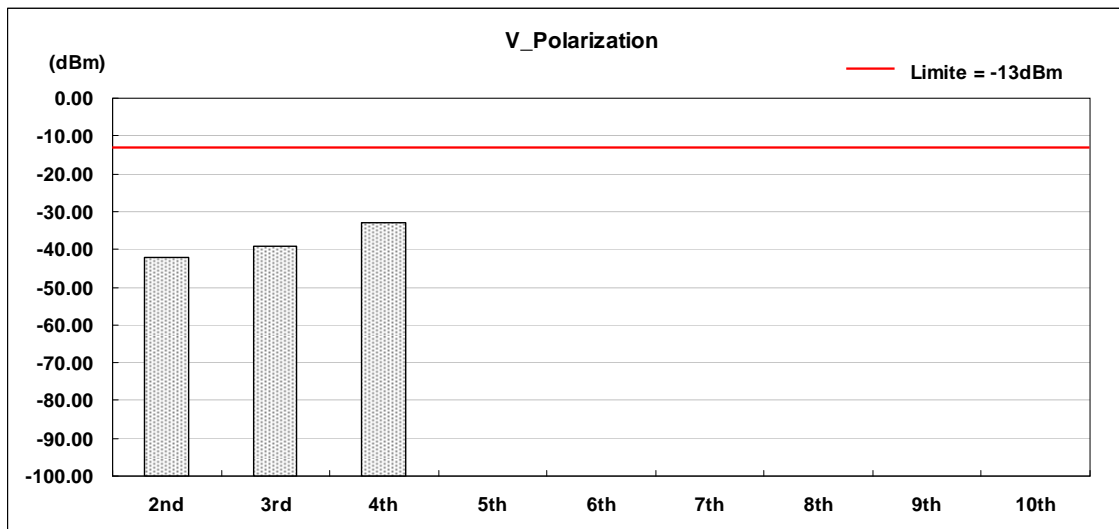

Product	Portable Terminal		
Test Item	Field Strength of Spurious Radiation		
Test Mode	Mode 5: WCDMA Band II Link / CH9400	Polarization	Horizontal
Date of Test	11/23/2009	Test Site	TE01

Harmonic	Frequency (MHz)	Polarization	FCC Max. Limit (dBm)	S.G Power (dBm)	Substitution Antenna Gain (dBi)	Cable Loss (dBm)	Peak Output Power (dBm)
2nd	3760.0	H	-13	-37.96	10.79	0.58	-27.75
3rd	5640.0	H	-13	-50.06	10.71	0.63	-39.98
4th	7520.0	H	-13	-43.99	10.81	0.78	-33.96
5th	9400.0	H	-13	*	*	*	*
6th	11280.0	H	-13	*	*	*	*
7th	13160.0	H	-13	*	*	*	*
8th	15040.0	H	-13	*	*	*	*
9th	16920.0	H	-13	*	*	*	*
10th	18800.0	H	-13	*	*	*	*

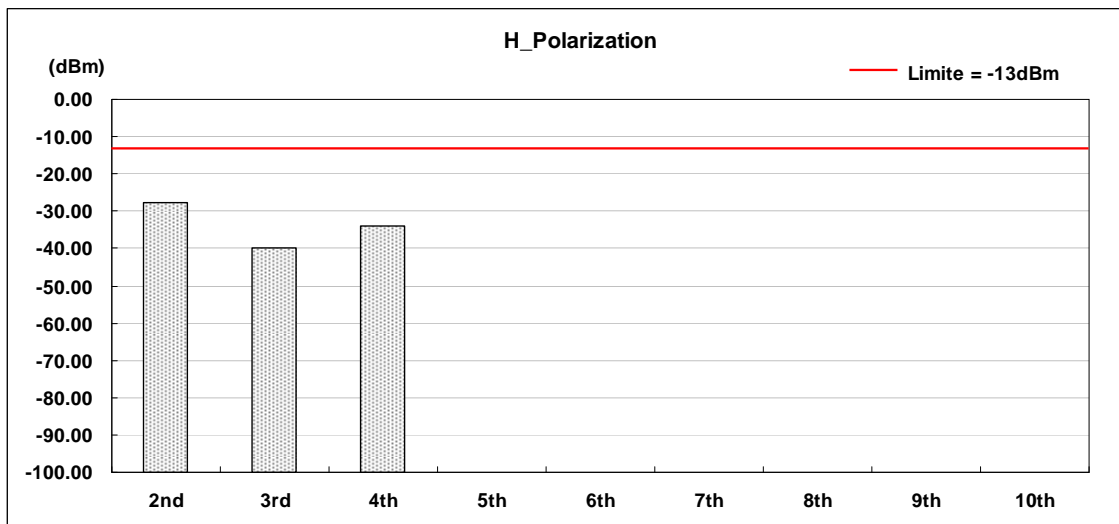

Product	Portable Terminal		
Test Item	Field Strength of Spurious Radiation		
Test Mode	Mode 5: WCDMA Band II Link / CH9400	Polarization	Vertical
Date of Test	11/23/2009	Test Site	TE01

Harmonic	Frequency (MHz)	Polarization	FCC Max. Limit (dBm)	S.G Power (dBm)	Substitution Antenna Gain (dBi)	Cable Loss (dBm)	Peak Output Power (dBm)
2nd	3760.0	V	-13	-42.67	10.79	0.58	-32.46
3rd	5640.0	V	-13	-50.09	10.71	0.63	-40.01
4th	7520.0	V	-13	-44.42	10.81	0.78	-34.39
5th	9400.0	V	-13	*	*	*	*
6th	11280.0	V	-13	*	*	*	*
7th	13160.0	V	-13	*	*	*	*
8th	15040.0	V	-13	*	*	*	*
9th	16920.0	V	-13	*	*	*	*
10th	18800.0	V	-13	*	*	*	*

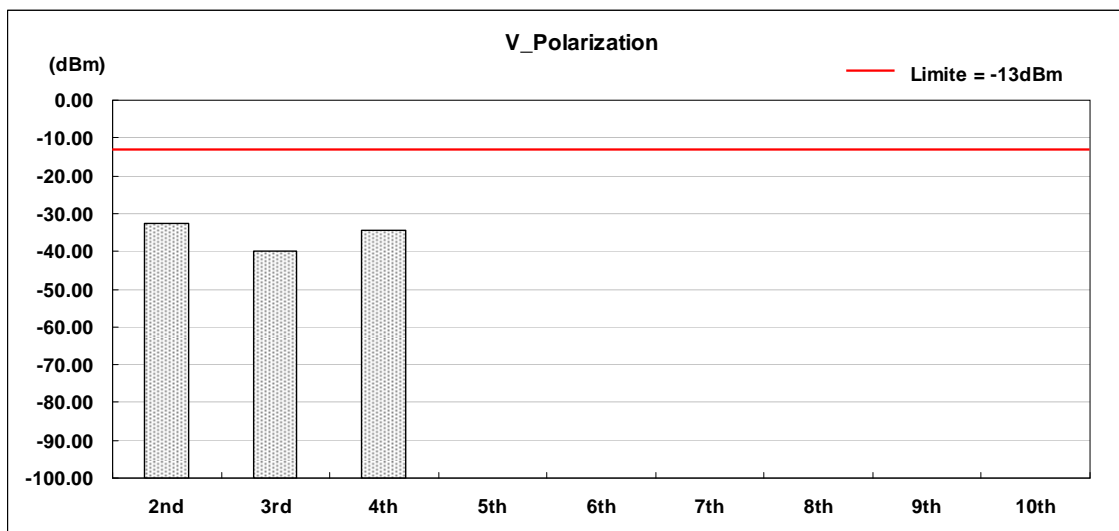

Product	Portable Terminal		
Test Item	Field Strength of Spurious Radiation		
Test Mode	Mode 5: WCDMA Band II Link / CH9538	Polarization	Horizontal
Date of Test	11/23/2009	Test Site	TE01

Harmonic	Frequency (MHz)	Polarization	FCC Max. Limit (dBm)	S.G Power (dBm)	Substitution Antenna Gain (dBi)	Cable Loss (dBm)	Peak Output Power (dBm)
2nd	3815.2	H	-13	-38.77	10.79	0.58	-28.56
3rd	5722.8	H	-13	-49.61	10.71	0.63	-39.53
4th	7630.4	H	-13	-43.21	10.81	0.78	-33.18
5th	9538.0	H	-13	*	*	*	*
6th	11445.6	H	-13	*	*	*	*
7th	13353.2	H	-13	*	*	*	*
8th	15260.8	H	-13	*	*	*	*
9th	17168.4	H	-13	*	*	*	*
10th	19076.0	H	-13	*	*	*	*

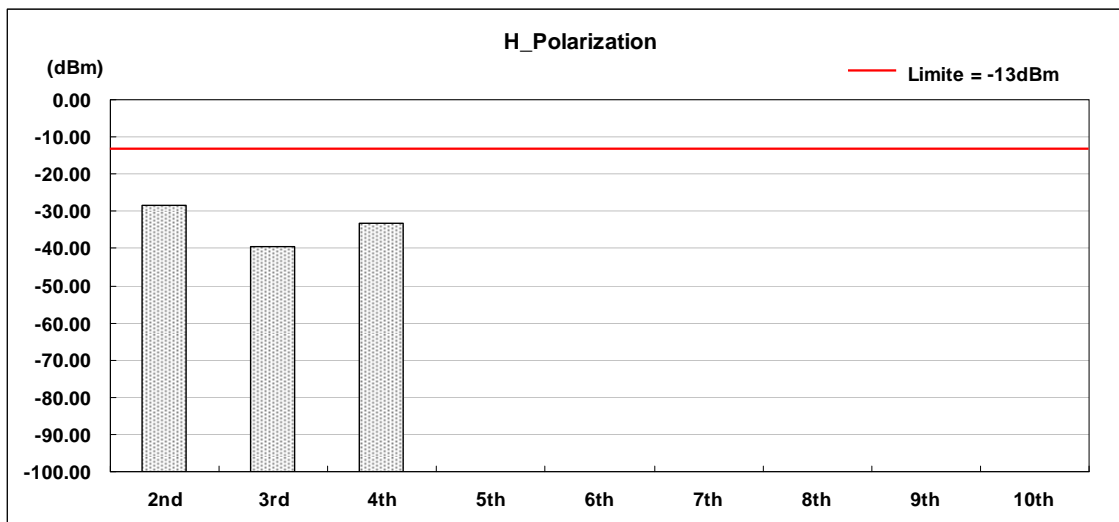

Product	Portable Terminal		
Test Item	Field Strength of Spurious Radiation		
Test Mode	Mode 5: WCDMA Band II Link / CH9538	Polarization	Vertical
Date of Test	11/23/2009	Test Site	TE01

Harmonic	Frequency (MHz)	Polarization	FCC Max. Limit (dBm)	S.G Power (dBm)	Substitution Antenna Gain (dBi)	Cable Loss (dBm)	Peak Output Power (dBm)
2nd	3815.2	V	-13	-42.51	10.79	0.58	-32.30
3rd	5722.8	V	-13	-50.22	10.71	0.63	-40.14
4th	7630.4	V	-13	-42.46	10.81	0.78	-32.43
5th	9538.0	V	-13	*	*	*	*
6th	11445.6	V	-13	*	*	*	*
7th	13353.2	V	-13	*	*	*	*
8th	15260.8	V	-13	*	*	*	*
9th	17168.4	V	-13	*	*	*	*
10th	19076.0	V	-13	*	*	*	*

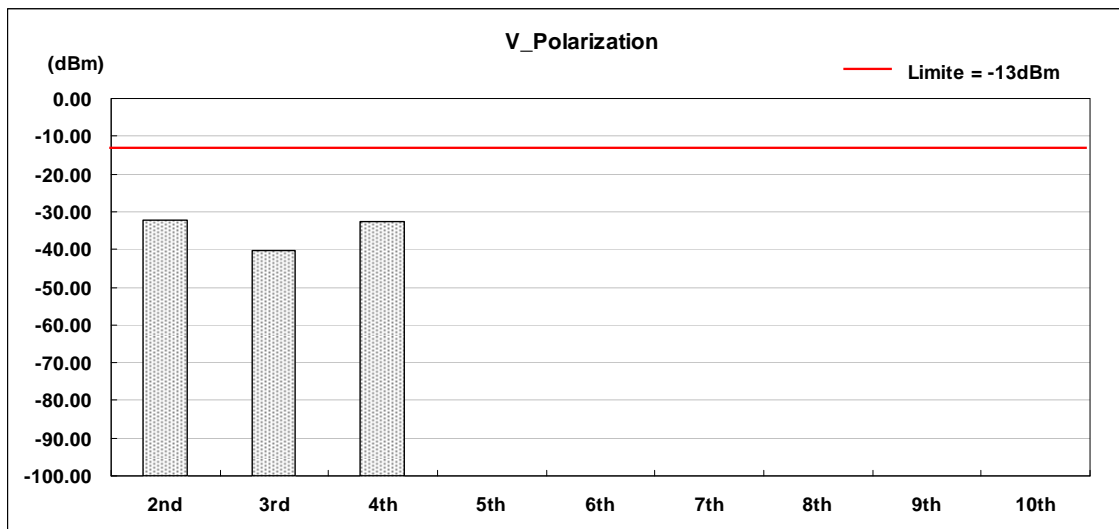

Product	Portable Terminal		
Test Item	Field Strength of Spurious Radiation		
Test Mode	Mode 6: WCDMA Band V Link / CH4132	Polarization	Horizontal
Date of Test	11/23/2009	Test Site	TE01

Harmonic	Frequency (MHz)	Polarization	FCC Max. Limit (dBm)	S.G Power (dBm)	Substitution Antenna Gain (dBi)	Cable Loss (dBm)	Peak Output Power (dBm)
2nd	1652.8	H	-13	-57.13	10.74	0.59	-46.98
3rd	2479.2	H	-13	-56.65	10.68	0.63	-46.60
4th	3305.6	H	-13	-54.99	10.80	0.78	-44.97
5th	4132.0	H	-13	*	*	*	*
6th	4958.4	H	-13	*	*	*	*
7th	5784.8	H	-13	*	*	*	*
8th	6611.2	H	-13	*	*	*	*
9th	7437.6	H	-13	*	*	*	*
10th	8264.0	H	-13	*	*	*	*

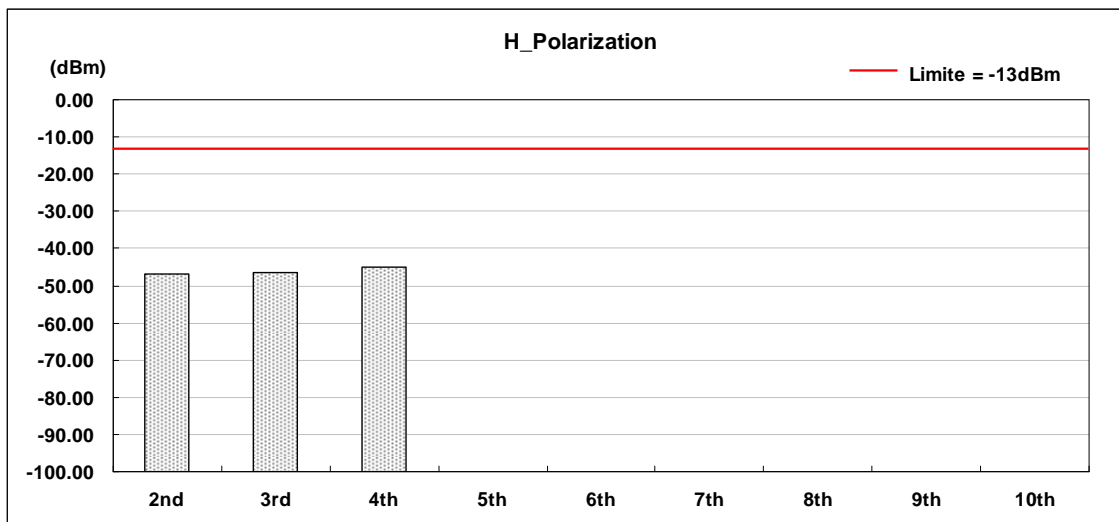

Product	Portable Terminal		
Test Item	Field Strength of Spurious Radiation		
Test Mode	Mode 6: WCDMA Band V Link / CH4132	Polarization	Vertical
Date of Test	11/23/2009	Test Site	TE01

Harmonic	Frequency (MHz)	Polarization	FCC Max. Limit (dBm)	S.G Power (dBm)	Substitution Antenna Gain (dBi)	Cable Loss (dBm)	Peak Output Power (dBm)
2nd	1652.8	V	-13	-55.07	10.74	0.59	-44.92
3rd	2479.2	V	-13	-57.22	10.68	0.63	-47.17
4th	3305.6	V	-13	-54.94	10.80	0.78	-44.92
5th	4132.0	V	-13	*	*	*	*
6th	4958.4	V	-13	*	*	*	*
7th	5784.8	V	-13	*	*	*	*
8th	6611.2	V	-13	*	*	*	*
9th	7437.6	V	-13	*	*	*	*
10th	8264.0	V	-13	*	*	*	*

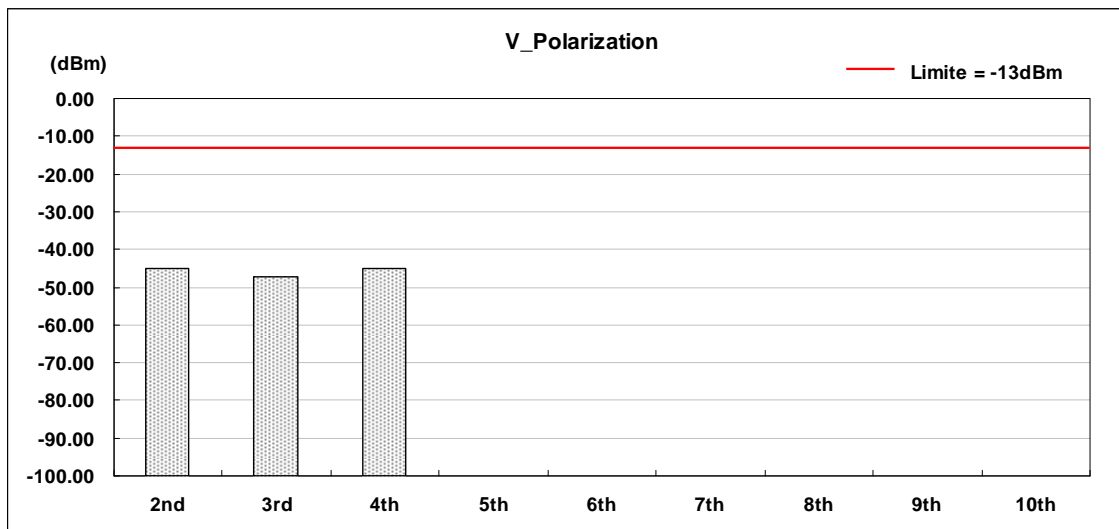

Product	Portable Terminal		
Test Item	Field Strength of Spurious Radiation		
Test Mode	Mode 6: WCDMA Band V Link / CH4183	Polarization	Horizontal
Date of Test	11/23/2009	Test Site	TE01

Harmonic	Frequency (MHz)	Polarization	FCC Max. Limit (dBm)	S.G Power (dBm)	Substitution Antenna Gain (dBi)	Cable Loss (dBm)	Peak Output Power (dBm)
2nd	1673.2	H	-13	-58.19	10.74	0.59	-48.04
3rd	2509.8	H	-13	-56.39	10.68	0.63	-46.34
4th	3346.4	H	-13	-54.72	10.80	0.78	-44.70
5th	4183.0	H	-13	*	*	*	*
6th	5019.6	H	-13	*	*	*	*
7th	5856.2	H	-13	*	*	*	*
8th	6692.8	H	-13	*	*	*	*
9th	7529.4	H	-13	*	*	*	*
10th	8366.0	H	-13	*	*	*	*

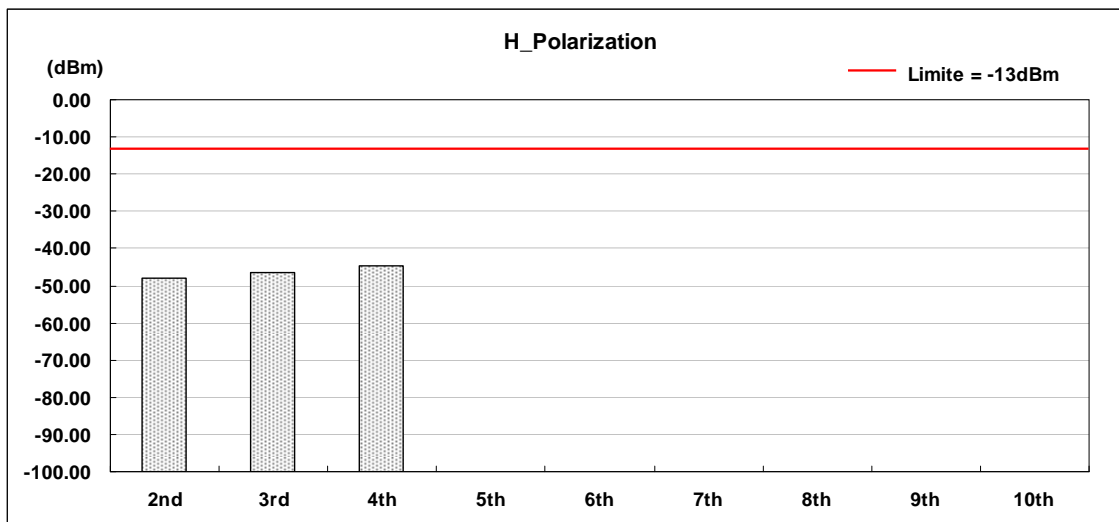

Product	Portable Terminal		
Test Item	Field Strength of Spurious Radiation		
Test Mode	Mode 6: WCDMA Band V Link / CH4183	Polarization	Vertical
Date of Test	11/23/2009	Test Site	TE01

Harmonic	Frequency (MHz)	Polarization	FCC Max. Limit (dBm)	S.G Power (dBm)	Substitution Antenna Gain (dBi)	Cable Loss (dBm)	Peak Output Power (dBm)
2nd	1673.2	V	-13	-56.76	10.74	0.59	-46.61
3rd	2509.8	V	-13	-56.53	10.68	0.63	-46.48
4th	3346.4	V	-13	-54.58	10.80	0.78	-44.56
5th	4183.0	V	-13	*	*	*	*
6th	5019.6	V	-13	*	*	*	*
7th	5856.2	V	-13	*	*	*	*
8th	6692.8	V	-13	*	*	*	*
9th	7529.4	V	-13	*	*	*	*
10th	8366.0	V	-13	*	*	*	*

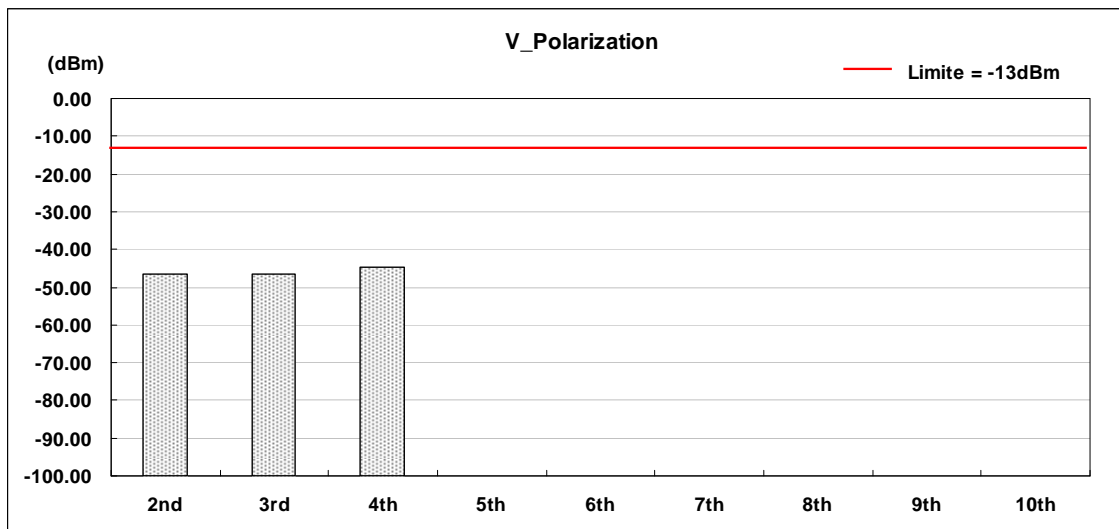

Product	Portable Terminal		
Test Item	Field Strength of Spurious Radiation		
Test Mode	Mode 6: WCDMA Band V Link / CH4233	Polarization	Horizontal
Date of Test	11/23/2009	Test Site	TE01

Harmonic	Frequency (MHz)	Polarization	FCC Max. Limit (dBm)	S.G Power (dBm)	Substitution Antenna Gain (dBi)	Cable Loss (dBm)	Peak Output Power (dBm)
2nd	1693.2	H	-13	-57.97	10.74	0.59	-47.82
3rd	2539.8	H	-13	-56.32	10.68	0.63	-46.27
4th	3386.4	H	-13	-54.78	10.80	0.78	-44.76
5th	4233.0	H	-13	*	*	*	*
6th	5079.6	H	-13	*	*	*	*
7th	5926.2	H	-13	*	*	*	*
8th	6772.8	H	-13	*	*	*	*
9th	7619.4	H	-13	*	*	*	*
10th	8466.0	H	-13	*	*	*	*

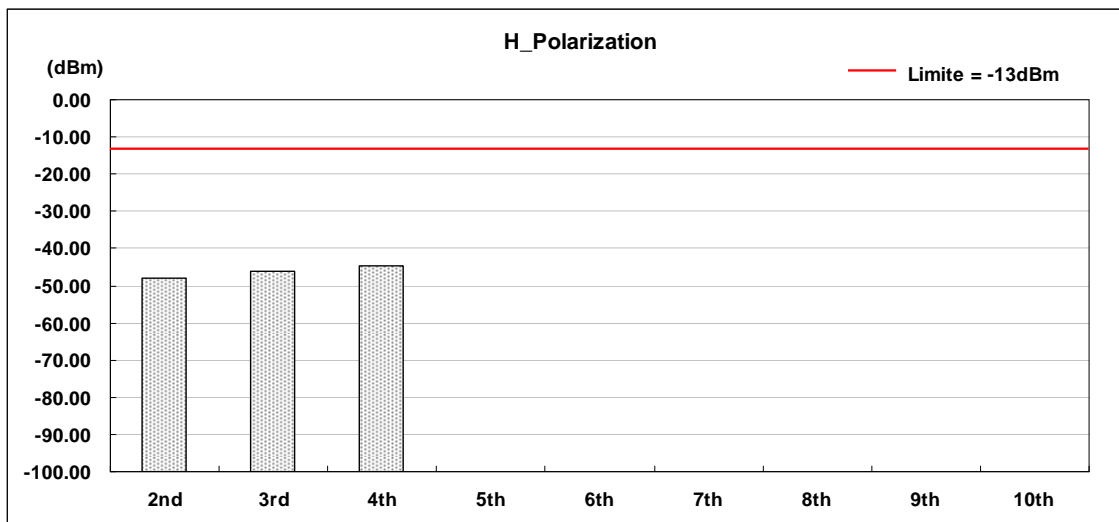

Product	Portable Terminal		
Test Item	Field Strength of Spurious Radiation		
Test Mode	Mode 6: WCDMA Band V Link / CH4233	Polarization	Vertical
Date of Test	11/23/2009	Test Site	TE01

Harmonic	Frequency (MHz)	Polarization	FCC Max. Limit (dBm)	S.G Power (dBm)	Substitution Antenna Gain (dBi)	Cable Loss (dBm)	Peak Output Power (dBm)
2nd	1693.2	V	-13	-58.15	10.74	0.59	-48.00
3rd	2539.8	V	-13	-54.67	10.68	0.63	-44.62
4th	3386.4	V	-13	-55.12	10.80	0.78	-45.10
5th	4233.0	V	-13	*	*	*	*
6th	5079.6	V	-13	*	*	*	*
7th	5926.2	V	-13	*	*	*	*
8th	6772.8	V	-13	*	*	*	*
9th	7619.4	V	-13	*	*	*	*
10th	8466.0	V	-13	*	*	*	*

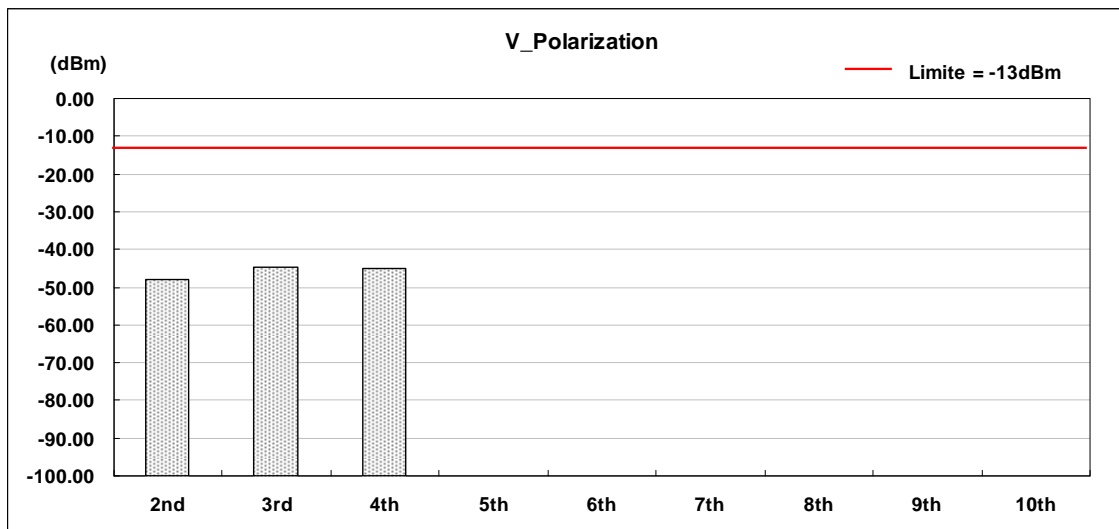

6.7. Test Photograph

Description : Front View of Field Strength of Spurious Radiation Test
Below 1GHz



Description : Back View of Field Strength of Spurious Radiation Test
Below 1GHz



Description : Front View of Field Strength of Spurious Radiation Test
Above 1GHz



Description : Back View of Field Strength of Spurious Radiation Test
Above 1GHz



7 Frequency Stability (Temperature Variation) Test

7.1. Limit

The frequency stability shall be measured by variation of ambient temperature and variation of primary supply voltage to ensure that the fundamental emission stays within the authorized frequency block.

The frequency stability of the transmitter shall be maintained within $\pm 0.00025\%$ ($\pm 2.5\text{ppm}$) of the center frequency.

7.2. Test Instruments

Describe	Manufacturer	Model No.	Serial No.	Cal. Date
Universal Radio Communication Tester	ROHDE & SCHWARZ	CMU200	109369	07/29/2009
Test Site	ATL	TE02	TE02	N.C.R.

NOTE: N.C.R. = No Calibration Request.

7.3. Setup

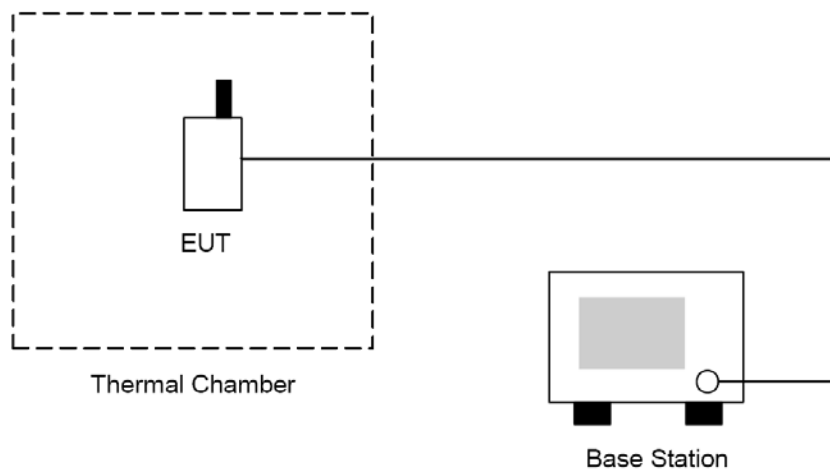

7.4. Test Procedure

The measurement is made according to FCC rules part 22 and 24:

1. The EUT and test equipment were set up as shown on the following section.
2. With all power removed, the temperature was decreased to -30°C and permitted to stabilize for three hours. Power was applied and the maximum change in frequency was note within one minute.
3. With power OFF, the temperature was raised in 10°C steps. The sample was permitted to stabilize at each step for at least one-half hour. Power was applied and the maximum frequency change was noted within one minute.
4. The temperature tests were performed for the worst case.
5. Test data was recorded.

7.5. Uncertainty

The measurement uncertainty is defined as for Frequency Stability (Temperature Variation) measurement is $\pm 10\text{Hz}$.

7.6. Test Result

Product	Portable Terminal		
Test Item	Frequency Stability (Temperature Variation)		
Test Mode	Mode 1: GPRS850 Link		
Date of Test	11/23/2009	Test Site	TE02

Temperature (°C)	Deviation (Hz)	Deviation (ppm)	Limit (ppm)	Result
-30	20.44	0.024	±2.5	Pass
-20	20.39	0.024	±2.5	Pass
-10	18.48	0.022	±2.5	Pass
0	19.72	0.024	±2.5	Pass
10	19.39	0.023	±2.5	Pass
20	20.44	0.024	±2.5	Pass
30	18.44	0.022	±2.5	Pass
40	23.48	0.028	±2.5	Pass
50	21.77	0.026	0.1	Pass

Product	Portable Terminal		
Test Item	Frequency Stability (Temperature Variation)		
Test Mode	Mode 2: GPRS1900 Link		
Date of Test	11/23/2009	Test Site	TE02

Temperature (°C)	Deviation (Hz)	Deviation (ppm)	Limit (ppm)	Result
-30	19.38	0.010	±2.5	Pass
-20	19.77	0.011	±2.5	Pass
-10	20.46	0.011	±2.5	Pass
0	20.43	0.011	±2.5	Pass
10	17.69	0.009	±2.5	Pass
20	17.27	0.009	±2.5	Pass
30	16.48	0.009	±2.5	Pass
40	16.22	0.009	±2.5	Pass
50	18.35	0.010	0.1	Pass

Product	Portable Terminal		
Test Item	Frequency Stability (Temperature Variation)		
Test Mode	Mode 5: WCDMA Band II Link		
Date of Test	11/23/2009	Test Site	TE02

Temperature (°C)	Deviation (Hz)	Deviation (ppm)	Limit (ppm)	Result
-30	24.12	0.013	±2.5	Pass
-20	20.58	0.011	±2.5	Pass
-10	18.35	0.010	±2.5	Pass
0	19.51	0.010	±2.5	Pass
10	15.15	0.008	±2.5	Pass
20	16.97	0.009	±2.5	Pass
30	16.83	0.009	±2.5	Pass
40	16.74	0.009	±2.5	Pass
50	20.85	0.011	0.1	Pass

Product	Portable Terminal		
Test Item	Frequency Stability (Temperature Variation)		
Test Mode	Mode 6: WCDMA Band V Link		
Date of Test	11/23/2009	Test Site	TE02

Temperature (°C)	Deviation (Hz)	Deviation (ppm)	Limit (ppm)	Result
-30	32.47	0.039	±2.5	Pass
-20	31.69	0.038	±2.5	Pass
-10	30.28	0.036	±2.5	Pass
0	28.75	0.034	±2.5	Pass
10	24.72	0.030	±2.5	Pass
20	22.51	0.027	±2.5	Pass
30	23.84	0.029	±2.5	Pass
40	23.23	0.028	±2.5	Pass
50	21.75	0.026	0.1	Pass

8 Frequency Stability (Voltage Variation) Test

8.1. Limit

The frequency stability shall be measured by variation of ambient temperature and variation of primary supply voltage to ensure that the fundamental emission stays within the authorized frequency block.

The frequency stability of the transmitter shall be maintained within $\pm 0.00025\%$ ($\pm 2.5\text{ppm}$) of the center frequency.

8.2. Test Instruments

Describe	Manufacturer	Model No.	Serial No.	Cal. Date
Universal Radio Communication Tester	ROHDE & SCHWARZ	CMU200	109369	07/29/2009
Test Site	ATL	TE02	TE02	N.C.R.

NOTE: N.C.R. = No Calibration Request.

8.3. Setup

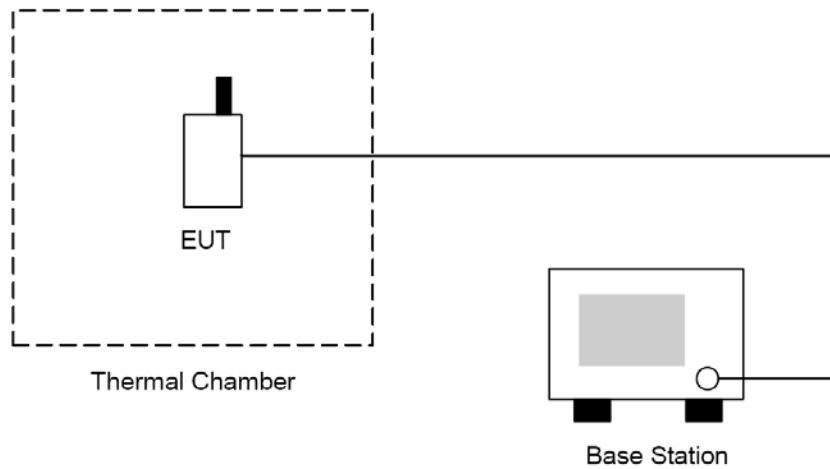

8.4. Test Procedure

1. The EUT was placed in a temperature chamber at 25 ± 5 °C and connected as the following section.
2. The power supply voltage to the EUT was varied from BEP to 115% of the nominal value measured at the input to the EUT.
3. The variation in frequency was measured for the worst case.

8.5. Uncertainty

The measurement uncertainty is defined as for Frequency Stability (Voltage Variation) measurement is ± 10 Hz.

8.6. Test Result

Product	Portable Terminal				
Test Item	Frequency Stability (Voltage Variation)				
Test Mode	Mode 1: GPRS850 Link				
Date of Test	11/23/2009	Test Site		TE02	
Level	Voltage [V]	Deviation [Hz]	Deviation [ppm]	Limit [ppm]	Result
Battery full point	8.40	21.79	0.026	±2.5	Pass
Normal	7.40	24.38	0.029	±2.5	Pass
Battery cut-off point	6.80	23.77	0.028	±2.5	Pass

Product	Portable Terminal				
Test Item	Frequency Stability (Voltage Variation)				
Test Mode	Mode 2: GPRS1900 Link				
Date of Test	11/23/2009	Test Site		TE02	
Level	Voltage [V]	Deviation [Hz]	Deviation [ppm]	Limit [ppm]	Result
Battery full point	8.40	21.45	0.011	±2.5	Pass
Normal	7.40	24.72	0.013	±2.5	Pass
Battery cut-off point	6.80	23.58	0.013	±2.5	Pass

Product	Portable Terminal				
Test Item	Frequency Stability (Voltage Variation)				
Test Mode	Mode 5: WCDMA Band II Link				
Date of Test	11/23/2009	Test Site		TE02	
Level	Voltage [V]	Deviation [Hz]	Deviation [ppm]	Limit [ppm]	Result
Battery full point	8.40	20.58	0.025	±2.5	Pass
Normal	7.40	21.76	0.026	±2.5	Pass
Battery cut-off point	6.80	18.35	0.022	±2.5	Pass

Product	Portable Terminal				
Test Item	Frequency Stability (Voltage Variation)				
Test Mode	Mode 6: WCDMA Band V Link				
Date of Test	11/23/2009	Test Site		TE02	
Level	Voltage [V]	Deviation [Hz]	Deviation [ppm]	Limit [ppm]	Result
Battery full point	8.40	19.51	0.010	±2.5	Pass
Normal	7.40	18.44	0.010	±2.5	Pass
Battery cut-off point	6.80	17.29	0.009	±2.5	Pass

9 AC Power Conducted Emissions Test

9.1. Limit

Frequency range (MHz)	Limits (dBuV)	
	Quasi-peak	Average
0.15 to 0.50	66 to 56	56 to 46
0.50 to 5.0	56	46
5.0 to 30	60	50

9.2. Test Instruments

Describe	Manufacturer	Model No.	Serial No.	Cal. Date
Spectrum Analyzer	Advantest	R3132	160300103	03/10/2009
Test Receiver	R&S	ESCI	100367	06/05/2009
LISN	EMCO	3816/2 SH	00060110	06/05/2009
LISN	EMCO	3816/2 SH	00060111	06/29/2009
Transient Limiter	ELECTRO-METRICS	EM-7600	777	09/22/2009
Spectrum Analyzer	Advantest	R3132	160300103	03/10/2009
Test Site	ATL	TE02	TE02	N.C.R.

NOTE: N.C.R. = No Calibration Request.

9.3. Setup

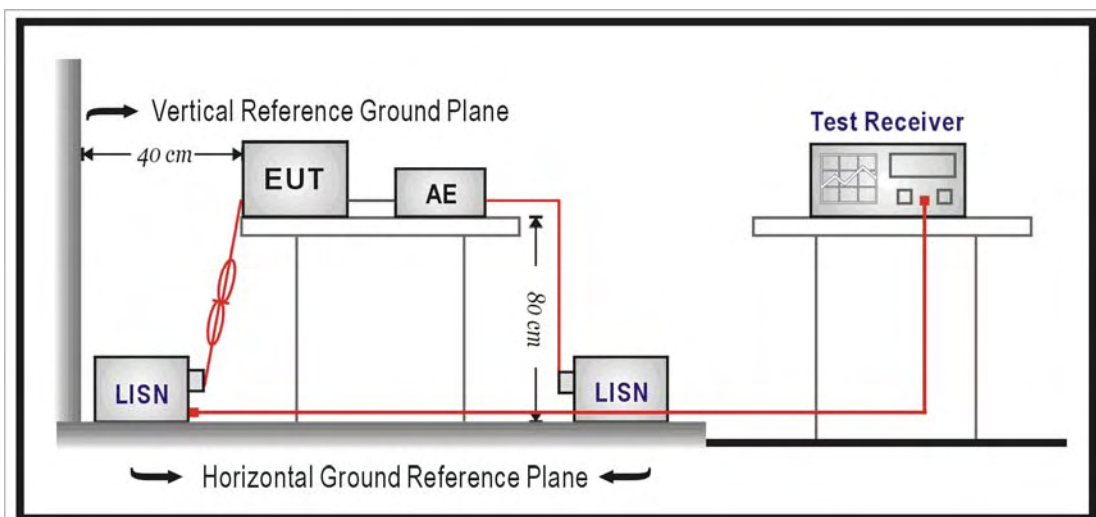

9.4. Test Procedure

The measurement is made according to FCC rules 15.207:

The power line conducted emission measurements were performed in a shielded enclosure. The EUT was assembled on a wooden table which is 80 centimeters high, was placed 40 centimeters from the back wall and at least 1 meter from the sidewall.

Power was fed to the EUT from the public utility power grid through a line filter and EMCO Model 3162/2 SH Line Impedance Stabilization Networks (LISN). The LISN housing, measuring instrumentation case, ground plane, etc., were electrically bonded together at the same RF potential. The Spectrum analyzer was connected to the AC line through an isolation transformer. The 50-ohm output of the LISN was connected to the spectrum analyzer directly. Conducted emission levels were in the CISPR quasi-peak detection mode. The analyzer's 6 dB bandwidth was set to 9 KHz. No post-detector video filter was used.

The spectrum was scanned from 150 KHz to 30 MHz. The physical arrangement of the test system and associated cabling was varied (within the scope of arrangements likely to be encountered in actual use) to determine the effect on the unit's emanations in amplitude and frequency. All spurious emission frequencies were observed. The highest emission amplitudes relative to the appropriate limit were measured and have been recorded in section 10.6.

9.5. Uncertainty

The measurement uncertainty is defined as for AC power conducted emission measurement is ± 2.24 dB.

9.6. Test Result

Product	Portable Terminal		
Test Item	Frequency Stability		
Test Mode	Mode 1: GPRS850 Link Mode 2: GPRS1900 Link Mode 5: WCDMA Band II Link Mode 6: WCDMA Band V Link		
Date of Test	11/21/2009	Test Site	TE02

File :FD-400(IDLE)

Data :#1

Date: 2009/11/21

Time: 下午 01:42:31

80.0 dBuV

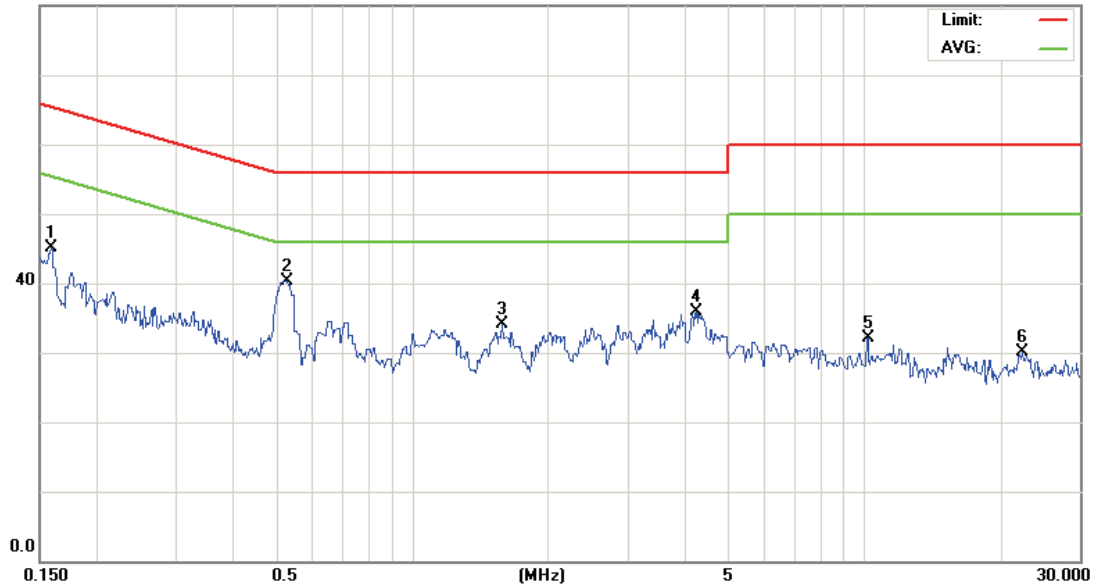

Site : 10M chamber

 Phase: **L1**

Temperature: 26 °C

Limit: CISPR22 Class B Conduction(QP)

Power: AC 120V/60Hz

Humidity: 55 %

EUT:

M/N: 09-0301-E

Mode: IDLE

Note:

No. Mk.	Freq. MHz	Reading Level dBuV	Correct Factor dB	Measure- ment dBuV	Limit dBuV	Over dB	Detector	Comment
1	0.1590	35.29	9.73	45.02	65.51	-20.49	peak	
2 *	0.5270	30.44	9.79	40.23	56.00	-15.77	peak	
3	1.5800	24.25	9.82	34.07	56.00	-21.93	peak	
4	4.2350	25.86	10.00	35.86	56.00	-20.14	peak	
5	10.1500	22.04	10.07	32.11	60.00	-27.89	peak	
6	22.3000	19.87	10.33	30.20	60.00	-29.80	peak	

*:Maximum data x:Over limit !:over margin

●Reference Only

File :FD-400(IDLE)

Data :#2

Date: 2009/11/21

Time: 下午 01:43:38

80.0 dBuV

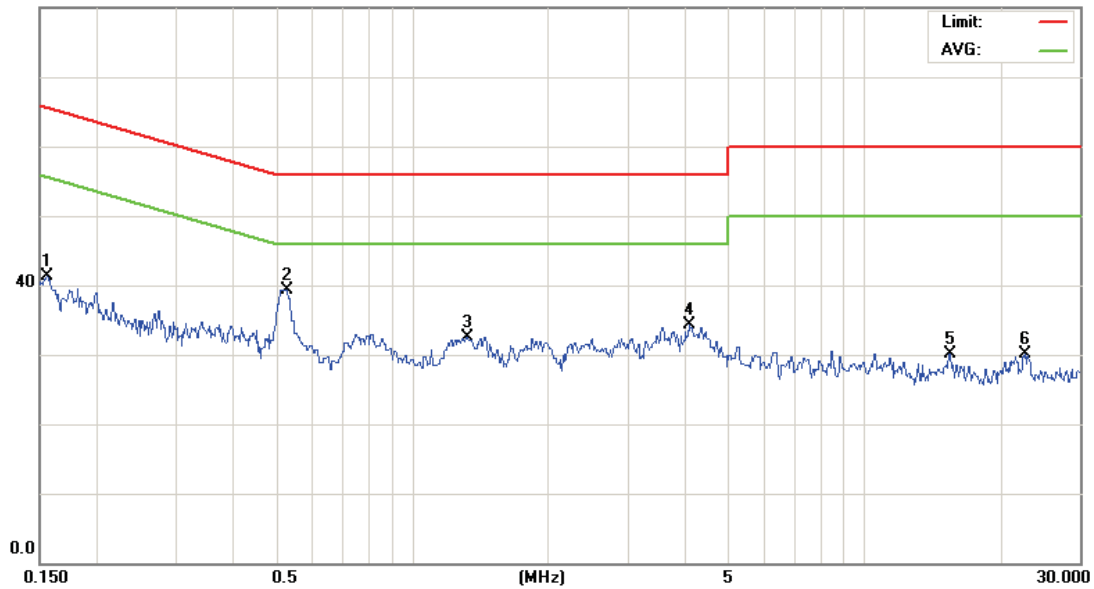

Site : 10M chamber

 Phase: **L2**

Temperature: 26 °C

Limit: CISPR22 Class B Conduction(QP)

Power: AC 120V/60Hz

Humidity: 55 %

EUT:

M/N: 09-0301-E

Mode: IDLE

Note:

No.	Mk.	Freq. MHz	Reading Level dBuV	Correct Factor dB	Measure- ment dBuV	Limit dBuV	Over dB	Detector	Comment
1		0.1556	31.66	9.73	41.39	65.69	-24.30	peak	
2	*	0.5270	29.60	9.79	39.39	56.00	-16.61	peak	
3		1.3190	22.77	9.82	32.59	56.00	-23.41	peak	
4		4.0910	24.30	9.96	34.26	56.00	-21.74	peak	
5		15.4000	19.90	10.25	30.15	60.00	-29.85	peak	
6		22.6000	19.81	10.32	30.13	60.00	-29.87	peak	

*:Maximum data x:Over limit !:over margin

●Reference Only

File :FD-400(GSM850)

Data :#1

Date: 2009/11/21

Time: 下午 01:11:19

80.0 dBuV

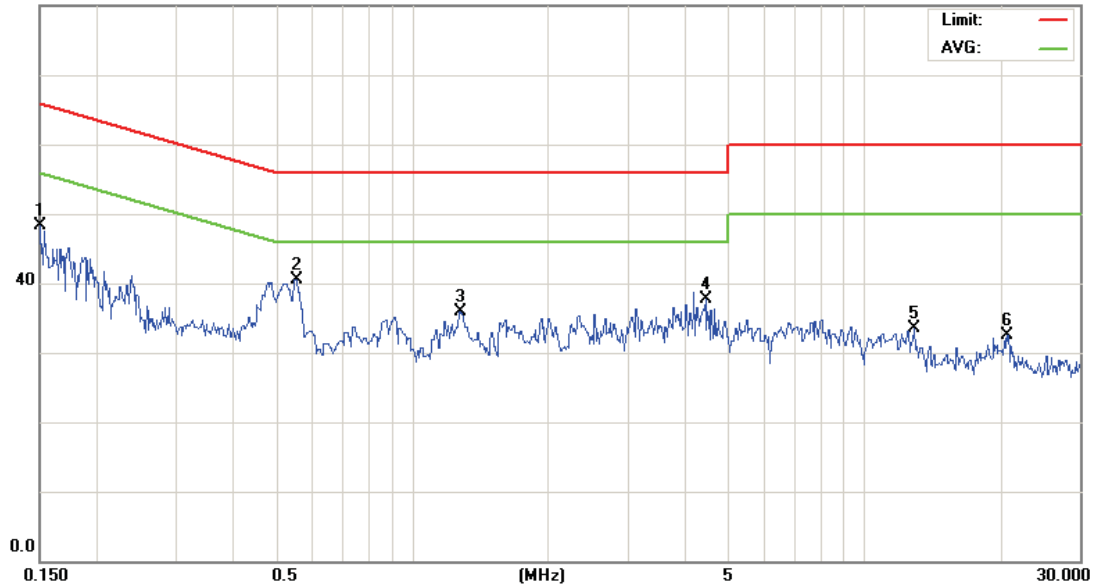

Site : 10M chamber

 Phase: **L1**

Temperature: 26 °C

Limit: CISPR22 Class B Conduction(QP)

Power: AC 120V/60Hz

Humidity: 55 %

EUT:

M/N: 09-0301-E

Mode: GPRS850

Note: Link CH190

No. Mk.	Freq. MHz	Reading Level dBuV	Correct Factor dB	Measure- ment dBuV	Limit dBuV	Over dB	Detector	Comment
1	0.1500	38.52	9.73	48.25	65.99	-17.74	peak	
2 *	0.5540	30.73	9.79	40.52	56.00	-15.48	peak	
3	1.2740	26.02	9.81	35.83	56.00	-20.17	peak	
4	4.4420	27.66	10.02	37.68	56.00	-18.32	peak	
5	12.9000	23.30	10.18	33.48	60.00	-26.52	peak	
6	20.7000	22.04	10.39	32.43	60.00	-27.57	peak	

*:Maximum data x:Over limit !:over margin

●Reference Only

File :FD-400(GSM850)

Data :#2

Date: 2009/11/21

Time: 下午 01:09:33

80.0 dBuV

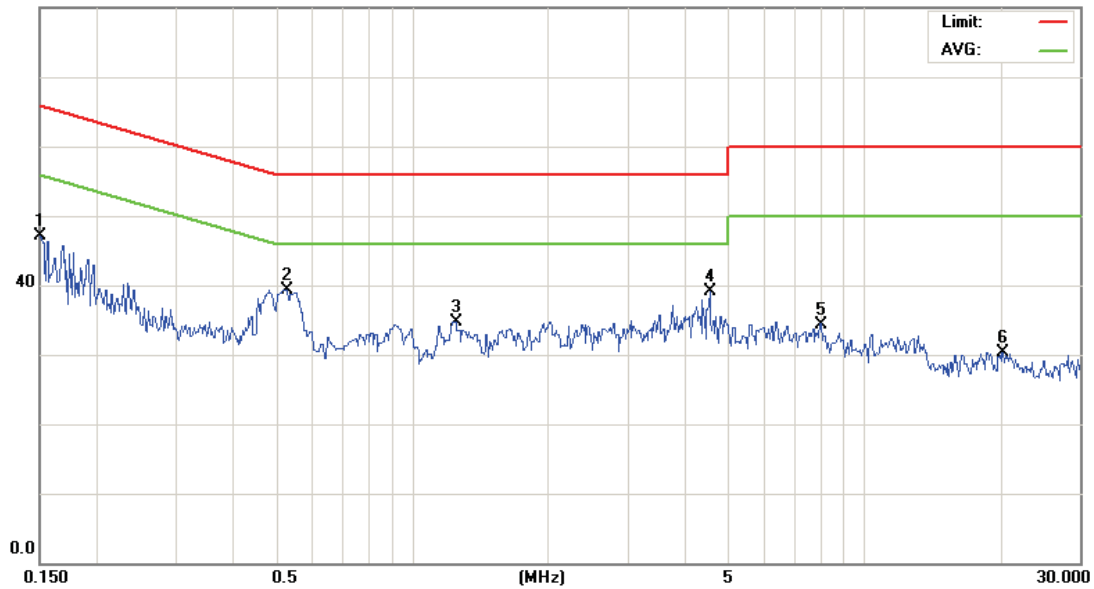

Site : 10M chamber

 Phase: **L2**

Temperature: 26 °C

Limit: CISPR22 Class B Conduction(QP)

Power: AC 120V/60Hz

Humidity: 55 %

EUT:

M/N: 09-0301-E

Mode: GPRS850

Note: Link CH190

No.	Mk.	Freq. MHz	Reading Level dBuV	Correct Factor dB	Measure- ment dBuV	Limit dBuV	Over dB	Detector	Comment
1		0.1507	37.30	9.73	47.03	65.96	-18.93	peak	
2	*	0.5270	29.61	9.79	39.40	56.00	-16.60	peak	
3		1.2470	24.85	9.81	34.66	56.00	-21.34	peak	
4		4.5410	29.14	10.02	39.16	56.00	-16.84	peak	
5		8.0000	24.31	10.09	34.40	60.00	-25.60	peak	
6		20.2000	20.03	10.29	30.32	60.00	-29.68	peak	

*:Maximum data x:Over limit !:over margin

●Reference Only

File :FD-400(PCS1900)

Data :#1

Date: 2009/11/21

Time: 下午 01:27:01

80.0 dBuV

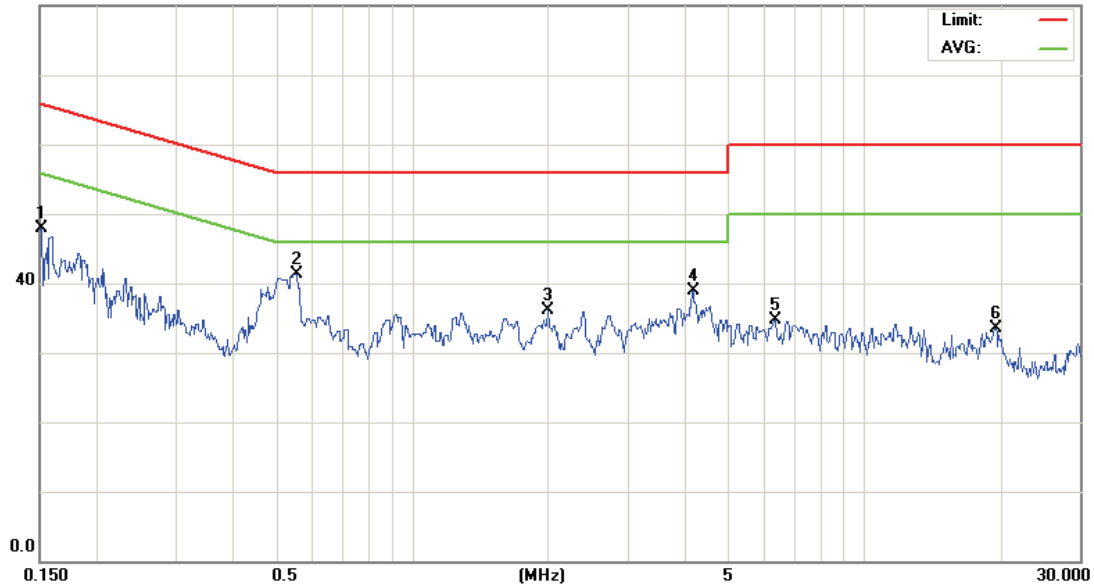

Site : 10M chamber

 Phase: **L1**

Temperature: 26 °C

Limit: CISPR22 Class B Conduction(QP)

Power: AC 120V/60Hz

Humidity: 55 %

EUT:

M/N: 09-0301-E

Mode: GPRS1900

Note: Link CH661

No.	Mk.	Freq. MHz	Reading Level dBuV	Correct Factor dB	Measure- ment dBuV	Limit dBuV	Over dB	Detector	Comment
1		0.1514	38.22	9.73	47.95	65.92	-17.97	peak	
2	*	0.5540	31.60	9.79	41.39	56.00	-14.61	peak	
3		1.9940	26.23	9.85	36.08	56.00	-19.92	peak	
4		4.1630	28.89	9.97	38.86	56.00	-17.14	peak	
5		6.3500	24.55	10.09	34.64	60.00	-25.36	peak	
6		19.4500	23.16	10.28	33.44	60.00	-26.56	peak	

*:Maximum data x:Over limit !:over margin

●Reference Only

File :FD-400(PCS1900)

Data :#2

Date: 2009/11/21

Time: 下午 01:29:26

80.0 dBuV

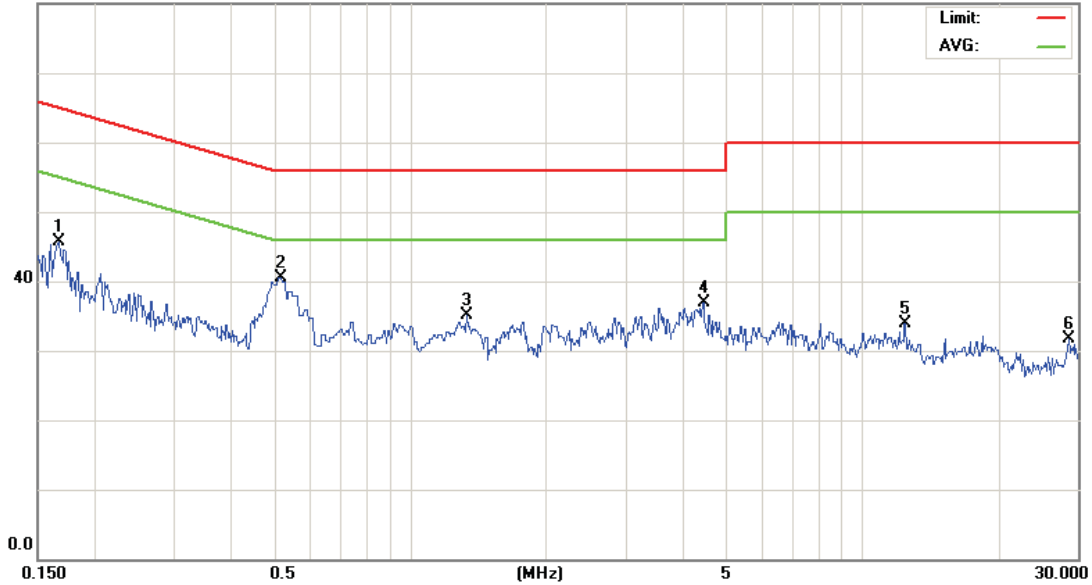

Site : 10M chamber

 Phase: **L2**

Temperature: 26 °C

Limit: CISPR22 Class B Conduction(QP)

Power: AC 120V/60Hz

Humidity: 55 %

EUT:

M/N: 09-0301-E

Mode: GPRS1900

Note: Link CH661

No.	Mk.	Freq. MHz	Reading Level dBuV	Correct Factor dB	Measure- ment dBuV	Limit dBuV	Over dB	Detector	Comment
1		0.1668	36.00	9.73	45.73	65.11	-19.38	peak	
2	*	0.5180	30.73	9.79	40.52	56.00	-15.48	peak	
3		1.3370	25.28	9.82	35.10	56.00	-20.90	peak	
4		4.4420	26.86	10.02	36.88	56.00	-19.12	peak	
5		12.4000	23.83	10.16	33.99	60.00	-26.01	peak	
6		28.5500	21.40	10.36	31.76	60.00	-28.24	peak	

*:Maximum data x:Over limit !:over margin

●Reference Only

File :FD-400(WCDMA Band 2)

Data :#1

Date: 2009/11/21

Time: 下午 12:55:31

80.0 dBuV

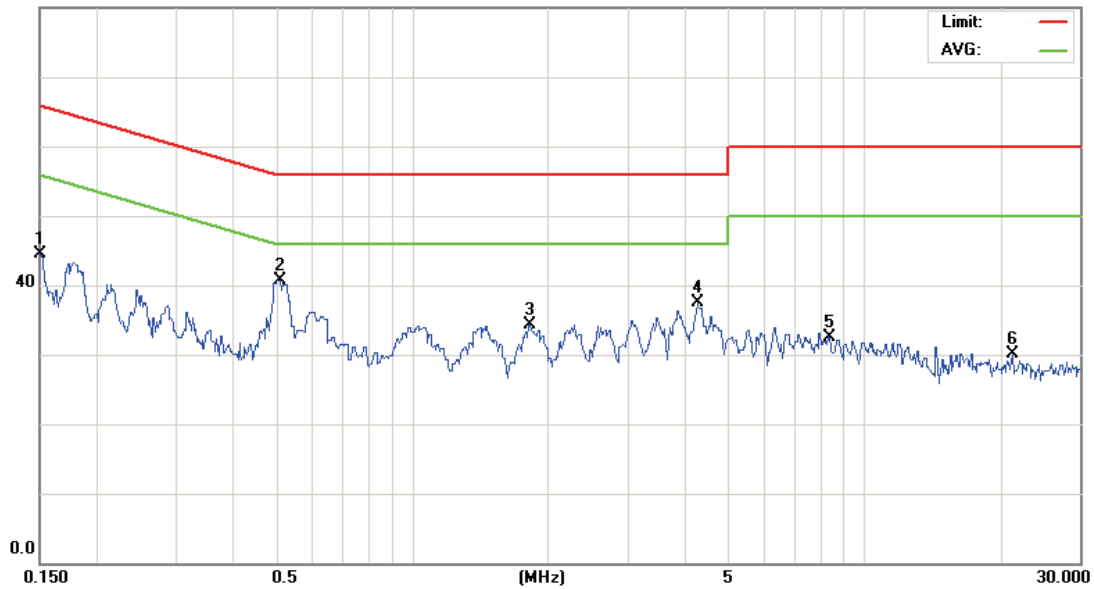

Site : 10M chamber

 Phase: **L1**

Temperature: 26 °C

Limit: CISPR22 Class B Conduction(QP)

Power: AC 120V/60Hz

Humidity: 55 %

EUT:

M/N: 09-0301-E

Mode: WCDMA Band II

Note: Link CH9400

No. Mk.	Freq. MHz	Reading Level dBuV	Correct Factor dB	Measure- ment dBuV	Limit dBuV	Over dB	Detector	Comment
1	0.1500	34.78	9.73	44.51	65.99	-21.48	peak	
2 *	0.5090	30.87	9.79	40.66	56.00	-15.34	peak	
3	1.8140	24.45	9.82	34.27	56.00	-21.73	peak	
4	4.2619	27.45	10.00	37.45	56.00	-18.55	peak	
5	8.3500	22.44	10.09	32.53	60.00	-27.47	peak	
6	21.2000	19.88	10.27	30.15	60.00	-29.85	peak	

*:Maximum data x:Over limit !:over margin

●Reference Only

File :FD-400(WCDMA Band 2)

Data :#2

Date: 2009/11/21

Time: 下午 12:57:07

80.0 dBuV

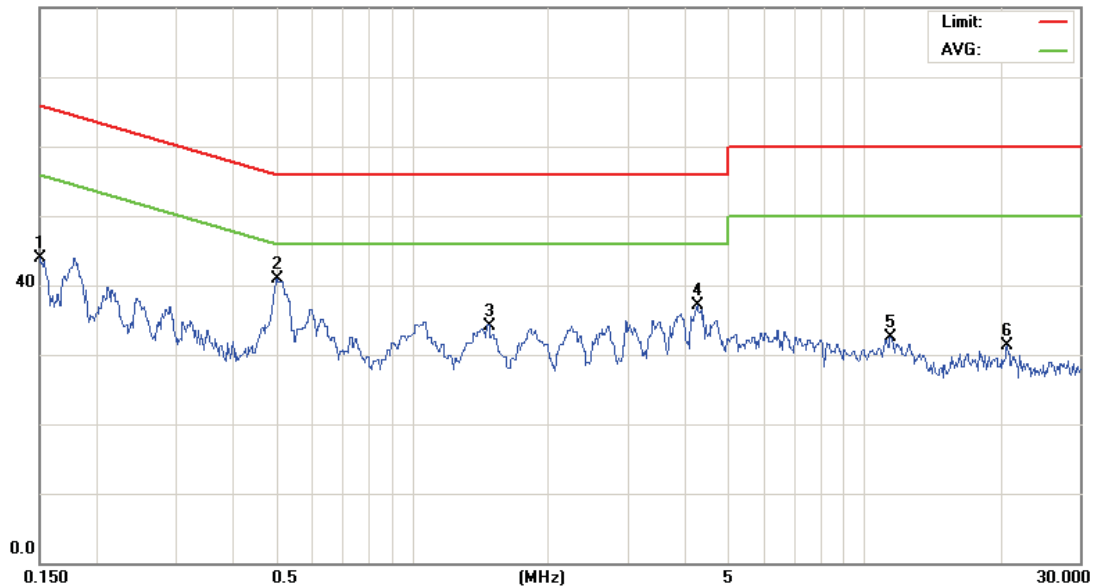

Site : 10M chamber

 Phase: **L2**

Temperature: 26 °C

Limit: CISPR22 Class B Conduction(QP)

Power: AC 120V/60Hz

Humidity: 55 %

EUT:

M/N: 09-0301-E

Mode: WCDMA Band II

Note: Link CH9400

No. Mk.	Freq. MHz	Reading Level dBuV	Correct Factor dB	Measure- ment dBuV	Limit dBuV	Over dB	Detector	Comment
1	0.1500	34.18	9.73	43.91	65.99	-22.08	peak	
2 *	0.5000	31.21	9.78	40.99	56.00	-15.01	peak	
3	1.4720	24.39	9.81	34.20	56.00	-21.80	peak	
4	4.2619	27.13	10.00	37.13	56.00	-18.87	peak	
5	11.4000	22.31	10.12	32.43	60.00	-27.57	peak	
6	20.6500	20.89	10.41	31.30	60.00	-28.70	peak	

*:Maximum data x:Over limit !:over margin

●Reference Only

File :FD-400(WCDMA Band 5)

Data :#1

Date: 2009/11/21

Time: 下午 01:02:32

80.0 dBuV

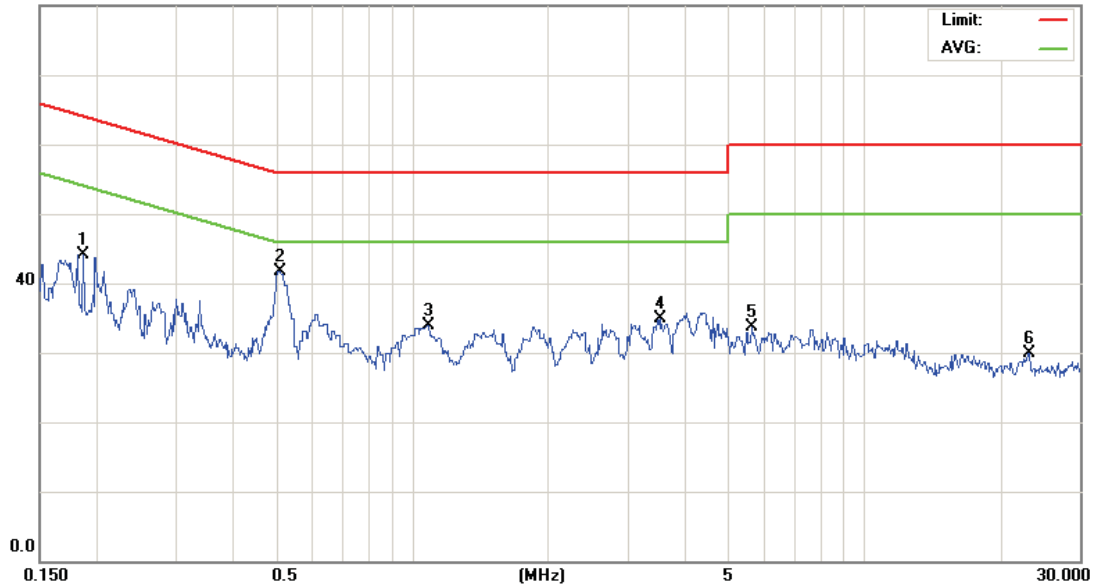

Site : 10M chamber

 Phase: **L1**

Temperature: 26 °C

Limit: CISPR22 Class B Conduction(QP)

Power: AC 120V/60Hz

Humidity: 55 %

EUT:

M/N: 09-0301-E

Mode: WCDMA Band V

Note: Link CH4180

No. Mk.	Freq. MHz	Reading Level dBuV	Correct Factor dB	Measure- ment dBuV	Limit dBuV	Over dB	Detector	Comment
1	0.1870	34.41	9.74	44.15	64.16	-20.01	peak	
2 *	0.5090	31.82	9.79	41.61	56.00	-14.39	peak	
3	1.0850	24.01	9.80	33.81	56.00	-22.19	peak	
4	3.5420	24.99	9.94	34.93	56.00	-21.07	peak	
5	5.6500	23.59	10.05	33.64	60.00	-26.36	peak	
6	23.0500	19.47	10.38	29.85	60.00	-30.15	peak	

*:Maximum data x:Over limit !:over margin

●Reference Only

File :FD-400(WCDMA Band 5)

Data :#2

Date: 2009/11/21

Time: 下午 01:04:07

80.0 dBuV

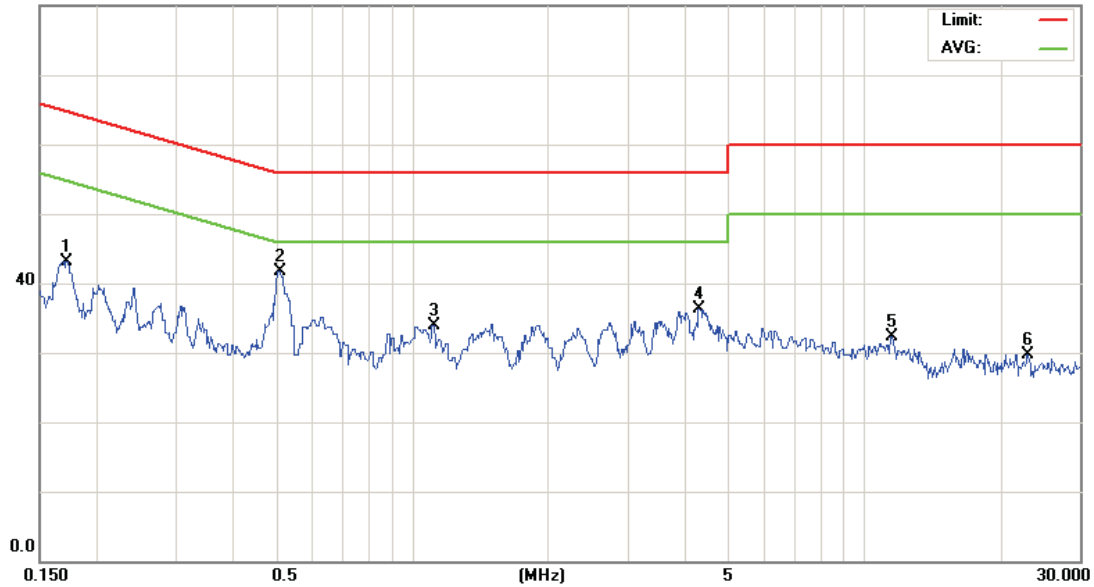

Site : 10M chamber

 Phase: **L2**

Temperature: 26 °C

Limit: CISPR22 Class B Conduction(QP)

Power: AC 120V/60Hz

Humidity: 55 %

EUT:

M/N: 09-0301-E

Mode: WCDMA Band V

Note: Link CH4180

No. Mk.	Freq. MHz	Reading Level dBuV	Correct Factor dB	Measure- ment dBuV	Limit dBuV	Over dB	Detector	Comment
1	0.1717	33.45	9.73	43.18	64.87	-21.69	peak	
2 *	0.5090	31.85	9.79	41.64	56.00	-14.36	peak	
3	1.1119	24.01	9.80	33.81	56.00	-22.19	peak	
4	4.2980	26.35	10.00	36.35	56.00	-19.65	peak	
5	11.4500	22.22	10.12	32.34	60.00	-27.66	peak	
6	22.9000	19.40	10.36	29.76	60.00	-30.24	peak	

*:Maximum data x:Over limit !:over margin

●Reference Only

9.7. Test Photograph

Description : Front View of AC Power Conducted Emissions Test



Description : Back View of AC Power Conducted Emissions Test

