

FCC Test Report (WLAN)

Report No.: RF161110E09

FCC ID: MQT-E200NP

Test Model: xCL_E200NP-UN5

Series Model: xCL_E200NP-UNN, xCL_E200NP-NN5, xCL_E200NP-NNN

Received Date: Nov. 10, 2016

Test Date: Nov. 18 to 29, 2016

Issued Date: Jan. 23, 2017

Applicant: XAC AUTOMATION CORP.

Address: 4F, No. 30, INDUSTRY E. RD. IX, SCIENCE-BASED INDUSTRIAL
PARK,HSINCHU,TAIWAN

Issued By: Bureau Veritas Consumer Products Services (H.K.) Ltd., Taoyuan Branch
Hsin Chu Laboratory

Lab Address: E-2, No.1, Li Hsin 1st Road, Hsinchu Science Park, Hsinchu City 300,
Taiwan R.O.C.

Test Location (1): E-2, No.1, Li Hsin 1st Road, Hsinchu Science Park, Hsinchu City 300,
Taiwan R.O.C.

Test Location (2): No. 49, Ln. 206, Wende Rd., Shangshan Tsuen, Chiung Lin Hsiang, Hsin
Chu Hsien 307, Taiwan R.O.C.



This report is for your exclusive use. Any copying or replication of this report to or for any other person or entity, or use of our name or trademark, is permitted only with our prior written permission. This report sets forth our findings solely with respect to the test samples identified herein. The results set forth in this report are not indicative or representative of the quality or characteristics of the lot from which a test sample was taken or any similar or identical product unless specifically and expressly noted. Our report includes all of the tests requested by you and the results thereof based upon the information that you provided to us. You have 60 days from date of issuance of this report to notify us of any material error or omission caused by our negligence, provided, however, that such notice shall be in writing and shall specifically address the issue you wish to raise. A failure to raise such issue within the prescribed time shall constitute your unqualified acceptance of the completeness of this report, the tests conducted and the correctness of the report contents. Unless specific mention, the uncertainty of measurement has been explicitly taken into account to declare the compliance or non-compliance to the specification. The report must not be used by the client to claim product certification, approval, or endorsement by TAF or any government agencies.

Table of Contents

Release Control Record	4
1 Certificate of Conformity	5
2 Summary of Test Results	6
2.1 Measurement Uncertainty	6
2.2 Modification Record	6
3 General Information	7
3.1 General Description of EUT (WLAN)	7
3.2 Description of Test Modes	10
3.2.1 Test Mode Applicability and Tested Channel Detail	11
3.3 Duty Cycle of Test Signal	13
3.4 Description of Support Units	14
3.4.1 Configuration of System under Test	15
3.5 General Description of Applied Standards	16
4 Test Types and Results	17
4.1 Radiated Emission and Bandedge Measurement	17
4.1.1 Limits of Radiated Emission and Bandedge Measurement	17
4.1.2 Test Instruments	18
4.1.3 Test Procedures	20
4.1.4 Deviation from Test Standard	20
4.1.5 Test Setup	21
4.1.6 EUT Operating Conditions	22
4.1.7 Test Results	23
4.2 Conducted Emission Measurement	36
4.2.1 Limits of Conducted Emission Measurement	36
4.2.2 Test Instruments	36
4.2.3 Test Procedures	37
4.2.4 Deviation from Test Standard	37
4.2.5 Test Setup	37
4.2.6 EUT Operating Conditions	37
4.2.7 Test Results (Mode 1)	38
4.2.8 Test Results (Mode 2)	40
4.3 6dB Bandwidth Measurement	42
4.3.1 Limits of 6dB Bandwidth Measurement	42
4.3.2 Test Setup	42
4.3.3 Test Instruments	42
4.3.4 Test Procedure	42
4.3.5 Deviation from Test Standard	42
4.3.6 EUT Operating Conditions	42
4.3.7 Test Result	43
4.4 Conducted Output Power Measurement	45
4.4.1 Limits of Conducted Output Power Measurement	45
4.4.2 Test Setup	45
4.4.3 Test Instruments	45
4.4.4 Test Procedures	45
4.4.5 Deviation from Test Standard	45
4.4.6 EUT Operating Conditions	45
4.4.7 Test Results	46
4.5 Power Spectral Density Measurement	48
4.5.1 Limits of Power Spectral Density Measurement	48
4.5.2 Test Setup	48
4.5.3 Test Instruments	48
4.5.4 Test Procedure	48
4.5.5 Deviation from Test Standard	48

4.5.6 EUT Operating Condition	48
4.5.7 Test Results	49
4.6 Conducted Out of Band Emission Measurement	51
4.6.1 Limits of Conducted Out of Band Emission Measurement.....	51
4.6.2 Test Setup.....	51
4.6.3 Test Instruments	51
4.6.4 Test Procedure	51
4.6.5 Deviation from Test Standard	51
4.6.6 EUT Operating Condition	51
4.6.7 Test Results	52
5 Pictures of Test Arrangements.....	57
Appendix – Information on the Testing Laboratories	58

Release Control Record

Issue No.	Description	Date Issued
RF161110E09	Original release.	Jan. 23, 2017

1 Certificate of Conformity

Product: Portable terminal

Brand: XAC

Test Model: xCL_E200NP-UN5

Series Model: xCL_E200NP-UNN, xCL_E200NP-NN5, xCL_E200NP-NNN

Sample Status: ENGINEERING SAMPLE

Applicant: XAC AUTOMATION CORP.

Test Date: Nov. 18 to 29, 2016

Standards: 47 CFR FCC Part 15, Subpart C (Section 15.247)
ANSI C63.10: 2013

The above equipment has been tested by **Bureau Veritas Consumer Products Services (H.K.) Ltd., Taoyuan Branch**, and found compliance with the requirement of the above standards. The test record, data evaluation & Equipment Under Test (EUT) configurations represented herein are true and accurate accounts of the measurements of the sample's EMC characteristics under the conditions specified in this report.

Prepared by : Midoli Peng , **Date:** Jan. 23, 2017
Midoli Peng / Specialist

Approved by : May Chen , **Date:** Jan. 23, 2017
May Chen / Manager

2 Summary of Test Results

47 CFR FCC Part 15, Subpart C (SECTION 15.247)			
FCC Clause	Test Item	Result	Remarks
15.207	AC Power Conducted Emission	PASS	Meet the requirement of limit. Minimum passing margin is -14.08dB at 2.79297MHz.
15.205 / 15.209 / 15.247(d)	Radiated Emissions and Band Edge Measurement	PASS	Meet the requirement of limit. Minimum passing margin is -5.3dB at 2483.50MHz.
15.247(d)	Antenna Port Emission	PASS	Meet the requirement of limit.
15.247(a)(2)	6dB bandwidth	PASS	Meet the requirement of limit.
15.247(b)	Conducted power	PASS	Meet the requirement of limit.
15.247(e)	Power Spectral Density	PASS	Meet the requirement of limit.
15.203	Antenna Requirement	PASS	Antenna connector is i-pex(MHF) not a standard connector.

2.1 Measurement Uncertainty

Where relevant, the following measurement uncertainty levels have been estimated for tests performed on the EUT as specified in CISPR 16-4-2:

Measurement	Frequency	Expanded Uncertainty (k=2) (±)
Conducted Emissions at mains ports	150kHz ~ 30MHz	1.83 dB
Radiated Emissions up to 1 GHz	30MHz ~ 1GHz	5.36 dB
Radiated Emissions above 1 GHz	1GHz ~ 6GHz	3.41 dB
	6GHz ~ 18GHz	3.49 dB
	18GHz ~ 40GHz	3.30 dB

2.2 Modification Record

There were no modifications required for compliance.

3 General Information

3.1 General Description of EUT (WLAN)

Product	Portable terminal
Brand	XAC
Test Model	xCL_E200NP-UN5
Series Model	xCL_E200NP-UNN, xCL_E200NP-NN5, xCL_E200NP-NNN
Status of EUT	ENGINEERING SAMPLE
Power Supply Rating	DC 3.85V or DC 3.7V from battery DC 5V from USB interface
Modulation Type	CCK, DQPSK, DBPSK for DSSS 64QAM, 16QAM, QPSK, BPSK for OFDM
Modulation Technology	DSSS, OFDM
Transfer Rate	802.11b: up to 11Mbps 802.11g: up to 54Mbps 802.11n: up to 150Mbps
Operating Frequency	For 15.247: 2.412 ~ 2.462GHz
	For 15.407: 5.18~5.24GHz, 5.26~5.32GHz, 5.50~5.70GHz, 5.745~5.825GHz
Number of Channel	For 15.247: 802.11b, 802.11g, 802.11n (HT20): 11 802.11n (HT40): 7
	For 15.407: 802.11a, 802.11n (HT20): 24 802.11n (HT40): 11
Output Power	For 15.247: 151.705mW
	For 15.407: 5180-5240MHz : 11.722mW 5260-5320MHz : 12.972mW 5500-5720MHz : 23.988mW 5745-5825MHz : 23.121mW
Antenna Type	Refer to Note
Antenna Connector	Refer to Note
Accessory Device	Battery x1 (option)
Data Cable Supplied	NA

Note:

1. All models are listed as below.

Model Name	Function				
	WLAN(b/g/n/an)	RFID	BT	2G/3G	Camera
				US	Rear 5M
xCL_E200NP-UN5	v	v	v	v	v
xCL_E200NP-UNN	v	v	v	v	-
xCL_E200NP-NN5	v	v	v	-	v
xCL_E200NP-NNN	v	v	v	-	-

From the above models, model: **xCL_E200NP-UN5** was selected as representative model for the test and its data was recorded in this report.

2. There are WLAN, Bluetooth WWAN and RFID technology used for the EUT.

3. EUT contains one certified WWAN module which FCC ID: QIPEHS5-US.

4. Simultaneously transmission condition.

Condition	Technology		
1	WLAN (2.4GHz)	Bluetooth	RFID
2	WLAN (5GHz)	Bluetooth	RFID
3	WWAN	Bluetooth	RFID

Note: The emission of the simultaneous operation has been evaluated and no non-compliance was found.

5. The antennas provided to the EUT, please refer to the following table:

WLAN/BT Antenna Spec.				
No.	Antenna Net Gain (dBi)	Frequency range	Antenna Type	Connector Type
1	0.26	2.4~2.4835GHz	PCB	i-pex(MHF)
	2.38	5.15~5.85GHz		
WWAN Antenna Spec.				
No.	Antenna Net Gain(dBi)	Frequency range	Antenna Type	Connector Type
1	-1.61	824-891MHz	PCB	i-pex(MHF)
	0.58	1850-1990MHz		
RFID Antenna Spec.				
No.	Antenna Net Gain(dBi)	Frequency range	Antenna Type	Connector Type
1	13	13.56MHz	Loop	NA

6. The EUT power needs to be supplied from one power adapter or battery, the information is as below table:

Power adapter (only for test not for sale)				
Brand	Model Name		Specification	
MOSO	MSA-C2000IC5.0-12W-US		Input: AC100-240V, 0.5A, 50/60Hz Output: DC 5V, 2A DC output cable (Unshielded, 1.2 m)	
Battery (option)				
No.	Brand	Model Name	Specification	Remark
1	TWS	E200NP	3.85V, 2900mAh, 11.17Wh	Black
2	HYB	J529/ICP575374P	3.7V, 3000mAh, 11.1Wh	Silver

7. For radiated emission test, the EUT was pre-tested under the following test modes :

Pre-test Mode	Power
Mode A	Power from battery 1
Mode B	Power from battery 2
Mode C	Power from USB interface (Adapter)

The worst radiated emission was found in **Mode C**. Therefore only the test data of the modes were recorded in this report.

8. The EUT incorporates a SISO function.

2.4GHz Band			
MODULATION MODE	DATA RATE (MCS)	TX & RX CONFIGURATION	
802.11b	1 ~ 11Mbps	1TX	1RX
802.11g	6 ~ 54Mbps	1TX	1RX
802.11n (HT20)	MCS 0~7	1TX	1RX
802.11n (HT40)	MCS 0~7	1TX	1RX
5GHz Band			
MODULATION MODE	DATA RATE (MCS)	TX & RX CONFIGURATION	
802.11a	6 ~ 54Mbps	1TX	1RX
802.11n (HT20)	MCS 0~7	1TX	1RX
802.11n (HT40)	MCS 0~7	1TX	1RX

9. The above EUT information is declared by manufacturer and for more detailed features description, please refer to the manufacturer's specifications or user's manual.

3.2 Description of Test Modes

11 channels are provided for 802.11b, 802.11g and 802.11n (HT20):

Channel	Frequency	Channel	Frequency
1	2412MHz	7	2442MHz
2	2417MHz	8	2447MHz
3	2422MHz	9	2452MHz
4	2427MHz	10	2457MHz
5	2432MHz	11	2462MHz
6	2437MHz		

7 channels are provided for 802.11n (HT40):

Channel	Frequency	Channel	Frequency
3	2422MHz	7	2442MHz
4	2427MHz	8	2447MHz
5	2432MHz	9	2452MHz
6	2437MHz		

3.2.1 Test Mode Applicability and Tested Channel Detail

EUT CONFIGURE MODE	APPLICABLE TO				DESCRIPTION
	RE \geq 1G	RE<1G	PLC	APCM	
1	√	√	√	√	Power from USB interface (Adapter)
2	-	-	√	-	Power from USB interface (Host)

Where RE \geq 1G: Radiated Emission above 1GHz & Bandedge Measurement
 RE<1G: Radiated Emission below 1GHz
 PLC: Power Line Conducted Emission
 APCM: Antenna Port Conducted Measurement

NOTE: 1. The EUT had been pre-tested on the positioned of each 3 axis. The worst case was found when positioned on **Z-plane**.
 2. "-" means no effect.

Radiated Emission Test (Above 1GHz):

- Pre-Scan has been conducted to determine the worst-case mode from all possible combinations between available modulations, data rates and antenna ports (if EUT with antenna diversity architecture).
- Following channel(s) was (were) selected for the final test as listed below.

MODE	AVAILABLE CHANNEL	TESTED CHANNEL	MODULATION TECHNOLOGY	MODULATION TYPE	DATA RATE (Mbps)
802.11b	1 to 11	1, 6, 11	DSSS	DBPSK	1
802.11g	1 to 11	1, 6, 11	OFDM	BPSK	6
802.11n (HT20)	1 to 11	1, 6, 11	OFDM	BPSK	6.5
802.11n (HT40)	3 to 9	3, 6, 9	OFDM	BPSK	13.5

Radiated Emission Test (Below 1GHz):

- Pre-Scan has been conducted to determine the worst-case mode from all possible combinations between available modulations, data rates and antenna ports (if EUT with antenna diversity architecture).
- Following channel(s) was (were) selected for the final test as listed below.

MODE	AVAILABLE CHANNEL	TESTED CHANNEL	MODULATION TECHNOLOGY	MODULATION TYPE	DATA RATE (Mbps)
802.11g	1 to 11	11	OFDM	BPSK	6

Power Line Conducted Emission Test:

- Pre-Scan has been conducted to determine the worst-case mode from all possible combinations between available modulations, data rates and antenna ports (if EUT with antenna diversity architecture).
- Following channel(s) was (were) selected for the final test as listed below.

MODE	AVAILABLE CHANNEL	TESTED CHANNEL	MODULATION TECHNOLOGY	MODULATION TYPE	DATA RATE (Mbps)
802.11g	1 to 11	11	OFDM	BPSK	6

Antenna Port Conducted Measurement:

- This item includes all test value of each mode, but only includes spectrum plot of worst value of each mode.
- Pre-Scan has been conducted to determine the worst-case mode from all possible combinations between available modulations, data rates and antenna ports (if EUT with antenna diversity architecture).
- Following channel(s) was (were) selected for the final test as listed below.

MODE	AVAILABLE CHANNEL	TESTED CHANNEL	MODULATION TECHNOLOGY	MODULATION TYPE	DATA RATE (Mbps)
802.11b	1 to 11	1, 6, 11	DSSS	DBPSK	1
802.11g	1 to 11	1, 6, 11	OFDM	BPSK	6
802.11n (HT20)	1 to 11	1, 6, 11	OFDM	BPSK	6.5
802.11n (HT40)	3 to 9	3, 6, 9	OFDM	BPSK	13.5

Test Condition:

APPLICABLE TO	ENVIRONMENTAL CONDITIONS	INPUT POWER (System)	TESTED BY
RE \geq 1G	23deg. C, 67%RH	120Vac, 60Hz	Terry Liao
RE $<$ 1G	24deg. C, 64%RH	120Vac, 60Hz	Jyunchun Lin
PLC	25deg. C, 75%RH	120Vac, 60Hz	Andy Ho
APCM	25deg. C, 60%RH	120Vac, 60Hz	Anderson Chen

3.3 Duty Cycle of Test Signal

If duty cycle of test signal is $\geq 98\%$, duty factor is not required.
 If duty cycle of test signal is $< 98\%$, duty factor shall be considered.

802.11b: Duty cycle = $33.025/33.25 = 0.993$

802.11g: Duty cycle = $5.483/5.701 = 0.962$, Duty factor = $10 * \log(1/0.962) = 0.17$

802.11n (HT20): Duty cycle = $5.08/5.295 = 0.959$, Duty factor = $10 * \log(1/0.959) = 0.18$

802.11n (HT40): Duty cycle = $2.468/2.684 = 0.920$, Duty factor = $10 * \log(1/0.920) = 0.36$

802.11b

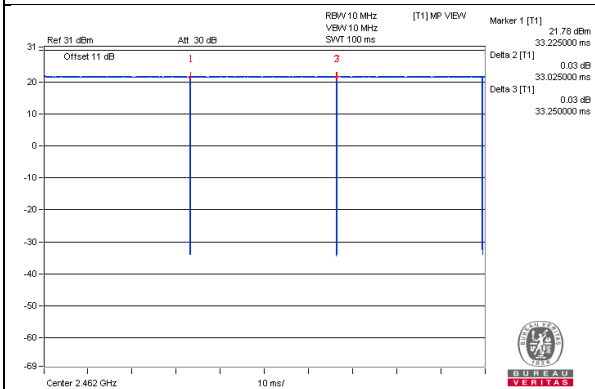

802.11g

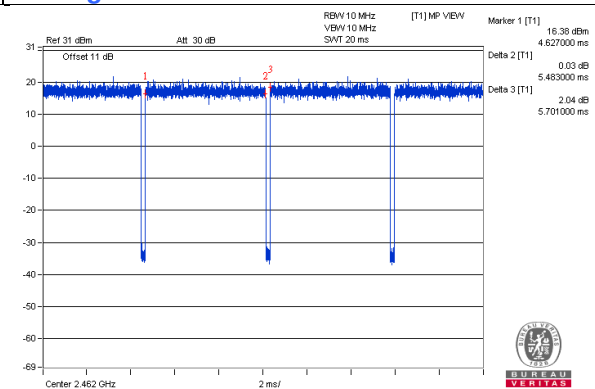

802.11n (HT20)

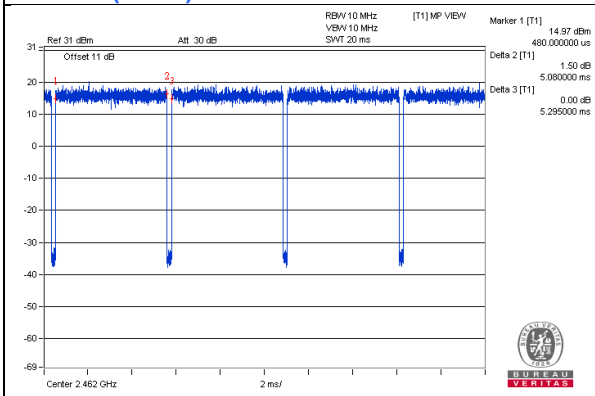

802.11n (HT40)

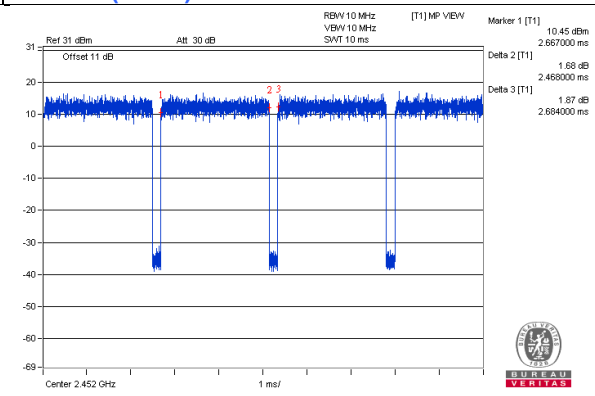

3.4 Description of Support Units

The EUT has been tested as an independent unit together with other necessary accessories or support units. The following support units or accessories were used to form a representative test configuration during the tests.

ID	Product	Brand	Model No.	Serial No.	FCC ID	Remarks
A	Earphone	Apple	NA	NA	NA	Provided by Lab
B	SIM Card	NA	NA	NA	NA	Supplied by client
C	SAM Card	NA	NA	NA	NA	Supplied by client
D	Adapter	MOSO	MSA-C2000IC5.0-12W-US	NA	NA	Supplied by client
E	Laptop	DELL	E5430	4YV4VY1	FCC DoC	Provided by Lab

Note:

1. All power cords of the above support units are non-shielded (1.8m).

ID	Descriptions	Qty.	Length (m)	Shielding (Yes/No)	Cores (Qty.)	Remarks
1	DC Cable	1	1.2	No	0	Supplied by client
2	Audio Cable	1	1.2	No	0	Provided by Lab
3	USB Cable	1	1	Yes	0	Provided by Lab

3.4.1 Configuration of System under Test

Mode 1

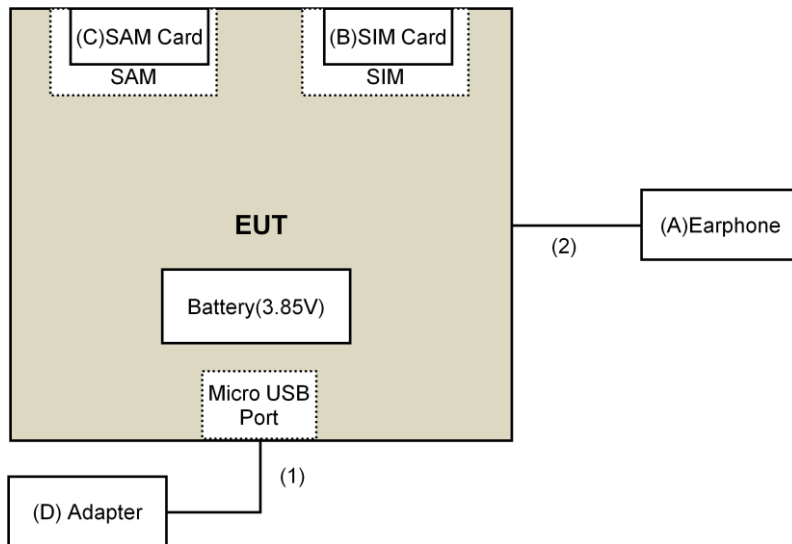

Mode 2

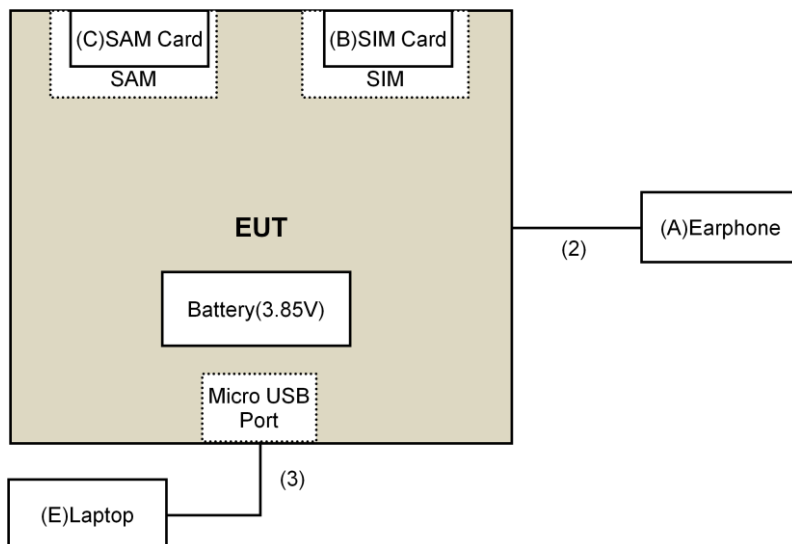

3.5 General Description of Applied Standards

The EUT is a RF Product. According to the specifications of the manufacturer, it must comply with the requirements of the following standards:

FCC Part 15, Subpart C (15.247)
KDB 558074 D01 DTS Meas Guidance v03r05
ANSI C63.10-2013

All test items have been performed and recorded as per the above standards.

4 Test Types and Results

4.1 Radiated Emission and Bandedge Measurement

4.1.1 Limits of Radiated Emission and Bandedge Measurement

Radiated emissions which fall in the restricted bands must comply with the radiated emission limits specified as below table. Other emissions shall be at least 20dB below the highest level of the desired power:

Frequencies (MHz)	Field Strength (microvolts/meter)	Measurement Distance (meters)
0.009 ~ 0.490	2400/F(kHz)	300
0.490 ~ 1.705	24000/F(kHz)	30
1.705 ~ 30.0	30	30
30 ~ 88	100	3
88 ~ 216	150	3
216 ~ 960	200	3
Above 960	500	3

NOTE:

1. The lower limit shall apply at the transition frequencies.
2. Emission level (dBuV/m) = 20 log Emission level (uV/m).
3. For frequencies above 1000MHz, the field strength limits are based on average detector, however, the peak field strength of any emission shall not exceed the maximum permitted average limits, specified above by more than 20dB under any condition of modulation.

4.1.2 Test Instruments

For below 1GHz test:

DESCRIPTION & MANUFACTURER	MODEL NO.	SERIAL NO.	CALIBRATED DATE	CALIBRATED UNTIL
Test Receiver Agilent	N9038A	MY50010156	Aug. 18, 2016	Aug. 17, 2017
Pre-Amplifier ^(*) EMCI	EMC001340	980142	Jan. 20, 2016	Jan. 19, 2018
Loop Antenna ^(*) Electro-Metrics	EM-6879	264	Dec. 16, 2014	Dec. 15, 2016
RF Cable	NA	LOOPCAB-001 LOOPCAB-002	Jan. 18, 2016	Jan. 17, 2017
Pre-Amplifier Mini-Circuits	ZFL-1000VH2 B	AMP-ZFL-05	May 07, 2016	May 06, 2017
Trilog Broadband Antenna SCHWARZBECK	VULB 9168	9168-156	Jan. 04, 2016	Jan. 03, 2017
RF Cable	8D	966-3-1 966-3-2 966-3-3	Apr. 02, 2016	Apr. 01, 2017
Fixed attenuator Mini-Circuits	UNAT-5+	PAD-3m-3-01	Oct. 05, 2016	Oct. 04, 2017
Software	ADT_Radiated _V8.7.08	NA	NA	NA
Antenna Tower & Turn Table Max-Full	MF-7802	MF780208406	NA	NA

Note:

1. The calibration interval of the above test instruments is 12 months and the calibrations are traceable to NML/ROC and NIST/USA.
2. *The calibration interval of the above test instruments is 24 months and the calibrations are traceable to NML/ROC and NIST/USA.
3. Loop antenna was used for all emissions below 30 MHz.
4. The test was performed in 966 Chamber No. 3.
5. The FCC Site Registration No. is 147459
6. The CANADA Site Registration No. is 20331-1
7. Tested Date: Nov. 25, 2016

For other test items:

DESCRIPTION & MANUFACTURER	MODEL NO.	SERIAL NO.	CALIBRATED DATE	CALIBRATED UNTIL
Test Receiver Keysight	N9038A	MY54450088	July 20, 2016	July 19, 2017
Horn_Antenna SCHWARZBECK	BBHA 9120D	9120D-783	Jan. 19, 2016	Jan. 18, 2017
Pre-Amplifier Agilent	8449B	3008A01922	Sep. 18, 2016	Sep. 17, 2017
RF Cable	EMC104-SM- SM-2000 EMC104-SM- SM-5000 EMC104-SM- SM-5000	150318 150323 150324	Mar. 30, 2016	Mar. 29, 2017
Pre-Amplifier EMCI	EMC184045	980143	Jan. 15, 2016	Jan. 14, 2017
Horn_Antenna SCHWARZBECK	BBHA 9170	BBHA9170608	Jan. 08, 2016	Jan. 07, 2017
RF Cable	SUCOFLEX 102	36432/2 36441/2	Jan. 16, 2016	Jan. 15, 2017
Software	ADT_Radiated _V8.7.08	NA	NA	NA
Antenna Tower & Turn Table Max-Full	MF-7802	MF780208410	NA	NA
Boresight Antenna Fixture	FBA-01	FBA-SIP02	NA	NA
Spectrum Analyzer Keysight	N9030A	MY54490679	July 23, 2016	July 22, 2017
Power meter Anritsu	ML2495A	0824006	May 26, 2016	May 25, 2017
Power sensor Anritsu	MA2411B	0738172	May 26, 2016	May 25, 2017

Note:

1. The calibration interval of the above test instruments is 12 months and the calibrations are traceable to NML/ROC and NIST/USA.
2. The test was performed in 966 Chamber No. 4.
3. The FCC Site Registration No. is 292998
4. The CANADA Site Registration No. is 20331-2
5. Tested Date: Nov. 18 to 29, 2016

4.1.3 Test Procedures

For Radiated emission below 30MHz

- a. The EUT was placed on the top of a rotating table 0.8 meters above the ground at a 3 meter chamber room. The table was rotated 360 degrees to determine the position of the highest radiation.
- b. The EUT was set 3 meters away from the interference-receiving antenna, which was mounted on the top of a variable-height antenna tower.
- c. Both X and Y axes of the antenna are set to make the measurement.
- d. For each suspected emission, the EUT was arranged to its worst case and the rotatable table was turned from 0 degrees to 360 degrees to find the maximum reading.
- e. The test-receiver system was set to Quasi-Peak Detect Function and Specified Bandwidth with Maximum Hold Mode.

NOTE:

1. The resolution bandwidth and video bandwidth of test receiver/spectrum analyzer is 9kHz at frequency below 30MHz.

For Radiated emission above 30MHz

- a. The EUT was placed on the top of a rotating table 0.8 meters (for 30MHz ~ 1GHz) / 1.5 meters (for above 1GHz) above the ground at 3 meter chamber room for test. The table was rotated 360 degrees to determine the position of the highest radiation.
- b. The EUT was set 3 meters away from the interference-receiving antenna, which was mounted on the top of a variable-height antenna tower.
- c. The height of antenna is varied from one meter to four meters above the ground to determine the maximum value of the field strength. Both horizontal and vertical polarizations of the antenna are set to make the measurement.
- d. For each suspected emission, the EUT was arranged to its worst case and then the antenna was tuned to heights from 1 meter to 4 meters and the rotatable table was turned from 0 degrees to 360 degrees to find the maximum reading.
- e. The test-receiver system was set to quasi-peak detect function and specified bandwidth with maximum hold mode when the test frequency is below 1 GHz.
- f. The test-receiver system was set to peak and average detect function and specified bandwidth with maximum hold mode when the test frequency is above 1 GHz. If the peak reading value also meets average limit, measurement with the average detector is unnecessary.

Note:

1. The resolution bandwidth and video bandwidth of test receiver/spectrum analyzer is 120kHz for Quasi-peak detection (QP) at frequency below 1GHz.
2. The resolution bandwidth of test receiver/spectrum analyzer is 1 MHz and the video bandwidth is 3 MHz for Peak detection (PK) at frequency above 1GHz.
3. The resolution bandwidth of test receiver/spectrum analyzer is 1MHz and the video bandwidth is $\geq 1/T$ (Duty cycle < 98%) or 10Hz (Duty cycle $\geq 98\%$) for Average detection (AV) at frequency above 1GHz.
4. All modes of operation were investigated and the worst-case emissions are reported.

4.1.4 Deviation from Test Standard

No deviation.

4.1.5 Test Setup

For Radiated emission below 30MHz

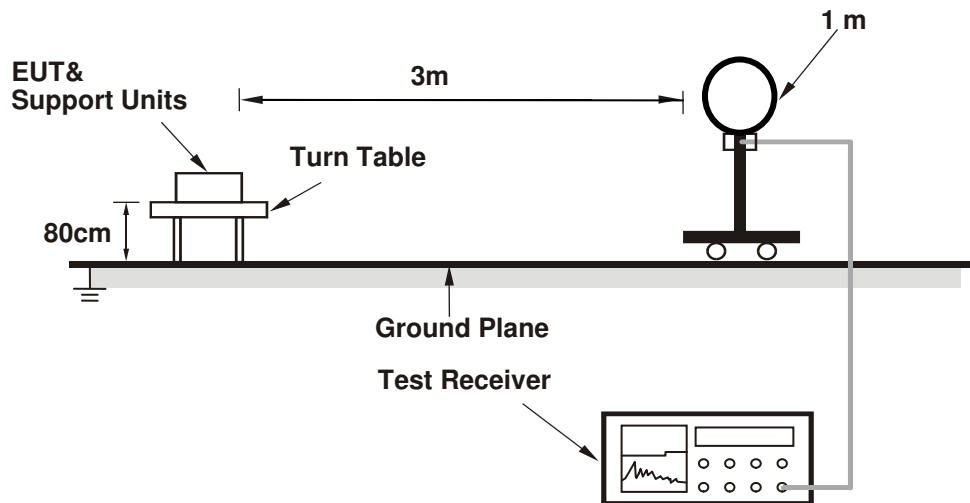

For Radiated emission 30MHz to 1GHz

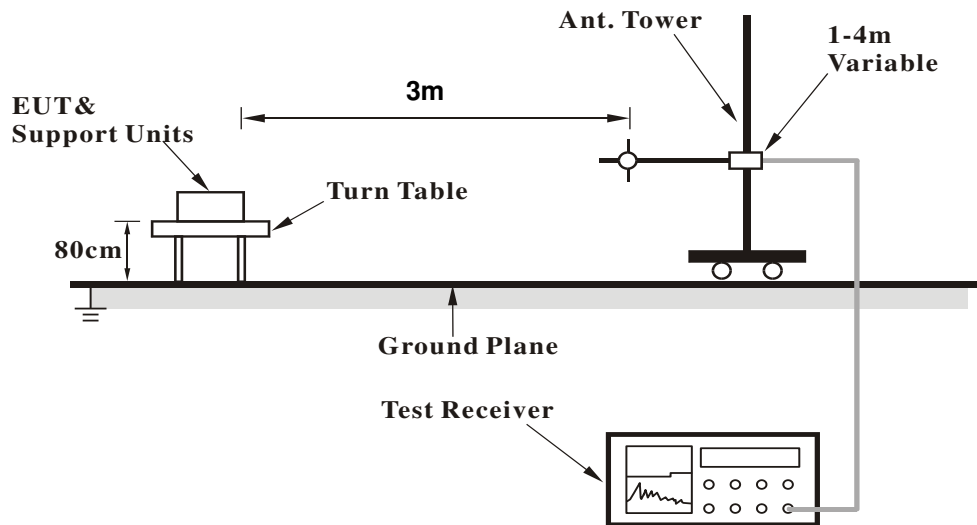

For Radiated emission above 1GHz

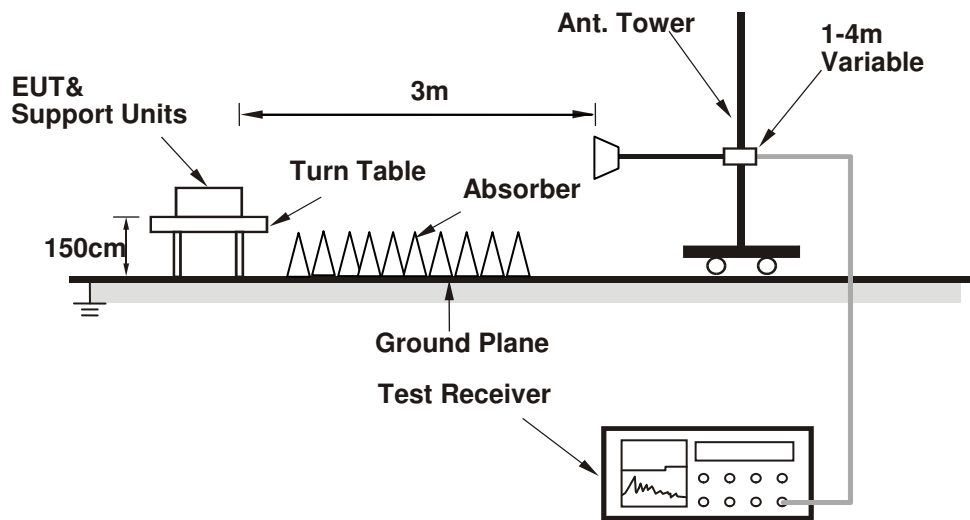

For the actual test configuration, please refer to the attached file (Test Setup Photo).

4.1.6 EUT Operating Conditions

The communication partner run test program “QRCT.exe (Ver3.0.124.0)” to enable EUT under transmission/receiving condition continuously at specific channel frequency.

4.1.7 Test Results

Above 1GHz Data :

802.11b

CHANNEL	TX Channel 1	DETECTOR FUNCTION	Peak (PK)
FREQUENCY RANGE	1GHz ~ 25GHz		Average (AV)

ANTENNA POLARITY & TEST DISTANCE: HORIZONTAL AT 3 M

NO.	FREQ. (MHz)	EMISSION LEVEL (dBuV/m)	LIMIT (dBuV/m)	MARGIN (dB)	ANTENNA HEIGHT (m)	TABLE ANGLE (Degree)	RAW VALUE (dBuV)	CORRECTION FACTOR (dB/m)
1	2390.00	48.2 PK	74.0	-25.8	1.00 H	232	53.9	-5.7
2	2390.00	37.5 AV	54.0	-16.5	1.00 H	232	43.2	-5.7
3	*2412.00	104.2 PK			1.00 H	232	109.8	-5.6
4	*2412.00	101.6 AV			1.00 H	232	107.2	-5.6
5	4824.00	41.3 PK	74.0	-32.7	1.60 H	314	40.5	0.8
6	4824.00	29.3 AV	54.0	-24.7	1.60 H	314	28.5	0.8

ANTENNA POLARITY & TEST DISTANCE: VERTICAL AT 3 M

NO.	FREQ. (MHz)	EMISSION LEVEL (dBuV/m)	LIMIT (dBuV/m)	MARGIN (dB)	ANTENNA HEIGHT (m)	TABLE ANGLE (Degree)	RAW VALUE (dBuV)	CORRECTION FACTOR (dB/m)
1	2390.00	47.7 PK	74.0	-26.3	1.32 V	360	53.4	-5.7
2	2390.00	35.1 AV	54.0	-18.9	1.32 V	360	40.8	-5.7
3	*2412.00	98.3 PK			1.32 V	360	103.9	-5.6
4	*2412.00	96.0 AV			1.32 V	360	101.6	-5.6
5	4824.00	40.2 PK	74.0	-33.8	1.76 V	101	39.4	0.8
6	4824.00	28.6 AV	54.0	-25.4	1.76 V	101	27.8	0.8

REMARKS:

1. Emission Level(dBuV/m) = Raw Value(dBuV) + Correction Factor(dB/m)
2. Correction Factor(dB/m) = Antenna Factor(dB/m) + Cable Factor(dB) – Pre-Amplifier Factor(dB)
3. The other emission levels were very low against the limit.
4. Margin value = Emission Level – Limit value
5. " * ": Fundamental frequency.

CHANNEL	TX Channel 6	DETECTOR FUNCTION	Peak (PK)
FREQUENCY RANGE	1GHz ~ 25GHz		Average (AV)

ANTENNA POLARITY & TEST DISTANCE: HORIZONTAL AT 3 M

NO.	FREQ. (MHz)	EMISSION LEVEL (dBuV/m)	LIMIT (dBuV/m)	MARGIN (dB)	ANTENNA HEIGHT (m)	TABLE ANGLE (Degree)	RAW VALUE (dBuV)	CORRECTION FACTOR (dB/m)
1	2390.00	47.2 PK	74.0	-26.8	1.30 H	230	52.9	-5.7
2	2390.00	35.1 AV	54.0	-18.9	1.30 H	230	40.8	-5.7
3	*2437.00	105.7 PK			1.30 H	230	111.2	-5.5
4	*2437.00	103.5 AV			1.30 H	230	109.0	-5.5
5	2483.50	47.8 PK	74.0	-26.2	1.30 H	230	53.3	-5.5
6	2483.50	36.2 AV	54.0	-17.8	1.30 H	230	41.7	-5.5
7	4874.00	40.9 PK	74.0	-33.1	1.59 H	321	40.0	0.9
8	4874.00	28.9 AV	54.0	-25.1	1.59 H	321	28.0	0.9
9	7311.00	46.7 PK	74.0	-27.3	1.65 H	138	39.3	7.4
10	7311.00	34.6 AV	54.0	-19.4	1.65 H	138	27.2	7.4

ANTENNA POLARITY & TEST DISTANCE: VERTICAL AT 3 M

NO.	FREQ. (MHz)	EMISSION LEVEL (dBuV/m)	LIMIT (dBuV/m)	MARGIN (dB)	ANTENNA HEIGHT (m)	TABLE ANGLE (Degree)	RAW VALUE (dBuV)	CORRECTION FACTOR (dB/m)
1	2390.00	48.3 PK	74.0	-25.7	1.26 V	360	54.0	-5.7
2	2390.00	35.5 AV	54.0	-18.5	1.26 V	360	41.2	-5.7
3	*2437.00	103.1 PK			1.28 V	257	108.6	-5.5
4	*2437.00	100.5 AV			1.28 V	257	106.0	-5.5
5	2483.50	49.5 PK	74.0	-24.5	1.06 V	261	55.0	-5.5
6	2483.50	41.2 AV	54.0	-12.8	1.06 V	261	46.7	-5.5
7	4874.00	40.6 PK	74.0	-33.4	1.85 V	94	39.7	0.9
8	4874.00	28.9 AV	54.0	-25.1	1.85 V	94	28.0	0.9
9	7311.00	46.0 PK	74.0	-28.0	1.28 V	225	38.6	7.4
10	7311.00	33.9 AV	54.0	-20.1	1.28 V	225	26.5	7.4

REMARKS:

1. Emission Level(dBuV/m) = Raw Value(dBuV) + Correction Factor(dB/m)
2. Correction Factor(dB/m) = Antenna Factor(dB/m) + Cable Factor(dB) – Pre-Amplifier Factor(dB)
3. The other emission levels were very low against the limit.
4. Margin value = Emission Level – Limit value
5. " * ": Fundamental frequency.

CHANNEL	TX Channel 11	DETECTOR FUNCTION	Peak (PK)
FREQUENCY RANGE	1GHz ~ 25GHz		Average (AV)

ANTENNA POLARITY & TEST DISTANCE: HORIZONTAL AT 3 M

NO.	FREQ. (MHz)	EMISSION LEVEL (dBuV/m)	LIMIT (dBuV/m)	MARGIN (dB)	ANTENNA HEIGHT (m)	TABLE ANGLE (Degree)	RAW VALUE (dBuV)	CORRECTION FACTOR (dB/m)
1	*2462.00	105.8 PK			1.30 H	235	111.2	-5.4
2	*2462.00	103.4 AV			1.30 H	235	108.8	-5.4
3	2483.50	51.5 PK	74.0	-22.5	1.30 H	235	57.0	-5.5
4	2483.50	43.7 AV	54.0	-10.3	1.30 H	235	49.2	-5.5
5	4924.00	40.5 PK	74.0	-33.5	1.63 H	325	39.4	1.1
6	4924.00	28.6 AV	54.0	-25.4	1.63 H	325	27.5	1.1
7	7386.00	46.2 PK	74.0	-27.8	1.69 H	124	38.6	7.6
8	7386.00	34.1 AV	54.0	-19.9	1.69 H	124	26.5	7.6

ANTENNA POLARITY & TEST DISTANCE: VERTICAL AT 3 M

NO.	FREQ. (MHz)	EMISSION LEVEL (dBuV/m)	LIMIT (dBuV/m)	MARGIN (dB)	ANTENNA HEIGHT (m)	TABLE ANGLE (Degree)	RAW VALUE (dBuV)	CORRECTION FACTOR (dB/m)
1	*2462.00	103.4 PK			1.00 V	253	108.8	-5.4
2	*2462.00	100.7 AV			1.00 V	253	106.1	-5.4
3	2483.50	49.7 PK	74.0	-24.3	1.00 V	253	55.2	-5.5
4	2483.50	41.4 AV	54.0	-12.6	1.00 V	253	46.9	-5.5
5	4924.00	40.1 PK	74.0	-33.9	1.80 V	89	39.0	1.1
6	4924.00	28.4 AV	54.0	-25.6	1.80 V	89	27.3	1.1
7	7386.00	46.1 PK	74.0	-27.9	1.33 V	236	38.5	7.6
8	7386.00	34.2 AV	54.0	-19.8	1.33 V	236	26.6	7.6

REMARKS:

1. Emission Level(dBuV/m) = Raw Value(dBuV) + Correction Factor(dB/m)
2. Correction Factor(dB/m) = Antenna Factor(dB/m) + Cable Factor(dB) – Pre-Amplifier Factor(dB)
3. The other emission levels were very low against the limit.
4. Margin value = Emission Level – Limit value
5. " * ": Fundamental frequency.

802.11g

CHANNEL	TX Channel 1	DETECTOR FUNCTION	Peak (PK)
FREQUENCY RANGE	1GHz ~ 25GHz		Average (AV)

ANTENNA POLARITY & TEST DISTANCE: HORIZONTAL AT 3 M

NO.	FREQ. (MHz)	EMISSION LEVEL (dBuV/m)	LIMIT (dBuV/m)	MARGIN (dB)	ANTENNA HEIGHT (m)	TABLE ANGLE (Degree)	RAW VALUE (dBuV)	CORRECTION FACTOR (dB/m)
1	2390.00	63.4 PK	74.0	-10.6	1.30 H	230	69.1	-5.7
2	2390.00	44.9 AV	54.0	-9.1	1.30 H	230	50.6	-5.7
3	*2412.00	102.6 PK			1.30 H	230	108.2	-5.6
4	*2412.00	90.3 AV			1.30 H	230	95.9	-5.6
5	4824.00	41.9 PK	74.0	-32.1	2.51 H	331	41.1	0.8
6	4824.00	29.5 AV	54.0	-24.5	2.51 H	331	28.7	0.8

ANTENNA POLARITY & TEST DISTANCE: VERTICAL AT 3 M

NO.	FREQ. (MHz)	EMISSION LEVEL (dBuV/m)	LIMIT (dBuV/m)	MARGIN (dB)	ANTENNA HEIGHT (m)	TABLE ANGLE (Degree)	RAW VALUE (dBuV)	CORRECTION FACTOR (dB/m)
1	2390.00	60.5 PK	74.0	-13.5	1.00 V	252	66.2	-5.7
2	2390.00	40.7 AV	54.0	-13.3	1.00 V	252	46.4	-5.7
3	*2412.00	99.8 PK			1.00 V	252	105.4	-5.6
4	*2412.00	87.9 AV			1.00 V	252	93.5	-5.6
5	4824.00	41.3 PK	74.0	-32.7	1.16 V	56	40.5	0.8
6	4824.00	28.2 AV	54.0	-25.8	1.16 V	56	27.4	0.8

REMARKS:

1. Emission Level(dBuV/m) = Raw Value(dBuV) + Correction Factor(dB/m)
2. Correction Factor(dB/m) = Antenna Factor(dB/m) + Cable Factor(dB) – Pre-Amplifier Factor(dB)
3. The other emission levels were very low against the limit.
4. Margin value = Emission Level – Limit value
5. " * ": Fundamental frequency.

CHANNEL	TX Channel 6	DETECTOR FUNCTION	Peak (PK)
FREQUENCY RANGE	1GHz ~ 25GHz		Average (AV)

ANTENNA POLARITY & TEST DISTANCE: HORIZONTAL AT 3 M

NO.	FREQ. (MHz)	EMISSION LEVEL (dBuV/m)	LIMIT (dBuV/m)	MARGIN (dB)	ANTENNA HEIGHT (m)	TABLE ANGLE (Degree)	RAW VALUE (dBuV)	CORRECTION FACTOR (dB/m)
1	2390.00	47.4 PK	74.0	-26.6	1.40 H	233	53.1	-5.7
2	2390.00	34.2 AV	54.0	-19.8	1.40 H	233	39.9	-5.7
3	*2437.00	104.8 PK			1.40 H	233	110.3	-5.5
4	*2437.00	92.7 AV			1.40 H	233	98.2	-5.5
5	2483.50	48.2 PK	74.0	-25.8	1.40 H	233	53.7	-5.5
6	2483.50	35.1 AV	54.0	-18.9	1.40 H	233	40.6	-5.5
7	4874.00	41.3 PK	74.0	-32.7	1.47 H	232	40.4	0.9
8	4874.00	28.3 AV	54.0	-25.7	1.47 H	232	27.4	0.9
9	7311.00	47.2 PK	74.0	-26.8	3.16 H	142	39.8	7.4
10	7311.00	34.1 AV	54.0	-19.9	3.16 H	142	26.7	7.4

ANTENNA POLARITY & TEST DISTANCE: VERTICAL AT 3 M

NO.	FREQ. (MHz)	EMISSION LEVEL (dBuV/m)	LIMIT (dBuV/m)	MARGIN (dB)	ANTENNA HEIGHT (m)	TABLE ANGLE (Degree)	RAW VALUE (dBuV)	CORRECTION FACTOR (dB/m)
1	2390.00	47.3 PK	74.0	-26.7	1.05 V	256	53.0	-5.7
2	2390.00	33.8 AV	54.0	-20.2	1.05 V	256	39.5	-5.7
3	*2437.00	100.7 PK			1.05 V	256	106.2	-5.5
4	*2437.00	89.1 AV			1.05 V	256	94.6	-5.5
5	2483.50	48.4 PK	74.0	-25.6	1.05 V	256	53.9	-5.5
6	2483.50	34.5 AV	54.0	-19.5	1.05 V	256	40.0	-5.5
7	4874.00	41.0 PK	74.0	-33.0	2.04 V	153	40.1	0.9
8	4874.00	29.0 AV	54.0	-25.0	2.04 V	153	28.1	0.9
9	7311.00	46.6 PK	74.0	-27.4	1.85 V	240	39.2	7.4
10	7311.00	34.5 AV	54.0	-19.5	1.85 V	240	27.1	7.4

REMARKS:

1. Emission Level(dBuV/m) = Raw Value(dBuV) + Correction Factor(dB/m)
2. Correction Factor(dB/m) = Antenna Factor(dB/m) + Cable Factor(dB) – Pre-Amplifier Factor(dB)
3. The other emission levels were very low against the limit.
4. Margin value = Emission Level – Limit value
5. " * ": Fundamental frequency.

CHANNEL	TX Channel 11	DETECTOR FUNCTION	Peak (PK)
FREQUENCY RANGE	1GHz ~ 25GHz		Average (AV)

ANTENNA POLARITY & TEST DISTANCE: HORIZONTAL AT 3 M

NO.	FREQ. (MHz)	EMISSION LEVEL (dBuV/m)	LIMIT (dBuV/m)	MARGIN (dB)	ANTENNA HEIGHT (m)	TABLE ANGLE (Degree)	RAW VALUE (dBuV)	CORRECTION FACTOR (dB/m)
1	*2462.00	105.0 PK			1.28 H	232	110.4	-5.4
2	*2462.00	93.0 AV			1.28 H	232	98.4	-5.4
3	2483.50	68.5 PK	74.0	-5.5	1.28 H	232	74.0	-5.5
4	2483.50	48.4 AV	54.0	-5.6	1.28 H	232	53.9	-5.5
5	4924.00	41.7 PK	74.0	-32.3	1.43 H	232	40.6	1.1
6	4924.00	28.4 AV	54.0	-25.6	1.43 H	232	27.3	1.1
7	7386.00	47.3 PK	74.0	-26.7	3.10 H	146	39.7	7.6
8	7386.00	34.4 AV	54.0	-19.6	3.10 H	146	26.8	7.6

ANTENNA POLARITY & TEST DISTANCE: VERTICAL AT 3 M

NO.	FREQ. (MHz)	EMISSION LEVEL (dBuV/m)	LIMIT (dBuV/m)	MARGIN (dB)	ANTENNA HEIGHT (m)	TABLE ANGLE (Degree)	RAW VALUE (dBuV)	CORRECTION FACTOR (dB/m)
1	*2462.00	102.1 PK			1.00 V	254	107.5	-5.4
2	*2462.00	92.3 AV			1.00 V	254	97.7	-5.4
3	2483.50	67.3 PK	74.0	-6.7	1.00 V	254	72.8	-5.5
4	2483.50	46.1 AV	54.0	-7.9	1.00 V	254	51.6	-5.5
5	4924.00	40.8 PK	74.0	-33.2	2.01 V	151	39.7	1.1
6	4924.00	28.6 AV	54.0	-25.4	2.01 V	151	27.5	1.1
7	7386.00	46.4 PK	74.0	-27.6	1.90 V	230	38.8	7.6
8	7386.00	34.5 AV	54.0	-19.5	1.90 V	230	26.9	7.6

REMARKS:

1. Emission Level(dBuV/m) = Raw Value(dBuV) + Correction Factor(dB/m)
2. Correction Factor(dB/m) = Antenna Factor(dB/m) + Cable Factor(dB) – Pre-Amplifier Factor(dB)
3. The other emission levels were very low against the limit.
4. Margin value = Emission Level – Limit value
5. " * ": Fundamental frequency.

802.11n (HT20)

CHANNEL	TX Channel 1	DETECTOR FUNCTION	Peak (PK)
FREQUENCY RANGE	1GHz ~ 25GHz		Average (AV)

ANTENNA POLARITY & TEST DISTANCE: HORIZONTAL AT 3 M

NO.	FREQ. (MHz)	EMISSION LEVEL (dBuV/m)	LIMIT (dBuV/m)	MARGIN (dB)	ANTENNA HEIGHT (m)	TABLE ANGLE (Degree)	RAW VALUE (dBuV)	CORRECTION FACTOR (dB/m)
1	2390.00	63.6 PK	74.0	-10.4	1.06 H	230	69.3	-5.7
2	2390.00	45.7 AV	54.0	-8.3	1.06 H	230	51.4	-5.7
3	*2412.00	102.0 PK			1.06 H	230	107.6	-5.6
4	*2412.00	89.9 AV			1.06 H	230	95.5	-5.6
5	4824.00	42.1 PK	74.0	-31.9	1.47 H	218	41.3	0.8
6	4824.00	28.8 AV	54.0	-25.2	1.47 H	218	28.0	0.8

ANTENNA POLARITY & TEST DISTANCE: VERTICAL AT 3 M

NO.	FREQ. (MHz)	EMISSION LEVEL (dBuV/m)	LIMIT (dBuV/m)	MARGIN (dB)	ANTENNA HEIGHT (m)	TABLE ANGLE (Degree)	RAW VALUE (dBuV)	CORRECTION FACTOR (dB/m)
1	2390.00	58.7 PK	74.0	-15.3	1.00 V	254	64.4	-5.7
2	2390.00	41.3 AV	54.0	-12.7	1.00 V	254	47.0	-5.7
3	*2412.00	98.7 PK			1.00 V	254	104.3	-5.6
4	*2412.00	86.8 AV			1.00 V	254	92.4	-5.6
5	4824.00	41.1 PK	74.0	-32.9	1.99 V	162	40.3	0.8
6	4824.00	28.9 AV	54.0	-25.1	1.99 V	162	28.1	0.8

REMARKS:

1. Emission Level(dBuV/m) = Raw Value(dBuV) + Correction Factor(dB/m)
2. Correction Factor(dB/m) = Antenna Factor(dB/m) + Cable Factor(dB) – Pre-Amplifier Factor(dB)
3. The other emission levels were very low against the limit.
4. Margin value = Emission Level – Limit value
5. " * ": Fundamental frequency.

CHANNEL	TX Channel 6	DETECTOR FUNCTION	Peak (PK)
FREQUENCY RANGE	1GHz ~ 25GHz		Average (AV)

ANTENNA POLARITY & TEST DISTANCE: HORIZONTAL AT 3 M

NO.	FREQ. (MHz)	EMISSION LEVEL (dBuV/m)	LIMIT (dBuV/m)	MARGIN (dB)	ANTENNA HEIGHT (m)	TABLE ANGLE (Degree)	RAW VALUE (dBuV)	CORRECTION FACTOR (dB/m)
1	2390.00	47.6 PK	74.0	-26.4	1.19 H	229	53.3	-5.7
2	2390.00	33.9 AV	54.0	-20.1	1.19 H	229	39.6	-5.7
3	*2437.00	103.6 PK			1.19 H	229	109.1	-5.5
4	*2437.00	91.6 AV			1.19 H	229	97.1	-5.5
5	2483.50	48.2 PK	74.0	-25.8	1.19 H	229	53.7	-5.5
6	2483.50	34.7 AV	54.0	-19.3	1.19 H	229	40.2	-5.5
7	4874.00	41.6 PK	74.0	-32.4	1.48 H	232	40.7	0.9
8	4874.00	28.0 AV	54.0	-26.0	1.48 H	232	27.1	0.9
9	7311.00	47.9 PK	74.0	-26.1	3.08 H	133	40.5	7.4
10	7311.00	34.8 AV	54.0	-19.2	3.08 H	133	27.4	7.4

ANTENNA POLARITY & TEST DISTANCE: VERTICAL AT 3 M

NO.	FREQ. (MHz)	EMISSION LEVEL (dBuV/m)	LIMIT (dBuV/m)	MARGIN (dB)	ANTENNA HEIGHT (m)	TABLE ANGLE (Degree)	RAW VALUE (dBuV)	CORRECTION FACTOR (dB/m)
1	2390.00	47.4 PK	74.0	-26.6	1.00 V	255	53.1	-5.7
2	2390.00	34.0 AV	54.0	-20.0	1.00 V	255	39.7	-5.7
3	*2437.00	100.7 PK			1.00 V	255	106.2	-5.5
4	*2437.00	88.3 AV			1.00 V	255	93.8	-5.5
5	2483.50	47.7 PK	74.0	-26.3	1.00 V	255	53.2	-5.5
6	2483.50	34.7 AV	54.0	-19.3	1.00 V	255	40.2	-5.5
7	4874.00	40.9 PK	74.0	-33.1	1.99 V	152	40.0	0.9
8	4874.00	28.7 AV	54.0	-25.3	1.99 V	152	27.8	0.9
9	7311.00	46.4 PK	74.0	-27.6	1.89 V	235	39.0	7.4
10	7311.00	34.7 AV	54.0	-19.3	1.89 V	235	27.3	7.4

REMARKS:

1. Emission Level(dBuV/m) = Raw Value(dBuV) + Correction Factor(dB/m)
2. Correction Factor(dB/m) = Antenna Factor(dB/m) + Cable Factor(dB) – Pre-Amplifier Factor(dB)
3. The other emission levels were very low against the limit.
4. Margin value = Emission Level – Limit value
5. " * ": Fundamental frequency.

CHANNEL	TX Channel 11	DETECTOR FUNCTION	Peak (PK)
FREQUENCY RANGE	1GHz ~ 25GHz		Average (AV)

ANTENNA POLARITY & TEST DISTANCE: HORIZONTAL AT 3 M

NO.	FREQ. (MHz)	EMISSION LEVEL (dBuV/m)	LIMIT (dBuV/m)	MARGIN (dB)	ANTENNA HEIGHT (m)	TABLE ANGLE (Degree)	RAW VALUE (dBuV)	CORRECTION FACTOR (dB/m)
1	*2462.00	103.0 PK			1.54 H	236	108.4	-5.4
2	*2462.00	91.3 AV			1.54 H	236	96.7	-5.4
3	2483.50	68.0 PK	74.0	-6.0	1.54 H	236	73.5	-5.5
4	2483.50	48.7 AV	54.0	-5.3	1.54 H	236	54.2	-5.5
5	4924.00	41.3 PK	74.0	-32.7	1.45 H	239	40.2	1.1
6	4924.00	28.0 AV	54.0	-26.0	1.45 H	239	26.9	1.1
7	7386.00	47.3 PK	74.0	-26.7	3.14 H	140	39.7	7.6
8	7386.00	34.6 AV	54.0	-19.4	3.14 H	140	27.0	7.6

ANTENNA POLARITY & TEST DISTANCE: VERTICAL AT 3 M

NO.	FREQ. (MHz)	EMISSION LEVEL (dBuV/m)	LIMIT (dBuV/m)	MARGIN (dB)	ANTENNA HEIGHT (m)	TABLE ANGLE (Degree)	RAW VALUE (dBuV)	CORRECTION FACTOR (dB/m)
1	*2462.00	101.1 PK			1.00 V	257	106.5	-5.4
2	*2462.00	90.0 AV			1.00 V	257	95.4	-5.4
3	2483.50	63.8 PK	74.0	-10.2	1.00 V	257	69.3	-5.5
4	2483.50	46.5 AV	54.0	-7.5	1.00 V	257	52.0	-5.5
5	4924.00	41.0 PK	74.0	-33.0	1.98 V	163	39.9	1.1
6	4924.00	28.8 AV	54.0	-25.2	1.98 V	163	27.7	1.1
7	7386.00	46.0 PK	74.0	-28.0	1.90 V	232	38.4	7.6
8	7386.00	34.2 AV	54.0	-19.8	1.90 V	232	26.6	7.6

REMARKS:

1. Emission Level(dBuV/m) = Raw Value(dBuV) + Correction Factor(dB/m)
2. Correction Factor(dB/m) = Antenna Factor(dB/m) + Cable Factor(dB) – Pre-Amplifier Factor(dB)
3. The other emission levels were very low against the limit.
4. Margin value = Emission Level – Limit value
5. " * ": Fundamental frequency.

802.11n (HT40)

CHANNEL	TX Channel 3	DETECTOR FUNCTION	Peak (PK)
FREQUENCY RANGE	1GHz ~ 25GHz		Average (AV)

ANTENNA POLARITY & TEST DISTANCE: HORIZONTAL AT 3 M

NO.	FREQ. (MHz)	EMISSION LEVEL (dBuV/m)	LIMIT (dBuV/m)	MARGIN (dB)	ANTENNA HEIGHT (m)	TABLE ANGLE (Degree)	RAW VALUE (dBuV)	CORRECTION FACTOR (dB/m)
1	2390.00	56.7 PK	74.0	-17.3	1.19 H	232	62.4	-5.7
2	2390.00	41.8 AV	54.0	-12.2	1.19 H	232	47.5	-5.7
3	*2422.00	98.6 PK			1.19 H	232	104.1	-5.5
4	*2422.00	86.1 AV			1.19 H	232	91.6	-5.5
5	4844.00	42.0 PK	74.0	-32.0	1.45 H	245	41.2	0.8
6	4844.00	28.7 AV	54.0	-25.3	1.45 H	245	27.9	0.8
7	7266.00	47.2 PK	74.0	-26.8	3.15 H	145	39.7	7.5
8	7266.00	34.5 AV	54.0	-19.5	3.15 H	145	27.0	7.5

ANTENNA POLARITY & TEST DISTANCE: VERTICAL AT 3 M

NO.	FREQ. (MHz)	EMISSION LEVEL (dBuV/m)	LIMIT (dBuV/m)	MARGIN (dB)	ANTENNA HEIGHT (m)	TABLE ANGLE (Degree)	RAW VALUE (dBuV)	CORRECTION FACTOR (dB/m)
1	2390.00	55.9 PK	74.0	-18.1	1.00 V	254	61.6	-5.7
2	2390.00	39.1 AV	54.0	-14.9	1.00 V	254	44.8	-5.7
3	*2422.00	96.3 PK			1.00 V	254	101.8	-5.5
4	*2422.00	83.2 AV			1.00 V	254	88.7	-5.5
5	4844.00	41.1 PK	74.0	-32.9	2.03 V	148	40.3	0.8
6	4844.00	29.0 AV	54.0	-25.0	2.03 V	148	28.2	0.8
7	7266.00	45.7 PK	74.0	-28.3	1.89 V	233	38.2	7.5
8	7266.00	34.0 AV	54.0	-20.0	1.89 V	233	26.5	7.5

REMARKS:

- Emission Level(dBuV/m) = Raw Value(dBuV) + Correction Factor(dB/m)
- Correction Factor(dB/m) = Antenna Factor(dB/m) + Cable Factor(dB) – Pre-Amplifier Factor(dB)
- The other emission levels were very low against the limit.
- Margin value = Emission Level – Limit value
- " * ": Fundamental frequency.

CHANNEL	TX Channel 6	DETECTOR FUNCTION	Peak (PK)
FREQUENCY RANGE	1GHz ~ 25GHz		Average (AV)

ANTENNA POLARITY & TEST DISTANCE: HORIZONTAL AT 3 M

NO.	FREQ. (MHz)	EMISSION LEVEL (dBuV/m)	LIMIT (dBuV/m)	MARGIN (dB)	ANTENNA HEIGHT (m)	TABLE ANGLE (Degree)	RAW VALUE (dBuV)	CORRECTION FACTOR (dB/m)
1	2390.00	48.2 PK	74.0	-25.8	1.22 H	229	53.9	-5.7
2	2390.00	35.5 AV	54.0	-18.5	1.22 H	229	41.2	-5.7
3	*2437.00	99.6 PK			1.22 H	229	105.1	-5.5
4	*2437.00	86.3 AV			1.22 H	229	91.8	-5.5
5	2483.50	57.6 PK	74.0	-16.4	1.22 H	229	63.1	-5.5
6	2483.50	39.3 AV	54.0	-14.7	1.22 H	229	44.8	-5.5
7	4874.00	41.6 PK	74.0	-32.4	1.49 H	234	40.7	0.9
8	4874.00	28.6 AV	54.0	-25.4	1.49 H	234	27.7	0.9
9	7311.00	47.3 PK	74.0	-26.7	3.19 H	126	39.9	7.4
10	7311.00	34.5 AV	54.0	-19.5	3.19 H	126	27.1	7.4

ANTENNA POLARITY & TEST DISTANCE: VERTICAL AT 3 M

NO.	FREQ. (MHz)	EMISSION LEVEL (dBuV/m)	LIMIT (dBuV/m)	MARGIN (dB)	ANTENNA HEIGHT (m)	TABLE ANGLE (Degree)	RAW VALUE (dBuV)	CORRECTION FACTOR (dB/m)
1	2390.00	47.3 PK	74.0	-26.7	1.10 V	238	53.0	-5.7
2	2390.00	34.7 AV	54.0	-19.3	1.10 V	238	40.4	-5.7
3	*2437.00	96.0 PK			1.10 V	256	101.5	-5.5
4	*2437.00	83.1 AV			1.10 V	256	88.6	-5.5
5	2483.50	54.5 PK	74.0	-19.5	1.10 V	238	60.0	-5.5
6	2483.50	37.8 AV	54.0	-16.2	1.10 V	238	43.3	-5.5
7	4874.00	40.9 PK	74.0	-33.1	2.04 V	140	40.0	0.9
8	4874.00	28.6 AV	54.0	-25.4	2.04 V	140	27.7	0.9
9	7311.00	46.2 PK	74.0	-27.8	1.89 V	238	38.8	7.4
10	7311.00	34.1 AV	54.0	-19.9	1.89 V	238	26.7	7.4

REMARKS:

1. Emission Level(dBuV/m) = Raw Value(dBuV) + Correction Factor(dB/m)
2. Correction Factor(dB/m) = Antenna Factor(dB/m) + Cable Factor(dB) – Pre-Amplifier Factor(dB)
3. The other emission levels were very low against the limit.
4. Margin value = Emission Level – Limit value
5. " * ": Fundamental frequency.

CHANNEL	TX Channel 9	DETECTOR FUNCTION	Peak (PK)
FREQUENCY RANGE	1GHz ~ 25GHz		Average (AV)

ANTENNA POLARITY & TEST DISTANCE: HORIZONTAL AT 3 M

NO.	FREQ. (MHz)	EMISSION LEVEL (dBuV/m)	LIMIT (dBuV/m)	MARGIN (dB)	ANTENNA HEIGHT (m)	TABLE ANGLE (Degree)	RAW VALUE (dBuV)	CORRECTION FACTOR (dB/m)
1	*2452.00	100.0 PK			1.18 H	234	105.5	-5.5
2	*2452.00	86.8 AV			1.18 H	234	92.3	-5.5
3	2483.50	63.1 PK	74.0	-10.9	1.18 H	234	68.6	-5.5
4	2483.50	47.6 AV	54.0	-6.4	1.18 H	234	53.1	-5.5
5	4904.00	41.7 PK	74.0	-32.3	1.41 H	226	40.7	1.0
6	4904.00	28.6 AV	54.0	-25.4	1.41 H	226	27.6	1.0
7	7356.00	47.3 PK	74.0	-26.7	3.13 H	130	39.7	7.6
8	7356.00	34.4 AV	54.0	-19.6	3.13 H	130	26.8	7.6

ANTENNA POLARITY & TEST DISTANCE: VERTICAL AT 3 M

NO.	FREQ. (MHz)	EMISSION LEVEL (dBuV/m)	LIMIT (dBuV/m)	MARGIN (dB)	ANTENNA HEIGHT (m)	TABLE ANGLE (Degree)	RAW VALUE (dBuV)	CORRECTION FACTOR (dB/m)
1	*2452.00	96.1 PK			1.07 V	259	101.6	-5.5
2	*2452.00	83.7 AV			1.07 V	259	89.2	-5.5
3	2483.50	61.9 PK	74.0	-12.1	1.07 V	259	67.4	-5.5
4	2483.50	45.4 AV	54.0	-8.6	1.07 V	259	50.9	-5.5
5	4904.00	40.1 PK	74.0	-33.9	1.96 V	164	39.1	1.0
6	4904.00	28.1 AV	54.0	-25.9	1.96 V	164	27.1	1.0
7	7356.00	46.2 PK	74.0	-27.8	1.88 V	217	38.6	7.6
8	7356.00	34.5 AV	54.0	-19.5	1.88 V	217	26.9	7.6

REMARKS:

1. Emission Level(dBuV/m) = Raw Value(dBuV) + Correction Factor(dB/m)
2. Correction Factor(dB/m) = Antenna Factor(dB/m) + Cable Factor(dB) – Pre-Amplifier Factor(dB)
3. The other emission levels were very low against the limit.
4. Margin value = Emission Level – Limit value
5. " * ": Fundamental frequency.

Below 1GHz Data:

802.11g

CHANNEL	TX Channel 6	DETECTOR FUNCTION	Quasi-Peak (QP)
FREQUENCY RANGE	9kHz ~ 1GHz		

ANTENNA POLARITY & TEST DISTANCE: HORIZONTAL AT 3 M								
NO.	FREQ. (MHz)	EMISSION LEVEL (dBuV/m)	LIMIT (dBuV/m)	MARGIN (dB)	ANTENNA HEIGHT (m)	TABLE ANGLE (Degree)	RAW VALUE (dBuV)	CORRECTION FACTOR (dB/m)
1	84.22	28.0 QP	40.0	-12.0	2.50 H	41	41.6	-13.6
2	137.79	30.0 QP	43.5	-13.5	2.00 H	283	39.1	-9.1
3	281.04	27.8 QP	46.0	-18.2	1.00 H	282	35.7	-7.9
4	309.77	26.6 QP	46.0	-19.4	1.00 H	43	33.7	-7.1
5	783.96	30.2 QP	46.0	-15.8	1.50 H	298	27.1	3.1
6	928.68	31.6 QP	46.0	-14.4	1.50 H	0	26.9	4.7

ANTENNA POLARITY & TEST DISTANCE: VERTICAL AT 3 M								
NO.	FREQ. (MHz)	EMISSION LEVEL (dBuV/m)	LIMIT (dBuV/m)	MARGIN (dB)	ANTENNA HEIGHT (m)	TABLE ANGLE (Degree)	RAW VALUE (dBuV)	CORRECTION FACTOR (dB/m)
1	84.10	30.4 QP	40.0	-9.6	2.50 V	65	44.0	-13.6
2	158.26	29.9 QP	43.5	-13.6	1.00 V	99	38.2	-8.3
3	322.53	24.6 QP	46.0	-21.4	1.50 V	7	31.3	-6.7
4	615.71	29.2 QP	46.0	-16.8	1.50 V	110	29.0	0.2
5	644.35	29.9 QP	46.0	-16.1	1.50 V	360	29.2	0.7
6	850.11	31.3 QP	46.0	-14.7	2.00 V	360	27.8	3.5

REMARKS:

1. Emission Level(dBuV/m) = Raw Value(dBuV) + Correction Factor(dB/m)
2. Correction Factor(dB/m) = Antenna Factor(dB/m) + Cable Factor(dB) – Pre-Amplifier Factor(dB)
3. The other emission levels were very low against the limit.
4. Margin value = Emission Level – Limit value

4.2 Conducted Emission Measurement

4.2.1 Limits of Conducted Emission Measurement

Frequency (MHz)	Conducted Limit (dBuV)	
	Quasi-peak	Average
0.15 - 0.5	66 - 56	56 - 46
0.50 - 5.0	56	46
5.0 - 30.0	60	50

Note: 1. The lower limit shall apply at the transition frequencies.

2. The limit decreases in line with the logarithm of the frequency in the range of 0.15 to 0.50MHz.

4.2.2 Test Instruments

DESCRIPTION & MANUFACTURER	MODEL NO.	SERIAL NO.	CALIBRATED DATE	CALIBRATED UNTIL
Test Receiver R&S	ESCS 30	847124/029	Oct. 24, 2016	Oct. 23, 2017
Line-Impedance Stabilization Network (for EUT) R&S	ESH3-Z5	848773/004	Oct. 26, 2016	Oct. 25, 2017
Line-Impedance Stabilization Network (for Peripheral) R&S	ENV216	100072	June 13, 2016	June 12, 2017
RF Cable	5D-FB	COCCAB-001	Sep. 30, 2016	Sep. 29, 2017
10 dB PAD Mini-Circuits	HAT-10+	CONATT-004	June 20, 2016	June 19, 2017
Software BVADT	BVADT_Cond_ V7.3.7.4	NA	NA	NA

Note:

1. The calibration interval of the above test instruments are 12 months and the calibrations are traceable to NML/ROC and NIST/USA.
2. The test was performed in Shielded Room No. 1.
- 3 Tested Date: Nov. 23, 2016

4.2.3 Test Procedures

- The EUT was placed 0.4 meters from the conducting wall of the shielded room with EUT being connected to the power mains through a line impedance stabilization network (LISN). Other support units were connected to the power mains through another LISN. The two LISNs provide 50 ohm/ 50uH of coupling impedance for the measuring instrument.
- Both lines of the power mains connected to the EUT were checked for maximum conducted interference.
- The frequency range from 150kHz to 30MHz was searched. Emission levels under (Limit - 20dB) was not recorded.

NOTE: The resolution bandwidth and video bandwidth of test receiver is 9kHz for quasi-peak detection (QP) and average detection (AV) at frequency 0.15MHz-30MHz.

4.2.4 Deviation from Test Standard

No deviation.

4.2.5 Test Setup

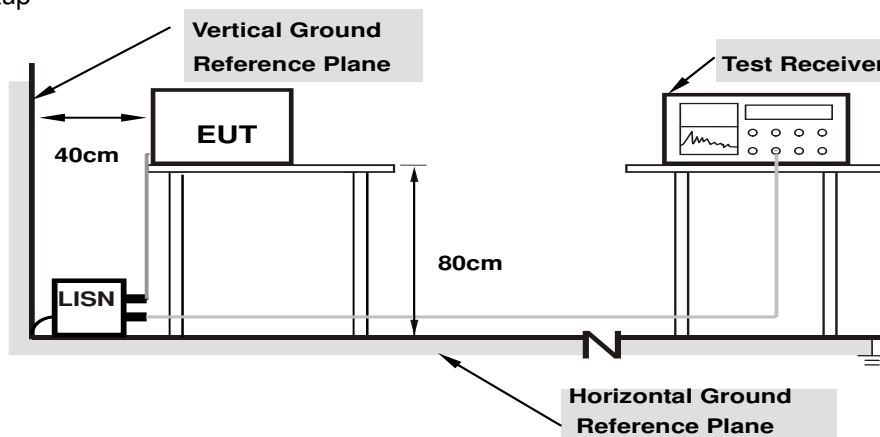

Note: 1.Support units were connected to second LISN.

For the actual test configuration, please refer to the attached file (Test Setup Photo).

4.2.6 EUT Operating Conditions

Same as 4.1.6.

4.2.7 Test Results (Mode 1)

Phase	Line (L)	Detector Function	Quasi-Peak (QP) / Average (AV)
-------	----------	-------------------	--------------------------------

Phase Of Power : Line (L)										
No	Frequency (MHz)	Correction Factor (dB)	Reading Value (dBuV)		Emission Level (dBuV)		Limit (dBuV)		Margin (dB)	
			Q.P.	AV.	Q.P.	AV.	Q.P.	AV.	Q.P.	AV.
1	0.15000	10.20	37.72	23.19	47.92	33.39	66.00	56.00	-18.08	-22.61
2	0.35703	10.23	21.81	12.01	32.04	22.24	58.80	48.80	-26.76	-26.56
3	0.43906	10.24	29.34	20.08	39.58	30.32	57.08	47.08	-17.50	-16.76
4	0.96250	10.30	11.37	2.62	21.67	12.92	56.00	46.00	-34.33	-33.08
5	2.35938	10.29	12.95	2.33	23.24	12.62	56.00	46.00	-32.76	-33.38
6	9.91406	10.72	6.77	-0.13	17.49	10.59	60.00	50.00	-42.51	-39.41

Remarks:

1. Q.P. and AV. are abbreviations of quasi-peak and average individually.
2. The emission levels of other frequencies were very low against the limit.
3. Margin value = Emission level – Limit value
4. Correction factor = Insertion loss + Cable loss
5. Emission Level = Correction Factor + Reading Value

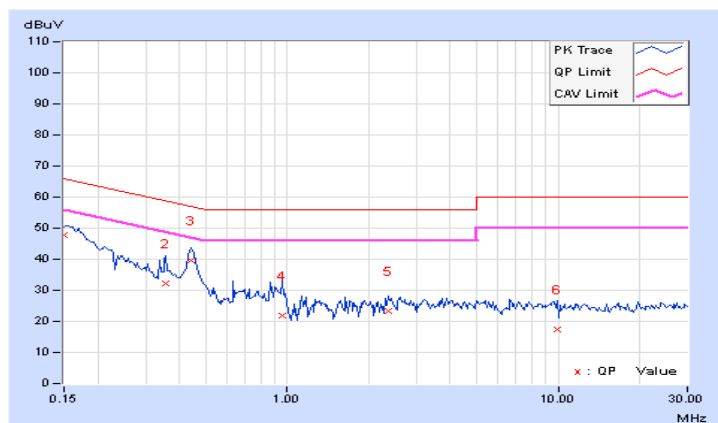

Phase	Neutral (N)	Detector Function	Quasi-Peak (QP) / Average (AV)
-------	-------------	-------------------	--------------------------------

Phase Of Power : Neutral (N)										
No	Frequency (MHz)	Correction Factor (dB)	Reading Value (dBuV)		Emission Level (dBuV)		Limit (dBuV)		Margin (dB)	
			Q.P.	AV.	Q.P.	AV.	Q.P.	AV.	Q.P.	AV.
1	0.15000	10.19	37.89	22.34	48.08	32.53	66.00	56.00	-17.92	-23.47
2	0.18516	10.18	33.14	17.96	43.32	28.14	64.25	54.25	-20.93	-26.11
3	0.27891	10.20	24.57	11.55	34.77	21.75	60.85	50.85	-26.08	-29.10
4	0.47031	10.24	21.12	7.64	31.36	17.88	56.51	46.51	-25.15	-28.63
5	0.59922	10.25	15.01	0.62	25.26	10.87	56.00	46.00	-30.74	-35.13
6	9.36719	10.59	4.48	-1.06	15.07	9.53	60.00	50.00	-44.93	-40.47

Remarks:

1. Q.P. and AV. are abbreviations of quasi-peak and average individually.
2. The emission levels of other frequencies were very low against the limit.
3. Margin value = Emission level – Limit value
4. Correction factor = Insertion loss + Cable loss
5. Emission Level = Correction Factor + Reading Value

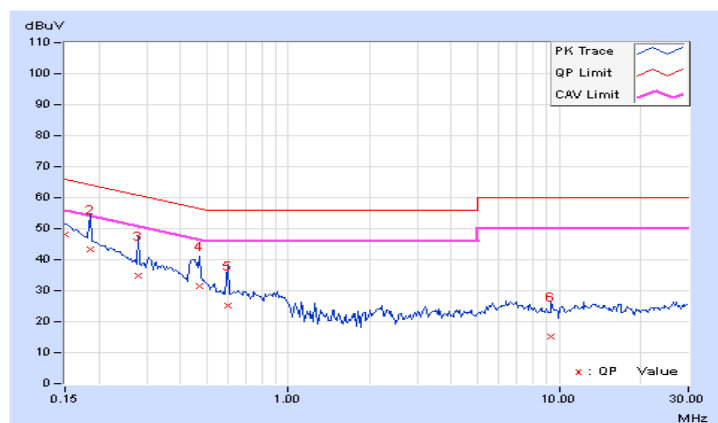

4.2.8 Test Results (Mode 2)

Phase	Line (L)	Detector Function	Quasi-Peak (QP) / Average (AV)
-------	----------	-------------------	--------------------------------

Phase Of Power : Line (L)										
No	Frequency (MHz)	Correction Factor (dB)	Reading Value (dBuV)		Emission Level (dBuV)		Limit (dBuV)		Margin (dB)	
			Q.P.	AV.	Q.P.	AV.	Q.P.	AV.	Q.P.	AV.
1	0.15000	10.19	34.84	18.50	45.03	28.69	66.00	56.00	-20.97	-27.31
2	0.18125	10.19	30.68	17.38	40.87	27.57	64.43	54.43	-23.56	-26.86
3	0.50156	10.23	26.52	21.04	36.75	31.27	56.00	46.00	-19.25	-14.73
4	0.90391	10.25	16.87	10.71	27.12	20.96	56.00	46.00	-28.88	-25.04
5	3.06250	10.24	26.02	20.58	36.26	30.82	56.00	46.00	-19.74	-15.18
6	10.21094	10.57	17.26	11.07	27.83	21.64	60.00	50.00	-32.17	-28.36

Remarks:

1. Q.P. and AV. are abbreviations of quasi-peak and average individually.
2. The emission levels of other frequencies were very low against the limit.
3. Margin value = Emission level – Limit value
4. Correction factor = Insertion loss + Cable loss
5. Emission Level = Correction Factor + Reading Value

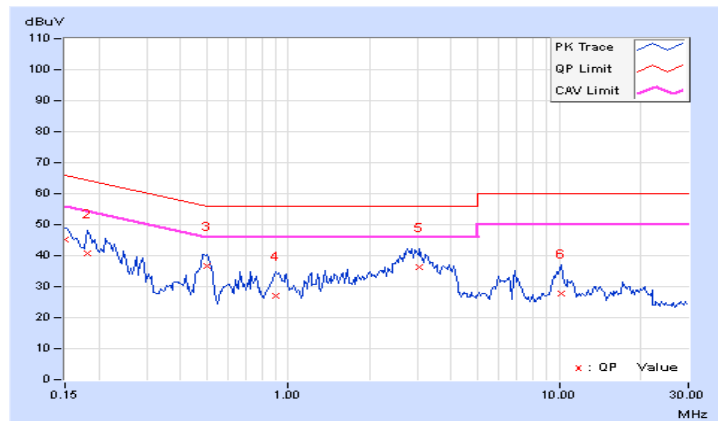

Phase	Neutral (N)	Detector Function	Quasi-Peak (QP) / Average (AV)
-------	-------------	-------------------	--------------------------------

Phase Of Power : Neutral (N)										
No	Frequency (MHz)	Correction Factor (dB)	Reading Value (dBuV)		Emission Level (dBuV)		Limit (dBuV)		Margin (dB)	
			Q.P.	AV.	Q.P.	AV.	Q.P.	AV.	Q.P.	AV.
1	0.15781	10.18	34.59	18.47	44.77	28.65	65.58	55.58	-20.81	-26.93
2	0.18906	10.16	28.08	12.95	38.24	23.11	64.08	54.08	-25.84	-30.97
3	0.49375	10.21	24.68	18.33	34.89	28.54	56.10	46.10	-21.21	-17.56
4	2.79297	10.23	27.62	21.69	37.85	31.92	56.00	46.00	-18.15	-14.08
5	4.07031	10.16	18.38	12.55	28.54	22.71	56.00	46.00	-27.46	-23.29
6	10.00000	10.49	19.60	13.13	30.09	23.62	60.00	50.00	-29.91	-26.38

Remarks:

1. Q.P. and AV. are abbreviations of quasi-peak and average individually.
2. The emission levels of other frequencies were very low against the limit.
3. Margin value = Emission level – Limit value
4. Correction factor = Insertion loss + Cable loss
5. Emission Level = Correction Factor + Reading Value

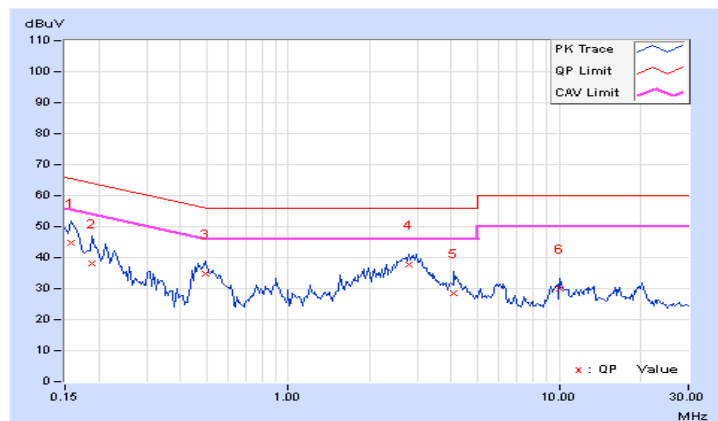

4.3 6dB Bandwidth Measurement

4.3.1 Limits of 6dB Bandwidth Measurement

The minimum of 6dB Bandwidth Measurement is 0.5 MHz.

4.3.2 Test Setup

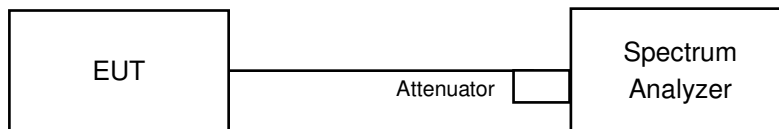

4.3.3 Test Instruments

Refer to section 4.1.2 to get information of above instrument.

4.3.4 Test Procedure

- a. Set resolution bandwidth (RBW) = 100kHz
- b. Set the video bandwidth (VBW) $\geq 3 \times$ RBW, Detector = Peak.
- c. Trace mode = max hold.
- d. Sweep = auto couple.
- e. Measure the maximum width of the emission that is constrained by the frequencies associated with the two amplitude points (upper and lower) that are attenuated by 6 dB relative to the maximum level measured in the fundamental emission

4.3.5 Deviation from Test Standard

No deviation.

4.3.6 EUT Operating Conditions

The software provided by client to enable the EUT under transmission condition continuously at lowest, middle and highest channel frequencies individually.

4.3.7 Test Result

802.11b

Channel	Frequency (MHz)	6dB Bandwidth (MHz)	Minimum Limit (MHz)	Pass / Fail
1	2412	8.06	0.5	PASS
6	2437	8.06	0.5	PASS
11	2462	7.64	0.5	PASS

802.11g

Channel	Frequency (MHz)	6dB Bandwidth (MHz)	Minimum Limit (MHz)	Pass / Fail
1	2412	16.42	0.5	PASS
6	2437	16.43	0.5	PASS
11	2462	16.38	0.5	PASS

802.11n (HT20)

Channel	Frequency (MHz)	6dB Bandwidth (MHz)	Minimum Limit (MHz)	Pass / Fail
1	2412	17.38	0.5	Pass
6	2437	17.68	0.5	Pass
11	2462	17.40	0.5	Pass

802.11n (HT40)

Channel	Frequency (MHz)	6dB Bandwidth (MHz)	Minimum Limit (MHz)	Pass / Fail
3	2422	35.35	0.5	Pass
6	2437	35.65	0.5	Pass
9	2452	35.16	0.5	Pass

Spectrum Plot of Worst Value

802.11b / CH11

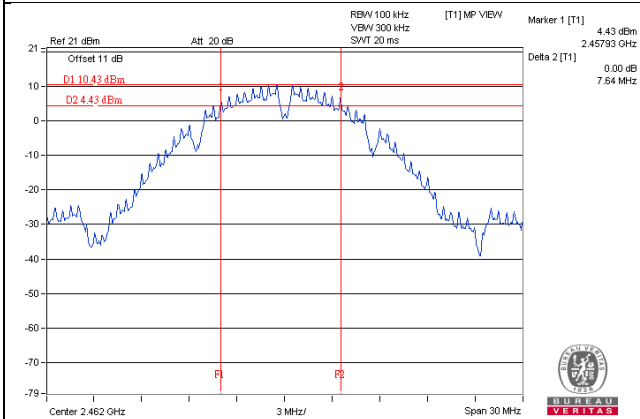

802.11g / CH11

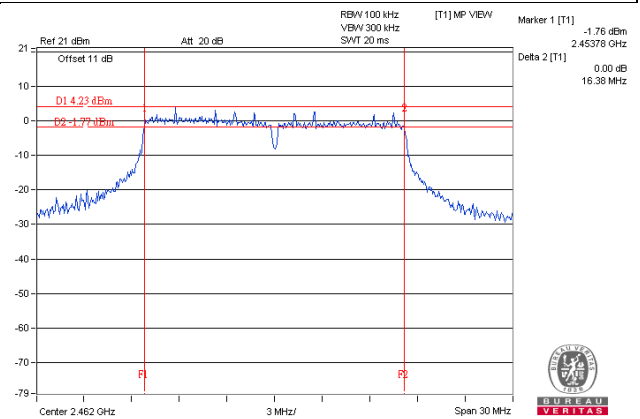

802.11n (HT20) / CH1

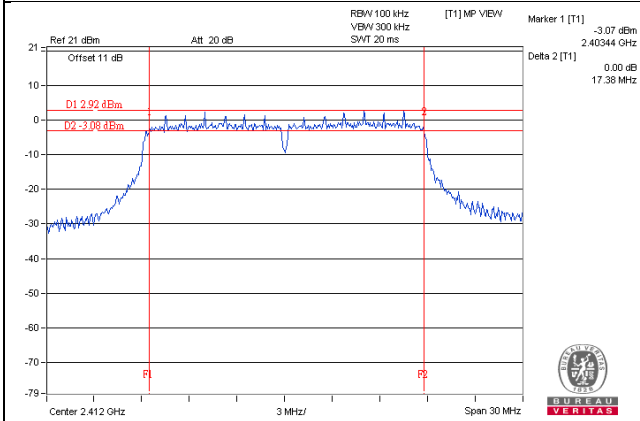

802.11n (HT40) / CH9

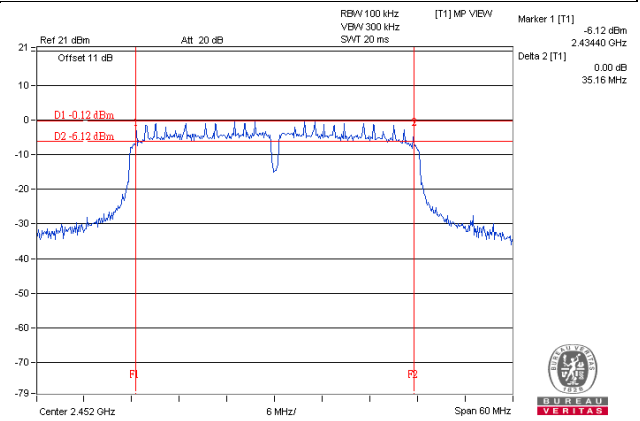

4.4 Conducted Output Power Measurement

4.4.1 Limits of Conducted Output Power Measurement

For systems using digital modulation in the 2400–2483.5 MHz bands: 1 Watt (30dBm)

4.4.2 Test Setup

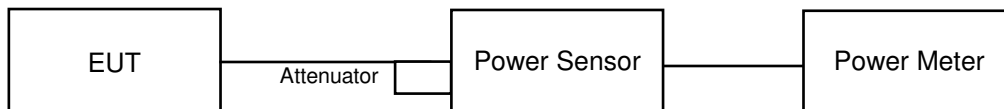

4.4.3 Test Instruments

Refer to section 4.1.2 to get information of above instrument.

4.4.4 Test Procedures

A peak / average power sensor was used on the output port of the EUT. A power meter was used to read the response of the peak / average power sensor. Record the power level.

4.4.5 Deviation from Test Standard

No deviation.

4.4.6 EUT Operating Conditions

Same as Item 4.3.6.

4.4.7 Test Results

FOR PEAK POWER

802.11b

Channel	Frequency (MHz)	Peak Power (mW)	Peak Power (dBm)	Limit (dBm)	Pass/Fail
1	2412	133.352	21.25	30	Pass
6	2437	136.773	21.36	30	Pass
11	2462	142.561	21.54	30	Pass

802.11g

Channel	Frequency (MHz)	Peak Power (mW)	Peak Power (dBm)	Limit (dBm)	Pass/Fail
1	2412	139.959	21.46	30	Pass
6	2437	145.881	21.64	30	Pass
11	2462	151.705	21.81	30	Pass

802.11n (HT20)

Channel	Frequency (MHz)	Peak Power (mW)	Peak Power (dBm)	Limit (dBm)	Pass/Fail
1	2412	116.95	20.68	30	Pass
6	2437	126.765	21.03	30	Pass
11	2462	127.35	21.05	30	Pass

802.11n (HT40)

Channel	Frequency (MHz)	Peak Power (mW)	Peak Power (dBm)	Limit (dBm)	Pass/Fail
3	2422	111.173	20.46	30	Pass
6	2437	106.66	20.28	30	Pass
9	2452	107.399	20.31	30	Pass

FOR AVERAGE POWER

802.11b

Channel	Frequency (MHz)	Average Power (mW)	Average Power (dBm)
1	2412	74.302	18.71
6	2437	76.913	18.86
11	2462	78.343	18.94

802.11g

Channel	Frequency (MHz)	Average Power (mW)	Average Power (dBm)
1	2412	30.061	14.78
6	2437	31.405	14.97
11	2462	30.479	14.84

802.11n (HT20)

Channel	Frequency (MHz)	Average Power (mW)	Average Power (dBm)
1	2412	25.235	14.02
6	2437	26.424	14.22
11	2462	26.546	14.24

802.11n (HT40)

Channel	Frequency (MHz)	Average Power (mW)	Average Power (dBm)
3	2422	17.458	12.42
6	2437	18.707	12.72
9	2452	18.281	12.62

4.5 Power Spectral Density Measurement

4.5.1 Limits of Power Spectral Density Measurement

The Maximum of Power Spectral Density Measurement is 8dBm.

4.5.2 Test Setup

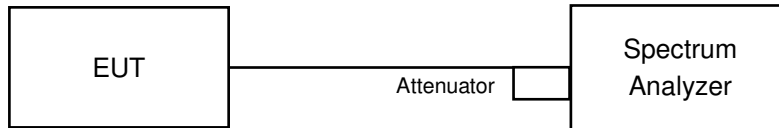

4.5.3 Test Instruments

Refer to section 4.1.2 to get information of above instrument.

4.5.4 Test Procedure

- Set analyzer center frequency to DTS channel center frequency.
- Set the span to 1.5 times the DTS bandwidth.
- Set the RBW to: $3 \text{ kHz} \leq \text{RBW} \leq 100 \text{ kHz}$.
- Set the VBW $\geq 3 \times \text{RBW}$.
- Detector = peak.
- Sweep time = auto couple.
- Trace mode = max hold.
- Allow trace to fully stabilize.
- Use the peak marker function to determine the maximum amplitude level within the RBW.

4.5.5 Deviation from Test Standard

No deviation.

4.5.6 EUT Operating Condition

Same as Item 4.3.6

4.5.7 Test Results

802.11b

Channel	Freq. (MHz)	PSD (dBm/3kHz)	Limit (dBm/3kHz)	Pass /Fail
1	2412	-3.84	8	Pass
6	2437	-4.77	8	Pass
11	2462	-4.46	8	Pass

802.11g

Channel	Freq. (MHz)	PSD (dBm/3kHz)	Limit (dBm/3kHz)	Pass /Fail
1	2412	-10.93	8	Pass
6	2437	-10.91	8	Pass
11	2462	-10.33	8	Pass

802.11n (HT20)

Channel	Freq. (MHz)	PSD (dBm/3kHz)	Limit (dBm/3kHz)	Pass /Fail
1	2412	-12.22	8	Pass
6	2437	-11.00	8	Pass
11	2462	-12.04	8	Pass

802.11n (HT40)

Channel	Freq. (MHz)	PSD (dBm/3kHz)	Limit (dBm/3kHz)	Pass /Fail
3	2422	-16.96	8	Pass
6	2437	-15.03	8	Pass
9	2452	-15.66	8	Pass

Spectrum Plot of Worst Value

802.11b / CH1

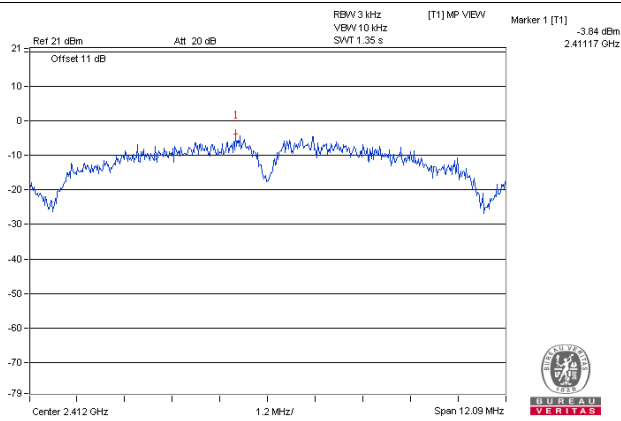

802.11g / CH11

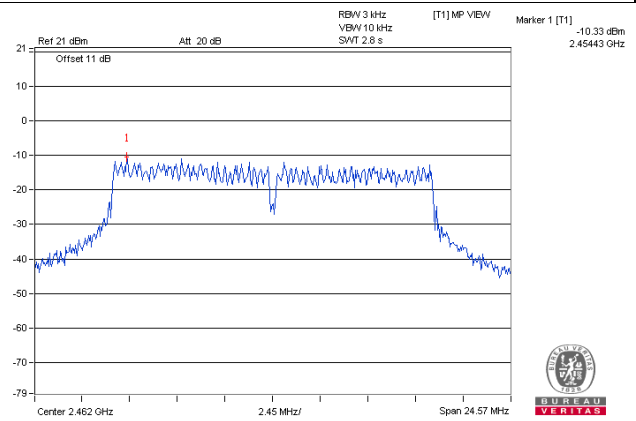

802.11n (HT20) / CH6

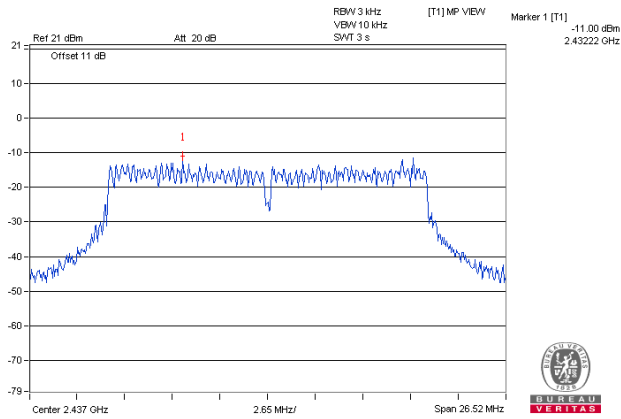

802.11n (HT40) / CH6

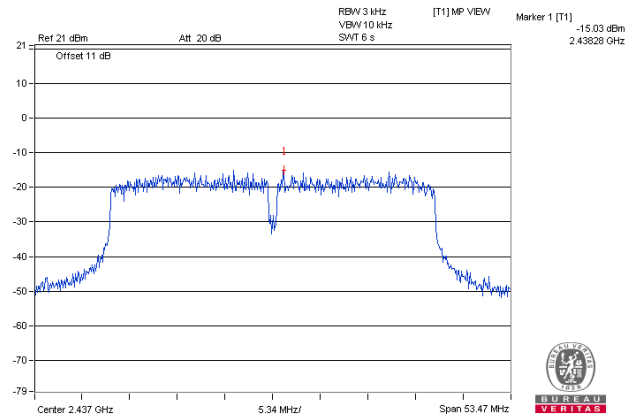

4.6 Conducted Out of Band Emission Measurement

4.6.1 Limits of Conducted Out of Band Emission Measurement

Below 20dB of the highest emission level of operating band (in 100kHz Resolution Bandwidth).

4.6.2 Test Setup

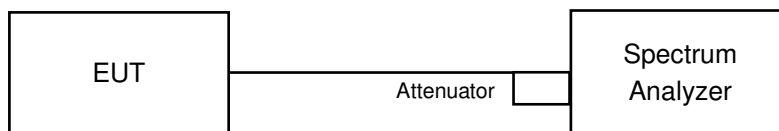

4.6.3 Test Instruments

Refer to section 4.1.2 to get information of above instrument.

4.6.4 Test Procedure

MEASUREMENT PROCEDURE REF

1. Set the RBW = 100 kHz.
2. Set the VBW \geq 300 kHz.
3. Detector = peak.
4. Sweep time = auto couple.
5. Trace mode = max hold.
6. Allow trace to fully stabilize.
7. Use the peak marker function to determine the maximum power level in any 100 kHz band segment within the fundamental EBW.

MEASUREMENT PROCEDURE OOB

1. Set RBW = 100 kHz.
2. Set VBW \geq 300 kHz.
3. Detector = peak.
4. Sweep = auto couple.
5. Trace Mode = max hold.
6. Allow trace to fully stabilize.
7. Use the peak marker function to determine the maximum amplitude level.

4.6.5 Deviation from Test Standard

No deviation.

4.6.6 EUT Operating Condition

Same as Item 4.3.6

4.6.7 Test Results

The spectrum plots are attached on the following pages. D1 line indicates the highest level, and D2 line indicates the 20dB offset below D1. It shows compliance with the requirement.

802.11b

CH 1

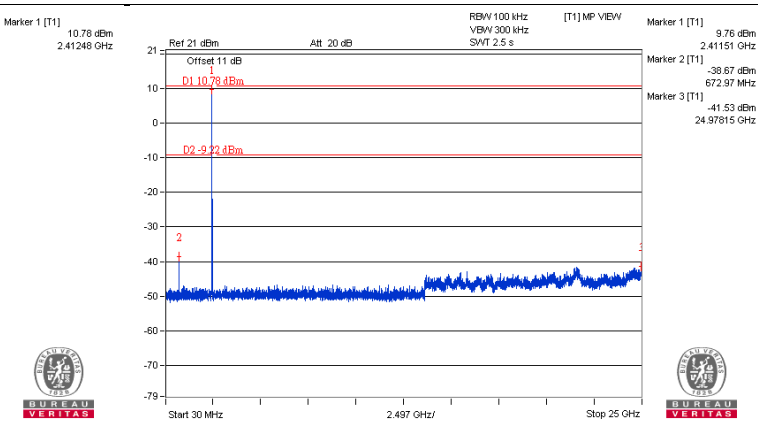
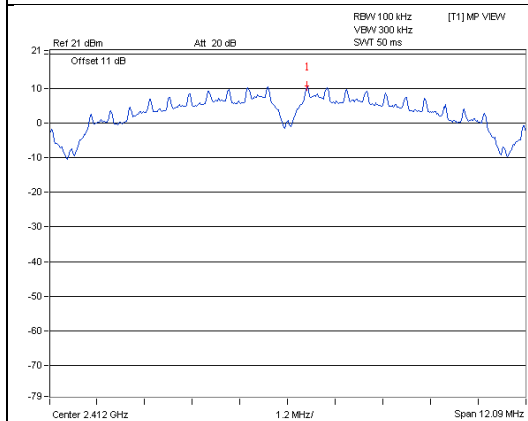

CH 6

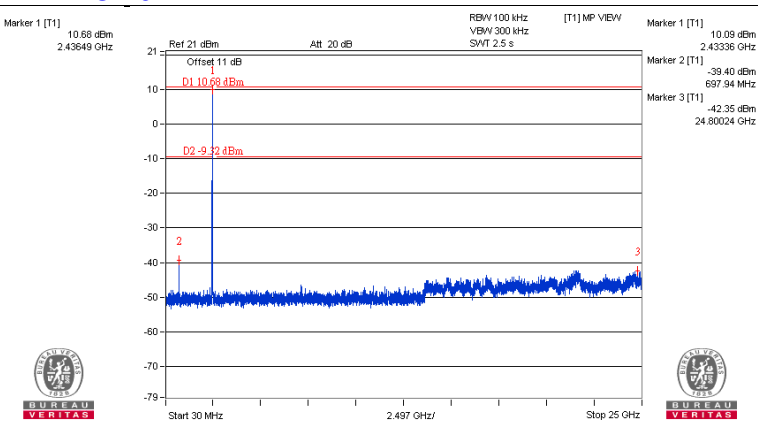
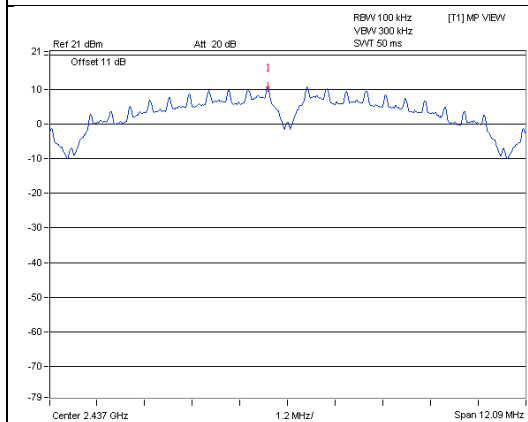

CH 11

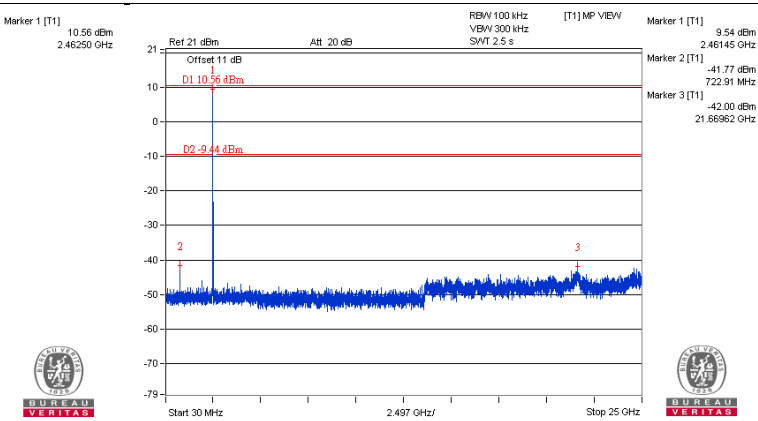
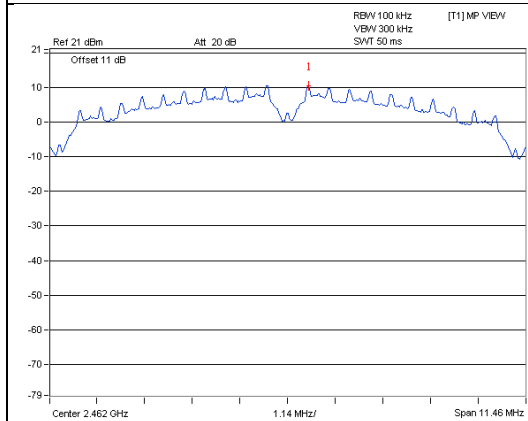

CH 1 Band edge

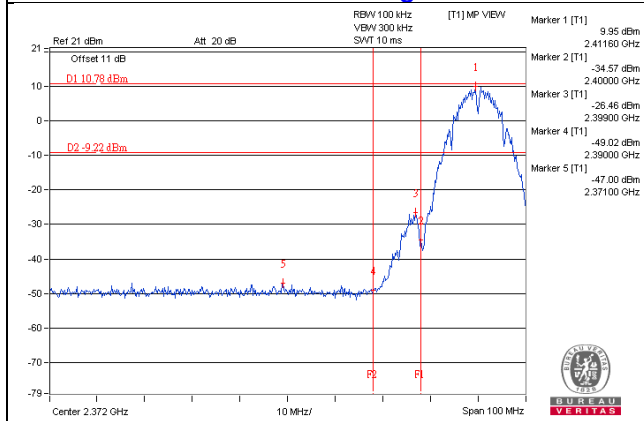

CH 11 Band edge

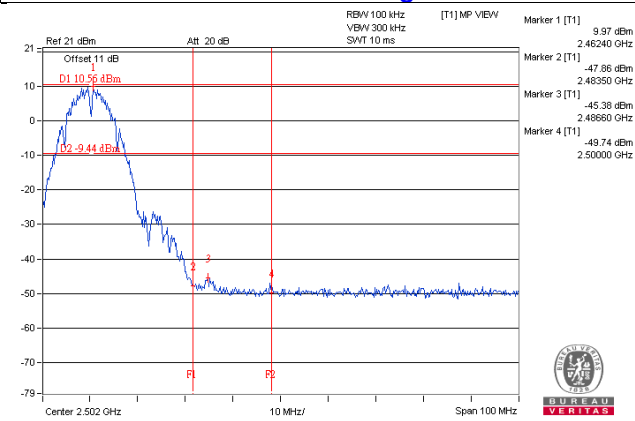

802.11g

CH 1

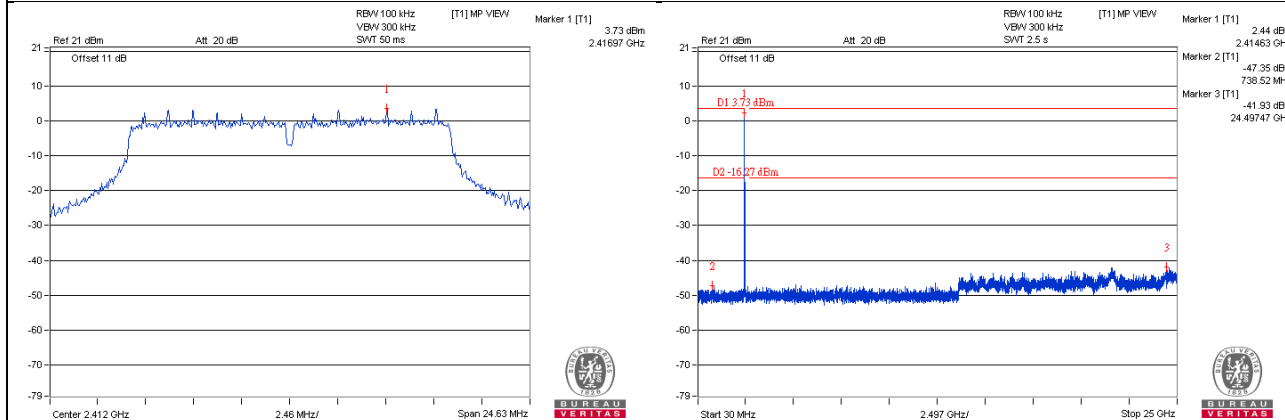

CH 6

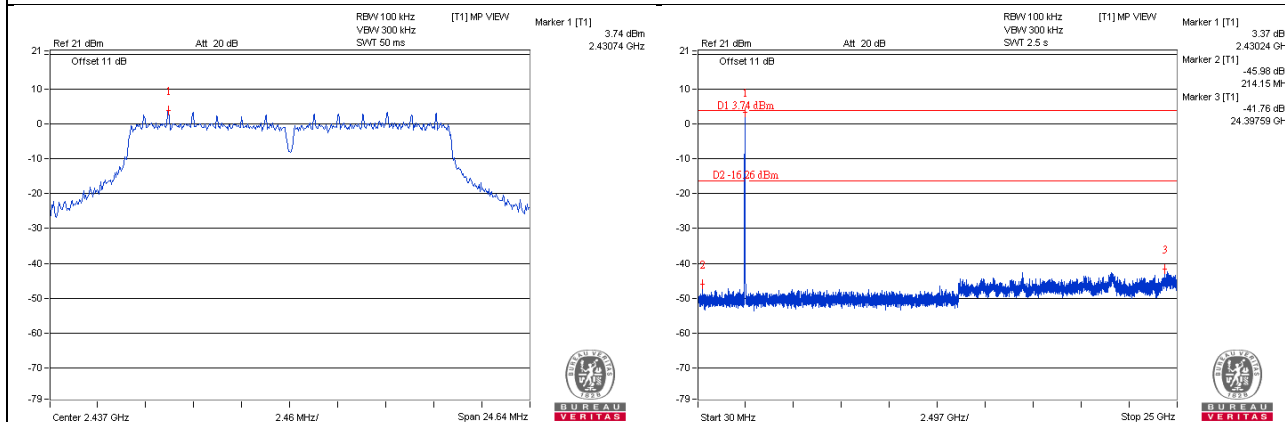

CH 11

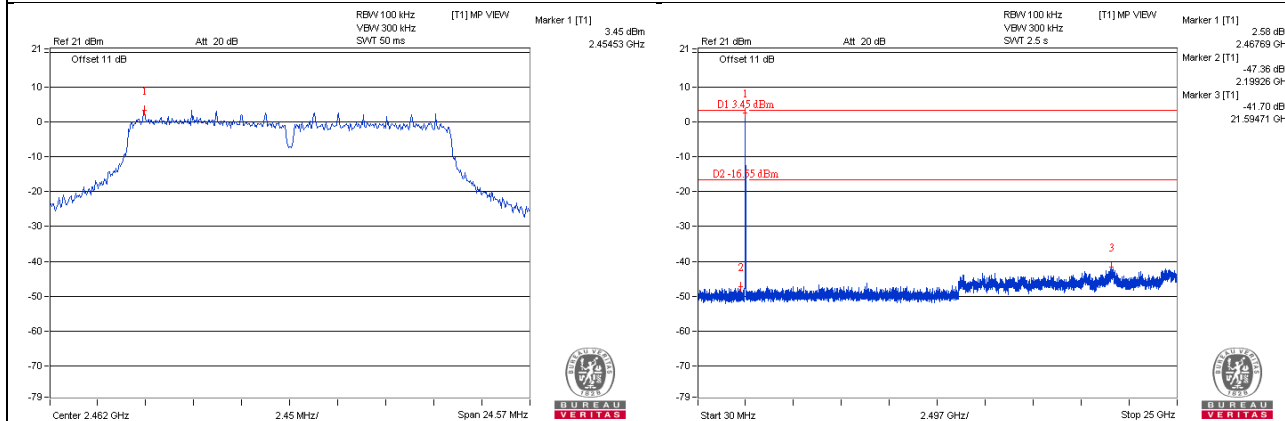

CH 1 Band edge

CH 11 Band edge

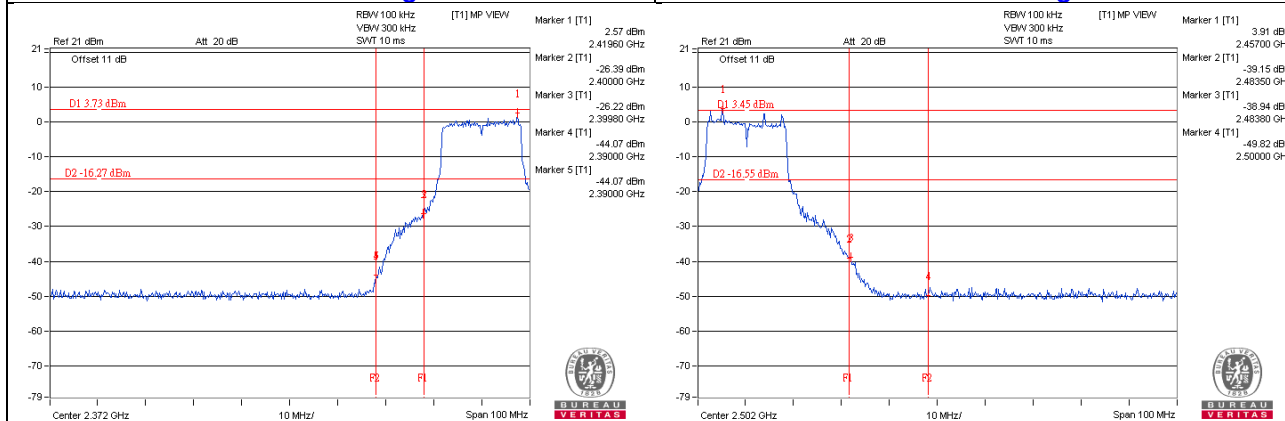

802.11n (HT20)

CH 1

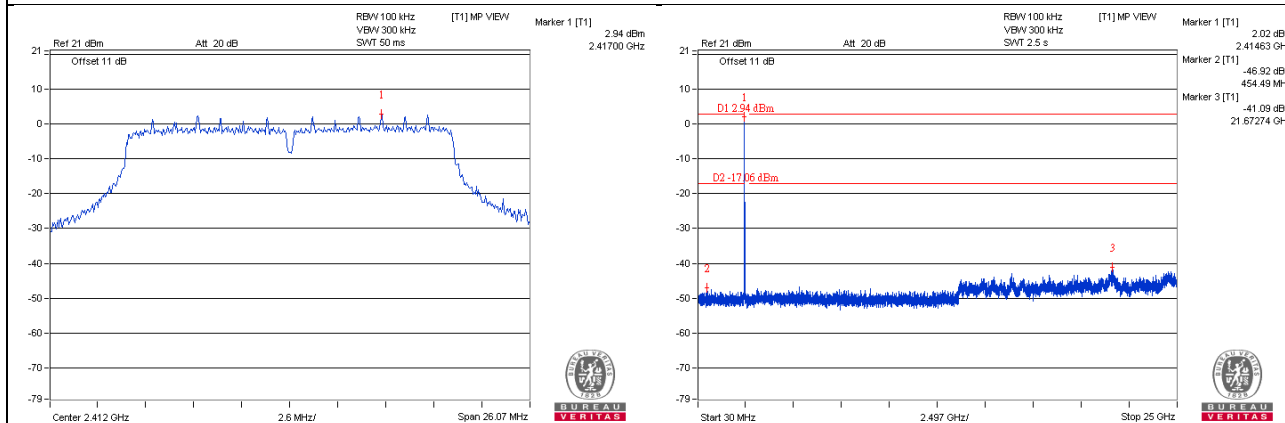

CH 6

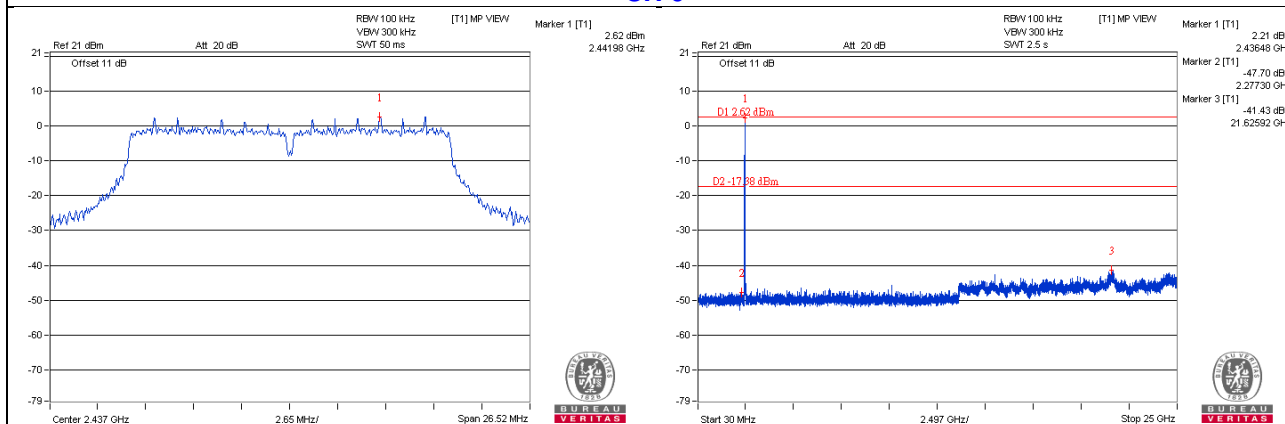

CH 11

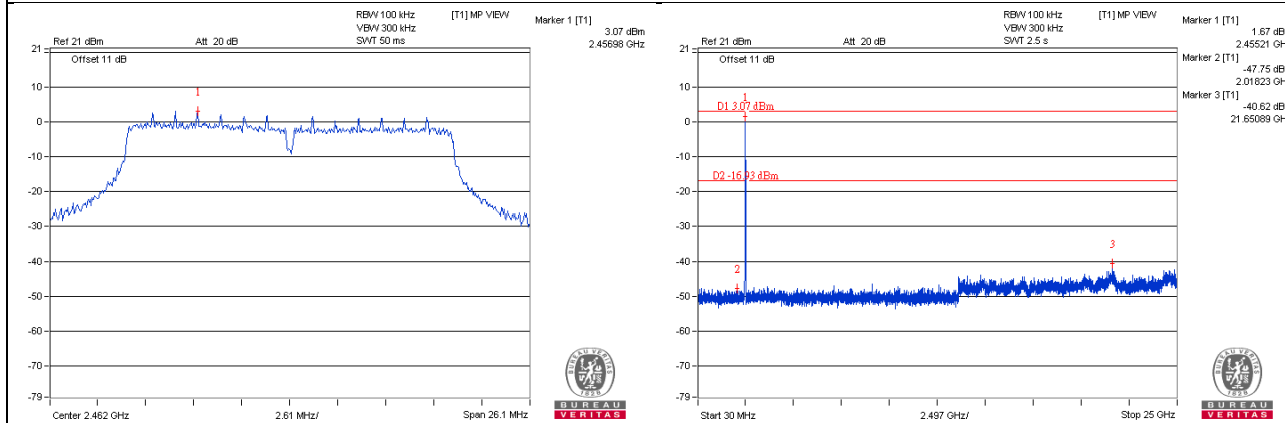

CH 1 Band edge

CH 11 Band edge

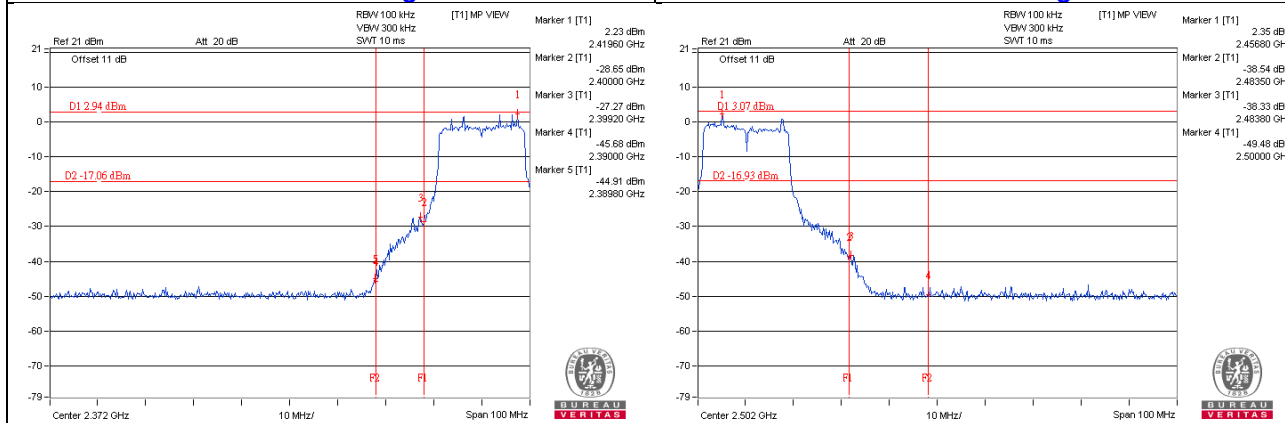

802.11n (HT40)

CH 3

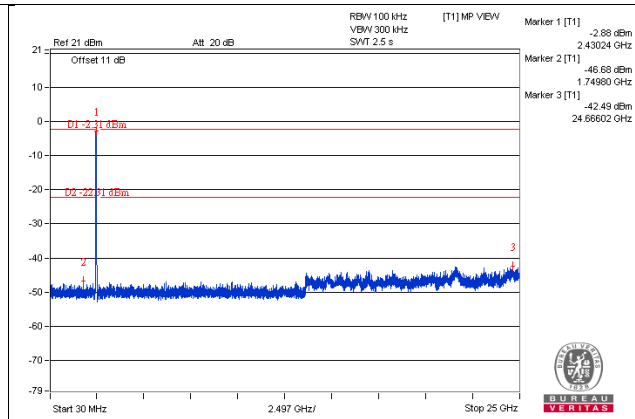
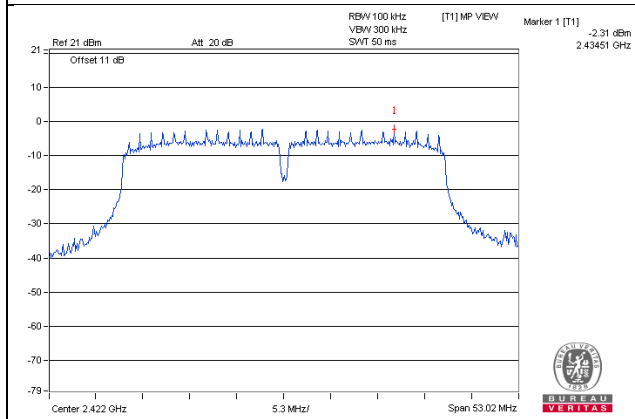

CH 6

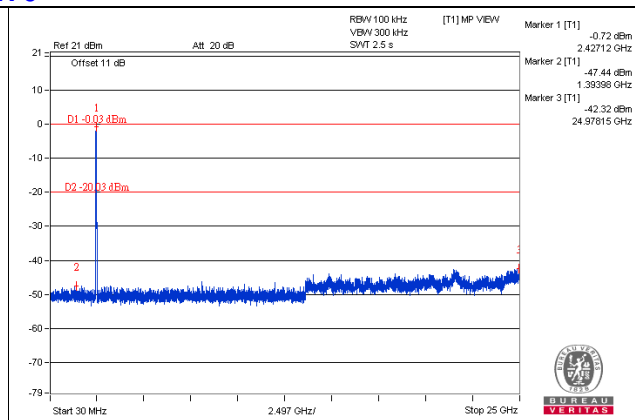
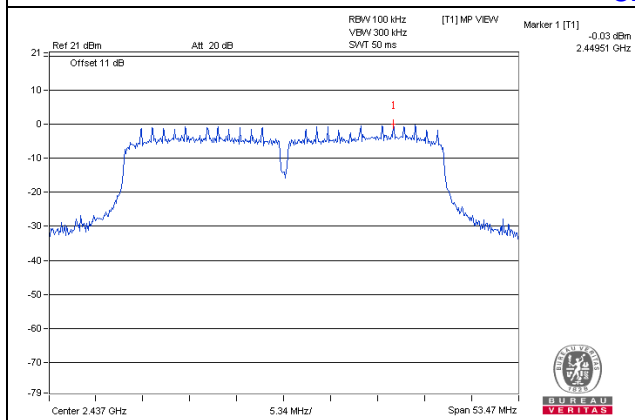

CH 9

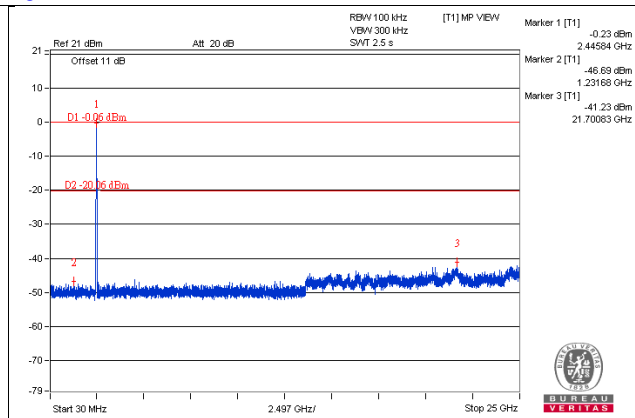
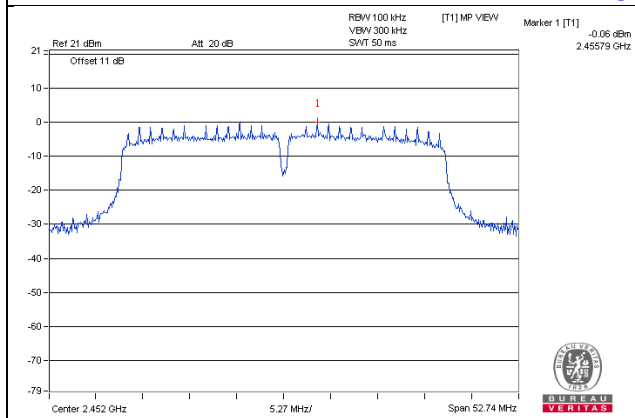

CH 3 Band edge

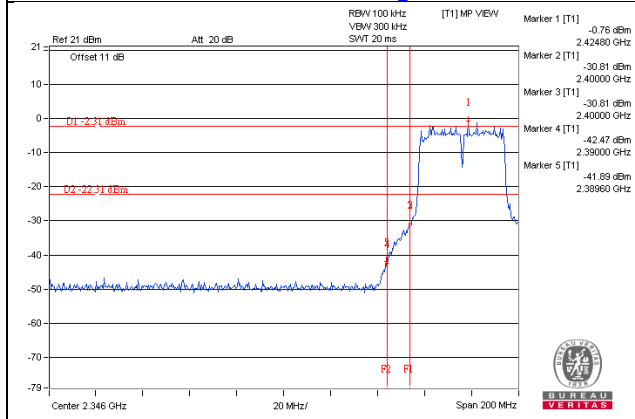

CH 9 Band edge

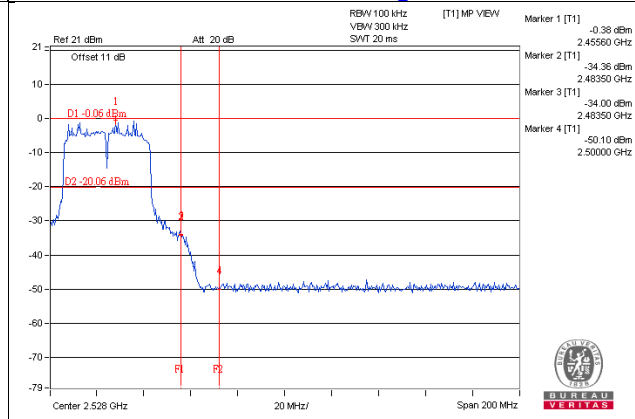

5 Pictures of Test Arrangements

Please refer to the attached file (Test Setup Photo).

Appendix – Information on the Testing Laboratories

We, Bureau Veritas Consumer Products Services (H.K.) Ltd., Taoyuan Branch, were founded in 1988 to provide our best service in EMC, Radio, Telecom and Safety consultation. Our laboratories are accredited and approved according to ISO/IEC 17025.

If you have any comments, please feel free to contact us at the following:

Linko EMC/RF Lab

Tel: 886-2-26052180

Fax: 886-2-26051924

Hsin Chu EMC/RF/Telecom Lab

Tel: 886-3-6668565

Fax: 886-3-6668323

Hwa Ya EMC/RF/Safety Lab

Tel: 886-3-3183232

Fax: 886-3-3270892

Email: service.adt@tw.bureauveritas.com

Web Site: www.bureauveritas-adt.com

The address and road map of all our labs can be found in our web site also.

--- END ---