

## FCC Test Report (BT-EDR)

**Report No.:** RF161110E09-5

**FCC ID:** MQT-E200NP

**Test Model:** xCL\_E200NP-UN5

**Series Model:** xCL\_E200NP-UNN, xCL\_E200NP-NN5, xCL\_E200NP-NNN

**Received Date:** Nov. 10, 2016

**Test Date:** Nov. 23 to Dec. 20, 2016

**Issued Date:** Jan. 23, 2017

**Applicant:** XAC AUTOMATION CORP.

**Address:** 4F, No. 30, INDUSTRY E. RD. IX, SCIENCE-BASED INDUSTRIAL  
PARK,HSINCHU,TAIWAN

**Issued By:** Bureau Veritas Consumer Products Services (H.K.) Ltd., Taoyuan Branch  
Hsin Chu Laboratory

**Lab Address:** E-2, No.1, Li Hsin 1st Road, Hsinchu Science Park, Hsinchu City 300,  
Taiwan R.O.C.

**Test Location (1):** E-2, No.1, Li Hsin 1st Road, Hsinchu Science Park, Hsinchu City 300,  
Taiwan R.O.C.

**Test Location (2):** No. 49, Ln. 206, Wende Rd., Shangshan Tsuen, Chiung Lin Hsiang, Hsin  
Chu Hsien 307, Taiwan R.O.C.



This report is for your exclusive use. Any copying or replication of this report to or for any other person or entity, or use of our name or trademark, is permitted only with our prior written permission. This report sets forth our findings solely with respect to the test samples identified herein. The results set forth in this report are not indicative or representative of the quality or characteristics of the lot from which a test sample was taken or any similar or identical product unless specifically and expressly noted. Our report includes all of the tests requested by you and the results thereof based upon the information that you provided to us. You have 60 days from date of issuance of this report to notify us of any material error or omission caused by our negligence, provided, however, that such notice shall be in writing and shall specifically address the issue you wish to raise. A failure to raise such issue within the prescribed time shall constitute your unqualified acceptance of the completeness of this report, the tests conducted and the correctness of the report contents. Unless specific mention, the uncertainty of measurement has been explicitly taken into account to declare the compliance or non-compliance to the specification. The report must not be used by the client to claim product certification, approval, or endorsement by TAF or any government agencies.

## Table of Contents

|  |           |
|--|-----------|
| <b>Release Control Record</b> .....                              | <b>4</b>  |
| <b>1 Certificate of Conformity</b> .....                         | <b>5</b>  |
| <b>2 Summary of Test Results</b> .....                           | <b>6</b>  |
| 2.1 Measurement Uncertainty .....                                | 6         |
| 2.2 Modification Record .....                                    | 6         |
| <b>3 General Information</b> .....                               | <b>7</b>  |
| 3.1 General Description of EUT (BT-EDR) .....                    | 7         |
| 3.2 Description of Test Modes .....                              | 9         |
| 3.2.1 Test Mode Applicability and Tested Channel Detail .....    | 10        |
| 3.3 Description of Support Units .....                           | 12        |
| 3.3.1 Configuration of System under Test .....                   | 13        |
| 3.4 General Description of Applied Standards .....               | 15        |
| <b>4 Test Types and Results</b> .....                            | <b>16</b> |
| 4.1 Radiated Emission and Bandedge Measurement .....             | 16        |
| 4.1.1 Limits of Radiated Emission and Bandedge Measurement ..... | 16        |
| 4.1.2 Test Instruments .....                                     | 17        |
| 4.1.3 Test Procedures .....                                      | 19        |
| 4.1.4 Deviation from Test Standard .....                         | 19        |
| 4.1.5 Test Setup .....   | 20        |
| 4.1.6 EUT Operating Conditions .....                             | 21        |
| 4.1.7 Test Results .....   | 22        |
| 4.2 Conducted Emission Measurement .....                         | 29        |
| 4.2.1 Limits of Conducted Emission Measurement .....             | 29        |
| 4.2.2 Test Instruments .....                                     | 29        |
| 4.2.3 Test Procedures .....                                      | 30        |
| 4.2.4 Deviation From Test Standard .....                         | 30        |
| 4.2.5 Test Setup .....   | 30        |
| 4.2.6 EUT Operating Condition .....                              | 30        |
| 4.2.7 Test Results (Mode 1) .....                                | 31        |
| 4.2.8 Test Results (Mode 2) .....                                | 33        |
| 4.3 Number of Hopping Frequency Used .....                       | 35        |
| 4.3.1 Limits of Hopping Frequency Used Measurement .....         | 35        |
| 4.3.2 Test Setup .....   | 35        |
| 4.3.3 Test Instruments .....                                     | 35        |
| 4.3.4 Test Procedure .....                                       | 35        |
| 4.3.5 Deviation from Test Standard .....                         | 35        |
| 4.3.6 Test Results .....   | 36        |
| 4.4 Dwell Time on Each Channel .....                             | 37        |
| 4.4.1 Limits of Dwell Time on Each Channel Measurement .....     | 37        |
| 4.4.2 Test Setup .....   | 37        |
| 4.4.3 Test Instruments .....                                     | 37        |
| 4.4.4 Test Procedures .....                                      | 37        |
| 4.4.5 Deviation from Test Standard .....                         | 37        |
| 4.4.6 Test Results .....   | 38        |
| 4.5 Channel Bandwidth .....                                      | 42        |
| 4.5.1 Limits of Channel Bandwidth Measurement .....              | 42        |
| 4.5.2 Test Setup .....   | 42        |
| 4.5.3 Test Instruments .....                                     | 42        |
| 4.5.4 Test Procedure .....                                       | 42        |
| 4.5.5 Deviation from Test Standard .....                         | 42        |
| 4.5.6 EUT Operating Condition .....                              | 42        |
| 4.5.7 Test Results .....   | 43        |
| 4.6 Hopping Channel Separation .....                             | 44        |

|          |   |           |
|----------|---|-----------|
| 4.6.1    | Limits of Hopping Channel Separation Measurement.....           | 44        |
| 4.6.2    | Test Setup.....   | 44        |
| 4.6.3    | Test Instruments .....  | 44        |
| 4.6.4    | Test Procedure .....  | 44        |
| 4.6.5    | Deviation from Test Standard .....                              | 44        |
| 4.6.6    | Test Results .....  | 45        |
| 4.7      | Maximum Output Power.....                                       | 46        |
| 4.7.1    | Limits of Maximum Output Power Measurement .....                | 46        |
| 4.7.2    | Test Setup.....   | 46        |
| 4.7.3    | Test Instruments .....  | 46        |
| 4.7.4    | Test Procedure .....  | 46        |
| 4.7.5    | Deviation from Test Standard .....                              | 46        |
| 4.7.6    | EUT Operating Condition .....                                   | 46        |
| 4.7.7    | Test Results .....  | 47        |
| 4.8      | Conducted Out of Band Emission Measurement.....                 | 48        |
| 4.8.1    | Limits of Conducted Out of Band Emission Measurement.....       | 48        |
| 4.8.2    | Test Instruments .....  | 48        |
| 4.8.3    | Test Procedure .....  | 48        |
| 4.8.4    | Deviation from Test Standard .....                              | 48        |
| 4.8.5    | EUT Operating Condition .....                                   | 48        |
| 4.8.6    | Test Results .....  | 48        |
| <b>5</b> | <b>Pictures of Test Arrangements.....</b>                       | <b>51</b> |
|          | <b>Appendix – Information on the Testing Laboratories .....</b> | <b>52</b> |

### Release Control Record

| Issue No.     | Description       | Date Issued   |
|---------------|-------------------|---------------|
| RF161110E09-5 | Original release. | Jan. 23, 2017 |

## 1 Certificate of Conformity

**Product:** Portable terminal

**Brand:** XAC

**Test Model:** xCL\_E200NP-UN5

**Series Model:** xCL\_E200NP-UNN, xCL\_E200NP-NN5, xCL\_E200NP-NNN

**Sample Status:** ENGINEERING SAMPLE

**Applicant:** XAC AUTOMATION CORP.

**Test Date:** Nov. 23 to Dec. 20, 2016

**Standards:** 47 CFR FCC Part 15, Subpart C (Section 15.247)  
ANSI C63.10: 2013

The above equipment has been tested by **Bureau Veritas Consumer Products Services (H.K.) Ltd., Taoyuan Branch**, and found compliance with the requirement of the above standards. The test record, data evaluation & Equipment Under Test (EUT) configurations represented herein are true and accurate accounts of the measurements of the sample's EMC characteristics under the conditions specified in this report.

**Prepared by :**  , **Date:** Jan. 23, 2017  
Midoli Peng / Specialist

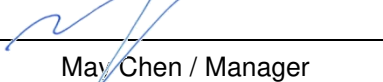
**Approved by :**  , **Date:** Jan. 23, 2017  
May Chen / Manager

## 2 Summary of Test Results

| 47 CFR FCC Part 15, Subpart C (SECTION 15.247) |   |        |  |
|--|---|--------|--|
| FCC Clause                                     | Test Item   | Result | Remarks  |
| 15.207   | AC Power Conducted Emission   | PASS   | Meet the requirement of limit. Minimum passing margin is -13.75dB at 2.64063MHz. |
| 15.247(a)(1)(iii)                              | Number of Hopping Frequency Used  | PASS   | Meet the requirement of limit.   |
| 15.247(a)(1)(iii)                              | Dwell Time on Each Channel  | PASS   | Meet the requirement of limit.   |
| 15.247(a)(1)                                   | 1. Hopping Channel Separation<br>2. Spectrum Bandwidth of a Frequency Hopping Sequence Spread Spectrum System | PASS   | Meet the requirement of limit.   |
| 15.247(b)                                      | Maximum Peak Output Power   | PASS   | Meet the requirement of limit.   |
| 15.205 & 209 & 15.247(d)                       | Radiated Emissions & Band Edge Measurement  | PASS   | Meet the requirement of limit. Minimum passing margin is -8.8dB at 81.65MHz.     |
| 15.247(d)                                      | Antenna Port Emission   | PASS   | Meet the requirement of limit.   |
| 15.203   | Antenna Requirement   | PASS   | Antenna connector is i-pex(MHF) not a standard connector.                        |

**NOTE:** If The Frequency Hopping System operating in 2400-2483.5MHz band and the output power less than 125mW. The hopping channel carrier frequencies separated by a minimum of 25kHz or two-thirds of the 20dB bandwidth of hopping channel whichever is greater.

### 2.1 Measurement Uncertainty

Where relevant, the following measurement uncertainty levels have been estimated for tests performed on the EUT as specified in CISPR 16-4-2:

| Measurement                        | Frequency      | Expanded Uncertainty (k=2) (±) |
|------------------------------------|----------------|--------------------------------|
| Conducted Emissions at mains ports | 150kHz ~ 30MHz | 1.83 dB                        |
| Radiated Emissions up to 1 GHz     | 30MHz ~ 1GHz   | 5.36 dB                        |
| Radiated Emissions above 1 GHz     | 1GHz ~ 6GHz    | 3.41 dB                        |
|                                    | 6GHz ~ 18GHz   | 3.49 dB                        |
|                                    | 18GHz ~ 40GHz  | 3.30 dB                        |

### 2.2 Modification Record

There were no modifications required for compliance.

### 3 General Information

#### 3.1 General Description of EUT (BT-EDR)

|                       |  |
|-----------------------|--|
| Product               | Portable terminal  |
| Brand                 | XAC  |
| Test Model            | xCL_E200NP-UN5   |
| Series Model          | xCL_E200NP-UNN, xCL_E200NP-NN5, xCL_E200NP-NNN               |
| Status of EUT         | ENGINEERING SAMPLE   |
| Power Supply Rating   | DC 3.85V or DC 3.7V from battery<br>DC 5V from USB interface |
| Modulation Type       | GFSK, $\pi/4$ -DQPSK, 8DPSK                                  |
| Modulation Technology | FHSS   |
| Transfer Rate         | Up to 3Mbps  |
| Operating Frequency   | 2402MHz ~ 2480MHz  |
| Number of Channel     | 79   |
| Output Power          | 13.677mW   |
| Antenna Type          | Refer to Note  |
| Antenna Connector     | Refer to Note  |
| Accessory Device      | Battery x1 (option)  |
| Data Cable Supplied   | NA   |

Note:

1. All models are listed as below.

| Model Name     | Function       |      |    |       |         |
|----------------|----------------|------|----|-------|---------|
|                | WLAN(b/g/n/an) | RFID | BT | 2G/3G | Camera  |
|                |                |      |    | US    | Rear 5M |
| xCL_E200NP-UN5 | v              | v    | v  | v     | v       |
| xCL_E200NP-UNN | v              | v    | v  | v     | -       |
| xCL_E200NP-NN5 | v              | v    | v  | -     | v       |
| xCL_E200NP-NNN | v              | v    | v  | -     | -       |

From the above models, model: **xCL\_E200NP-UN5** was selected as representative model for the test and its data was recorded in this report.

2. There are WLAN, Bluetooth WWAN and RFID technology used for the EUT.

3. EUT contains one certified WWAN module which FCC ID: QIPEHS5-US.

4. Simultaneously transmission condition.

| Condition | Technology    |           |      |
|-----------|---------------|-----------|------|
| 1         | WLAN (2.4GHz) | Bluetooth | RFID |
| 2         | WLAN (5GHz)   | Bluetooth | RFID |
| 3         | WWAN          | Bluetooth | RFID |

**Note:** The emission of the simultaneous operation has been evaluated and no non-compliance was found.

5. The antennas provided to the EUT, please refer to the following table:

| <b>WLAN/BT Antenna Spec.</b> |                        |                 |              |                |
|------------------------------|------------------------|-----------------|--------------|----------------|
| No.                          | Antenna Net Gain (dBi) | Frequency range | Antenna Type | Connector Type |
| 1                            | 0.26                   | 2.4~2.4835GHz   | PCB          | i-pex(MHF)     |
|                              | 2.38                   | 5.15~5.85GHz    |              |                |
| <b>WWAN Antenna Spec.</b>    |                        |                 |              |                |
| No.                          | Antenna Net Gain(dBi)  | Frequency range | Antenna Type | Connector Type |
| 1                            | -1.61                  | 824-891MHz      | PCB          | i-pex(MHF)     |
|                              | 0.58                   | 1850-1990MHz    |              |                |
| <b>RFID Antenna Spec.</b>    |                        |                 |              |                |
| No.                          | Antenna Net Gain(dBi)  | Frequency range | Antenna Type | Connector Type |
| 1                            | 13                     | 13.56MHz        | Loop         | NA             |

6. The EUT power needs to be supplied from one power adapter or battery, the information is as below table:

| <b>Power adapter (only for test not for sale)</b> |                       |  |                         |        |
|---|-----------------------|--|-------------------------|--------|
| Brand   | Model Name            | Specification  |                         |        |
| MOSO  | MSA-C2000IC5.0-12W-US | Input: AC100-240V, 0.5A, 50/60Hz<br>Output: DC 5V, 2A<br>DC output cable (Unshielded, 1.2 m) |                         |        |
| <b>Battery (option)</b>                           |                       |  |                         |        |
| No.   | Brand                 | Model Name   | Specification           | Remark |
| 1   | TWS                   | E200NP   | 3.85V, 2900mAh, 11.17Wh | Black  |
| 2   | HYB                   | J529/ICP575374P  | 3.7V, 3000mAh, 11.1Wh   | Silver |

7. For radiated emission test, the EUT was pre-tested under the following test modes :

| Pre-test Mode | Power                                     |
|---------------|---|
| Mode A        | Power from battery 1                      |
| Mode B        | Power from battery 2                      |
| <b>Mode C</b> | <b>Power from USB interface (Adapter)</b> |

The worst radiated emission was found in **Mode C**. Therefore only the test data of the modes were recorded in this report.

8. The above EUT information is declared by manufacturer and for more detailed features description, please refer to the manufacturer's specifications or user's manual.



### 3.2 Description of Test Modes

79 channels are provided for BT-EDR mode:

| Channel | Freq. (MHz) | Channel | Freq. (MHz) | Channel | Freq. (MHz) | Channel | Freq. (MHz) |
|---------|-------------|---------|-------------|---------|-------------|---------|-------------|
| 0       | 2402        | 20      | 2422        | 40      | 2442        | 60      | 2462        |
| 1       | 2403        | 21      | 2423        | 41      | 2443        | 61      | 2463        |
| 2       | 2404        | 22      | 2424        | 42      | 2444        | 62      | 2464        |
| 3       | 2405        | 23      | 2425        | 43      | 2445        | 63      | 2465        |
| 4       | 2406        | 24      | 2426        | 44      | 2446        | 64      | 2466        |
| 5       | 2407        | 25      | 2427        | 45      | 2447        | 65      | 2467        |
| 6       | 2408        | 26      | 2428        | 46      | 2448        | 66      | 2468        |
| 7       | 2409        | 27      | 2429        | 47      | 2449        | 67      | 2469        |
| 8       | 2410        | 28      | 2430        | 48      | 2450        | 68      | 2470        |
| 9       | 2411        | 29      | 2431        | 49      | 2451        | 69      | 2471        |
| 10      | 2412        | 30      | 2432        | 50      | 2452        | 70      | 2472        |
| 11      | 2413        | 31      | 2433        | 51      | 2453        | 71      | 2473        |
| 12      | 2414        | 32      | 2434        | 52      | 2454        | 72      | 2474        |
| 13      | 2415        | 33      | 2435        | 53      | 2455        | 73      | 2475        |
| 14      | 2416        | 34      | 2436        | 54      | 2456        | 74      | 2476        |
| 15      | 2417        | 35      | 2437        | 55      | 2457        | 75      | 2477        |
| 16      | 2418        | 36      | 2438        | 56      | 2458        | 76      | 2478        |
| 17      | 2419        | 37      | 2439        | 57      | 2459        | 77      | 2479        |
| 18      | 2420        | 38      | 2440        | 58      | 2460        | 78      | 2480        |
| 19      | 2421        | 39      | 2441        | 59      | 2461        |         |             |

### 3.2.1 Test Mode Applicability and Tested Channel Detail

| EUT Configure Mode | Applicable To |       |     |      | Description                        |
|--------------------|---------------|-------|-----|------|------------------------------------|
|                    | RE $\geq$ 1G  | RE<1G | PLC | APCM |                                    |
| 1                  | √             | √     | √   | √    | Power from USB interface (Adapter) |
| 2                  | -             | -     | √   | -    | Power from USB interface (Host)    |

Where **RE $\geq$ 1G**: Radiated Emission above 1GHz      **RE<1G**: Radiated Emission below 1GHz  
**PLC**: Power Line Conducted Emission      **APCM**: Antenna Port Conducted Measurement

NOTE: 1. The EUT had been pre-tested on the positioned of each 3 axis. The worst case was found when positioned on Z-plane(below 1GHz) & X-plane(above 1GHz) .  
 2. "-" means no effect.

#### **Radiated Emission Test (Above 1GHz):**

- Pre-Scan has been conducted to determine the worst-case mode from all possible combinations between available modulations, data rates and antenna ports (if EUT with antenna diversity architecture).
- Following channel(s) was (were) selected for the final test as listed below.

| AVAILABLE CHANNEL | TESTED CHANNEL | MODULATION TECHNOLOGY | MODULATION TYPE | PACKET TYPE |
|-------------------|----------------|-----------------------|-----------------|-------------|
| 0 to 78           | 0, 39, 78      | FHSS                  | GFSK            | DH5         |
| 0 to 78           | 0, 39, 78      | FHSS                  | 8DPSK           | 3DH5        |

#### **Radiated Emission Test (Below 1GHz):**

- Pre-Scan has been conducted to determine the worst-case mode from all possible combinations between available modulations, data rates and antenna ports (if EUT with antenna diversity architecture).
- Following channel(s) was (were) selected for the final test as listed below.

| AVAILABLE CHANNEL | TESTED CHANNEL | MODULATION TECHNOLOGY | MODULATION TYPE | PACKET TYPE |
|-------------------|----------------|-----------------------|-----------------|-------------|
| 0 to 78           | 39             | FHSS                  | GFSK            | DH5         |

#### **Power Line Conducted Emission Test:**

- Pre-Scan has been conducted to determine the worst-case mode from all possible combinations between available modulations, data rates and antenna ports (if EUT with antenna diversity architecture).
- Following channel(s) was (were) selected for the final test as listed below.

| AVAILABLE CHANNEL | TESTED CHANNEL | MODULATION TECHNOLOGY | MODULATION TYPE | PACKET TYPE |
|-------------------|----------------|-----------------------|-----------------|-------------|
| 0 to 78           | 39             | FHSS                  | GFSK            | DH5         |

**Antenna Port Conducted Measurement:**

- This item includes all test value of each mode, but only includes spectrum plot of worst value of each mode.
- Pre-Scan has been conducted to determine the worst-case mode from all possible combinations between available modulations, data rates and antenna ports (if EUT with antenna diversity architecture).
- Following channel(s) was (were) selected for the final test as listed below.

| AVAILABLE CHANNEL | TESTED CHANNEL | MODULATION TECHNOLOGY | MODULATION TYPE | PACKET TYPE |
|-------------------|----------------|-----------------------|-----------------|-------------|
| 0 to 78           | 0, 39, 78      | FHSS                  | GFSK            | DH5         |
| 0 to 78           | 0, 39, 78      | FHSS                  | 8DPSK           | 3DH5        |

**Test Condition:**

| APPLICABLE TO | ENVIRONMENTAL CONDITIONS | INPUT POWER (System) | TESTED BY     |
|---------------|--------------------------|----------------------|---------------|
| RE $\geq$ 1G  | 25deg. C, 63%RH          | 120Vac, 60Hz         | Jyunchun Lin  |
| RE<1G         | 24deg. C, 64%RH          | 120Vac, 60Hz         | Jyunchun Lin  |
| PLC           | 25deg. C, 75%RH          | 120Vac, 60Hz         | Andy Ho       |
| APCM          | 25deg. C, 60%RH          | 120Vac, 60Hz         | Anderson Chen |

### 3.3 Description of Support Units

The EUT has been tested as an independent unit together with other necessary accessories or support units. The following support units or accessories were used to form a representative test configuration during the tests.

| ID | Product             | Brand   | Model No.                 | Serial No. | FCC ID  | Remarks            |
|----|---------------------|---------|---------------------------|------------|---------|--------------------|
| A  | Earphone            | Apple   | NA                        | NA         | NA      | Provided by Lab    |
| B  | SIM Card            | NA      | NA                        | NA         | NA      | Supplied by client |
| C  | SAM Card            | NA      | NA                        | NA         | NA      | Supplied by client |
| D  | Bluetooth Simulator | Anritsu | MT8852B                   | 1218002    | NA      | Provided by Lab    |
| E  | Adapter             | MOSO    | MSA-C2000IC5.0<br>-12W-US | NA         | NA      | Supplied by client |
| F  | Laptop              | DELL    | E5430                     | 4YV4VY1    | FCC DoC | Provided by Lab    |

Note:

1. All power cords of the above support units are non-shielded (1.8m).

| ID | Descriptions | Qty. | Length (m) | Shielding (Yes/No) | Cores (Qty.) | Remarks            |
|----|--------------|------|------------|--------------------|--------------|--------------------|
| 1  | DC Cable     | 1    | 1.2        | No                 | 0            | Supplied by client |
| 2  | Audio Cable  | 1    | 1.2        | No                 | 0            | Provided by Lab    |
| 3  | USB Cable    | 1    | 1          | Yes                | 0            | Provided by Lab    |

### 3.3.1 Configuration of System under Test

#### Mode 1

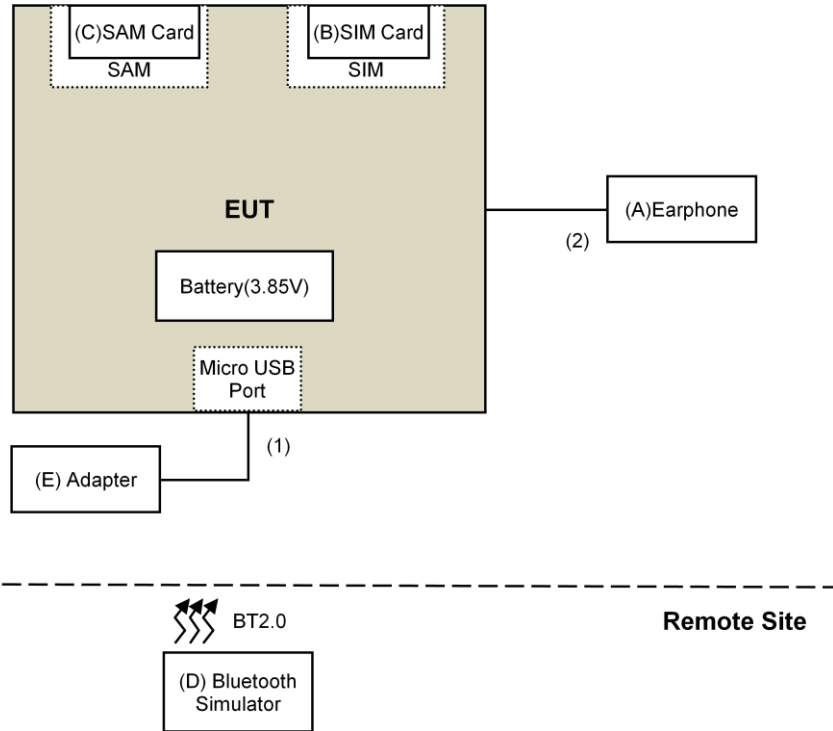

## Mode 2

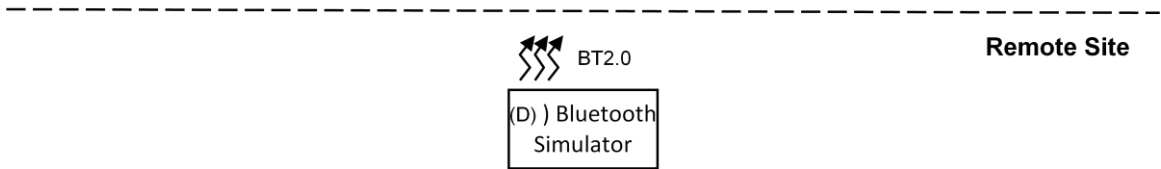
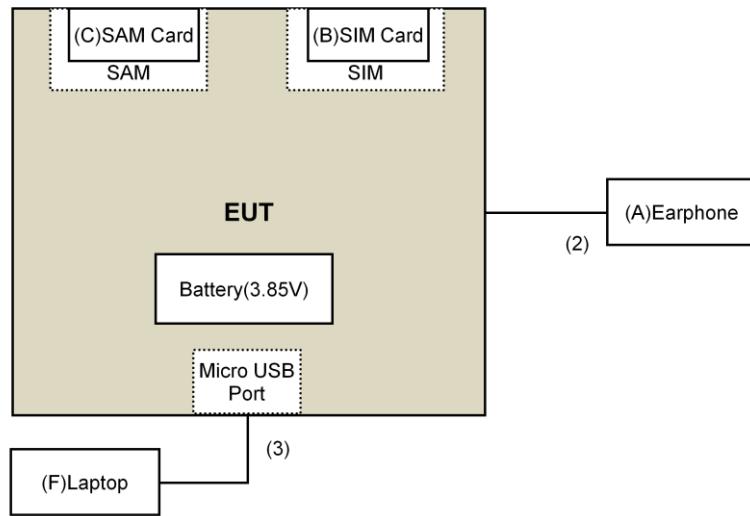

### 3.4 General Description of Applied Standards

The EUT is a RF Product. According to the specifications of the manufacturer, it must comply with the requirements of the following standards:

**FCC Part 15, Subpart C (15.247)**

ANSI C63.10-2013

All test items have been performed and recorded as per the above standards.

## 4 Test Types and Results

### 4.1 Radiated Emission and Bandedge Measurement

#### 4.1.1 Limits of Radiated Emission and Bandedge Measurement

Radiated emissions which fall in the restricted bands must comply with the radiated emission limits specified as below table. Other emissions shall be at least 20dB below the highest level of the desired power:

| Frequencies (MHz) | Field Strength (microvolts/meter) | Measurement Distance (meters) |
|-------------------|-----------------------------------|-------------------------------|
| 0.009 ~ 0.490     | 2400/F(kHz)                       | 300                           |
| 0.490 ~ 1.705     | 24000/F(kHz)                      | 30                            |
| 1.705 ~ 30.0      | 30                                | 30                            |
| 30 ~ 88           | 100                               | 3                             |
| 88 ~ 216          | 150                               | 3                             |
| 216 ~ 960         | 200                               | 3                             |
| Above 960         | 500                               | 3                             |

#### NOTE:

1. The lower limit shall apply at the transition frequencies.
2. Emission level (dBuV/m) = 20 log Emission level (uV/m).
3. For frequencies above 1000MHz, the field strength limits are based on average detector, however, the peak field strength of any emission shall not exceed the maximum permitted average limits, specified above by more than 20dB under any condition of modulation.



#### 4.1.2 Test Instruments

##### For below 1GHz test:

| DESCRIPTION & MANUFACTURER                     | MODEL NO.                | SERIAL NO.                    | CALIBRATED DATE | CALIBRATED UNTIL |
|--|--------------------------|-------------------------------|-----------------|------------------|
| Test Receiver<br>Agilent                       | N9038A                   | MY50010156                    | Aug. 18, 2016   | Aug. 17, 2017    |
| Pre-Amplifier <sup>(*)</sup><br>EMCI           | EMC001340                | 980142                        | Jan. 20, 2016   | Jan. 19, 2018    |
| Loop Antenna <sup>(*)</sup><br>Electro-Metrics | EM-6879                  | 264                           | Dec. 16, 2014   | Dec. 15, 2016    |
| RF Cable                                       | NA                       | LOOPCAB-001<br>LOOPCAB-002    | Jan. 18, 2016   | Jan. 17, 2017    |
| Pre-Amplifier<br>Mini-Circuits                 | ZFL-1000VH2<br>B         | AMP-ZFL-05                    | May 07, 2016    | May 06, 2017     |
| Trilog Broadband Antenna<br>SCHWARZBECK        | VULB 9168                | 9168-156                      | Jan. 04, 2016   | Jan. 03, 2017    |
| RF Cable                                       | 8D                       | 966-3-1<br>966-3-2<br>966-3-3 | Apr. 02, 2016   | Apr. 01, 2017    |
| Fixed attenuator<br>Mini-Circuits              | UNAT-5+                  | PAD-3m-3-01                   | Oct. 05, 2016   | Oct. 04, 2017    |
| Software                                       | ADT_Radiated<br>_V8.7.08 | NA                            | NA              | NA               |
| Antenna Tower & Turn Table<br>Max-Full         | MF-7802                  | MF780208406                   | NA              | NA               |

##### Note:

1. The calibration interval of the above test instruments is 12 months and the calibrations are traceable to NML/ROC and NIST/USA.
2. \*The calibration interval of the above test instruments is 24 months and the calibrations are traceable to NML/ROC and NIST/USA.
3. Loop antenna was used for all emissions below 30 MHz.
4. The test was performed in 966 Chamber No. 3.
5. The FCC Site Registration No. is 147459
6. The CANADA Site Registration No. is 20331-1
7. Tested Date: Nov. 25, 2016

**For other test items:**

| DESCRIPTION & MANUFACTURER             | MODEL NO.   | SERIAL NO.                 | CALIBRATED DATE | CALIBRATED UNTIL |
|--|---|----------------------------|-----------------|------------------|
| Test Receiver<br>Keysight              | N9038A  | MY54450088                 | July 20, 2016   | July 19, 2017    |
| Horn_Antenna<br>SCHWARZBECK            | BBHA 9120D  | 9120D-783                  | Jan. 19, 2016   | Jan. 18, 2017    |
| Pre-Amplifier<br>Agilent               | 8449B   | 3008A01922                 | Sep. 18, 2016   | Sep. 17, 2017    |
| RF Cable                               | EMC104-SM-<br>SM-2000<br>EMC104-SM-<br>SM-5000<br>EMC104-SM-<br>SM-5000 | 150318<br>150323<br>150324 | Mar. 30, 2016   | Mar. 29, 2017    |
| Pre-Amplifier<br>EMCI                  | EMC184045   | 980143                     | Jan. 15, 2016   | Jan. 14, 2017    |
| Horn_Antenna<br>SCHWARZBECK            | BBHA 9170   | BBHA9170608                | Jan. 08, 2016   | Jan. 07, 2017    |
| RF Cable                               | SUCOFLEX<br>102   | 36432/2<br>36441/2         | Jan. 16, 2016   | Jan. 15, 2017    |
| Software                               | ADT_Radiated<br>_V8.7.08  | NA                         | NA              | NA               |
| Antenna Tower & Turn Table<br>Max-Full | MF-7802   | MF780208410                | NA              | NA               |
| Boresight Antenna Fixture              | FBA-01  | FBA-SIP02                  | NA              | NA               |
| Spectrum Analyzer<br>Keysight          | N9030A  | MY54490679                 | July 23, 2016   | July 22, 2017    |

**Note:**

1. The calibration interval of the above test instruments is 12 months and the calibrations are traceable to NML/ROC and NIST/USA.
2. The test was performed in 966 Chamber No. 4.
3. The FCC Site Registration No. is 292998
4. The CANADA Site Registration No. is 20331-2
5. Tested Date: Nov. 23 to Dec. 20, 2016

#### 4.1.3 Test Procedures

##### **For Radiated emission below 30MHz**

- a. The EUT was placed on the top of a rotating table 0.8 meters above the ground at a 3 meter chamber room. The table was rotated 360 degrees to determine the position of the highest radiation.
- b. The EUT was set 3 meters away from the interference-receiving antenna, which was mounted on the top of a variable-height antenna tower.
- c. Both X and Y axes of the antenna are set to make the measurement.
- d. For each suspected emission, the EUT was arranged to its worst case and the rotatable table was turned from 0 degrees to 360 degrees to find the maximum reading.
- e. The test-receiver system was set to Quasi-Peak Detect Function and Specified Bandwidth with Maximum Hold Mode.

##### **NOTE:**

1. The resolution bandwidth and video bandwidth of test receiver/spectrum analyzer is 9kHz at frequency below 30MHz.

##### **For Radiated emission above 30MHz**

- a. The EUT was placed on the top of a rotating table 0.8 meters (for 30MHz ~ 1GHz) / 1.5 meters (for above 1GHz) above the ground at 3 meter chamber room for test. The table was rotated 360 degrees to determine the position of the highest radiation.
- b. The EUT was set 3 meters away from the interference-receiving antenna, which was mounted on the top of a variable-height antenna tower.
- c. The height of antenna is varied from one meter to four meters above the ground to determine the maximum value of the field strength. Both horizontal and vertical polarizations of the antenna are set to make the measurement.
- d. For each suspected emission, the EUT was arranged to its worst case and then the antenna was tuned to heights from 1 meter to 4 meters and the rotatable table was turned from 0 degrees to 360 degrees to find the maximum reading.
- e. The test-receiver system was set to quasi-peak detect function and specified bandwidth with maximum hold mode when the test frequency is below 1 GHz.

##### **Note:**

1. The resolution bandwidth and video bandwidth of test receiver/spectrum analyzer is 120kHz for Quasi-peak detection (QP) at frequency below 1GHz.
2. The resolution bandwidth of test receiver/spectrum analyzer is 1 MHz and the video bandwidth is 3 MHz for Peak detection (PK) at frequency above 1GHz.
3. For Average measurement, due to the DH5 packet was the worse case duty cycle for a transmit dwell time on a channel, based upon bluetooth theory the transmitter is on  $0.625 * 5$  per 296.25 ms per channel. Therefore, the duty cycle correlation factor be equal to:  $20\log(3.125 / 100) = -30.1$  dB, therefore Average value = peak reading +  $20\log(\text{duty cycle})$ .
4. All modes of operation were investigated and the worst-case emissions are reported.

#### 4.1.4 Deviation from Test Standard

No deviation.

#### 4.1.5 Test Setup

##### For Radiated emission below 30MHz

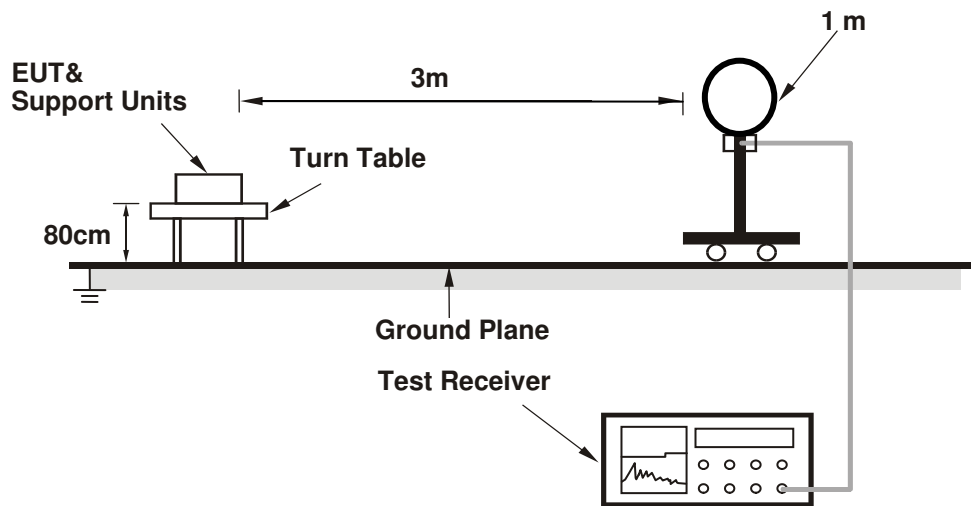

##### For Radiated emission 30MHz to 1GHz

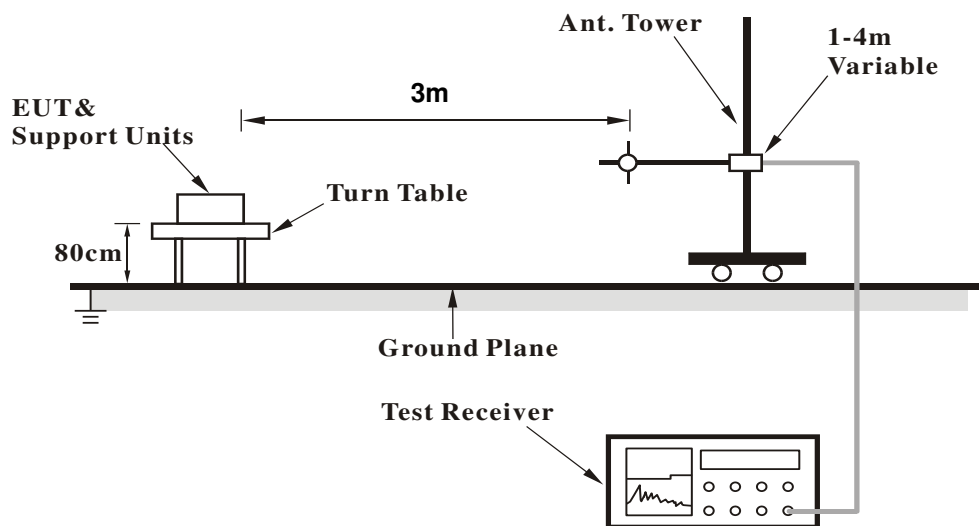

### For Radiated emission above 1GHz

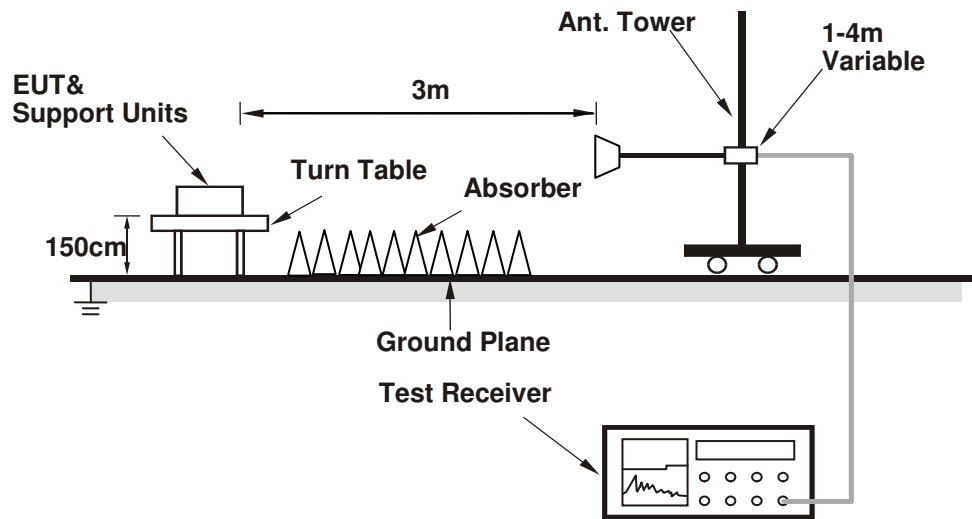

For the actual test configuration, please refer to the attached file (Test Setup Photo).

#### 4.1.6 EUT Operating Conditions

- a. Support unit D (Bluetooth Simulator) link EUT under transmission/receiving condition continuously via wireless transmission.

4.1.7 Test Results

Above 1GHz Data:

BT\_GFSK

|                        |              |                          |           |
|------------------------|--------------|--------------------------|-----------|
| <b>CHANNEL</b>         | TX Channel 0 | <b>DETECTOR FUNCTION</b> | Peak (PK) |
| <b>FREQUENCY RANGE</b> | 1GHz ~ 25GHz |                          |           |

| ANTENNA POLARITY & TEST DISTANCE: HORIZONTAL AT 3 M |             |                         |                |             |                    |                      |                  |                          |
|---|-------------|-------------------------|----------------|-------------|--------------------|----------------------|------------------|--------------------------|
| NO.   | FREQ. (MHz) | EMISSION LEVEL (dBuV/m) | LIMIT (dBuV/m) | MARGIN (dB) | ANTENNA HEIGHT (m) | TABLE ANGLE (Degree) | RAW VALUE (dBuV) | CORRECTION FACTOR (dB/m) |
| 1   | 2390.00     | 48.9 PK                 | 74.0           | -25.1       | 1.00 H             | 114                  | 54.6             | -5.7                     |
| 2   | 2390.00     | 18.8 AV                 | 54.0           | -35.2       | 1.00 H             | 114                  | 24.5             | -5.7                     |
| 3   | *2402.00    | 102.5 PK                |                |             | 1.00 H             | 114                  | 108.2            | -5.7                     |
| 4   | *2402.00    | 72.4 AV                 |                |             | 1.00 H             | 114                  | 78.1             | -5.7                     |
| 5   | 4804.00     | 42.5 PK                 | 74.0           | -31.5       | 1.19 H             | 100                  | 41.7             | 0.8                      |
| 6   | 4804.00     | 12.4 AV                 | 54.0           | -41.6       | 1.19 H             | 100                  | 11.6             | 0.8                      |

| ANTENNA POLARITY & TEST DISTANCE: VERTICAL AT 3 M |             |                         |                |             |                    |                      |                  |                          |
|---|-------------|-------------------------|----------------|-------------|--------------------|----------------------|------------------|--------------------------|
| NO.   | FREQ. (MHz) | EMISSION LEVEL (dBuV/m) | LIMIT (dBuV/m) | MARGIN (dB) | ANTENNA HEIGHT (m) | TABLE ANGLE (Degree) | RAW VALUE (dBuV) | CORRECTION FACTOR (dB/m) |
| 1   | 2390.00     | 49.2 PK                 | 74.0           | -24.8       | 2.77 V             | 25                   | 54.9             | -5.7                     |
| 2   | 2390.00     | 19.1 AV                 | 54.0           | -34.9       | 2.77 V             | 25                   | 24.8             | -5.7                     |
| 3   | *2402.00    | 103.2 PK                |                |             | 2.77 V             | 25                   | 108.9            | -5.7                     |
| 4   | *2402.00    | 73.1 AV                 |                |             | 2.77 V             | 25                   | 78.8             | -5.7                     |
| 5   | 4804.00     | 43.1 PK                 | 74.0           | -30.9       | 1.16 V             | 216                  | 42.3             | 0.8                      |
| 6   | 4804.00     | 13.0 AV                 | 54.0           | -41.0       | 1.16 V             | 216                  | 12.2             | 0.8                      |

REMARKS:

- Emission Level(dBuV/m) = Raw Value(dBuV) + Correction Factor(dB/m)
- Correction Factor(dB/m) = Antenna Factor(dB/m) + Cable Factor(dB) – Pre-Amplifier Factor(dB)
- The other emission levels were very low against the limit.
- Margin value = Emission Level – Limit value
- " \* ": Fundamental frequency.
- The DH5 packet was the worse case duty cycle for a transmit dwell time on a channel, based upon bluetooth theory the transmitter is on 0.625 \* 5 per 296.25 ms per channel. Therefore, the duty cycle correlation factor be equal to:  $20\log(3.125 / 100) = -30.1$  dB
- Average value = peak reading +  $20\log(\text{duty cycle})$ .

|                        |               |                          |           |
|------------------------|---------------|--------------------------|-----------|
| <b>CHANNEL</b>         | TX Channel 39 | <b>DETECTOR FUNCTION</b> | Peak (PK) |
| <b>FREQUENCY RANGE</b> | 1GHz ~ 25GHz  |                          |           |

**ANTENNA POLARITY & TEST DISTANCE: HORIZONTAL AT 3 M**

| NO. | FREQ. (MHz) | EMISSION LEVEL (dBuV/m) | LIMIT (dBuV/m) | MARGIN (dB) | ANTENNA HEIGHT (m) | TABLE ANGLE (Degree) | RAW VALUE (dBuV) | CORRECTION FACTOR (dB/m) |
|-----|-------------|-------------------------|----------------|-------------|--------------------|----------------------|------------------|--------------------------|
| 1   | *2441.00    | 103.5 PK                |                |             | 1.04 H             | 127                  | 109.0            | -5.5                     |
| 2   | *2441.00    | 73.4 AV                 |                |             | 1.04 H             | 127                  | 78.9             | -5.5                     |
| 3   | 4882.00     | 41.7 PK                 | 74.0           | -32.3       | 1.16 H             | 120                  | 40.8             | 0.9                      |
| 4   | 4882.00     | 11.6 AV                 | 54.0           | -42.4       | 1.16 H             | 120                  | 10.7             | 0.9                      |
| 5   | 7323.00     | 49.3 PK                 | 74.0           | -24.7       | 1.34 H             | 149                  | 41.9             | 7.4                      |
| 6   | 7323.00     | 19.2 AV                 | 54.0           | -34.8       | 1.34 H             | 149                  | 11.8             | 7.4                      |

**ANTENNA POLARITY & TEST DISTANCE: VERTICAL AT 3 M**

| NO. | FREQ. (MHz) | EMISSION LEVEL (dBuV/m) | LIMIT (dBuV/m) | MARGIN (dB) | ANTENNA HEIGHT (m) | TABLE ANGLE (Degree) | RAW VALUE (dBuV) | CORRECTION FACTOR (dB/m) |
|-----|-------------|-------------------------|----------------|-------------|--------------------|----------------------|------------------|--------------------------|
| 1   | *2441.00    | 104.3 PK                |                |             | 2.74 V             | 22                   | 109.8            | -5.5                     |
| 2   | *2441.00    | 74.2 AV                 |                |             | 2.74 V             | 22                   | 79.7             | -5.5                     |
| 3   | 4882.00     | 42.6 PK                 | 74.0           | -31.4       | 1.25 V             | 208                  | 41.7             | 0.9                      |
| 4   | 4882.00     | 12.5 AV                 | 54.0           | -41.5       | 1.25 V             | 208                  | 11.6             | 0.9                      |
| 5   | 7323.00     | 49.6 PK                 | 74.0           | -24.4       | 1.52 V             | 158                  | 42.2             | 7.4                      |
| 6   | 7323.00     | 19.5 AV                 | 54.0           | -34.5       | 1.52 V             | 158                  | 12.1             | 7.4                      |

**REMARKS:**

1. Emission Level(dBuV/m) = Raw Value(dBuV) + Correction Factor(dB/m)
2. Correction Factor(dB/m) = Antenna Factor(dB/m) + Cable Factor(dB) – Pre-Amplifier Factor(dB)
3. The other emission levels were very low against the limit.
4. Margin value = Emission Level – Limit value
5. " \* ": Fundamental frequency.
6. The DH5 packet was the worse case duty cycle for a transmit dwell time on a channel, based upon bluetooth theory the transmitter is on 0.625 \* 5 per 296.25 ms per channel. Therefore, the duty cycle correlation factor be equal to:  $20\log(3.125 / 100) = -30.1 \text{ dB}$
7. Average value = peak reading +  $20\log(\text{duty cycle})$ .

|                        |               |                          |           |
|------------------------|---------------|--------------------------|-----------|
| <b>CHANNEL</b>         | TX Channel 78 | <b>DETECTOR FUNCTION</b> | Peak (PK) |
| <b>FREQUENCY RANGE</b> | 1GHz ~ 25GHz  |                          |           |

**ANTENNA POLARITY & TEST DISTANCE: HORIZONTAL AT 3 M**

| NO. | FREQ. (MHz) | EMISSION LEVEL (dBuV/m) | LIMIT (dBuV/m) | MARGIN (dB) | ANTENNA HEIGHT (m) | TABLE ANGLE (Degree) | RAW VALUE (dBuV) | CORRECTION FACTOR (dB/m) |
|-----|-------------|-------------------------|----------------|-------------|--------------------|----------------------|------------------|--------------------------|
| 1   | *2480.00    | 102.2 PK                |                |             | 1.00 H             | 114                  | 107.6            | -5.4                     |
| 2   | *2480.00    | 72.1 AV                 |                |             | 1.00 H             | 114                  | 77.5             | -5.4                     |
| 3   | 2483.50     | 51.0 PK                 | 74.0           | -23.0       | 1.00 H             | 114                  | 56.5             | -5.5                     |
| 4   | 2483.50     | 20.9 AV                 | 54.0           | -33.1       | 1.00 H             | 114                  | 26.4             | -5.5                     |
| 5   | 4960.00     | 42.2 PK                 | 74.0           | -31.8       | 1.19 H             | 93                   | 41.0             | 1.2                      |
| 6   | 4960.00     | 12.1 AV                 | 54.0           | -41.9       | 1.19 H             | 93                   | 10.9             | 1.2                      |
| 7   | 7440.00     | 48.9 PK                 | 74.0           | -25.1       | 1.33 H             | 142                  | 41.2             | 7.7                      |
| 8   | 7440.00     | 18.8 AV                 | 54.0           | -35.2       | 1.33 H             | 142                  | 11.1             | 7.7                      |

**ANTENNA POLARITY & TEST DISTANCE: VERTICAL AT 3 M**

| NO. | FREQ. (MHz) | EMISSION LEVEL (dBuV/m) | LIMIT (dBuV/m) | MARGIN (dB) | ANTENNA HEIGHT (m) | TABLE ANGLE (Degree) | RAW VALUE (dBuV) | CORRECTION FACTOR (dB/m) |
|-----|-------------|-------------------------|----------------|-------------|--------------------|----------------------|------------------|--------------------------|
| 1   | *2480.00    | 103.0 PK                |                |             | 3.18 V             | 21                   | 108.4            | -5.4                     |
| 2   | *2480.00    | 72.9 AV                 |                |             | 3.18 V             | 21                   | 78.3             | -5.4                     |
| 3   | 2483.50     | 51.6 PK                 | 74.0           | -22.4       | 3.18 V             | 21                   | 57.1             | -5.5                     |
| 4   | 2483.50     | 21.5 AV                 | 54.0           | -32.5       | 3.18 V             | 21                   | 27.0             | -5.5                     |
| 5   | 4960.00     | 42.8 PK                 | 74.0           | -31.2       | 1.18 V             | 193                  | 41.6             | 1.2                      |
| 6   | 4960.00     | 12.7 AV                 | 54.0           | -41.3       | 1.18 V             | 193                  | 11.5             | 1.2                      |
| 7   | 7440.00     | 49.5 PK                 | 74.0           | -24.5       | 1.44 V             | 169                  | 41.8             | 7.7                      |
| 8   | 7440.00     | 19.4 AV                 | 54.0           | -34.6       | 1.44 V             | 169                  | 11.7             | 7.7                      |

**REMARKS:**

- Emission Level(dBuV/m) = Raw Value(dBuV) + Correction Factor(dB/m)
- Correction Factor(dB/m) = Antenna Factor(dB/m) + Cable Factor(dB) – Pre-Amplifier Factor(dB)
- The other emission levels were very low against the limit.
- Margin value = Emission Level – Limit value
- " \* " : Fundamental frequency.
- The DH5 packet was the worse case duty cycle for a transmit dwell time on a channel, based upon bluetooth theory the transmitter is on 0.625 \* 5 per 296.25 ms per channel. Therefore, the duty cycle correlation factor be equal to:  $20\log(3.125 / 100) = -30.1 \text{ dB}$
- Average value = peak reading +  $20\log(\text{duty cycle})$ .



**BT\_8DPSK**

|                        |              |                          |           |
|------------------------|--------------|--------------------------|-----------|
| <b>CHANNEL</b>         | TX Channel 0 | <b>DETECTOR FUNCTION</b> | Peak (PK) |
| <b>FREQUENCY RANGE</b> | 1GHz ~ 25GHz |                          |           |

**ANTENNA POLARITY & TEST DISTANCE: HORIZONTAL AT 3 M**

| NO. | FREQ. (MHz) | EMISSION LEVEL (dBuV/m) | LIMIT (dBuV/m) | MARGIN (dB) | ANTENNA HEIGHT (m) | TABLE ANGLE (Degree) | RAW VALUE (dBuV) | CORRECTION FACTOR (dB/m) |
|-----|-------------|-------------------------|----------------|-------------|--------------------|----------------------|------------------|--------------------------|
| 1   | 2390.00     | 49.3 PK                 | 74.0           | -24.7       | 1.04 H             | 70                   | 55.0             | -5.7                     |
| 2   | 2390.00     | 19.2 AV                 | 54.0           | -34.8       | 1.04 H             | 70                   | 24.9             | -5.7                     |
| 3   | *2402.00    | 101.6 PK                |                |             | 1.04 H             | 70                   | 107.3            | -5.7                     |
| 4   | *2402.00    | 71.5 AV                 |                |             | 1.04 H             | 70                   | 77.2             | -5.7                     |
| 5   | 4804.00     | 42.6 PK                 | 74.0           | -31.4       | 1.18 H             | 93                   | 41.8             | 0.8                      |
| 6   | 4804.00     | 12.5 AV                 | 54.0           | -41.5       | 1.18 H             | 93                   | 11.7             | 0.8                      |

**ANTENNA POLARITY & TEST DISTANCE: VERTICAL AT 3 M**

| NO. | FREQ. (MHz) | EMISSION LEVEL (dBuV/m) | LIMIT (dBuV/m) | MARGIN (dB) | ANTENNA HEIGHT (m) | TABLE ANGLE (Degree) | RAW VALUE (dBuV) | CORRECTION FACTOR (dB/m) |
|-----|-------------|-------------------------|----------------|-------------|--------------------|----------------------|------------------|--------------------------|
| 1   | 2390.00     | 49.8 PK                 | 74.0           | -24.2       | 3.51 V             | 12                   | 55.5             | -5.7                     |
| 2   | 2390.00     | 19.7 AV                 | 54.0           | -34.3       | 3.51 V             | 12                   | 25.4             | -5.7                     |
| 3   | *2402.00    | 102.8 PK                |                |             | 3.51 V             | 12                   | 108.5            | -5.7                     |
| 4   | *2402.00    | 72.7 AV                 |                |             | 3.51 V             | 12                   | 78.4             | -5.7                     |
| 5   | 4804.00     | 42.1 PK                 | 74.0           | -31.9       | 1.20 V             | 203                  | 41.3             | 0.8                      |
| 6   | 4804.00     | 12.0 AV                 | 54.0           | -42.0       | 1.20 V             | 203                  | 11.2             | 0.8                      |

**REMARKS:**

- Emission Level(dBuV/m) = Raw Value(dBuV) + Correction Factor(dB/m)
- Correction Factor(dB/m) = Antenna Factor(dB/m) + Cable Factor(dB) – Pre-Amplifier Factor(dB)
- The other emission levels were very low against the limit.
- Margin value = Emission Level – Limit value
- " \* ": Fundamental frequency.
- The DH5 packet was the worse case duty cycle for a transmit dwell time on a channel, based upon bluetooth theory the transmitter is on 0.625 \* 5 per 296.25 ms per channel. Therefore, the duty cycle correlation factor be equal to:  $20\log(3.125 / 100) = -30.1$  dB
- Average value = peak reading +  $20\log(\text{duty cycle})$ .

|                        |               |                          |           |
|------------------------|---------------|--------------------------|-----------|
| <b>CHANNEL</b>         | TX Channel 39 | <b>DETECTOR FUNCTION</b> | Peak (PK) |
| <b>FREQUENCY RANGE</b> | 1GHz ~ 25GHz  |                          |           |

**ANTENNA POLARITY & TEST DISTANCE: HORIZONTAL AT 3 M**

| NO. | FREQ. (MHz) | EMISSION LEVEL (dBuV/m) | LIMIT (dBuV/m) | MARGIN (dB) | ANTENNA HEIGHT (m) | TABLE ANGLE (Degree) | RAW VALUE (dBuV) | CORRECTION FACTOR (dB/m) |
|-----|-------------|-------------------------|----------------|-------------|--------------------|----------------------|------------------|--------------------------|
| 1   | *2441.00    | 102.1 PK                |                |             | 1.02 H             | 70                   | 107.6            | -5.5                     |
| 2   | *2441.00    | 72.0 AV                 |                |             | 1.02 H             | 70                   | 77.5             | -5.5                     |
| 3   | 4882.00     | 42.6 PK                 | 74.0           | -31.4       | 1.19 H             | 104                  | 41.7             | 0.9                      |
| 4   | 4882.00     | 12.5 AV                 | 54.0           | -41.5       | 1.19 H             | 104                  | 11.6             | 0.9                      |
| 5   | 7323.00     | 48.7 PK                 | 74.0           | -25.3       | 1.37 H             | 154                  | 41.3             | 7.4                      |
| 6   | 7323.00     | 18.6 AV                 | 54.0           | -35.4       | 1.37 H             | 154                  | 11.2             | 7.4                      |

**ANTENNA POLARITY & TEST DISTANCE: VERTICAL AT 3 M**

| NO. | FREQ. (MHz) | EMISSION LEVEL (dBuV/m) | LIMIT (dBuV/m) | MARGIN (dB) | ANTENNA HEIGHT (m) | TABLE ANGLE (Degree) | RAW VALUE (dBuV) | CORRECTION FACTOR (dB/m) |
|-----|-------------|-------------------------|----------------|-------------|--------------------|----------------------|------------------|--------------------------|
| 1   | *2441.00    | 103.4 PK                |                |             | 3.56 V             | 11                   | 108.9            | -5.5                     |
| 2   | *2441.00    | 73.3 AV                 |                |             | 3.56 V             | 11                   | 78.8             | -5.5                     |
| 3   | 4882.00     | 43.4 PK                 | 74.0           | -30.6       | 1.21 V             | 201                  | 42.5             | 0.9                      |
| 4   | 4882.00     | 13.3 AV                 | 54.0           | -40.7       | 1.21 V             | 201                  | 12.4             | 0.9                      |
| 5   | 7323.00     | 48.9 PK                 | 74.0           | -25.1       | 1.47 V             | 156                  | 41.5             | 7.4                      |
| 6   | 7323.00     | 18.8 AV                 | 54.0           | -35.2       | 1.47 V             | 156                  | 11.4             | 7.4                      |

**REMARKS:**

1. Emission Level(dBuV/m) = Raw Value(dBuV) + Correction Factor(dB/m)
2. Correction Factor(dB/m) = Antenna Factor(dB/m) + Cable Factor(dB) – Pre-Amplifier Factor(dB)
3. The other emission levels were very low against the limit.
4. Margin value = Emission Level – Limit value
5. " \* ": Fundamental frequency.
6. The DH5 packet was the worse case duty cycle for a transmit dwell time on a channel, based upon bluetooth theory the transmitter is on 0.625 \* 5 per 296.25 ms per channel. Therefore, the duty cycle correlation factor be equal to:  $20\log(3.125 / 100) = -30.1 \text{ dB}$
7. Average value = peak reading +  $20\log(\text{duty cycle})$ .

|                        |               |                          |           |
|------------------------|---------------|--------------------------|-----------|
| <b>CHANNEL</b>         | TX Channel 78 | <b>DETECTOR FUNCTION</b> | Peak (PK) |
| <b>FREQUENCY RANGE</b> | 1GHz ~ 25GHz  |                          |           |

**ANTENNA POLARITY & TEST DISTANCE: HORIZONTAL AT 3 M**

| NO. | FREQ. (MHz) | EMISSION LEVEL (dBuV/m) | LIMIT (dBuV/m) | MARGIN (dB) | ANTENNA HEIGHT (m) | TABLE ANGLE (Degree) | RAW VALUE (dBuV) | CORRECTION FACTOR (dB/m) |
|-----|-------------|-------------------------|----------------|-------------|--------------------|----------------------|------------------|--------------------------|
| 1   | *2480.00    | 100.9 PK                |                |             | 1.00 H             | 67                   | 106.3            | -5.4                     |
| 2   | *2480.00    | 70.8 AV                 |                |             | 1.00 H             | 67                   | 76.2             | -5.4                     |
| 3   | 2483.50     | 50.3 PK                 | 74.0           | -23.7       | 1.00 H             | 67                   | 55.8             | -5.5                     |
| 4   | 2483.50     | 20.2 AV                 | 54.0           | -33.8       | 1.00 H             | 67                   | 25.7             | -5.5                     |
| 5   | 4960.00     | 42.3 PK                 | 74.0           | -31.7       | 1.12 H             | 100                  | 41.1             | 1.2                      |
| 6   | 4960.00     | 12.2 AV                 | 54.0           | -41.8       | 1.12 H             | 100                  | 11.0             | 1.2                      |
| 7   | 7440.00     | 49.1 PK                 | 74.0           | -24.9       | 1.34 H             | 164                  | 41.4             | 7.7                      |
| 8   | 7440.00     | 19.0 AV                 | 54.0           | -35.0       | 1.34 H             | 164                  | 11.3             | 7.7                      |

**ANTENNA POLARITY & TEST DISTANCE: VERTICAL AT 3 M**

| NO. | FREQ. (MHz) | EMISSION LEVEL (dBuV/m) | LIMIT (dBuV/m) | MARGIN (dB) | ANTENNA HEIGHT (m) | TABLE ANGLE (Degree) | RAW VALUE (dBuV) | CORRECTION FACTOR (dB/m) |
|-----|-------------|-------------------------|----------------|-------------|--------------------|----------------------|------------------|--------------------------|
| 1   | *2480.00    | 102.2 PK                |                |             | 3.51 V             | 16                   | 107.6            | -5.4                     |
| 2   | *2480.00    | 72.1 AV                 |                |             | 3.51 V             | 16                   | 77.5             | -5.4                     |
| 3   | 2483.50     | 51.1 PK                 | 74.0           | -22.9       | 3.51 V             | 16                   | 56.6             | -5.5                     |
| 4   | 2483.50     | 21.0 AV                 | 54.0           | -33.0       | 3.51 V             | 16                   | 26.5             | -5.5                     |
| 5   | 4960.00     | 42.8 PK                 | 74.0           | -31.2       | 1.23 V             | 208                  | 41.6             | 1.2                      |
| 6   | 4960.00     | 12.7 AV                 | 54.0           | -41.3       | 1.23 V             | 208                  | 11.5             | 1.2                      |
| 7   | 7440.00     | 49.2 PK                 | 74.0           | -24.8       | 1.51 V             | 144                  | 41.5             | 7.7                      |
| 8   | 7440.00     | 19.1 AV                 | 54.0           | -34.9       | 1.51 V             | 144                  | 11.4             | 7.7                      |

**REMARKS:**

- Emission Level(dBuV/m) = Raw Value(dBuV) + Correction Factor(dB/m)
- Correction Factor(dB/m) = Antenna Factor(dB/m) + Cable Factor(dB) – Pre-Amplifier Factor(dB)
- The other emission levels were very low against the limit.
- Margin value = Emission Level – Limit value
- " \* " : Fundamental frequency.
- The DH5 packet was the worse case duty cycle for a transmit dwell time on a channel, based upon bluetooth theory the transmitter is on 0.625 \* 5 per 296.25 ms per channel. Therefore, the duty cycle correlation factor be equal to:  $20\log(3.125 / 100) = -30.1 \text{ dB}$
- Average value = peak reading +  $20\log(\text{duty cycle})$ .

**Below 1GHz Data:**

|                        |               |                          |                 |
|------------------------|---------------|--------------------------|-----------------|
| <b>CHANNEL</b>         | TX Channel 39 | <b>DETECTOR FUNCTION</b> | Quasi-Peak (QP) |
| <b>FREQUENCY RANGE</b> | 9kHz ~ 1GHz   |                          |                 |

| <b>ANTENNA POLARITY &amp; TEST DISTANCE: HORIZONTAL AT 3 M</b> |             |                         |                |             |                    |                      |                  |                          |
|--|-------------|-------------------------|----------------|-------------|--------------------|----------------------|------------------|--------------------------|
| NO.  | FREQ. (MHz) | EMISSION LEVEL (dBuV/m) | LIMIT (dBuV/m) | MARGIN (dB) | ANTENNA HEIGHT (m) | TABLE ANGLE (Degree) | RAW VALUE (dBuV) | CORRECTION FACTOR (dB/m) |
| 1  | 83.47       | 27.5 QP                 | 40.0           | -12.5       | 1.50 H             | 229                  | 41.0             | -13.5                    |
| 2  | 139.22      | 29.7 QP                 | 43.5           | -13.8       | 2.00 H             | 286                  | 38.7             | -9.0                     |
| 3  | 165.44      | 26.8 QP                 | 43.5           | -16.7       | 2.00 H             | 283                  | 35.3             | -8.5                     |
| 4  | 278.27      | 26.5 QP                 | 46.0           | -19.5       | 1.00 H             | 276                  | 34.6             | -8.1                     |
| 5  | 587.00      | 28.1 QP                 | 46.0           | -17.9       | 2.50 H             | 166                  | 28.6             | -0.5                     |
| 6  | 849.04      | 30.5 QP                 | 46.0           | -15.5       | 1.50 H             | 69                   | 27.0             | 3.5                      |

| <b>ANTENNA POLARITY &amp; TEST DISTANCE: VERTICAL AT 3 M</b> |              |                         |                |             |                    |                      |                  |                          |
|--|--------------|-------------------------|----------------|-------------|--------------------|----------------------|------------------|--------------------------|
| NO.  | FREQ. (MHz)  | EMISSION LEVEL (dBuV/m) | LIMIT (dBuV/m) | MARGIN (dB) | ANTENNA HEIGHT (m) | TABLE ANGLE (Degree) | RAW VALUE (dBuV) | CORRECTION FACTOR (dB/m) |
| <b>1</b>   | <b>81.65</b> | <b>31.2 QP</b>          | <b>40.0</b>    | <b>-8.8</b> | <b>2.00 V</b>      | <b>31</b>            | <b>44.4</b>      | <b>-13.2</b>             |
| 2  | 159.37       | 30.0 QP                 | 43.5           | -13.5       | 1.00 V             | 109                  | 38.3             | -8.3                     |
| 3  | 558.46       | 28.5 QP                 | 46.0           | -17.5       | 1.00 V             | 45                   | 29.9             | -1.4                     |
| 4  | 615.73       | 29.7 QP                 | 46.0           | -16.3       | 1.50 V             | 360                  | 29.5             | 0.2                      |
| 5  | 644.33       | 30.6 QP                 | 46.0           | -15.4       | 2.50 V             | 182                  | 29.9             | 0.7                      |
| 6  | 923.25       | 33.1 QP                 | 46.0           | -12.9       | 2.50 V             | 360                  | 28.2             | 4.9                      |

**REMARKS:**

1. Emission Level(dBuV/m) = Raw Value(dBuV) + Correction Factor(dB/m)
2. Correction Factor(dB/m) = Antenna Factor(dB/m) + Cable Factor(dB) – Pre-Amplifier Factor(dB)
3. The other emission levels were very low against the limit.
4. Margin value = Emission Level – Limit value

## 4.2 Conducted Emission Measurement

### 4.2.1 Limits of Conducted Emission Measurement

| Frequency (MHz) | Conducted Limit (dBuV) |         |
|-----------------|------------------------|---------|
|                 | Quasi-peak             | Average |
| 0.15 - 0.5      | 66 - 56                | 56 - 46 |
| 0.50 - 5.0      | 56                     | 46      |
| 5.0 - 30.0      | 60                     | 50      |

Note: 1. The lower limit shall apply at the transition frequencies.

2. The limit decreases in line with the logarithm of the frequency in the range of 0.15 to 0.50MHz.

### 4.2.2 Test Instruments

| DESCRIPTION & MANUFACTURER   | MODEL NO.               | SERIAL NO. | CALIBRATED DATE | CALIBRATED UNTIL |
|--|-------------------------|------------|-----------------|------------------|
| Test Receiver<br>R&S   | ESCS 30                 | 847124/029 | Oct. 24, 2016   | Oct. 23, 2017    |
| Line-Impedance<br>Stabilization Network<br>(for EUT)<br>R&S        | ESH3-Z5                 | 848773/004 | Oct. 26, 2016   | Oct. 25, 2017    |
| Line-Impedance<br>Stabilization Network<br>(for Peripheral)<br>R&S | ENV216                  | 100072     | June 13, 2016   | June 12, 2017    |
| RF Cable   | 5D-FB                   | COCCAB-001 | Sep. 30, 2016   | Sep. 29, 2017    |
| 10 dB PAD<br>Mini-Circuits   | HAT-10+                 | CONATT-004 | June 20, 2016   | June 19, 2017    |
| Software<br>BVADT  | BVADT_Cond_<br>V7.3.7.4 | NA         | NA              | NA               |

**Note:**

1. The calibration interval of the above test instruments are 12 months and the calibrations are traceable to NML/ROC and NIST/USA.
2. The test was performed in Shielded Room No. 1.
3. Tested Date: Nov. 23, 2016

#### 4.2.3 Test Procedures

- The EUT was placed 0.4 meters from the conducting wall of the shielded room with EUT being connected to the power mains through a line impedance stabilization network (LISN). Other support units were connected to the power mains through another LISN. The two LISNs provide 50 ohm/ 50uH of coupling impedance for the measuring instrument.
- Both lines of the power mains connected to the EUT were checked for maximum conducted interference.
- The frequency range from 150kHz to 30MHz was searched. Emission levels under (Limit - 20dB) was not recorded.

**NOTE:** The resolution bandwidth and video bandwidth of test receiver is 9kHz for quasi-peak detection (QP) and average detection (AV) at frequency 0.15MHz-30MHz.

#### 4.2.4 Deviation From Test Standard

No deviation.

#### 4.2.5 Test Setup

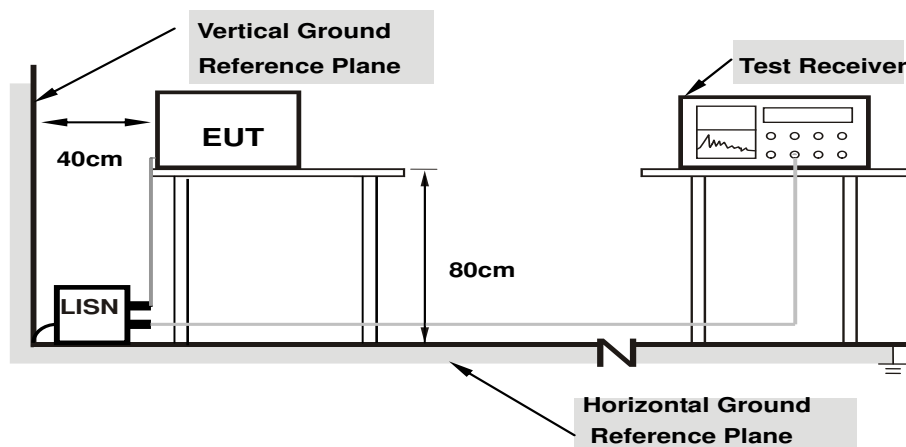

**Note: 1.Support units were connected to second LISN.**

For the actual test configuration, please refer to the attached file (Test Setup Photo).

#### 4.2.6 EUT Operating Condition

Same as 4.1.6.

#### 4.2.7 Test Results (Mode 1)

|       |          |                   |                                |
|-------|----------|-------------------|--------------------------------|
| Phase | Line (L) | Detector Function | Quasi-Peak (QP) / Average (AV) |
|-------|----------|-------------------|--------------------------------|

| Phase Of Power : Line (L) |                 |                        |                      |       |                       |       |              |       |             |        |
|---------------------------|-----------------|------------------------|----------------------|-------|-----------------------|-------|--------------|-------|-------------|--------|
| No                        | Frequency (MHz) | Correction Factor (dB) | Reading Value (dBuV) |       | Emission Level (dBuV) |       | Limit (dBuV) |       | Margin (dB) |        |
|                           |                 |                        | Q.P.                 | AV.   | Q.P.                  | AV.   | Q.P.         | AV.   | Q.P.        | AV.    |
| 1                         | 0.15000         | 10.20                  | 38.53                | 23.75 | 48.73                 | 33.95 | 66.00        | 56.00 | -17.27      | -22.05 |
| 2                         | 0.22812         | 10.21                  | 29.82                | 17.21 | 40.03                 | 27.42 | 62.52        | 52.52 | -22.49      | -25.10 |
| 3                         | 0.44688         | 10.24                  | 29.66                | 20.49 | 39.90                 | 30.73 | 56.93        | 46.93 | -17.03      | -16.20 |
| 4                         | 0.99375         | 10.30                  | 11.69                | 1.59  | 21.99                 | 11.89 | 56.00        | 46.00 | -34.01      | -34.11 |
| 5                         | 2.33594         | 10.29                  | 12.76                | 2.40  | 23.05                 | 12.69 | 56.00        | 46.00 | -32.95      | -33.31 |
| 6                         | 10.00781        | 10.73                  | 7.54                 | 0.23  | 18.27                 | 10.96 | 60.00        | 50.00 | -41.73      | -39.04 |

#### Remarks:

1. Q.P. and AV. are abbreviations of quasi-peak and average individually.
2. The emission levels of other frequencies were very low against the limit.
3. Margin value = Emission level – Limit value
4. Correction factor = Insertion loss + Cable loss
5. Emission Level = Correction Factor + Reading Value

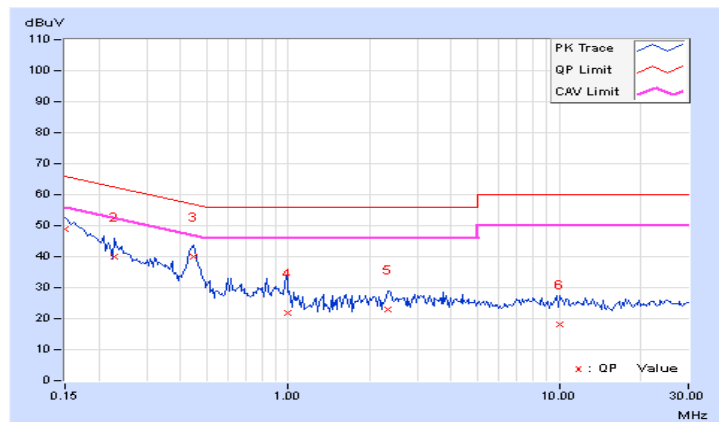

|       |             |                   |                                |
|-------|-------------|-------------------|--------------------------------|
| Phase | Neutral (N) | Detector Function | Quasi-Peak (QP) / Average (AV) |
|-------|-------------|-------------------|--------------------------------|

| Phase Of Power : Neutral (N) |                 |                        |                      |       |                       |       |              |       |             |        |
|------------------------------|-----------------|------------------------|----------------------|-------|-----------------------|-------|--------------|-------|-------------|--------|
| No                           | Frequency (MHz) | Correction Factor (dB) | Reading Value (dBuV) |       | Emission Level (dBuV) |       | Limit (dBuV) |       | Margin (dB) |        |
|                              |                 |                        | Q.P.                 | AV.   | Q.P.                  | AV.   | Q.P.         | AV.   | Q.P.        | AV.    |
| 1                            | 0.15000         | 10.19                  | 40.25                | 26.82 | 50.44                 | 37.01 | 66.00        | 56.00 | -15.56      | -18.99 |
| 2                            | 0.31016         | 10.21                  | 26.90                | 14.46 | 37.11                 | 24.67 | 59.97        | 49.97 | -22.86      | -25.30 |
| 3                            | 0.36094         | 10.23                  | 22.80                | 11.49 | 33.03                 | 21.72 | 58.71        | 48.71 | -25.68      | -26.99 |
| 4                            | 0.50000         | 10.24                  | 16.23                | 4.09  | 26.47                 | 14.33 | 56.00        | 46.00 | -29.53      | -31.67 |
| 5                            | 0.84922         | 10.25                  | 11.07                | 2.27  | 21.32                 | 12.52 | 56.00        | 46.00 | -34.68      | -33.48 |
| 6                            | 14.27734        | 11.02                  | 2.18                 | -2.04 | 13.20                 | 8.98  | 60.00        | 50.00 | -46.80      | -41.02 |

**Remarks:**

1. Q.P. and AV. are abbreviations of quasi-peak and average individually.
2. The emission levels of other frequencies were very low against the limit.
3. Margin value = Emission level – Limit value
4. Correction factor = Insertion loss + Cable loss
5. Emission Level = Correction Factor + Reading Value

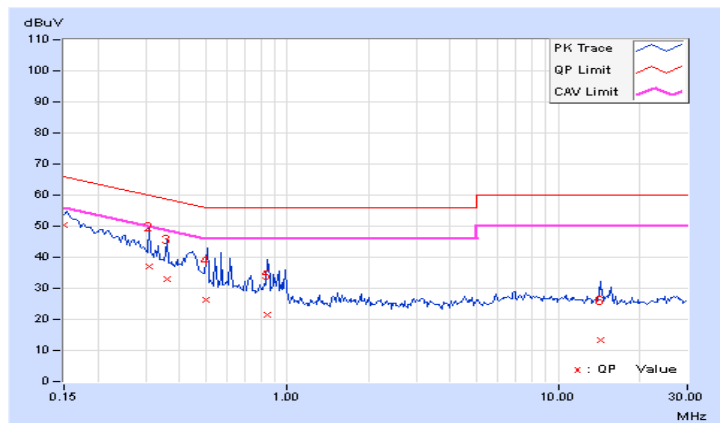



#### 4.2.8 Test Results (Mode 2)

|       |          |                   |                                |
|-------|----------|-------------------|--------------------------------|
| Phase | Line (L) | Detector Function | Quasi-Peak (QP) / Average (AV) |
|-------|----------|-------------------|--------------------------------|

| Phase Of Power : Line (L) |                 |                        |                      |       |                       |       |              |       |             |        |
|---------------------------|-----------------|------------------------|----------------------|-------|-----------------------|-------|--------------|-------|-------------|--------|
| No                        | Frequency (MHz) | Correction Factor (dB) | Reading Value (dBuV) |       | Emission Level (dBuV) |       | Limit (dBuV) |       | Margin (dB) |        |
|                           |                 |                        | Q.P.                 | AV.   | Q.P.                  | AV.   | Q.P.         | AV.   | Q.P.        | AV.    |
| 1                         | 0.15000         | 10.19                  | 34.20                | 19.93 | 44.39                 | 30.12 | 66.00        | 56.00 | -21.61      | -25.88 |
| 2                         | 0.49375         | 10.23                  | 26.65                | 21.53 | 36.88                 | 31.76 | 56.10        | 46.10 | -19.22      | -14.34 |
| 3                         | 0.86875         | 10.25                  | 15.77                | 10.17 | 26.02                 | 20.42 | 56.00        | 46.00 | -29.98      | -25.58 |
| 4                         | 2.64844         | 10.24                  | 26.77                | 21.55 | 37.01                 | 31.79 | 56.00        | 46.00 | -18.99      | -14.21 |
| 5                         | 9.94531         | 10.55                  | 16.37                | 10.57 | 26.92                 | 21.12 | 60.00        | 50.00 | -33.08      | -28.88 |
| 6                         | 20.09375        | 11.38                  | 13.16                | 7.52  | 24.54                 | 18.90 | 60.00        | 50.00 | -35.46      | -31.10 |

#### Remarks:

1. Q.P. and AV. are abbreviations of quasi-peak and average individually.
2. The emission levels of other frequencies were very low against the limit.
3. Margin value = Emission level – Limit value
4. Correction factor = Insertion loss + Cable loss
5. Emission Level = Correction Factor + Reading Value

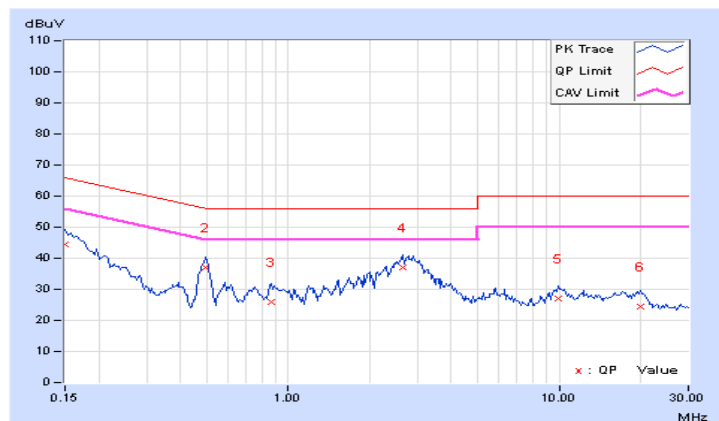

|       |             |                   |                                |
|-------|-------------|-------------------|--------------------------------|
| Phase | Neutral (N) | Detector Function | Quasi-Peak (QP) / Average (AV) |
|-------|-------------|-------------------|--------------------------------|

| Phase Of Power : Neutral (N) |                 |                        |                      |              |                       |              |              |              |               |               |
|------------------------------|-----------------|------------------------|----------------------|--------------|-----------------------|--------------|--------------|--------------|---------------|---------------|
| No                           | Frequency (MHz) | Correction Factor (dB) | Reading Value (dBUV) |              | Emission Level (dBUV) |              | Limit (dBUV) |              | Margin (dB)   |               |
|                              |                 |                        | Q.P.                 | AV.          | Q.P.                  | AV.          | Q.P.         | AV.          | Q.P.          | AV.           |
| 1                            | 0.15000         | 10.18                  | 34.04                | 19.95        | 44.22                 | 30.13        | 66.00        | 56.00        | -21.78        | -25.87        |
| 2                            | 0.20078         | 10.16                  | 24.87                | 11.89        | 35.03                 | 22.05        | 63.58        | 53.58        | -28.55        | -31.53        |
| 3                            | 0.49375         | 10.21                  | 24.68                | 19.26        | 34.89                 | 29.47        | 56.10        | 46.10        | -21.21        | -16.63        |
| <b>4</b>                     | <b>2.64063</b>  | <b>10.24</b>           | <b>26.29</b>         | <b>22.01</b> | <b>36.53</b>          | <b>32.25</b> | <b>56.00</b> | <b>46.00</b> | <b>-19.47</b> | <b>-13.75</b> |
| 5                            | 9.94141         | 10.49                  | 21.35                | 11.16        | 31.84                 | 21.65        | 60.00        | 50.00        | -28.16        | -28.35        |
| 6                            | 20.12891        | 11.10                  | 12.60                | 6.62         | 23.70                 | 17.72        | 60.00        | 50.00        | -36.30        | -32.28        |

**Remarks:**

1. Q.P. and AV. are abbreviations of quasi-peak and average individually.
2. The emission levels of other frequencies were very low against the limit.
3. Margin value = Emission level – Limit value
4. Correction factor = Insertion loss + Cable loss
5. Emission Level = Correction Factor + Reading Value

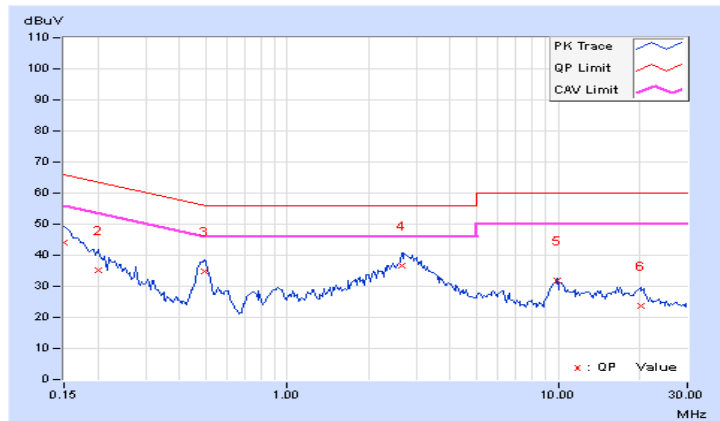

### 4.3 Number of Hopping Frequency Used

#### 4.3.1 Limits of Hopping Frequency Used Measurement

At least 15 channels frequencies, and should be equally spaced.

#### 4.3.2 Test Setup



#### 4.3.3 Test Instruments

Refer to section 4.1.2 to get information of above instrument.

#### 4.3.4 Test Procedure

- a. Check the calibration of the measuring instrument (SA) using either an internal calibrator or a known signal from an external generator.
- b. Turn on the EUT and connect its antenna terminal to measurement via a low loss cable. Then set it to any one measured frequency within its operating range and make sure the instrument is operated in its linear range.
- c. Set the SA on MaxHold Mode, and then keep the EUT in hopping mode. Record all the signals from each channel until each one has been recorded.
- d. Set the SA on View mode and then plot the result on SA screen.
- e. Repeat above procedures until all frequencies measured were complete.

#### 4.3.5 Deviation from Test Standard

No deviation.

#### 4.3.6 Test Results

There are 79 hopping frequencies in the hopping mode. Please refer to next page for the test result. On the plots, it shows that the hopping frequencies are equally spaced.



#### 4.4 Dwell Time on Each Channel

##### 4.4.1 Limits of Dwell Time on Each Channel Measurement

The average time of occupancy on any channel shall not be greater than 0.4 seconds within a period of 0.4 seconds multiplied by the number of hopping channels employed.

##### 4.4.2 Test Setup

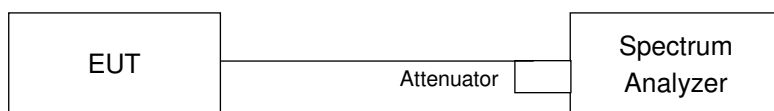

##### 4.4.3 Test Instruments

Refer to section 4.1.2 to get information of above instrument.

##### 4.4.4 Test Procedures

- a. Check the calibration of the measuring instrument (SA) using either an internal calibrator or a known signal from an external generator.
- b. Turn on the EUT and connect its antenna terminal to measurement via a low loss cable. Then set it to any one measured frequency within its operating range and make sure the instrument is operated in its linear range.
- c. Adjust the center frequency of SA on any frequency be measured and set SA to zero span mode. And then, set RBW and VBW of spectrum analyzer to proper value.
- d. Measure the time duration of one transmission on the measured frequency. And then plot the result with time difference of this time duration.
- e. Repeat above procedures until all different time-slot modes have been completed.

##### 4.4.5 Deviation from Test Standard

No deviation.

#### 4.4.6 Test Results

##### GFSK

| Mode | Number of transmission in a 31.6 (79Hopping*0.4) | Length of transmission time (msec) | Result (msec) | Limit (msec) |
|------|--|------------------------------------|---------------|--------------|
| DH1  | 50 (times / 5 sec) * 6.32 = 316 times            | 0.432                              | 136.51        | 400          |
| DH3  | 12 (times / 5 sec) * 6.32 = 75.84 times          | 1.71                               | 129.69        | 400          |
| DH5  | 11 (times / 5 sec) * 6.32 = 69.52 times          | 2.992                              | 208           | 400          |

**NOTE:** Test plots of the transmitting time slot are shown on next page.

### DH1

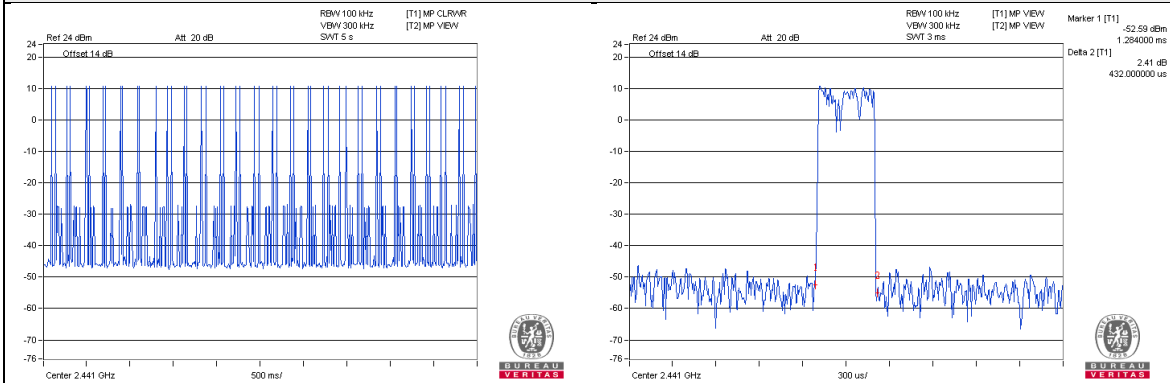

### DH3

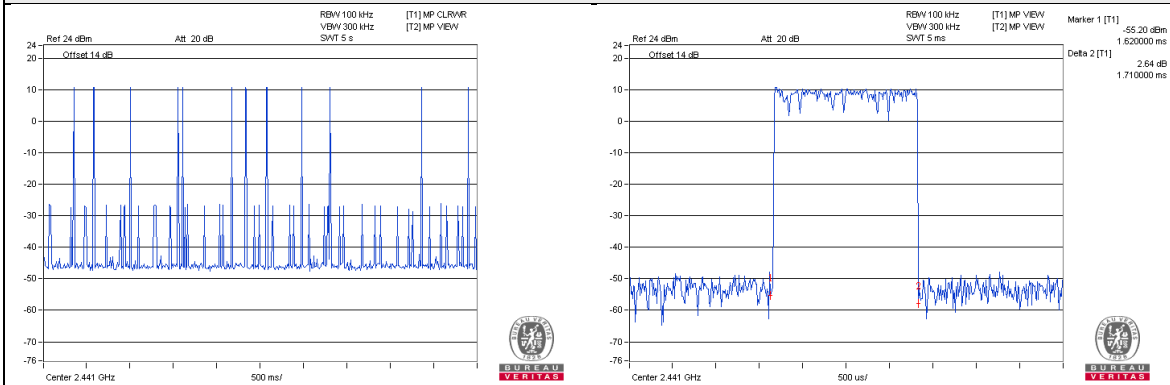

### DH5

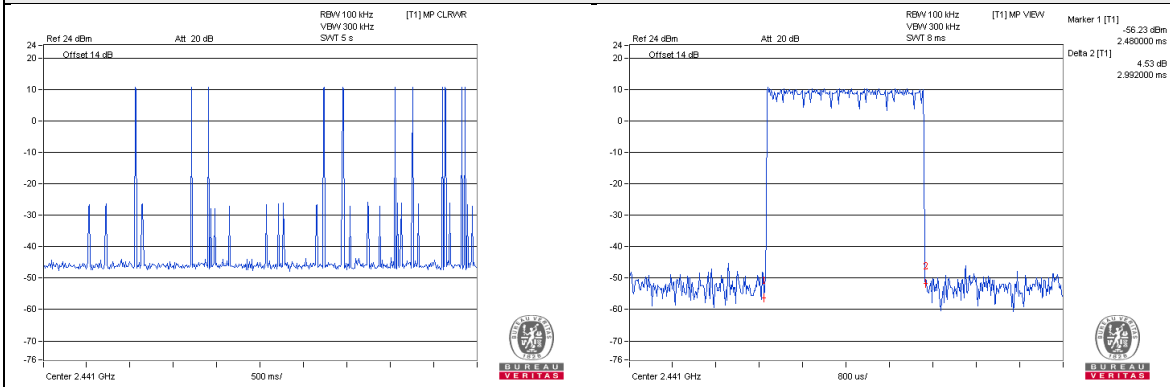

### 8DPSK

| Mode | Number of transmission in a 31.6 (79Hopping*0.4) | Length of transmission time (msec) | Result (msec) | Limit (msec) |
|------|--|------------------------------------|---------------|--------------|
| 3DH1 | 44 (times / 5 sec) * 6.32 = 278.08 times         | 0.426                              | 118.46        | 400          |
| 3DH3 | 12 (times / 5 sec) * 6.32 = 75.84 times          | 1.73                               | 131.2         | 400          |
| 3DH5 | 10 (times / 5 sec) * 6.32 = 63.2 times           | 2.992                              | 189.09        | 400          |

**NOTE:** Test plots of the transmitting time slot are shown on next page.



### 3DH1

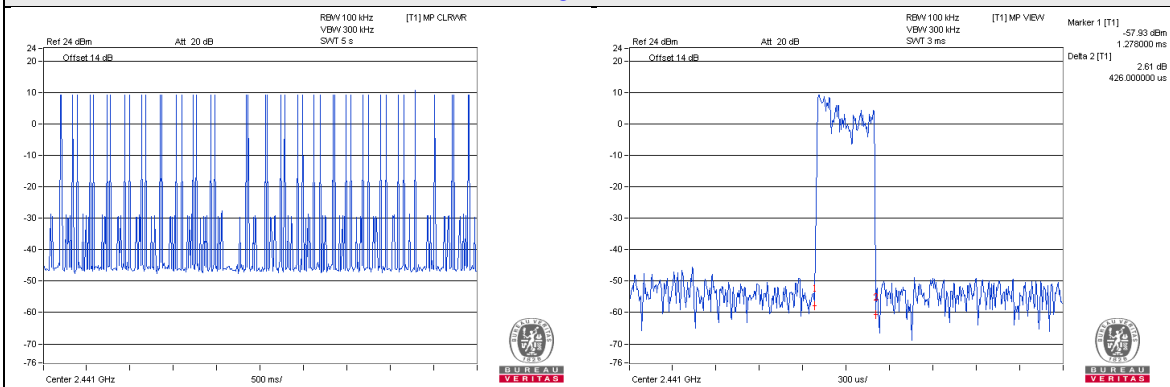

### 3DH3

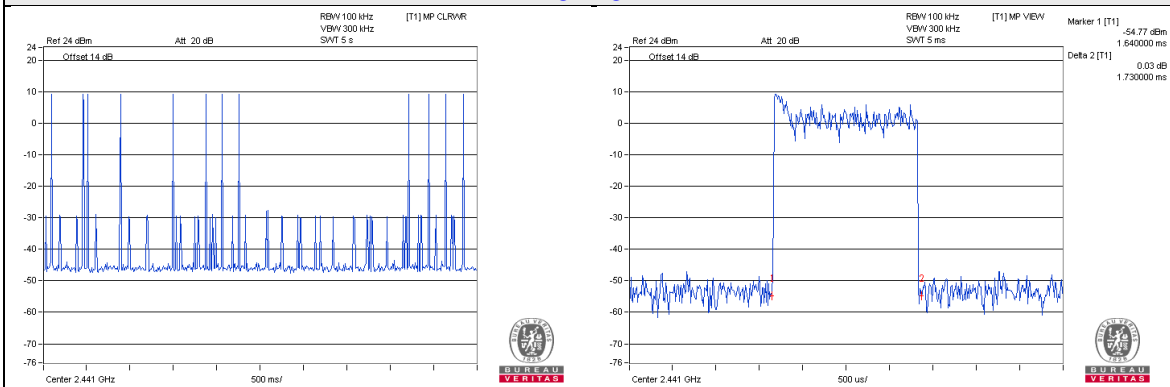

### 3DH5

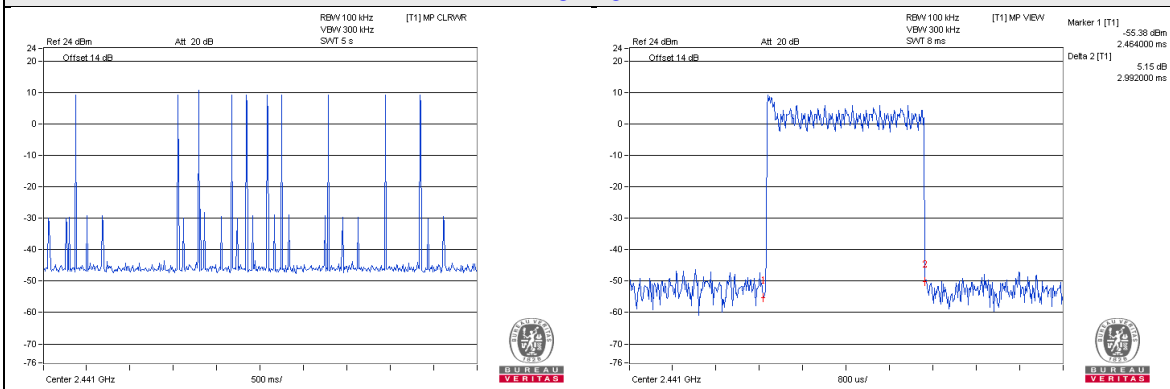

## 4.5 Channel Bandwidth

### 4.5.1 Limits of Channel Bandwidth Measurement

For frequency hopping system operating in the 2400-2483.5MHz, If the 20dB bandwidth of hopping channel is greater than 25kHz, two-thirds 20dB bandwidth of hopping channel shall be a minimum limit for the hopping channel separation.

### 4.5.2 Test Setup

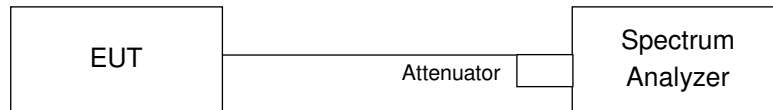

### 4.5.3 Test Instruments

Refer to section 4.1.2 to get information of above instrument.

### 4.5.4 Test Procedure

- Check the calibration of the measuring instrument using either an internal calibrator or a known signal from an external generator.
- Turn on the EUT and connect it to measurement instrument. Then set it to any one convenient frequency within its operating range. Set a reference level on the measuring instrument equal to the highest peak value.
- Measure the frequency difference of two frequencies that were attenuated 20dB from the reference level. Record the frequency difference as the emission bandwidth.
- Repeat above procedures until all frequencies measured were complete.

### 4.5.5 Deviation from Test Standard

No deviation.

### 4.5.6 EUT Operating Condition

The software provided by client enabled the EUT to transmit and receive data at lowest, middle and highest channel frequencies individually.

### 4.5.7 Test Results

| Channel | Frequency (MHz) | 20dB Bandwidth (MHz) |       |
|---------|-----------------|----------------------|-------|
|         |                 | GFSK                 | 8DPSK |
| 0       | 2402            | 0.96                 | 1.29  |
| 39      | 2441            | 0.95                 | 1.28  |
| 78      | 2480            | 0.96                 | 1.28  |

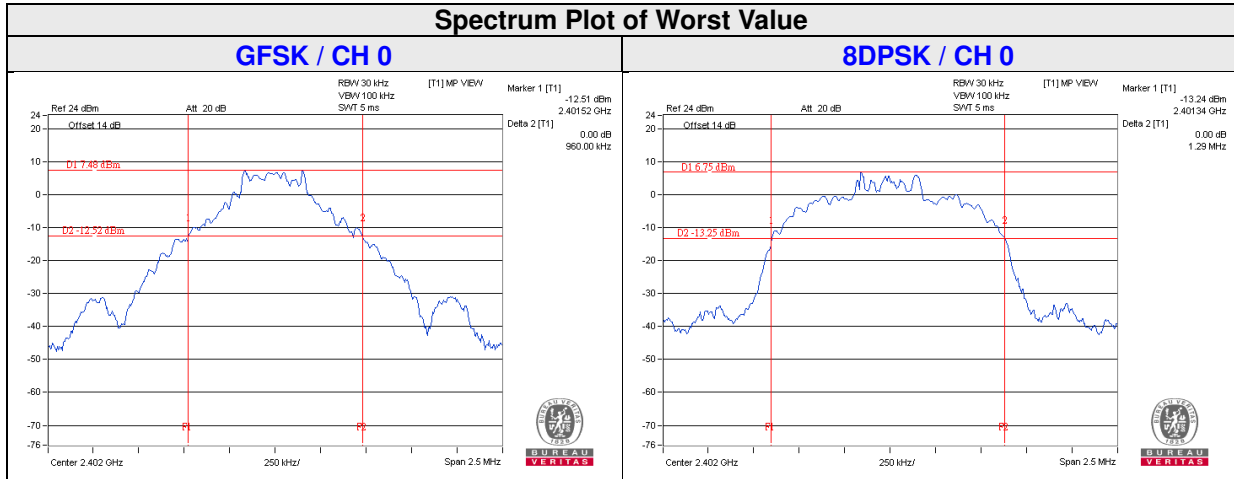

## 4.6 Hopping Channel Separation

### 4.6.1 Limits of Hopping Channel Separation Measurement

At least 25kHz or two-third of 20dB hopping channel bandwidth (whichever is greater).

### 4.6.2 Test Setup

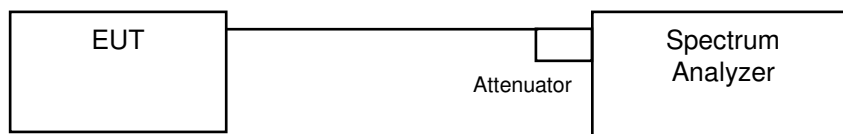

### 4.6.3 Test Instruments

Refer to section 4.1.2 to get information of above instrument.

### 4.6.4 Test Procedure

#### Measurement Procedure REF

- a. Check the calibration of the measuring instrument using either an internal calibrator or a known signal from an external generator.
- b. Turn on the EUT and connect it to measurement instrument. Then set it to any one convenient frequency within its operating range.
- c. By using the MaxHold function record the separation of two adjacent channels.
- d. Measure the frequency difference of these two adjacent channels by SA MARK function. And then plot the result on SA screen.
- e. Repeat above procedures until all frequencies measured were complete.

### 4.6.5 Deviation from Test Standard

No deviation.

#### 4.6.6 Test Results

| Channel | Frequency (MHz) | Adjacent Channel Separation (MHz) |       | 20dB Bandwidth (MHz) |       | Minimum Limit (MHz) |       | Pass / Fail |
|---------|-----------------|-----------------------------------|-------|----------------------|-------|---------------------|-------|-------------|
|         |                 | GFSK                              | 8DPSK | GFSK                 | 8DPSK | GFSK                | 8DPSK |             |
| 0       | 2402            | 1.00                              | 1.00  | 0.96                 | 1.29  | 0.64                | 0.86  | Pass        |
| 39      | 2441            | 1.00                              | 1.00  | 0.95                 | 1.28  | 0.64                | 0.86  | Pass        |
| 78      | 2480            | 1.00                              | 1.00  | 0.96                 | 1.28  | 0.64                | 0.86  | Pass        |

**NOTE:** The minimum limit is two-third 20dB bandwidth.

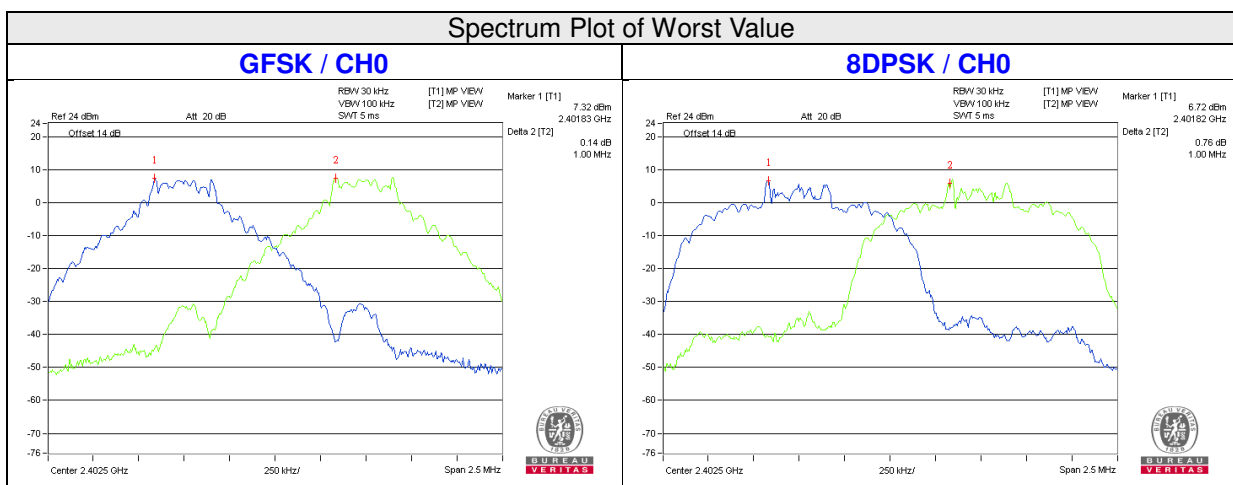

## 4.7 Maximum Output Power

### 4.7.1 Limits of Maximum Output Power Measurement

The Maximum Output Power Measurement is 125mW.

### 4.7.2 Test Setup

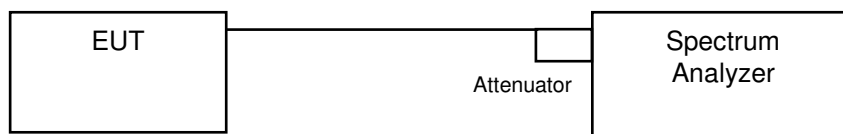

### 4.7.3 Test Instruments

Refer to section 4.1.2 to get information of above instrument.

### 4.7.4 Test Procedure

- a. Check the calibration of the measuring instrument using either an internal calibrator or a known signal from an external generator.
- b. Turn on the EUT and connect it to measurement instrument. Then set it to any one convenient frequency within its operating range. Set a reference level on the measuring instrument equal to the highest peak value.
- c. The center frequency of the spectrum analyzer is set to the fundamental frequency and using 3MHz RBW and 10 MHz VBW.
- d. Measure the captured power within the band and recording the plot.
- e. Repeat above procedures until all frequencies required were complete.

### 4.7.5 Deviation from Test Standard

No deviation.

### 4.7.6 EUT Operating Condition

The software provided by client enabled the EUT to transmit and receive data at lowest, middle and highest channel frequencies individually.

#### 4.7.7 Test Results

| Channel | Frequency (MHZ) | Output Power (mW) |        | Output Power (dBm) |       | Power Limit (mW) | Pass / Fail |
|---------|-----------------|-------------------|--------|--------------------|-------|------------------|-------------|
|         |                 | GFSK              | 8DPSK  | GFSK               | 8DPSK |                  |             |
| 0       | 2402            | 9.162             | 9.908  | 9.62               | 9.96  | 125              | Pass        |
| 39      | 2441            | 12.735            | 13.677 | 11.05              | 11.36 | 125              | Pass        |
| 78      | 2480            | 8.185             | 8.531  | 9.13               | 9.31  | 125              | Pass        |

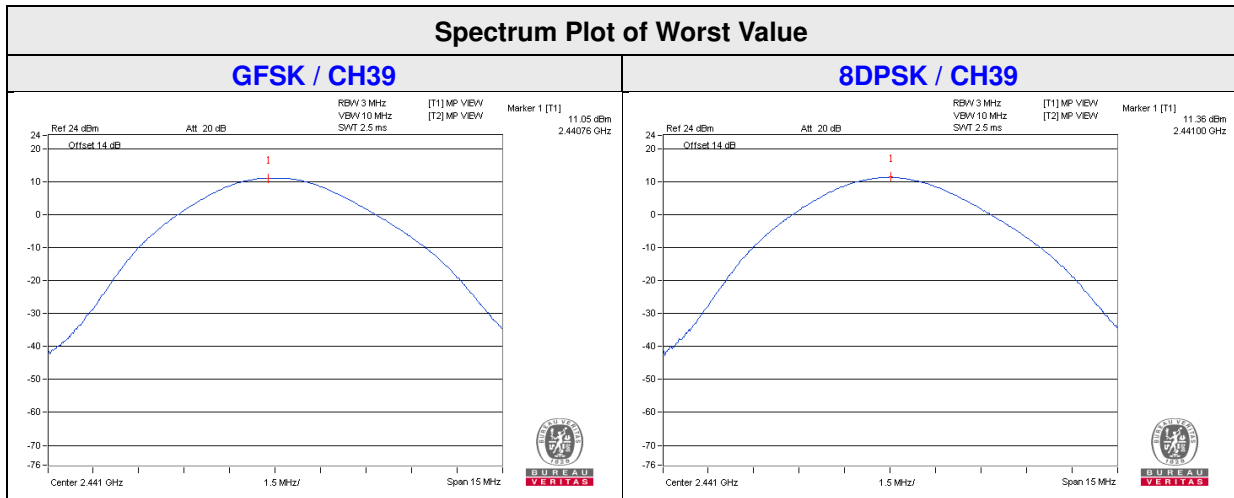

## 4.8 Conducted Out of Band Emission Measurement

### 4.8.1 Limits of Conducted Out of Band Emission Measurement

Below -20dB of the highest emission level of operating band (in 100kHz RBW).

### 4.8.2 Test Instruments

Refer to section 4.1.2 to get information of above instrument.

### 4.8.3 Test Procedure

The transmitter output was connected to the spectrum analyzer via a low lose cable. Set both RBW and VBW of spectrum analyzer to 100 kHz and 300 kHz with suitable frequency span including 100 MHz bandwidth from band edge. The band edges was measured and recorded.

### 4.8.4 Deviation from Test Standard

No deviation.

### 4.8.5 EUT Operating Condition

The software provided by client enabled the EUT to transmit and receive data at lowest, middle and highest channel frequencies individually.

### 4.8.6 Test Results

The spectrum plots are attached on the following images. D1 line indicates the highest level, D2 line indicates the 20dB offset below D1. It shows compliance with the requirement.



GFSK

Hopping disabled Low Channel

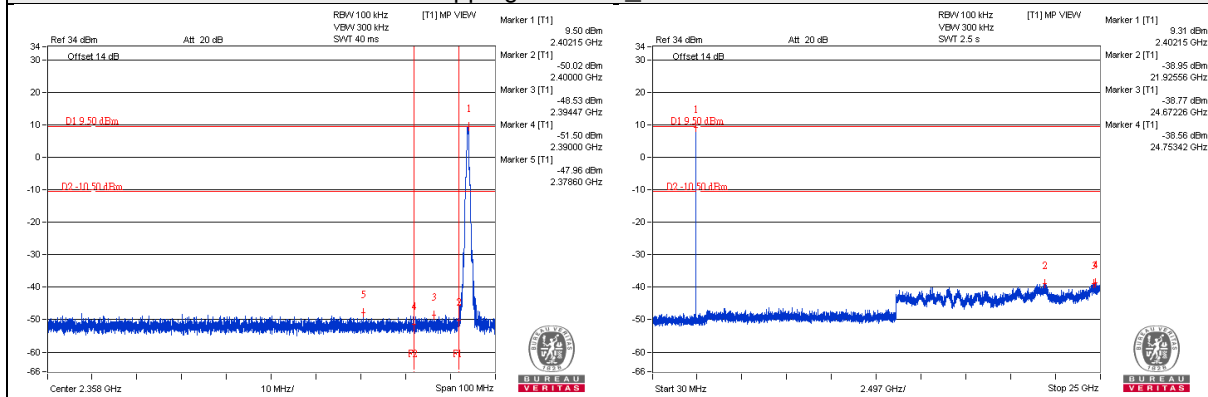

Hopping disabled High Channel

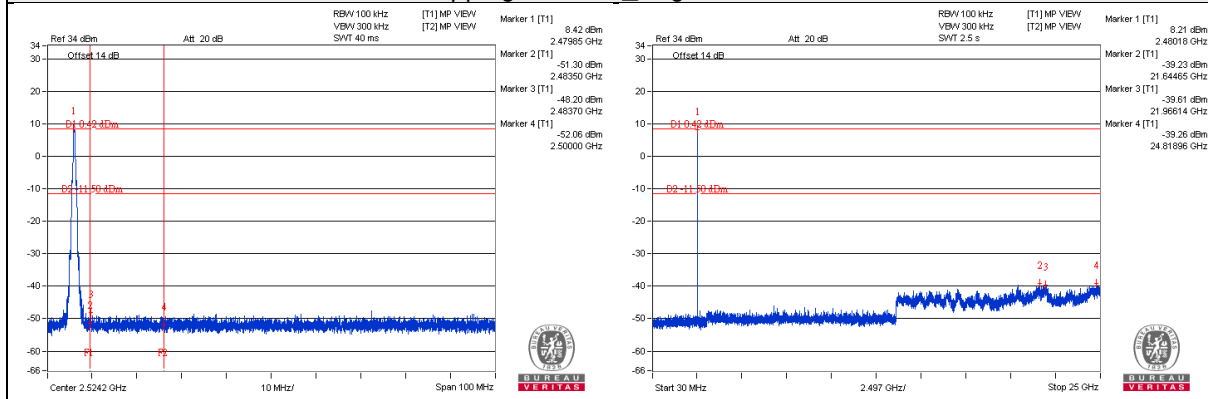

Hopping enabled Low Channel

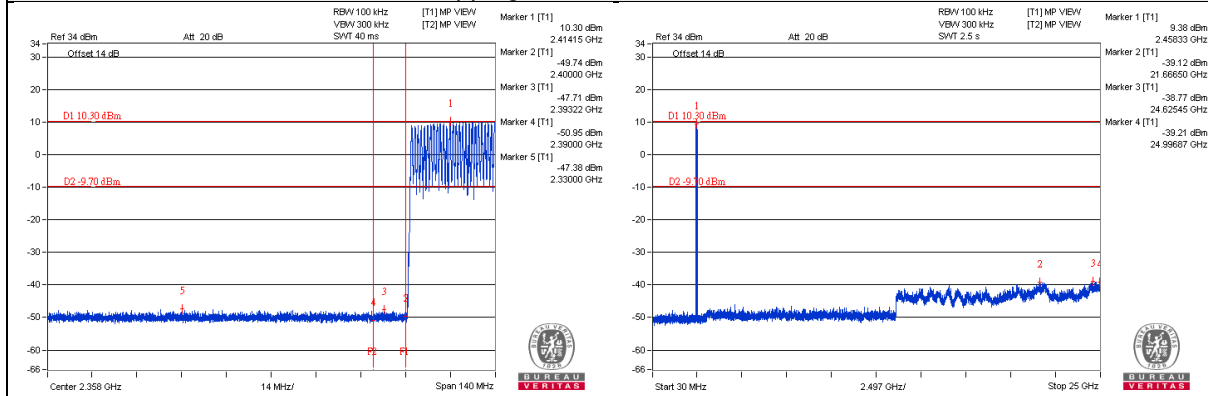

Hopping enabled High Channel

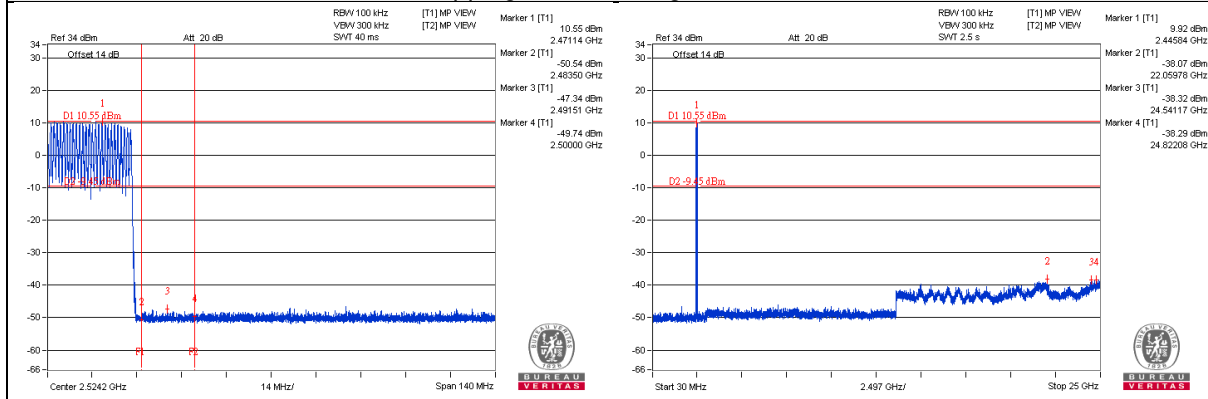

# 8DPSK

## Hopping disabled Low Channel

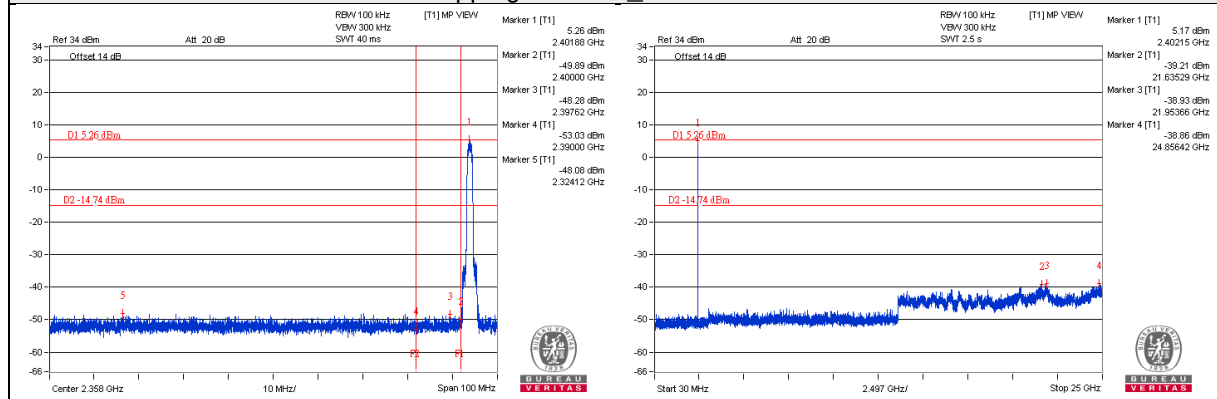

## Hopping disabled High Channel

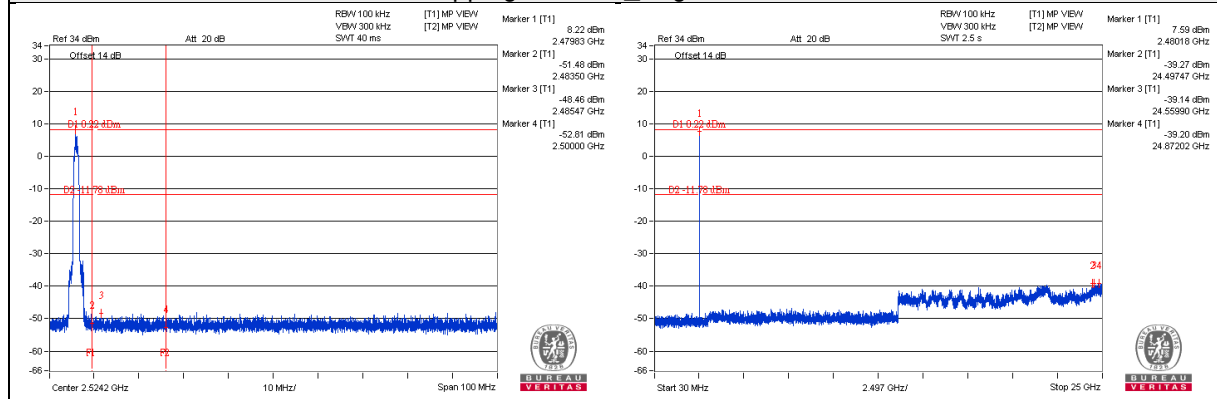

## Hopping enabled Low Channel

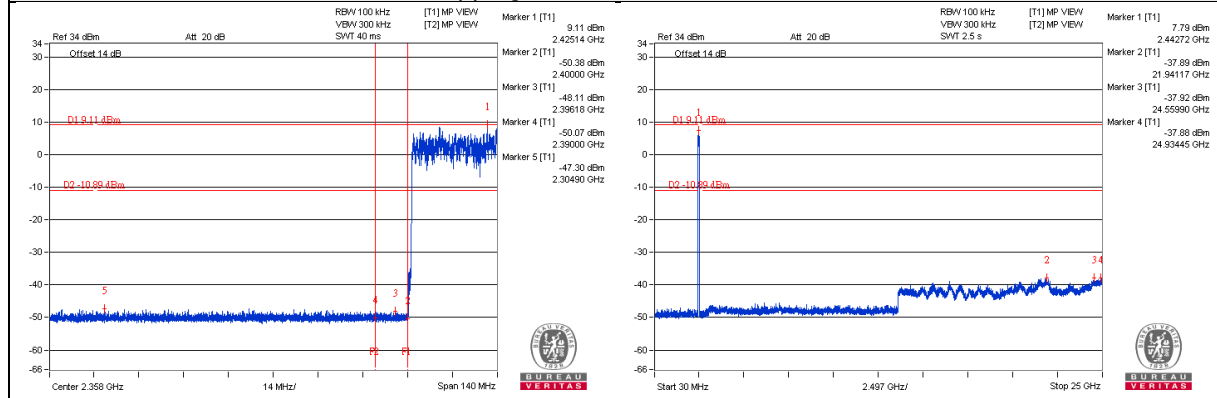

## Hopping enabled High Channel

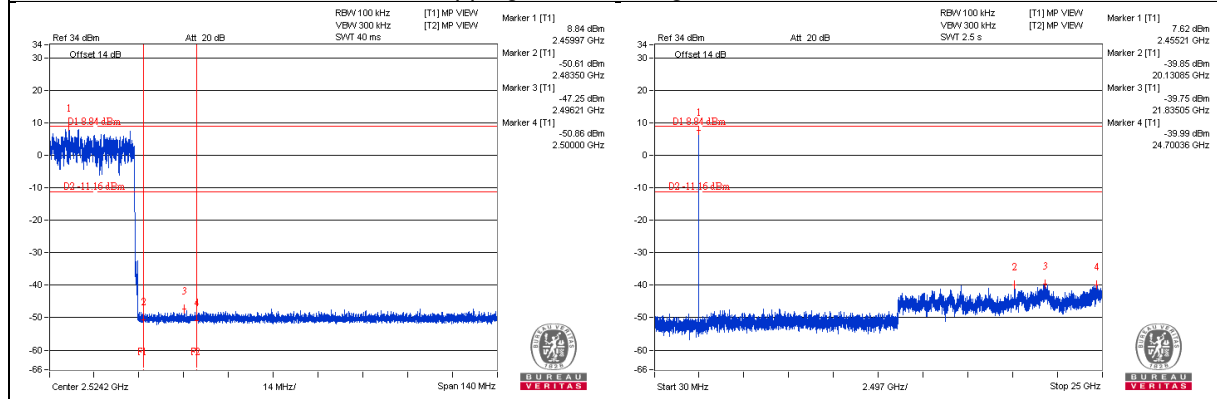

## 5 Pictures of Test Arrangements

Please refer to the attached file (Test Setup Photo).

## Appendix – Information on the Testing Laboratories

We, Bureau Veritas Consumer Products Services (H.K.) Ltd., Taoyuan Branch, were founded in 1988 to provide our best service in EMC, Radio, Telecom and Safety consultation. Our laboratories are accredited and approved according to ISO/IEC 17025.

If you have any comments, please feel free to contact us at the following:

**Linko EMC/RF Lab**

Tel: 886-2-26052180

Fax: 886-2-26051924

**Hsin Chu EMC/RF/Telecom Lab**

Tel: 886-3-6668565

Fax: 886-3-6668323

**Hwa Ya EMC/RF/Safety Lab**

Tel: 886-3-3183232

Fax: 886-3-3270892

**Email:** [service.adt@tw.bureauveritas.com](mailto:service.adt@tw.bureauveritas.com)

**Web Site:** [www.bureauveritas-adt.com](http://www.bureauveritas-adt.com)

The address and road map of all our labs can be found in our web site also.

--- END ---