

Supplemental “Transmit Simultaneously” Test Report

Report No.: RF170414E05-6

FCC ID: MQT-E200CP

Model No.: xCL_E200CP

Received Date: Apr. 14, 2017

Test Date: Apr. 18 to May 17, 2017

Issued Date: June 08, 2017

Applicant: XAC AUTOMATION CORP.

Address: 4F, No. 30, INDUSTRY E. RD. IX, SCIENCE-BASED INDUSTRIAL
PARK,HSINCHU,TAIWAN

Issued By: Bureau Veritas Consumer Products Services (H.K.) Ltd., Taoyuan Branch
Hsin Chu Laboratory

Lab Address: E-2, No.1, Li Hsin 1st Road, Hsinchu Science Park, Hsinchu City 300,
Taiwan R.O.C.

Test Location (1): E-2, No.1, Li Hsin 1st Road, Hsinchu Science Park, Hsinchu City 300,
Taiwan R.O.C.

Test Location (2): No. 49, Ln. 206, Wende Rd., Shangshan Tsuen, Chiung Lin Hsiang, Hsin
Chu Hsien 307, Taiwan R.O.C.



This report is for your exclusive use. Any copying or replication of this report to or for any other person or entity, or use of our name or trademark, is permitted only with our prior written permission. This report sets forth our findings solely with respect to the test samples identified herein. The results set forth in this report are not indicative or representative of the quality or characteristics of the lot from which a test sample was taken or any similar or identical product unless specifically and expressly noted. Our report includes all of the tests requested by you and the results thereof based upon the information that you provided to us. You have 60 days from date of issuance of this report to notify us of any material error or omission caused by our negligence, provided, however, that such notice shall be in writing and shall specifically address the issue you wish to raise. A failure to raise such issue within the prescribed time shall constitute your unqualified acceptance of the completeness of this report, the tests conducted and the correctness of the report contents. Unless specific mention, the uncertainty of measurement has been explicitly taken into account to declare the compliance or non-compliance to the specification. This report should not be used by the client to claim product certification, approval, or endorsement by TAF or any government agencies.

Table of Contents

Release Control Record	3
1 Certificate of Conformity	4
2 Summary of Test Results	5
2.1 Measurement Uncertainty	5
2.2 Modification Record	5
3 General Information	6
3.1 General Description of EUT	6
3.1.1 Test Mode Applicability and Tested Channel Detail	8
3.2 Description of Support Units	11
3.2.1 Configuration of System under Test	12
4 Test Types and Results	14
4.1 Radiated Emission and Bandedge Measurement	14
4.1.1 Limits of Radiated Emission and Bandedge Measurement	14
4.1.2 Test Instruments	15
4.1.3 Test Procedures	17
4.1.4 Deviation from Test Standard	17
4.1.5 Test Setup	18
4.1.6 EUT Operating Conditions	19
4.1.7 Test Results (Mode 1)	20
4.1.8 Test Results (Mode 2)	22
4.2 Conducted Emission Measurement	24
4.2.1 Limits of Conducted Emission Measurement	24
4.2.2 Test Instruments	24
4.2.3 Test Procedures	25
4.2.4 Deviation from Test Standard	25
4.2.5 Test Setup	25
4.2.6 EUT Operating Conditions	25
4.2.7 Test Results (Mode 1)	26
4.2.8 Test Results (Mode 2)	28
4.2.9 Test Results (Mode 3)	30
4.2.10 Test Results (Mode 4)	32
4.3 Conducted Out of Band Emission Measurement	34
4.3.1 Limits of Conducted Out of Band Emission Measurement	34
4.3.2 Test Setup	34
4.3.3 Test Instruments	34
4.3.4 Test Procedures	34
4.3.5 Deviation from Test Standard	34
4.3.6 EUT Operating Conditions	34
4.3.7 Test Results	34
5 Pictures of Test Arrangements	36
Appendix – Information on the Testing Laboratories	37

Release Control Record

Issue No.	Description	Date Issued
RF170414E05-6	Original release.	June 08, 2017

1 Certificate of Conformity

Product: Terminal

Brand: XAC

Model No.: xCL_E200CP

Sample Status: ENGINEERING SAMPLE

Applicant: XAC AUTOMATION CORP.

Test Date: Apr. 18 to May 17, 2017

Standards: 47 CFR FCC Part 15, Subpart C (Section 15.247)
47 CFR FCC Part 15, Subpart E (Section 15.407)
ANSI C63.10: 2013

The above equipment has been tested by **Bureau Veritas Consumer Products Services (H.K.) Ltd., Taoyuan Branch**, and found compliance with the requirement of the above standards. The test record, data evaluation & Equipment Under Test (EUT) configurations represented herein are true and accurate accounts of the measurements of the sample's EMC characteristics under the conditions specified in this report.

Prepared by :  _____, **Date:** June 08, 2017
Claire Kuan / Specialist

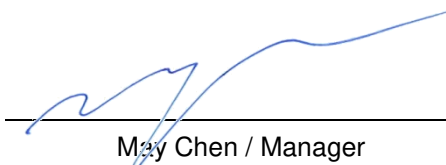
Approved by :  _____, **Date:** June 08, 2017
May Chen / Manager

2 Summary of Test Results

47 CFR FCC Part 15, Subpart C, E (SECTION 15.247, 15.407)			
FCC Clause	Test Item	Result	Remarks
15.207 15.407(b)(6)	AC Power Conducted Emission	PASS	Meet the requirement of limit. Minimum passing margin is -3.85dB at 0.16912MHz.
15.205 / 15.209 / 15.247(d) 15.407(b) (1/2/3/4(i/ii)/6)	Radiated Emissions and Band Edge Measurement	PASS	Meet the requirement of limit. Minimum passing margin is -2.1dB at 203.75MHz.

2.1 Measurement Uncertainty

Where relevant, the following measurement uncertainty levels have been estimated for tests performed on the EUT as specified in CISPR 16-4-2:

Measurement	Frequency	Expanded Uncertainty (k=2) (±)
Conducted Emissions at mains ports	150kHz ~ 30MHz	1.84 dB
Radiated Emissions up to 1 GHz	30MHz ~ 1GHz	5.30 dB
Radiated Emissions above 1 GHz	1GHz ~ 6GHz	5.16 dB
	6GHz ~ 18GHz	4.91 dB
	18GHz ~ 40GHz	5.30 dB

2.2 Modification Record

There were no modifications required for compliance.

3 General Information

3.1 General Description of EUT

Product	Terminal
Brand	XAC
Model No.	xCL_E200CP
Status of EUT	ENGINEERING SAMPLE
Power Supply Rating	12Vdc from power adapter or 12Vdc from host equipment
Modulation Type	WLAN: CCK, DQPSK, DBPSK for DSSS 64QAM, 16QAM, QPSK, BPSK for OFDM BT-EDR: GFSK, $\pi/4$ -DQPSK, 8DPSK BT-LE: GFSK
Modulation Technology	WLAN: DSSS, OFDM BT-EDR: FHSS BT-LE: DTS RFID: ASK
Transfer Rate	802.11b: up to 11Mbps 802.11a/g: up to 54Mbps 802.11n: up to 150Mbps BT-EDR: Up to 3Mbps BT-LE: Up to 1Mbps
Operating Frequency	WLAN 2.4GHz: 2.412 ~ 2.462GHz 5GHz: 5.18~5.24GHz, 5.26~5.32GHz, 5.50~5.70GHz, 5.745~5.825GHz BT-EDR: 2402MHz ~ 2480MHz BT-LE: 2402MHz ~ 2480MHz RFID: 13.56MHz
Number of Channel	WLAN: 2.4GHz: 802.11b, 802.11g, 802.11n (HT20): 11 802.11n (HT40): 7 5GHz: 802.11a, 802.11n (HT20), 802.11ac (VHT20): 24 802.11n (HT40), 802.11ac (VHT40): 11 802.11ac (VHT80): 5 BT-EDR: 79 BT-LE: 40 RFID: 1
Antenna Type	Refer to Note
Antenna Connector	Refer to Note
Accessory Device	NA
Data Cable Supplied	NA

Note:

1. There are WLAN, Bluetooth, RFID technology used for the EUT.
2. Simultaneously transmission condition.

Condition	Technology		
1	WLAN (2.4GHz)	Bluetooth	RFID
2	WLAN (5GHz)	Bluetooth	RFID

3. The EUT could be supplied with a power adapter (only for test) as the following table:

Brand	Model No.	Spec.
DELTA	ADP-36PH B	AC I/P: 100-240V, 50-60Hz, 1A DC O/P: 12V, 3A DC output cable(Unshielded, 1.7m, with one core)

4. The antennas provided to the EUT, please refer to the following table:

WiFi/BT Antenna Spec.			
Antenna Net Gain(dBi)	Frequency range (GHz)	Antenna Type	Antenna Connector
4.01	2.4~2.4835	PCB	i-pex(MHF)
3.79	5.15~5.85		

RFID Antenna Spec.			
Antenna Net Gain(dBi)	Frequency range (MHz)	Antenna Type	Antenna Connector
13	13.56	Loop	N/A

5. The EUT incorporates a SISO function.

2.4GHz Band			
MODULATION MODE	DATA RATE (MCS)	TX & RX CONFIGURATION	
802.11b	1 ~ 11Mbps	1TX	1RX
802.11g	6 ~ 54Mbps	1TX	1RX
802.11n (HT20)	MCS 0~7	1TX	1RX
802.11n (HT40)	MCS 0~7	1TX	1RX
5GHz Band			
MODULATION MODE	DATA RATE (MCS)	TX & RX CONFIGURATION	
802.11a	6 ~ 54Mbps	1TX	1RX
802.11n (HT20)	MCS 0~7	1TX	1RX
802.11n (HT40)	MCS 0~7	1TX	1RX

6. For radiated emission test, the EUT was pre-tested under the following test modes :

Pre-test Mode	Power
Mode A	Power from adapter
Mode B	Power from host equipment

The worst radiated emission was found in **Mode A**. Therefore only the test data of the modes were recorded in this report.

7. The above EUT information is declared by manufacturer and for more detailed features description, please refer to the manufacturer's specifications or user's manual.

3.1.1 Test Mode Applicability and Tested Channel Detail

EUT Configure Mode	Applicable To				Description
	RE \geq 1G	RE $<$ 1G	PLC	OB	
1	√	√	√	√	WLAN (2.4GHz) + Bluetooth + RFID With adapter
2	√	√	√	√	WLAN (5GHz) + Bluetooth + RFID With adapter
3	-	-	√	-	WLAN (2.4GHz) + Bluetooth + RFID With host equipment
4	-	-	√	-	WLAN (5GHz) + Bluetooth + RFID With host equipment

Where **RE \geq 1G**: Radiated Emission above 1GHz **RE $<$ 1G**: Radiated Emission below 1GHz
PLC: Power Line Conducted Emission **OB**: Conducted Out-Band Emission Measurement

NOTE:

1. The EUT had been pre-tested on the positioned of each 2 axis. The worst case was found when positioned on **Y-plane**.
2. "-" means no effect.

Radiated Emission Test (Above 1GHz):

Following channel(s) was (were) selected for the final test as listed below.

MODE	AVAILABLE CHANNEL	TESTED CHANNEL	MODULATION TECHNOLOGY	MODULATION TYPE
802.11b + 8DPSK + RFID	1 to 11	1	DSSS	DBPSK
	0 to 78	39	FHSS	8DPSK
	1	1	-	ASK
802.11n (HT40) + 8DPSK + RFID	38 to 46 54 to 62 102 to 134 151 to 159	134	OFDM	BPSK
	0 to 78	39	FHSS	8DPSK
	1	1	-	ASK

Radiated Emission Test (Below 1GHz):
 Following channel(s) was (were) selected for the final test as listed below.

MODE	AVAILABLE CHANNEL	TESTED CHANNEL	MODULATION TECHNOLOGY	MODULATION TYPE
802.11b + 8DPSK + RFID	1 to 11	1	DSSS	DBPSK
	0 to 78	39	FHSS	8DPSK
	1	1	-	ASK
802.11n (HT40) + 8DPSK + RFID	38 to 46 54 to 62 102 to 134 151 to 159	134	OFDM	BPSK
	0 to 78	39	FHSS	8DPSK
	1	1	-	ASK

Power Line Conducted Emission Test:
 Following channel(s) was (were) selected for the final test as listed below.

MODE	AVAILABLE CHANNEL	TESTED CHANNEL	MODULATION TECHNOLOGY	MODULATION TYPE
802.11b + 8DPSK + RFID	1 to 11	1	DSSS	DBPSK
	0 to 78	39	FHSS	8DPSK
	1	1	-	ASK
802.11n (HT40) + 8DPSK + RFID	38 to 46 54 to 62 102 to 134 151 to 159	134	OFDM	BPSK
	0 to 78	39	FHSS	8DPSK
	1	1	-	ASK

Conducted Out-Band Emission Measurement:

Following channel(s) was (were) selected for the final test as listed below.

MODE	AVAILABLE CHANNEL	TESTED CHANNEL	MODULATION TECHNOLOGY	MODULATION TYPE
802.11b + 8DPSK	1 to 11	1	DSSS	DBPSK
	0 to 78	39	FHSS	8DPSK
802.11n (HT40) + 8DPSK	38 to 46 54 to 62 102 to 134 151 to 159	134	OFDM	BPSK
	0 to 78	39	FHSS	8DPSK

Test Condition:

APPLICABLE TO	ENVIRONMENTAL CONDITIONS	INPUT POWER	TESTED BY
RE \geq 1G	24deg. C, 67%RH	120Vac, 60Hz	Weiwei Lo
RE $<$ 1G	23deg. C, 64%RH	120Vac, 60Hz	Jyunchun Lin
PLC	25deg. C, 65%RH	120Vac, 60Hz	Andy Ho
OB	23deg. C, 66%RH	120Vac, 60Hz	Andy Ho

3.2 Description of Support Units

The EUT has been tested as an independent unit together with other necessary accessories or support units. The following support units or accessories were used to form a representative test configuration during the tests.

ID	Product	Brand	Model No.	Serial No.	FCC ID	Remarks
A.	iPod	Apple	MD778TA/A	CC4JMFL0F4T1	NA	Provided by Lab
B.	Earphone	Jazz	i82	NA	NA	Supplied by client
C.	PC	IBM	4810-350	NA	NA	Supplied by client
D.	NB	DELL	E6420	482T3R1	FCC DoC	Provided by Lab
E.	SAM card	NA	NA	NA	NA	Supplied by client

Note:

1. All power cords of the above support units are non-shielded (1.8m).

ID	Descriptions	Qty.	Length (m)	Shielding (Yes/No)	Cores (Qty.)	Remarks
1.	USB Cable	1	0.1	Yes	0	Provided by Lab
2.	RJ45 Cable	1	10	No	0	Provided by Lab
3.	RJ12 Cash Drawer Cable	1	1.2	No	0	Supplied by client
4.	Audio Cable	1	1.2	No	0	Supplied by client
5.	USB TypeC Cable	1	1	Yes	0	Supplied by client
6.	DC Cable	1	1.7	No	1	Supplied by client
7.	AC Cable	1	1	No	0	Supplied by client
8.	Power USB Cable	1	1.2	Yes	1	Supplied by client
9.	AC Cable	1	1.8	No	0	Provided by Lab

Note: The core(s) is(are) originally attached to the cable(s).

3.2.1 Configuration of System under Test

For adapter mode:

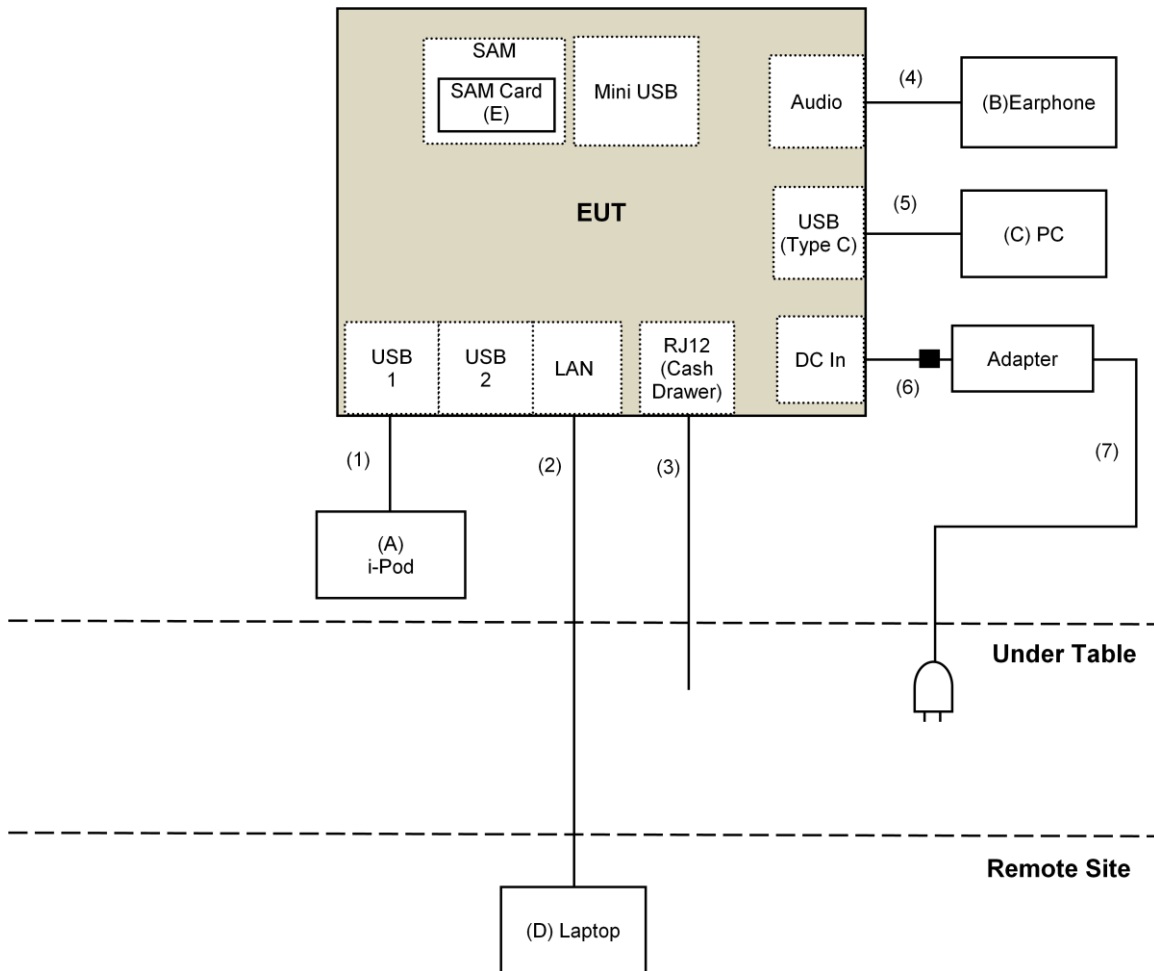

For host equipment mode:

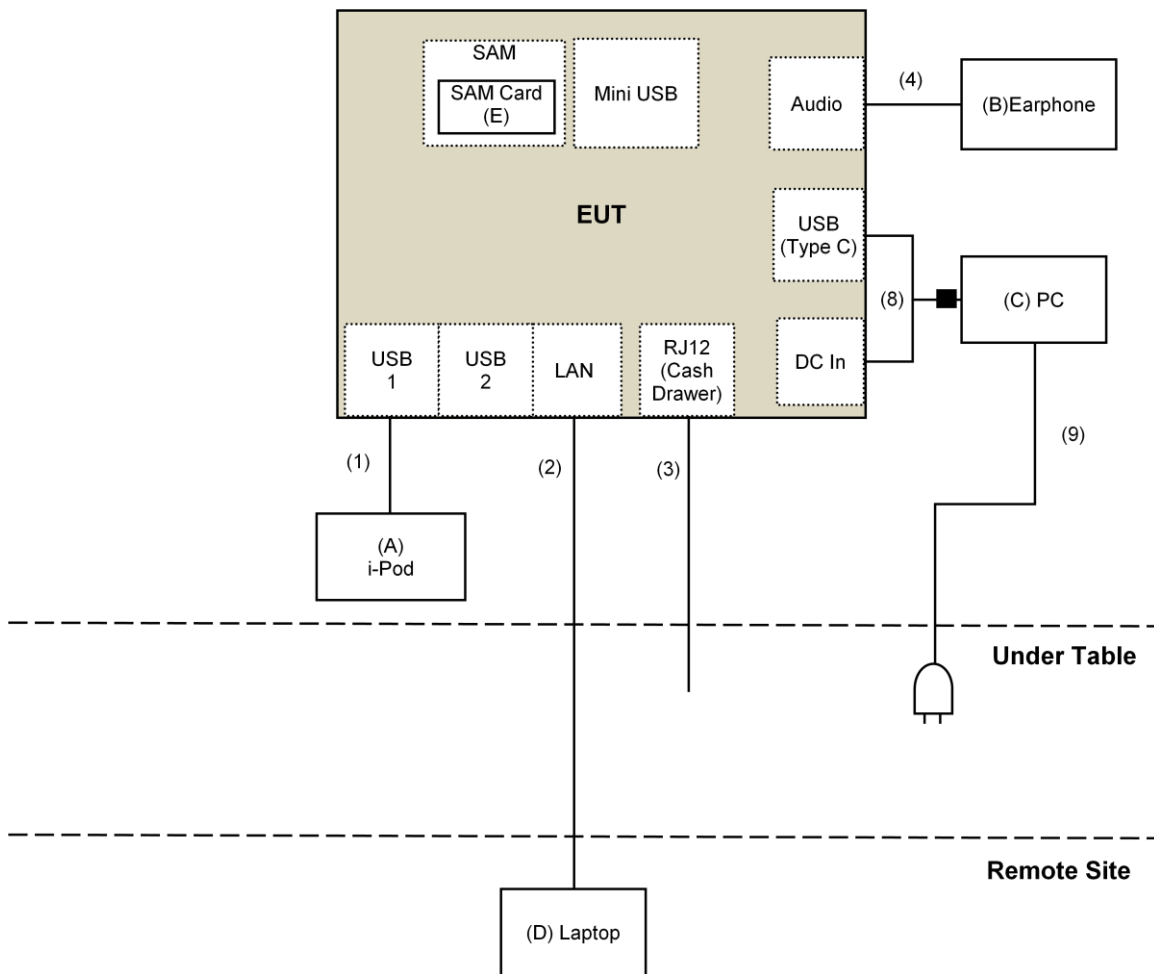

4 Test Types and Results

4.1 Radiated Emission and Bandedge Measurement

4.1.1 Limits of Radiated Emission and Bandedge Measurement

Radiated emissions which fall in the restricted bands must comply with the radiated emission limits specified as below table.

Frequencies (MHz)	Field Strength (microvolts/meter)	Measurement Distance (meters)
0.009 ~ 0.490	2400/F(kHz)	300
0.490 ~ 1.705	24000/F(kHz)	30
1.705 ~ 30.0	30	30
30 ~ 88	100	3
88 ~ 216	150	3
216 ~ 960	200	3
Above 960	500	3

NOTE:

- The lower limit shall apply at the transition frequencies.
- Emission level (dBuV/m) = 20 log Emission level (uV/m).
- For frequencies above 1000MHz, the field strength limits are based on average detector, however, the peak field strength of any emission shall not exceed the maximum permitted average limits, specified above by more than 20dB under any condition of modulation.

Limits of unwanted emission out of the restricted bands

Applicable To		Limit	
789033 D02 General UNII Test Procedure New Rules v01r04		Field Strength at 3m	
		PK:74 (dBμV/m)	AV:54 (dBμV/m)
Frequency Band	Applicable To	EIRP Limit	Equivalent Field Strength at 3m
5150~5250 MHz	15.407(b)(1)	PK:-27 (dBm/MHz)	PK:68.2(dBμV/m)
5250~5350 MHz	15.407(b)(2)		
5470~5725 MHz	15.407(b)(3)		
5725~5850 MHz	<input checked="" type="checkbox"/> 15.407(b)(4)(i)	PK:-27 (dBm/MHz) ^{*1} PK:10 (dBm/MHz) ^{*2} PK:15.6 (dBm/MHz) ^{*3} PK:27 (dBm/MHz) ^{*4}	PK: 68.2(dBμV/m) ^{*1} PK:105.2 (dBμV/m) ^{*2} PK: 110.8(dBμV/m) ^{*3} PK:122.2 (dBμV/m) ^{*4}
	<input type="checkbox"/> 15.407(b)(4)(ii)	Emission limits in section 15.247(d)	
^{*1} beyond 75 MHz or more above of the band edge.		^{*2} below the band edge increasing linearly to 10 dBm/MHz at 25 MHz above.	
^{*3} below the band edge increasing linearly to a level of 15.6 dBm/MHz at 5 MHz above.		^{*4} from 5 MHz above or below the band edge increasing linearly to a level of 27 dBm/MHz at the band edge.	

Note:

The following formula is used to convert the equipment isotropic radiated power (eirp) to field strength:

$$E = \frac{1000000\sqrt{30P}}{3} \mu\text{V/m, where P is the eirp (Watts).}$$

4.1.2 Test Instruments

DESCRIPTION & MANUFACTURER	MODEL NO.	SERIAL NO.	CALIBRATED DATE	CALIBRATED UNTIL
Test Receiver Keysight	N9038A	MY54450088	July 20, 2016	July 19, 2017
Pre-Amplifier ^(*) EMCI	EMC001340	980142	Jan. 20, 2016	Jan. 19, 2018
Loop Antenna ^(*) Electro-Metrics	EM-6879	264	Dec. 16, 2016	Dec. 15, 2018
RF Cable	NA	LOOPCAB-001 LOOPCAB-002	Jan. 17, 2017	Jan. 16, 2018
Pre-Amplifier Mini-Circuits	ZFL-1000VH2B	AMP-ZFL-01	Nov. 10, 2016	Nov. 09, 2017
Trilog Broadband Antenna SCHWARZBECK	VULB 9168	9168-406	Dec. 13, 2016	Dec. 12, 2017
RF Cable	8D	966-4-1 966-4-2 966-4-3	Apr. 01, 2017	Mar. 31, 2018
Fixed attenuator Mini-Circuits	UNAT-5+	PAD-3m-4-01	Oct. 05, 2016	Oct. 04, 2017
Horn Antenna SCHWARZBECK	BBHA 9120D	9120D-783	Dec. 27, 2016	Dec. 26, 2017
Pre-Amplifier EMCI	EMC12630SE	980385	Feb. 02, 2017	Feb. 01, 2018
RF Cable	EMC104-SM-SM-1200 EMC104-SM-SM-2000 EMC104-SM-SM-5000	160923 150318 150323	Feb. 02, 2017 Mar. 29, 2017 Mar. 29, 2017	Feb. 01, 2018 Mar. 28, 2018 Mar. 28, 2018
Pre-Amplifier EMCI	EMC184045SE	980387	Feb. 02, 2017	Feb. 01, 2018
Horn Antenna SCHWARZBECK	BBHA 9170	BBHA9170608	Dec. 15, 2016	Dec. 14, 2017
RF Cable	SUCOFLEX 102	36432/2 36433/2	Jan. 15, 2017	Jan. 14, 2018
Software	ADT_Radiated_V8.7.08	NA	NA	NA
Antenna Tower & Turn Table Max-Full	MF-7802	MF780208410	NA	NA
Boresight Antenna Fixture	FBA-01	FBA-SIP02	NA	NA
Spectrum Analyzer R&S	FSv40	100964	June 28, 2016	June 27, 2017
Spectrum Analyzer Agilent	E4446A	MY48250253	Dec. 21, 2016	Dec. 20, 2017
Power meter Anritsu	ML2495A	0824006	May 26, 2016	May 25, 2017
Power sensor Anritsu	MA2411B	0738172	May 26, 2016	May 25, 2017

Note:

1. The calibration interval of the above test instruments is 12 months and the calibrations are traceable to NML/ROC and NIST/USA.
2. *The calibration interval of the above test instruments is 24 months and the calibrations are traceable to NML/ROC and NIST/USA.
3. The test was performed in 966 Chamber No. 4.
4. The FCC Site Registration No. is 292998
5. The CANADA Site Registration No. is 20331-2
6. Tested Date: Apr. 18 to May 16, 2017

4.1.3 Test Procedures

For Radiated emission below 30MHz

- a. The EUT was placed on the top of a rotating table 0.8 meters above the ground at a 3 meter chamber room. The table was rotated 360 degrees to determine the position of the highest radiation.
- b. The EUT was set 3 meters away from the interference-receiving antenna, which was mounted on the top of a variable-height antenna tower.
- c. Both X and Y axes of the antenna are set to make the measurement.
- d. For each suspected emission, the EUT was arranged to its worst case and the rotatable table was turned from 0 degrees to 360 degrees to find the maximum reading.
- e. The test-receiver system was set to Quasi-Peak Detect Function and Specified Bandwidth with Maximum Hold Mode.

NOTE:

1. The resolution bandwidth and video bandwidth of test receiver/spectrum analyzer is 9kHz at frequency below 30MHz.

For Radiated emission above 30MHz

- a. The EUT was placed on the top of a rotating table 0.8 meters (for 30MHz ~ 1GHz) / 1.5 meters (for above 1GHz) above the ground at 3 meter chamber room for test. The table was rotated 360 degrees to determine the position of the highest radiation.
- b. The EUT was set 3 meters away from the interference-receiving antenna, which was mounted on the top of a variable-height antenna tower.
- c. The height of antenna is varied from one meter to four meters above the ground to determine the maximum value of the field strength. Both horizontal and vertical polarizations of the antenna are set to make the measurement.
- d. For each suspected emission, the EUT was arranged to its worst case and then the antenna was tuned to heights from 1 meter to 4 meters and the rotatable table was turned from 0 degrees to 360 degrees to find the maximum reading.
- e. The test-receiver system was set to quasi-peak detect function and specified bandwidth with maximum hold mode when the test frequency is below 1 GHz.
- f. The test-receiver system was set to peak and average detect function and specified bandwidth with maximum hold mode when the test frequency is above 1 GHz. If the peak reading value also meets average limit, measurement with the average detector is unnecessary.

Note:

1. The resolution bandwidth and video bandwidth of test receiver/spectrum analyzer is 120kHz for Quasi-peak detection (QP) at frequency below 1GHz.
2. The resolution bandwidth of test receiver/spectrum analyzer is 1 MHz and the video bandwidth is 3 MHz for Peak detection (PK) at frequency above 1GHz.
3. The resolution bandwidth of test receiver/spectrum analyzer is 1MHz and the video bandwidth is $\geq 1/T$ (Duty cycle < 98%) or 10Hz (Duty cycle $\geq 98\%$) for Average detection (AV) at frequency above 1GHz.
4. All modes of operation were investigated and the worst-case emissions are reported.

4.1.4 Deviation from Test Standard

No deviation.

4.1.5 Test Setup

For Radiated emission below 30MHz

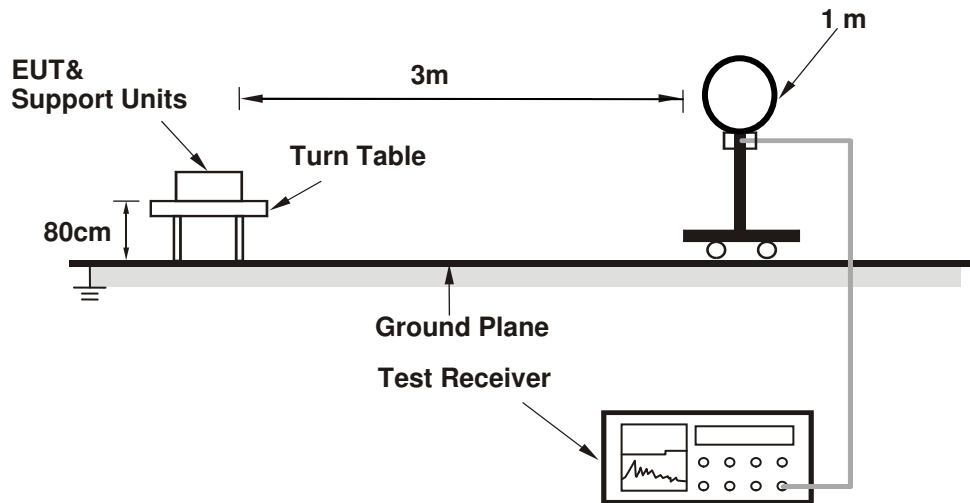

For Radiated emission 30MHz to 1GHz

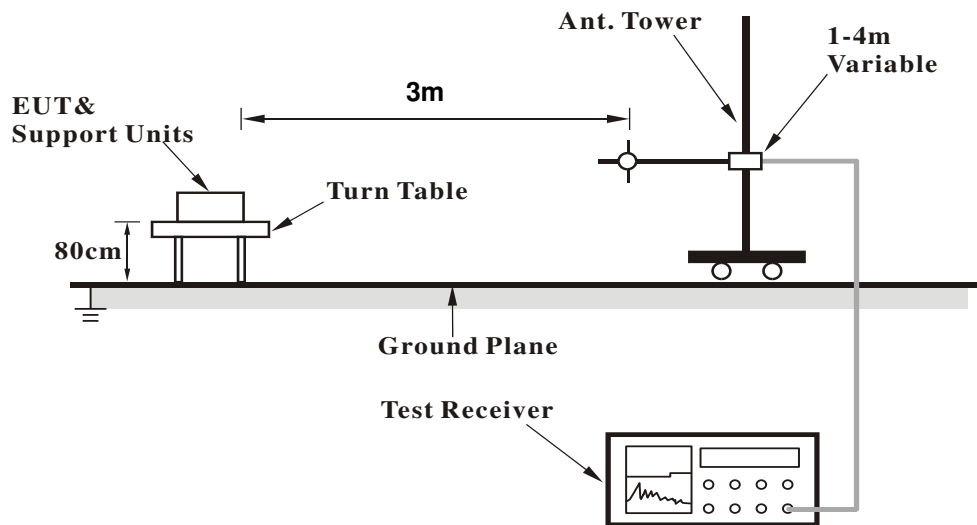

For Radiated emission above 1GHz

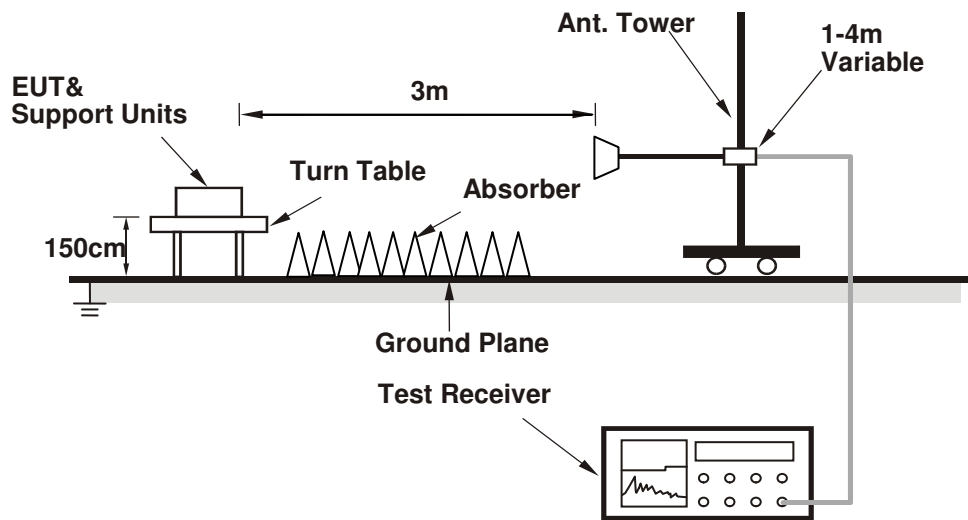

For the actual test configuration, please refer to the attached file (Test Setup Photo).

4.1.6 EUT Operating Conditions

- a. Connected the EUT with the Laptop which is placed on remote site.
- b. Controlling software (QRCT.exe[Ver3.0.187.0]) has been activated to set the EUT on specific status.

4.1.7 Test Results (Mode 1)

Above 1GHz Data

FREQUENCY RANGE	1GHz ~ 25GHz	DETECTOR FUNCTION	Peak (PK) Average (AV)
------------------------	--------------	--------------------------	---------------------------

ANTENNA POLARITY & TEST DISTANCE: HORIZONTAL AT 3 M

NO.	FREQ. (MHz)	EMISSION LEVEL (dBuV/m)	LIMIT (dBuV/m)	MARGIN (dB)	ANTENNA HEIGHT (m)	TABLE ANGLE (Degree)	RAW VALUE (dBuV)	CORRECTION FACTOR (dB/m)
1	4824.00	45.7 PK	74.0	-28.3	2.86 H	107	42.5	3.2
2	4824.00	41.9 AV	54.0	-12.1	2.86 H	107	38.7	3.2
3	4882.00	41.7 PK	74.0	-32.3	1.53 H	360	38.3	3.4
4	4882.00	11.6 AV	54.0	-42.4	1.53 H	360	8.2	3.4
5	7323.00	45.3 PK	74.0	-28.7	1.50 H	129	35.5	9.8
6	7323.00	15.2 AV	54.0	-38.8	1.50 H	129	5.4	9.8

ANTENNA POLARITY & TEST DISTANCE: VERTICAL AT 3 M

NO.	FREQ. (MHz)	EMISSION LEVEL (dBuV/m)	LIMIT (dBuV/m)	MARGIN (dB)	ANTENNA HEIGHT (m)	TABLE ANGLE (Degree)	RAW VALUE (dBuV)	CORRECTION FACTOR (dB/m)
1	4824.00	43.7 PK	74.0	-30.3	1.41 V	182	40.5	3.2
2	4824.00	36.5 AV	54.0	-17.5	1.41 V	182	33.3	3.2
3	4882.00	39.8 PK	74.0	-34.2	1.44 V	153	36.4	3.4
4	4882.00	9.7 AV	54.0	-44.3	1.44 V	153	6.3	3.4
5	7323.00	44.6 PK	74.0	-29.4	1.56 V	206	34.8	9.8
6	7323.00	14.5 AV	54.0	-39.5	1.56 V	206	4.7	9.8

REMARKS:

1. Emission Level(dBuV/m) = Raw Value(dBuV) + Correction Factor(dB/m)
2. Correction Factor(dB/m) = Antenna Factor(dB/m) + Cable Factor(dB) – Pre-Amplifier Factor(dB)
3. The other emission levels were very low against the limit.
4. Margin value = Emission Level – Limit value

Below 1GHz Data:

FREQUENCY RANGE	9kHz ~ 1GHz	DETECTOR FUNCTION	Quasi-Peak (QP)
------------------------	-------------	--------------------------	-----------------

ANTENNA POLARITY & TEST DISTANCE: HORIZONTAL AT 3 M

NO.	FREQ. (MHz)	EMISSION LEVEL (dBuV/m)	LIMIT (dBuV/m)	MARGIN (dB)	ANTENNA HEIGHT (m)	TABLE ANGLE (Degree)	RAW VALUE (dBuV)	CORRECTION FACTOR (dB/m)
1	135.61	33.1 QP	43.5	-10.4	2.00 H	105	41.8	-8.7
2	162.74	39.3 QP	43.5	-4.2	2.00 H	220	47.2	-7.9
3	176.30	35.3 QP	43.5	-8.2	1.50 H	267	44.3	-9.0
4	203.75	41.4 QP	43.5	-2.1	1.00 H	320	52.8	-11.4
5	488.20	38.6 QP	46.0	-7.4	1.50 H	22	41.7	-3.1
6	515.32	33.8 QP	46.0	-12.2	1.50 H	229	36.1	-2.3

ANTENNA POLARITY & TEST DISTANCE: VERTICAL AT 3 M

NO.	FREQ. (MHz)	EMISSION LEVEL (dBuV/m)	LIMIT (dBuV/m)	MARGIN (dB)	ANTENNA HEIGHT (m)	TABLE ANGLE (Degree)	RAW VALUE (dBuV)	CORRECTION FACTOR (dB/m)
1	44.11	26.6 QP	40.0	-13.4	1.00 V	103	34.3	-7.7
2	162.74	31.1 QP	43.5	-12.4	1.50 V	360	39.0	-7.9
3	176.30	31.9 QP	43.5	-11.6	1.00 V	126	40.9	-9.0
4	203.75	35.6 QP	43.5	-7.9	2.00 V	360	47.0	-11.4
5	488.20	39.1 QP	46.0	-6.9	1.00 V	200	42.2	-3.1
6	515.32	32.5 QP	46.0	-13.5	1.00 V	74	34.8	-2.3

REMARKS:

1. Emission Level(dBuV/m) = Raw Value(dBuV) + Correction Factor(dB/m)
2. Correction Factor(dB/m) = Antenna Factor(dB/m) + Cable Factor(dB) – Pre-Amplifier Factor(dB)
3. The other emission levels were very low against the limit.
4. Margin value = Emission Level – Limit value

4.1.8 Test Results (Mode 2)

Above 1GHz Data

FREQUENCY RANGE	1GHz ~ 40GHz	DETECTOR FUNCTION	Peak (PK) Average (AV)
------------------------	--------------	--------------------------	---------------------------

ANTENNA POLARITY & TEST DISTANCE: HORIZONTAL AT 3 M

NO.	FREQ. (MHz)	EMISSION LEVEL (dBuV/m)	LIMIT (dBuV/m)	MARGIN (dB)	ANTENNA HEIGHT (m)	TABLE ANGLE (Degree)	RAW VALUE (dBuV)	CORRECTION FACTOR (dB/m)
1	4882.00	41.8 PK	74.0	-32.2	1.49 H	360	38.4	3.4
2	4882.00	11.7 AV	54.0	-42.3	1.49 H	360	8.3	3.4
3	7323.00	45.6 PK	74.0	-28.4	1.55 H	118	35.8	9.8
4	7323.00	15.5 AV	54.0	-38.5	1.55 H	118	5.7	9.8
5	11340.00	47.6 PK	74.0	-26.4	1.32 H	273	33.2	14.4
6	11340.00	35.1 AV	54.0	-18.9	1.32 H	273	20.7	14.4
7	#17010.00	46.0 PK	74.0	-28.0	1.15 H	356	27.8	18.2
8	#17010.00	34.8 AV	54.0	-19.2	1.15 H	356	16.6	18.2

ANTENNA POLARITY & TEST DISTANCE: VERTICAL AT 3 M

NO.	FREQ. (MHz)	EMISSION LEVEL (dBuV/m)	LIMIT (dBuV/m)	MARGIN (dB)	ANTENNA HEIGHT (m)	TABLE ANGLE (Degree)	RAW VALUE (dBuV)	CORRECTION FACTOR (dB/m)
1	4882.00	39.1 PK	74.0	-34.9	1.45 V	168	35.7	3.4
2	4882.00	9.0 AV	54.0	-45.0	1.45 V	168	5.6	3.4
3	7323.00	44.9 PK	74.0	-29.1	1.54 V	222	35.1	9.8
4	7323.00	14.8 AV	54.0	-39.2	1.54 V	222	5.0	9.8
5	11340.00	48.1 PK	74.0	-25.9	1.62 V	317	33.7	14.4
6	11340.00	35.6 AV	54.0	-18.4	1.62 V	317	21.2	14.4
7	#17010.00	46.9 PK	74.0	-27.1	2.00 V	139	28.7	18.2
8	#17010.00	35.4 AV	54.0	-18.6	2.00 V	139	17.2	18.2

REMARKS:

1. Emission Level(dBuV/m) = Raw Value(dBuV) + Correction Factor(dB/m)
2. Correction Factor(dB/m) = Antenna Factor(dB/m) + Cable Factor(dB) – Pre-Amplifier Factor(dB)
3. The other emission levels were very low against the limit.
4. Margin value = Emission Level – Limit value

Below 1GHz Data:

FREQUENCY RANGE	9kHz ~ 1GHz	DETECTOR FUNCTION	Quasi-Peak (QP)
------------------------	-------------	--------------------------	-----------------

ANTENNA POLARITY & TEST DISTANCE: HORIZONTAL AT 3 M

NO.	FREQ. (MHz)	EMISSION LEVEL (dBuV/m)	LIMIT (dBuV/m)	MARGIN (dB)	ANTENNA HEIGHT (m)	TABLE ANGLE (Degree)	RAW VALUE (dBuV)	CORRECTION FACTOR (dB/m)
1	135.61	32.8 QP	43.5	-10.7	2.50 H	124	41.5	-8.7
2	162.74	39.2 QP	43.5	-4.3	2.00 H	228	47.1	-7.9
3	176.30	35.6 QP	43.5	-7.9	1.50 H	252	44.6	-9.0
4	203.75	41.4 QP	43.5	-2.1	1.00 H	311	52.8	-11.4
5	488.18	39.2 QP	46.0	-6.8	2.00 H	360	42.3	-3.1
6	611.20	32.9 QP	46.0	-13.1	1.00 H	155	33.1	-0.2

ANTENNA POLARITY & TEST DISTANCE: VERTICAL AT 3 M

NO.	FREQ. (MHz)	EMISSION LEVEL (dBuV/m)	LIMIT (dBuV/m)	MARGIN (dB)	ANTENNA HEIGHT (m)	TABLE ANGLE (Degree)	RAW VALUE (dBuV)	CORRECTION FACTOR (dB/m)
1	135.63	28.6 QP	43.5	-14.9	1.00 V	221	37.3	-8.7
2	162.74	29.8 QP	43.5	-13.7	2.50 V	308	37.7	-7.9
3	176.30	31.5 QP	43.5	-12.0	1.00 V	129	40.5	-9.0
4	203.75	35.8 QP	43.5	-7.7	2.00 V	360	47.2	-11.4
5	488.20	39.1 QP	46.0	-6.9	1.00 V	196	42.2	-3.1
6	611.20	32.2 QP	46.0	-13.8	1.50 V	104	32.4	-0.2

REMARKS:

1. Emission Level(dBuV/m) = Raw Value(dBuV) + Correction Factor(dB/m)
2. Correction Factor(dB/m) = Antenna Factor(dB/m) + Cable Factor(dB) – Pre-Amplifier Factor(dB)
3. The other emission levels were very low against the limit.
4. Margin value = Emission Level – Limit value

4.2 Conducted Emission Measurement

4.2.1 Limits of Conducted Emission Measurement

Frequency (MHz)	Conducted Limit (dBuV)	
	Quasi-peak	Average
0.15 - 0.5	66 - 56	56 - 46
0.50 - 5.0	56	46
5.0 - 30.0	60	50

Note: 1. The lower limit shall apply at the transition frequencies.

2. The limit decreases in line with the logarithm of the frequency in the range of 0.15 to 0.50MHz.

4.2.2 Test Instruments

DESCRIPTION & MANUFACTURER	MODEL NO.	SERIAL NO.	CALIBRATED DATE	CALIBRATED UNTIL
Test Receiver R&S	ESCS 30	847124/029	Oct. 24, 2016	Oct. 23, 2017
Line-Impedance Stabilization Network (for EUT) R&S	ESH3-Z5	848773/004	Oct. 26, 2016	Oct. 25, 2017
RF Cable	5D-FB	COCCAB-001	Sep. 30, 2016	Sep. 29, 2017
10 dB PAD Mini-Circuits	HAT-10+	CONATT-004	June 20, 2016	June 19, 2017
Software BVADT	BVADT_Cond_ V7.3.7.4	NA	NA	NA

Note:

1. The calibration interval of the above test instruments are 12 months and the calibrations are traceable to NML/ROC and NIST/USA.
2. The test was performed in Shielded Room No. 1.
3. Tested Date: May 17, 2017

4.2.3 Test Procedures

- The EUT was placed 0.4 meters from the conducting wall of the shielded room with EUT being connected to the power mains through a line impedance stabilization network (LISN). Other support units were connected to the power mains through another LISN. The two LISNs provide 50 ohm/ 50uH of coupling impedance for the measuring instrument.
- Both lines of the power mains connected to the EUT were checked for maximum conducted interference.
- The frequency range from 150kHz to 30MHz was searched. Emission levels under (Limit - 20dB) was not recorded.

NOTE: The resolution bandwidth and video bandwidth of test receiver is 9kHz for quasi-peak detection (QP) and average detection (AV) at frequency 0.15MHz-30MHz.

4.2.4 Deviation from Test Standard

No deviation.

4.2.5 Test Setup

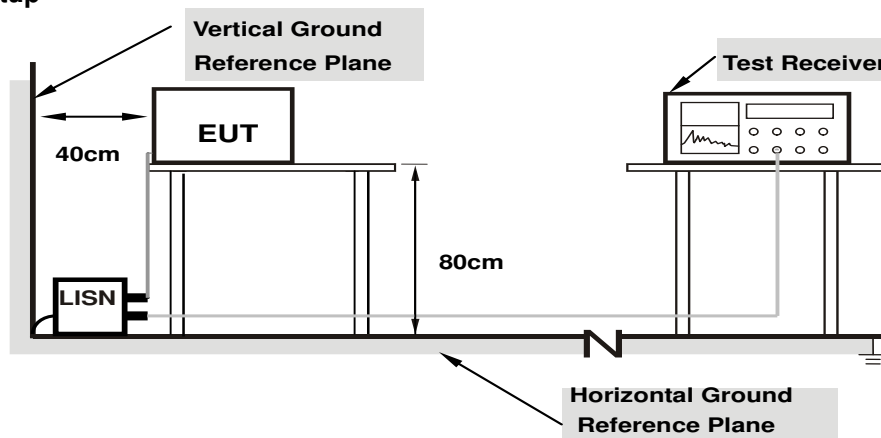

Note: 1.Support units were connected to second LISN.

For the actual test configuration, please refer to the attached file (Test Setup Photo).

4.2.6 EUT Operating Conditions

Same as 4.1.6.

4.2.7 Test Results (Mode 1)

Phase	Line (L)	Detector Function	Quasi-Peak (QP) / Average (AV)
-------	----------	-------------------	--------------------------------

Phase Of Power : Line (L)										
No	Frequency (MHz)	Correction Factor (dB)	Reading Value (dBuV)		Emission Level (dBuV)		Limit (dBuV)		Margin (dB)	
			Q.P.	AV.	Q.P.	AV.	Q.P.	AV.	Q.P.	AV.
1	0.15000	10.19	40.41	23.37	50.60	33.56	66.00	56.00	-15.40	-22.44
2	0.20078	10.19	31.60	14.87	41.79	25.06	63.58	53.58	-21.79	-28.52
3	0.39609	10.22	22.31	11.91	32.53	22.13	57.93	47.93	-25.40	-25.80
4	0.95469	10.26	7.35	1.46	17.61	11.72	56.00	46.00	-38.39	-34.28
5	5.50000	10.32	13.83	8.05	24.15	18.37	60.00	50.00	-35.85	-31.63
6	27.72656	11.45	7.68	4.08	19.13	15.53	60.00	50.00	-40.87	-34.47

Remarks:

1. Q.P. and AV. are abbreviations of quasi-peak and average individually.
2. The emission levels of other frequencies were very low against the limit.
3. Margin value = Emission level – Limit value
4. Correction factor = Insertion loss + Cable loss
5. Emission Level = Correction Factor + Reading Value

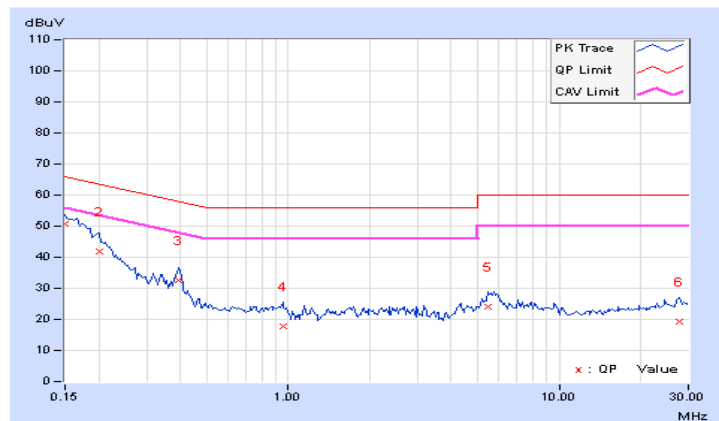

Phase	Neutral (N)	Detector Function	Quasi-Peak (QP) / Average (AV)
-------	-------------	-------------------	--------------------------------

Phase Of Power : Neutral (N)										
No	Frequency (MHz)	Correction Factor (dB)	Reading Value (dBuV)		Emission Level (dBuV)		Limit (dBuV)		Margin (dB)	
			Q.P.	AV.	Q.P.	AV.	Q.P.	AV.	Q.P.	AV.
1	0.15000	10.18	40.50	23.17	50.68	33.35	66.00	56.00	-15.32	-22.65
2	0.17734	10.17	35.31	18.61	45.48	28.78	64.61	54.61	-19.13	-25.83
3	0.39219	10.21	21.59	11.35	31.80	21.56	58.02	48.02	-26.22	-26.46
4	0.77500	10.22	5.73	2.87	15.95	13.09	56.00	46.00	-40.05	-32.91
5	4.37109	10.18	10.43	3.89	20.61	14.07	56.00	46.00	-35.39	-31.93
6	27.53125	11.06	8.65	4.35	19.71	15.41	60.00	50.00	-40.29	-34.59

Remarks:

1. Q.P. and AV. are abbreviations of quasi-peak and average individually.
2. The emission levels of other frequencies were very low against the limit.
3. Margin value = Emission level – Limit value
4. Correction factor = Insertion loss + Cable loss
5. Emission Level = Correction Factor + Reading Value

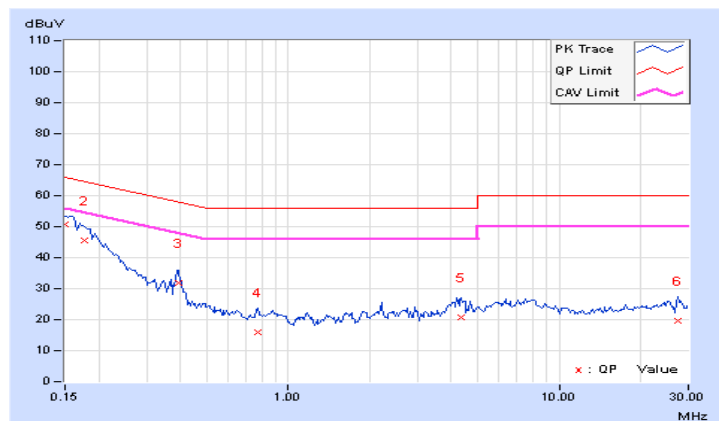

4.2.8 Test Results (Mode 2)

Phase	Line (L)	Detector Function	Quasi-Peak (QP) / Average (AV)
-------	----------	-------------------	--------------------------------

Phase Of Power : Line (L)										
No	Frequency (MHz)	Correction Factor (dB)	Reading Value (dBUV)		Emission Level (dBUV)		Limit (dBUV)		Margin (dB)	
			Q.P.	AV.	Q.P.	AV.	Q.P.	AV.	Q.P.	AV.
1	0.15000	10.19	40.47	23.23	50.66	33.42	66.00	56.00	-15.34	-22.58
2	0.18125	10.19	34.75	15.93	44.94	26.12	64.43	54.43	-19.49	-28.31
3	0.23594	10.20	25.70	9.24	35.90	19.44	62.24	52.24	-26.34	-32.80
4	0.40000	10.22	20.62	9.52	30.84	19.74	57.85	47.85	-27.01	-28.11
5	5.96484	10.34	13.99	8.49	24.33	18.83	60.00	50.00	-35.67	-31.17
6	27.95703	11.45	6.75	3.73	18.20	15.18	60.00	50.00	-41.80	-34.82

Remarks:

1. Q.P. and AV. are abbreviations of quasi-peak and average individually.
2. The emission levels of other frequencies were very low against the limit.
3. Margin value = Emission level – Limit value
4. Correction factor = Insertion loss + Cable loss
5. Emission Level = Correction Factor + Reading Value

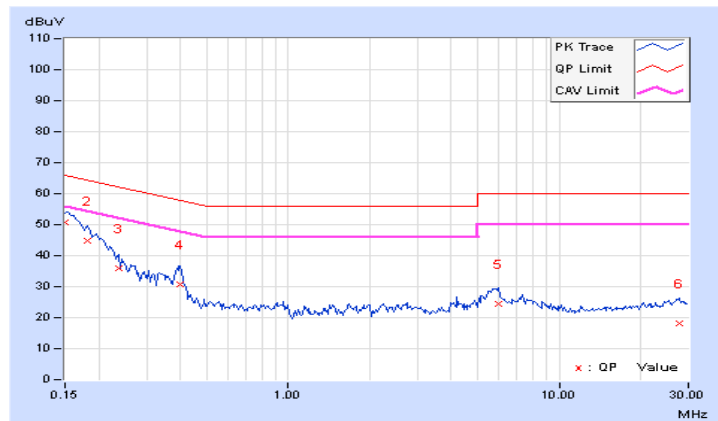

Phase	Neutral (N)	Detector Function	Quasi-Peak (QP) / Average (AV)
-------	-------------	-------------------	--------------------------------

Phase Of Power : Neutral (N)										
No	Frequency (MHz)	Correction Factor (dB)	Reading Value (dBuV)		Emission Level (dBuV)		Limit (dBuV)		Margin (dB)	
			Q.P.	AV.	Q.P.	AV.	Q.P.	AV.	Q.P.	AV.
1	0.15000	10.18	40.37	23.35	50.55	33.53	66.00	56.00	-15.45	-22.47
2	0.16953	10.17	36.27	19.65	46.44	29.82	64.98	54.98	-18.54	-25.16
3	0.21250	10.16	29.22	11.12	39.38	21.28	63.11	53.11	-23.73	-31.83
4	0.39219	10.21	21.71	11.37	31.92	21.58	58.02	48.02	-26.10	-26.44
5	7.42188	10.35	9.32	5.33	19.67	15.68	60.00	50.00	-40.33	-34.32
6	27.87500	11.06	7.34	1.20	18.40	12.26	60.00	50.00	-41.60	-37.74

Remarks:

1. Q.P. and AV. are abbreviations of quasi-peak and average individually.
2. The emission levels of other frequencies were very low against the limit.
3. Margin value = Emission level – Limit value
4. Correction factor = Insertion loss + Cable loss
5. Emission Level = Correction Factor + Reading Value

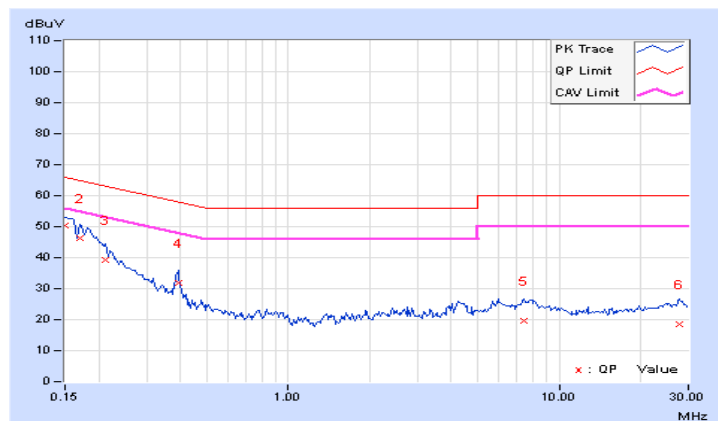

4.2.9 Test Results (Mode 3)

Phase	Line (L)	Detector Function	Quasi-Peak (QP) / Average (AV)
-------	----------	-------------------	--------------------------------

Phase Of Power : Line (L)										
No	Frequency (MHz)	Correction Factor (dB)	Reading Value (dBuV)		Emission Level (dBuV)		Limit (dBuV)		Margin (dB)	
			Q.P.	AV.	Q.P.	AV.	Q.P.	AV.	Q.P.	AV.
1	0.15000	10.19	43.91	20.52	54.10	30.71	66.00	56.00	-11.90	-25.29
2	0.17238	10.19	43.25	38.58	53.44	48.77	64.84	54.84	-11.40	-6.07
3	0.25762	10.20	34.56	23.63	44.76	33.83	61.51	51.51	-16.75	-17.68
4	0.29606	10.20	34.59	25.88	44.79	36.08	60.35	50.35	-15.56	-14.27
5	0.71250	10.24	28.77	23.03	39.01	33.27	56.00	46.00	-16.99	-12.73
6	30.00000	11.47	31.28	25.39	42.75	36.86	60.00	50.00	-17.25	-13.14

Remarks:

1. Q.P. and AV. are abbreviations of quasi-peak and average individually.
2. The emission levels of other frequencies were very low against the limit.
3. Margin value = Emission level – Limit value
4. Correction factor = Insertion loss + Cable loss
5. Emission Level = Correction Factor + Reading Value

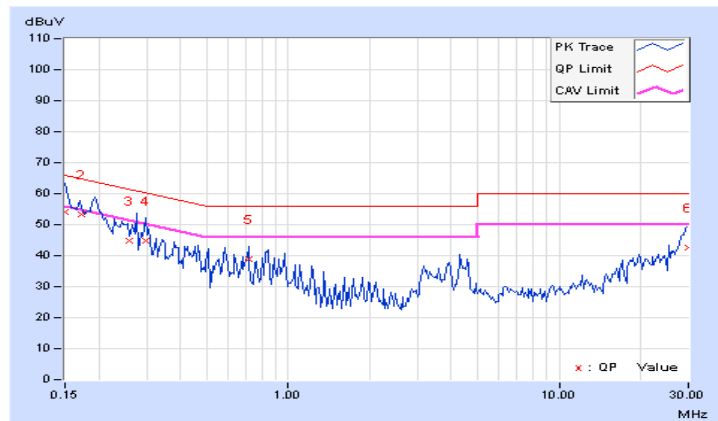

Phase	Neutral (N)	Detector Function	Quasi-Peak (QP) / Average (AV)
-------	-------------	-------------------	--------------------------------

Phase Of Power : Neutral (N)										
No	Frequency (MHz)	Correction Factor (dB)	Reading Value (dBuV)		Emission Level (dBuV)		Limit (dBuV)		Margin (dB)	
			Q.P.	AV.	Q.P.	AV.	Q.P.	AV.	Q.P.	AV.
1	0.15000	10.18	44.07	21.13	54.25	31.31	66.00	56.00	-11.75	-24.69
2	0.17175	10.17	44.46	40.04	54.63	50.21	64.88	54.88	-10.25	-4.67
3	0.19687	10.16	41.22	34.32	51.38	44.48	63.74	53.74	-12.36	-9.26
4	0.29844	10.18	34.01	26.34	44.19	36.52	60.29	50.29	-16.10	-13.77
5	0.97031	10.23	29.51	23.76	39.74	33.99	56.00	46.00	-16.26	-12.01
6	29.27344	11.05	33.81	27.34	44.86	38.39	60.00	50.00	-15.14	-11.61

Remarks:

1. Q.P. and AV. are abbreviations of quasi-peak and average individually.
2. The emission levels of other frequencies were very low against the limit.
3. Margin value = Emission level – Limit value
4. Correction factor = Insertion loss + Cable loss
5. Emission Level = Correction Factor + Reading Value

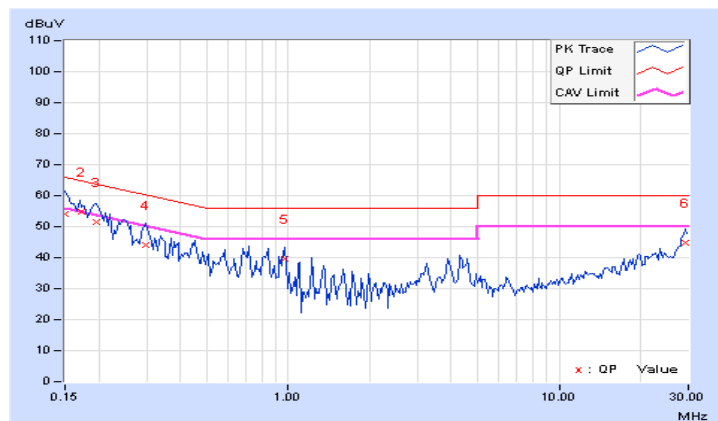

4.2.10 Test Results (Mode 4)

Phase	Line (L)	Detector Function	Quasi-Peak (QP) / Average (AV)
-------	----------	-------------------	--------------------------------

Phase Of Power : Line (L)										
No	Frequency (MHz)	Correction Factor (dB)	Reading Value (dBuV)		Emission Level (dBuV)		Limit (dBuV)		Margin (dB)	
			Q.P.	AV.	Q.P.	AV.	Q.P.	AV.	Q.P.	AV.
1	0.15000	10.19	43.97	21.01	54.16	31.20	66.00	56.00	-11.84	-24.80
2	0.16950	10.19	45.02	40.49	55.21	50.68	64.98	54.98	-9.77	-4.30
3	0.19687	10.19	43.34	38.15	53.53	48.34	63.74	53.74	-10.21	-5.40
4	0.29453	10.20	34.21	24.76	44.41	34.96	60.40	50.40	-15.99	-15.44
5	0.71250	10.24	28.54	22.77	38.78	33.01	56.00	46.00	-17.22	-12.99
6	29.86328	11.47	33.07	26.13	44.54	37.60	60.00	50.00	-15.46	-12.40

Remarks:

1. Q.P. and AV. are abbreviations of quasi-peak and average individually.
2. The emission levels of other frequencies were very low against the limit.
3. Margin value = Emission level – Limit value
4. Correction factor = Insertion loss + Cable loss
5. Emission Level = Correction Factor + Reading Value

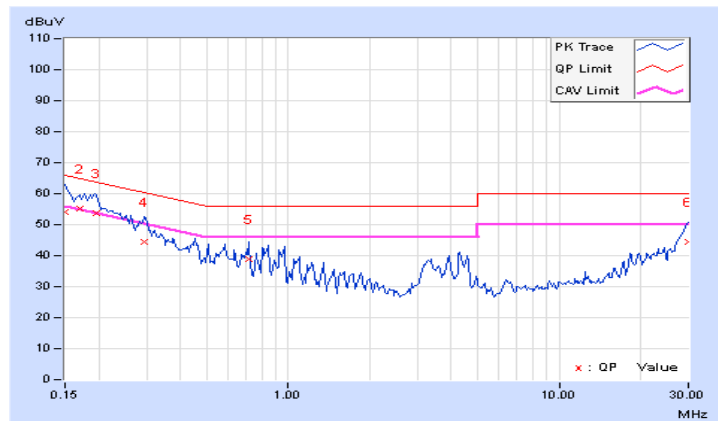

Phase	Neutral (N)	Detector Function	Quasi-Peak (QP) / Average (AV)
-------	-------------	-------------------	--------------------------------

Phase Of Power : Neutral (N)										
No	Frequency (MHz)	Correction Factor (dB)	Reading Value (dBuV)		Emission Level (dBuV)		Limit (dBuV)		Margin (dB)	
			Q.P.	AV.	Q.P.	AV.	Q.P.	AV.	Q.P.	AV.
1	0.15000	10.18	44.39	21.56	54.57	31.74	66.00	56.00	-11.43	-24.26
2	0.16912	10.17	45.53	40.98	55.70	51.15	65.00	55.00	-9.30	-3.85
3	0.19297	10.16	42.71	37.55	52.87	47.71	63.91	53.91	-11.04	-6.20
4	0.23203	10.17	34.15	10.96	44.32	21.13	62.38	52.38	-18.06	-31.25
5	4.60938	10.19	27.34	24.98	37.53	35.17	56.00	46.00	-18.47	-10.83
6	29.17969	11.05	31.84	26.44	42.89	37.49	60.00	50.00	-17.11	-12.51

Remarks:

1. Q.P. and AV. are abbreviations of quasi-peak and average individually.
2. The emission levels of other frequencies were very low against the limit.
3. Margin value = Emission level – Limit value
4. Correction factor = Insertion loss + Cable loss
5. Emission Level = Correction Factor + Reading Value

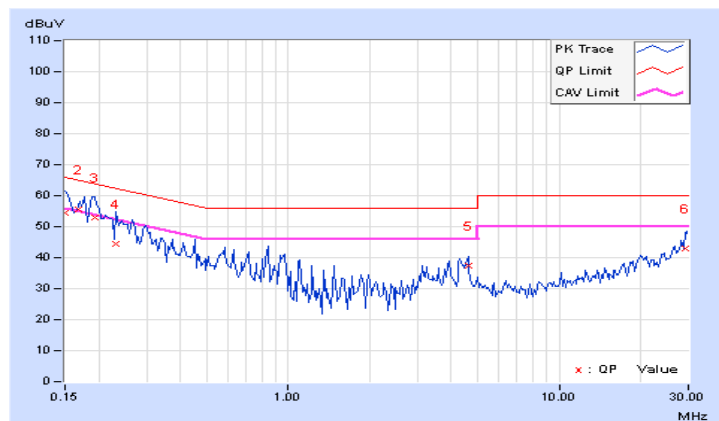

4.3 Conducted Out of Band Emission Measurement

4.3.1 Limits of Conducted Out of Band Emission Measurement

Below 20dB of the highest emission level of operating band (in 100kHz Resolution Bandwidth).

4.3.2 Test Setup

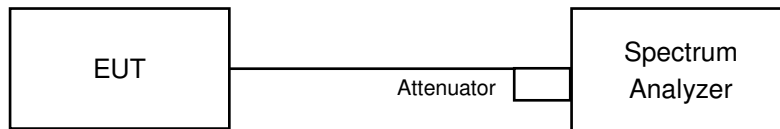

4.3.3 Test Instruments

Refer to section 4.1.2 to get information of above instrument.

4.3.4 Test Procedures

MEASUREMENT PROCEDURE REF

1. Set the RBW = 100 kHz.
2. Set the VBW \geq 300 kHz.
3. Detector = peak.
4. Sweep time = auto couple.
5. Trace mode = max hold.
6. Allow trace to fully stabilize.
7. Use the peak marker function to determine the maximum power level in any 100 kHz band segment within the fundamental EBW.

MEASUREMENT PROCEDURE OOBE

1. Set RBW = 100 kHz.
2. Set VBW \geq 300 kHz.
3. Detector = peak.
4. Sweep = auto couple.
5. Trace Mode = max hold.
6. Allow trace to fully stabilize.
7. Use the peak marker function to determine the maximum amplitude level.

4.3.5 Deviation from Test Standard

No deviation.

4.3.6 EUT Operating Conditions

The software provided by client to enable the EUT under transmission condition continuously at lowest, middle and highest channel frequencies individually.

4.3.7 Test Results

The spectrum plots are attached on the following pages. D1 line indicates the highest level, and D2 line indicates the 20dB offset below D1. It shows compliance with the requirement.

802.11b CH1 + Buletooth 8DPSK CH39

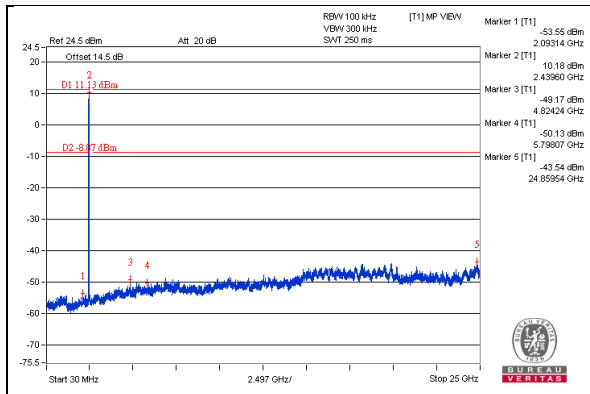

802.11n (HT40) CH134 + Buletooth 8DPSK CH39

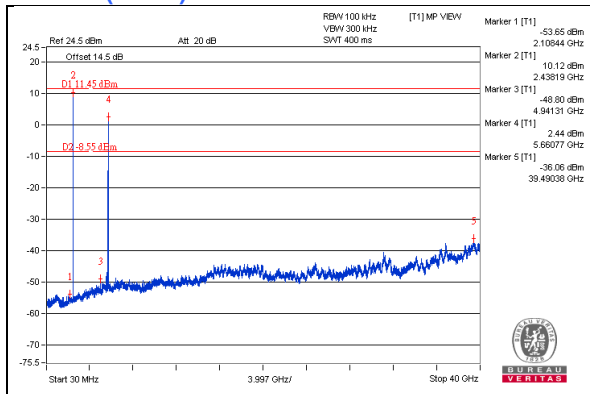

5 Pictures of Test Arrangements

Please refer to the attached file (Test Setup Photo).

Appendix – Information on the Testing Laboratories

We, Bureau Veritas Consumer Products Services (H.K.) Ltd., Taoyuan Branch, were founded in 1988 to provide our best service in EMC, Radio, Telecom and Safety consultation. Our laboratories are accredited and approved according to ISO/IEC 17025.

If you have any comments, please feel free to contact us at the following:

Linko EMC/RF Lab

Tel: 886-2-26052180

Fax: 886-2-26051924

Hsin Chu EMC/RF/Telecom Lab

Tel: 886-3-6668565

Fax: 886-3-6668323

Hwa Ya EMC/RF/Safety Lab

Tel: 886-3-3183232

Fax: 886-3-3270892

Email: service.adt@tw.bureauveritas.com

Web Site: www.bureauveritas-adt.com

The address and road map of all our labs can be found in our web site also.

--- END ---