



Test report No. : 4789969990-US-R2-V0  
Page : 1 of 23  
Issued date : 2021/7/30  
FCC ID : MQT-AT170R18W

## DFS TEST REPORT

**Product** : Terminal

**Model Name** : xCL\_AT-170-R-18W

**Series Model** : Utimaco C3

**FCC ID** : MQT-AT170R18W

**Test Regulation** : FCC 47 CFR Part 15 Subpart E (Section 15.407)

**Received Date** : 2021/6/2

**Test Date** : 2021/6/18 ~ 2021/6/25

**Issued Date** : 2021/7/30

**Applicant** : XAC Automation Corporation  
4F., No. 30 Industry E. Road IX, Science-Based Industrial  
Park Hsin-Chu, 300, Taiwan, ROC

**Issued By** : Underwriters Laboratories Taiwan Co., Ltd.  
Building B and Building E, No. 372-7, Sec. 4, Zhongxing  
Rd., Zhudong Township, Hsinchu County, Taiwan



The results reported herein have been performed in accordance with the laboratory's terms of accreditation. This report shall not be reproduced except in full without the written approval of the Laboratory. The results in this report apply to the test sample(s) mentioned above at the time of the testing period only and are not to be used to indicate applicability to other similar products.

### **Underwriters Laboratories Taiwan Co., Ltd.**

Building B and Building E, No. 372-7, Sec. 4, Zhongxing Rd., Zhudong Township, Hsinchu County, Taiwan  
Telephone : +886-2-7737-3000  
Facsimile (FAX) : +886-3-583-7948

Doc No: 17-EM-F0886 / 5.0





## Table of Contents

<b>1.</b>	<b>Attestation of Test Results.....</b>	<b>4</b>
<b>2.</b>	<b>Test Methodology and Reference Procedures .....</b>	<b>5</b>
<b>3.</b>	<b>Facilities and Accreditation .....</b>	<b>5</b>
<b>4.</b>	<b>Equipment under Test.....</b>	<b>6</b>
4.1	Description of EUT.....	6
4.2	EUT Software and Firmware Version .....	8
4.3	Support Equipment .....	8
4.4	Description of Available Antennas .....	8
4.5	EUT Maximum Conducted Power.....	9
4.6	EUT Maximum E.I.R.P. Power .....	10
4.7	Test Condition.....	10
<b>5.</b>	<b>Test Equipment.....</b>	<b>11</b>
<b>6.</b>	<b>Test Result .....</b>	<b>12</b>
6.1	Transmit Power Control (TPC).....	12
6.2	Dynamic Frequency Selection (DFS) .....	13
6.2.1	<i>Applicability of DFS Requirements .....</i>	<i>13</i>
6.2.2	<i>DFS Detection Thresholds and Response Requirement .....</i>	<i>14</i>
6.2.3	<i>Radar Test Waveforms.....</i>	<i>15</i>
6.2.4	<i>Channel Loading / Data Streaming.....</i>	<i>17</i>
6.2.5	<i>Test Setup.....</i>	<i>18</i>
6.2.6	<i>Test Result .....</i>	<i>19</i>

### Underwriters Laboratories Taiwan Co., Ltd.

Building B and Building E, No. 372-7, Sec. 4, Zhongxing Rd., Zhudong Township, Hsinchu County, Taiwan  
Telephone :+886-2-7737-3000  
Facsimile (FAX) :+886-3-583-7948



## 1. Attestation of Test Results

**APPLICANT:** XAC Automation Corporation  
 4F., No. 30 Industry E. Road IX, Science-Based Industrial Park  
 Hsin-Chu, 300, Taiwan, ROC

**MANUFACTURER:** XAC Automation Corporation  
 4F., No. 30 Industry E. Road IX, Science-Based Industrial  
 Park Hsin-Chu, 300, Taiwan, ROC

**EUT DESCRIPTION:** Terminal

**BRAND:** XAC, Utimaco

**MODEL:** xCL\_AT-170-R-18W

**SERIES MODEL:** Utimaco C3

**SAMPLE STAGE:** Engineering Verification Test sample

**DATE of TESTED:** 2021/6/18 ~ 2021/6/25

APPLICABLE STANDARDS	
STANDARD	Test Results
FCC 47 CFR PART 15 Subpart E (Section 15.407)	PASS

Underwriters Laboratories Taiwan Co., Ltd. tested the above equipment in accordance with the requirements set forth in the above standards. All indications of Pass/Fail in this report are opinions expressed by Underwriters Laboratories Taiwan Co., Ltd. based on interpretations and/or observations of test results. The test results show that the equipment tested is capable of demonstrating compliance with the requirements as documented in this report.

**Note:** The results documented in this report apply only to the tested sample, under the conditions and modes of operation as described herein. This document may not be altered or revised in any way unless done so by Underwriters Laboratories Taiwan Co., Ltd. and all revisions are duly noted in the revisions section. Any alteration of this document not carried out by Underwriters Laboratories Taiwan Co., Ltd. will constitute fraud and shall nullify the document. This report must not be used by the client to claim product certification, approval, or endorsement by NVLAP, NIST, any agency of the Federal Government, or any agency of any government.

Prepared By:

Sally Lu  
Project Handler

Date : 2021/7/30

Approved and Authorized By:

Mike Cai  
Engineer Project Associate

Date : 2021/7/30

### Underwriters Laboratories Taiwan Co., Ltd.

Building B and Building E, No. 372-7, Sec. 4, Zhongxing Rd., Zhudong Township, Hsinchu County, Taiwan  
 Telephone : +886-2-7737-3000  
 Facsimile (FAX) : +886-3-583-7948



## 2. Test Methodology and Reference Procedures

The tests documented in this report were performed in accordance with KDB 905462 D02 UNII DFS Compliance Procedures New Rules v02, FCC KDB 905462 D06 802 11 Channel Plans v02, KDB 905462 D03 UNII Clients Without Radar Detection New Rules v01r02.

## 3. Facilities and Accreditation

<b>Test Location</b>	Underwriters Laboratories Taiwan Co., Ltd.
<b>Address</b>	Building B and Building E, No. 372-7, Sec. 4, Zhongxing Rd., Zhudong Township, Hsinchu County, Taiwan
<b>Accreditation Certificate</b>	Underwriters Laboratories Taiwan Co., Ltd. is accredited by TAF, Laboratory Code 3398. The full scope of accreditation can be viewed at <a href="http://accreditation.taftw.org.tw/taf/public/basic/viewApplyItems.action?unitNo=3398">http://accreditation.taftw.org.tw/taf/public/basic/viewApplyItems.action?unitNo=3398</a>

### Underwriters Laboratories Taiwan Co., Ltd.

Building B and Building E, No. 372-7, Sec. 4, Zhongxing Rd., Zhudong Township, Hsinchu County, Taiwan  
Telephone : +886-2-7737-3000  
Facsimile (FAX) : +886-3-583-7948



## 4. Equipment under Test

### 4.1 Description of EUT

<b>Product</b>	Terminal
<b>Brand Name</b>	XAC, Utimaco
<b>Model Name</b>	xCL_AT-170-R-18W
<b>Series Model</b>	Utimaco C3
<b>Normal Voltage</b>	5Vdc from adapter or host 3.8Vdc from battery
<b>S/N</b>	Conducted Test: 1740D2103 Radiated Test: 1740D2107
<b>Sample ID</b>	Conducted Test: 3949576 Radiated Test: 3949578
<b>Software Version</b>	Android Version: 8.1.0 Kernel Version: 3.18.71 (gcc version 4.8(GCC))
<b>Operating Frequency Range</b>	5250~5350MHz 5470~5725MHz
<b>Operational Mode</b>	<input type="checkbox"/> Client with radar detection <input checked="" type="checkbox"/> Client without radar detection
<b>TPC Function</b>	<input type="checkbox"/> with TPC <input checked="" type="checkbox"/> without TPC
<b>Weather Band</b>	<input checked="" type="checkbox"/> with 5600 ~ 5650MHz <input type="checkbox"/> without 5600 ~ 5650MHz

### Underwriters Laboratories Taiwan Co., Ltd.

Building B and Building E, No. 372-7, Sec. 4, Zhongxing Rd., Zhudong Township, Hsinchu County, Taiwan  
Telephone :+886-2-7737-3000  
Facsimile (FAX) :+886-3-583-7948



Note:

1. The models difference table as below:

<b>Main Model Name</b>		
Brand	Model	Difference
XAC	xCL_AT-170-R-18W	-
<b>Series Model Name</b>		
Brand	Model	Difference
Utimaco	Utimaco C3	For market segmentation

2. The EUT could be supplied with rechargeable battery as the following table:

<b>Brand Name</b>	<b>Model</b>	<b>Description</b>
Shenzhen Rishengzhi Electronics Technology Co., Ltd.	J601	3.8Vdc, 5200mAh

3. The above EUT information is declared by manufacturer and for more detailed features description, please refer the manufacturer's or user's manual.

**Underwriters Laboratories Taiwan Co., Ltd.**

Building B and Building E, No. 372-7, Sec. 4, Zhongxing Rd., Zhudong Township, Hsinchu County, Taiwan  
Telephone :+886-2-7737-3000  
Facsimile (FAX ) :+886-3-583-7948



## 4.2 EUT Software and Firmware Version

Software/Firmware Version
Android Version: 8.1.0 Kernel Version: 3.18.71 (gcc version 4.8(GCC))

## 4.3 Support Equipment

No.	Equipment	Brand Name	Model Name	FCC ID	Remark
1	AC Adapter	MASS POWER	NBS10B050200VUU	N/A	Input:100V-240V, 50/60Hz, 21~33VA 0.3A Output: 5.0V/2.0A
2	USB to Type C Cable	N/A	N/A	N/A	Length: 1.2m
3	Wireless-AX6000 Dual Band Gigabit Router	ASUS	RT-AX88U	MSQ-RTAXHP00	N/A
4	Notebook	Lenovo	T430	PBE38AK	N/A

## 4.4 Description of Available Antennas

Ant. No.	Transmitter Circuit	Brand Name	Model Name	Ant. Type	Maximum Gain (dBi)
1	Chain (0)	AWAN	AYF6P-100000	PIFA	2.4GHz: 1.2 5GHz: 3.71

Note: The above antenna information was provided from customer and for more detailed features description, please refer the manufacturer's specification or user's manual.

### Underwriters Laboratories Taiwan Co., Ltd.

Building B and Building E, No. 372-7, Sec. 4, Zhongxing Rd., Zhudong Township, Hsinchu County, Taiwan  
Telephone :+886-2-7737-3000  
Facsimile (FAX) :+886-3-583-7948





## 4.5 EUT Maximum Conducted Power

### 802.11a

Ant No.	Frequency Band (MHz)	MAX. Power	
		Output Power(dBm)	Output Power(mW)
1	5250~5350	15.60	36.31
1	5470~5725	15.90	38.91

### 802.11n HT20

Ant No.	Frequency Band (MHz)	MAX. Power	
		Output Power(dBm)	Output Power(mW)
1	5250~5350	15.84	38.37
1	5470~5725	15.90	38.91

### 802.11n HT40

Ant No.	Frequency Band (MHz)	MAX. Power	
		Output Power(dBm)	Output Power(mW)
1	5250~5350	16.29	42.56
1	5470~5725	16.41	43.75

## Underwriters Laboratories Taiwan Co., Ltd.

Building B and Building E, No. 372-7, Sec. 4, Zhongxing Rd., Zhudong Township, Hsinchu County, Taiwan  
Telephone :+886-2-7737-3000  
Facsimile (FAX) :+886-3-583-7948



## 4.6 EUT Maximum E.I.R.P. Power

### 802.11a

Ant No.	Frequency Band (MHz)	MAX. Power	
		Output Power(dBm)	Output Power(mW)
1	5250~5350	19.31	85.31
1	5470~5725	19.61	91.41

### 802.11n HT20

Ant No.	Frequency Band (MHz)	MAX. Power	
		Output Power(dBm)	Output Power(mW)
1	5250~5350	19.55	90.16
1	5470~5725	19.61	91.41

### 802.11n HT40

Ant No.	Frequency Band (MHz)	MAX. Power	
		Output Power(dBm)	Output Power(mW)
1	5250~5350	20.00	100.00
1	5470~5725	20.12	102.80

## 4.7 Test Condition

Test Item	Test Site No.	Environmental Condition	Input Power	Test Date	Tested by
DFS	SR4	22~26°C/ 62~68%RH	5Vdc	2021/06/18~ 2021/06/25	Wayne Chen

### Underwriters Laboratories Taiwan Co., Ltd.

Building B and Building E, No. 372-7, Sec. 4, Zhongxing Rd., Zhudong Township, Hsinchu County, Taiwan  
Telephone :+886-2-7737-3000  
Facsimile (FAX) :+886-3-583-7948



## 5. Test Equipment

Test Equipment List					
Equipment	Manufacturer	Model No.	Serial No.	Cal. Date	Expired date
Antenna Port Conducted Measurement					
Spectrum Analyzer	Keysight	N9010A	MY56070834	2020/11/6	2021/11/5
Signal Generator	Keysight	N5182B	MY57300028	2020/11/18	2021/11/17

### UL Software

Software	Test Item	Version
N7607B Signal Studio	DFS Radar Profiles	3.0.0.0
ISMointor10	DFS measurement	10.0.0.0

### Underwriters Laboratories Taiwan Co., Ltd.

Building B and Building E, No. 372-7, Sec. 4, Zhongxing Rd., Zhudong Township, Hsinchu County, Taiwan  
Telephone : +886-2-7737-3000  
Facsimile (FAX) : +886-3-583-7948



## 6. Test Result

### 6.1 Transmit Power Control (TPC)

#### Requirements

U-NII devices operating in the 5.25-5.35 GHz band and the 5.47-5.725 GHz band shall employ a TPC mechanism. The U-NII device is required to have the capability to operate at least 6 dB below the mean EIRP value of 30 dBm. A TPC mechanism is not required for systems with an e.i.r.p. of less than 500 mW.

#### Test Data

Maximum EIRP of this device is 102.8 mW which less than 500 mW, therefore it's not require TPC function.

#### **Underwriters Laboratories Taiwan Co., Ltd.**

Building B and Building E, No. 372-7, Sec. 4, Zhongxing Rd., Zhudong Township, Hsinchu County, Taiwan  
Telephone :+886-2-7737-3000  
Facsimile (FAX ) :+886-3-583-7948



## 6.2 Dynamic Frequency Selection (DFS)

### 6.2.1 Applicability of DFS Requirements

Applicability of DFS Requirements Prior to use of a Channel :

Requirement	Operational Mode		
	Master	Client Without Radar Detection	Client with Radar Detection
Non-Occupancy Period	Yes	Yes <small>note</small>	Yes
DFS Detection Threshold	Yes	Not required	Yes
Channel Availability Check Time	Yes	Not required	Not required
U-NII Detection Bandwidth	Yes	Not required	Yes

Note: Per KDB 905462 D03 UNII Clients Without Radar Detection New Rules v01r02 section (b)(5/6), If the client moves with the master, the device is considered compliant if nothing appears in the client non-occupancy period test. For devices that shut down (rather than moving channels), no beacons should appear. An analyzer plot that contains a single 30-minute sweep on the original channel.

Applicability of DFS Requirements during Normal Operation :

Requirement	Operational Mode	
	Master or Client with Radar Detection	Client Without Radar Detection
DFS Detection Threshold	Yes	Not required
Channel Closing Transmission Time	Yes	Yes
Channel Move Time	Yes	Yes
U-NII Detection Bandwidth	Yes	Not required

Additional requirements for devices with multiple bandwidth modes	Operational Mode	
	Master or Client with Radar Detection	Client Without Radar Detection
U-NII Detection Bandwidth and Statistical Performance Check	All BW modes must be tested	Not required
Channel Move Time and Channel Closing Transmission Time	Test using widest BW mode available	Test using the widest BW mode available for the link
All other tests	Any single BW mode	Not required

Note: Frequencies selected for statistical performance check should include several frequencies within the radar detection bandwidth and frequencies near the edge of the radar detection bandwidth. For 802.11 devices it is suggested to select frequencies in all 20 MHz channel blocks and a null frequencies between the bonded 20 MHz channel blocks.

### Underwriters Laboratories Taiwan Co., Ltd.

Building B and Building E, No. 372-7, Sec. 4, Zhongxing Rd., Zhudong Township, Hsinchu County, Taiwan  
Telephone : +886-2-7737-3000  
Facsimile (FAX) : +886-3-583-7948



## 6.2.2 DFS Detection Thresholds and Response Requirement

Below table provides the DFS Detection Thresholds for Master Devices as well as Client Devices incorporating In-Service Monitoring.

DFS Detection Thresholds for Master Devices and Client Devices With Radar Detection:

Maximum Transmit Power	Value (See Notes 1 , 2 and 3)
EIRP $\geq$ 200 milliwatt	-64 dBm
EIRP < 200 milliwatt and power spectral density < 10 dBm / MHz	-62 dBm
EIRP < 200 milliwatt and that do not meet the power spectral density requirement	-64 dBm
<p>Note 1: This is the level at the input of the receiver assuming a 0 dBi receive antenna.  Note 2: Throughout these test procedures an additional 1 dB has been added to the amplitude of the test transmission waveforms to account for variations in measurement equipment. This will ensure that the test signal is at or above the detection threshold level to trigger a DFS response.  Note3: EIRP is based on the highest antenna gain. For MIMO devices refer to KDB Publication 662911 D01.</p>	

DFS Response Requirement Values :

Parameter	Value
Non-occupancy period	Minimum 30 minutes.
Channel Availability Check Time	60 seconds.
Channel Move Time	10 seconds. (See Note 1.)
Channel Closing Transmission Time	200 milliseconds + an aggregate of 60 milliseconds over remaining 10 second period. (See Notes 1 and 2.)
U-NII Detection Bandwidth	Minimum 100% of the U- NII 99% transmission power bandwidth. (See Note 3.)
<p>Note 1: Channel Move Time and the Channel Closing Transmission Time should be performed with Radar Type 0. The measurement timing begins at the end of the Radar Type 0 burst.  Note 2: The Channel Closing Transmission Time is comprised of 200 milliseconds starting at the beginning of the Channel Move Time plus any additional intermittent control signals required to facilitate a Channel move (an aggregate of 60 milliseconds) during the remainder of the 10 second period. The aggregate duration of control signals will not count quiet periods in between transmissions.  Note 3: During the U-NII Detection Bandwidth detection test, radar type 0 should be used. For each frequency step the minimum percentage of detection is 90 percent. Measurements are performed with no data traffic.</p>	

### Underwriters Laboratories Taiwan Co., Ltd.

Building B and Building E, No. 372-7, Sec. 4, Zhongxing Rd., Zhudong Township, Hsinchu County, Taiwan  
Telephone :+886-2-7737-3000  
Facsimile (FAX ) :+886-3-583-7948



### 6.2.3 Radar Test Waveforms

This section provides the parameters for required test waveforms, minimum percentage of successful detections, and the minimum number of trials that must be used for determining DFS conformance. Step intervals of 0.1 microsecond for Pulse Width, 1 microsecond for PRI, 1 MHz for chirp width and 1 for the number of pulses will be utilized for the random determination of specific test waveforms.

Short Pulse Radar Test Waveforms:

Radar Type	Pulse Width (μsec)	PRI (μsec)	Number of Pulses	Minimum Percentage of Successful Detection	Minimum Number of Trials
0	1	1428	18	See Note1	See Note1
1		Test A: 15 unique PRI values randomly selected from the list of 23 PRI values in Table 5a	Roundup $\left\{ \left( \frac{1}{360} \right) \cdot \left( \frac{19 \cdot 10^6}{\text{PRI}_{\mu\text{sec}}} \right) \right\}$	60%	30
		Test B: 15 unique PRI values randomly selected within the range of 518-3066 μsec, with a minimum increment of 1 μsec, excluding PRI values selected in Test A			
2	1-5	150-230	23-29	60%	30
3	6-10	200-500	16-18	60%	30
4	11-20	200-500	12-16	60%	30
Aggregate (Radar Types 1-4)				80%	120

Note 1: Short Pulse Radar Type 0 should be used for the detection bandwidth test, channel move time, and channel closing time tests.

A minimum of 30 unique waveforms are required for each of the Short Pulse Radar Types 2 through 4. If more than 30 waveforms are used for Short Pulse Radar Types 2 through 4, then each additional waveform must also be unique and not repeated from the previous waveforms. If more than 30 waveforms are used for Short Pulse Radar Type 1, then each additional waveform is generated with Test B and must also be unique and not repeated from the previous waveforms in Tests A or B.

#### Underwriters Laboratories Taiwan Co., Ltd.

Building B and Building E, No. 372-7, Sec. 4, Zhongxing Rd., Zhudong Township, Hsinchu County, Taiwan  
 Telephone :+886-2-7737-3000  
 Facsimile (FAX) :+886-3-583-7948



Long Pulse Radar Test Waveform:

Radar Type	Pulse Width (μsec)	Chirp Width (MHz)	PRI (μsec)	Number of Pulses per Burst	Number of Bursts	Minimum Percentage of Successful Detection	Minimum Number of Trials
5	50-100	5-20	1000-2000	1-3	8-20	80%	30

The parameters for this waveform are randomly chosen. Thirty unique waveforms are required for the Long Pulse Radar Type waveforms. If more than 30 waveforms are used for the Long Pulse Radar Type waveforms, then each additional waveform must also be unique and not repeated from the previous waveforms.

Frequency Hopping Radar Test Waveform:

Radar Type	Pulse Width (μsec)	PRI (μsec)	Pulses per Hop	Hopping Rate (kHz)	Hopping Sequence Length (msec)	Minimum Percentage of Successful Detection	Minimum Number of Trials
6	1	333	9	0.333	300	70%	30

For the Frequency Hopping Radar Type, the same Burst parameters are used for each waveform. The hopping sequence is different for each waveform and a 100-length segment is selected from the hopping sequence defined by the following algorithm: The first frequency in a hopping sequence is selected randomly from the group of 475 integer frequencies from 5250 – 5724 MHz. Next, the frequency that was just chosen is removed from the group and a frequency is randomly selected from the remaining 474 frequencies in the group. This process continues until all 475 frequencies are chosen for the set. For selection of a random frequency, the frequencies remaining within the group are always treated as equally likely

**Underwriters Laboratories Taiwan Co., Ltd.**

Building B and Building E, No. 372-7, Sec. 4, Zhongxing Rd., Zhudong Township, Hsinchu County, Taiwan  
Telephone : +886-2-7737-3000  
Facsimile (FAX) : +886-3-583-7948





## 6.2.4 Channel Loading / Data Streaming

	a) The data file must be of a type that is typical for the device (i.e., MPEG-2, MPEG-4, WAV, MP3, MP4, AVI, etc.) and must generally be transmitting in a streaming mode.
	b) Software to ping the client is permitted to simulate data transfer but must have random ping intervals.
V	c) Timing plots are required with calculations demonstrating a minimum channel loading of approximately 17% or greater.
	d) Unicast or Multicast protocols are preferable but other protocols may be used. The appropriate protocol used must be described in the test procedures.

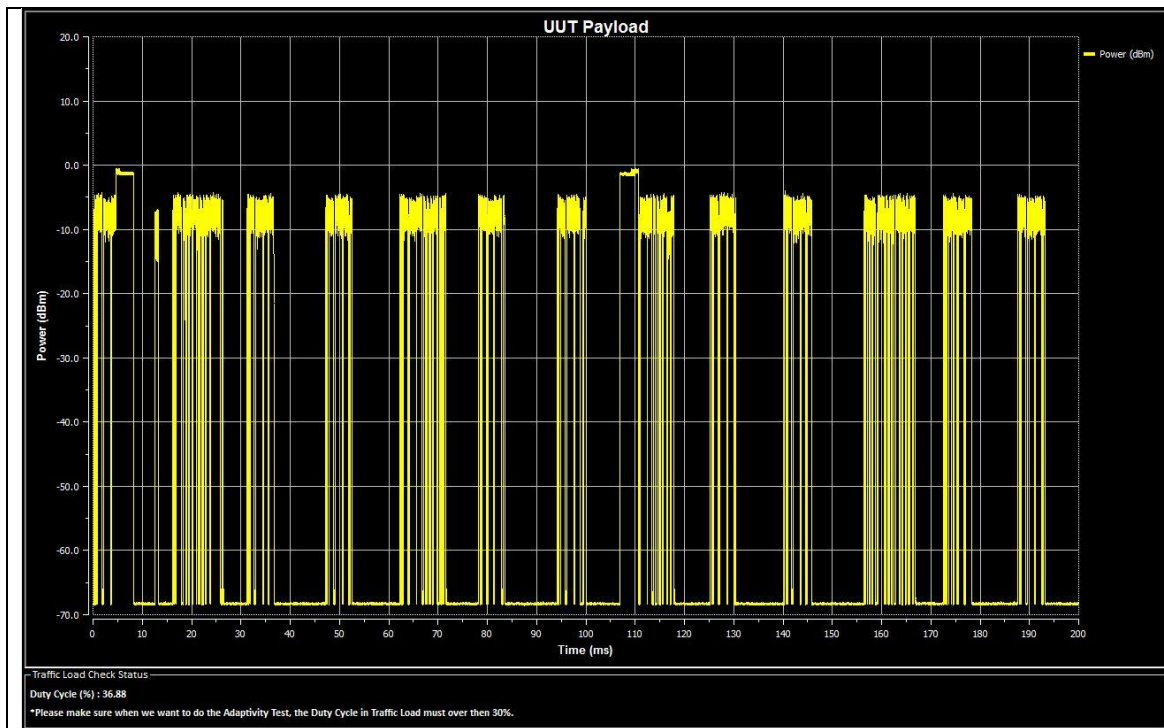

### Underwriters Laboratories Taiwan Co., Ltd.

Building B and Building E, No. 372-7, Sec. 4, Zhongxing Rd., Zhudong Township, Hsinchu County, Taiwan  
Telephone : +886-2-7737-3000  
Facsimile (FAX) : +886-3-583-7948



### 6.2.5 Test Setup

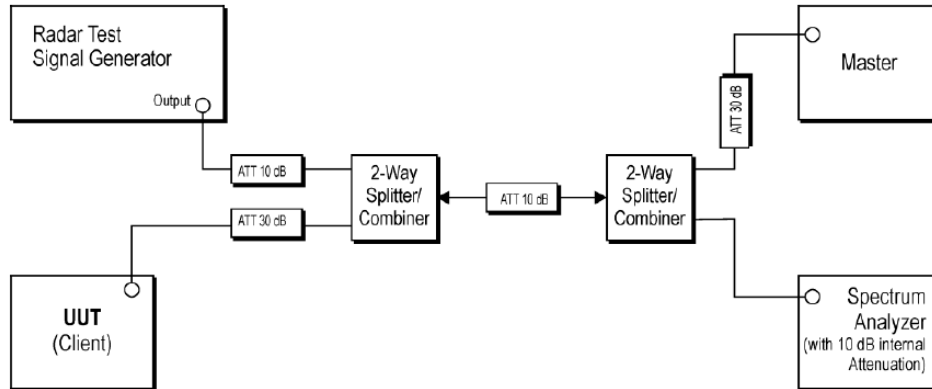

### Underwriters Laboratories Taiwan Co., Ltd.

Building B and Building E, No. 372-7, Sec. 4, Zhongxing Rd., Zhudong Township, Hsinchu County, Taiwan  
Telephone : +886-2-7737-3000  
Facsimile (FAX) : +886-3-583-7948



## 6.2.6 Test Result

### DFS Detection Threshold

For detection threshold level of -64dBm, the required Radar Signal at antenna port was set to -64dBm + Ant Gain (0 dBi) + 1dB = -63 dBm. That had been taken into account the output power range and antenna gain.

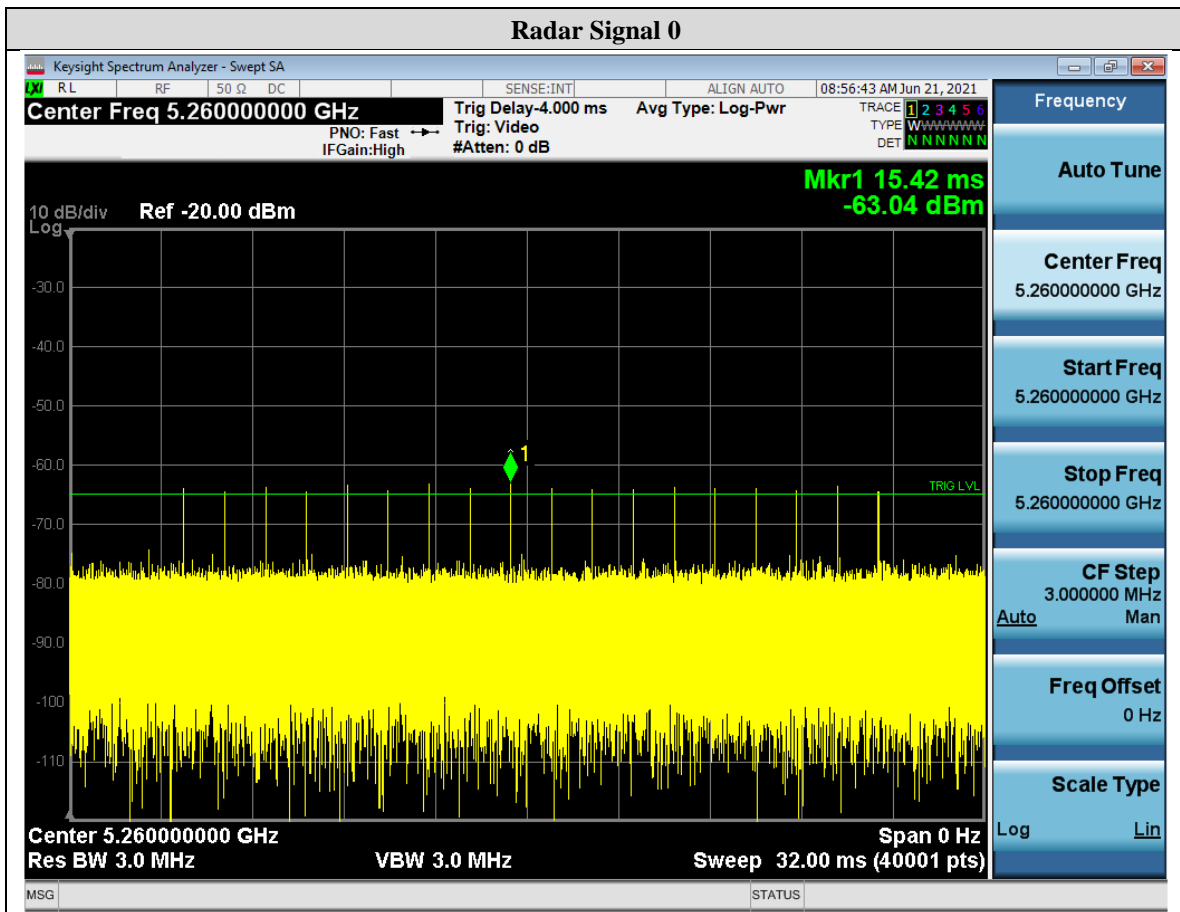

### Underwriters Laboratories Taiwan Co., Ltd.

Building B and Building E, No. 372-7, Sec. 4, Zhongxing Rd., Zhudong Township, Hsinchu County, Taiwan  
Telephone : +886-2-7737-3000  
Facsimile (FAX) : +886-3-583-7948



**Channel Move Time & Channel Closing Transmission Time**

802.11a/802.11n (HT20)

Ch52

Channel Move Time(s)	Limit(s)	Result
0.9	10	PASS
Channel Closing Transmission Time(ms)	Limit(ms)	Result
6.75	60	PASS

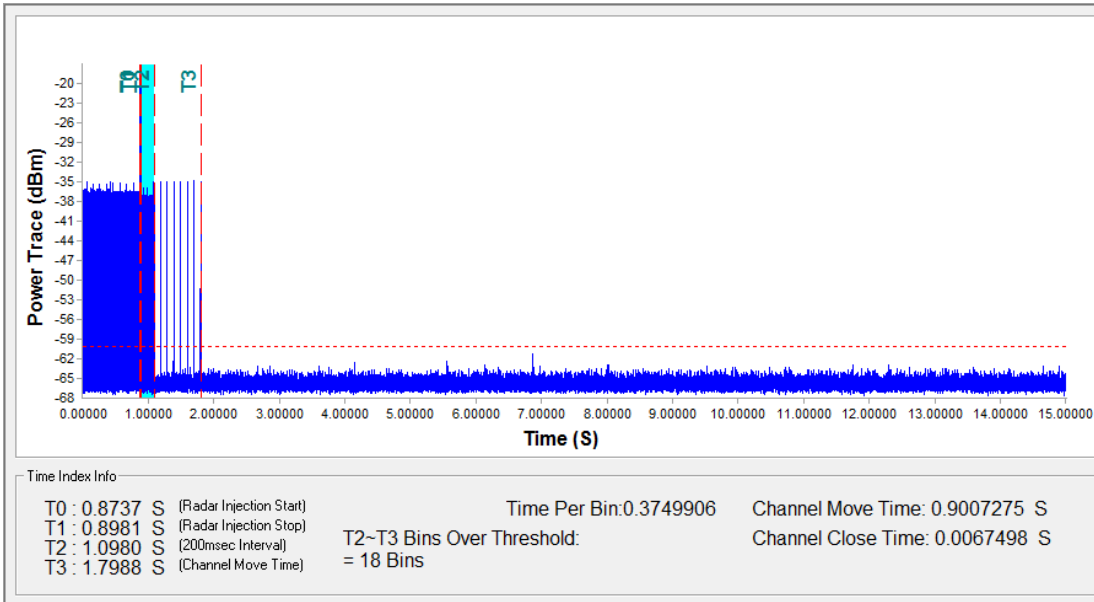

**Underwriters Laboratories Taiwan Co., Ltd.**

Building B and Building E, No. 372-7, Sec. 4, Zhongxing Rd., Zhudong Township, Hsinchu County, Taiwan  
 Telephone : +886-2-7737-3000  
 Facsimile (FAX) : +886-3-583-7948



802.11n (HT40)

Ch54

Channel Move Time(s)	Limit(s)	Result
0.85	10	PASS
Channel Closing Transmission Time(ms)	Limit(ms)	Result
7.87	60	PASS

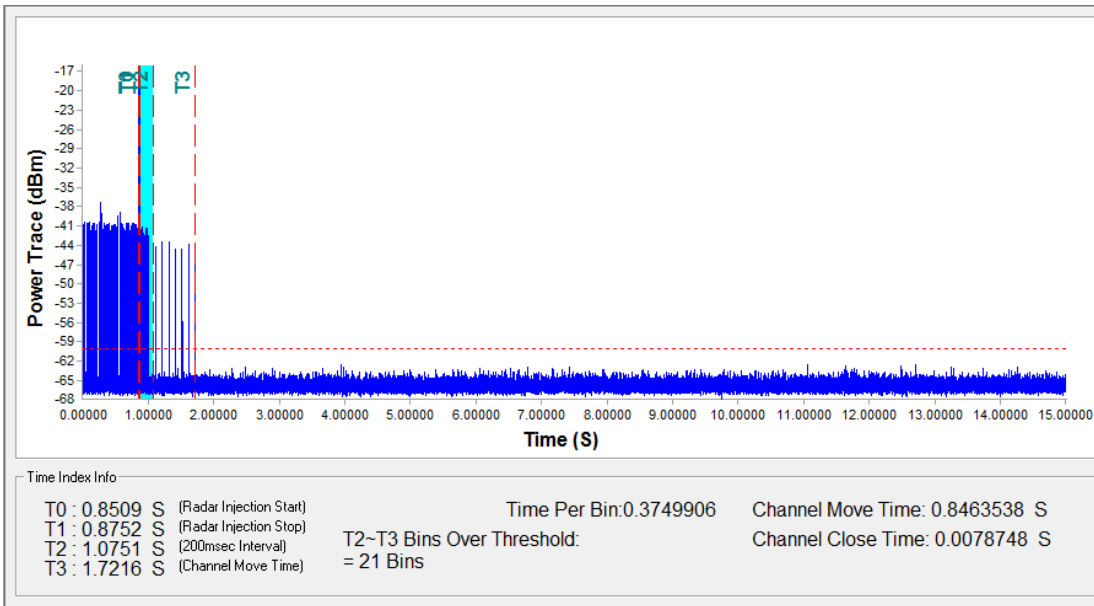

**Underwriters Laboratories Taiwan Co., Ltd.**

Building B and Building E, No. 372-7, Sec. 4, Zhongxing Rd., Zhudong Township, Hsinchu County, Taiwan  
 Telephone :+886-2-7737-3000  
 Facsimile (FAX) :+886-3-583-7948



## Non-Occupancy Period

During the 30 minutes observation time, UUT did not make any transmissions on a channel after a radar signal was detected on that channel by either the Channel Availability Check or the In-Service Monitoring

### 802.11a/802.11n (HT20)

#### Ch52

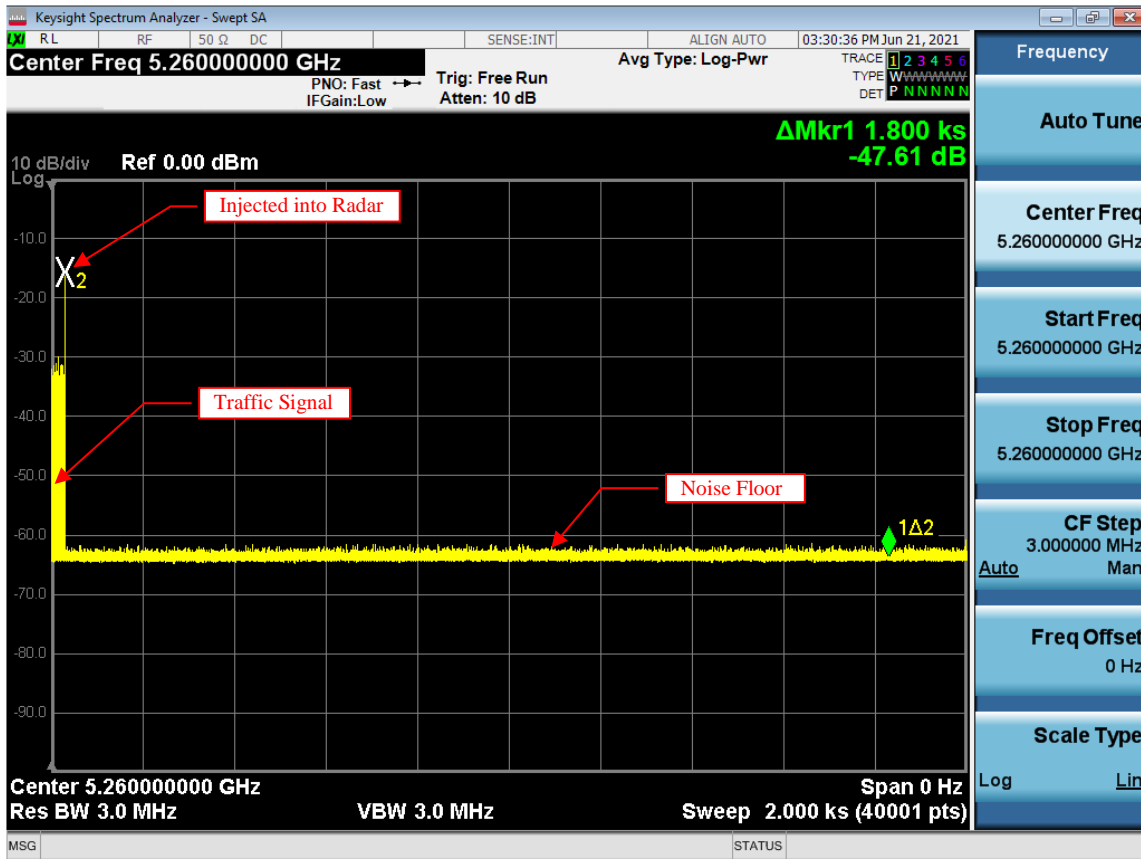

Note:

1. 5260MHz has been monitored in 30 minutes period. In this period, no any transmission occurs.

## Underwriters Laboratories Taiwan Co., Ltd.

Building B and Building E, No. 372-7, Sec. 4, Zhongxing Rd., Zhudong Township, Hsinchu County, Taiwan  
Telephone :+886-2-7737-3000  
Facsimile (FAX) :+886-3-583-7948



## 802.11n (HT40)

### Ch54

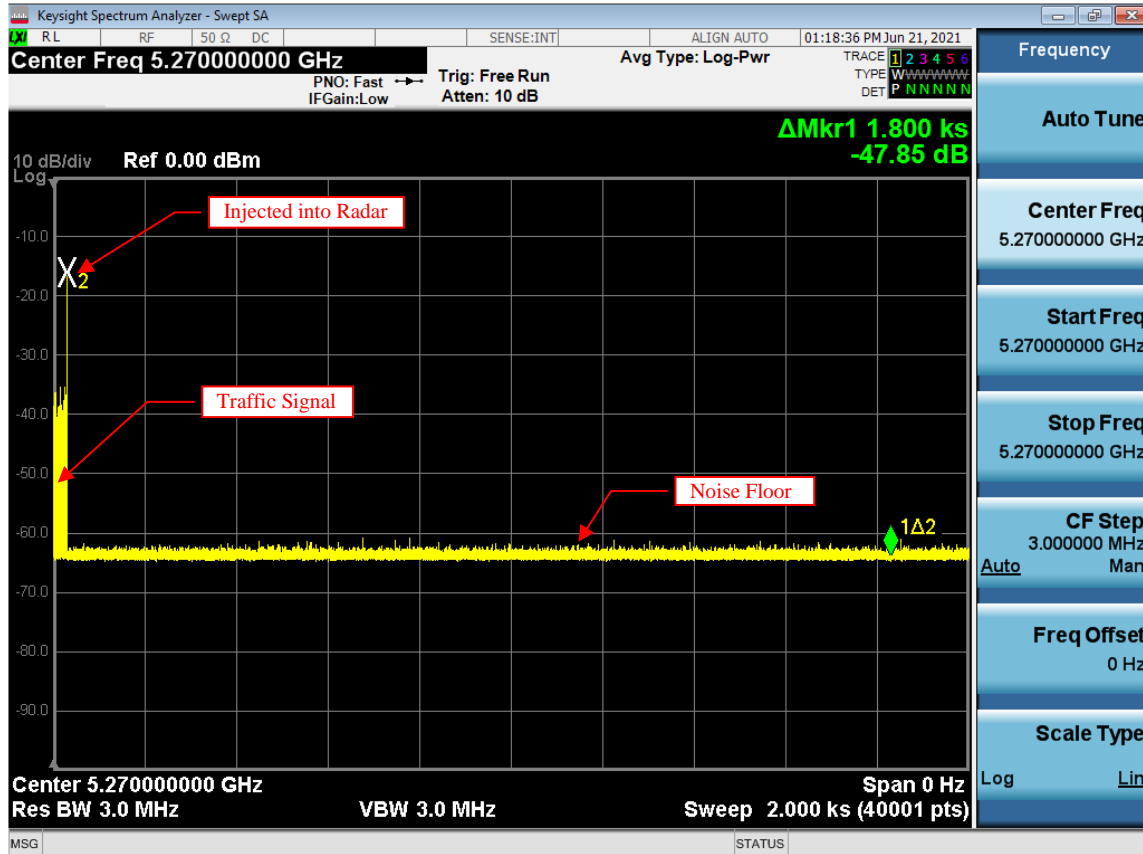

Note:

1. 5270MHz has been monitored in 30 minutes period. In this period, no any transmission occurs.

**END OF REPORT**

**Underwriters Laboratories Taiwan Co., Ltd.**

Building B and Building E, No. 372-7, Sec. 4, Zhongxing Rd., Zhudong Township, Hsinchu County, Taiwan

Telephone :+886-2-7737-3000

Facsimile (FAX ) :+886-3-583-7948

Doc No: 17-EM-F0886 / 5.0