



A Partner You Can Trust

TERMINAL PAYMENT DEVICE

xCL_AT-150 SERIES

INSTALLATION GUIDE

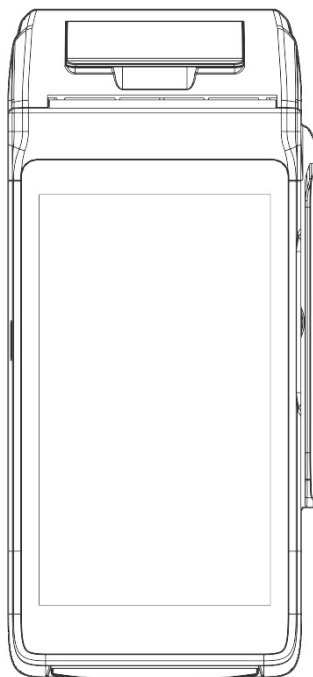

xCL_AT-150 series:

- xCL_AT-150-R3-18U
- xCL_AT-150-R3-18E

1. PACKAGE CONTENT

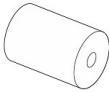
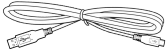

■ AT-150

■ Power adaptor

■ USB cable

■ Paper Roll

2. DEVICE OVERVIEW

Device Overview (Figure 1):

FRONT

REAR

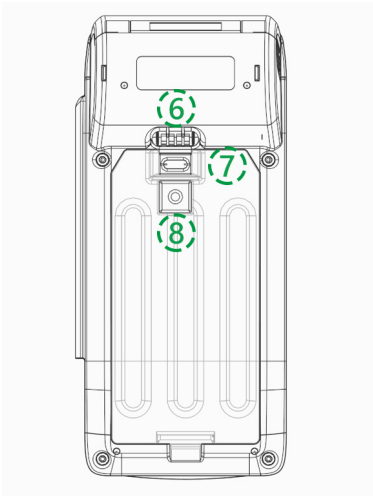
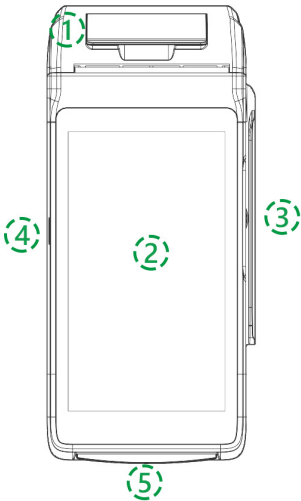

Figure 1

FRONT AREA	1	Printer Paper Cover
	2	5" Display
	3	Magnetic Strip Reader (MSR) slot
	4	Power Button (Press > 3 seconds to power on/off)
	5	Smart Card Reader (SCR) slot
REAR AREA	6	Charging contact points (Optional)
	7	USB port (type C) for charging
	8	Battery Compartment

■ **AT-150 Power spec:**

Input: 5V DC, 2A

■ **Power Adapter spec:**

Input: 100 ~240 Vac

Output: 5V DC, 2A



This symbol is intended to alert the user before starting using the POS.



Caution: Use only the AC adapter approved and provided by XAC Automation Corporation for use with this device. Use of any other AC adapter may cause a risk of fire or explosion.

- Operating Temperature: 0°C to 40°C

3. POWER ON/OFF THE DEVICE

To power on the device: Long press the Power button (**Figure 2**) > 3 seconds and the device screen will be activated.

To power off the device:

- 1) Press the Power button > 3 seconds to shut down the device.
- 2) No action on device after 30 minutes.

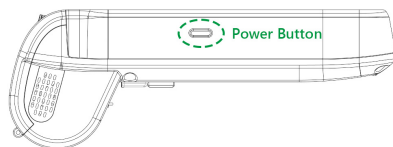
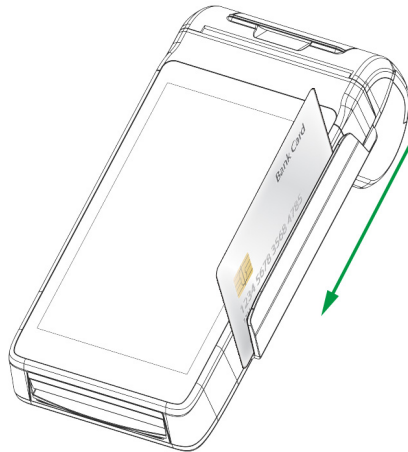

Figure 2

NOTE: When there is no action on AT-150 after 2mins (adjustable), the device will enter sleep mode. Please short press power button to wake up the device.

4. USING THE MAGNETIC CARD READER

Swipe the card through the slot with magnetic stripe side facing the same direction as the display. (Figure 3)



(Figure 3)

5. USING THE IC CARD READER

Insert an IC card into the slot (Figure 4) with the chip side facing the same direction as the touch panel (Figure 5).

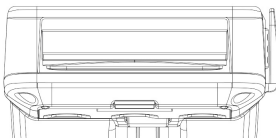

Figure 4

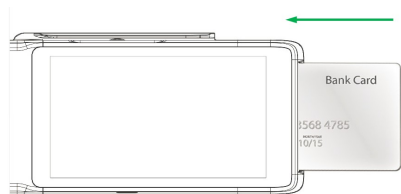

Figure 5

6. USING THE KEY PAD

After inserting the chip card, Press the numeric key as below keypad (**Figure 6**) to enter the desirable numbers on touch panel. Press Cancel (X) key to terminate any current function and press the Enter (O) key to confirm a value or an option.

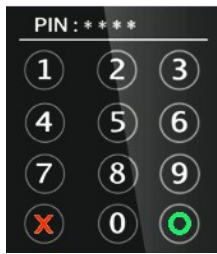

Figure 6

7. USING THE CONTACTLESS CARD READER

Tap the contactless card on top of the contactless logo (**Figure 7**).



Figure 7

8. REPLACE THE BATTERY

8-1 REMOVE THE BATTERY

STEP 1: Push the latch to pull the bottom cover from AT-150 as Figure 8.

STEP 2: After removing the bottom cover, pull up the battery connector as below Figure 9 to change a new battery.

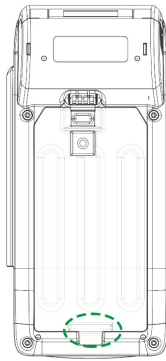

Figure 8

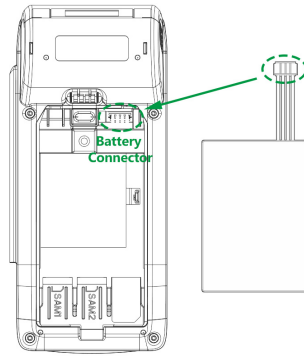

Figure 9

8-2 INSTALL THE BATTERY

STEP 1: Insert the battery connector into AT150 with correct direction as Figure 10.

STEP 2: After install the battery, close the bottom cover as Figure 11.

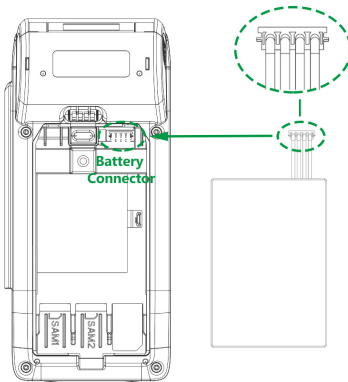

Figure 10

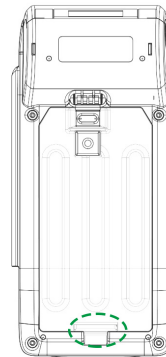

Figure 11



Bottom Cover Removal Warning

When removing the bottom cover and screws for the purposes of changing battery, remember to put back the cover and screws before power on the POS.



CAUTION:

RISK OF EXPLOSION IF BATTERY IS REPLACED BY AN INCORRECT TYPE. DISPOSE OF USED BATTERIES ACCORDING TO THE INSTRUCTIONS.



Warning for internal battery pack

To reduce risk of fire or burns:

1. Do not attempt to open, disassemble, or service the battery pack.
2. Do not crush, puncture, short external contacts, or dispose of in fire or water.
3. Do not heat above 60°C

9. INSERT SAM/SIM CARD

After removing the battery, the user can find SAM*2 (left) slots and SIM*1(right) slot at the bottom side of device. Please insert the card correctly as the icon shown on the cover as Figure

12:

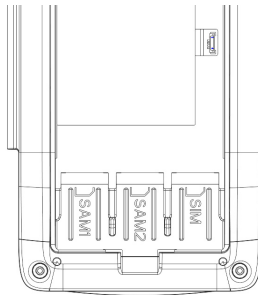

Figure 12

10. LOADING THE PAPER

Gently pop the printer cover's latch; then pull the cover (Figure 13). Load a roll of thermal paper into the printer. Load it so that the print-side of the paper will feed out facing the operator. Close the cover by pressing on the center of the printer cover. Use the serrated bar to tear off any excess paper.

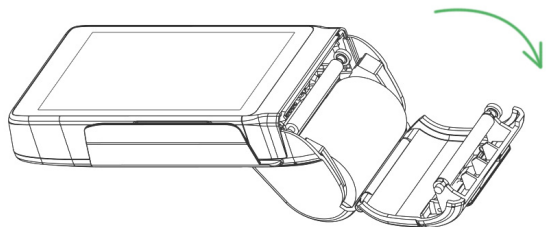
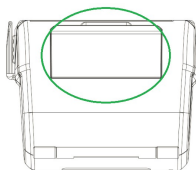

Figure 13

FEDERAL COMMUNICATIONS COMMISSION INTERFERENCE STATEMENT (Only for xCL_AT-150-R3-18U)

This device complies with Part 15 of the FCC Rules. Operation is subject to the following two conditions: (1) This device may not cause harmful interference, and (2) this device must accept any interference received, including interference that may cause undesired operation.

Note: This equipment has been tested and found to comply with the limits for a Class B digital device, pursuant to Part 15 of the FCC Rules. These limits are designed to provide reasonable protection against harmful interference in a residential installation. This equipment generates, uses and can radiate radio frequency energy and, if not installed and used in accordance with the instructions, may cause harmful interference to radio communications. However, there is no guarantee that interference will not occur in a particular installation. If this equipment does cause harmful interference to radio or television reception, which can be determined by turning the equipment off and on, the user is encouraged to try to correct the interference by one of the following measures:

- Reorient or relocate the receiving antenna.
- Increase the separation between the equipment and receiver.
- Connect the equipment into an outlet on a circuit different from that to which the receiver is connected.
- Consult the dealer or an experienced radio/TV technician for help.

FCC Caution: Any changes or modifications not expressly approved by the party responsible for compliance could void the user's authority to operate this equipment.

This transmitter must not be co-located or operating in conjunction with any other antenna or transmitter.

Radiation Exposure Statement:

The product comply with the FCC portable RF exposure limit set forth for an uncontrolled environment and are safe for intended operation as described in this manual. The further RF exposure reduction can be achieved if the product can be kept as far as possible from the user limb or set the device to lower output power if such function is available.

Specific Absorption Rate (SAR) Testing Your device has been designed to comply with applicable limits for RF exposure. These limits use a unit of measurement called Specific Absorption Rate, or SAR, which refers to the rate at which the limb absorbs RF energy. The Federal Communications Commission (FCC) has established a SAR limit for mobile phones of 1.6 W/kg, which applies in the United States and other countries that follow the FCC's SAR limit.

SAR testing is conducted with the device placed in common operating positions (e.g., held against the head, worn on the limb) and transmitting at its highest certified power level in each frequency band of operation. Because the device is transmitting at its highest certified power level, SAR tests capture a worst-case operating scenario and therefore often do not reflect the amount of RF exposure during normal, everyday use.

More information on SAR testing is available on the FCC's website at <http://www.fcc.gov/guides/wireless-devices-and-health-concerns>.

XAC Automation Corporation submitted SAR test results demonstrating compliance with the FCC's SAR limit for wireless devices as part of the FCC's equipment certification process for this device.

These results can be accessed via the FCC's equipment authorization database (found at <http://transition.fcc.gov/oet/ea/fccid/>) by searching for the device's FCC ID: MQT-AT150R3.