

SAR Test Report

Report No. : SF200518E05
Applicant : XAC AUTOMATION CORP.
Address : 4F, No. 30, INDUSTRY E. RD. IX, SCIENCE-BASED INDUSTRIAL
PARK,HSINCHU,TAIWAN
Product : Terminal
FCC ID : MQT-AT150R3
Brand : XAC
Model No. : xCL_AT-150-R3-18U
Standards : FCC 47 CFR Part 2 (2.1093), IEEE C95.1:1992, IEEE Std 1528:2013
KDB 865664 D01 v01r04, KDB 865664 D02 v01r02, KDB 248227 D01 v02r02,
KDB 447498 D01 v06, KDB 941225 D01 v03r01, KDB 941225 D05 v02r05
Sample Received Date : May 18, 2020
Date of Testing : Jun. 12, 2020 ~ Jun. 15, 2020
Lab Address : No. 47-2, 14th Ling, Chia Pau Vil., Lin Kou Dist., New Taipei City, Taiwan
Test Location : No. 19, Hwa Ya 2nd Rd., Wen Hwa Vil., Kwei Shan Dist., Taoyuan City, Taiwan

CERTIFICATION: The above equipment have been tested by **Bureau Veritas Consumer Products Services (H.K.) Ltd., Taoyuan Branch–Lin Kou Laboratories**, and found compliance with the requirement of the above standards. The test record, data evaluation & Equipment Under Test (EUT) configurations represented herein are true and accurate accounts of the measurements of the sample's SAR characteristics under the conditions specified in this report. It should not be reproduced except in full, without the written approval of our laboratory. The client should not use it to claim product certification, approval, or endorsement by TAF or any government agencies.

Prepared By :

Vera Huang

Vera Huang / Specialist

Approved By :

Gordon Lin

Gordon Lin / Manager



FCC Accredited No.: TW0003

This report is for your exclusive use. Any copying or replication of this report to or for any other person or entity, or use of our name or trademark, is permitted only with our prior written permission. This report sets forth our findings solely with respect to the test samples identified herein. The results set forth in this report are not indicative or representative of the quality or characteristics of the lot from which a test sample was taken or any similar or identical product unless specifically and expressly noted. Our report includes all of the tests requested by you and the results thereof based upon the information that you provided to us. You have 60 days from date of issuance of this report to notify us of any material error or omission caused by our negligence, provided, however, that such notice shall be in writing and shall specifically address the issue you wish to raise. A failure to raise such issue within the prescribed time shall constitute your unqualified acceptance of the completeness of this report, the tests conducted and the correctness of the report contents. Unless specific mention, the uncertainty of measurement has been explicitly taken into account to declare the compliance or non-compliance to the specification.

Table of Contents

Release Control Record	3
1. Summary of Maximum SAR Value	4
2. Description of Equipment Under Test	5
3. SAR Measurement System	6
3.1 Definition of Specific Absorption Rate (SAR)	6
3.2 SPEAG DASY6 System	6
3.2.1 Robot	7
3.2.2 Probes	8
3.2.3 Data Acquisition Electronics (DAE)	8
3.2.4 Phantoms	8
3.2.5 Device Holder	9
3.2.6 System Validation Dipoles	10
3.2.7 Power Source	10
3.2.8 Tissue Simulating Liquids	11
3.3 SAR System Verification	13
3.4 SAR Measurement Procedure	14
3.4.1 Area Scan and Zoom Scan Procedure	14
3.4.2 Volume Scan Procedure	15
3.4.3 Power Drift Monitoring	16
3.4.4 Spatial Peak SAR Evaluation	16
3.4.5 SAR Averaged Methods	16
4. SAR Measurement Evaluation	17
4.1 EUT Configuration and Setting	17
4.2 EUT Testing Position	22
4.2.1 Extremity Exposure Conditions	22
4.3 Tissue Verification	23
4.4 System Validation	23
4.5 System Verification	24
4.6 Maximum Output Power	24
4.6.1 Maximum Target Conducted Power	24
4.6.2 Measured Conducted Power Result	26
4.7 SAR Testing Results	31
4.7.1 SAR Test Reduction Considerations	31
4.7.2 SAR Results for Extremity Exposure Condition (Test Separation Distance is 0 mm)	33
4.7.3 SAR Measurement Variability	36
4.7.4 Simultaneous Multi-band Transmission Evaluation	37
5. Calibration of Test Equipment	39
6. Measurement Uncertainty	40
7. Information of the Testing Laboratories	41
Appendix A. SAR Plots of System Verification	
Appendix B. SAR Plots of SAR Measurement	
Appendix C. Calibration Certificate for Probe and Dipole	
Appendix D. Photographs of EUT and Setup	



Release Control Record

Report No.	Reason for Change	Date Issued
SF200518E05	Initial release	Jun. 19, 2020

1. Summary of Maximum SAR Value

Equipment Class	Mode	Highest SAR-10g Extremity Tested at 0 mm (W/kg)
PCB	WCDMA II	2.53
	WCDMA V	0.55
	LTE 2	2.63
	LTE 4	3.05
	LTE 12	0.79
DTS	2.4G WLAN	2.16
NII	5.3G WLAN	0.33
	5.6G WLAN	0.18
	5.8G WLAN	0.46
DSS	Bluetooth	0.17
DXX	NFC	N/A
Highest Simultaneous Transmission SAR		Extremity
		3.08

Note:

- The SAR criteria (**Head & Body: SAR-1g1.6 W/kg, and Extremity: SAR-10g 4.0 W/kg**) for general population/uncontrolled exposure is specified in FCC 47 CFR part 2 (2.1093) and ANSI/IEEE C95.1-1992.

2. Description of Equipment Under Test

EUT Type	Terminal
FCC ID	MQT-AT150R3
Brand Name	XAC
Model Name	xCL_AT-150-R3-18U
Tx Frequency Bands (Unit: MHz)	WCDMA Band II : 1852.4 ~ 1907.6 WCDMA Band V : 826.4 ~ 846.6 LTE Band 2 : 1850.7 ~ 1909.3 (BW: 1.4M, 3M, 5M, 10M, 15M, 20M) LTE Band 4 : 1710.7 ~ 1754.3 (BW: 1.4M, 3M, 5M, 10M, 15M, 20M) LTE Band 12 : 699.7 ~ 715.3 (BW: 1.4M, 3M, 5M, 10M) WLAN : 2412 ~ 2462, 5180 ~ 5240, 5260 ~ 5320, 5500 ~ 5720, 5745 ~ 5825 Bluetooth : 2402 ~ 2480 NFC : 13.56
Uplink Modulations	WCDMA : QPSK LTE : QPSK, 16QAM 802.11b : DSSS 802.11a/g/n : OFDM Bluetooth : GFSK, $\pi/4$ -DQPSK, 8-DPSK NFC : ASK
Maximum Tune-up Conducted Power (Unit: dBm)	Please refer to section 4.6.1 of this report
Antenna Type	FPCB Antenna
EUT Stage	Engineering Sample

Note:

1. The above EUT information is declared by manufacturer and for more detailed features description please refers to the manufacturer's specifications or User's Manual.

List of Accessory:

Battery (Optional)	Brand Name	Shenzhen Rishengzhi Electronics Technology Co., Ltd.
	Model Name	J625
	Power Rating	3.7Vdc, 3000mAh, 11.1Wh
	Type	Li-ion

3. SAR Measurement System

3.1 Definition of Specific Absorption Rate (SAR)

SAR is related to the rate at which energy is absorbed per unit mass in an object exposed to a radio field. The SAR distribution in a biological body is complicated and is usually carried out by experimental techniques or numerical modeling. The standard recommends limits for two tiers of groups, occupational/controlled and general population/uncontrolled, based on a person's awareness and ability to exercise control over his or her exposure. In general, occupational/controlled exposure limits are higher than the limits for general population/uncontrolled.

The SAR definition is the time derivative (rate) of the incremental energy (dW) absorbed by (dissipated in) an incremental mass (dm) contained in a volume element (dv) of a given density (ρ). The equation description is as below:

$$\text{SAR} = \frac{d}{dt} \left(\frac{dW}{dm} \right) = \frac{d}{dt} \left(\frac{dW}{\rho dv} \right)$$

SAR is expressed in units of Watts per kilogram (W/kg)

SAR measurement can be related to the electrical field in the tissue by

$$\text{SAR} = \frac{\sigma |E|^2}{\rho}$$

Where: σ is the conductivity of the tissue, ρ is the mass density of the tissue and E is the RMS electrical field strength.

3.2 SPEAG DASY6 System

DASY6 system consists of high precision robot, probe alignment sensor, phantom, robot controller, controlled measurement server and near-field probe. The robot includes six axes that can move to the precision position of the DASY6 software defined. The DASY6 software can define the area that is detected by the probe. The robot is connected to controlled box. Controlled measurement server is connected to the controlled robot box. The DAE includes amplifier, signal multiplexing, AD converter, offset measurement and surface detection. It is connected to the Electro-optical coupler (ECO). The ECO performs the conversion from the optical into digital electric signal of the DAE and transfers data to the PC.

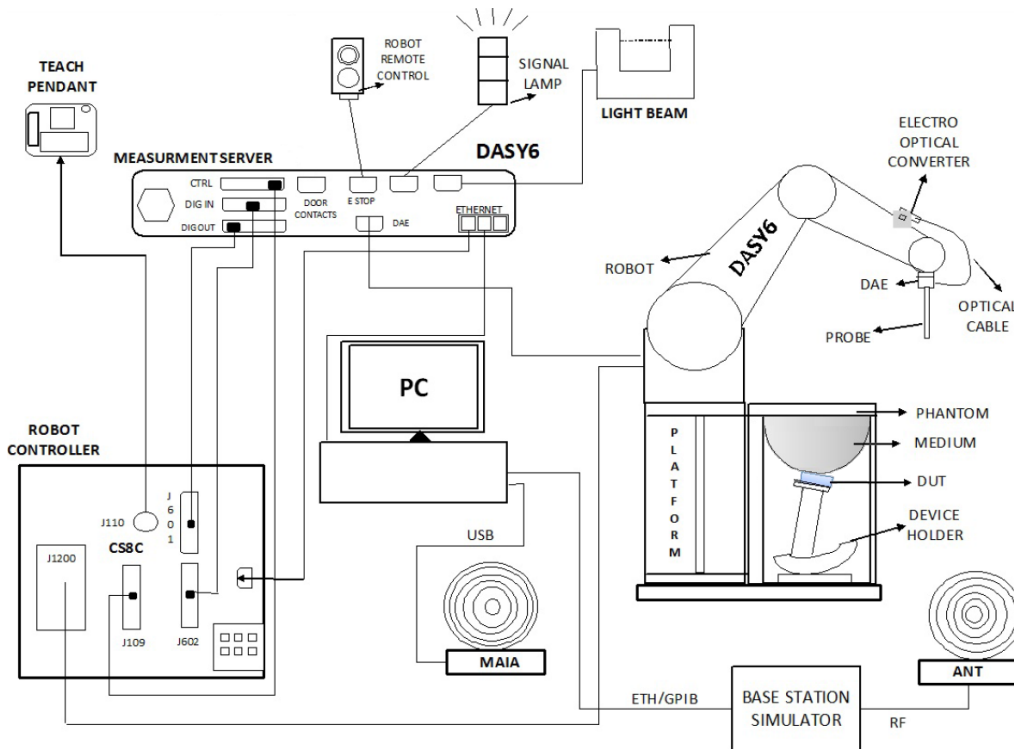

Fig-3.1 SPEAG DASY6 System Setup

3.2.1 Robot

The DASY6 systems use the high precision robots from Stäubli SA (France). For the 6-axis controller system, the robot controller version of CS8c from Stäubli is used. The Stäubli robot series have many features that are important for our application:

- High precision (repeatability ± 0.035 mm)
- High reliability (industrial design)
- Jerk-free straight movements
- Low ELF interference (the closed metallic construction shields against motor control fields)

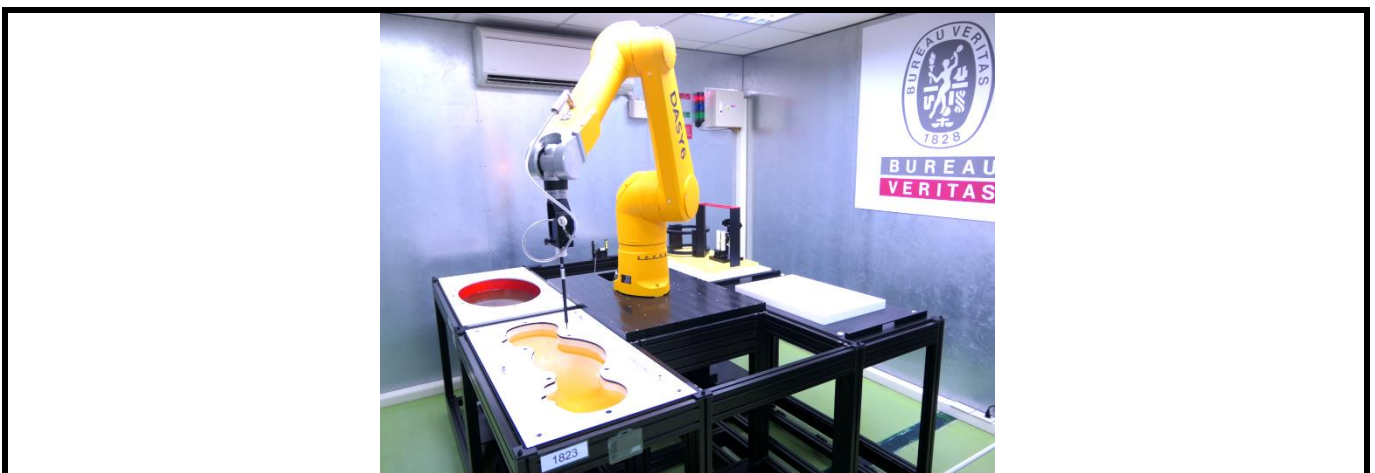



Fig-3.2 SPEAG DASY6 System

SAR Test Report

3.2.2 Probes

The SAR measurement is conducted with the dosimetric probe. The probe is specially designed and calibrated for use in liquid with high permittivity. The dosimetric probe has special calibration in liquid at different frequency.

Model	EX3DV4	
Construction	Symmetrical design with triangular core. Built-in shielding against static charges. PEEK enclosure material (resistant to organic solvents, e.g., DGBE).	
Frequency	4 MHz to 10 GHz Linearity: ± 0.2 dB	
Directivity	± 0.1 dB in TSL (rotation around probe axis) ± 0.3 dB in TSL (rotation normal to probe axis)	
Dynamic Range	10 μ W/g to 100 mW/g Linearity: ± 0.2 dB (noise: typically < 1 μ W/g)	
Dimensions	Overall length: 337 mm (Tip: 20 mm) Tip diameter: 2.5 mm (Body: 12 mm) Typical distance from probe tip to dipole centers: 1 mm	

3.2.3 Data Acquisition Electronics (DAE)

Model	DAE3, DAE4	
Construction	Signal amplifier, multiplexer, A/D converter and control logic. Serial optical link for communication with DASY embedded system (fully remote controlled). Two step probe touch detector for mechanical surface detection and emergency robot stop.	
Measurement Range	-100 to +300 mV (16 bit resolution and two range settings: 4mV, 400mV)	
Input Offset Voltage	$< 5\mu$ V (with auto zero)	
Input Bias Current	< 50 fA	
Dimensions	60 x 60 x 68 mm	

3.2.4 Phantoms

Model	SAM-Twin Phantom	
Construction	The shell corresponds to the specifications of the Specific Anthropomorphic Mannequin (SAM) phantom defined in IEEE Std 1528 and IEC 62209-1. It enables the dosimetric evaluation of left and right hand phone usage as well as body-mounted usage at the flat phantom region. A cover prevents evaporation of the liquid. Reference markings on the phantom allow the complete setup of all predefined phantom positions and measurement grids by teaching three points with the robot.	
Material	Vinylester, fiberglass reinforced (VE-GF)	
Shell Thickness	2 ± 0.2 mm (6 ± 0.2 mm at ear point)	
Dimensions	Length: 1000 mm Width: 500 mm Height: adjustable feet	
Filling Volume	approx. 25 liters	

SAR Test Report

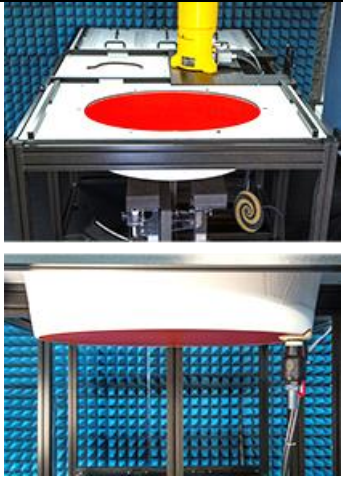
Model	ELI	
Construction	The ELI phantom is used for compliance testing of handheld and body-mounted wireless devices. ELI is fully compatible with the IEC 62209-2 standard and all known tissue simulating liquids. ELI has been optimized regarding its performance and can be integrated into our standard phantom tables. A cover prevents evaporation of the liquid. Reference markings on the phantom allow installation of the complete setup, including all predefined phantom positions and measurement grids, by teaching three points. The phantom is compatible with all SPEAG dosimetric probes and dipoles.	
Material	Vinylester, fiberglass reinforced (VE-GF)	
Shell Thickness	2.0 ± 0.2 mm (bottom plate)	
Dimensions	Major axis: 600 mm Minor axis: 400 mm	
Filling Volume	approx. 30 liters	

3.2.5 Device Holder

Model	MD4HHTV5 - Mounting Device for Hand-Held Transmitters	
Construction	In combination with the Twin SAM or ELI phantoms, the Mounting Device for Hand-Held Transmitters enables rotation of the mounted transmitter device to specified spherical coordinates. At the heads, the rotation axis is at the ear opening. Transmitter devices can be easily and accurately positioned according to IEC 62209-1, IEEE 1528, FCC, or other specifications. The device holder can be locked for positioning at different phantom sections (left head, right head, flat).	
Material	Polyoxymethylene (POM)	

Model	MDA4WTV5 - Mounting Device Adaptor for Ultra Wide Transmitters	
Construction	An upgrade kit to Mounting Device to enable easy mounting of wider devices like big smart-phones, e-books, small tablets, etc. It holds devices with width up to 140 mm.	
Material	Polyoxymethylene (POM)	

Model	MDA4SPV6 - Mounting Device Adaptor for Smart Phones	
Construction	The solid low-density MDA4SPV6 adaptor assuring no impact on the DUT radiation performance and is conform with any DUT design and shape.	
Material	ROHACELL	

SAR Test Report

Model	MD4LAPV5 - Mounting Device for Laptops and other Body-Worn Transmitters	
Construction	In combination with the Twin SAM or ELI phantoms, the Mounting Device (Body-Worn) enables testing of transmitter devices according to IEC 62209-2 specifications. The device holder can be locked for positioning at a flat phantom section.	
Material	Polyoxymethylene (POM), PET-G, Foam	

3.2.6 System Validation Dipoles

Model	D-Serial	
Construction	Symmetrical dipole with 1/4 balun. Enables measurement of feed point impedance with NWA. Matched for use near flat phantoms filled with tissue simulating solutions.	
Frequency	750 MHz to 5800 MHz	
Return Loss	> 20 dB	
Power Capability	> 100 W (f < 1GHz), > 40 W (f > 1GHz)	

3.2.7 Power Source

Model	Powersource1	
Signal Type	Continuous Wave	
Operating Frequencies	600 MHz to 5850 MHz	
Output Power	-5.0 dBm to +17.0 dBm	
Power Supply	5V DC, via USB jack	
Power Consumption	<3 W	
Applications	System performance check and validation with a CW signal.	

3.2.8 Tissue Simulating Liquids

For SAR measurement of the field distribution inside the phantom, the phantom must be filled with homogeneous tissue simulating liquid to a depth of at least 15 cm. For head SAR testing, the liquid height from the ear reference point (ERP) of the phantom to the liquid top surface is larger than 15 cm. For body SAR testing, the liquid height from the center of the flat phantom to the liquid top surface is larger than 15 cm. The nominal dielectric values of the tissue simulating liquids in the phantom and the tolerance of 10 % are listed in Table-3.1.

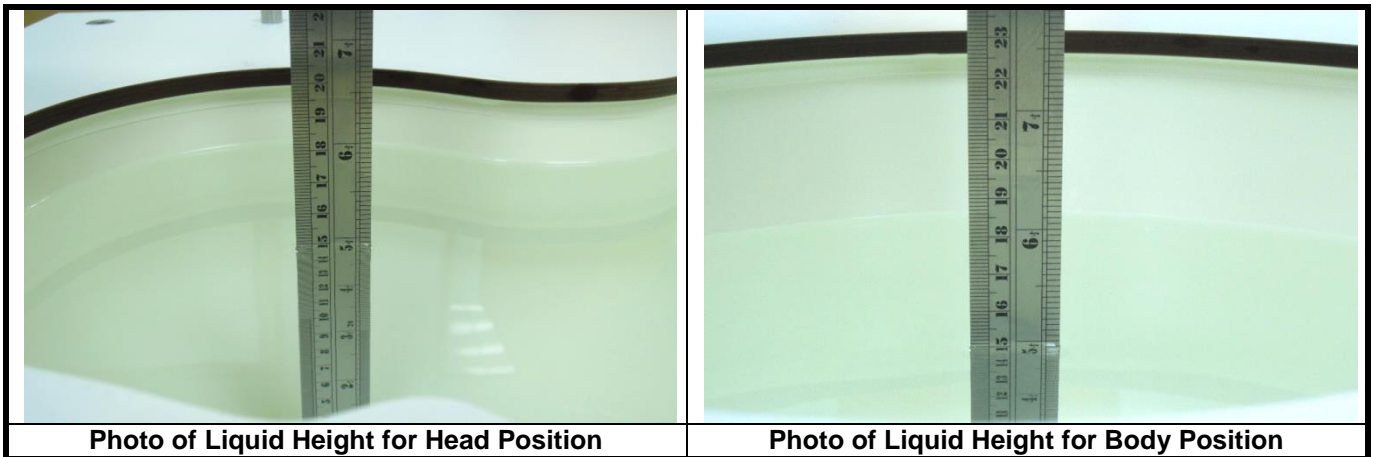

Table-3.1 Targets of Tissue Simulating Liquid

Frequency (MHz)	Target Permittivity	Range of ±10 %	Target Conductivity	Range of ±10 %
450	43.5	39.2 ~ 47.9	0.87	0.78 ~ 0.96
750	41.9	37.7 ~ 46.1	0.89	0.80 ~ 0.98
835	41.5	37.4 ~ 45.7	0.90	0.81 ~ 0.99
900	41.5	37.4 ~ 45.7	0.97	0.87 ~ 1.07
1450	40.5	36.5 ~ 44.6	1.20	1.08 ~ 1.32
1500	40.4	36.4 ~ 44.4	1.23	1.11 ~ 1.35
1640	40.2	36.2 ~ 44.2	1.31	1.18 ~ 1.44
1750	40.1	36.1 ~ 44.1	1.37	1.23 ~ 1.51
1800	40.0	36.0 ~ 44.0	1.40	1.26 ~ 1.54
1900	40.0	36.0 ~ 44.0	1.40	1.26 ~ 1.54
2000	40.0	36.0 ~ 44.0	1.40	1.26 ~ 1.54
2100	39.8	35.8 ~ 43.8	1.49	1.34 ~ 1.64
2300	39.5	35.6 ~ 43.5	1.67	1.50 ~ 1.84
2450	39.2	35.3 ~ 43.1	1.80	1.62 ~ 1.98
2600	39.0	35.1 ~ 42.9	1.96	1.76 ~ 2.16
3000	38.5	34.7 ~ 42.4	2.40	2.16 ~ 2.64
3500	37.9	34.1 ~ 41.7	2.91	2.62 ~ 3.20
4000	37.4	33.7 ~ 41.1	3.43	3.09 ~ 3.77
4500	36.8	33.1 ~ 40.5	3.94	3.55 ~ 4.33
5000	36.2	32.6 ~ 39.8	4.45	4.01 ~ 4.90
5200	36.0	32.4 ~ 39.6	4.66	4.19 ~ 5.13
5400	35.8	32.2 ~ 39.4	4.86	4.37 ~ 5.35
5600	35.5	32.0 ~ 39.1	5.07	4.56 ~ 5.58
5800	35.3	31.8 ~ 38.8	5.27	4.74 ~ 5.80
6000	35.1	31.6 ~ 38.6	5.48	4.93 ~ 6.03

SAR Test Report

The dielectric properties of the tissue simulating liquids are defined in IEC 62209-1 and IEC 62209-2. The dielectric properties of the tissue simulating liquids were verified prior to the SAR evaluation using a dielectric assessment kit and a network analyzer.

Since the range of $\pm 10\%$ of the required target values is used to measure relative permittivity and conductivity, the SAR correction procedure is applied to correct measured SAR for the deviations in permittivity and conductivity. Only positive correction has been used to scale up the measured SAR, and SAR result would not be corrected if the correction Δ SAR has a negative sign.

The following table gives the recipes for tissue simulating liquids.

Table-3.2 Recipes of Tissue Simulating Liquid

Tissue Type	Bactericide	DGBE	HEC	NaCl	Sucrose	Triton X-100	Water	Diethylene Glycol Mono-hexylether
H750	0.2	-	0.2	1.5	56.0	-	42.1	-
H835	0.2	-	0.2	1.5	57.0	-	41.1	-
H900	0.2	-	0.2	1.4	58.0	-	40.2	-
H1450	-	43.3	-	0.6	-	-	56.1	-
H1640	-	45.8	-	0.5	-	-	53.7	-
H1750	-	47.0	-	0.4	-	-	52.6	-
H1800	-	44.5	-	0.3	-	-	55.2	-
H1900	-	44.5	-	0.2	-	-	55.3	-
H2000	-	44.5	-	0.1	-	-	55.4	-
H2300	-	44.9	-	0.1	-	-	55.0	-
H2450	-	45.0	-	0.1	-	-	54.9	-
H2600	-	45.1	-	0.1	-	-	54.8	-
H3500	-	8.0	-	0.2	-	20.0	71.8	-
H5G	-	-	-	-	-	17.2	65.5	17.3

3.3 SAR System Verification

The system check verifies that the system operates within its specifications. It is performed daily or before every SAR measurement. The system check uses normal SAR measurements in the flat section of the phantom with a matched dipole at a specified distance. The system verification setup is shown as below.

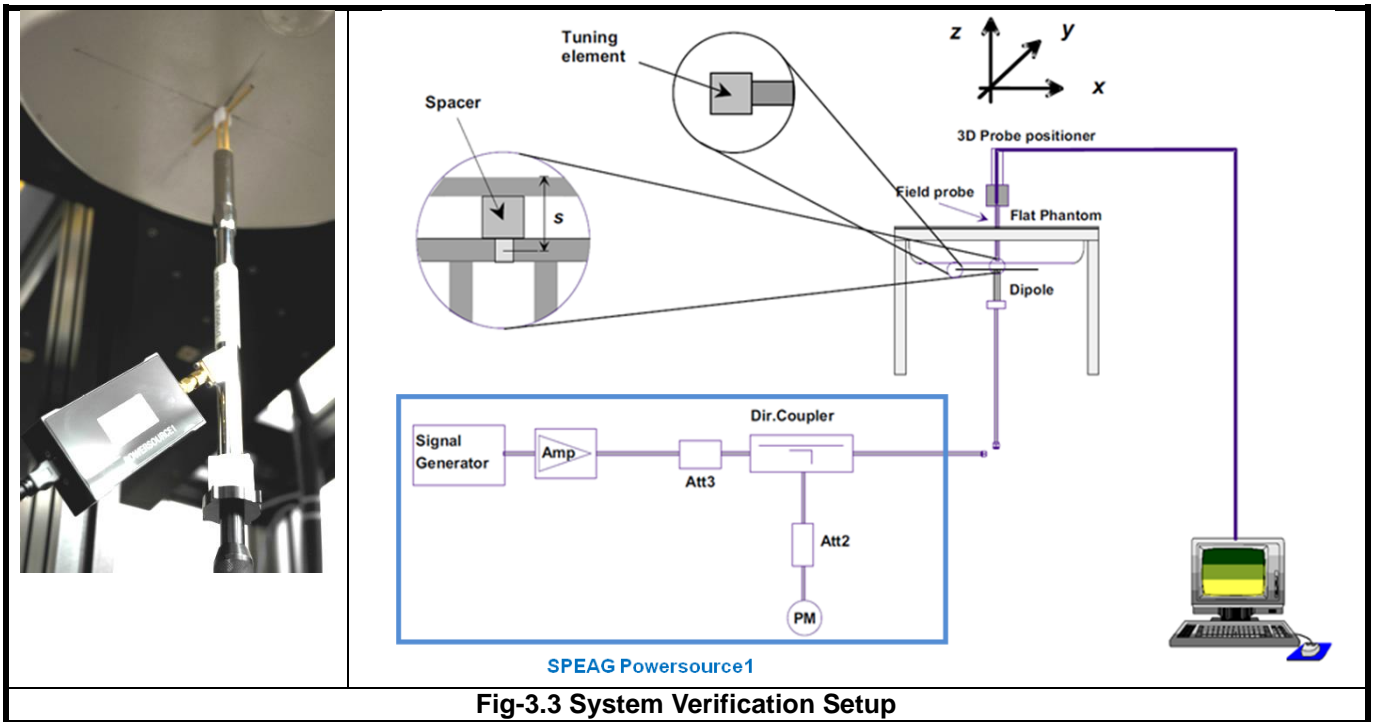

Fig-3.3 System Verification Setup

The SPEAG Powersource1 is a portable and very stable RF source providing a continuous wave (CW) signal. It is designed for conducting SAR system checks and SAR system validation of DASY and is compatible with IEC 62209-1, IEC 62209-2 and IEEE Std 1528 standards. The Powersource1 has been calibrated by SPEAG's ISO/IEC 17025-accredited calibration center. When using Powersource1, the setup can be simplified, as shown in Fig-3.3. The signal purity is warranted by design. Since the Powersource1 is calibrated, no additional equipment is needed and the Powersource1 can directly be connected to the SMA connector of the dipole without a cable as all separate components (signal generator, amplifier, coupler and power meter) are built into the unit.

The validation dipole is placed beneath the flat phantom with the specific spacer in place. The distance spacer is touch the phantom surface with a light pressure at the reference marking and be oriented parallel to the long side of the phantom. The Powersource1 is adjusted for the desired forward power of 17 dBm at the dipole connector and the RF output power would be turned on. After system check testing, the SAR result will be normalized to 1W forward input power and compared with the reference SAR value derived from validation dipole certificate report. The deviation of system check should be within 10 %.

3.4 SAR Measurement Procedure

According to the SAR test standard, the recommended procedure for assessing the peak spatial-average SAR value consists of the following steps:

- (a) Power reference measurement
- (b) Area scan
- (c) Zoom scan
- (d) Power drift measurement

The SAR measurement procedures for each of test conditions are as follows:

- (a) Make EUT to transmit maximum output power
- (b) Measure conducted output power through RF cable
- (c) Place the EUT in the specific position of phantom
- (d) Perform SAR testing steps on the DASY system
- (e) Record the SAR value

3.4.1 Area Scan and Zoom Scan Procedure

First area scan is used to locate the approximate location(s) of the local peak SAR value(s). The measurement grid within an area scan is defined by the grid extent, grid step size and grid offset. Next, in order to determine the EM field distribution in a three-dimensional spatial extension, zoom scan is required. The zoom scan is performed around the highest E-field value to determine the averaged SAR-distribution.

Measure the local SAR at a test point at 1.4 mm of the inner surface of the phantom recommended by SEPAG. The area scan (two-dimensional SAR distribution) is performed cover at least an area larger than the projection of the EUT or antenna. The measurement resolution and spatial resolution for interpolation shall be chosen to allow identification of the local peak locations to within one-half of the linear dimension of the corresponding side of the zoom scan volume. Following table provides the measurement parameters required for the area scan.

Parameter	$f \leq 3 \text{ GHz}$	$3 \text{ GHz} < f \leq 6 \text{ GHz}$
Maximum distance from closest measurement point to phantom surface	5 ± 1	$\delta \ln(2)/2 \pm 0.5$
Maximum probe angle from probe axis to phantom surface normal at the measurement location	$30^\circ \pm 1^\circ$	$20^\circ \pm 1^\circ$
Maximum area scan spatial resolution: $\Delta x_{Area}, \Delta y_{Area}$	$\leq 2 \text{ GHz: } \leq 15 \text{ mm}$ $2 - 3 \text{ GHz: } \leq 12 \text{ mm}$	$3 - 4 \text{ GHz: } \leq 12 \text{ mm}$ $4 - 6 \text{ GHz: } \leq 10 \text{ mm}$

From the scanned SAR distribution, identify the position of the maximum SAR value, in addition identify the positions of any local maxima with SAR values within 2 dB of the maximum value that will not be within the zoom scan of other peaks. Additional peaks shall be measured only when the primary peak is within 2 dB of the SAR compliance limit (e.g. 1 W/kg for 1.6 W/kg, 1 g limit; or 1.26 W/kg for 2 W/kg, 10 g limit).

The zoom scan (three-dimensional SAR distribution) is performed at the local maxima locations identified in previous area scan procedure. The zoom scan volume must be larger than the required minimum dimensions. When graded grids are used, which only applies in the direction normal to the phantom surface, the initial grid separation closest to the phantom surface and subsequent graded grid increment ratios must satisfy the required protocols. The 1-g SAR averaging volume must be fully contained within the zoom scan measurement volume boundaries; otherwise, the measurement must be repeated by shifting or expanding the zoom scan volume. The similar requirements also apply to 10-g SAR measurements. Following table provides the measurement parameters required for the zoom scan.

Parameter		$f \leq 3$ GHz	$3 \text{ GHz} < f \leq 6$ GHz
Maximum zoom scan spatial resolution: $\Delta x_{\text{zoom}}, \Delta y_{\text{zoom}}$		≤ 2 GHz: ≤ 8 mm 2 – 3 GHz: ≤ 5 mm	3 – 4 GHz: ≤ 5 mm 4 – 6 GHz: ≤ 4 mm
Maximum zoom scan spatial resolution, normal to phantom surface	<i>uniform grid:</i> $\Delta z_{\text{zoom}}(n)$	≤ 5 mm	3 – 4 GHz: ≤ 4 mm 4 – 5 GHz: ≤ 3 mm 5 – 6 GHz: ≤ 2 mm
	<i>graded grids:</i> $\Delta z_{\text{zoom}}(1)$	≤ 4 mm	3 – 4 GHz: ≤ 3.0 mm 4 – 5 GHz: ≤ 2.5 mm 5 – 6 GHz: ≤ 2.0 mm
	$\Delta z_{\text{zoom}}(n>1)$	$\leq 1.5 \cdot \Delta z_{\text{zoom}}(n-1)$ mm	
Minimum zoom scan volume (x, y, z)		≥ 30 mm	3 – 4 GHz: ≥ 28 mm 4 – 5 GHz: ≥ 25 mm 5 – 6 GHz: ≥ 22 mm

Per IEC 62209-2 AMD1, the successively higher resolution zoom scan is required if the zoom scan measured as defined above complies with both of the following criteria, or if the peak spatial-average SAR is below 0.1 W/kg, no additional measurements are needed:

- (1) The smallest horizontal distance from the local SAR peaks to all points 3 dB below the SAR peak shall be larger than the horizontal grid steps in both x and y directions ($\Delta x, \Delta y$). This shall be checked for the measured zoom scan plane conformal to the phantom at the distance z_{M1} .
- (2) The ratio of the SAR at the second measured point (M2) to the SAR at the closest measured point (M1) at the x-y location of the measured maximum SAR value shall be at least 30 %.

If one or both of the above criteria are not met, the zoom scan measurement shall be repeated using a finer resolution. New horizontal and vertical grid steps shall be determined from the measured SAR distribution so that the above criteria are met. Compliance with the above two criteria shall be demonstrated for the new measured zoom scan.

3.4.2 Volume Scan Procedure

The volume scan is used for assess overlapping SAR distributions for antennas transmitting in different frequency bands. It is equivalent to an oversized zoom scan used in standalone measurements. The measurement volume will be used to enclose all the simultaneous transmitting antennas. For antennas transmitting simultaneously in different frequency bands, the volume scan is measured separately in each frequency band. In order to sum correctly to compute the 1g aggregate SAR, the EUT remain in the same test position for all measurements and all volume scan use the same spatial resolution and grid spacing. When all volume scan were completed, the software, SEMCAD postprocessor can combine and subsequently superpose these measurement data to calculating the multiband SAR.

3.4.3 Power Drift Monitoring

All SAR testing is under the EUT install full charged battery and transmit maximum output power. In DASY measurement software, the power reference measurement and power drift measurement procedures are used for monitoring the power drift of EUT during SAR test. Both these procedures measure the field at a specified reference position before and after the SAR testing. The software will calculate the field difference in dB. If the power drift more than 5%, the SAR will be retested.

3.4.4 Spatial Peak SAR Evaluation

The procedure for spatial peak SAR evaluation has been implemented according to the test standard. It can be conducted for 1g and 10g, as well as for user-specific masses. The DASY software includes all numerical procedures necessary to evaluate the spatial peak SAR value.

The base for the evaluation is a "cube" measurement. The measured volume must include the 1g and 10g cubes with the highest averaged SAR values. For that purpose, the center of the measured volume is aligned to the interpolated peak SAR value of a previously performed area scan.

The entire evaluation of the spatial peak values is performed within the post-processing engine (SEMCAD). The system always gives the maximum values for the 1g and 10g cubes. The algorithm to find the cube with highest averaged SAR is divided into the following stages:

- (a) Extraction of the measured data (grid and values) from the Zoom Scan
- (b) Calculation of the SAR value at every measurement point based on all stored data (A/D values and measurement parameters)
- (c) Generation of a high-resolution mesh within the measured volume
- (d) Interpolation of all measured values from the measurement grid to the high-resolution grid
- (e) Extrapolation of the entire 3-D field distribution to the phantom surface over the distance from sensor to surface
- (f) Calculation of the averaged SAR within masses of 1g and 10g

3.4.5 SAR Averaged Methods

In DASY, the interpolation and extrapolation are both based on the modified Quadratic Shepard's method. The interpolation scheme combines a least-square fitted function method and a weighted average method which are the two basic types of computational interpolation and approximation.

Extrapolation routines are used to obtain SAR values between the lowest measurement points and the inner phantom surface. The extrapolation distance is determined by the surface detection distance and the probe sensor offset. The uncertainty increases with the extrapolation distance. To keep the uncertainty within 1% for the 1 g and 10 g cubes, the extrapolation distance should not be larger than 5 mm.

4. SAR Measurement Evaluation

4.1 EUT Configuration and Setting

<Connections between EUT and System Simulator>

For WWAN SAR testing, the EUT was linked and controlled by base station emulator. Communication between the EUT and the emulator was established by air link. The distance between the EUT and the communicating antenna of the emulator is larger than 50 cm and the output power radiated from the emulator antenna is at least 30 dB smaller than the output power of EUT. The EUT was set from the emulator to radiate maximum output power during SAR testing.

<Considerations Related to WCDMA for Setup and Testing>

Release 5 HSDPA Data Devices

The 3G SAR test reduction procedure is applied to body SAR with 12.2 kbps RMC as the primary mode. Otherwise, body SAR for HSDPA is measured using an FRC with H-Set 1 in Sub-test 1 and a 12.2 kbps RMC configured in Test Loop Mode 1, for the highest reported SAR configuration in 12.2 kbps RMC without HSDPA. HSDPA is configured according to the applicable UE category of a test device. The number of HS-DSCH/HS-PDSCHs, HARQ processes, minimum inter-TTI interval, transport block sizes and RV coding sequence are defined by the H-set. To maintain a consistent test configuration and stable transmission conditions, QPSK is used in the H-set for SAR testing. HS-DPCCH should be configured with a CQI feedback cycle of 4 ms and a CQI repetition factor of 2 to maintain a constant rate of active CQI slots. DPCCH and DPDCH gain factors (β_c , β_d), and HS-DPCCH power offset parameters (Δ_{ACK} , Δ_{NACK} , Δ_{CQI}) are set according to values indicated in below. The CQI value is determined by the UE category, transport block size, number of HS-PDSCHs and modulation used in the H-set.

Sub-test	β_c	β_d	β_d (SF)	β_c/β_d	$\beta_{HS}^{(1)(2)}$	CM ⁽³⁾ (dB)	MPR ⁽³⁾ (dB)
1	2/15	15/15	64	2/15	4/15	0.0	0.0
2	12/15 ⁽⁴⁾	15/15 ⁽⁴⁾	64	12/15 ⁽⁴⁾	24/15	1.0	0.0
3	15/15	8/15	64	15/8	30/15	1.5	0.5
4	15/15	4/15	64	15/4	30/15	1.5	0.5

Note 1: Δ_{ACK} , Δ_{NACK} and $\Delta_{CQI} = 30/15$ with $\beta_{HS} = 30/15 * \beta_c$.

Note 2: For the HS-DPCCH power mask requirement test in clause 5.2C, 5.7A, and the Error Vector Magnitude (EVM) with HS-DPCCH test in clause 5.13.1A, and HSDPA EVM with phase discontinuity in clause 5.13.1AA, Δ_{ACK} and $\Delta_{NACK} = 30/15$ with $\beta_{HS} = 30/15 * \beta_c$, and $\Delta_{CQI} = 24/15$ with $\beta_{HS} = 24/15 * \beta_c$.

Note 3: CM = 1 for $\beta_c/\beta_d = 12/15$, $\beta_{HS}/\beta_c = 24/15$. For all other combinations of DPDCH, DPCCH and HS-DPCCH the MPR is based on the relative CM difference. This is applicable for only UEs that support HSDPA in release 6 and later releases.

Note 4: For subtest 2 the β_c/β_d ratio of 12/15 for the TFC during the measurement period (TF1, TF0) is achieved by setting the signalled gain factors for the reference TFC (TF1, TF1) to $\beta_c = 11/15$ and $\beta_d = 15/15$.

SAR Test Report

Release 6 HSUPA Data Devices

The 3G SAR test reduction procedure is applied to body SAR with 12.2 kbps RMC as the primary mode. Otherwise, body SAR for HSPA is measured with E-DCH Sub-test 5, using H-Set 1 and QPSK for FRC and a 12.2 kbps RMC configured in Test Loop Mode 1 and power control algorithm 2, according to the highest reported body SAR configuration in 12.2 kbps RMC without HSPA. When VOIP applies to head exposure, the 3G SAR test reduction procedure is applied with 12.2 kbps RMC as the primary mode. Otherwise, the same HSPA configuration used for body SAR measurements are applied to head exposure testing. Due to inner loop power control requirements in HSPA, a communication test set is required for output power and SAR tests. The 12.2 kbps RMC, FRC H-set 1 and E-DCH configurations for HSPA are configured according to the β values indicated in below.

Sub-test	β_c	β_d	β_d (SF)	β_c/β_d	$\beta_{HS}^{(1)}$	β_{ec}	$\beta_{ed}^{(4)(5)}$	β_{ed} (SF)	β_{ed} (Codes)	CM ⁽²⁾ (dB)	MPR ⁽²⁾⁽⁶⁾ (dB)	AG ⁽⁵⁾ Index	E-TFCI
1	11/15 ⁽³⁾	15/15 ⁽³⁾	64	11/15 ⁽³⁾	22/15	209/225	1309/225	4	1	1.0	0.0	20	75
2	6/15	15/15	64	6/15	12/15	12/15	94/75	4	1	3.0	2.0	12	67
3	15/15	9/15	64	15/9	30/15	30/15	β_{ed1} : 47/15 β_{ed2} : 47/15	4 4	2	2.0	1.0	15	92
4	2/15	15/15	64	2/15	4/15	2/15	56/75	4	1	3.0	2.0	17	71
5	15/15	0	-	-	5/15	5/15	47/15	4	1	1.0	0.0	12	67

Note 1: For sub-test 1 to 4, Δ_{ACK} , Δ_{NACK} and $\Delta_{CQI} = 30/15$ with $\beta_{HS} = 30/15 * \beta_c$. For sub-test 5, Δ_{ACK} , Δ_{NACK} and $\Delta_{CQI} = 5/15$ with $\beta_{HS} = 5/15 * \beta_c$.
 Note 2: CM = 1 for $\beta_c/\beta_d = 12/15, \beta_{HS}/\beta_c = 24/15$. For all other combinations of DPDCH, DPCCH, HS-DPCCH, E-DPDCH and E-DPCCH the MPR is based on the relative CM difference.
 Note 3: For subtest 1 the β_c/β_d ratio of 11/15 for the TFC during the measurement period (TF1, TF0) is achieved by setting the signalled gain factors for the reference TFC (TF1, TF1) to $\beta_c = 10/15$ and $\beta_d = 15/15$.
 Note 4: In case of testing by UE using E-DPDCH Physical Layer category 1, Sub-test 3 is omitted according to TS25.306 Table 5.1g.
 Note 5: β_{ed} can not be set directly; it is set by Absolute Grant Value.
 Note 6: For subtests 2, 3 and 4, UE may perform E-DPDCH power scaling at max power which could results in slightly smaller MPR values.

HSPA+ SAR Guidance

The 3G SAR test reduction procedure is applied to HSPA+(uplink) with 12.2 kbps RMC as the primary mode. Otherwise, when SAR is required for Rel. 6 HSPA, SAR is required for Rel. 7 HSPA+. Power is measured for HSPA+ that supports uplink 16QAM according to configurations in Table C.11.1.4 of 3GPP TS 34.121-1 to determine SAR test reduction.

Sub-test	$\beta_c^{(3)}$	β_d	$\beta_{HS}^{(1)}$	β_{ec}	$\beta_{ed}^{(4)}$ (2xSF2)	$\beta_{ed}^{(4)}$ (2xSF4)	CM ⁽²⁾ (dB)	MPR ⁽²⁾ (dB)	AG ⁽⁴⁾ Index	E-TFCI ⁽⁵⁾	E-TFCI (boost)
1	1	0	30/15	30/15	β_{ed1} : 30/15 β_{ed2} : 30/15	β_{ed3} : 24/15 β_{ed4} : 24/15	3.5	2.5	14	105	105

Note 1: Δ_{ACK} , Δ_{NACK} and $\Delta_{CQI} = 30/15$ with $\beta_{HS} = 30/15 * \beta_c$.
 Note 2: CM = 3.5 and the MPR is based on the relative CM difference, MPR = MAX(CM-1,0).
 Note 3: DPDCH is not configured, therefore the β_c is set to 1 and $\beta_d = 0$ by default.
 Note 4: β_{ed} can not be set directly; it is set by Absolute Grant Value.
 Note 5: All the sub-tests require the UE to transmit 2SF2+2SF4 16QAM EDCH and they apply for UE using E-DPDCH category 7. E-DCH TTI is set to 2ms TTI and E-DCH table index = 2. To support these E-DCH configurations DPDCH is not allocated. The UE is signalled to use the extrapolation algorithm.

DC-HSDPA SAR Guidance

The 3G SAR test reduction procedure is applied to DC-HSDPA with 12.2 kbps RMC as the primary mode. Otherwise, when SAR is required for Rel. 5 HSDPA, SAR is required for Rel. 8 DC-HSDPA. Power is measured for DC-HSDPA according to the H-Set 12, FRC configuration in Table C.8.1.12 of 3GPP TS 34.121-1 to determine SAR test reduction. A primary and a secondary serving HS-DSCH Cell are required to perform the power measurement and for the results to be acceptable.

<Considerations Related to LTE for Setup and Testing>

This device contains LTE transmitter which follows 3GPP standards, is category 3, supports both QPSK and QAM modulations, and supported LTE band and channel bandwidth is listed in below. The output power was tested per 3GPP TS 36.521-1 maximum transmit procedures for both QPSK and QAM modulation. The results please refer to section 4.6 of this report.

EUT Supported LTE Band and Channel Bandwidth						
LTE Band	BW 1.4 MHz	BW 3 MHz	BW 5 MHz	BW 10 MHz	BW 15 MHz	BW 20 MHz
2	V	V	V	V	V	V
4	V	V	V	V	V	V
12	V	V	V	V		

The LTE maximum power reduction (MPR) in accordance with 3GPP TS 36.101 is active all times during LTE operation. The allowed MPR for the maximum output power is specified in below.

Modulation	Channel Bandwidth / RB Configurations						LTE MPR Setting (dB)
	BW 1.4 MHz	BW 3 MHz	BW 5 MHz	BW 10 MHz	BW 15 MHz	BW 20 MHz	
QPSK	> 5	> 4	> 8	> 12	> 16	> 18	1
16QAM	<= 5	<= 4	<= 8	<= 12	<= 16	<= 18	1
16QAM	> 5	> 4	> 8	> 12	> 16	> 18	2

Note: MPR is according to the standard and implemented in the circuit (mandatory).

In addition, the device is compliant with additional maximum power reduction (A-MPR) requirements defined in 3GPP TS 36.101 section 6.2.4 that was disabled for all FCC compliance testing.

During LTE SAR testing, the related parameters of operating band, channel bandwidth, uplink channel number, modulation type, and RB was set in base station simulator. When the EUT has registered and communicated to base station simulator, the simulator set to make EUT transmitting the maximum radiated power.

<Considerations Related to WLAN for Setup and Testing>

In general, various vendor specific external test software and chipset based internal test modes are typically used for SAR measurement. These chipset based test mode utilities are generally hardware and manufacturer dependent, and often include substantial flexibility to reconfigure or reprogram a device. A Wi-Fi device must be configured to transmit continuously at the required data rate, channel bandwidth and signal modulation, using the highest transmission duty factor supported by the test mode tools for SAR measurement. The test frequencies established using test mode must correspond to the actual channel frequencies. When 802.11 frame gaps are accounted for in the transmission, a maximum transmission duty factor of 92 - 96% is typically achievable in most test mode configurations. A minimum transmission duty factor of 85% is required to avoid certain hardware and device implementation issues related to wide range SAR scaling. In addition, a periodic transmission duty factor is required for current generation SAR systems to measure SAR correctly. The reported SAR must be scaled to 100% transmission duty factor to determine compliance at the maximum tune-up tolerance limit.

According to KDB 248227 D01, this device has installed WLAN engineering testing software which can provide continuous transmitting RF signal. During WLAN SAR testing, this device was operated to transmit continuously at the maximum transmission duty with specified transmission mode, operating frequency, lowest data rate, and maximum output power.

Initial Test Configuration

An initial test configuration is determined for OFDM transmission modes in 2.4 GHz and 5 GHz bands according to the channel bandwidth, modulation and data rate combination(s) with the highest maximum output power specified for production units in each standalone and aggregated frequency band. When the same maximum power is specified for multiple transmission modes in a frequency band, the largest channel bandwidth, lowest order modulation, lowest data rate and lowest order 802.11a/g/n/ac mode is used for SAR measurement, on the highest measured output power channel in the initial test configuration, for each frequency band.

Subsequent Test Configuration

SAR measurement requirements for the remaining 802.11 transmission mode configurations that have not been tested in the initial test configuration are determined separately for each standalone and aggregated frequency band, in each exposure condition, according to the maximum output power specified for production units. Additional power measurements may be required to determine if SAR measurements are required for subsequent highest output power channels in a subsequent test configuration. When the highest reported SAR for the initial test configuration according to the initial test position or fixed exposure position requirements, is adjusted by the ratio of the subsequent test configuration to initial test configuration specified maximum output power and the adjusted SAR is ≤ 1.2 W/kg, SAR is not required for that subsequent test configuration.

SAR Test Configuration and Channel Selection

When multiple channel bandwidth configurations in a frequency band have the same specified maximum output power, the initial test configuration is using largest channel bandwidth, lowest order modulation, lowest data rate, and lowest order 802.11 mode (i.e., 802.11a is chosen over 802.11n then 802.11ac or 802.11g is chosen over 802.11n). After an initial test configuration is determined, if multiple test channels have the same measured maximum output power, the channel chosen for SAR measurement is determined according to the following.

- 1) The channel closest to mid-band frequency is selected for SAR measurement.
- 2) For channels with equal separation from mid-band frequency; for example, high and low channels or two mid-band channels, the higher frequency (number) channel is selected for SAR measurement.

Test Reduction for U-NII-1 (5.2 GHz) and U-NII-2A (5.3 GHz) Bands

For devices that operate in both U-NII bands using the same transmitter and antenna(s), SAR test reduction is determined according to the following.

- 1) When the same maximum output power is specified for both bands, begin SAR measurement in U-NII-2A band by applying the OFDM SAR requirements. If the highest reported SAR for a test configuration is ≤ 1.2 W/kg, SAR is not required for U-NII-1 band for that configuration (802.11 mode and exposure condition).
- 2) When different maximum output power is specified for the bands, begin SAR measurement in the band with higher specified maximum output power. The highest reported SAR for the tested configuration is adjusted by the ratio of lower to higher specified maximum output power for the two bands. When the adjusted SAR is ≤ 1.2 W/kg, SAR is not required for the band with lower maximum output power in that test configuration.

<Considerations Related to Bluetooth for Setup and Testing>

This device has installed Bluetooth engineering testing software which can provide continuous transmitting RF signal. During Bluetooth SAR testing, this device was operated to transmit continuously at the maximum transmission duty with specified transmission mode, operating frequency, lowest data rate, and maximum output power.

The Bluetooth call box has been used during SAR measurement and the EUT was set to DH5 mode at the maximum output power. Its duty factor was calculated as below and the measured SAR for Bluetooth would be scaled to the 100% transmission duty factor to determine compliance.

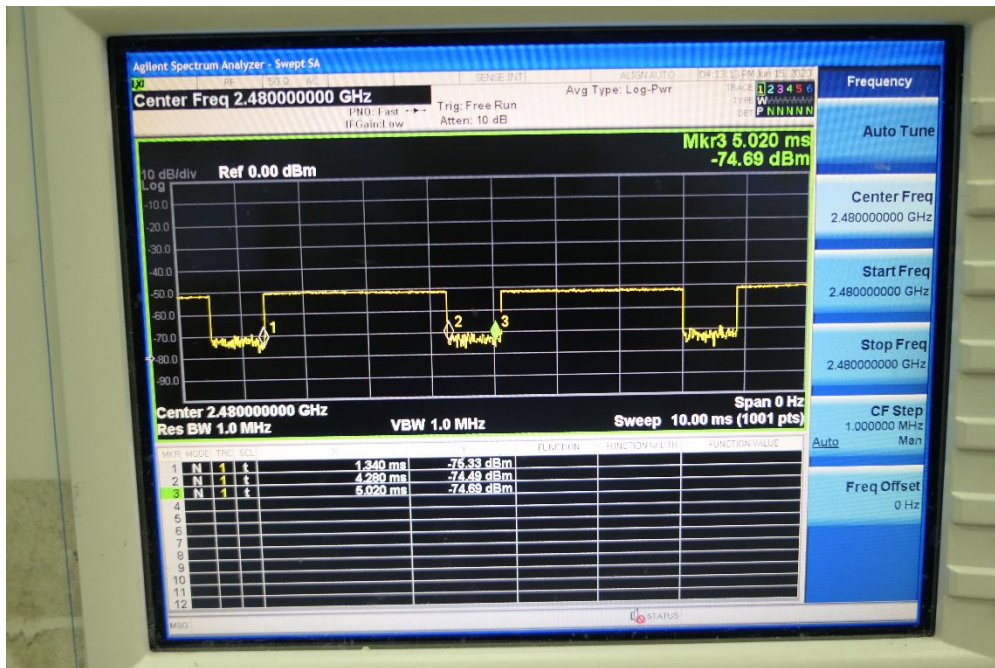

Time-domain plot for Bluetooth transmission signal

The duty factor of Bluetooth signal has been calculated as following.

$$\text{Duty Factor} = \text{Pulse Width} / \text{Total Period} = (4.280 - 1.340) / (5.020 - 1.340) = 79.89 \%$$

4.2 EUT Testing Position

4.2.1 Extremity Exposure Conditions

For credit card transaction authorization terminals, point-of-sale and/or inventory terminals where these devices may be torso or limb-supported, SAR should be separately assessed with each surface and the separation distances positioned against the flat phantom that correspond to the intended use as specified by the manufacturer. If the intended use is not specified in the user instructions, the device shall be tested directly against the flat phantom in all usable orientations.

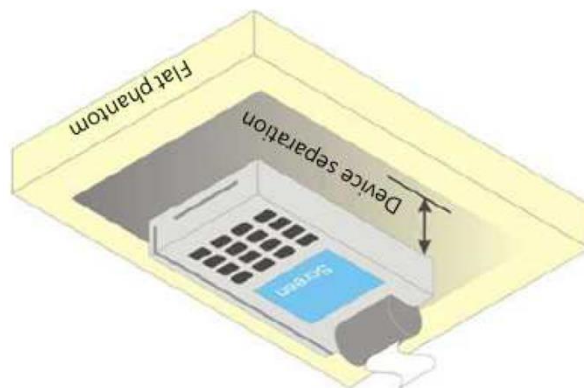

Fig-4.1 Illustration for Terminal Setup

4.3 Tissue Verification

The measuring results for tissue simulating liquid are shown as below.

Frequency (MHz)	Liquid Temp. (°C)	Measured Conductivity (σ)	Measured Permittivity (ϵ_r)	Target Conductivity (σ)	Target Permittivity (ϵ_r)	Conductivity Deviation (%)	Permittivity Deviation (%)	Test Date
750	23.1	0.892	42.971	0.89	41.9	0.22	2.56	Jun. 12, 2020
835	23.1	0.925	42.519	0.9	41.5	2.78	2.46	Jun. 12, 2020
1750	23.1	1.323	39.8	1.37	40.1	-3.43	-0.75	Jun. 12, 2020
1900	23.1	1.45	39.259	1.4	40	3.57	-1.85	Jun. 12, 2020
2450	23.5	1.882	38.248	1.8	39.2	4.56	-2.43	Jun. 15, 2020
5250	23.5	4.597	36.617	4.71	35.9	-2.40	2.00	Jun. 15, 2020
5600	23.5	5.006	36.08	5.07	35.5	-1.26	1.63	Jun. 15, 2020
5750	23.5	5.175	35.814	5.22	35.4	-0.86	1.17	Jun. 15, 2020

Note:

The dielectric properties of the tissue simulating liquid have been measured within 24 hours before the SAR testing and within $\pm 10\%$ of the target values. Liquid temperature during the SAR testing has kept within $\pm 2^\circ\text{C}$.

4.4 System Validation

The SAR measurement system was validated according to procedures in KDB 865664 D01. The validation status in tabulated summary is as below.

Test Date	Probe S/N	Calibration Point	Measured Conductivity (σ)	Measured Permittivity (ϵ_r)	Validation for CW			Validation for Modulation		
					Sensitivity Range	Probe Linearity	Probe Isotropy	Modulation Type	Duty Factor	PAR
Jun. 12, 2020	3971	750	0.892	42.971	Pass	Pass	Pass	N/A	N/A	N/A
Jun. 12, 2020	3971	835	0.925	42.519	Pass	Pass	Pass	N/A	N/A	N/A
Jun. 12, 2020	3971	1750	1.323	39.8	Pass	Pass	Pass	N/A	N/A	N/A
Jun. 12, 2020	3971	1900	1.45	39.259	Pass	Pass	Pass	N/A	N/A	N/A
Jun. 15, 2020	3650	2450	1.882	38.248	Pass	Pass	Pass	OFDM	N/A	Pass
Jun. 15, 2020	3650	5250	4.597	36.617	Pass	Pass	Pass	OFDM	N/A	Pass
Jun. 15, 2020	3650	5600	5.006	36.08	Pass	Pass	Pass	OFDM	N/A	Pass
Jun. 15, 2020	3650	5750	5.175	35.814	Pass	Pass	Pass	OFDM	N/A	Pass

SAR Test Report

4.5 System Verification

The measuring result for system verification is tabulated as below.

Test Date	Frequency (MHz)	1W Target SAR-10g (W/kg)	Measured SAR-10g (W/kg)	Normalized to 1W SAR-10g (W/kg)	Deviation (%)	Dipole S/N	Probe S/N	DAE S/N
Jun. 12, 2020	750	5.62	0.27	5.40	-3.91	1013	3971	1277
Jun. 12, 2020	835	6.22	0.326	6.52	4.82	4d121	3971	1277
Jun. 12, 2020	1750	19.50	1.03	20.60	5.64	1055	3971	1277
Jun. 12, 2020	1900	20.90	1.13	22.60	8.13	5d036	3971	1277
Jun. 15, 2020	2450	24.50	1.2	24.00	-2.04	737	3650	861
Jun. 15, 2020	5250	22.80	1.17	23.40	2.63	1019	3650	861
Jun. 15, 2020	5600	23.70	1.23	24.60	3.80	1019	3650	861
Jun. 15, 2020	5750	22.80	1.13	22.60	-0.88	1019	3650	861

Note:

Comparing to the reference SAR value provided by SPEAG in dipole calibration certificate, the deviation of system check results is within its specification of 10 %. The result indicates the system check can meet the variation criterion and the plots please refer to Appendix A of this report.

4.6 Maximum Output Power

4.6.1 Maximum Target Conducted Power

The maximum conducted average power (Unit: dBm) including tune-up tolerance is shown as below.

Mode	WCDMA Band II	WCDMA Band V
RMC 12.2K	22.5	23.0
HSDPA / HSUPA / DC-HSDPA	22.5	23.0

Mode	LTE 2	LTE 4	LTE 12
Maximum Target Power	23.0	23.0	23.5

WLAN 2.4G>

Mode	Channel	Frequency (MHz)	Tune-up Power
802.11b	1	2412	21.5
	6	2437	21.0
	11	2462	18.5
802.11g	1	2412	17.5
	6	2437	20.5
	11	2462	14.5
802.11n (HT20)	1	2412	17.5
	6	2437	20.0
	11	2462	13.5

SAR Test Report

<WLAN 5.2G>

Mode	Channel	Frequency (MHz)	Tune-up Power
802.11a	36	5180	15.0
	40	5200	15.0
	44	5220	15.0
	48	5240	16.0
802.11n (HT20)	36	5180	15.0
	40	5200	15.0
	44	5220	15.0
	48	5240	16.0
802.11n (HT40)	38	5190	11.5
	46	5230	16.5

<WLAN 5.3G>

Mode	Channel	Frequency (MHz)	Tune-up Power
802.11a	52	5260	16.5
	56	5280	16.0
	60	5300	17.0
	64	5320	16.0
802.11n (HT20)	52	5260	16.0
	56	5280	16.0
	60	5300	16.5
	64	5320	16.0
802.11n (HT40)	54	5270	13.5
	62	5310	13.5

<WLAN 5.6G>

Mode	Channel	Frequency (MHz)	Tune-up Power
802.11a	100	5500	14.0
	116	5580	15.5
	120	5600	15.0
	124	5620	15.0
	132	5660	15.0
	140	5700	12.0
	144	5720	13.0
802.11n (HT20)	100	5500	13.0
	116	5580	15.0
	120	5600	15.0
	124	5620	15.0
	132	5660	15.0
	140	5700	13.0
	144	5720	13.0
802.11n (HT40)	102	5510	12.5
	110	5550	15.5
	118	5590	15.5
	126	5630	15.5
	134	5670	14.0
	142	5710	13.0

SAR Test Report

<WLAN 5.8G>

Mode	Channel	Frequency (MHz)	Tune-up Power
802.11a	149	5745	14.5
	153	5765	14.5
	157	5785	14.5
	161	5805	14.5
	165	5825	14.5
802.11n (HT20)	149	5745	14.5
	153	5765	14.5
	157	5785	14.5
	161	5805	14.5
	165	5825	14.5
802.11n (HT40)	151	5755	14.5
	159	5795	14.5

<Bluetooth>

Mode	Channel	Frequency (MHz)	Tune-up Power
Bluetooth BDR	0	2402	12.0
	39	2441	12.0
	78	2480	12.0
Bluetooth LE	0	2402	3.0
	19	2440	3.0
	39	2480	3.0

4.6.2 Measured Conducted Power Result

The measuring conducted average power (Unit: dBm) is shown as below.

Band	WCDMA Band II			WCDMA Band V			3GPP MPR (dB)
	9262	9400	9538	4132	4182	4233	
Channel	1852.4	1880.0	1907.6	826.4	836.4	846.6	
Frequency (MHz)	1852.4	1880.0	1907.6	826.4	836.4	846.6	
RMC 12.2K	22.06	22.26	22.21	22.64	22.62	22.72	-
HSDPA Subtest-1	21.79	21.93	21.95	22.37	22.32	22.47	0
HSDPA Subtest-2	21.87	22.04	22.01	22.41	22.34	22.44	0
HSDPA Subtest-3	21.39	21.56	21.55	21.92	21.94	22.09	0.5
HSDPA Subtest-4	21.39	21.58	21.50	21.91	21.93	22.05	0.5
DC-HSDPA Subtest-1	21.68	21.82	21.83	22.25	22.21	22.36	0
DC-HSDPA Subtest-2	21.77	21.95	21.92	22.30	22.24	22.32	0
DC-HSDPA Subtest-3	21.30	21.45	21.42	21.80	21.85	22.00	0.5
DC-HSDPA Subtest-4	21.28	21.50	21.40	21.82	21.82	21.94	0.5
HSUPA Subtest-1	21.36	21.80	21.74	21.82	22.01	22.26	0
HSUPA Subtest-2	19.90	20.03	20.49	20.46	20.40	20.90	2
HSUPA Subtest-3	20.80	20.99	20.98	21.40	21.24	21.39	1
HSUPA Subtest-4	20.38	20.49	20.50	20.99	20.86	21.00	2
HSUPA Subtest-5	21.80	21.90	21.90	22.40	22.40	22.30	0



SAR Test Report

LTE Band 2

BW	MCS Index	RB Size	RB Offset	Low	Mid	High	3GPP MPR (dB)	BW	MCS Index	RB Size	RB Offset	Low	Mid	High	3GPP MPR (dB)
		Channel		18700	18900	19100				Channel		18675	18900	19125	
		Frequency (MHz)		1860.0	1880.0	1900.0				Frequency (MHz)		1857.5	1880.0	1902.5	
20M	QPSK	1	0	22.50	22.87	22.81	0	15M	QPSK	1	0	22.42	22.81	22.81	0
		1	50	22.05	22.42	22.36	0			1	37	22.04	22.35	22.30	0
		1	99	22.32	22.69	22.63	0			1	74	22.26	22.62	22.60	0
		50	0	21.25	21.62	21.56	1			36	0	21.19	21.52	21.49	1
		50	25	21.09	21.46	21.40	1			36	19	20.99	21.41	21.40	1
		50	50	21.21	21.58	21.52	1			36	39	21.14	21.55	21.46	1
	100	0	21.24	21.61	21.55	1	75		0	21.17	21.51	21.49	1		
	16QAM	1	0	21.61	21.98	21.92	1		16QAM	1	0	21.51	21.91	21.86	1
		1	50	21.19	21.56	21.50	1			1	37	21.15	21.54	21.47	1
		1	99	21.57	21.94	21.88	1			1	74	21.57	21.92	21.78	1
		50	0	20.11	20.48	20.42	2			36	0	20.11	20.46	20.41	2
		50	25	20.02	20.39	20.33	2			36	19	20.01	20.29	20.31	2
		50	50	20.10	20.47	20.41	2			36	39	20.01	20.46	20.36	2
	100	0	20.11	20.48	20.42	2	75		0	20.10	20.43	20.41	2		
10M	QPSK	1	0	22.32	22.69	22.71	0	5M	QPSK	1	0	22.39	22.75	22.51	0
		1	24	21.86	22.31	22.19	0			1	12	22.01	22.30	22.25	0
		1	49	22.15	22.49	22.44	0			1	24	22.25	22.60	22.52	0
		25	0	21.10	21.48	21.46	1			12	0	21.22	21.46	21.36	1
		25	12	21.04	21.29	21.30	1			12	6	20.91	21.40	21.26	1
		25	25	21.04	21.45	21.31	1			12	13	21.13	21.46	21.33	1
	50	0	21.02	21.43	21.46	1	25		0	21.20	21.48	21.29	1		
	16QAM	1	0	21.57	21.86	21.80	1		16QAM	1	0	21.45	21.85	21.83	1
		1	24	21.00	21.43	21.40	1			1	12	21.07	21.44	21.41	1
		1	49	21.47	21.77	21.83	1			1	24	21.47	21.76	21.66	1
		25	0	19.90	20.37	20.21	2			12	0	20.05	20.30	20.36	2
		25	12	19.98	20.35	20.14	2			12	6	19.86	20.33	20.13	2
		25	25	19.96	20.22	20.33	2			12	13	19.97	20.33	20.31	2
	50	0	20.07	20.46	20.41	2	25		0	20.01	20.29	20.29	2		
3M	QPSK	1	0	22.30	22.74	22.71	0	1.4M	QPSK	1	0	22.45	22.83	22.64	0
		1	7	21.92	22.25	22.26	0			1	2	21.84	22.22	22.13	0
		1	14	22.21	22.60	22.46	0			1	5	22.13	22.59	22.59	0
		8	0	21.06	21.48	21.36	1			3	0	22.12	22.57	22.37	0
		8	3	21.01	21.32	21.29	1			3	1	21.96	22.41	22.23	0
		8	7	21.07	21.49	21.45	1			3	3	22.09	22.47	22.42	0
	15	0	21.15	21.50	21.36	1	6		0	21.02	21.49	21.53	1		
	16QAM	1	0	21.46	21.84	21.86	1		16QAM	1	0	21.49	21.82	21.84	1
		1	7	21.09	21.39	21.35	1			1	2	21.06	21.45	21.27	1
		1	14	21.50	21.91	21.77	1			1	5	21.39	21.88	21.71	1
		8	0	20.08	20.43	20.25	2			3	0	20.95	21.34	21.29	1
		8	3	19.94	20.22	20.16	2			3	1	20.97	21.26	21.29	1
		8	7	19.93	20.36	20.27	2			3	3	20.96	21.30	21.28	1
	15	0	19.93	20.41	20.29	2	6		0	19.98	20.28	20.33	2		

SAR Test Report

LTE Band 4															
BW	MCS Index	RB Size	RB Offset	Low	Mid	High	3GPP MPR (dB)	BW	MCS Index	RB Size	RB Offset	Low	Mid	High	3GPP MPR (dB)
		Channel		20050	20175	20300				Channel		20025	20175	20325	
		Frequency (MHz)		1720.0	1732.5	1745.0				Frequency (MHz)		1717.5	1732.5	1747.5	
20M	QPSK	1	0	22.63	22.80	22.99	0	15M	QPSK	1	0	22.63	22.79	22.94	0
		1	50	22.38	22.55	22.74	0			1	37	22.31	22.47	22.72	0
		1	99	22.24	22.41	22.60	0			1	74	22.14	22.31	22.59	0
		50	0	21.62	21.79	21.98	1			36	0	21.55	21.70	21.94	1
		50	25	21.45	21.62	21.81	1			36	19	21.37	21.61	21.71	1
		50	50	21.28	21.45	21.64	1			36	39	21.18	21.44	21.60	1
	100	0	21.53	21.70	21.89	1	75		0	21.44	21.60	21.79	1		
	16QAM	1	0	21.78	21.95	21.94	1		16QAM	1	0	21.71	21.95	21.92	1
		1	50	21.25	21.42	21.61	1			1	37	21.18	21.33	21.57	1
		1	99	21.13	21.30	21.49	1			1	74	21.04	21.29	21.43	1
		50	0	20.66	20.83	20.99	2			36	0	20.56	20.83	20.91	2
		50	25	20.42	20.59	20.78	2			36	19	20.36	20.51	20.76	2
		50	50	20.35	20.52	20.71	2			36	39	20.35	20.43	20.69	2
		100	0	20.49	20.66	20.85	2			75	0	20.44	20.64	20.80	2
10M		QPSK	1	0	22.40	22.70	22.91	0		5M	QPSK	1	0	22.56	22.69
	1		24	22.16	22.42	22.74	0	1	12			22.38	22.43	22.61	0
	1		49	22.16	22.41	22.50	0	1	24			22.12	22.23	22.36	0
	25		0	21.37	21.61	21.96	1	12	0			21.50	21.70	21.79	1
	25		12	21.33	21.39	21.65	1	12	6			21.28	21.60	21.51	1
	25		25	21.22	21.35	21.47	1	12	13			21.15	21.25	21.48	1
	50	0	21.37	21.47	21.82	1	25	0	21.41		21.62	21.70	1		
	16QAM	1	0	21.62	21.79	21.83	1	16QAM	1		0	21.71	21.81	21.71	1
		1	24	21.13	21.39	21.51	1		1		12	21.15	21.25	21.48	1
		1	49	20.98	21.28	21.27	1		1		24	20.95	21.14	21.31	1
		25	0	20.50	20.59	20.95	2		12		0	20.61	20.65	20.82	2
		25	12	20.27	20.53	20.65	2		12		6	20.30	20.55	20.65	2
		25	25	20.19	20.42	20.64	2		12		13	20.29	20.44	20.57	2
		50	0	20.47	20.49	20.79	2		25		0	20.46	20.51	20.70	2
3M		QPSK	1	0	22.57	22.63	22.91		0	1.4M	QPSK	1	0	22.49	22.58
	1		7	22.25	22.53	22.61	0	1	2			22.21	22.48	22.60	0
	1		14	22.09	22.26	22.56	0	1	5			22.11	22.22	22.38	0
	8		0	21.61	21.75	21.80	1	3	0			22.49	22.68	22.79	0
	8		3	21.31	21.58	21.66	1	3	1			22.44	22.51	22.56	0
	8		7	21.23	21.31	21.49	1	3	3			22.18	22.29	22.46	0
	15	0	21.41	21.61	21.89	1	6	0	21.33		21.58	21.73	1		
	16QAM	1	0	21.66	21.82	21.88	1	16QAM	1		0	21.72	21.72	21.83	1
		1	7	21.12	21.36	21.57	1		1		2	21.13	21.32	21.58	1
		1	14	21.03	21.29	21.37	1		1		5	20.94	21.11	21.44	1
		8	0	20.54	20.59	20.94	2		3		0	21.43	21.65	21.92	1
		8	3	20.30	20.43	20.68	2		3		1	21.33	21.44	21.61	1
		8	7	20.15	20.38	20.56	2		3		3	21.23	21.32	21.47	1
		15	0	20.35	20.55	20.74	2		6		0	20.33	20.56	20.82	2



SAR Test Report

LTE Band 12															
BW	MCS Index	RB Size	RB Offset	Low	Mid	High	3GPP MPR (dB)	BW	MCS Index	RB Size	RB Offset	Low	Mid	High	3GPP MPR (dB)
		Channel		23060	23095	23130				Channel		23035	23095	23155	
		Frequency (MHz)		704.0	707.5	711.0				Frequency (MHz)		701.5	707.5	713.5	
10M	QPSK	1	0	23.17	23.37	23.40	0	5M	QPSK	1	0	23.17	23.37	23.31	0
		1	24	22.95	23.15	23.18	0			1	12	22.85	23.05	23.17	0
		1	49	23.05	23.25	23.28	0			1	24	23.05	23.24	23.26	0
		25	0	21.87	22.07	22.10	1			12	0	21.85	22.03	22.04	1
		25	12	21.84	22.04	22.07	1			12	6	21.84	22.04	21.97	1
		25	25	21.83	22.03	22.06	1			12	13	21.74	21.94	21.99	1
	50	0	21.80	22.00	22.03	1	25		0	21.72	21.99	22.03	1		
	16QAM	1	0	21.97	22.17	22.20	1		16QAM	1	0	21.95	22.11	22.10	1
		1	24	21.54	21.74	21.77	1			1	12	21.49	21.72	21.75	1
		1	49	21.84	22.04	22.07	1			1	24	21.79	21.95	21.99	1
		25	0	20.75	20.95	20.98	2			12	0	20.73	20.95	20.92	2
		25	12	21.03	21.23	21.26	2			12	6	20.94	21.23	21.19	2
		25	25	20.98	21.18	21.21	2			12	13	20.95	21.13	21.18	2
		50	0	20.83	21.03	21.06	2			25	0	20.75	20.95	21.06	2
3M		QPSK	1	0	23.09	23.25	23.27	0		1.4M	QPSK	1	0	23.03	23.30
	1		7	22.74	23.00	22.98	0	1	2			22.80	23.09	22.97	0
	1		14	23.00	23.21	23.13	0	1	5			22.87	23.07	23.00	0
	8		0	21.83	21.92	22.05	1	3	0			21.75	21.90	21.91	0
	8		3	21.64	21.85	21.93	1	3	1			21.75	21.94	21.96	0
	8		7	21.70	21.79	21.91	1	3	3			21.78	21.97	21.84	0
	15	0	21.71	21.83	21.89	1	6	0	21.62		21.96	21.89	1		
	16QAM	1	0	21.84	22.02	22.14	1	16QAM	1		0	21.90	22.11	22.08	1
		1	7	21.32	21.58	21.54	1		1		2	21.49	21.53	21.62	1
		1	14	21.71	21.88	22.01	1		1		5	21.65	21.89	21.94	1
		8	0	20.59	20.84	20.94	2		3		0	20.64	20.86	20.90	1
		8	3	21.02	21.07	21.07	2		3		1	20.89	21.11	21.07	1
		8	7	20.77	21.05	21.20	2		3		3	20.83	21.12	21.04	1
		15	0	20.62	20.93	20.96	2		6		0	20.69	20.90	20.92	2

SAR Test Report

<WLAN 2.4G>

Mode	Channel	Frequency (MHz)	Average Power
802.11b	1	2412	21.40
	6	2437	20.61
	11	2462	18.24

<WLAN 5.3G>

Mode	Channel	Frequency (MHz)	Average Power
802.11a	52	5260	16.12
	56	5280	15.53
	60	5300	16.80
	64	5320	15.41

<WLAN 5.6G>

Mode	Channel	Frequency (MHz)	Average Power
802.11n (HT40)	102	5510	12.24
	110	5550	15.40
	118	5590	15.35
	126	5630	15.32
	134	5670	13.80
	142	5710	12.92

<WLAN 5.8G>

Mode	Channel	Frequency (MHz)	Average Power
802.11n (HT40)	151	5755	14.40
	159	5795	14.10

<Bluetooth>

Mode	Channel	Frequency (MHz)	Average Power
Bluetooth EDR	0	2402	11.55
	39	2441	11.69
	78	2480	11.86
Bluetooth LE	0	2402	2.52
	19	2440	2.54
	39	2480	2.85

4.7 SAR Testing Results

4.7.1 SAR Test Reduction Considerations

<KDB 447498 D01, General RF Exposure Guidance>

Testing of other required channels within the operating mode of a frequency band is not required when the reported SAR for the mid-band or highest output power channel is:

- (1) ≤ 0.8 W/kg or 2.0 W/kg, for 1-g or 10-g respectively, when the transmission band is ≤ 100 MHz
- (2) ≤ 0.6 W/kg or 1.5 W/kg, for 1-g or 10-g respectively, when the transmission band is between 100 MHz and 200 MHz
- (3) ≤ 0.4 W/kg or 1.0 W/kg, for 1-g or 10-g respectively, when the transmission band is ≥ 200 MHz

When SAR is not measured at the maximum power level allowed for production units, the measured SAR will be scaled to the maximum tune-up tolerance limit to determine compliance. The scaling factor for the tune-up power is defined as maximum tune-up limit (mW) / measured conducted power (mW). The reported SAR would be calculated by measured SAR x tune-up power scaling factor.

The SAR has been measured with highest transmission duty factor supported by the test mode tools for WLAN and/or Bluetooth. When the transmission duty factor could not achieve 100%, the reported SAR will be scaled to 100% transmission duty factor to determine compliance at the maximum tune-up power. The scaling factor for the duty factor is defined as 100% / transmission duty cycle (%). The reported SAR would be calculated by measured SAR x tune-up power scaling factor x duty cycle scaling factor.

<KDB 941225 D01, 3G SAR Measurement Procedures>

The mode tested for SAR is referred to as the primary mode. The equivalent modes considered for SAR test reduction are denoted as secondary modes. Both primary and secondary modes must be in the same frequency band. When the maximum output power and tune-up tolerance specified for production units in a secondary mode is $\leq 1/4$ dB higher than the primary mode or when the highest reported SAR of the primary mode is scaled by the ratio of specified maximum output power and tune-up tolerance of secondary to primary mode and the adjusted SAR is ≤ 1.2 W/kg, SAR measurement is not required for the secondary mode.

<KDB 941225 D05, SAR Evaluation Considerations for LTE Devices>

(1) QPSK with 1 RB and 50% RB allocation

Start with the largest channel bandwidth and measure SAR, using the RB offset and required test channel combination with the highest maximum output power among RB offsets at the upper edge, middle and lower edge of each required test channel. When the reported SAR is ≤ 0.8 W/kg, testing of the remaining RB offset configurations and required test channels is not required; otherwise, SAR is required for the remaining required test channels and only for the RB offset configuration with the highest output power for that channel. When the reported SAR of a required test channel is > 1.45 W/kg, SAR is required for all three RB offset configurations for that required test channel.

(2) QPSK with 100% RB allocation

SAR is not required when the highest maximum output power for 100% RB allocation is less than the highest maximum output power in 50% and 1 RB allocations and the highest reported SAR for 1 RB and 50% RB allocation are ≤ 0.8 W/kg. Otherwise, SAR is measured for the highest output power channel; and if the reported SAR is > 1.45 W/kg, the remaining required test channels must also be tested.

(3) Higher order modulations

SAR is required only when the highest maximum output power for the configuration in the higher order modulation is $> 1/2$ dB higher than the same configuration in QPSK or when the reported SAR for the QPSK configuration is > 1.45 W/kg.

(4) Other channel bandwidth

SAR is required when the highest maximum output power of the smaller channel bandwidth is $> 1/2$ dB higher than the equivalent channel configurations in the largest channel bandwidth configuration or the reported SAR of a configuration for the largest channel bandwidth is > 1.45 W/kg.

<KDB 248227 D01, SAR Guidance for Wi-Fi Transmitters>

- (1) For WLAN 2.4 GHz, the highest measured maximum output power channel for DSSS was selected for SAR measurement. When the reported SAR is ≤ 0.8 W/kg, no further SAR testing is required. Otherwise, SAR is evaluated at the next highest measured output power channel. When any reported SAR is > 1.2 W/kg, SAR is required for the third channel. For OFDM modes (802.11g/n), SAR is not required when the highest reported SAR for DSSS is adjusted by the ratio of OFDM to DSSS specified maximum output power and it is ≤ 1.2 W/kg.
- (2) For WLAN 5GHz, the initial test configuration was selected according to the transmission mode with the highest maximum output power. When the reported SAR of initial test configuration is > 0.8 W/kg, SAR is required for the subsequent highest measured output power channel until the reported SAR result is ≤ 1.2 W/kg or all required channels are measured. For other transmission modes, SAR is not required when the highest reported SAR for initial test configuration is adjusted by the ratio of subsequent test configuration to initial test configuration specified maximum output power and it is ≤ 1.2 W/kg.
- (3) For WLAN 5GHz, the initial test configuration was selected according to the transmission mode with the highest maximum output power. When the reported SAR of initial test configuration is > 0.8 W/kg, SAR is required for the subsequent highest measured output power channel until the reported SAR result is ≤ 1.2 W/kg or all required channels are measured. For other transmission modes, SAR is not required when the highest reported SAR for initial test configuration is adjusted by the ratio of subsequent test configuration to initial test configuration specified maximum output power and it is ≤ 1.2 W/kg.

SAR Test Report

4.7.2 SAR Results for Extremity Exposure Condition (Test Separation Distance is 0 mm)

Plot No.	Band	Mode	Test Position	Ch.	Max. Tune-up Power (dBm)	Measured Conducted Power (dBm)	Scaling Factor	Power Drift (dB)	Measured SAR-10g (W/kg)	Scaled SAR-10g (W/kg)
	WCDMA II	RMC12.2K	Front Face	9400	22.50	22.26	1.06	0.11	0.081	0.09
	WCDMA II	RMC12.2K	Rear Face	9400	22.50	22.26	1.06	-0.01	2.27	2.41
	WCDMA II	RMC12.2K	Left Side	9400	22.50	22.26	1.06	-0.19	0.18	0.19
	WCDMA II	RMC12.2K	Right Side	9400	22.50	22.26	1.06	0.017	0.248	0.26
	WCDMA II	RMC12.2K	Top Side	9400	22.50	22.26	1.06	-0.14	0.936	0.99
	WCDMA II	RMC12.2K	Bottom Side	9400	22.50	22.26	1.06	0	<0.001	0.00
	WCDMA II	RMC12.2K	Rear Face	9262	22.50	22.06	1.11	-0.17	2.19	2.43
01	WCDMA II	RMC12.2K	Rear Face	9538	22.50	22.21	1.07	0.13	2.36	2.53
	WCDMA II	RMC12.2K	Rear Face	9538	22.50	22.21	1.07	0.11	2.33	2.49
	WCDMA V	RMC12.2K	Front Face	4233	23.00	22.72	1.07	0.05	0.099	0.11
	WCDMA V	RMC12.2K	Rear Face	4233	23.00	22.72	1.07	0.11	0.486	0.52
	WCDMA V	RMC12.2K	Left Side	4233	23.00	22.72	1.07	0.01	0.15	0.16
	WCDMA V	RMC12.2K	Right Side	4233	23.00	22.72	1.07	-0.04	0.118	0.13
	WCDMA V	RMC12.2K	Top Side	4233	23.00	22.72	1.07	-0.19	0.235	0.25
	WCDMA V	RMC12.2K	Bottom Side	4233	23.00	22.72	1.07	0	<0.001	0.00
02	WCDMA V	RMC12.2K	Rear Face	4132	23.00	22.64	1.09	-0.17	0.500	0.55
	WCDMA V	RMC12.2K	Rear Face	4182	23.00	22.62	1.09	0.04	0.477	0.52

Note: The "< 0.001" means there is no SAR value or the SAR is too low to be measured.

Plot No.	Band	Mode	Test Position	Ch.	RB#	RB Offset	Max. Tune-up Power (dBm)	Measured Conducted Power (dBm)	Scaling Factor	Power Drift (dB)	Measured SAR-10g (W/kg)	Scaled SAR-10g (W/kg)
	LTE 2	QPSK20M	Front Face	18900	1	0	23.00	22.87	1.03	0.04	0.081	0.08
	LTE 2	QPSK20M	Rear Face	18900	1	0	23.00	22.87	1.03	0.19	2.35	2.42
	LTE 2	QPSK20M	Left Side	18900	1	0	23.00	22.87	1.03	0.04	0.233	0.24
	LTE 2	QPSK20M	Right Side	18900	1	0	23.00	22.87	1.03	-0.1	0.241	0.25
	LTE 2	QPSK20M	Top Side	18900	1	0	23.00	22.87	1.03	0.09	1.03	1.06
	LTE 2	QPSK20M	Bottom Side	18900	1	0	23.00	22.87	1.03	-0.05	0.026	0.03
	LTE 2	QPSK20M	Front Face	18900	50	0	22.00	21.62	1.09	-0.11	0.064	0.07
	LTE 2	QPSK20M	Rear Face	18900	50	0	22.00	21.62	1.09	-0.18	1.82	1.98
	LTE 2	QPSK20M	Left Side	18900	50	0	22.00	21.62	1.09	0.11	0.155	0.17
	LTE 2	QPSK20M	Right Side	18900	50	0	22.00	21.62	1.09	-0.01	0.198	0.22
	LTE 2	QPSK20M	Top Side	18900	50	0	22.00	21.62	1.09	0.19	0.817	0.89
	LTE 2	QPSK20M	Bottom Side	18900	50	0	22.00	21.62	1.09	0	<0.001	0.00
	LTE 2	QPSK20M	Rear Face	18700	1	0	23.00	22.50	1.12	-0.06	2.29	2.56
03	LTE 2	QPSK20M	Rear Face	19100	1	0	23.00	22.81	1.04	-0.07	2.53	2.63
	LTE 2	QPSK20M	Rear Face	18900	100	0	22.00	21.61	1.09	0.08	1.94	2.11
	LTE 2	QPSK20M	Rear Face	19100	1	0	23.00	22.81	1.04	-0.07	2.48	2.58

Note: The "< 0.001" means there is no SAR value or the SAR is too low to be measured.



SAR Test Report

Plot No.	Band	Mode	Test Position	Ch.	RB#	RB Offset	Max. Tune-up Power (dBm)	Measured Conducted Power (dBm)	Scaling Factor	Power Drift (dB)	Measured SAR-10g (W/kg)	Scaled SAR-10g (W/kg)
	LTE 4	QPSK20M	Front Face	20300	1	0	23.00	22.99	1.00	0.02	0.056	0.06
	LTE 4	QPSK20M	Rear Face	20300	1	0	23.00	22.99	1.00	-0.13	2.59	2.59
	LTE 4	QPSK20M	Left Side	20300	1	0	23.00	22.99	1.00	-0.18	0.091	0.09
	LTE 4	QPSK20M	Right Side	20300	1	0	23.00	22.99	1.00	-0.1	0.121	0.12
	LTE 4	QPSK20M	Top Side	20300	1	0	23.00	22.99	1.00	0.09	0.91	0.91
	LTE 4	QPSK20M	Bottom Side	20300	1	0	23.00	22.99	1.00	0	<0.001	0.00
	LTE 4	QPSK20M	Front Face	20300	50	0	22.00	21.98	1.00	0.11	0.045	0.05
	LTE 4	QPSK20M	Rear Face	20300	50	0	22.00	21.98	1.00	0.08	1.91	1.91
	LTE 4	QPSK20M	Left Side	20300	50	0	22.00	21.98	1.00	0	0.075	0.08
	LTE 4	QPSK20M	Right Side	20300	50	0	22.00	21.98	1.00	-0.18	0.098	0.10
	LTE 4	QPSK20M	Top Side	20300	50	0	22.00	21.98	1.00	0.08	0.633	0.63
	LTE 4	QPSK20M	Bottom Side	20300	50	0	22.00	21.98	1.00	0	<0.001	0.00
04	LTE 4	QPSK20M	Rear Face	20050	1	0	23.00	22.63	1.09	0.05	2.8	3.05
	LTE 4	QPSK20M	Rear Face	20175	1	0	23.00	22.80	1.05	-0.02	2.74	2.88
	LTE 4	QPSK20M	Rear Face	20300	100	0	22.00	21.89	1.03	-0.19	1.99	2.05
	LTE 4	QPSK20M	Rear Face	20050	1	0	23.00	22.63	1.09	0.05	2.77	3.02
	LTE 12	QPSK10M	Front Face	23130	1	0	23.50	23.40	1.02	-0.1	0.282	0.29
	LTE 12	QPSK10M	Rear Face	23130	1	0	23.50	23.40	1.02	0.12	0.385	0.39
	LTE 12	QPSK10M	Left Side	23130	1	0	23.50	23.40	1.02	0.19	0.373	0.38
	LTE 12	QPSK10M	Right Side	23130	1	0	23.50	23.40	1.02	-0.09	0.732	0.75
	LTE 12	QPSK10M	Top Side	23130	1	0	23.50	23.40	1.02	-0.18	0.21	0.21
	LTE 12	QPSK10M	Bottom Side	23130	1	0	23.50	23.40	1.02	0	<0.001	0.00
	LTE 12	QPSK10M	Front Face	23130	25	0	22.50	22.10	1.10	0.01	0.203	0.22
	LTE 12	QPSK10M	Rear Face	23130	25	0	22.50	22.10	1.10	-0.06	0.312	0.34
	LTE 12	QPSK10M	Left Side	23130	25	0	22.50	22.10	1.10	0.12	0.291	0.32
	LTE 12	QPSK10M	Right Side	23130	25	0	22.50	22.10	1.10	-0.05	0.564	0.62
	LTE 12	QPSK10M	Top Side	23130	25	0	22.50	22.10	1.10	0.05	0.161	0.18
	LTE 12	QPSK10M	Bottom Side	23130	25	0	22.50	22.10	1.10	0	<0.001	0.00
05	LTE 12	QPSK10M	Right Side	23060	1	0	23.50	23.17	1.08	-0.05	0.735	0.79
	LTE 12	QPSK10M	Right Side	23095	1	0	23.50	23.37	1.03	-0.16	0.7	0.72

Note: The "< 0.001" means there is no SAR value or the SAR is too low to be measured.

Plot No.	Band	Mode	Test Position	Ch.	Duty Cycle	Crest Factor	Max. Tune-up Power (dBm)	Measured Conducted Power (dBm)	Scaling Factor	Power Drift (dB)	Measured SAR-10g (W/kg)	Scaled SAR-10g (W/kg)
	WLAN2.4G	802.11b	Front Face	1	99.00	1.01	21.50	21.40	1.02	0.05	0.112	0.12
	WLAN2.4G	802.11b	Rear Face	1	99.00	1.01	21.50	21.40	1.02	0.06	0.381	0.39
	WLAN2.4G	802.11b	Left Side	1	99.00	1.01	21.50	21.40	1.02	0.02	0.206	0.21
06	WLAN2.4G	802.11b	Right Side	1	99.00	1.01	21.50	21.40	1.02	-0.10	2.1	2.16
	WLAN2.4G	802.11b	Top Side	1	99.00	1.01	21.50	21.40	1.02	0.11	0.425	0.44
	WLAN2.4G	802.11b	Bottom Side	1	99.00	1.01	21.50	21.40	1.02	0	<0.001	0.00
	WLAN2.4G	802.11b	Right Side	6	99.00	1.01	21.00	20.61	1.09	0.11	1.12	1.23
	WLAN2.4G	802.11b	Right Side	11	99.00	1.01	18.50	18.24	1.06	0.12	0.75	0.80
	WLAN2.4G	802.11b	Right Side	1	99.00	1.01	21.50	21.40	1.02	-0.1	1.99	2.05
	WLAN5.3G	802.11a	Front Face	60	90.10	1.11	17.00	16.80	1.05	0.05	0.049	0.06
	WLAN5.3G	802.11a	Rear Face	60	90.10	1.11	17.00	16.80	1.05	0.11	0.051	0.06
	WLAN5.3G	802.11a	Left Side	60	90.10	1.11	17.00	16.80	1.05	0.12	0.015	0.02
	WLAN5.3G	802.11a	Right Side	60	90.10	1.11	17.00	16.80	1.05	0.03	0.196	0.23
07	WLAN5.3G	802.11a	Top Side	60	90.10	1.11	17.00	16.80	1.05	-0.07	0.282	0.33
	WLAN5.3G	802.11a	Bottom Side	60	90.10	1.11	17.00	16.80	1.05	0	<0.001	0.00
	WLAN5.3G	802.11a	Top Side	52	90.10	1.11	16.50	16.12	1.09	0.02	0.111	0.13
	WLAN5.3G	802.11a	Top Side	56	90.10	1.11	16.00	15.53	1.11	0.03	0.105	0.13
	WLAN5.3G	802.11a	Top Side	64	90.10	1.11	16.00	15.41	1.15	0.02	0.098	0.13

Note: The "< 0.001" means there is no SAR value or the SAR is too low to be measured.

SAR Test Report

Plot No.	Band	Mode	Test Position	Ch.	Duty Cycle	Crest Factor	Max. Tune-up Power (dBm)	Measured Conducted Power (dBm)	Scaling Factor	Power Drift (dB)	Measured SAR-10g (W/kg)	Scaled SAR-10g (W/kg)
	WLAN5.6G	802.11n HT40	Front Face	110	78.00	1.28	15.50	15.40	1.02	0.12	0.016	0.02
	WLAN5.6G	802.11n HT40	Rear Face	110	78.00	1.28	15.50	15.40	1.02	0.05	0.041	0.05
	WLAN5.6G	802.11n HT40	Left Side	110	78.00	1.28	15.50	15.40	1.02	0.06	0.00495	0.01
	WLAN5.6G	802.11n HT40	Right Side	110	78.00	1.28	15.50	15.40	1.02	0.02	0.121	0.16
	WLAN5.6G	802.11n HT40	Top Side	110	78.00	1.28	15.50	15.40	1.02	0.17	0.082	0.11
	WLAN5.6G	802.11n HT40	Bottom Side	110	78.00	1.28	15.50	15.40	1.02	0	<0.001	0.00
	WLAN5.6G	802.11n HT40	Right Side	102	78.00	1.28	12.50	12.24	1.06	0.12	0.058	0.08
	WLAN5.6G	802.11n HT40	Right Side	118	78.00	1.28	15.50	15.35	1.04	0.05	0.118	0.16
	WLAN5.6G	802.11n HT40	Right Side	126	78.00	1.28	15.50	15.32	1.04	0.05	0.130	0.17
08	WLAN5.6G	802.11n HT40	Right Side	134	78.00	1.28	14.00	13.80	1.05	0.04	0.133	0.18
	WLAN5.6G	802.11n HT40	Right Side	142	78.00	1.28	13.00	12.92	1.02	0.02	0.111	0.14
	WLAN5.8G	802.11n HT40	Front Face	151	78.00	1.28	14.50	14.40	1.02	0.11	0.034	0.04
	WLAN5.8G	802.11n HT40	Rear Face	151	78.00	1.28	14.50	14.40	1.02	0.05	0.216	0.28
	WLAN5.8G	802.11n HT40	Left Side	151	78.00	1.28	14.50	14.40	1.02	0.06	0.017	0.02
09	WLAN5.8G	802.11n HT40	Right Side	151	78.00	1.28	14.50	14.40	1.02	0.02	0.354	0.46
	WLAN5.8G	802.11n HT40	Top Side	151	78.00	1.28	14.50	14.40	1.02	0.1	0.299	0.39
	WLAN5.8G	802.11n HT40	Bottom Side	151	78.00	1.28	14.50	14.40	1.02	0	<0.001	0.00
	WLAN5.8G	802.11n HT40	Right Side	159	78.00	1.28	14.50	14.10	1.10	0.1	0.278	0.39
	BT	BDR	Front Face	78	79.89	1.25	12.00	11.86	1.03	0	<0.001	0.00
	BT	BDR	Rear Face	78	79.89	1.25	12.00	11.86	1.03	0.11	0.022	0.03
	BT	BDR	Left Side	78	79.89	1.25	12.00	11.86	1.03	0	<0.001	0.00
	BT	BDR	Right Side	78	79.89	1.25	12.00	11.86	1.03	0.05	0.099	0.13
	BT	BDR	Top Side	78	79.89	1.25	12.00	11.86	1.03	0.1	0.019	0.02
	BT	BDR	Bottom Side	78	79.89	1.25	12.00	11.86	1.03	0	<0.001	0.00
10	BT	BDR	Right Side	0	79.89	1.25	12.00	11.55	1.11	-0.06	0.121	0.17
	BT	BDR	Right Side	39	79.89	1.25	12.00	11.69	1.07	0.05	0.084	0.11

Note: The "< 0.001" means there is no SAR value or the SAR is too low to be measured.

4.7.3 SAR Measurement Variability

According to KDB 865664 D01, SAR measurement variability was assessed for each frequency band, which is determined by the SAR probe calibration point and tissue-equivalent medium used for the device measurements. When both head and body tissue-equivalent media are required for SAR measurements in a frequency band, the variability measurement procedures should be applied to the tissue medium with the highest measured SAR, using the highest measured SAR configuration for that tissue-equivalent medium. Alternatively, if the highest measured SAR for both head and body tissue-equivalent media are ≤ 1.45 W/kg and the ratio of these highest SAR values, i.e., largest divided by smallest value, is ≤ 1.10 , the highest SAR configuration for either head or body tissue-equivalent medium may be used to perform the repeated measurement. These additional measurements are repeated after the completion of all measurements requiring the same head or body tissue-equivalent medium in a frequency band. The test device should be returned to ambient conditions (normal room temperature) with the battery fully charged before it is re-mounted on the device holder for the repeated measurement(s) to minimize any unexpected variations in the repeated results.

SAR repeated measurement procedure:

1. When the highest measured SAR is < 0.80 W/kg, repeated measurement is not required.
2. When the highest measured SAR is ≥ 0.80 W/kg, repeat that measurement once.
3. If the ratio of largest to smallest SAR for the original and first repeated measurements is > 1.20 , or when the original or repeated measurement is ≥ 1.45 W/kg, perform a second repeated measurement.
4. If the ratio of largest to smallest SAR for the original, first and second repeated measurements is > 1.20 , and the original, first or second repeated measurement is ≥ 1.5 W/kg, perform a third repeated measurement.
5. The same procedures should be adapted for measurements according to extremity and occupational exposure limits by applying a factor of 2.5 for extremity exposure and a factor of 5 for occupational exposure to the corresponding SAR thresholds.

Band	Test Position	Ch.	Original Measured SAR-10g (W/kg)	1st Repeated SAR-10g (W/kg)	L/S Ratio	2nd Repeated SAR-1g (W/kg)	L/S Ratio	3rd Repeated SAR-1g (W/kg)	L/S Ratio
WCDMA II	Rear Face	9538	2.36	2.33	1.01	N/A	N/A	N/A	N/A
LTE 2	Rear Face	19100	2.53	2.48	1.02	N/A	N/A	N/A	N/A
LTE 4	Rear Face	20050	2.80	2.77	1.01	N/A	N/A	N/A	N/A
WLAN2.4G	Right Side	1	2.1	1.99	1.06	N/A	N/A	N/A	N/A

SAR Test Report

4.7.4 Simultaneous Multi-band Transmission Evaluation

<Possibilities of Simultaneous Transmission>

The simultaneous transmission possibilities for this device are listed as below.

Simultaneous TX Combination	Capable Transmit Configurations	Body Exposure Condition
1	WWAN + BT	Yes

<SAR Summation Analysis>

Simultaneous transmission SAR test exclusion is determined for each operating configuration and exposure condition according to the reported standalone SAR of each applicable simultaneous transmitting antenna. When the sum of SAR_{1g} of all simultaneously transmitting antennas in an operating mode and exposure condition combination is within the SAR limit(SAR_{1g} 1.6 W/kg), the simultaneous transmission SAR is not required. When the sum of SAR_{1g} is greater than the SAR limit (SAR_{1g} 1.6 W/kg), SAR test exclusion is determined by the SPLSR.

No.	TX Conditions	Exposure Condition	Test Position	Max. WWAN SAR	Max. BT SAR	SAR Summation	SPLSR Analysis
1	WCDMA II + BT(DSS)	Extremity	Front Face	0.09	0.00	0.09	∑ SAR < 4.0, Not required
			Rear Face	2.53	0.03	2.56	∑ SAR < 4.0, Not required
			Left Side	0.19	0.00	0.19	∑ SAR < 4.0, Not required
			Right Side	0.26	0.17	0.43	∑ SAR < 4.0, Not required
			Top Side	0.99	0.02	1.01	∑ SAR < 4.0, Not required
			Bottom Side	0.00	0.00	0.00	∑ SAR < 4.0, Not required
2	WCDMA V + BT(DSS)	Extremity	Front Face	0.11	0.00	0.11	∑ SAR < 4.0, Not required
			Rear Face	0.55	0.03	0.58	∑ SAR < 4.0, Not required
			Left Side	0.16	0.00	0.16	∑ SAR < 4.0, Not required
			Right Side	0.13	0.17	0.30	∑ SAR < 4.0, Not required
			Top Side	0.25	0.02	0.27	∑ SAR < 4.0, Not required
			Bottom Side	0.00	0.00	0.00	∑ SAR < 4.0, Not required

SAR Test Report

No.	TX Conditions	Exposure Condition	Test Position	Max. WWAN SAR	Max. BT SAR	SAR Summation	SPLSR Analysis
3	LTE 2 + BT(DSS)	Extremity	Front Face	0.08	0.00	0.08	Σ SAR < 4.0, Not required
			Rear Face	2.63	0.03	2.66	Σ SAR < 4.0, Not required
			Left Side	0.24	0.00	0.24	Σ SAR < 4.0, Not required
			Right Side	0.25	0.17	0.42	Σ SAR < 4.0, Not required
			Top Side	1.06	0.02	1.08	Σ SAR < 4.0, Not required
			Bottom Side	0.03	0.00	0.03	Σ SAR < 4.0, Not required
4	LTE 4 + BT(DSS)	Extremity	Front Face	0.06	0.00	0.06	Σ SAR < 4.0, Not required
			Rear Face	3.05	0.03	3.08	Σ SAR < 4.0, Not required
			Left Side	0.09	0.00	0.09	Σ SAR < 4.0, Not required
			Right Side	0.12	0.17	0.29	Σ SAR < 4.0, Not required
			Top Side	0.91	0.02	0.93	Σ SAR < 4.0, Not required
			Bottom Side	0.00	0.00	0.00	Σ SAR < 4.0, Not required
5	LTE 12 + BT(DSS)	Extremity	Front Face	0.29	0.00	0.29	Σ SAR < 4.0, Not required
			Rear Face	0.39	0.03	0.42	Σ SAR < 4.0, Not required
			Left Side	0.38	0.00	0.38	Σ SAR < 4.0, Not required
			Right Side	0.79	0.17	0.96	Σ SAR < 4.0, Not required
			Top Side	0.21	0.02	0.23	Σ SAR < 4.0, Not required
			Bottom Side	0.00	0.00	0.00	Σ SAR < 4.0, Not required

Test Engineer : Mars Chang, and Rex Tseng

5. Calibration of Test Equipment

Equipment	Manufacturer	Model	SN	Cal. Date	Cal. Interval
System Validation Dipole	SPEAG	D750V3	1013	Aug. 23, 2019	1 Year
System Validation Dipole	SPEAG	D835V2	4d121	Aug. 23, 2019	1 Year
System Validation Dipole	SPEAG	D1750V2	1055	Aug. 23, 2019	1 Year
System Validation Dipole	SPEAG	D1900V2	5d036	Jan. 21, 2020	1 Year
System Validation Dipole	SPEAG	D2450V2	737	Aug. 26, 2019	1 Year
System Validation Dipole	SPEAG	D5GHzV2	1019	Mar. 13, 2020	1 Year
Dosimetric E-Field Probe	SPEAG	EX3DV4	3971	Jan. 27, 2020	1 Year
Dosimetric E-Field Probe	SPEAG	EX3DV4	3650	Mar. 25, 2020	1 Year
Data Acquisition Electronics	SPEAG	DAE4	1277	Jan. 24, 2020	1 Year
Data Acquisition Electronics	SPEAG	DAE4	861	May 27, 2020	1 Year
Universal Radio Communication Tester	Anritsu	MT8821C	6261786083	Jun. 27, 2019	1 Year
Spectrum Analyzer	R&S	FSL6	102006	Mar. 26, 2020	1 Year
Universal Wireless Test Set	Anritsu	MT8870A/MU8 87000A	6201699387	Oct. 07, 2019	1 Year
Thermometer	YFE	YF-160A	120702365	Aug. 06, 2019	1 Year
Dielectric Assessment Kit	SPEAG	DAKS-3.5	0004	Jun. 25, 2019	1 Year
Powersource1	SPEAG	SE_UMS_160 BA	4010	Aug. 21, 2019	1 Year

6. Measurement Uncertainty

According to KDB 865664 D01, SAR measurement uncertainty analysis is required in SAR reports only when the highest measured SAR in a frequency band is ≥ 1.5 W/kg for 1-g SAR, and ≥ 3.75 W/kg for 10-g SAR. The procedures described in IEEE Std 1528-2013 should be applied. The expanded SAR measurement uncertainty must be $\leq 30\%$, for a confidence interval of $k = 2$. When the highest measured SAR within a frequency band is < 1.5 W/kg for 1-g and < 3.75 W/kg for 10-g, the extensive SAR measurement uncertainty analysis described in IEEE Std 1528-2013 is not required in SAR reports submitted for equipment approval. Hence, the measurement uncertainty analysis is not required in this SAR report because the test result met the condition.

7. Information of the Testing Laboratories

We, Bureau Veritas Consumer Products Services (H.K.) Ltd., Taoyuan Branch, were founded in 1988 to provide our best service in EMC, Radio, Telecom and Safety consultation. Our laboratories are accredited and approved according to ISO/IEC 17025.

If you have any comments, please feel free to contact us at the following:

Taiwan Huaya Lab:

Add: No. 19, Huaya 2nd Rd., Guishan Dist., Taoyuan City 333, Taiwan

Tel: +886-(0)3-318-3232

Fax: +886-(0)3-211-5834

Taiwan Linkou Lab:

Add: No. 47-2, Baodoucuokeng, Linkou Dist., New Taipei City 244, Taiwan

Tel: +886-(0)2-2605-2180

Fax: +886-(0)2-2605-2943

Taiwan Hsinchu Lab1:

Add: E-2, No. 1, Lixing 1st Rd., East Dist., Hsinchu City 300, Taiwan

Tel: +886-(0)3-666-8565

Fax: +886-(0)3-666-8323

Taiwan Hsinchu Lab2:

Add: No. 49, Ln. 206, Wende Rd., Qionglin Township, Hsinchu County 307, Taiwan

Tel: +886-(0)3-512-0595

Fax: +886-(0)3-512-0568

Taiwan Xindian Lab:

Add: B2F., No. 215, Sec. 3, Beixin Rd., Xindian Dist., New Taipei City 231, Taiwan

Tel: +886-(0)2-8914-5882

Fax: +886-(0)2-8914-5840

Email: service.adt@tw.bureauveritas.com

Web Site: <https://ee.bureauveritas.com.tw/BVInternet/Default>

The road map of all our labs can be found in our web site also.

---END---

Appendix A. SAR Plots of System Verification

The plots for system verification with largest deviation for each SAR system combination are shown as follows.

System Check_H750_200612

DUT: Dipole 750 MHz; Type: D750V3; SN: 1013

Communication System: UID 0, CW; Frequency: 750 MHz; Duty Cycle: 1:1

Medium: H06T09N1_0612 Medium parameters used: $f = 750$ MHz; $\sigma = 0.892$ S/m; $\epsilon_r = 42.971$; $\rho = 1000$ kg/m³

Ambient Temperature : 23.2 °C ; Liquid Temperature : 23.1 °C

DASY5 Configuration:

- Probe: EX3DV4 - SN3971; ConvF(10.6, 10.6, 10.6) @ 750 MHz; Calibrated: 2020/01/27
- Sensor-Surface: 1.4mm (Mechanical Surface Detection)
- Electronics: DAE4 Sn1277; Calibrated: 2020/01/24
- Phantom: Twin SAM Phantom_1496; Type: QD000P40CB;
- Measurement SW: DASY52, Version 52.10 (4); SEMCAD X Version 14.6.14 (7483)

Pin=50mW/Area Scan (61x81x1): Interpolated grid: dx=1.500 mm, dy=1.500 mm

Maximum value of SAR (interpolated) = 0.515 W/kg

Pin=50mW/Zoom Scan (5x5x7)/Cube 0: Measurement grid: dx=8mm, dy=8mm, dz=5mm

Reference Value = 25.38 V/m; Power Drift = 0.04 dB

Peak SAR (extrapolated) = 0.736 W/kg

SAR(1 g) = 0.401 W/kg; SAR(10 g) = 0.270 W/kg (SAR corrected for target medium)

Maximum value of SAR (measured) = 0.736 W/kg

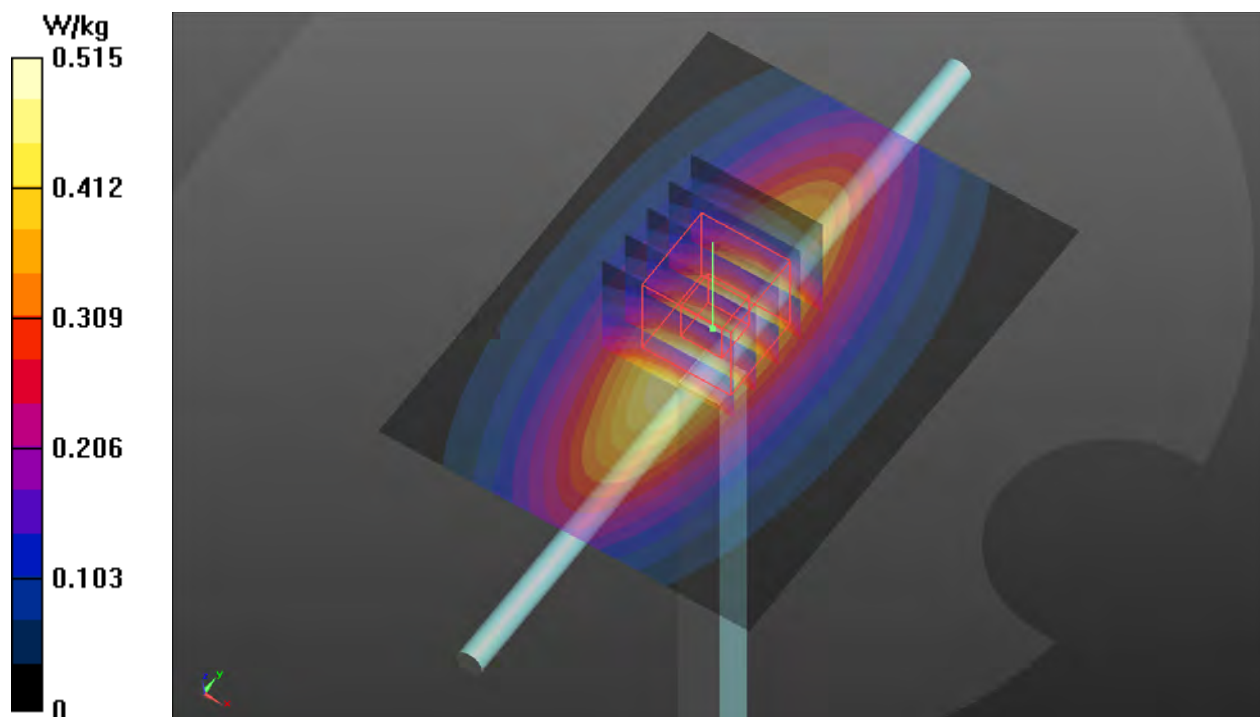

System Check_H835_200612

DUT: Dipole 835 MHz; Type: D835V2; SN: 4d121

Communication System: UID 0, CW; Frequency: 835 MHz; Duty Cycle: 1:1

Medium: H07T10N1_0612 Medium parameters used: $f = 835 \text{ MHz}$; $\sigma = 0.925 \text{ S/m}$; $\epsilon_r = 42.519$; $\rho = 1000 \text{ kg/m}^3$

Ambient Temperature : $23.2 \text{ }^\circ\text{C}$; Liquid Temperature : $23.1 \text{ }^\circ\text{C}$

DASY5 Configuration:

- Probe: EX3DV4 - SN3971; ConvF(10.26, 10.26, 10.26) @ 835 MHz; Calibrated: 2020/01/27
- Sensor-Surface: 1.4mm (Mechanical Surface Detection)
- Electronics: DAE4 Sn1277; Calibrated: 2020/01/24
- Phantom: Twin SAM Phantom_1496; Type: QD000P40CB;
- Measurement SW: DASY52, Version 52.10 (4); SEMCAD X Version 14.6.14 (7483)

Pin=50mW/Area Scan (61x61x1): Interpolated grid: $dx=1.500 \text{ mm}$, $dy=1.500 \text{ mm}$

Maximum value of SAR (interpolated) = 0.661 W/kg

Pin=50mW/Zoom Scan (5x5x7)/Cube 0: Measurement grid: $dx=8\text{mm}$, $dy=8\text{mm}$, $dz=5\text{mm}$

Reference Value = 28.33 V/m ; Power Drift = 0.03 dB

Peak SAR (extrapolated) = 0.748 W/kg

SAR(1 g) = 0.501 W/kg ; SAR(10 g) = 0.326 W/kg (SAR corrected for target medium)

Maximum value of SAR (measured) = 0.675 W/kg

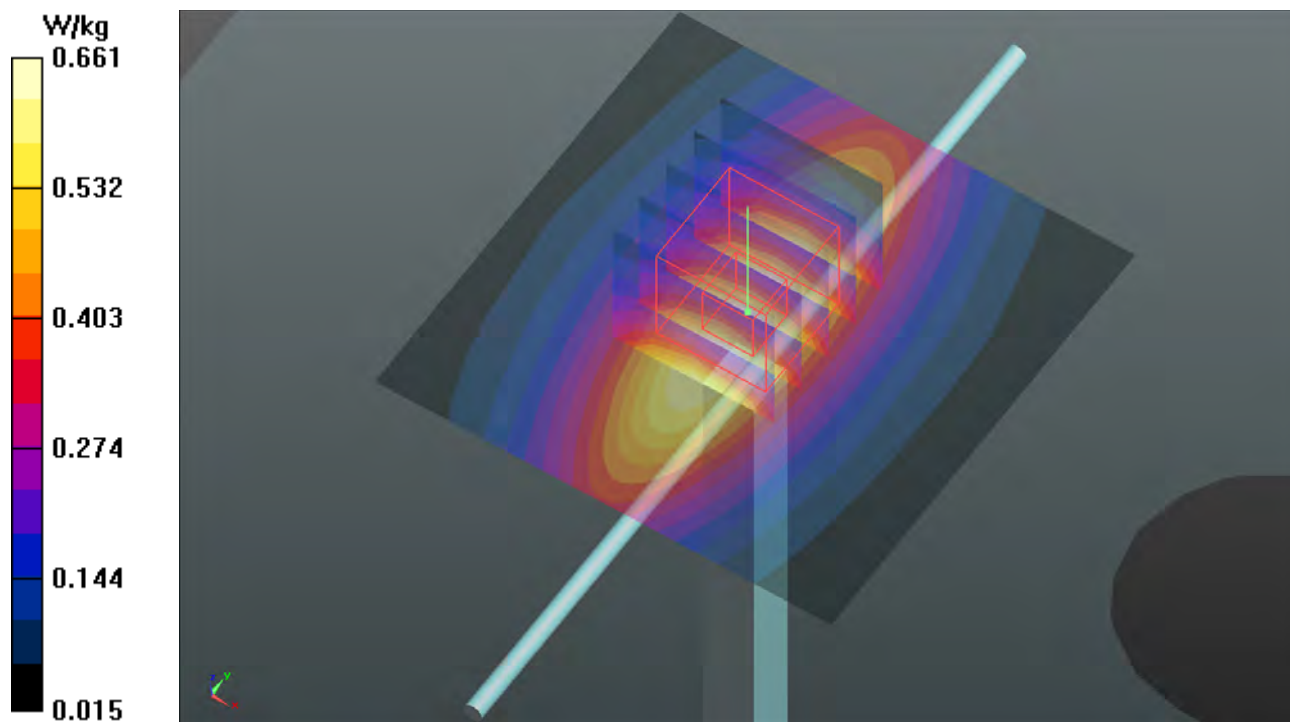

System Check_H1750_200612

DUT: Dipole 1750 MHz; Type: D1750V2; SN: 1055

Communication System: UID 0, CW; Frequency: 1750 MHz; Duty Cycle: 1:1

Medium: H16T20N1_0612 Medium parameters used: $f = 1750$ MHz; $\sigma = 1.323$ S/m; $\epsilon_r = 39.8$; $\rho = 1000$ kg/m³

Ambient Temperature : 23.2 °C ; Liquid Temperature : 23.1 °C

DASY5 Configuration:

- Probe: EX3DV4 - SN3971; ConvF(8.73, 8.73, 8.73) @ 1750 MHz; Calibrated: 2020/01/27
- Sensor-Surface: 1.4mm (Mechanical Surface Detection)
- Electronics: DAE4 Sn1277; Calibrated: 2020/01/24
- Phantom: Twin SAM Phantom_1496; Type: QD000P40CB;
- Measurement SW: DASY52, Version 52.10 (4); SEMCAD X Version 14.6.14 (7483)

Pin=50mW/Area Scan (61x61x1): Interpolated grid: dx=1.500 mm, dy=1.500 mm

Maximum value of SAR (interpolated) = 2.77 W/kg

Pin=50mW/Zoom Scan (5x5x7)/Cube 0: Measurement grid: dx=8mm, dy=8mm, dz=5mm

Reference Value = 47.44 V/m; Power Drift = -0.03 dB

Peak SAR (extrapolated) = 4.04 W/kg

SAR(1 g) = 1.91 W/kg; SAR(10 g) = 1.03 W/kg (SAR corrected for target medium)

Maximum value of SAR (measured) = 2.90 W/kg

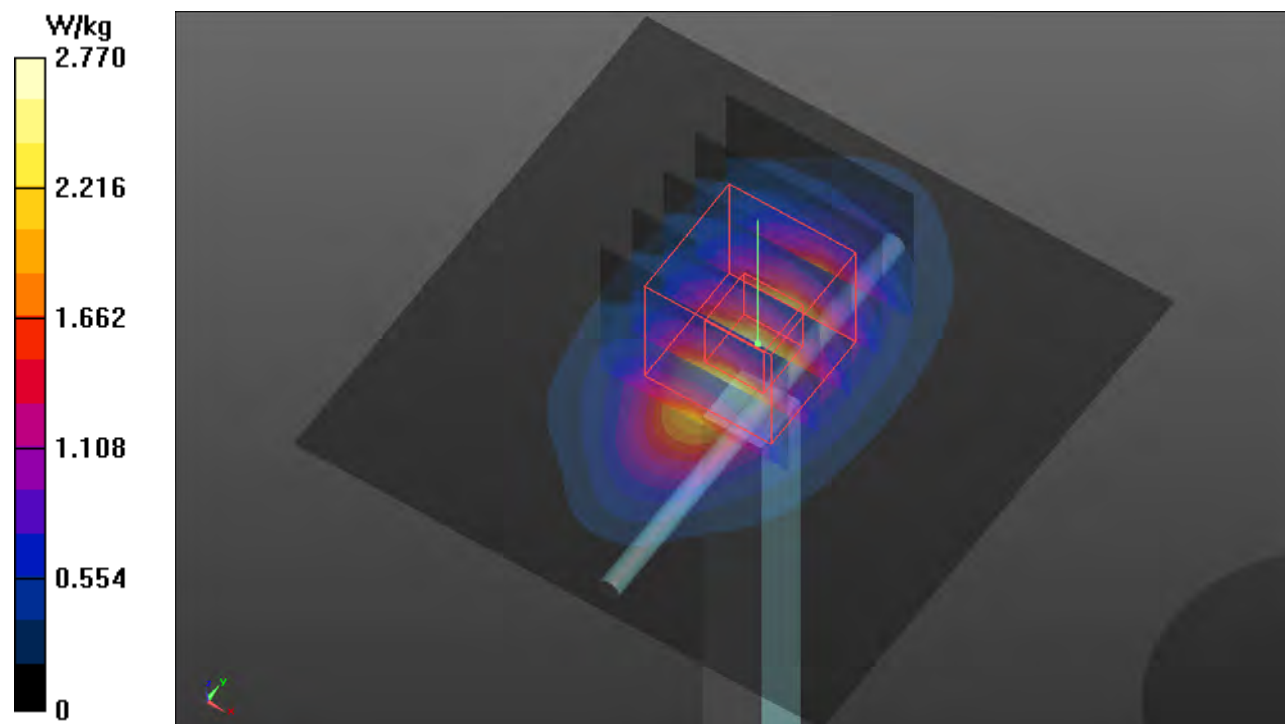

System Check_H1900_200612

DUT: Dipole 1900 MHz; Type: D1900V2; SN: 5d036

Communication System: UID 0, CW; Frequency: 1900 MHz; Duty Cycle: 1:1

Medium: H16T20N1_0612 Medium parameters used: $f = 1900$ MHz; $\sigma = 1.45$ S/m; $\epsilon_r = 39.259$; $\rho = 1000$ kg/m³

Ambient Temperature : 23.2 °C ; Liquid Temperature : 23.1 °C

DASY5 Configuration:

- Probe: EX3DV4 - SN3971; ConvF(8.54, 8.54, 8.54) @ 1900 MHz; Calibrated: 2020/01/27
- Sensor-Surface: 1.4mm (Mechanical Surface Detection)
- Electronics: DAE4 Sn1277; Calibrated: 2020/01/24
- Phantom: Twin SAM Phantom_1496; Type: QD000P40CB;
- Measurement SW: DASY52, Version 52.10 (4); SEMCAD X Version 14.6.14 (7483)

Pin=50mW/Area Scan (61x61x1): Interpolated grid: dx=1.500 mm, dy=1.500 mm

Maximum value of SAR (interpolated) = 3.15 W/kg

Pin=50mW/Zoom Scan (5x5x7)/Cube 0: Measurement grid: dx=8mm, dy=8mm, dz=5mm

Reference Value = 48.27 V/m; Power Drift = -0.04 dB

Peak SAR (extrapolated) = 10.1 W/kg

SAR(1 g) = 3.04 W/kg; SAR(10 g) = 1.13 W/kg (SAR corrected for target medium)

Maximum value of SAR (measured) = 8.68 W/kg

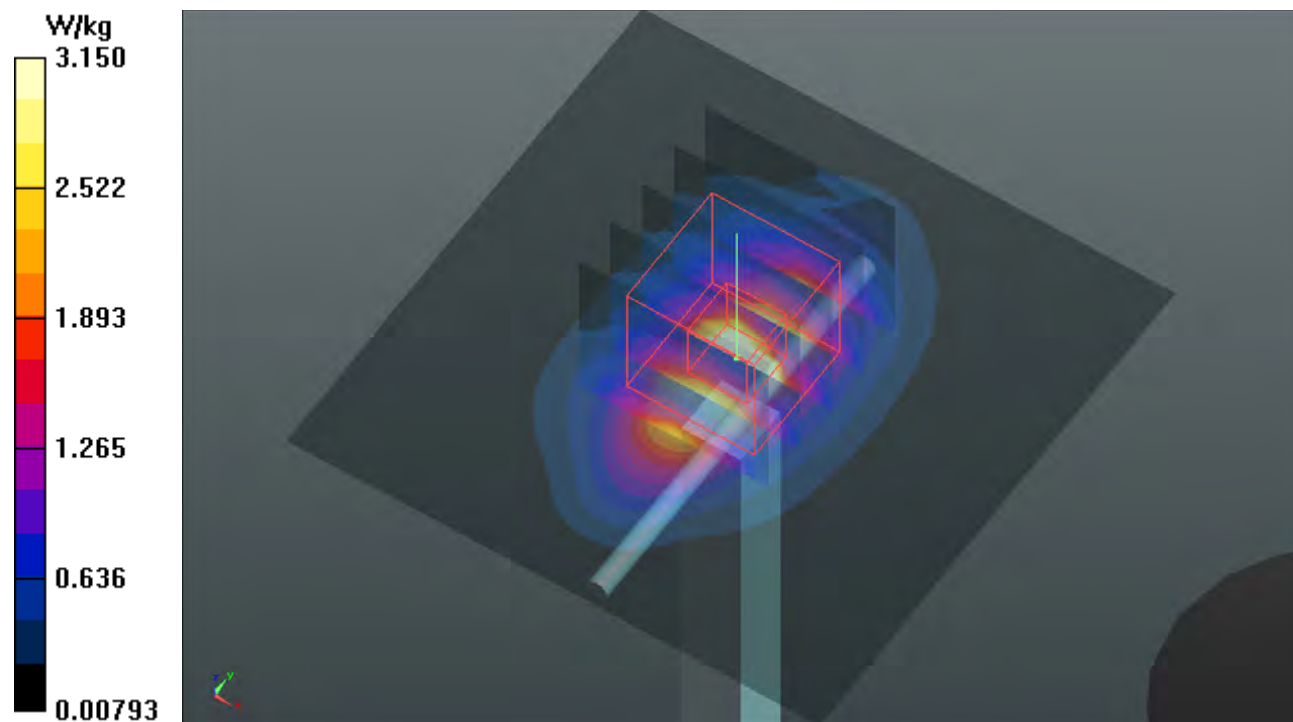

System Check_H2450_200615

DUT: Dipole 2450 MHz; Type: D2450V2; SN: 737

Communication System: UID 0, CW; Frequency: 2450 MHz; Duty Cycle: 1:1

Medium: H19T27N4_0615 Medium parameters used: $f = 2450$ MHz; $\sigma = 1.882$ S/m; $\epsilon_r = 38.248$; $\rho = 1000$ kg/m³

Ambient Temperature : 23.7 °C ; Liquid Temperature : 23.5 °C

DASY5 Configuration:

- Probe: EX3DV4 - SN3650; ConvF(7.75, 7.75, 7.75) @ 2450 MHz; Calibrated: 2020/01/27
- Sensor-Surface: 1.4mm (Mechanical Surface Detection)
- Electronics: DAE4 Sn861; Calibrated: 2020/05/27
- Phantom: Twin SAM Phantom_1823; Type: QD 000 P40 CD;
- Measurement SW: DASY52, Version 52.10 (4); SEMCAD X Version 14.6.14 (7483)

Pin=50mW/Area Scan (61x61x1): Interpolated grid: dx=1.200 mm, dy=1.200 mm

Maximum value of SAR (interpolated) = 4.96 W/kg

Pin=50mW/Zoom Scan (5x5x7)/Cube 0: Measurement grid: dx=8mm, dy=8mm, dz=5mm

Reference Value = 49.11 V/m; Power Drift = -0.05 dB

Peak SAR (extrapolated) = 5.19 W/kg

SAR(1 g) = 2.51 W/kg; SAR(10 g) = 1.2 W/kg (SAR corrected for target medium)

Maximum value of SAR (measured) = 4.27 W/kg

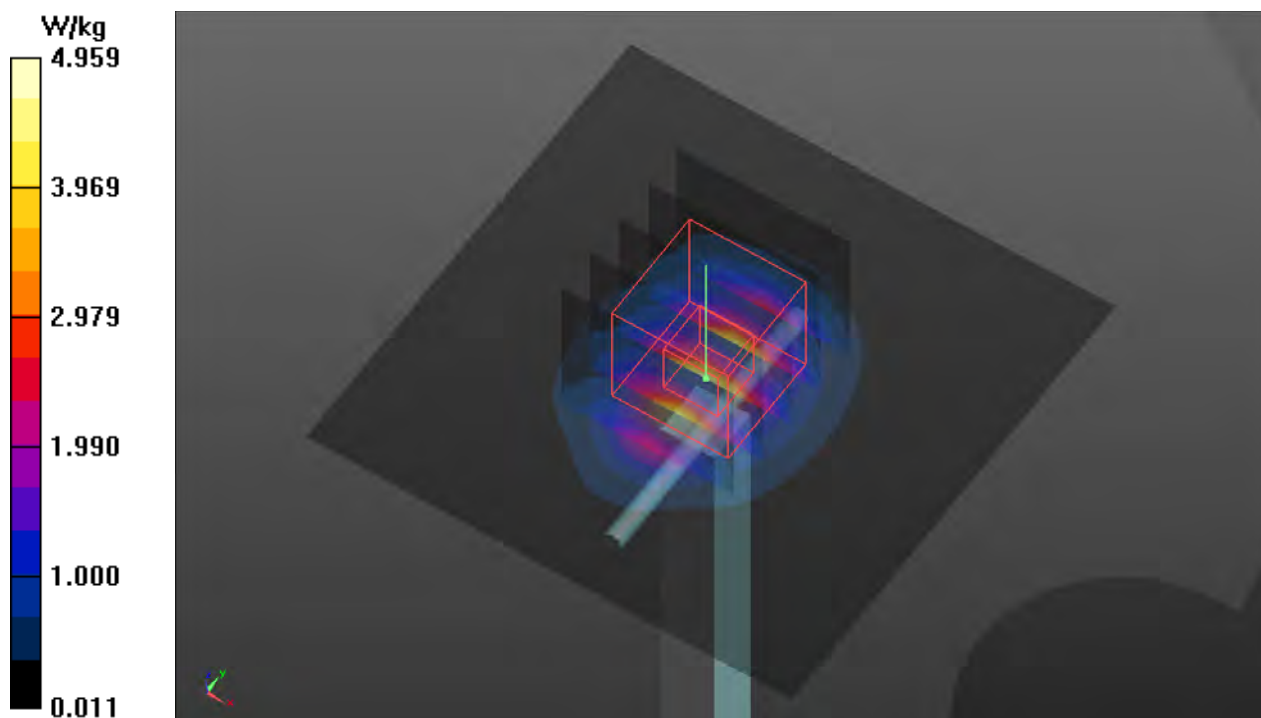

System Check_H5250_200615

DUT: Dipole 5 GHz; Type: D5GHzV2; SN: 1019

Communication System: UID 0, CW; Frequency: 5250 MHz; Duty Cycle: 1:1

Medium: H34T60N4_0615 Medium parameters used: $f = 5250$ MHz; $\sigma = 4.597$ S/m; $\epsilon_r = 36.617$; $\rho = 1000$ kg/m³

Ambient Temperature : 23.7 °C ; Liquid Temperature : 23.5 °C

DASY5 Configuration:

- Probe: EX3DV4 - SN3650; ConvF(5.39, 5.39, 5.39) @ 5250 MHz; Calibrated: 2020/01/27
- Sensor-Surface: 1.4mm (Mechanical Surface Detection)
- Electronics: DAE4 Sn861; Calibrated: 2020/05/27
- Phantom: Twin SAM Phantom_1823; Type: QD 000 P40 CD;
- Measurement SW: DASY52, Version 52.10 (4); SEMCAD X Version 14.6.14 (7483)

Pin=50mW/Area Scan (81x81x1): Interpolated grid: dx=1.200 mm, dy=1.200 mm

Maximum value of SAR (interpolated) = 9.62 W/kg

Pin=50mW/Zoom Scan (7x7x7)/Cube 0: Measurement grid: dx=4mm, dy=4mm, dz=1.4mm

Reference Value = 49.60 V/m; Power Drift = -0.11 dB

Peak SAR (extrapolated) = 15.1 W/kg

SAR(1 g) = 4.02 W/kg; SAR(10 g) = 1.17 W/kg (SAR corrected for target medium)

Maximum value of SAR (measured) = 9.79 W/kg

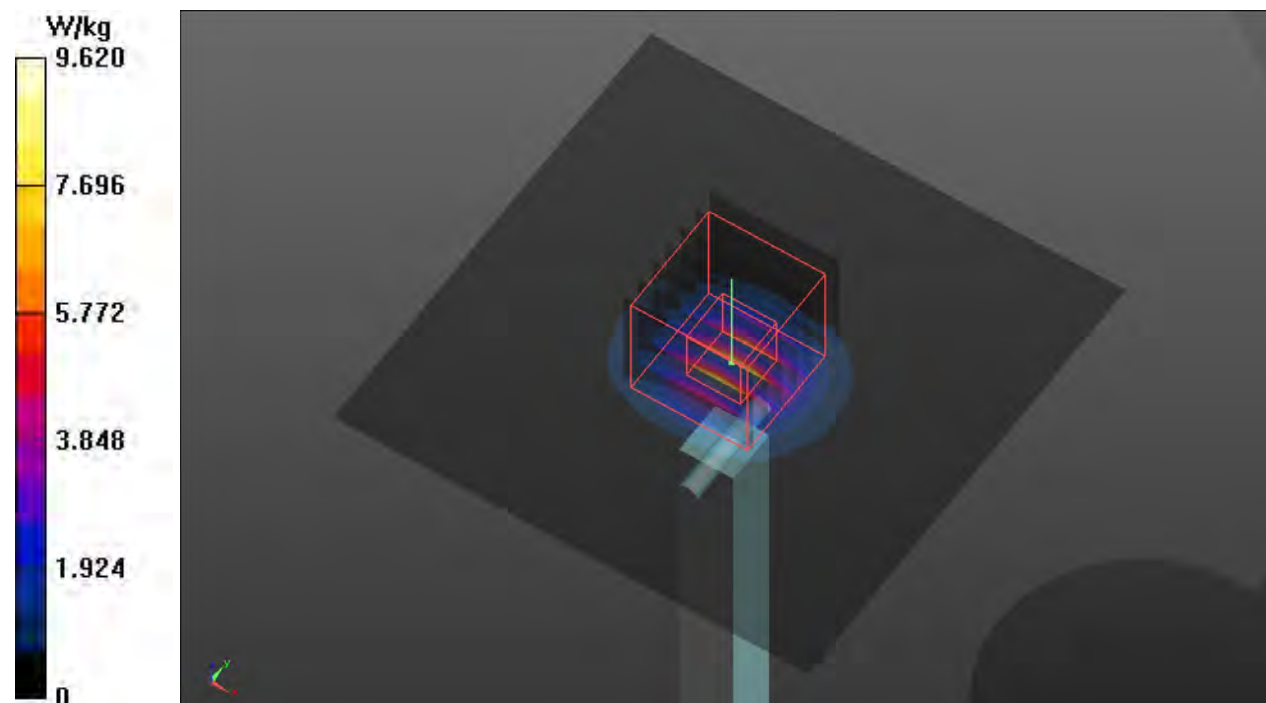

System Check_H5600_200615

DUT: Dipole 5 GHz; Type: D5GHzV2; SN: 1019

Communication System: UID 0, CW; Frequency: 5600 MHz; Duty Cycle: 1:1

Medium: H34T60N4_0615 Medium parameters used: $f = 5600$ MHz; $\sigma = 5.006$ S/m; $\epsilon_r = 36.08$; $\rho = 1000$ kg/m³

Ambient Temperature : 23.7 °C ; Liquid Temperature : 23.5 °C

DASY5 Configuration:

- Probe: EX3DV4 - SN3650; ConvF(4.88, 4.88, 4.88) @ 5600 MHz; Calibrated: 2020/01/27
- Sensor-Surface: 1.4mm (Mechanical Surface Detection)
- Electronics: DAE4 Sn861; Calibrated: 2020/05/27
- Phantom: Twin SAM Phantom_1823; Type: QD 000 P40 CD;
- Measurement SW: DASY52, Version 52.10 (4); SEMCAD X Version 14.6.14 (7483)

Pin=50mW/Area Scan (81x81x1): Interpolated grid: dx=1.000 mm, dy=1.000 mm

Maximum value of SAR (interpolated) = 10.7 W/kg

Pin=50mW/Zoom Scan (7x7x7)/Cube 0: Measurement grid: dx=4mm, dy=4mm, dz=1.4mm

Reference Value = 50.55 V/m; Power Drift = -0.11 dB

Peak SAR (extrapolated) = 18.7 W/kg

SAR(1 g) = 4.32 W/kg; SAR(10 g) = 1.23 W/kg (SAR corrected for target medium)

Maximum value of SAR (measured) = 11.2 W/kg

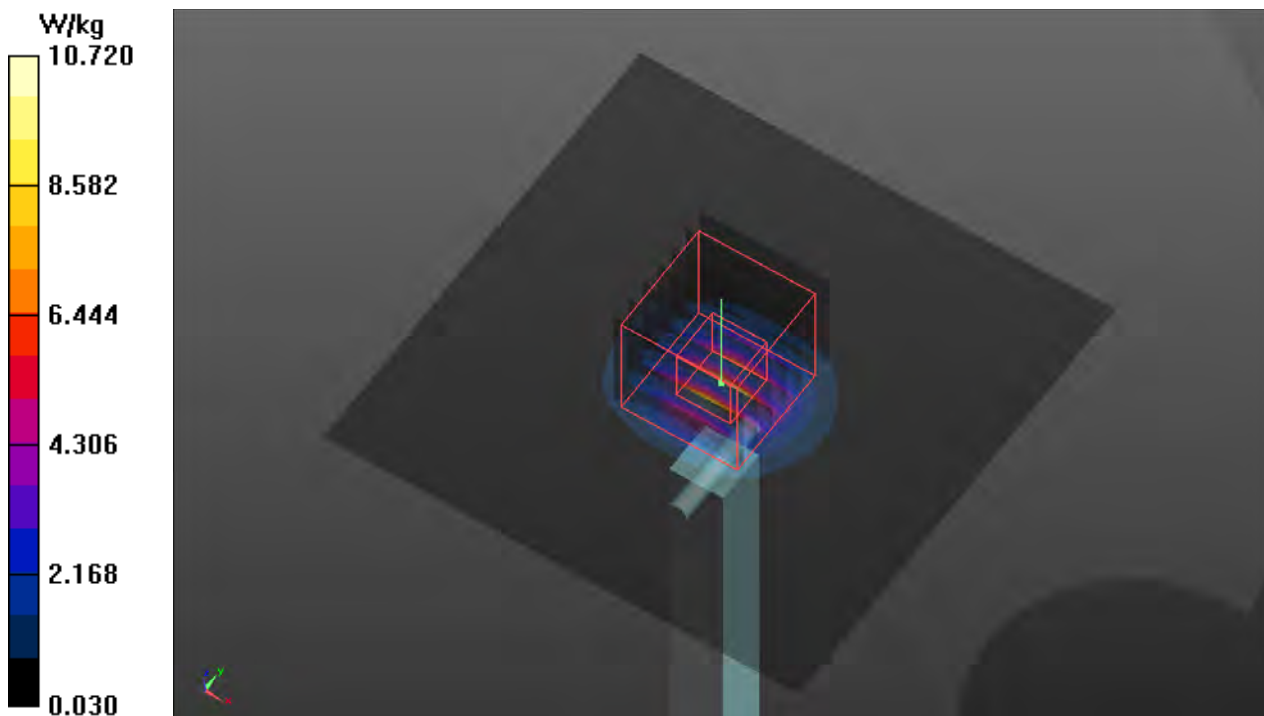

System Check_H5750_200615

DUT: Dipole 5 GHz; Type: D5GHzV2; SN: 1019

Communication System: UID 0, CW; Frequency: 5750 MHz; Duty Cycle: 1:1

Medium: H34T60N4_0615 Medium parameters used: $f = 5750$ MHz; $\sigma = 5.175$ S/m; $\epsilon_r = 35.814$; $\rho = 1000$ kg/m³

Ambient Temperature : 23.7 °C ; Liquid Temperature : 23.5 °C

DASY5 Configuration:

- Probe: EX3DV4 - SN3650; ConvF(5.1, 5.1, 5.1) @ 5750 MHz; Calibrated: 2020/01/27
- Sensor-Surface: 1.4mm (Mechanical Surface Detection)
- Electronics: DAE4 Sn861; Calibrated: 2020/05/27
- Phantom: Twin SAM Phantom_1823; Type: QD 000 P40 CD;
- Measurement SW: DASY52, Version 52.10 (4); SEMCAD X Version 14.6.14 (7483)

Pin=50mW/Area Scan (81x81x1): Interpolated grid: dx=1.200 mm, dy=1.200 mm
Maximum value of SAR (interpolated) = 9.57 W/kg

Pin=50mW/Zoom Scan (7x7x7)/Cube 0: Measurement grid: dx=4mm, dy=4mm, dz=1.4mm
Reference Value = 46.95 V/m; Power Drift = -0.18 dB
Peak SAR (extrapolated) = 16.4 W/kg
SAR(1 g) = 3.79 W/kg; SAR(10 g) = 1.13 W/kg (SAR corrected for target medium)
Maximum value of SAR (measured) = 9.76 W/kg

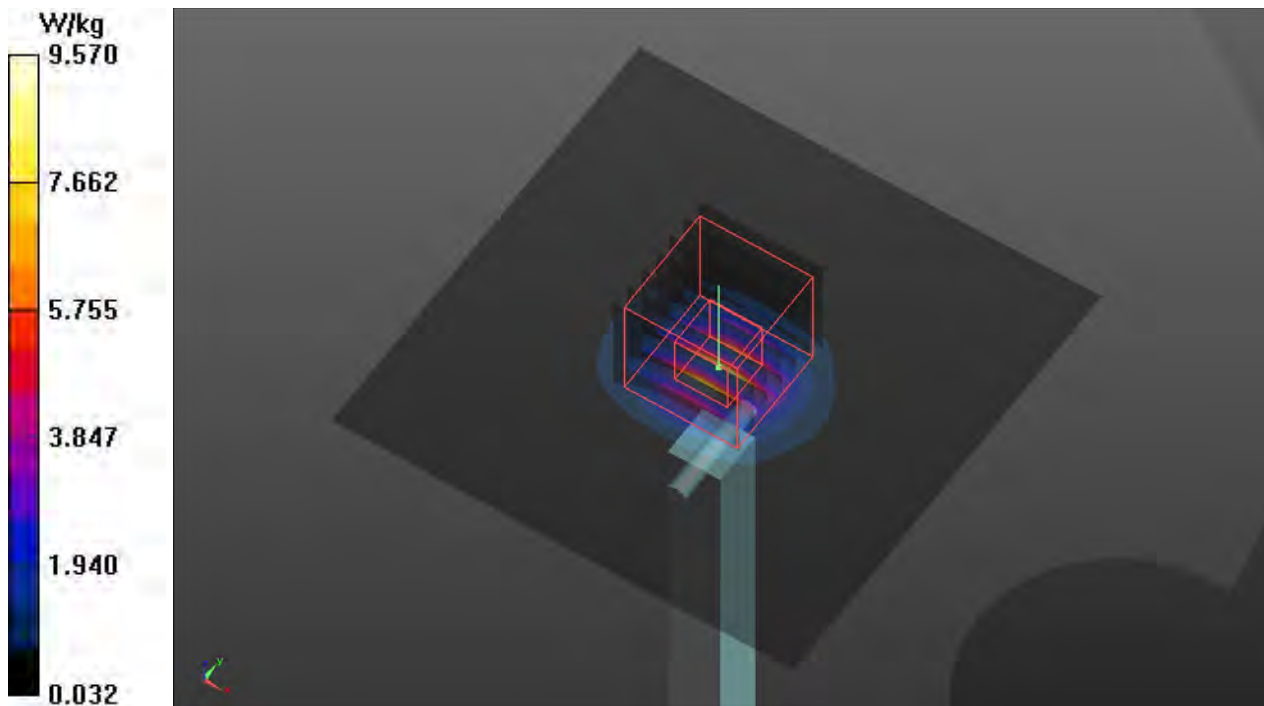

Appendix B. SAR Plots of SAR Measurement

The SAR plots for highest measured SAR in each exposure configuration, wireless mode and frequency band combination, and measured SAR > 1.5 W/kg are shown as follows.

P01 WCDMA II_RMC12.2K_Rear Face_0mm_Ch9538

DUT: 200518E05

Communication System: UID 10011 - CAB, UMTS-FDD (WCDMA); Frequency: 1907.6 MHz; Duty Cycle: 1:1.95

Medium: H16T20N1_0612 Medium parameters used: $f = 1908$ MHz; $\sigma = 1.458$ S/m; $\epsilon_r = 39.249$; $\rho = 1000$ kg/m³

Ambient Temperature : 23.2 °C ; Liquid Temperature : 23.1 °C

DASY5 Configuration:

- Probe: EX3DV4 - SN3971; ConvF(8.54, 8.54, 8.54) @ 1907.6 MHz; Calibrated: 2020/01/27
- Sensor-Surface: 1.4mm (Mechanical Surface Detection)
- Electronics: DAE4 Sn1277; Calibrated: 2020/01/24
- Phantom: Twin SAM Phantom_1496; Type: QD000P40CB;
- Measurement SW: DASY52, Version 52.10 (4); SEMCAD X Version 14.6.14 (7483)

Area Scan (81x141x1): Interpolated grid: dx=1.500 mm, dy=1.500 mm

Maximum value of SAR (interpolated) = 5.90 W/kg

Zoom Scan (5x5x7)/Cube 0: Measurement grid: dx=8mm, dy=8mm, dz=5mm

Reference Value = 58.36 V/m; Power Drift = 0.13 dB

Peak SAR (extrapolated) = 7.03 W/kg

SAR(1 g) = 4.33 W/kg; SAR(10 g) = 2.36 W/kg (SAR corrected for target medium)

Smallest distance from peaks to all points 3 dB below = 10.7 mm

Ratio of SAR at M2 to SAR at M1 = 67.9%

Maximum value of SAR (measured) = 6.33 W/kg

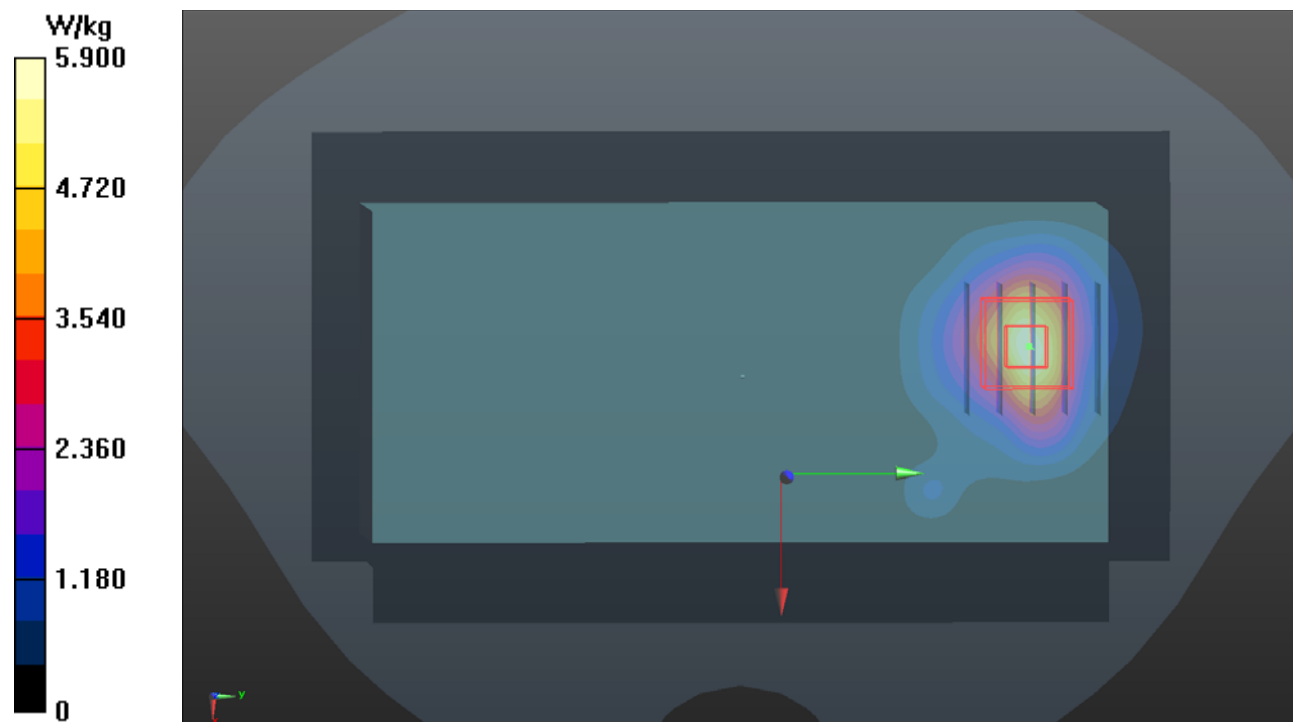

P02 WCDMA V_RMC12.2K_Rear Face_0mm_Ch4132

DUT: 200518E05

Communication System: UID 10011 - CAB, UMTS-FDD (WCDMA); Frequency: 826.4 MHz; Duty Cycle: 1:1.95

Medium: H07T10N1_0612 Medium parameters used (interpolated): $f = 826.4$ MHz; $\sigma = 0.917$ S/m; $\epsilon_r = 42.627$; $\rho = 1000$ kg/m³

Ambient Temperature : 23.2 °C ; Liquid Temperature : 23.1 °C

DASY5 Configuration:

- Probe: EX3DV4 - SN3971; ConvF(10.26, 10.26, 10.26) @ 826.4 MHz; Calibrated: 2020/01/27
- Sensor-Surface: 1.4mm (Mechanical Surface Detection)
- Electronics: DAE4 Sn1277; Calibrated: 2020/01/24
- Phantom: Twin SAM Phantom_1496; Type: QD000P40CB;
- Measurement SW: DASY52, Version 52.10 (4); SEMCAD X Version 14.6.14 (7483)

Area Scan (81x141x1): Interpolated grid: dx=1.500 mm, dy=1.500 mm

Maximum value of SAR (interpolated) = 1.64 W/kg

Zoom Scan 2 (5x5x5)/Cube 0: Measurement grid: dx=8mm, dy=8mm, dz=5mm

Reference Value = 32.92 V/m; Power Drift = -0.17 dB

Peak SAR (extrapolated) = 1.46 W/kg

SAR(1 g) = 0.848 W/kg; SAR(10 g) = 0.500 W/kg (SAR corrected for target medium)

Smallest distance from peaks to all points 3 dB below = 9.6 mm

Ratio of SAR at M2 to SAR at M1 = 62.9%

Maximum value of SAR (measured) = 1.12 W/kg

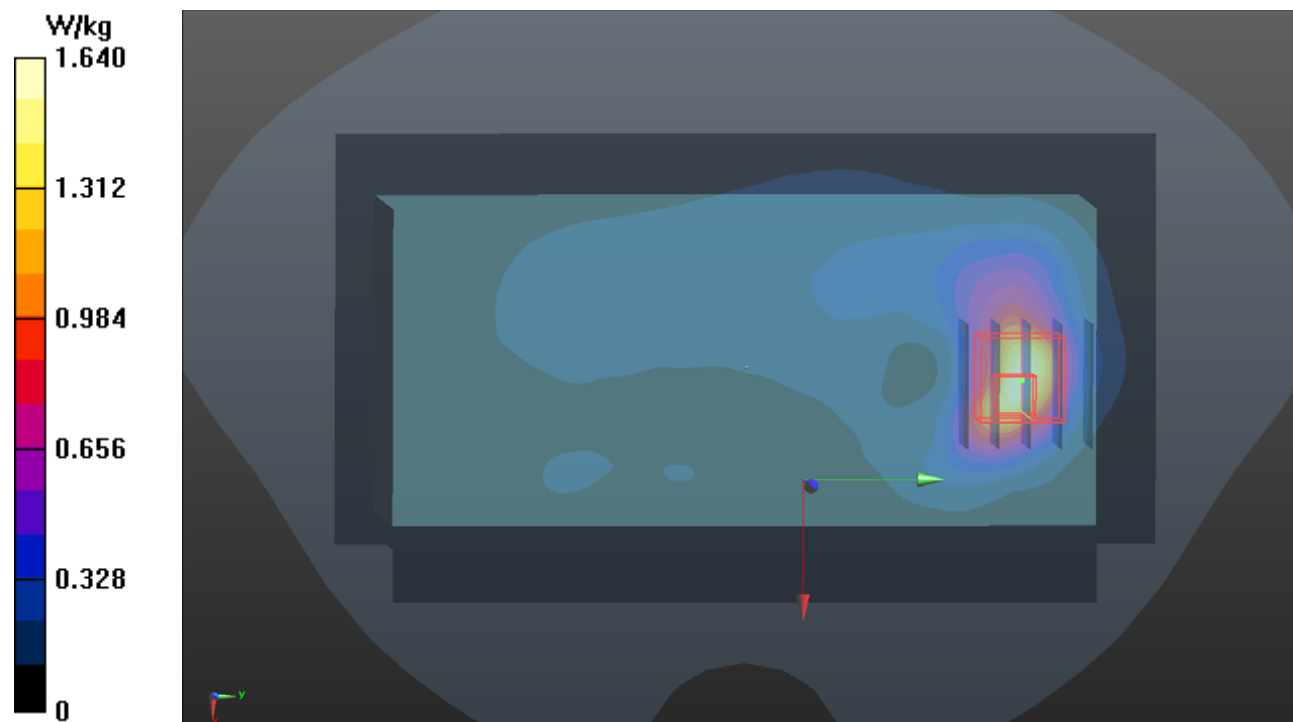

P03 LTE 2_QPSK20M_Rear Face_0mm_Ch19100_1RB_OS0

DUT: 200518E05

Communication System: UID 10169 - CAE, LTE-FDD (SC-FDMA, 1 RB, 20 MHz, QPSK);
Frequency: 1900 MHz; Duty Cycle: 1:3.74

Medium: H19T27N1_0612 Medium parameters used: $f = 1900$ MHz; $\sigma = 1.325$ S/m; $\epsilon_r = 41$; $\rho = 1000$ kg/m³

Ambient Temperature : 23.2 °C ; Liquid Temperature : 23.1 °C

DASY5 Configuration:

- Probe: EX3DV4 - SN3971; ConvF(8.54, 8.54, 8.54) @ 1900 MHz; Calibrated: 2020/01/27
- Sensor-Surface: 1.4mm (Mechanical Surface Detection)
- Electronics: DAE4 Sn1277; Calibrated: 2020/01/24
- Phantom: Twin SAM Phantom_1496; Type: QD000P40CB;
- Measurement SW: DASY52, Version 52.10 (4); SEMCAD X Version 14.6.14 (7483)

Area Scan (81x141x1): Interpolated grid: dx=1.500 mm, dy=1.500 mm

Maximum value of SAR (interpolated) = 6.00 W/kg

Zoom Scan (5x5x7)/Cube 0: Measurement grid: dx=8mm, dy=8mm, dz=5mm

Reference Value = 61.65 V/m; Power Drift = -0.07 dB

Peak SAR (extrapolated) = 7.34 W/kg

SAR(1 g) = 4.8 W/kg; SAR(10 g) = 2.53 W/kg (SAR corrected for target medium)

Smallest distance from peaks to all points 3 dB below = 10.1 mm

Ratio of SAR at M2 to SAR at M1 = 67.7%

Maximum value of SAR (measured) = 6.64 W/kg

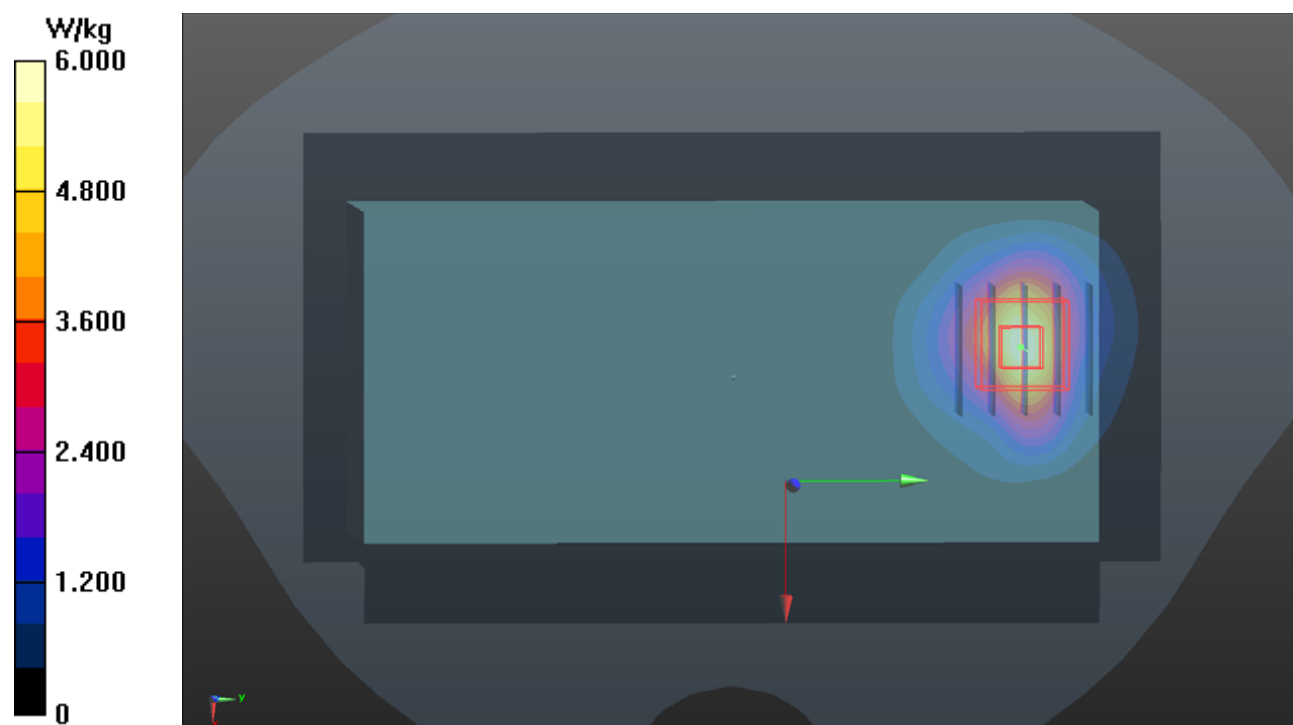

P04 LTE 4_QPSK20M_Rear Face_0mm_Ch20050_1RB_OS0

DUT: 200518E05

Communication System: UID 10169 - CAE, LTE-FDD (SC-FDMA, 1 RB, 20 MHz, QPSK);
Frequency: 1720 MHz; Duty Cycle: 1:3.74

Medium: H16T20N1_0612 Medium parameters used: $f = 1720$ MHz; $\sigma = 1.299$ S/m; $\epsilon_r = 39.928$; $\rho = 1000$ kg/m³

Ambient Temperature : 23.2 °C ; Liquid Temperature : 23.1 °C

DASY5 Configuration:

- Probe: EX3DV4 - SN3971; ConvF(8.73, 8.73, 8.73) @ 1720 MHz; Calibrated: 2020/01/27
- Sensor-Surface: 1.4mm (Mechanical Surface Detection)
- Electronics: DAE4 Sn1277; Calibrated: 2020/01/24
- Phantom: Twin SAM Phantom_1496; Type: QD000P40CB;
- Measurement SW: DASY52, Version 52.10 (4); SEMCAD X Version 14.6.14 (7483)

Area Scan (81x141x1): Interpolated grid: dx=1.500 mm, dy=1.500 mm

Maximum value of SAR (interpolated) = 6.66 W/kg

Zoom Scan (5x5x7)/Cube 0: Measurement grid: dx=8mm, dy=8mm, dz=5mm

Reference Value = 68.28 V/m; Power Drift = 0.05 dB

Peak SAR (extrapolated) = 7.75 W/kg

SAR(1 g) = 5.05 W/kg; SAR(10 g) = 2.8 W/kg (SAR corrected for target medium)

Smallest distance from peaks to all points 3 dB below = 10.7 mm

Ratio of SAR at M2 to SAR at M1 = 67%

Maximum value of SAR (measured) = 6.97 W/kg

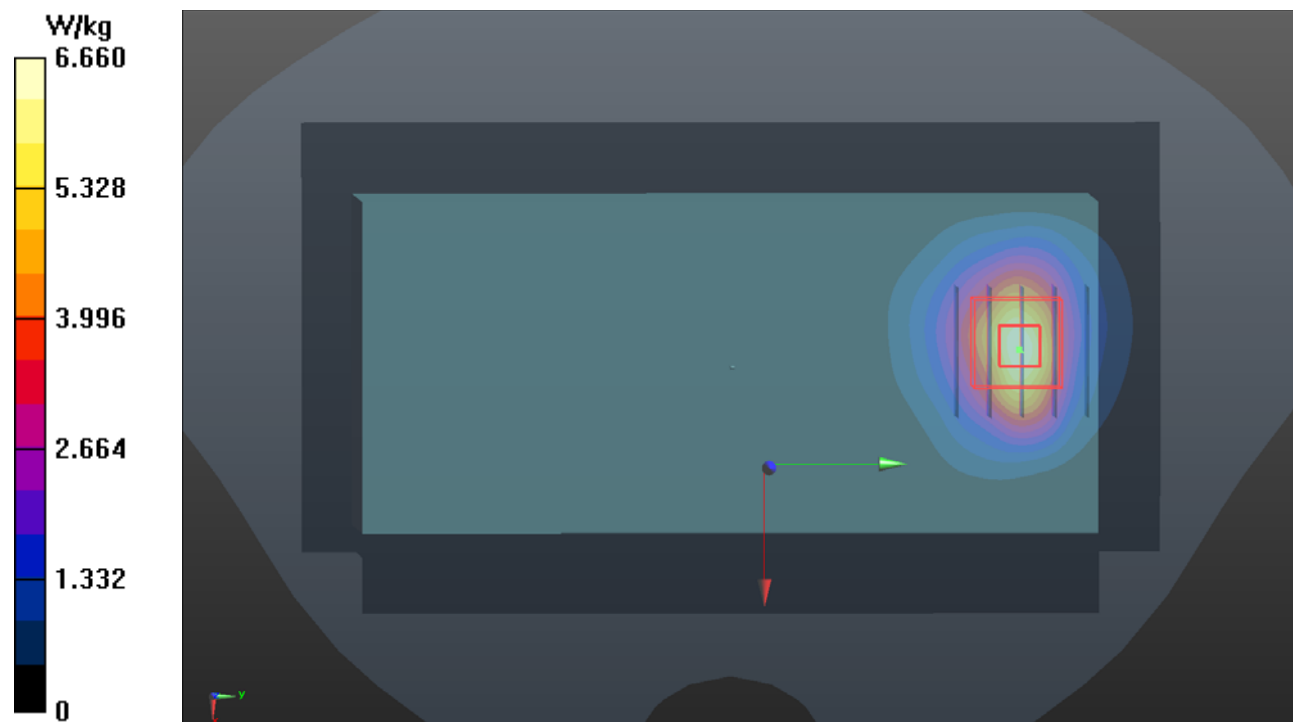

P05 LTE 12_QPSK10M_Right Side_0mm_Ch23060_1RB_OS0

DUT: 200518E05

Communication System: UID 10175 - CAG, LTE-FDD (SC-FDMA, 1 RB, 10 MHz, QPSK);

Frequency: 704 MHz; Duty Cycle: 1:3.74

Medium: H06T09N1_0612 Medium parameters used: $f = 704 \text{ MHz}$; $\sigma = 0.851 \text{ S/m}$; $\epsilon_r = 43.558$; $\rho = 1000 \text{ kg/m}^3$

Ambient Temperature : 23.2 °C ; Liquid Temperature : 23.1 °C

DASY5 Configuration:

- Probe: EX3DV4 - SN3971; ConvF(10.6, 10.6, 10.6) @ 704 MHz; Calibrated: 2020/01/27
- Sensor-Surface: 1.4mm (Mechanical Surface Detection)
- Electronics: DAE4 Sn1277; Calibrated: 2020/01/24
- Phantom: Twin SAM Phantom_1496; Type: QD000P40CB;
- Measurement SW: DASY52, Version 52.10 (4); SEMCAD X Version 14.6.14 (7483)

Area Scan (61x141x1): Interpolated grid: $dx=1.500 \text{ mm}$, $dy=1.500 \text{ mm}$

Maximum value of SAR (interpolated) = 2.02 W/kg

Zoom Scan (5x5x7)/Cube 0: Measurement grid: $dx=8\text{mm}$, $dy=8\text{mm}$, $dz=5\text{mm}$

Reference Value = 45.24 V/m; Power Drift = -0.05 dB

Peak SAR (extrapolated) = 2.27 W/kg

SAR(1 g) = 1.38 W/kg; SAR(10 g) = 0.735 W/kg (SAR corrected for target medium)

Smallest distance from peaks to all points 3 dB below = 12.8 mm

Ratio of SAR at M2 to SAR at M1 = 57.8%

Maximum value of SAR (measured) = 1.97 W/kg

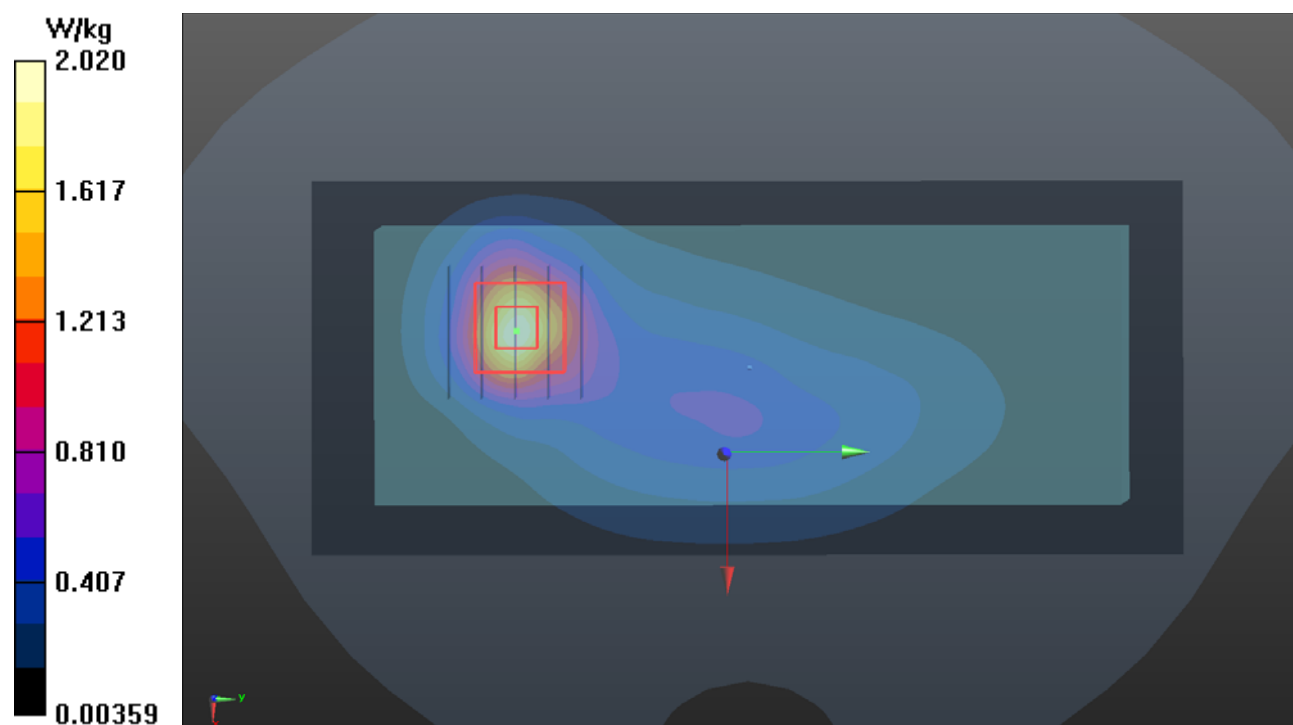

P06 WLAN2.4G_802.11b_Right Side_0mm_Ch1

DUT: 200518E05

Communication System: UID 10415 - AAA, IEEE 802.11b WiFi 2.4 GHz (DSSS, 1 Mbps, 99pc duty cycle); Frequency: 2412 MHz; Duty Cycle: 1:1.01

Medium: H19T27N4_0615 Medium parameters used: $f = 2412$ MHz; $\sigma = 1.863$ S/m; $\epsilon_r = 38.409$; $\rho = 1000$ kg/m³

Ambient Temperature : 23.7 °C ; Liquid Temperature : 23.5 °C

DASY5 Configuration:

- Probe: EX3DV4 - SN3650; ConvF(7.75, 7.75, 7.75) @ 2412 MHz; Calibrated: 2020/03/25
- Sensor-Surface: 1.4mm (Mechanical Surface Detection)
- Electronics: DAE4 Sn861; Calibrated: 2020/05/27
- Phantom: Twin SAM Phantom_1823; Type: QD 000 P40 CD;
- Measurement SW: DASY52, Version 52.10 (4); SEMCAD X Version 14.6.14 (7483)

Area Scan (81x181x1): Interpolated grid: dx=1.200 mm, dy=1.200 mm

Maximum value of SAR (interpolated) = 6.84 W/kg

Zoom Scan (7x7x7)/Cube 0: Measurement grid: dx=5mm, dy=5mm, dz=5mm

Reference Value = 61.92 V/m; Power Drift = -0.10 dB

Peak SAR (extrapolated) = 8.19 W/kg

SAR(1 g) = 4.14 W/kg; SAR(10 g) = 2.1 W/kg (SAR corrected for target medium)

Smallest distance from peaks to all points 3 dB below = 11.2 mm

Ratio of SAR at M2 to SAR at M1 = 52.2%

Maximum value of SAR (measured) = 6.68 W/kg

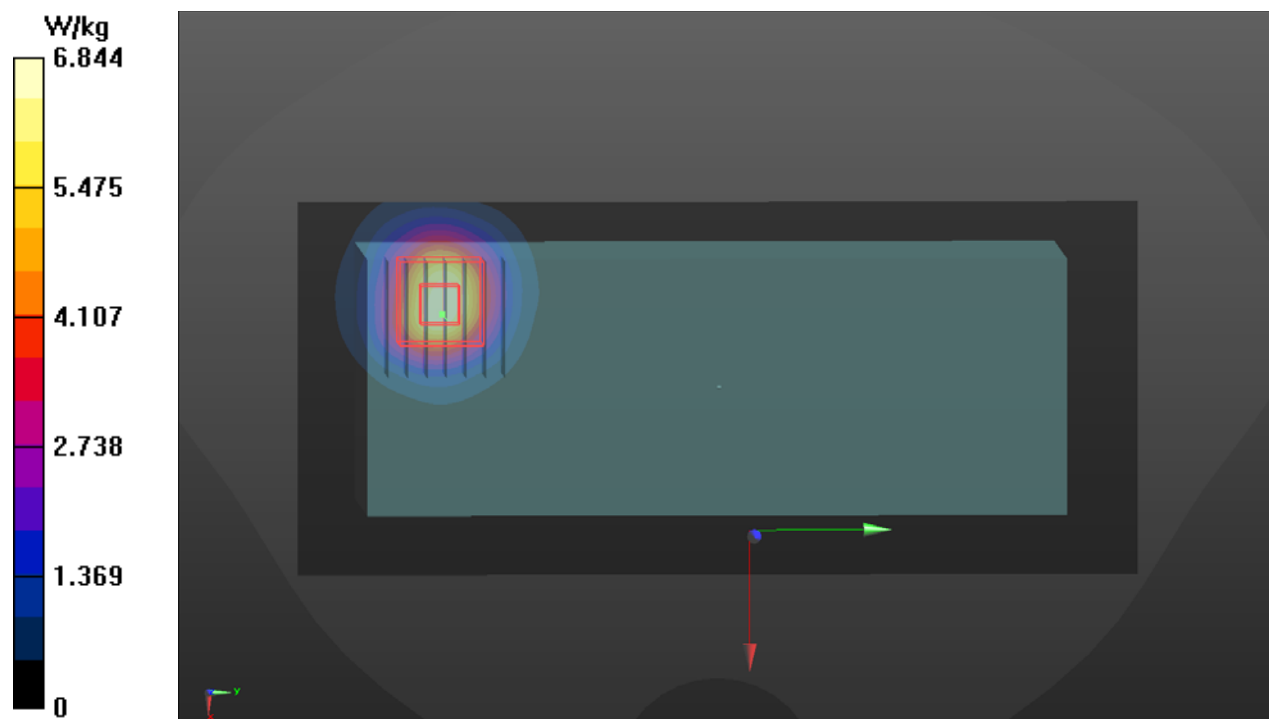

P07 WLAN5.3G_802.11a_Top Side_0mm_Ch60

DUT: 200518E05

Communication System: UID 10317 - AAC, IEEE 802.11a WiFi 5 GHz (OFDM, 6 Mbps, 96pc duty cycle); Frequency: 5300 MHz;Duty Cycle: 1:1.11
Medium: H34T60N4_0615 Medium parameters used: $f = 5300$ MHz; $\sigma = 4.651$ S/m; $\epsilon_r = 36.562$; $\rho = 1000$ kg/m³
Ambient Temperature : 23.7 °C ; Liquid Temperature : 23.5 °C

DASY5 Configuration:

- Probe: EX3DV4 - SN3650; ConvF(5.39, 5.39, 5.39) @ 5300 MHz; Calibrated: 2020/03/25
- Sensor-Surface: 1.4mm (Mechanical Surface Detection)
- Electronics: DAE4 Sn861; Calibrated: 2020/05/27
- Phantom: Twin SAM Phantom_1823; Type: QD 000 P40 CD;
- Measurement SW: DASY52, Version 52.10 (4); SEMCAD X Version 14.6.14 (7483)

Area Scan (81x111x1): Interpolated grid: dx=1.000 mm, dy=1.000 mm
Maximum value of SAR (interpolated) = 1.45 W/kg

Zoom Scan (7x7x7)/Cube 0: Measurement grid: dx=4mm, dy=4mm, dz=1.4mm
Reference Value = 18.90 V/m; Power Drift = -0.07 dB
Peak SAR (extrapolated) = 2.18 W/kg
SAR(1 g) = 0.699 W/kg; SAR(10 g) = 0.282 W/kg (SAR corrected for target medium)
Smallest distance from peaks to all points 3 dB below = 12.2 mm
Ratio of SAR at M2 to SAR at M1 = 68.5%
Maximum value of SAR (measured) = 1.47 W/kg

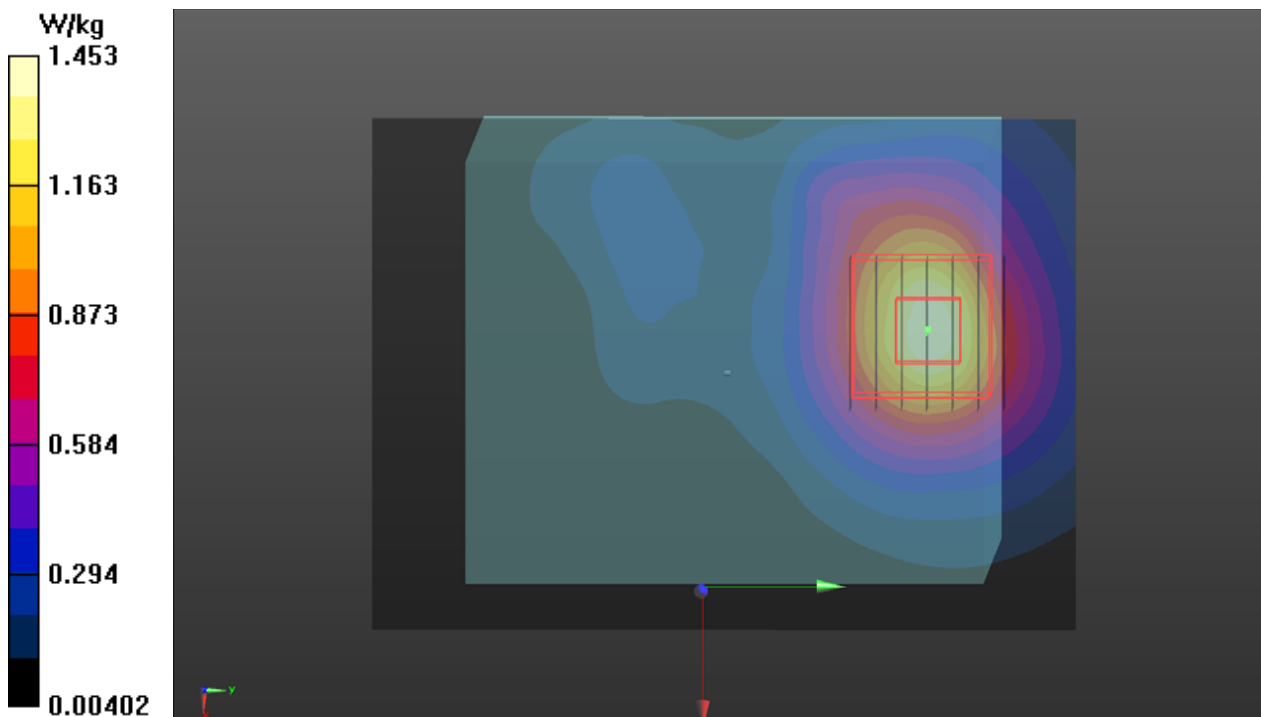

P08 WLAN5.6G_802.11n HT40_Right Side_0mm_Ch134

DUT: 200518E05

Communication System: UID 10599 - AAB, IEEE 802.11n (HT Mixed, 40MHz, MCS0, 90pc duty cycle); Frequency: 5670 MHz; Duty Cycle: 1:1.28
Medium: H34T60N4_0615 Medium parameters used: $f = 5670$ MHz; $\sigma = 5.083$ S/m; $\epsilon_r = 35.972$; $\rho = 1000$ kg/m³
Ambient Temperature : 23.7 °C ; Liquid Temperature : 23.5 °C

DASY5 Configuration:

- Probe: EX3DV4 - SN3650; ConvF(4.88, 4.88, 4.88) @ 5670 MHz; Calibrated: 2020/03/25
- Sensor-Surface: 1.4mm (Mechanical Surface Detection)
- Electronics: DAE4 Sn861; Calibrated: 2020/05/27
- Phantom: Twin SAM Phantom_1823; Type: QD 000 P40 CD;
- Measurement SW: DASY52, Version 52.10 (4); SEMCAD X Version 14.6.14 (7483)

Area Scan (101x201x1): Interpolated grid: dx=1.000 mm, dy=1.000 mm
Maximum value of SAR (interpolated) = 0.910 W/kg

Zoom Scan (7x7x7)/Cube 0: Measurement grid: dx=4mm, dy=4mm, dz=1.4mm
Reference Value = 13.10 V/m; Power Drift = 0.04 dB
Peak SAR (extrapolated) = 1.90 W/kg
SAR(1 g) = 0.458 W/kg; SAR(10 g) = 0.133 W/kg (SAR corrected for target medium)
Smallest distance from peaks to all points 3 dB below = 6.4 mm
Ratio of SAR at M2 to SAR at M1 = 62.1%
Maximum value of SAR (measured) = 1.09 W/kg

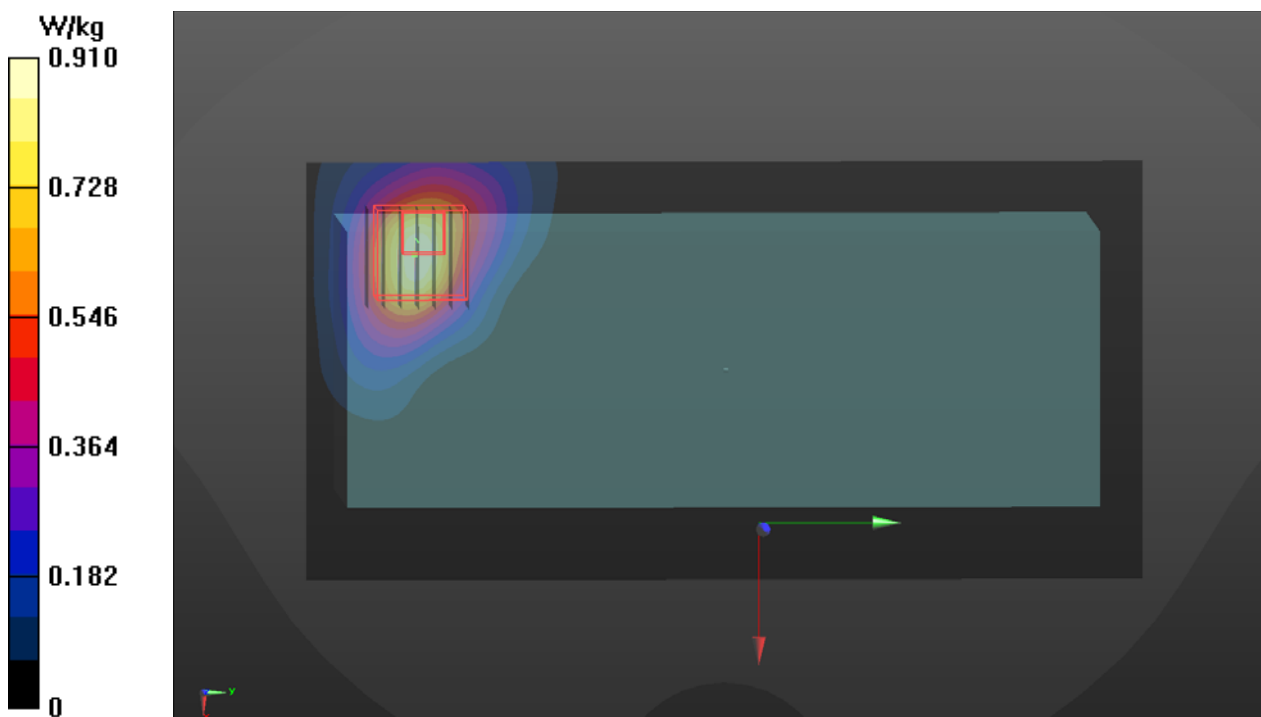

P09 WLAN5.8G_802.11n HT40_Right Side_0mm_Ch151

DUT: 200518E05

Communication System: UID 10599 - AAB, IEEE 802.11n (HT Mixed, 40MHz, MCS0, 90pc duty cycle); Frequency: 5755 MHz; Duty Cycle: 1:1.28
Medium: H34T60N4_0615 Medium parameters used: $f = 5755$ MHz; $\sigma = 5.183$ S/m; $\epsilon_r = 35.809$; $\rho = 1000$ kg/m³
Ambient Temperature : 23.7 °C ; Liquid Temperature : 23.5 °C

DASY5 Configuration:

- Probe: EX3DV4 - SN3650; ConvF(5.1, 5.1, 5.1) @ 5755 MHz; Calibrated: 2020/03/25
- Sensor-Surface: 1.4mm (Mechanical Surface Detection)
- Electronics: DAE4 Sn861; Calibrated: 2020/05/27
- Phantom: Twin SAM Phantom_1823; Type: QD 000 P40 CD;
- Measurement SW: DASY52, Version 52.10 (4); SEMCAD X Version 14.6.14 (7483)

Area Scan (101x201x1): Interpolated grid: dx=1.000 mm, dy=1.000 mm
Maximum value of SAR (interpolated) = 2.24 W/kg

Zoom Scan (7x7x7)/Cube 0: Measurement grid: dx=4mm, dy=4mm, dz=1.4mm
Reference Value = 19.65 V/m; Power Drift = 0.02 dB
Peak SAR (extrapolated) = 4.68 W/kg
SAR(1 g) = 1.11 W/kg; SAR(10 g) = 0.354 W/kg (SAR corrected for target medium)
Smallest distance from peaks to all points 3 dB below = 7.2 mm
Ratio of SAR at M2 to SAR at M1 = 62.1%
Maximum value of SAR (measured) = 2.76 W/kg

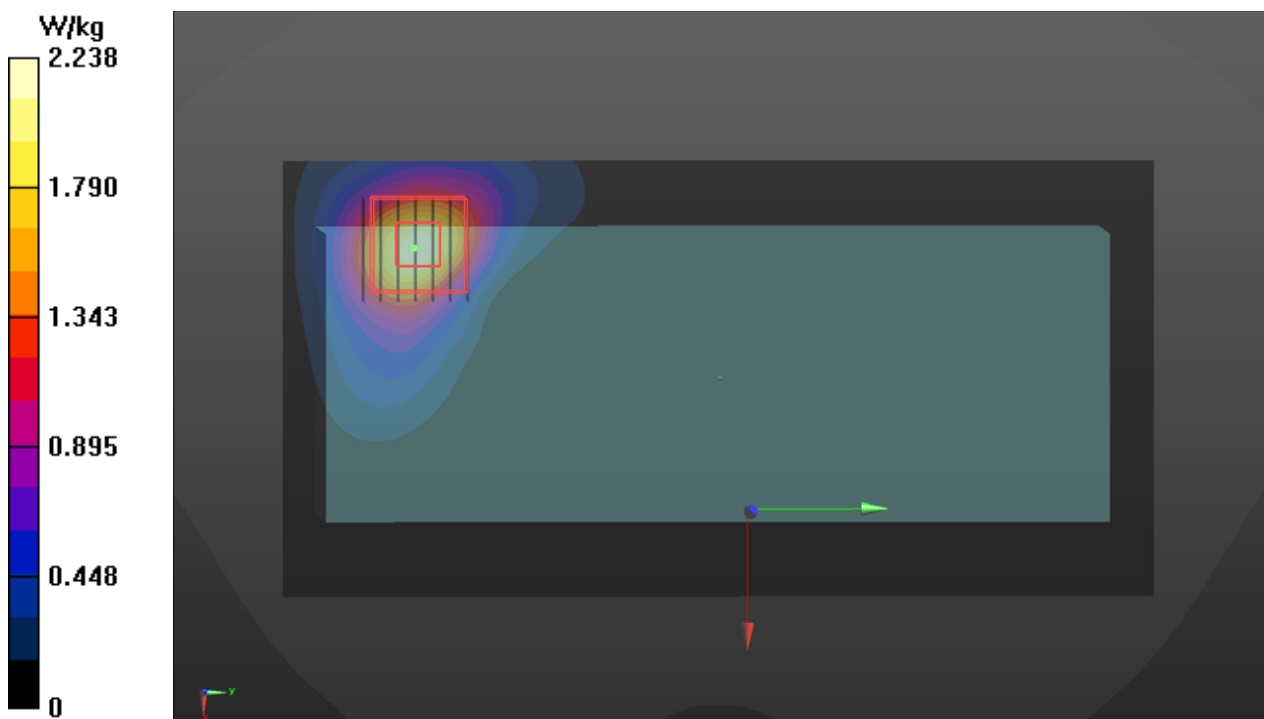

P10 BT_BDR_Right Side_0mm_Ch0

DUT: 200518E05

Communication System: UID 10032 - CAA, IEEE 802.15.1 Bluetooth (GFSK, DH5); Frequency: 2402 MHz; Duty Cycle: 1:1.25

Medium: H19T27N4_0615 Medium parameters used (interpolated): $f = 2402$ MHz; $\sigma = 1.852$ S/m; $\epsilon_r = 38.434$; $\rho = 1000$ kg/m³

Ambient Temperature : 23.7 °C ; Liquid Temperature : 23.5 °C

DASY5 Configuration:

- Probe: EX3DV4 - SN3650; ConvF(7.75, 7.75, 7.75) @ 2402 MHz; Calibrated: 2020/03/25
- Sensor-Surface: 1.4mm (Mechanical Surface Detection)
- Electronics: DAE4 Sn861; Calibrated: 2020/05/27
- Phantom: Twin SAM Phantom_1823; Type: QD 000 P40 CD;
- Measurement SW: DASY52, Version 52.10 (4); SEMCAD X Version 14.6.14 (7483)

Area Scan (81x181x1): Interpolated grid: dx=1.200 mm, dy=1.200 mm

Maximum value of SAR (interpolated) = 0.428 W/kg

Zoom Scan (7x7x7)/Cube 0: Measurement grid: dx=5mm, dy=5mm, dz=5mm

Reference Value = 13.98 V/m; Power Drift = -0.06 dB

Peak SAR (extrapolated) = 0.483 W/kg

SAR(1 g) = 0.240 W/kg; SAR(10 g) = 0.121 W/kg (SAR corrected for target medium)

Smallest distance from peaks to all points 3 dB below = 11.7 mm

Ratio of SAR at M2 to SAR at M1 = 50.8%

Maximum value of SAR (measured) = 0.397 W/kg

