

TEST REPORT

CERTIFICATE OF CONFORMITY

Standard: 47 CFR FCC Part 15, Subpart C (Section 15.247)

Report No.: RFBEOE-WTW-P23060395

FCC ID: MQT-AT150E18U

Product: Terminal

Brand: XAC

Model No.: xCL_AT-150-E-18U

Received Date: 2023/6/15

Test Date: 2023/6/30 ~ 2023/7/20

Issued Date: 2023/9/1

Applicant: XAC AUTOMATION CORP.

Address: 4F, No. 30, INDUSTRY E. RD. IX, SCIENCE-BASED INDUSTRIAL PARK,HSINCHU,TAIWAN

Issued By: Bureau Veritas Consumer Products Services (H.K.) Ltd., Taoyuan Branch
Hsin Chu Laboratory

Lab Address: E-2, No.1, Li Hsin 1st Road, Hsinchu Science Park, Hsinchu City 300, Taiwan

Test Location: E-2, No.1, Li Hsin 1st Road, Hsinchu Science Park, Hsinchu City 300, Taiwan

FCC Registration / 723255 / TW2022

Designation Number:

Approved by: _____



May Chen / Manager

Date: _____

2023/9/1

This test report consists of 63 pages in total. It may be duplicated completely for legal use with the approval of the applicant. It should not be reproduced except in full, without the written approval of our laboratory. The test results in the report only apply to the tested sample. The test results in this report are traceable to the national or international standards.



Prepared by : Vito Lung / Specialist

This report is governed by, and incorporates by reference, the Conditions of Testing as posted at the date of issuance of this report at <http://www.bureauveritas.com/home/about-us/our-business/cps/about-us/terms-conditions/> and is intended for your exclusive use. Any copying or replication of this report to or for any other person or entity, or use of our name or trademark, is permitted only with our prior written permission. This report sets forth our findings solely with respect to the test samples identified herein. The results set forth in this report are not indicative or representative of the quality or characteristics of the lot from which a test sample was taken or any similar or identical product unless specifically and expressly noted. Our report includes all of the tests requested by you and the results thereof based upon the information that you provided to us. Measurement uncertainty is only provided upon request for accredited tests. Statements of conformity are based on simple acceptance criteria without taking measurement uncertainty into account, unless otherwise requested in writing. You have 60 days from date of issuance of this report to notify us of any material error or omission caused by our negligence or if you require measurement uncertainty; provided, however, that such notice shall be in writing and shall specifically address the issue you wish to raise. A failure to raise such issue within the prescribed time shall constitute your unqualified acceptance of the completeness of this report, the tests conducted and the correctness of the report contents.

Table of Contents

Release Control Record	4
1 Certificate.....	5
2 Summary of Test Results	6
2.1 Measurement Uncertainty	6
2.2 Supplementary Information	6
3 General Information	7
3.1 General Description	7
3.2 Antenna Description of EUT	8
3.3 Channel List.....	9
3.4 Test Mode Applicability and Tested Channel Detail.....	10
3.5 Duty Cycle of Test Signal.....	11
3.6 Test Program Used and Operation Descriptions	12
3.7 Connection Diagram of EUT and Peripheral Devices	12
3.8 Configuration of Peripheral Devices and Cable Connections	13
4 Test Instruments	14
4.1 RF Output Power	14
4.2 Power Spectral Density	14
4.3 6 dB Bandwidth	14
4.4 Conducted Out of Band Emissions	14
4.5 AC Power Conducted Emissions	15
4.6 Unwanted Emissions below 1 GHz	15
4.7 Unwanted Emissions above 1 GHz.....	16
5 Limits of Test Items.....	17
5.1 RF Output Power	17
5.2 Power Spectral Density	17
5.3 6 dB Bandwidth	17
5.4 Conducted Out of Band Emissions	17
5.5 AC Power Conducted Emissions	17
5.6 Unwanted Emissions below 1 GHz	17
5.7 Unwanted Emissions above 1 GHz.....	18
6 Test Arrangements.....	19
6.1 RF Output Power	19
6.1.1 Test Setup	19
6.1.2 Test Procedure.....	19
6.2 Power Spectral Density	19
6.2.1 Test Setup	19
6.2.2 Test Procedure.....	19
6.3 6 dB Bandwidth	20
6.3.1 Test Setup	20
6.3.2 Test Procedure.....	20
6.4 Conducted Out of Band Emissions	20
6.4.1 Test Setup	20
6.4.2 Test Procedure.....	20
6.5 AC Power Conducted Emissions	21
6.5.1 Test Setup	21
6.5.2 Test Procedure.....	21
6.6 Unwanted Emissions below 1 GHz	22
6.6.1 Test Setup	22
6.6.2 Test Procedure.....	23
6.7 Unwanted Emissions above 1 GHz.....	24
6.7.1 Test Setup	24
6.7.2 Test Procedure.....	24
7 Test Results of Test Item	25



7.1	RF Output Power	25
7.2	Power Spectral Density	27
7.3	6 dB Bandwidth	29
7.4	Conducted Out of Band Emissions	31
7.5	AC Power Conducted Emissions	34
7.6	Unwanted Emissions below 1 GHz	36
7.7	Unwanted Emissions above 1 GHz.....	38
8	Pictures of Test Arrangements	62
9	Information of the Testing Laboratories	63



Release Control Record

Issue No.	Description	Date Issued
RFBEOE-WTW-P23060395	Original release.	2023/9/1

1 Certificate

Product: Terminal

Brand: XAC

Test Model: xCL_AT-150-E-18U

Sample Status: Engineering sample

Applicant: XAC AUTOMATION CORP.

Test Date: 2023/6/30 ~ 2023/7/20

Standard: 47 CFR FCC Part 15, Subpart C (Section 15.247)

Measurement ANSI C63.10-2013

procedure: KDB 558074 D01 15.247 Meas Guidance v05r02

The above equipment has been tested by **Bureau Veritas Consumer Products Services (H.K.) Ltd., Taoyuan Branch**, and found compliance with the requirement of the above standards. The test record, data evaluation & Equipment Under Test (EUT) configurations represented herein are true and accurate accounts of the measurements of the sample's RF characteristics under the conditions specified in this report.

2 Summary of Test Results

47 CFR FCC Part 15, Subpart C (Section 15.247)			
Standard / Clause	Test Item	Result	Remark
15.247(b)	RF Output Power	Pass	Meet the requirement of limit.
15.247(e)	Power Spectral Density	Pass	Meet the requirement of limit.
15.247(a)(2)	6 dB Bandwidth	Pass	Meet the requirement of limit.
15.247(d)	Conducted Out of Band Emissions	Pass	Meet the requirement of limit.
15.207	AC Power Conducted Emissions	Pass	Minimum passing margin is -14.59 dB at 0.61094 MHz
15.205 / 15.209 / 15.247(d)	Unwanted Emissions below 1 GHz	Pass	Minimum passing margin is -9.6 dB at 32.73 MHz
15.205 / 15.209 / 15.247(d)	Unwanted Emissions above 1 GHz	Pass	Minimum passing margin is -1.6 dB at 2483.50 MHz
15.203	Antenna Requirement	Pass	Antenna connector is i-pex(MHF) not a standard connector.

Note: Determining compliance based on the results of the compliance measurement, not taking into account measurement instrumentation uncertainty.

2.1 Measurement Uncertainty

Where relevant, the following measurement uncertainty levels have been estimated for tests performed on the EUT as specified in CISPR 16-4-2:

Measurement	Specification	Expanded Uncertainty (k=2) (±)
Conducted Out of Band Emissions	9 kHz ~ 40 GHz	2.5 dB
AC Power Conducted Emissions	150 kHz ~ 30 MHz	1.9 dB
Unwanted Emissions below 1 GHz	9 kHz ~ 30 MHz	3.1 dB
	30 MHz ~ 1 GHz	5.4 dB
Unwanted Emissions above 1 GHz	1 GHz ~ 18 GHz	5.0 dB
	18 GHz ~ 40 GHz	5.3 dB

The other instruments specified are routine verified to remain within the calibrated levels, no measurement uncertainty is required to be calculated.

2.2 Supplementary Information

There is not any deviation from the test standards for the test method, and no modifications required for compliance.

3 General Information

3.1 General Description

Product	Terminal
Brand	XAC
Test Model	xCL_AT-150-E-18U
Status of EUT	Engineering sample
Power Supply Rating	3.88 Vdc from Battery / DC 5V from USB type C or DC 9V from PIGO PIN
Modulation Type	CCK, DQPSK, DBPSK for DSSS 64QAM, 16QAM, QPSK, BPSK for OFDM
Modulation Technology	DSSS, OFDM
Transfer Rate	802.11b: up to 11 Mbps 802.11g: up to 54 Mbps 802.11n: up to 72.2 Mbps
Operating Frequency	2.412 GHz ~ 2.462 GHz
Number of Channel	802.11b, 802.11g, 802.11n (HT20): 11
Output Power	208.449 mW (23.19 dBm)

Note:

1. All models are listed as below.

Brand	Model	Difference
XAC	xCL_AT-150-E-18U	For marketing purpose.
Uniform Industrial Corp.	PIXIE-5EU2NSU2W	

From the above models, model: xCL_AT-150-E-18U was selected as representative model for the test and its data was recorded in this report.

2. The EUT uses following accessories.

Battery 1		
Brand	Model	Power Rating
IES	IDS155GA	3.88V, 3780mAh

3. The EUT has below radios as following table:

Radio 1	Radio 2	Radio 3
WLAN 2.4GHz + WLAN 5GHz + Bluetooth	WWAN(LTE)	NFC

4. Simultaneously transmission condition.

Condition	Technology			
1	WWAN(LTE)	WLAN (2.4 GHz)	WLAN (5 GHz)	NFC
2	WWAN(LTE)	WLAN (5 GHz)	Bluetooth	NFC

Note: The emission of the simultaneous operation has been evaluated and no non-compliance was found.

5. The above EUT information is declared by manufacturer and for more detailed features description, please refer to the manufacturer's specifications or user's manual.

3.2 Antenna Description of EUT

1. The antenna information is listed as below.

RF Chain NO.	Brand	Model	Antenna Net Gain(dBi)	Frequency range	Antenna Type	Connector Type
WiFi/BT	AWAN	AYF6P-100002	2.59	2.4~2.5GHz	PIFA	ipex(MHF)
			4.47	5.15~5.85GHz		

* Detail antenna specification please refer to antenna datasheet and/or antenna measurement report.

2. The EUT incorporates a SISO function:

2.4 GHz Band		
Modulation Mode	TX & RX Configuration	
802.11b	1TX	1RX
802.11g	1TX	1RX
802.11n (HT20)	1TX	1RX

3.3 Channel List

11 channels are provided for 802.11b, 802.11g, 802.11n (HT20):

Channel	Frequency	Channel	Frequency
1	2412 MHz	7	2442 MHz
2	2417 MHz	8	2447 MHz
3	2422 MHz	9	2452 MHz
4	2427 MHz	10	2457 MHz
5	2432 MHz	11	2462 MHz
6	2437 MHz		

3.4 Test Mode Applicability and Tested Channel Detail

Pre-Scan:	<p>1. For Unwanted Emission (below 1GHz) item: Battery/ POGO Pin (Adapter: DSA-33PDA FUS)/ USB type C (Adapter: NBS10B050200VUU). Pre-scan these modes and find the worst case as a representative test condition.</p> <p>2. For AC power conducted emission item: POGO Pin (Adapter: DSA-33PDA FUS)/ USB type C (Adapter: NBS10B050200VUU). Pre-scan these modes and find the worst case as a representative test condition.</p> <p>3. Pre-Scan has been conducted to determine the worst-case mode from all possible combinations between available modulations, data rates and antenna ports (if EUT with antenna diversity architecture).</p>
Worst Case:	<p>1.Unwanted Emission item worst condition: USB type C (Adapter: NBS10B050200VUU)</p> <p>2.AC Adapter Worst Condition: USB type C (Adapter: NBS10B050200VUU)</p> <p>3. X-axis/ Y-axis/ Z-axis Worst Condition: X-axis</p>

Following channel(s) was (were) selected for the final test as listed below:

Test Item	Mode	Tested Channel	Modulation	Data Rate Parameter
RF Output Power / Power Spectral Density	802.11b	1, 6, 11	DBPSK	1Mb/s
	802.11g	1, 6, 11	BPSK	6Mb/s
	802.11n (HT20)	1, 6, 11	BPSK	MCS0
6 dB Bandwidth / Conducted Out of Band Emissions	802.11b	1, 6, 11	DBPSK	1Mb/s
	802.11g	1, 6, 11	BPSK	6Mb/s
	802.11n (HT20)	1, 6, 11	BPSK	MCS0
AC Power Conducted Emissions	802.11b	6	DBPSK	1Mb/s
Unwanted Emissions below 1 GHz	802.11b	6	DBPSK	1Mb/s
Unwanted Emissions above 1 GHz	802.11b	1, 6, 11	DBPSK	1Mb/s
	802.11g	1, 6, 11	BPSK	6Mb/s
	802.11n (HT20)	1, 6, 11	BPSK	MCS0



3.5 Duty Cycle of Test Signal

802.11b: Duty cycle = 12.209 ms / 12.339 ms x 100% = 98.9%

802.11g: Duty cycle = 2.029 ms / 2.064 ms x 100% = 98.3%

802.11n (HT20): Duty cycle = 1.89 ms / 1.925 ms x 100% = 98.2%

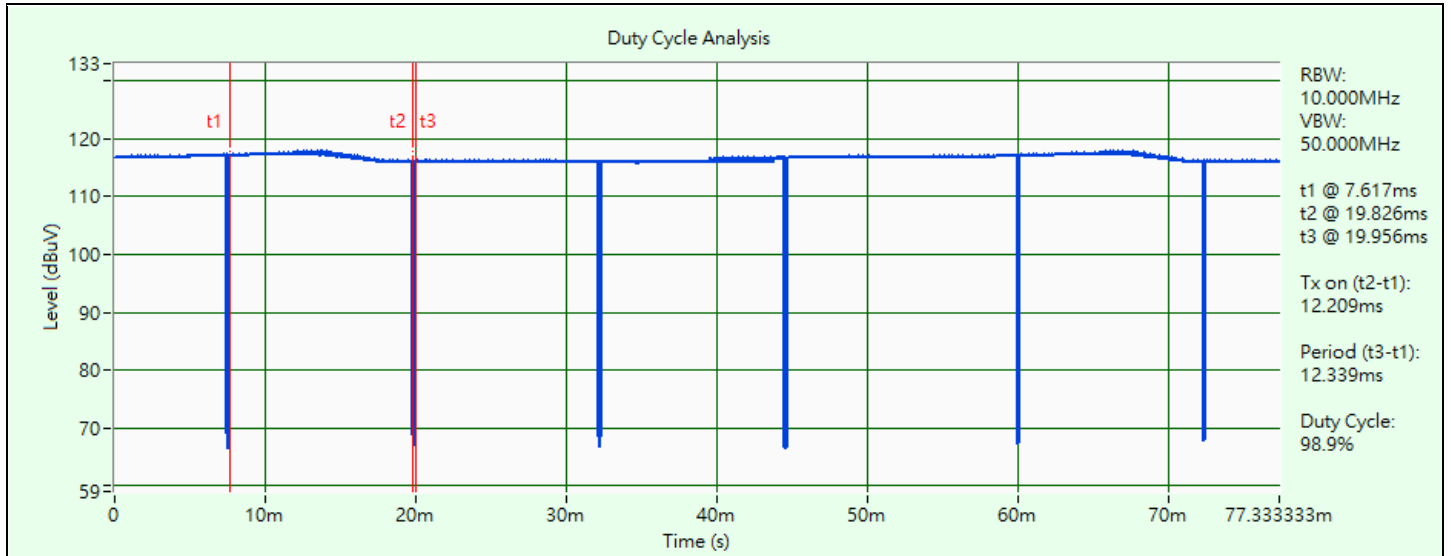

802.11b

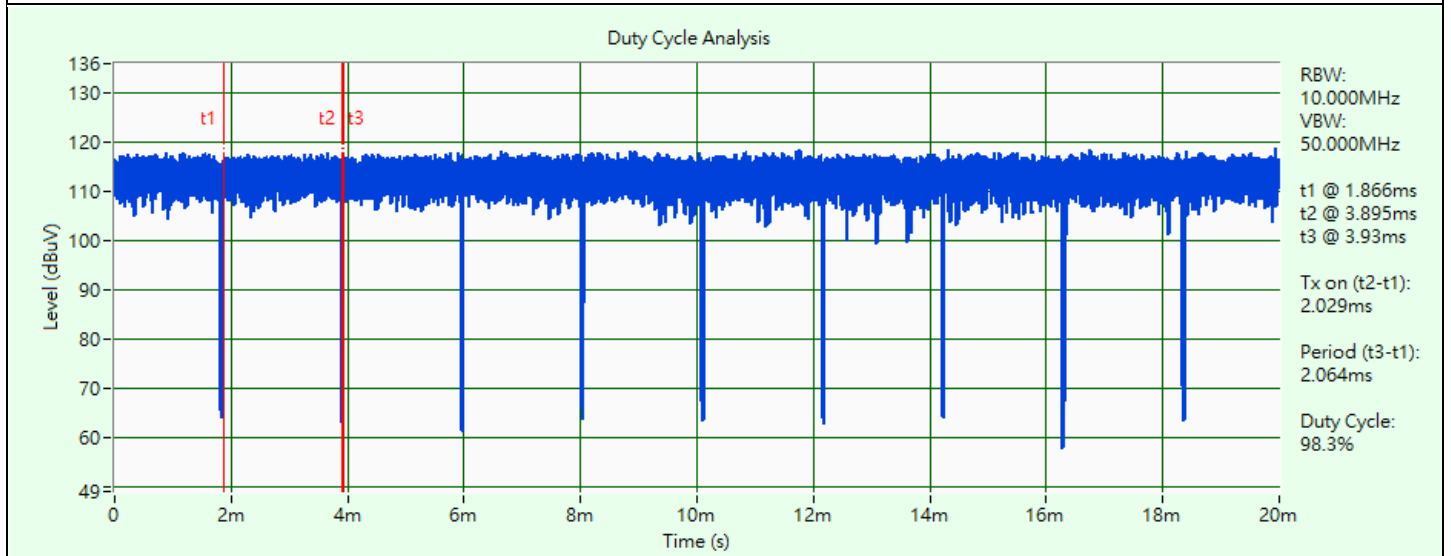

802.11g

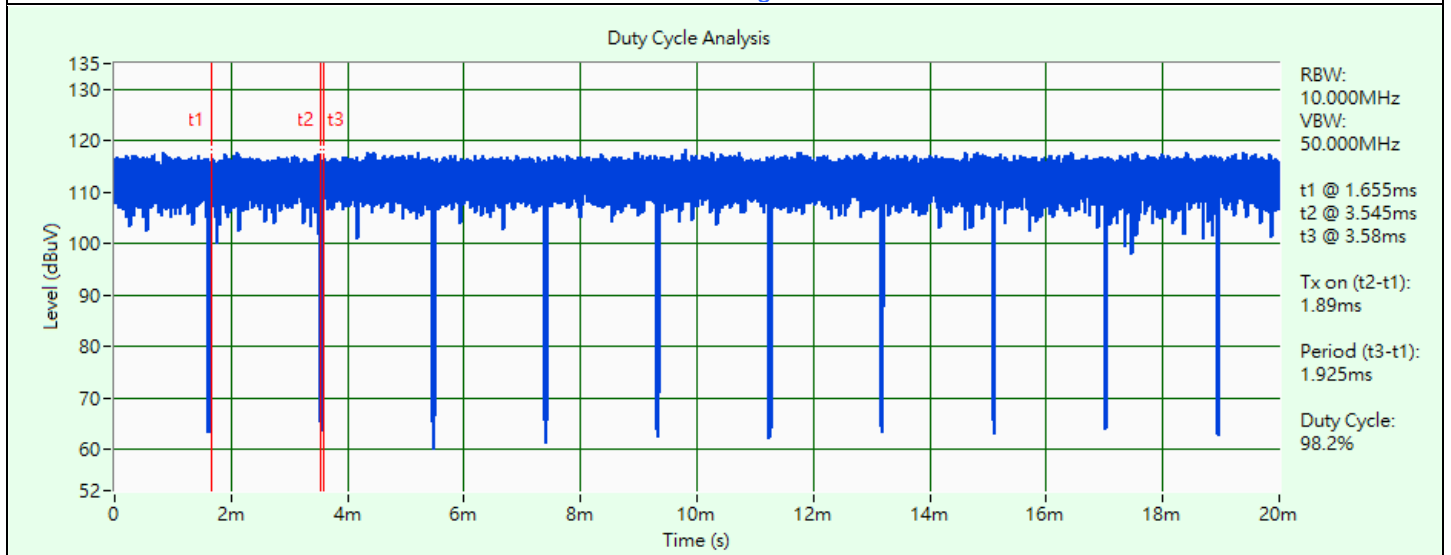

802.11n (HT20)

3.6 Test Program Used and Operation Descriptions

Controlling software (Wifi: QDART_WIN_4_8_Installer_00057_1) has been activated to set the EUT under transmission condition continuously at specific channel frequency.

3.7 Connection Diagram of EUT and Peripheral Devices

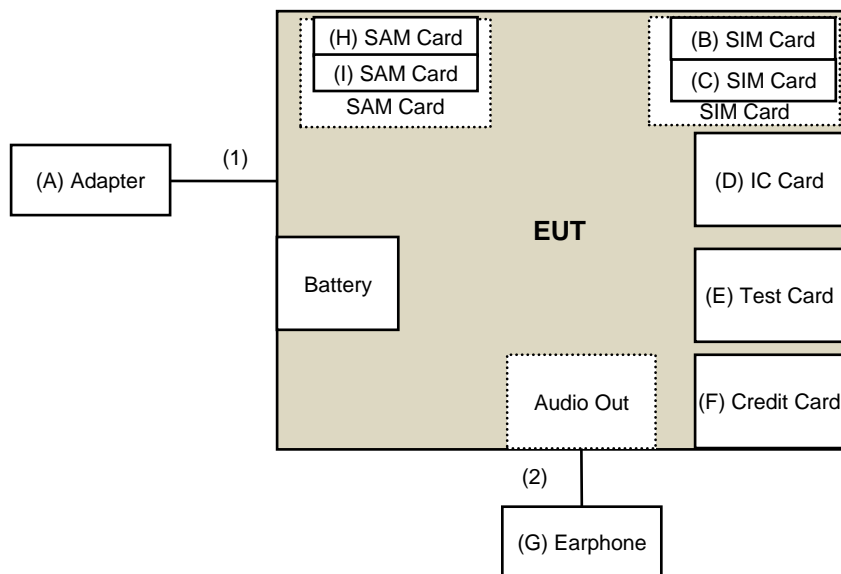

3.8 Configuration of Peripheral Devices and Cable Connections

ID	Product	Brand	Model No.	Serial No.	FCC ID	Remarks
A	Adapter	MASS POWER	NBS10B050200VUU	NA	NA	Supplied by applicant
B	SIM Card	XAC	NA	NA	NA	Supplied by applicant
C	SIM Card	XAC	NA	NA	NA	Supplied by applicant
D	IC Card	XAC	NA	NA	NA	Supplied by applicant
E	Test Card	XAC	NA	NA	NA	Supplied by applicant
F	Credit Card	Cathay	NA	NA	NA	Provided by Lab
G	Earphone	Amkor	IE2	NA	NA	Provided by Lab
H	SAM Card	XAC	NA	NA	NA	Supplied by applicant
I	SAM Card	XAC	NA	NA	NA	Supplied by applicant

ID	Cable Descriptions	Qty.	Length (m)	Shielding (Yes/No)	Cores (Qty.)	Remarks
1	USB Type A to USB Type C cable	1	1.2	Yes	0	Supplied by applicant
2	Audio Cable	1	1.2	No	0	Provided by Lab

4 Test Instruments

The calibration interval of the all test instruments are 12 months and the calibrations are traceable to NML/ROC and NIST/USA.

4.1 RF Output Power

Description Manufacturer	Model No.	Serial No.	Calibrated Date	Calibrated Until
Fixed Attenuator Woken	MDCS18N-10	MDCS18N-10-01	2023/3/27	2024/3/26
Power Meter Anritsu	ML2495A	1529002	2023/6/17	2024/6/16
Pulse Power Sensor Anritsu	MA2411B	1726434	2023/6/19	2024/6/18

Notes:

1. The test was performed in Oven room 2.
2. Tested Date: 2023/7/15 ~ 2023/7/20

4.2 Power Spectral Density

Description Manufacturer	Model No.	Serial No.	Calibrated Date	Calibrated Until
Fixed Attenuator Woken	MDCS18N-10	MDCS18N-10-01	2023/3/27	2024/3/26
MXA Signal Analyzer Keysight	N9020B	MY60112409	2023/2/18	2024/2/17
Software	ADT_RF Test Software V6.6.5.4	N/A	N/A	N/A

Notes:

1. The test was performed in Oven room 2.
2. Tested Date: 2023/7/15 ~ 2023/7/20

4.3 6 dB Bandwidth

Refer to section 4.2 to get information of the instruments.

4.4 Conducted Out of Band Emissions

Refer to section 4.2 to get information of the instruments.

4.5 AC Power Conducted Emissions

Description Manufacturer	Model No.	Serial No.	Calibrated Date	Calibrated Until
50 ohm terminal resistance	N/A	EMC-01	2022/9/27	2023/9/26
EMI Test Receiver R&S	ESCS 30	847124/029	2022/10/14	2023/10/13
Fixed Attenuator STI	STI02-2200-10	005	2023/7/1	2024/6/30
LISN R&S	ESH3-Z5	848773/004	2022/10/18	2023/10/17
RF Coaxial Cable JYEBAO	5D-FB	COCCAB-001	2023/7/1	2024/6/30
Software BVADT	BVADT_Cond_V7.3.7.4	N/A	N/A	N/A

Notes:

1. The test was performed in Conduction 1
2. Tested Date: 2023/7/17

4.6 Unwanted Emissions below 1 GHz

Description Manufacturer	Model No.	Serial No.	Calibrated Date	Calibrated Until
Antenna Tower & Turn Table Max-Full	MF-7802	MF780208406	N/A	N/A
Bi_Log Antenna Schwarzbeck	VULB 9168	9168-361	2022/10/21	2023/10/20
Fix tool for Boresight antenna tower BV	FBA-01	FBA_SIP01	N/A	N/A
Fixed Attenuator Mini-Circuits	UNAT-5+	PAD-3m-3-01	2022/9/14	2023/9/13
Loop Antenna Electro-Metrics	EM-6879	264	2023/2/21	2024/2/20
MXE EMI Receiver Keysight	N9038A	MY59050100	2023/6/13	2024/6/12
Preamplifier Agilent	8447D	2944A10636	2023/3/12	2024/3/11
Preamplifier Mini-Circuits	ZFL-1000VH2	QA0838008	2022/10/4	2023/10/3
PXA Signal Analyzer Keysight	N9030B	MY57142938	2023/4/6	2024/4/5
RF Coaxial Cable JYEBAO	5D-FB	LOOPCAB-001	2022/12/19	2023/12/18
		LOOPCAB-002	2022/12/19	2023/12/18
RF Coaxial Cable PEWC	8D	966-3-2	2023/2/17	2024/2/16
		966-3-3	2023/2/17	2024/2/16
		966-4-1	2023/2/18	2024/2/17
Software	ADT_Radiated_V8.7.08	N/A	N/A	N/A

Notes:

1. The test was performed in 966 Chamber No. 3.
2. Tested Date: 2023/7/17

4.7 Unwanted Emissions above 1 GHz

Description Manufacturer	Model No.	Serial No.	Calibrated Date	Calibrated Until
Antenna Tower & Turn Table Max-Full	MF-7802	MF780208406	N/A	N/A
Fix tool for Boresight antenna tower BV	FBA-01	FBA_SIP01	N/A	N/A
Horn Antenna Schwarzbeck	BBHA 9120D	9120D-406	2022/11/13	2023/11/12
	BBHA 9170	9170-739	2022/11/13	2023/11/12
MXE EMI Receiver Keysight	N9038A	MY59050100	2023/6/13	2024/6/12
Preamplifier EMCI	EMC12630SE	980384	2022/12/28	2023/12/27
	EMC184045SE	980387	2022/12/28	2023/12/27
PXA Signal Analyzer Keysight	N9030B	MY57142938	2023/4/6	2024/4/5
RF Coaxial Cable EMCI	EMC-KM-KM-4000	200214	2023/2/20	2024/2/19
	EMC102-KM-KM-1200	160924	2022/12/28	2023/12/27
	EMC104-SM-SM-1500	180504	2023/3/27	2024/3/26
	EMC104-SM-SM-2000	180601	2023/6/2	2024/6/1
	EMC104-SM-SM-6000	210201	2023/5/8	2024/5/7
Software	ADT_Radiated_V8.7.08	N/A	N/A	N/A

Notes:

1. The test was performed in 966 Chamber No. 3.
2. Tested Date: 2023/6/30 ~ 2023/7/14

5 Limits of Test Items

5.1 RF Output Power

For systems using digital modulation in the 2400–2483.5 MHz bands: 1 Watt (30 dBm)

5.2 Power Spectral Density

The Maximum of Power Spectral Density Measurement is 8 dBm in any 3 kHz.

5.3 6 dB Bandwidth

The minimum of 6 dB Bandwidth Measurement is 0.5 MHz.

5.4 Conducted Out of Band Emissions

Below 20 dB of the highest emission level of operating band (in 100 kHz Resolution Bandwidth).

5.5 AC Power Conducted Emissions

Frequency (MHz)	Conducted Limit (dBuV)	
	Quasi-peak	Average
0.15 - 0.5	66 - 56	56 - 46
0.50 - 5.0	56	46
5.0 - 30.0	60	50

Notes:

1. The lower limit shall apply at the transition frequencies.
2. The limit decreases in line with the logarithm of the frequency in the range of 0.15 to 0.50 MHz.

5.6 Unwanted Emissions below 1 GHz

Radiated emissions up to 1 GHz which fall in the restricted bands must comply with the radiated emission limits specified as below table. Other emissions shall be at least 20 dB below the highest level of the desired power:

Frequencies (MHz)	Field Strength (microvolts/meter)	Measurement Distance (meters)
0.009 ~ 0.490	2400/F(kHz)	300
0.490 ~ 1.705	24000/F(kHz)	30
1.705 ~ 30.0	30	30
30 ~ 88	100	3
88 ~ 216	150	3
216 ~ 960	200	3
Above 960	500	3

Notes:

1. The lower limit shall apply at the transition frequencies.
2. Emission level (dBuV/m) = 20 log Emission level (uV/m).

5.7 Unwanted Emissions above 1 GHz

Radiated emissions above 1 GHz which fall in the restricted bands must comply with the radiated emission limits specified as below table. Other emissions shall be at least 20 dB below the highest level of the desired power:

Frequencies (MHz)	Field Strength (microvolts/meter)	Measurement Distance (meters)
Above 960	500	3

Notes:

1. The lower limit shall apply at the transition frequencies.
2. Emission level (dBuV/m) = 20 log Emission level (uV/m).
3. For frequencies above 1000 MHz, the field strength limits are based on average detector, however, the peak field strength of any emission shall not exceed the maximum permitted average limits, specified above by more than 20 dB under any condition of modulation.

6 Test Arrangements

6.1 RF Output Power

6.1.1 Test Setup

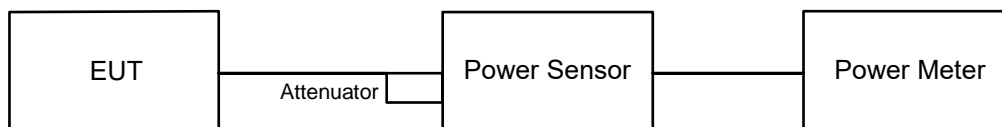

6.1.2 Test Procedure

Peak Power:

A peak power sensor was used on the output port of the EUT. A power meter was used to read the response of the peak power sensor. Record the power level.

Average Power:

Average power sensor was used to perform output power measurement, trigger and gating function of wide band power meter is enabled to measure max output power of TX on burst. Duty factor is not added to measured value.

6.2 Power Spectral Density

6.2.1 Test Setup

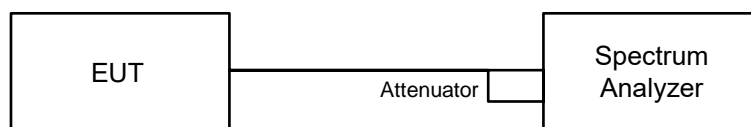

6.2.2 Test Procedure

- a. Set analyzer center frequency to DTS channel center frequency.
- b. Set the span to 1.5 times the DTS bandwidth.
- c. Set the RBW to: 3 kHz.
- d. Set the VBW $\geq 3 \times$ RBW.
- e. Detector = peak.
- f. Sweep time = auto couple.
- g. Trace mode = max hold.
- h. Allow trace to fully stabilize.
- i. Use the peak marker function to determine the maximum amplitude level within the RBW.

6.3 6 dB Bandwidth

6.3.1 Test Setup

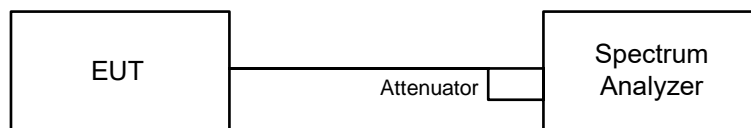

6.3.2 Test Procedure

- Set resolution bandwidth (RBW) = 100 kHz.
- Set the video bandwidth (VBW) $\geq 3 \times$ RBW, Detector = Peak.
- Trace mode = max hold.
- Sweep = auto couple.
- Measure the maximum width of the emission that is constrained by the frequencies associated with the two amplitude points (upper and lower) that are attenuated by 6 dB relative to the maximum level measured in the fundamental emission.

6.4 Conducted Out of Band Emissions

6.4.1 Test Setup

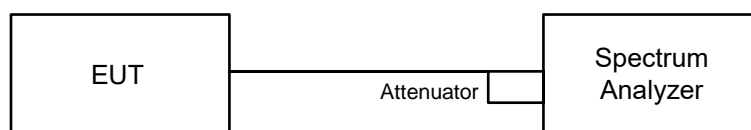

6.4.2 Test Procedure

MEASUREMENT PROCEDURE REF

- Set the RBW = 100 kHz.
- Set the VBW ≥ 300 kHz.
- Detector = peak.
- Sweep time = auto couple.
- Trace mode = max hold.
- Allow trace to fully stabilize.
- Use the peak marker function to determine the maximum power level in any 100 kHz band segment within the fundamental EBW.

MEASUREMENT PROCEDURE OOB

- Set RBW = 100 kHz.
- Set VBW ≥ 300 kHz.
- Detector = peak.
- Sweep = auto couple.
- Trace Mode = max hold.
- Allow trace to fully stabilize.
- Use the peak marker function to determine the maximum amplitude level.

6.5 AC Power Conducted Emissions

6.5.1 Test Setup

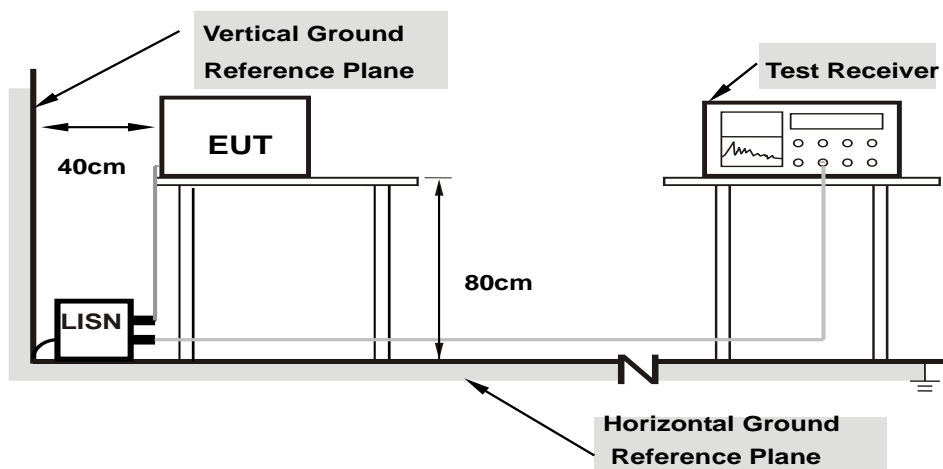

Note: 1.Support units were connected to second LISN.

For the actual test configuration, please refer to the attached file (Test Setup Photo).

6.5.2 Test Procedure

- The EUT was placed on a 0.8 meter to the top of table and placed 0.4 meters from the conducting wall of the shielded room with EUT being connected to the power mains through a line impedance stabilization network (LISN). Other support units were connected to the power mains through another LISN. The two LISNs provide 50 ohm/ 50 uH of coupling impedance for the measuring instrument.
- Both lines of the power mains connected to the EUT were checked for maximum conducted interference.
- The frequency range from 150 kHz to 30 MHz was searched. Emission levels under (Limit – 20 dB) was not recorded.

Note: The resolution bandwidth and video bandwidth of test receiver is 9 kHz for quasi-peak detection (QP) and average detection (AV) at frequency 0.15 MHz-30 MHz.

6.6 Unwanted Emissions below 1 GHz

6.6.1 Test Setup

For Radiated emission below 30 MHz

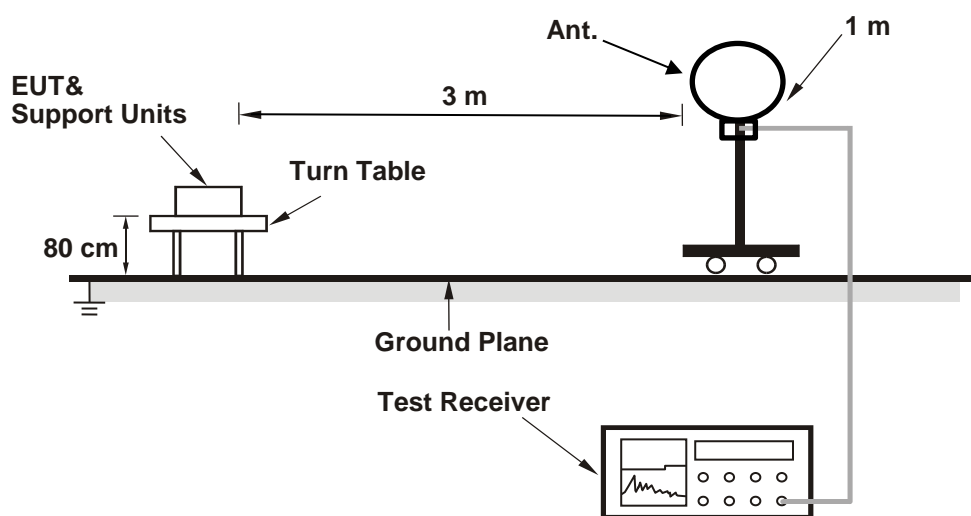

For Radiated emission above 30 MHz

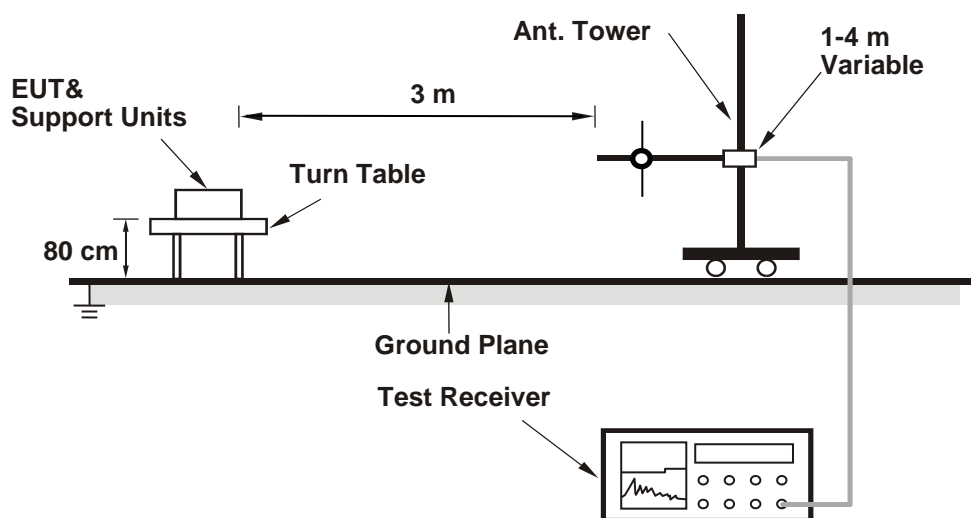

For the actual test configuration, please refer to the attached file (Test Setup Photo).

6.6.2 Test Procedure

For Radiated emission below 30 MHz

- a. The EUT was placed on the top of a rotating table 0.8 meters above the ground at 3 meter chamber room for test. The table was rotated 360 degrees to determine the position of the highest radiation.
- b. The EUT was set 3 meters away from the interference-receiving antenna, which was mounted on the top of a variable-height antenna tower.
- c. Parallel, perpendicular, and ground-parallel orientations of the antenna are set to make the measurement.
- d. For each suspected emission, the EUT was arranged to its worst case and the rotatable table was turned from 0 degrees to 360 degrees to find the maximum reading.
- e. The test-receiver system was set to Quasi-Peak Detect Function and Specified Bandwidth with Maximum Hold Mode, except for the frequency band (9 kHz to 90 kHz and 110 kHz to 490 kHz) set to average detect function and peak detect function.

Notes:

1. The resolution bandwidth and video bandwidth of test receiver/spectrum analyzer is 200 Hz at frequency below 150 kHz.
2. The resolution bandwidth and video bandwidth of test receiver/spectrum analyzer is 9 kHz or 10 kHz at frequency (150 kHz to 30 MHz).
3. All modes of operation were investigated and the worst-case emissions are reported.

For Radiated emission above 30 MHz

- a. The EUT was placed on the top of a rotating table 0.8 meters above the ground at 3 meter chamber room for test. The table was rotated 360 degrees to determine the position of the highest radiation.
- b. The EUT was set 3 meters away from the interference-receiving antenna, which was mounted on the top of a variable-height antenna tower.
- c. The height of antenna is varied from one meter to four meters above the ground to determine the maximum value of the field strength. Both horizontal and vertical polarizations of the antenna are set to make the measurement.
- d. For each suspected emission, the EUT was arranged to its worst case and then the antenna was tuned to heights from 1 meter to 4 meters and the rotatable table was turned from 0 degrees to 360 degrees to find the maximum reading.
- e. The test-receiver system was set to quasi-peak detect function and specified bandwidth with maximum hold mode when the test frequency is below 1 GHz.

Notes:

1. The resolution bandwidth and video bandwidth of test receiver/spectrum analyzer is 120 kHz for Quasi-peak detection (QP) at frequency below 1 GHz.
2. All modes of operation were investigated and the worst-case emissions are reported.

6.7 Unwanted Emissions above 1 GHz

6.7.1 Test Setup

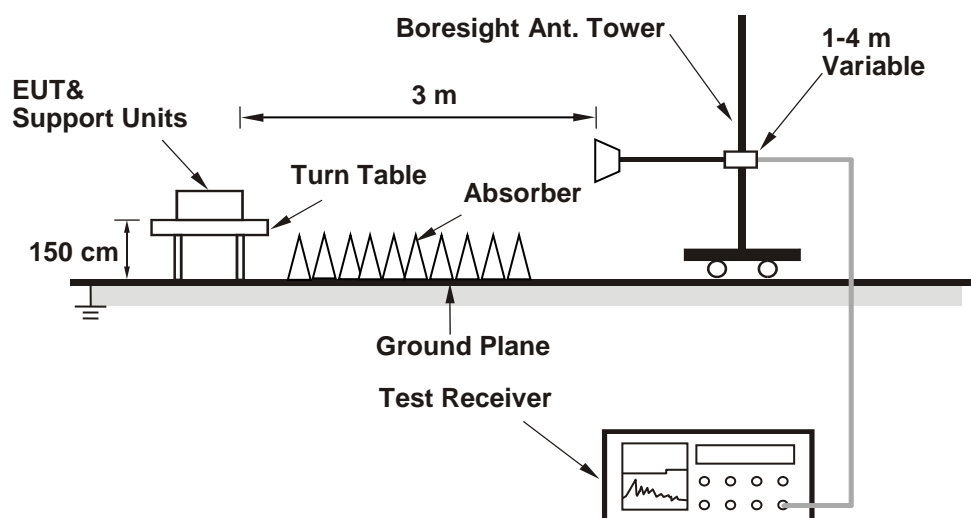

For the actual test configuration, please refer to the attached file (Test Setup Photo).

6.7.2 Test Procedure

- The EUT was placed on the top of a rotating table 1.5 meters above the ground at 3 meter chamber room for test. The table was rotated 360 degrees to determine the position of the highest radiation.
- The EUT was set 3 meters away from the interference-receiving antenna, which was mounted on the top of a variable-height antenna tower.
- The height of antenna is varied from one meter to four meters above the ground to determine the maximum value of the field strength. Both horizontal and vertical polarizations of the antenna are set to make the measurement.
- For each suspected emission, the EUT was arranged to its worst case and then the antenna was tuned to heights from 1 meter to 4 meters and the rotatable table was turned from 0 degrees to 360 degrees to find the maximum reading.
- The test-receiver system was set to peak and average detects function and specified bandwidth with maximum hold mode when the test frequency is above 1 GHz. If the peak reading value also meets average limit, measurement with the average detector is unnecessary.

Notes:

- The resolution bandwidth of test receiver/spectrum analyzer is 1 MHz and the video bandwidth is 3 MHz for Peak detection (PK) and Average detection (AV) at frequency above 1 GHz.
- For fundamental and harmonic signal measurement, the resolution bandwidth of test receiver/spectrum analyzer is 1 MHz and the video bandwidth is $\geq 1/T$ (Duty cycle $< 98\%$) or 10 Hz (Duty cycle $\geq 98\%$) for Average detection (AV) at frequency above 1 GHz.
- All modes of operation were investigated and the worst-case emissions are reported.

7 Test Results of Test Item

7.1 RF Output Power

Input Power:	3.88 Vdc	Environmental Conditions:	25°C, 60% RH	Tested By:	Kevin Ko
--------------	----------	---------------------------	--------------	------------	----------

For Peak Power

802.11b

Chan.	Chan. Freq. (MHz)	Peak Power (mW)	Peak Power (dBm)	Power Limit (dBm)	Test Result
1	2412	150.661	21.78	30	Pass
6	2437	166.725	22.22	30	Pass
11	2462	161.436	22.08	30	Pass

Note: The antenna gain is 2.59 dBi < 6 dBi, so the output power limit shall not be reduced.

802.11g

Chan.	Chan. Freq. (MHz)	Peak Power (mW)	Peak Power (dBm)	Power Limit (dBm)	Test Result
1	2412	162.555	22.11	30	Pass
6	2437	208.449	23.19	30	Pass
11	2462	125.314	20.98	30	Pass

Note: The antenna gain is 2.59 dBi < 6 dBi, so the output power limit shall not be reduced.

802.11n (HT20)

Chan.	Chan. Freq. (MHz)	Peak Power (mW)	Peak Power (dBm)	Power Limit (dBm)	Test Result
1	2412	161.436	22.08	30	Pass
6	2437	200.909	23.03	30	Pass
11	2462	124.738	20.96	30	Pass

Note: The antenna gain is 2.59 dBi < 6 dBi, so the output power limit shall not be reduced.

For Average Power

802.11b

Chan.	Chan. Freq. (MHz)	Average Power (mW)	Average Power (dBm)
1	2412	101.391	20.06
6	2437	105.925	20.25
11	2462	103.276	20.14

802.11g

Chan.	Chan. Freq. (MHz)	Average Power (mW)	Average Power (dBm)
1	2412	78.524	18.95
6	2437	97.051	19.87
11	2462	49.431	16.94

802.11n (HT20)

Chan.	Chan. Freq. (MHz)	Average Power (mW)	Average Power (dBm)
1	2412	75.336	18.77
6	2437	93.756	19.72
11	2462	47.973	16.81

7.2 Power Spectral Density

Input Power:	3.88 Vdc	Environmental Conditions:	25°C, 60% RH	Tested By:	Kevin Ko
--------------	----------	---------------------------	--------------	------------	----------

802.11b

Chan.	Chan. Freq. (MHz)	PSD (dBm/3kHz)	PSD Limit (dBm/3kHz)	Test Result
1	2412	-2.03	8	Pass
6	2437	-1.82	8	Pass
11	2462	-2.14	8	Pass

Note: The antenna gain is 2.59 dBi < 6 dBi, so the power density limit shall not be reduced.

802.11g

Chan.	Chan. Freq. (MHz)	PSD (dBm/3kHz)	PSD Limit (dBm/3kHz)	Test Result
1	2412	-3.58	8	Pass
6	2437	-4.58	8	Pass
11	2462	-6.34	8	Pass

Note: The antenna gain is 2.59 dBi < 6 dBi, so the power density limit shall not be reduced.

802.11n (HT20)

Chan.	Chan. Freq. (MHz)	PSD (dBm/3kHz)	PSD Limit (dBm/3kHz)	Test Result
1	2412	-5.67	8	Pass
6	2437	-4.50	8	Pass
11	2462	-6.82	8	Pass

Note: The antenna gain is 2.59 dBi < 6 dBi, so the power density limit shall not be reduced.



Spectrum Plot of Maximum Value

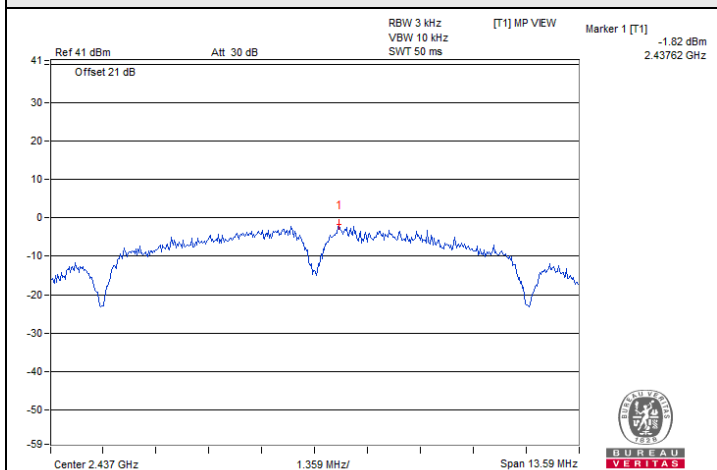

802.11b : CH 6

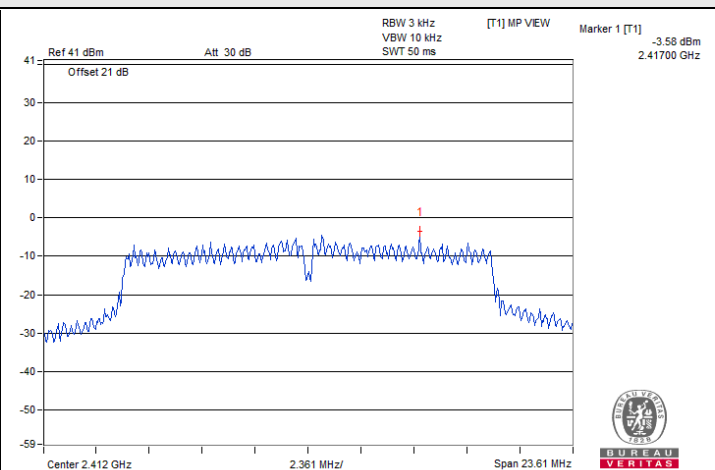

802.11g : CH 1

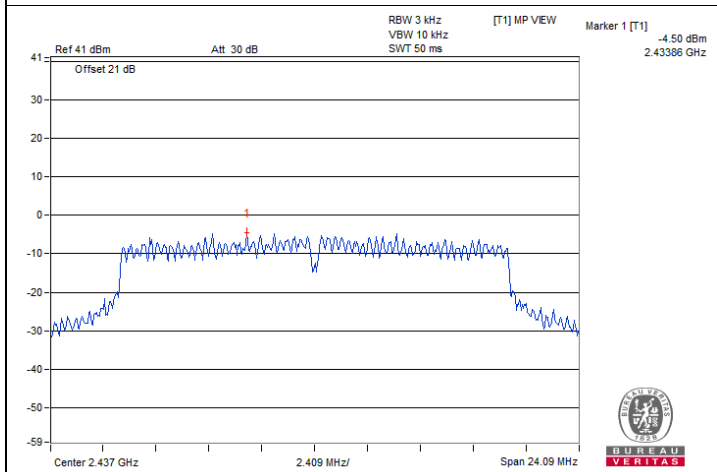

802.11n (HT20) : CH 6

7.3 6 dB Bandwidth

Input Power:	3.88 Vdc	Environmental Conditions:	25°C, 60% RH	Tested By:	Kevin Ko
--------------	----------	---------------------------	--------------	------------	----------

802.11b

Channel	Frequency (MHz)	6 dB Bandwidth (MHz)	Minimum Limit (MHz)	Test Result
1	2412	9.57	0.5	Pass
6	2437	9.06	0.5	Pass
11	2462	9.55	0.5	Pass

802.11g

Channel	Frequency (MHz)	6 dB Bandwidth (MHz)	Minimum Limit (MHz)	Test Result
1	2412	15.74	0.5	Pass
6	2437	16.07	0.5	Pass
11	2462	15.78	0.5	Pass

802.11n (HT20)

Channel	Frequency (MHz)	6 dB Bandwidth (MHz)	Minimum Limit (MHz)	Test Result
1	2412	16.34	0.5	Pass
6	2437	16.06	0.5	Pass
11	2462	16.19	0.5	Pass

Spectrum Plot of Minimum Value

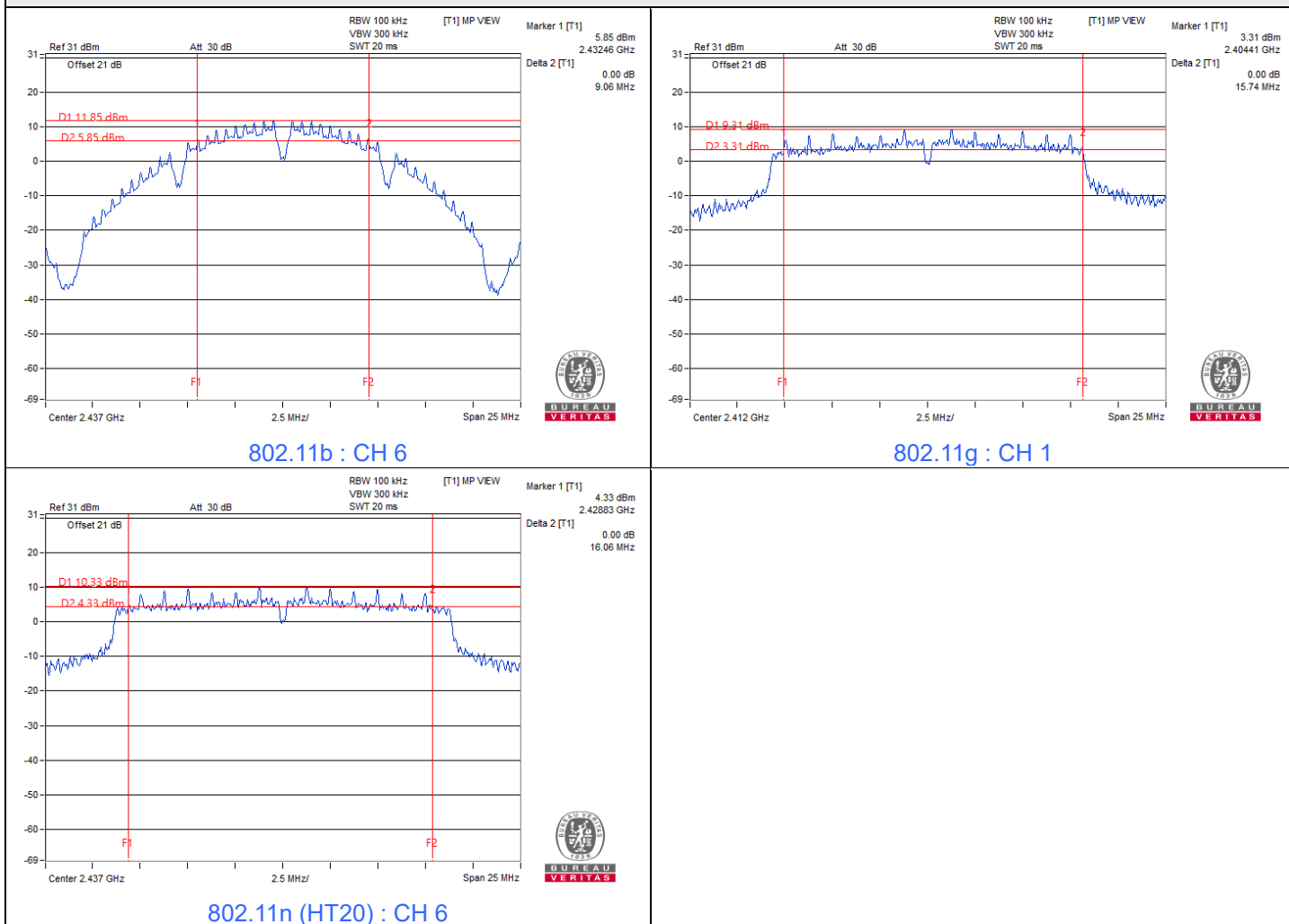



7.4 Conducted Out of Band Emissions

Input Power:	3.88 Vdc	Environmental Conditions:	25°C, 60% RH	Tested By:	Kevin Ko
--------------	----------	---------------------------	--------------	------------	----------

802.11b

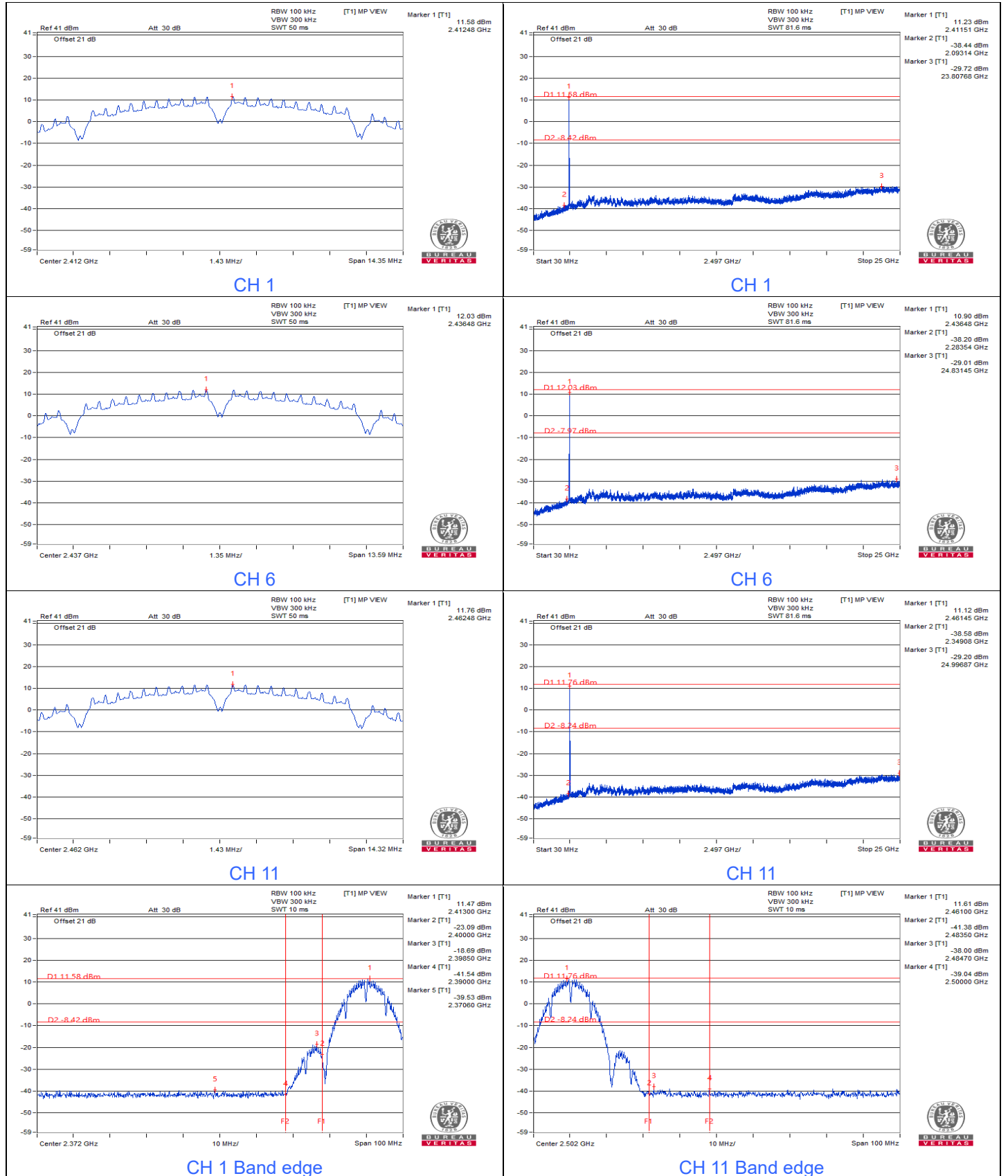



802.11g

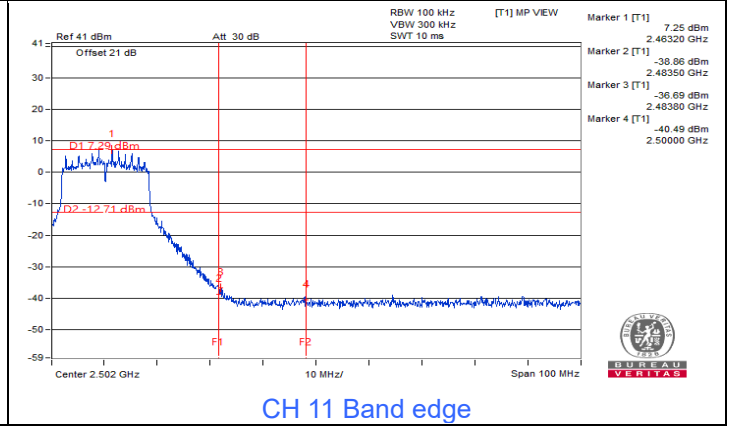
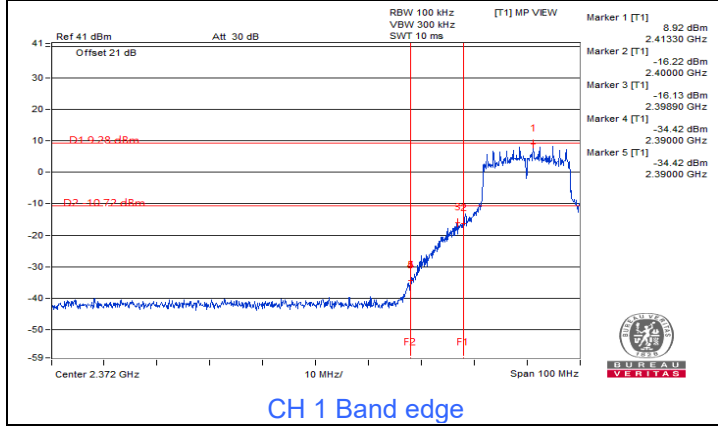
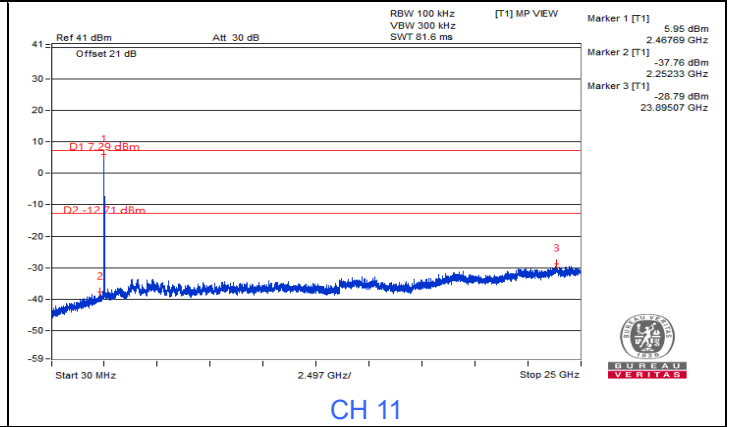
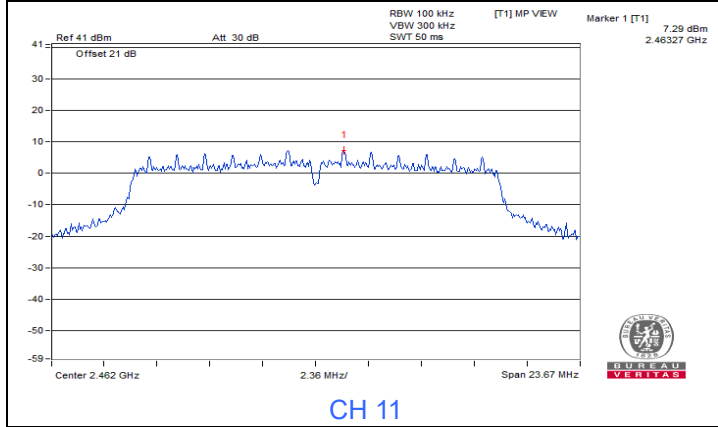
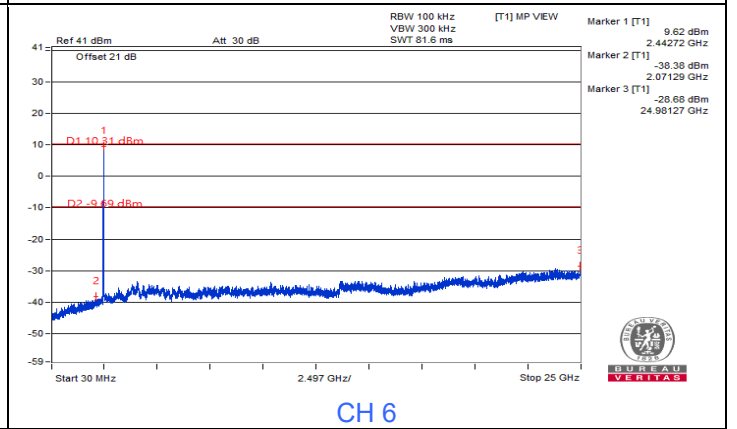
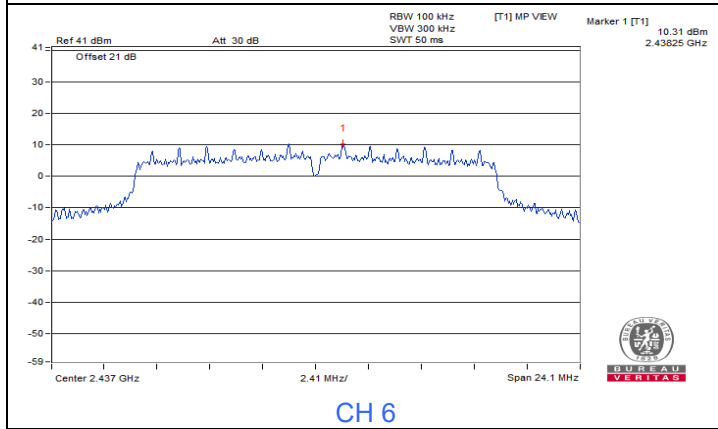
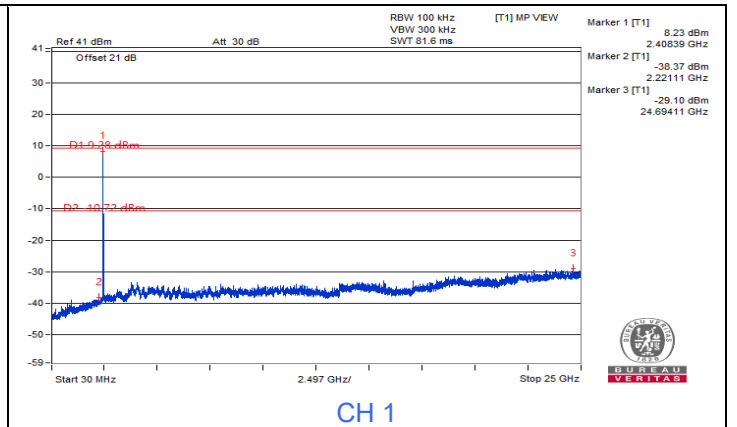
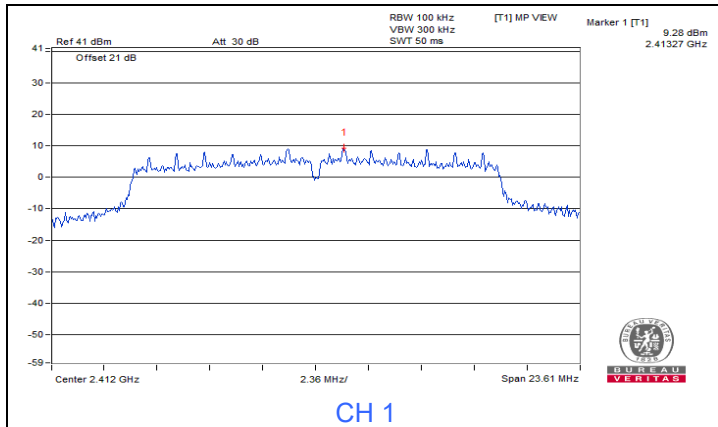



802.11n (HT20)

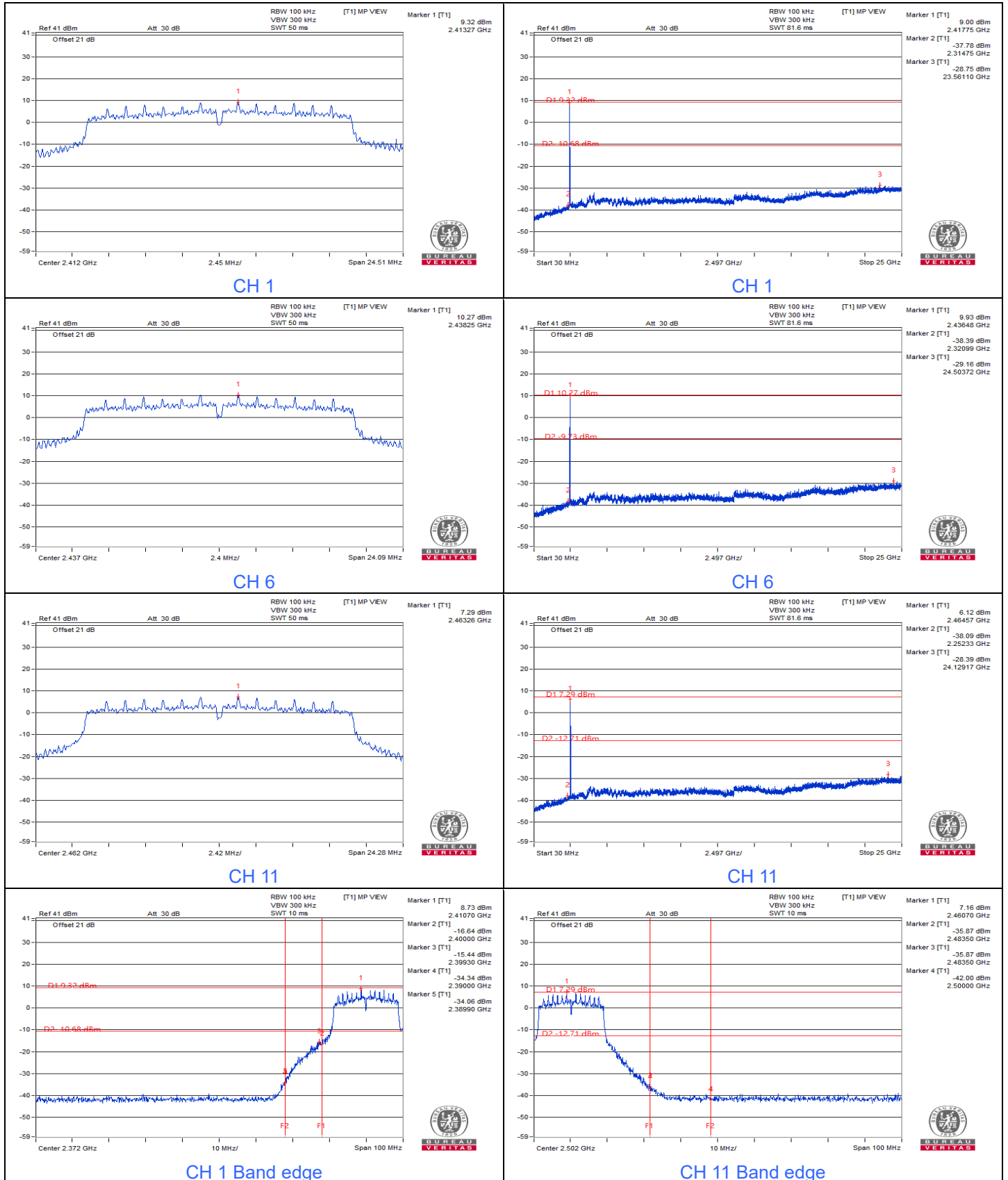

7.5 AC Power Conducted Emissions

RF Mode	802.11b	Channel	CH 6 : 2437 MHz
Frequency Range	150kHz ~ 30MHz	Detector Function & Resolution Bandwidth	Quasi-Peak (QP) / Average (AV), 9 kHz
Input Power (System)	120 Vac, 60 Hz	Environmental Conditions	25°C, 75% RH
Tested By	Ryan Du		

Phase Of Power : Line (L)

No	Frequency (MHz)	Correction Factor (dB)	Reading Value (dBuV)		Emission Level (dBuV)		Limit (dBuV)		Margin (dB)	
			Q.P.	AV.	Q.P.	AV.	Q.P.	AV.	Q.P.	AV.
1	0.15391	9.95	37.98	22.83	47.93	32.78	65.79	55.79	-17.86	-23.01
2	0.18516	9.95	35.66	20.27	45.61	30.22	64.25	54.25	-18.64	-24.03
3	0.59141	9.97	23.01	11.79	32.98	21.76	56.00	46.00	-23.02	-24.24
4	0.95078	10.00	20.96	8.39	30.96	18.39	56.00	46.00	-25.04	-27.61
5	10.13281	10.66	21.32	11.52	31.98	22.18	60.00	50.00	-28.02	-27.82
6	17.32031	11.06	27.09	16.08	38.15	27.14	60.00	50.00	-21.85	-22.86

Remarks:

1. Q.P. and AV. are abbreviations of quasi-peak and average individually.
2. The emission levels of other frequencies were very low against the limit.
3. Margin value = Emission level – Limit value
4. Correction factor = Insertion loss + Cable loss
5. Emission Level = Correction Factor + Reading Value

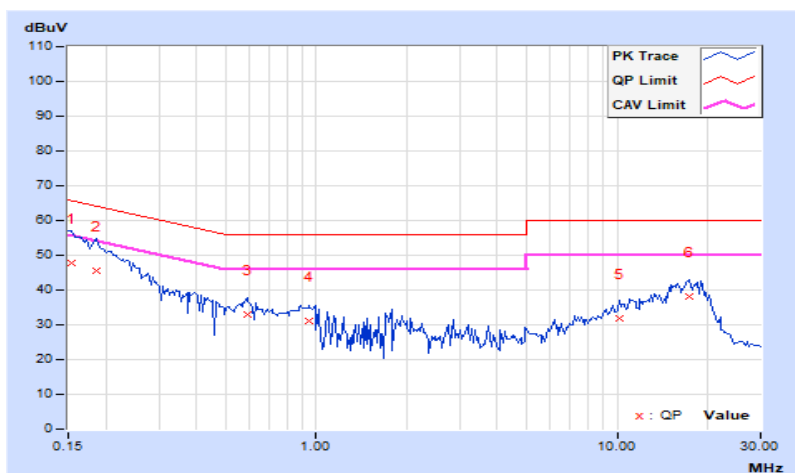

RF Mode	802.11b	Channel	CH 6 : 2437 MHz
Frequency Range	150kHz ~ 30MHz	Detector Function & Resolution Bandwidth	Quasi-Peak (QP) / Average (AV), 9 kHz
Input Power (System)	120 Vac, 60 Hz	Environmental Conditions	25°C, 75% RH
Tested By	Ryan Du		

Phase Of Power : Neutral (N)										
No	Frequency (MHz)	Correction Factor (dB)	Reading Value (dBuV)		Emission Level (dBuV)		Limit (dBuV)		Margin (dB)	
			Q.P.	AV.	Q.P.	AV.	Q.P.	AV.	Q.P.	AV.
1	0.15781	10.00	37.17	23.24	47.17	33.24	65.58	55.58	-18.41	-22.34
2	0.19297	10.00	33.71	20.35	43.71	30.35	63.91	53.91	-20.20	-23.56
3	0.61094	10.02	29.61	21.39	39.63	31.41	56.00	46.00	-16.37	-14.59
4	0.81016	10.04	21.57	13.64	31.61	23.68	56.00	46.00	-24.39	-22.32
5	10.80078	10.68	24.31	15.30	34.99	25.98	60.00	50.00	-25.01	-24.02
6	16.01953	10.89	24.39	16.88	35.28	27.77	60.00	50.00	-24.72	-22.23

Remarks:

1. Q.P. and AV. are abbreviations of quasi-peak and average individually.
2. The emission levels of other frequencies were very low against the limit.
3. Margin value = Emission level – Limit value
4. Correction factor = Insertion loss + Cable loss
5. Emission Level = Correction Factor + Reading Value

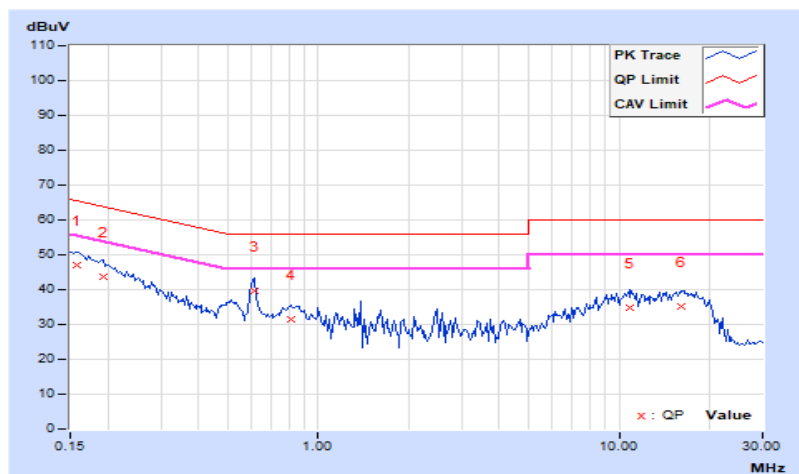

7.6 Unwanted Emissions below 1 GHz

RF Mode	802.11b	Channel	CH 6 : 2437 MHz
Frequency Range	30 MHz ~ 1 GHz	Detector Function & Bandwidth	Quasi-Peak (QP), RB = 120kHz
Input Power (System)	120 Vac, 60 Hz	Environmental Conditions	25°C, 65% RH
Tested By	Ryan Du		

Antenna Polarity & Test Distance : Horizontal at 3 m

No	Frequency (MHz)	Emission Level (dBuV/m)	Limit (dBuV/m)	Margin (dB)	Antenna Height (m)	Table Angle (Degree)	Raw Value (dBuV)	Correction Factor (dB/m)
1	32.26	25.2 QP	40.0	-14.8	3.00 H	331	38.3	-13.1
2	132.08	24.2 QP	43.5	-19.3	2.00 H	246	37.5	-13.3
3	179.19	24.4 QP	43.5	-19.1	2.00 H	133	38.0	-13.6
4	288.00	19.6 QP	46.0	-26.4	1.00 H	360	31.5	-11.9
5	409.20	22.4 QP	46.0	-23.6	1.00 H	320	31.1	-8.7
6	600.85	26.1 QP	46.0	-19.9	3.00 H	360	30.1	-4.0

Remarks:

1. Emission Level(dBuV/m) = Raw Value(dBuV) + Correction Factor(dB/m)
2. Correction Factor(dB/m) = Antenna Factor(dB/m) + Cable Factor(dB) – Pre-Amplifier Factor(dB)
3. Margin value = Emission Level – Limit value
4. The other emission levels were very low against the limit of frequency range 30 MHz ~ 1 GHz.
5. The frequency range 9 kHz ~ 30 MHz: all emissions are more than 20 dB below the limit, therefore do not be recorded in this report.

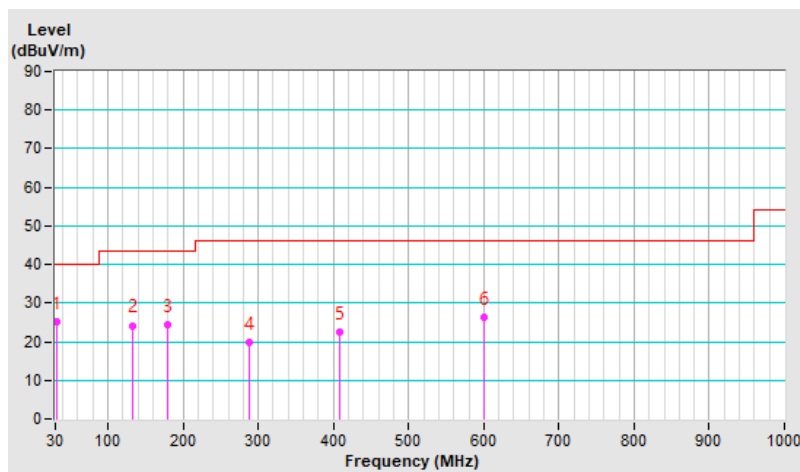

RF Mode	802.11b	Channel	CH 6 : 2437 MHz
Frequency Range	30 MHz ~ 1 GHz	Detector Function & Bandwidth	Quasi-Peak (QP), RB = 120kHz
Input Power (System)	120 Vac, 60 Hz	Environmental Conditions	25°C, 65% RH
Tested By	Ryan Du		

Antenna Polarity & Test Distance : Vertical at 3 m								
No	Frequency (MHz)	Emission Level (dBuV/m)	Limit (dBuV/m)	Margin (dB)	Antenna Height (m)	Table Angle (Degree)	Raw Value (dBuV)	Correction Factor (dB/m)
1	32.73	30.4 QP	40.0	-9.6	1.00 V	227	43.5	-13.1
2	59.47	26.4 QP	40.0	-13.6	1.00 V	38	39.4	-13.0
3	74.84	25.1 QP	40.0	-14.9	1.00 V	329	40.9	-15.8
4	131.27	19.6 QP	43.5	-23.9	1.00 V	0	32.9	-13.3
5	266.39	17.2 QP	46.0	-28.8	1.00 V	271	29.9	-12.7
6	477.34	22.8 QP	46.0	-23.2	3.00 V	57	29.8	-7.0

Remarks:

1. Emission Level(dBuV/m) = Raw Value(dBuV) + Correction Factor(dB/m)
2. Correction Factor(dB/m) = Antenna Factor(dB/m) + Cable Factor(dB) – Pre-Amplifier Factor(dB)
3. Margin value = Emission Level – Limit value
4. The other emission levels were very low against the limit of frequency range 30 MHz ~ 1 GHz.
5. The frequency range 9 kHz ~ 30 MHz: all emissions are more than 20 dB below the limit, therefore do not be recorded in this report.

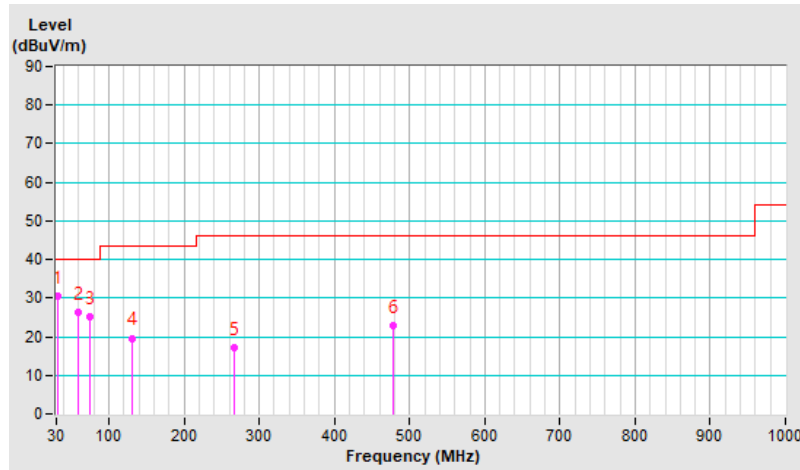

7.7 Unwanted Emissions above 1 GHz

RF Mode	802.11b	Channel	CH 1 : 2412 MHz
Frequency Range	1 GHz ~ 25 GHz	Detector Function & Bandwidth	Peak (PK), RB = 1 MHz, VB = 3 MHz Peak (AV), RB = 1 MHz, VB = 10 Hz
Input Power (System)	120 Vac, 60 Hz	Environmental Conditions	25°C, 75% RH
Tested By	Louis Yang		

Antenna Polarity & Test Distance : Horizontal at 3 m								
No	Frequency (MHz)	Emission Level (dBuV/m)	Limit (dBuV/m)	Margin (dB)	Antenna Height (m)	Table Angle (Degree)	Raw Value (dBuV)	Correction Factor (dB/m)
1	2390.00	56.9 PK	74.0	-17.1	2.72 H	352	59.3	-2.4
2	2390.00	46.1 AV	54.0	-7.9	2.72 H	352	48.5	-2.4
3	*2412.00	104.2 PK			2.72 H	352	106.7	-2.5
4	*2412.00	101.5 AV			2.72 H	352	104.0	-2.5
5	4824.00	42.6 PK	74.0	-31.4	1.04 H	57	40.9	1.7
6	4824.00	40.2 AV	54.0	-13.8	1.04 H	57	38.5	1.7

Remarks:

1. Emission Level(dBuV/m) = Raw Value(dBuV) + Correction Factor(dB/m)
2. Correction Factor(dB/m) = Antenna Factor(dB/m) + Cable Factor(dB) – Pre-Amplifier Factor(dB)
3. Margin value = Emission Level – Limit value
4. The other emission levels were very low against the limit.
5. " * " : Fundamental frequency, the limit was restricted at the RF Output Power.

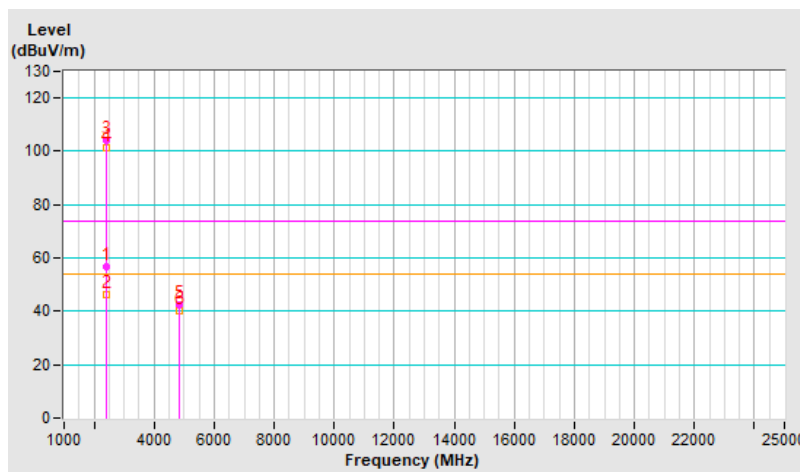

RF Mode	802.11b	Channel	CH 1 : 2412 MHz
Frequency Range	1 GHz ~ 25 GHz	Detector Function & Bandwidth	Peak (PK), RB = 1 MHz, VB = 3 MHz Peak (AV), RB = 1 MHz, VB = 10 Hz
Input Power (System)	120 Vac, 60 Hz	Environmental Conditions	25°C, 75% RH
Tested By	Louis Yang		

Antenna Polarity & Test Distance : Vertical at 3 m								
No	Frequency (MHz)	Emission Level (dBuV/m)	Limit (dBuV/m)	Margin (dB)	Antenna Height (m)	Table Angle (Degree)	Raw Value (dBuV)	Correction Factor (dB/m)
1	2390.00	58.5 PK	74.0	-15.5	1.75 V	19	60.9	-2.4
2	2390.00	50.4 AV	54.0	-3.6	1.75 V	19	52.8	-2.4
3	*2412.00	111.3 PK			1.75 V	19	113.8	-2.5
4	*2412.00	108.9 AV			1.75 V	19	111.4	-2.5
5	4824.00	46.5 PK	74.0	-27.5	3.08 V	345	44.8	1.7
6	4824.00	45.3 AV	54.0	-8.7	3.08 V	345	43.6	1.7

Remarks:

1. Emission Level(dBuV/m) = Raw Value(dBuV) + Correction Factor(dB/m)
2. Correction Factor(dB/m) = Antenna Factor(dB/m) + Cable Factor(dB) – Pre-Amplifier Factor(dB)
3. Margin value = Emission Level – Limit value
4. The other emission levels were very low against the limit.
5. " * " : Fundamental frequency, the limit was restricted at the RF Output Power.

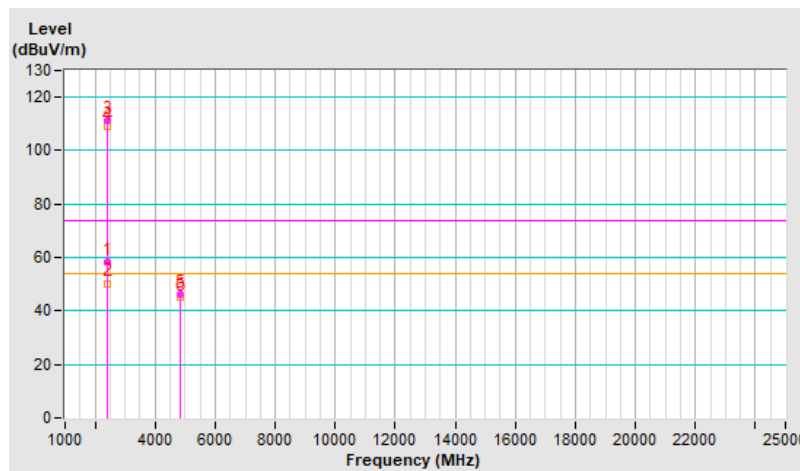

RF Mode	802.11b	Channel	CH 6 : 2437 MHz
Frequency Range	1 GHz ~ 25 GHz	Detector Function & Bandwidth	Peak (PK), RB = 1 MHz, VB = 3 MHz Peak (AV), RB = 1 MHz, VB = 10 Hz
Input Power (System)	120 Vac, 60 Hz	Environmental Conditions	25°C, 75% RH
Tested By	Louis Yang		

Antenna Polarity & Test Distance : Horizontal at 3 m								
No	Frequency (MHz)	Emission Level (dBuV/m)	Limit (dBuV/m)	Margin (dB)	Antenna Height (m)	Table Angle (Degree)	Raw Value (dBuV)	Correction Factor (dB/m)
1	2390.00	55.6 PK	74.0	-18.4	3.00 H	337	58.0	-2.4
2	2390.00	43.7 AV	54.0	-10.3	3.00 H	337	46.1	-2.4
3	*2437.00	103.6 PK			3.00 H	337	106.0	-2.4
4	*2437.00	100.9 AV			3.00 H	337	103.3	-2.4
5	2483.50	56.5 PK	74.0	-17.5	3.00 H	337	58.8	-2.3
6	2483.50	44.2 AV	54.0	-9.8	3.00 H	337	46.5	-2.3
7	4874.00	42.8 PK	74.0	-31.2	1.09 H	44	41.1	1.7
8	4874.00	40.5 AV	54.0	-13.5	1.09 H	44	38.8	1.7
9	7311.00	44.5 PK	74.0	-29.5	1.12 H	247	36.6	7.9
10	7311.00	31.9 AV	54.0	-22.1	1.12 H	247	24.0	7.9

Remarks:

1. Emission Level(dBuV/m) = Raw Value(dBuV) + Correction Factor(dB/m)
2. Correction Factor(dB/m) = Antenna Factor(dB/m) + Cable Factor(dB) – Pre-Amplifier Factor(dB)
3. Margin value = Emission Level – Limit value
4. The other emission levels were very low against the limit.
5. " * " : Fundamental frequency, the limit was restricted at the RF Output Power.

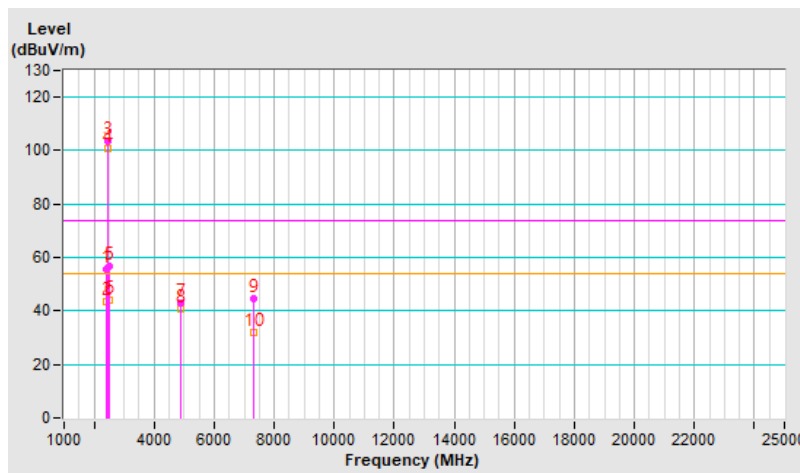

RF Mode	802.11b	Channel	CH 6 : 2437 MHz
Frequency Range	1 GHz ~ 25 GHz	Detector Function & Bandwidth	Peak (PK), RB = 1 MHz, VB = 3 MHz Peak (AV), RB = 1 MHz, VB = 10 Hz
Input Power (System)	120 Vac, 60 Hz	Environmental Conditions	25°C, 75% RH
Tested By	Louis Yang		

Antenna Polarity & Test Distance : Vertical at 3 m								
No	Frequency (MHz)	Emission Level (dBuV/m)	Limit (dBuV/m)	Margin (dB)	Antenna Height (m)	Table Angle (Degree)	Raw Value (dBuV)	Correction Factor (dB/m)
1	2390.00	55.9 PK	74.0	-18.1	2.00 V	20	58.3	-2.4
2	2390.00	43.9 AV	54.0	-10.1	2.00 V	20	46.3	-2.4
3	*2437.00	111.3 PK			2.00 V	20	113.7	-2.4
4	*2437.00	108.6 AV			2.00 V	20	111.0	-2.4
5	2483.50	57.7 PK	74.0	-16.3	2.00 V	20	60.0	-2.3
6	2483.50	48.9 AV	54.0	-5.1	2.00 V	20	51.2	-2.3
7	4874.00	50.6 PK	74.0	-23.4	3.07 V	344	48.9	1.7
8	4874.00	49.1 AV	54.0	-4.9	3.07 V	344	47.4	1.7
9	7311.00	45.0 PK	74.0	-29.0	2.14 V	266	37.1	7.9
10	7311.00	32.4 AV	54.0	-21.6	2.14 V	266	24.5	7.9

Remarks:

1. Emission Level(dBuV/m) = Raw Value(dBuV) + Correction Factor(dB/m)
2. Correction Factor(dB/m) = Antenna Factor(dB/m) + Cable Factor(dB) – Pre-Amplifier Factor(dB)
3. Margin value = Emission Level – Limit value
4. The other emission levels were very low against the limit.
5. " * " : Fundamental frequency, the limit was restricted at the RF Output Power.

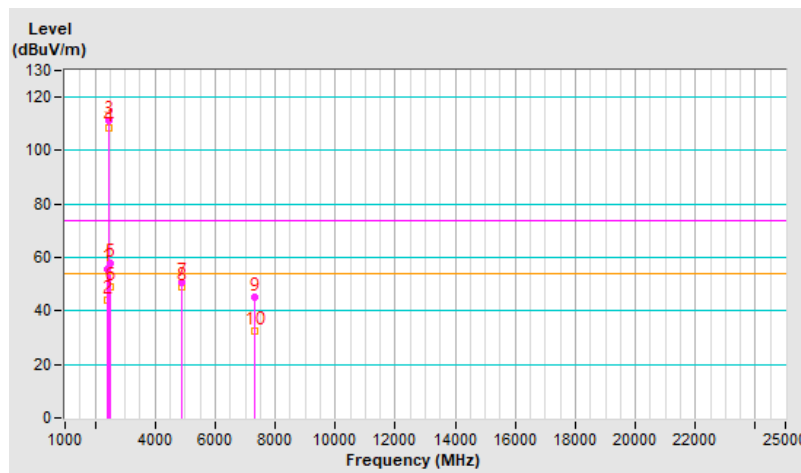

RF Mode	802.11b	Channel	CH 11 : 2462 MHz
Frequency Range	1 GHz ~ 25 GHz	Detector Function & Bandwidth	Peak (PK), RB = 1 MHz, VB = 3 MHz Peak (AV), RB = 1 MHz, VB = 10 Hz
Input Power (System)	120 Vac, 60 Hz	Environmental Conditions	25°C, 75% RH
Tested By	Louis Yang		

Antenna Polarity & Test Distance : Horizontal at 3 m								
No	Frequency (MHz)	Emission Level (dBuV/m)	Limit (dBuV/m)	Margin (dB)	Antenna Height (m)	Table Angle (Degree)	Raw Value (dBuV)	Correction Factor (dB/m)
1	*2462.00	105.1 PK			3.76 H	135	107.4	-2.3
2	*2462.00	102.7 AV			3.76 H	135	105.0	-2.3
3	2483.50	56.7 PK	74.0	-17.3	3.76 H	135	59.0	-2.3
4	2483.50	46.0 AV	54.0	-8.0	3.76 H	135	48.3	-2.3
5	4924.00	43.1 PK	74.0	-30.9	1.11 H	53	41.3	1.8
6	4924.00	40.9 AV	54.0	-13.1	1.11 H	53	39.1	1.8
7	7386.00	34.8 PK	74.0	-39.2	1.06 H	252	27.2	7.6
8	7386.00	22.4 AV	54.0	-31.6	1.06 H	252	14.8	7.6

Remarks:

1. Emission Level(dBuV/m) = Raw Value(dBuV) + Correction Factor(dB/m)
2. Correction Factor(dB/m) = Antenna Factor(dB/m) + Cable Factor(dB) – Pre-Amplifier Factor(dB)
3. Margin value = Emission Level – Limit value
4. The other emission levels were very low against the limit.
5. " * " : Fundamental frequency, the limit was restricted at the RF Output Power.

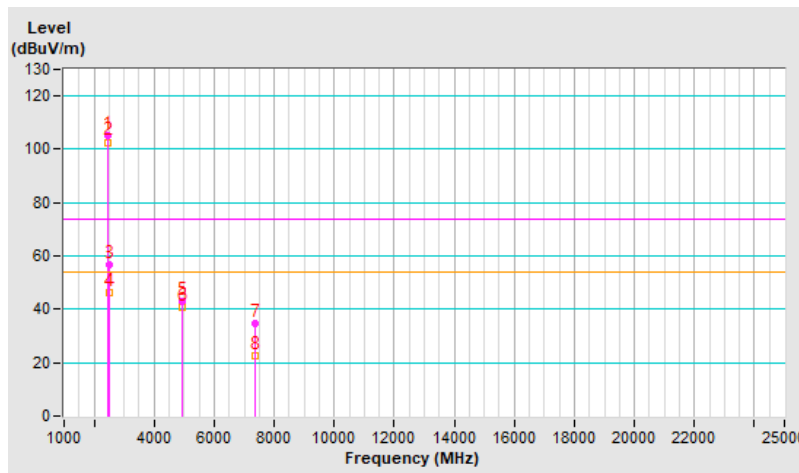

RF Mode	802.11b	Channel	CH 11 : 2462 MHz
Frequency Range	1 GHz ~ 25 GHz	Detector Function & Bandwidth	Peak (PK), RB = 1 MHz, VB = 3 MHz Peak (AV), RB = 1 MHz, VB = 10 Hz
Input Power (System)	120 Vac, 60 Hz	Environmental Conditions	25°C, 75% RH
Tested By	Louis Yang		

Antenna Polarity & Test Distance : Vertical at 3 m								
No	Frequency (MHz)	Emission Level (dBuV/m)	Limit (dBuV/m)	Margin (dB)	Antenna Height (m)	Table Angle (Degree)	Raw Value (dBuV)	Correction Factor (dB/m)
1	*2462.00	110.2 PK			2.72 V	25	112.5	-2.3
2	*2462.00	107.9 AV			2.72 V	25	110.2	-2.3
3	2483.50	60.1 PK	74.0	-13.9	2.72 V	25	62.4	-2.3
4	2483.50	51.5 AV	54.0	-2.5	2.72 V	25	53.8	-2.3
5	4924.00	46.8 PK	74.0	-27.2	3.10 V	360	45.0	1.8
6	4924.00	45.3 AV	54.0	-8.7	3.10 V	360	43.5	1.8
7	7386.00	44.3 PK	74.0	-29.7	2.16 V	266	36.7	7.6
8	7386.00	31.9 AV	54.0	-22.1	2.16 V	266	24.3	7.6

Remarks:

1. Emission Level(dBuV/m) = Raw Value(dBuV) + Correction Factor(dB/m)
2. Correction Factor(dB/m) = Antenna Factor(dB/m) + Cable Factor(dB) – Pre-Amplifier Factor(dB)
3. Margin value = Emission Level – Limit value
4. The other emission levels were very low against the limit.
5. " * " : Fundamental frequency, the limit was restricted at the RF Output Power.

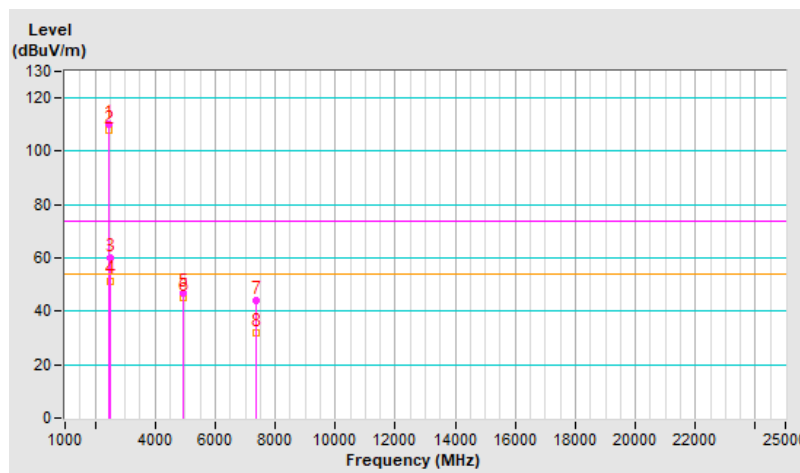

RF Mode	802.11g	Channel	CH 1 : 2412 MHz
Frequency Range	1 GHz ~ 25 GHz	Detector Function & Bandwidth	Peak (PK), RB = 1 MHz, VB = 3 MHz Peak (AV), RB = 1 MHz, VB = 10 Hz
Input Power (System)	120 Vac, 60 Hz	Environmental Conditions	25°C, 75% RH
Tested By	Louis Yang		

Antenna Polarity & Test Distance : Horizontal at 3 m								
No	Frequency (MHz)	Emission Level (dBuV/m)	Limit (dBuV/m)	Margin (dB)	Antenna Height (m)	Table Angle (Degree)	Raw Value (dBuV)	Correction Factor (dB/m)
1	2390.00	56.6 PK	74.0	-17.4	2.75 H	350	59.0	-2.4
2	2390.00	44.2 AV	54.0	-9.8	2.75 H	350	46.6	-2.4
3	*2412.00	103.9 PK			2.75 H	350	106.4	-2.5
4	*2412.00	92.1 AV			2.75 H	350	94.6	-2.5
5	4824.00	42.1 PK	74.0	-31.9	1.13 H	58	40.4	1.7
6	4824.00	40.1 AV	54.0	-13.9	1.13 H	58	38.4	1.7

Remarks:

1. Emission Level(dBuV/m) = Raw Value(dBuV) + Correction Factor(dB/m)
2. Correction Factor(dB/m) = Antenna Factor(dB/m) + Cable Factor(dB) – Pre-Amplifier Factor(dB)
3. Margin value = Emission Level – Limit value
4. The other emission levels were very low against the limit.
5. " * " : Fundamental frequency, the limit was restricted at the RF Output Power.

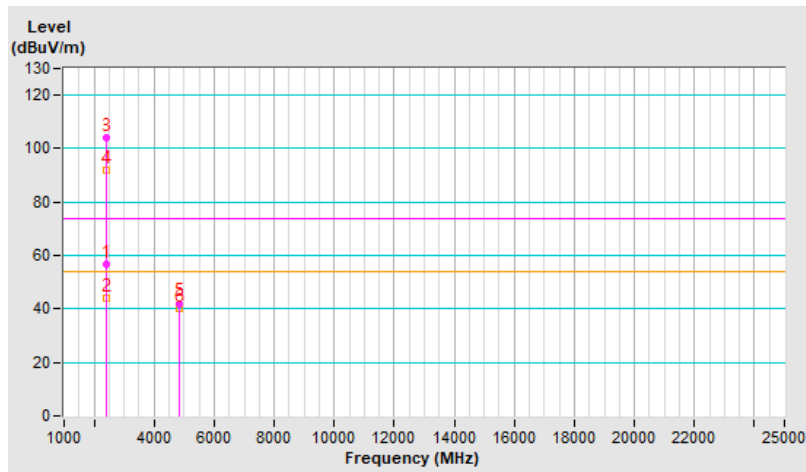

RF Mode	802.11g	Channel	CH 1 : 2412 MHz
Frequency Range	1 GHz ~ 25 GHz	Detector Function & Bandwidth	Peak (PK), RB = 1 MHz, VB = 3 MHz Peak (AV), RB = 1 MHz, VB = 10 Hz
Input Power (System)	120 Vac, 60 Hz	Environmental Conditions	25°C, 75% RH
Tested By	Louis Yang		

Antenna Polarity & Test Distance : Vertical at 3 m								
No	Frequency (MHz)	Emission Level (dBuV/m)	Limit (dBuV/m)	Margin (dB)	Antenna Height (m)	Table Angle (Degree)	Raw Value (dBuV)	Correction Factor (dB/m)
1	2390.00	62.8 PK	74.0	-11.2	1.82 V	28	65.2	-2.4
2	2390.00	50.4 AV	54.0	-3.6	1.82 V	28	52.8	-2.4
3	*2412.00	110.7 PK			1.82 V	28	113.2	-2.5
4	*2412.00	100.9 AV			1.82 V	28	103.4	-2.5
5	4824.00	53.2 PK	74.0	-20.8	1.97 V	18	51.5	1.7
6	4824.00	46.1 AV	54.0	-7.9	1.97 V	18	44.4	1.7

Remarks:

1. Emission Level(dBuV/m) = Raw Value(dBuV) + Correction Factor(dB/m)
2. Correction Factor(dB/m) = Antenna Factor(dB/m) + Cable Factor(dB) – Pre-Amplifier Factor(dB)
3. Margin value = Emission Level – Limit value
4. The other emission levels were very low against the limit.
5. " * " : Fundamental frequency, the limit was restricted at the RF Output Power.

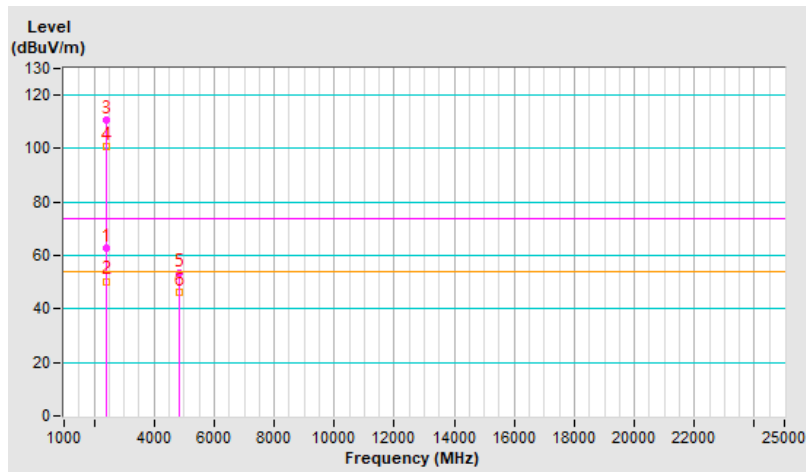

RF Mode	802.11g	Channel	CH 6 : 2437 MHz
Frequency Range	1 GHz ~ 25 GHz	Detector Function & Bandwidth	Peak (PK), RB = 1 MHz, VB = 3 MHz Peak (AV), RB = 1 MHz, VB = 10 Hz
Input Power (System)	120 Vac, 60 Hz	Environmental Conditions	25°C, 75% RH
Tested By	Louis Yang		

Antenna Polarity & Test Distance : Horizontal at 3 m								
No	Frequency (MHz)	Emission Level (dBuV/m)	Limit (dBuV/m)	Margin (dB)	Antenna Height (m)	Table Angle (Degree)	Raw Value (dBuV)	Correction Factor (dB/m)
1	2390.00	58.3 PK	74.0	-15.7	2.98 H	335	60.7	-2.4
2	2390.00	43.8 AV	54.0	-10.2	2.98 H	335	46.2	-2.4
3	*2437.00	107.0 PK			2.98 H	335	109.4	-2.4
4	*2437.00	96.3 AV			2.98 H	335	98.7	-2.4
5	2483.50	58.1 PK	74.0	-15.9	2.98 H	335	60.4	-2.3
6	2483.50	44.1 AV	54.0	-9.9	2.98 H	335	46.4	-2.3
7	4874.00	42.7 PK	74.0	-31.3	1.05 H	59	41.0	1.7
8	4874.00	40.3 AV	54.0	-13.7	1.05 H	59	38.6	1.7
9	7311.00	44.5 PK	74.0	-29.5	1.15 H	261	36.6	7.9
10	7311.00	31.7 AV	54.0	-22.3	1.15 H	261	23.8	7.9

Remarks:

1. Emission Level(dBuV/m) = Raw Value(dBuV) + Correction Factor(dB/m)
2. Correction Factor(dB/m) = Antenna Factor(dB/m) + Cable Factor(dB) – Pre-Amplifier Factor(dB)
3. Margin value = Emission Level – Limit value
4. The other emission levels were very low against the limit.
5. " * " : Fundamental frequency, the limit was restricted at the RF Output Power.

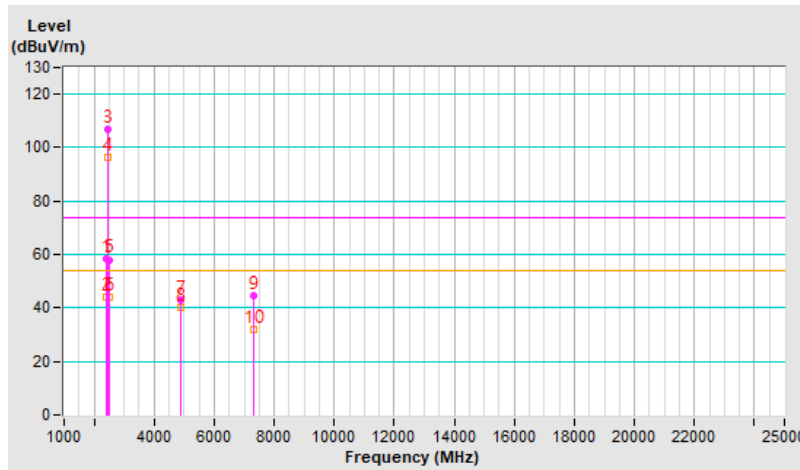

RF Mode	802.11g	Channel	CH 6 : 2437 MHz
Frequency Range	1 GHz ~ 25 GHz	Detector Function & Bandwidth	Peak (PK), RB = 1 MHz, VB = 3 MHz Peak (AV), RB = 1 MHz, VB = 10 Hz
Input Power (System)	120 Vac, 60 Hz	Environmental Conditions	25°C, 75% RH
Tested By	Louis Yang		

Antenna Polarity & Test Distance : Vertical at 3 m								
No	Frequency (MHz)	Emission Level (dBuV/m)	Limit (dBuV/m)	Margin (dB)	Antenna Height (m)	Table Angle (Degree)	Raw Value (dBuV)	Correction Factor (dB/m)
1	2390.00	63.5 PK	74.0	-10.5	2.02 V	22	65.9	-2.4
2	2390.00	44.0 AV	54.0	-10.0	2.02 V	22	46.4	-2.4
3	*2437.00	114.0 PK			2.02 V	22	116.4	-2.4
4	*2437.00	103.8 AV			2.02 V	22	106.2	-2.4
5	2483.50	66.3 PK	74.0	-7.7	2.02 V	22	68.6	-2.3
6	2483.50	49.1 AV	54.0	-4.9	2.02 V	22	51.4	-2.3
7	4874.00	55.6 PK	74.0	-18.4	1.98 V	13	53.9	1.7
8	4874.00	49.3 AV	54.0	-4.7	1.98 V	13	47.6	1.7
9	7311.00	47.2 PK	74.0	-26.8	3.06 V	349	39.3	7.9
10	7311.00	45.6 AV	54.0	-8.4	3.06 V	349	37.7	7.9

Remarks:

1. Emission Level(dBuV/m) = Raw Value(dBuV) + Correction Factor(dB/m)
2. Correction Factor(dB/m) = Antenna Factor(dB/m) + Cable Factor(dB) – Pre-Amplifier Factor(dB)
3. Margin value = Emission Level – Limit value
4. The other emission levels were very low against the limit.
5. " * " : Fundamental frequency, the limit was restricted at the RF Output Power.

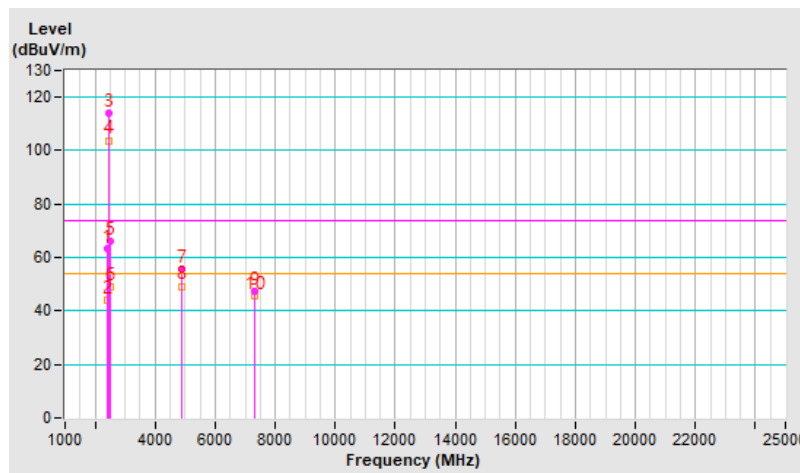

RF Mode	802.11g	Channel	CH 11 : 2462 MHz
Frequency Range	1 GHz ~ 25 GHz	Detector Function & Bandwidth	Peak (PK), RB = 1 MHz, VB = 3 MHz Peak (AV), RB = 1 MHz, VB = 10 Hz
Input Power (System)	120 Vac, 60 Hz	Environmental Conditions	25°C, 75% RH
Tested By	Louis Yang		

Antenna Polarity & Test Distance : Horizontal at 3 m								
No	Frequency (MHz)	Emission Level (dBuV/m)	Limit (dBuV/m)	Margin (dB)	Antenna Height (m)	Table Angle (Degree)	Raw Value (dBuV)	Correction Factor (dB/m)
1	*2462.00	103.8 PK			3.84 H	135	106.1	-2.3
2	*2462.00	92.3 AV			3.84 H	135	94.6	-2.3
3	2483.50	56.1 PK	74.0	-17.9	3.84 H	135	58.4	-2.3
4	2483.50	44.3 AV	54.0	-9.7	3.84 H	135	46.6	-2.3
5	4924.00	43.6 PK	74.0	-30.4	1.15 H	57	41.8	1.8
6	4924.00	36.2 AV	54.0	-17.8	1.15 H	57	34.4	1.8
7	7386.00	44.4 PK	74.0	-29.6	1.17 H	257	36.8	7.6
8	7386.00	31.8 AV	54.0	-22.2	1.17 H	257	24.2	7.6

Remarks:

1. Emission Level(dBuV/m) = Raw Value(dBuV) + Correction Factor(dB/m)
2. Correction Factor(dB/m) = Antenna Factor(dB/m) + Cable Factor(dB) – Pre-Amplifier Factor(dB)
3. Margin value = Emission Level – Limit value
4. The other emission levels were very low against the limit.
5. " * " : Fundamental frequency, the limit was restricted at the RF Output Power.

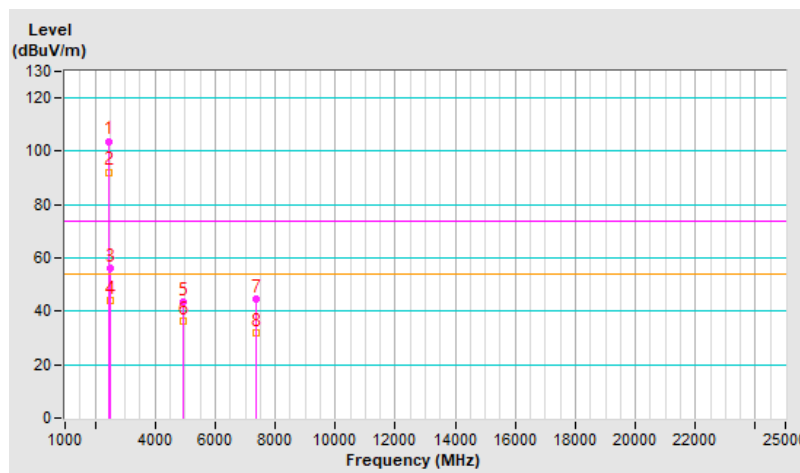

RF Mode	802.11g	Channel	CH 11 : 2462 MHz
Frequency Range	1 GHz ~ 25 GHz	Detector Function & Bandwidth	Peak (PK), RB = 1 MHz, VB = 3 MHz Peak (AV), RB = 1 MHz, VB = 10 Hz
Input Power (System)	120 Vac, 60 Hz	Environmental Conditions	25°C, 75% RH
Tested By	Louis Yang		

Antenna Polarity & Test Distance : Vertical at 3 m								
No	Frequency (MHz)	Emission Level (dBuV/m)	Limit (dBuV/m)	Margin (dB)	Antenna Height (m)	Table Angle (Degree)	Raw Value (dBuV)	Correction Factor (dB/m)
1	*2462.00	109.1 PK			1.72 V	23	111.4	-2.3
2	*2462.00	99.0 AV			1.72 V	23	101.3	-2.3
3	2483.50	65.9 PK	74.0	-8.1	1.72 V	23	68.2	-2.3
4	2483.50	50.8 AV	54.0	-3.2	1.72 V	23	53.1	-2.3
5	4924.00	44.7 PK	74.0	-29.3	2.01 V	22	42.9	1.8
6	4924.00	41.9 AV	54.0	-12.1	2.01 V	22	40.1	1.8
7	7386.00	46.4 PK	74.0	-27.6	3.03 V	355	38.8	7.6
8	7386.00	44.8 AV	54.0	-9.2	3.03 V	355	37.2	7.6

Remarks:

1. Emission Level(dBuV/m) = Raw Value(dBuV) + Correction Factor(dB/m)
2. Correction Factor(dB/m) = Antenna Factor(dB/m) + Cable Factor(dB) – Pre-Amplifier Factor(dB)
3. Margin value = Emission Level – Limit value
4. The other emission levels were very low against the limit.
5. " * " : Fundamental frequency, the limit was restricted at the RF Output Power.

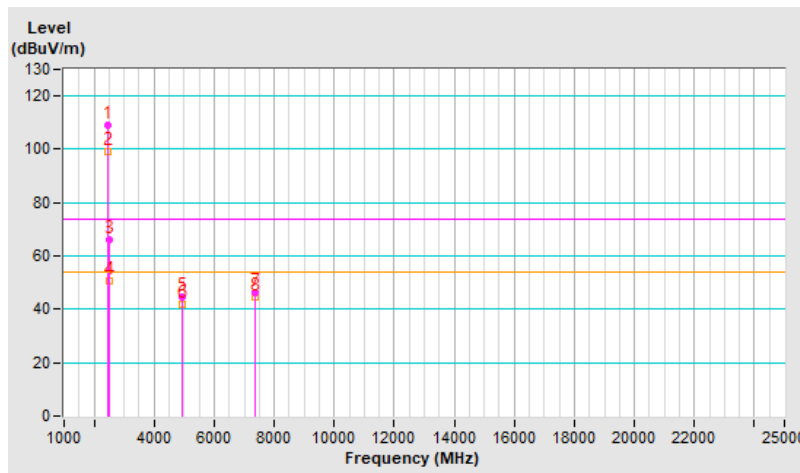

RF Mode	802.11n (HT20)	Channel	CH 1 : 2412 MHz
Frequency Range	1 GHz ~ 25 GHz	Detector Function & Bandwidth	Peak (PK), RB = 1 MHz, VB = 3 MHz Peak (AV), RB = 1 MHz, VB = 10 Hz
Input Power (System)	120 Vac, 60 Hz	Environmental Conditions	25°C, 75% RH
Tested By	Louis Yang		

Antenna Polarity & Test Distance : Horizontal at 3 m								
No	Frequency (MHz)	Emission Level (dBuV/m)	Limit (dBuV/m)	Margin (dB)	Antenna Height (m)	Table Angle (Degree)	Raw Value (dBuV)	Correction Factor (dB/m)
1	2390.00	60.0 PK	74.0	-14.0	3.38 H	341	62.4	-2.4
2	2390.00	47.0 AV	54.0	-7.0	3.38 H	341	49.4	-2.4
3	*2412.00	103.8 PK			3.38 H	341	106.3	-2.5
4	*2412.00	94.3 AV			3.38 H	341	96.8	-2.5
5	4824.00	44.2 PK	74.0	-29.8	1.10 H	39	42.5	1.7
6	4824.00	36.8 AV	54.0	-17.2	1.10 H	39	35.1	1.7

Remarks:

1. Emission Level(dBuV/m) = Raw Value(dBuV) + Correction Factor(dB/m)
2. Correction Factor(dB/m) = Antenna Factor(dB/m) + Cable Factor(dB) – Pre-Amplifier Factor(dB)
3. Margin value = Emission Level – Limit value
4. The other emission levels were very low against the limit.
5. " * " : Fundamental frequency, the limit was restricted at the RF Output Power.

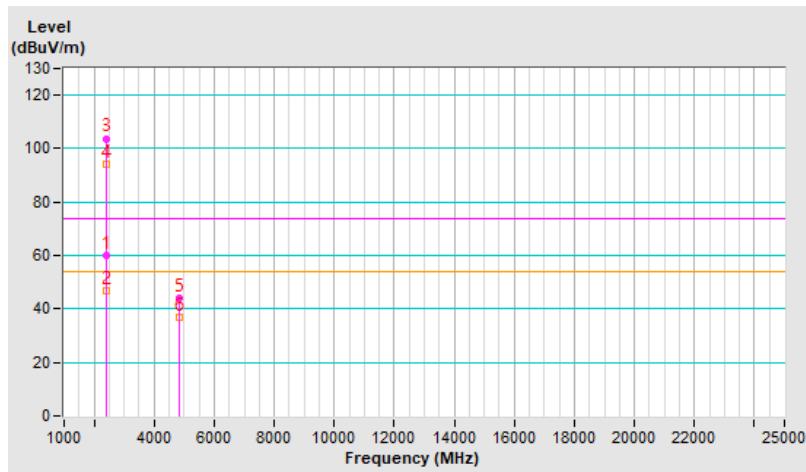

RF Mode	802.11n (HT20)	Channel	CH 1 : 2412 MHz
Frequency Range	1 GHz ~ 25 GHz	Detector Function & Bandwidth	Peak (PK), RB = 1 MHz, VB = 3 MHz Peak (AV), RB = 1 MHz, VB = 10 Hz
Input Power (System)	120 Vac, 60 Hz	Environmental Conditions	25°C, 75% RH
Tested By	Louis Yang		

Antenna Polarity & Test Distance : Vertical at 3 m								
No	Frequency (MHz)	Emission Level (dBuV/m)	Limit (dBuV/m)	Margin (dB)	Antenna Height (m)	Table Angle (Degree)	Raw Value (dBuV)	Correction Factor (dB/m)
1	2390.00	64.9 PK	74.0	-9.1	1.76 V	30	67.3	-2.4
2	2390.00	51.7 AV	54.0	-2.3	1.76 V	30	54.1	-2.4
3	*2412.00	110.6 PK			1.76 V	30	113.1	-2.5
4	*2412.00	100.3 AV			1.76 V	30	102.8	-2.5
5	4824.00	44.5 PK	74.0	-29.5	1.98 V	16	42.8	1.7
6	4824.00	41.9 AV	54.0	-12.1	1.98 V	16	40.2	1.7

Remarks:

1. Emission Level(dBuV/m) = Raw Value(dBuV) + Correction Factor(dB/m)
2. Correction Factor(dB/m) = Antenna Factor(dB/m) + Cable Factor(dB) – Pre-Amplifier Factor(dB)
3. Margin value = Emission Level – Limit value
4. The other emission levels were very low against the limit.
5. " * " : Fundamental frequency, the limit was restricted at the RF Output Power.

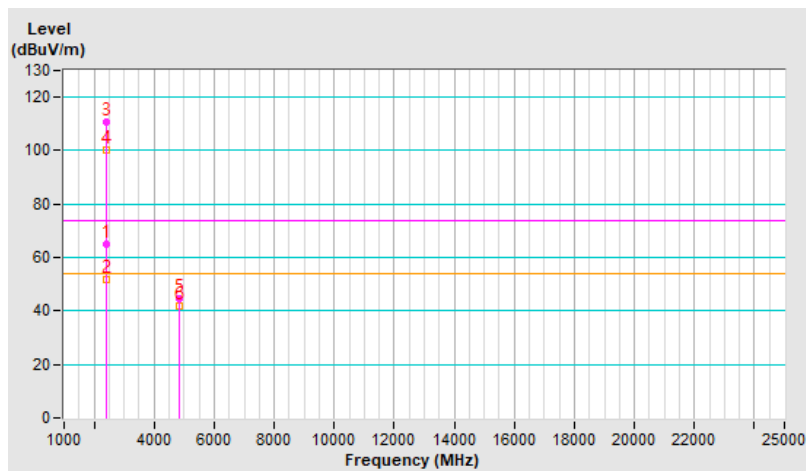

RF Mode	802.11n (HT20)	Channel	CH 6 : 2437 MHz
Frequency Range	1 GHz ~ 25 GHz	Detector Function & Bandwidth	Peak (PK), RB = 1 MHz, VB = 3 MHz Peak (AV), RB = 1 MHz, VB = 10 Hz
Input Power (System)	120 Vac, 60 Hz	Environmental Conditions	25°C, 75% RH
Tested By	Louis Yang		

Antenna Polarity & Test Distance : Horizontal at 3 m								
No	Frequency (MHz)	Emission Level (dBuV/m)	Limit (dBuV/m)	Margin (dB)	Antenna Height (m)	Table Angle (Degree)	Raw Value (dBuV)	Correction Factor (dB/m)
1	2390.00	56.5 PK	74.0	-17.5	3.04 H	342	58.9	-2.4
2	2390.00	43.9 AV	54.0	-10.1	3.04 H	342	46.3	-2.4
3	*2437.00	105.4 PK			3.04 H	342	107.8	-2.4
4	*2437.00	95.8 AV			3.04 H	342	98.2	-2.4
5	2483.50	55.4 PK	74.0	-18.6	3.04 H	342	57.7	-2.3
6	2483.50	44.6 AV	54.0	-9.4	3.04 H	342	46.9	-2.3
7	4874.00	42.7 PK	74.0	-31.3	1.09 H	45	41.0	1.7
8	4874.00	40.7 AV	54.0	-13.3	1.09 H	45	39.0	1.7
9	7311.00	43.7 PK	74.0	-30.3	1.06 H	240	35.8	7.9
10	7311.00	31.4 AV	54.0	-22.6	1.06 H	240	23.5	7.9

Remarks:

1. Emission Level(dBuV/m) = Raw Value(dBuV) + Correction Factor(dB/m)
2. Correction Factor(dB/m) = Antenna Factor(dB/m) + Cable Factor(dB) – Pre-Amplifier Factor(dB)
3. Margin value = Emission Level – Limit value
4. The other emission levels were very low against the limit.
5. " * " : Fundamental frequency, the limit was restricted at the RF Output Power.

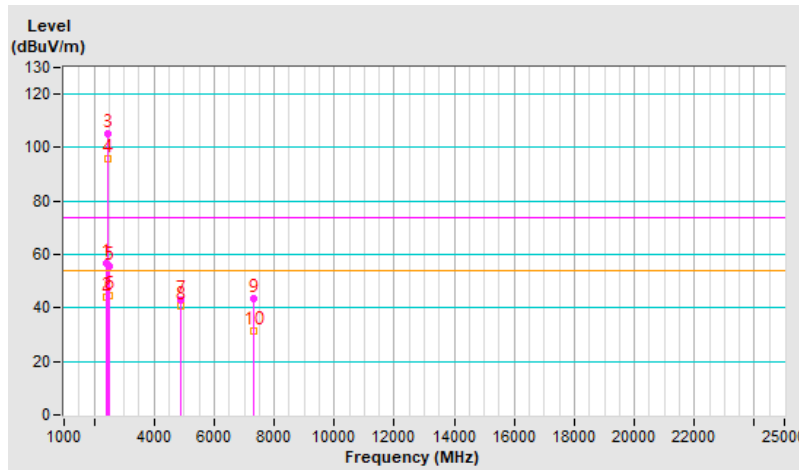

RF Mode	802.11n (HT20)	Channel	CH 6 : 2437 MHz
Frequency Range	1 GHz ~ 25 GHz	Detector Function & Bandwidth	Peak (PK), RB = 1 MHz, VB = 3 MHz Peak (AV), RB = 1 MHz, VB = 10 Hz
Input Power (System)	120 Vac, 60 Hz	Environmental Conditions	25°C, 75% RH
Tested By	Louis Yang		

Antenna Polarity & Test Distance : Vertical at 3 m								
No	Frequency (MHz)	Emission Level (dBuV/m)	Limit (dBuV/m)	Margin (dB)	Antenna Height (m)	Table Angle (Degree)	Raw Value (dBuV)	Correction Factor (dB/m)
1	2390.00	56.0 PK	74.0	-18.0	1.98 V	18	58.4	-2.4
2	2390.00	44.1 AV	54.0	-9.9	1.98 V	18	46.5	-2.4
3	*2437.00	113.9 PK			1.98 V	18	116.3	-2.4
4	*2437.00	103.5 AV			1.98 V	18	105.9	-2.4
5	2483.50	62.3 PK	74.0	-11.7	1.98 V	18	64.6	-2.3
6	2483.50	50.0 AV	54.0	-4.0	1.98 V	18	52.3	-2.3
7	4874.00	50.2 PK	74.0	-23.8	3.05 V	340	48.5	1.7
8	4874.00	48.7 AV	54.0	-5.3	3.05 V	340	47.0	1.7
9	7311.00	45.0 PK	74.0	-29.0	2.14 V	252	37.1	7.9
10	7311.00	32.2 AV	54.0	-21.8	2.14 V	252	24.3	7.9

Remarks:

1. Emission Level(dBuV/m) = Raw Value(dBuV) + Correction Factor(dB/m)
2. Correction Factor(dB/m) = Antenna Factor(dB/m) + Cable Factor(dB) – Pre-Amplifier Factor(dB)
3. Margin value = Emission Level – Limit value
4. The other emission levels were very low against the limit.
5. " * " : Fundamental frequency, the limit was restricted at the RF Output Power.

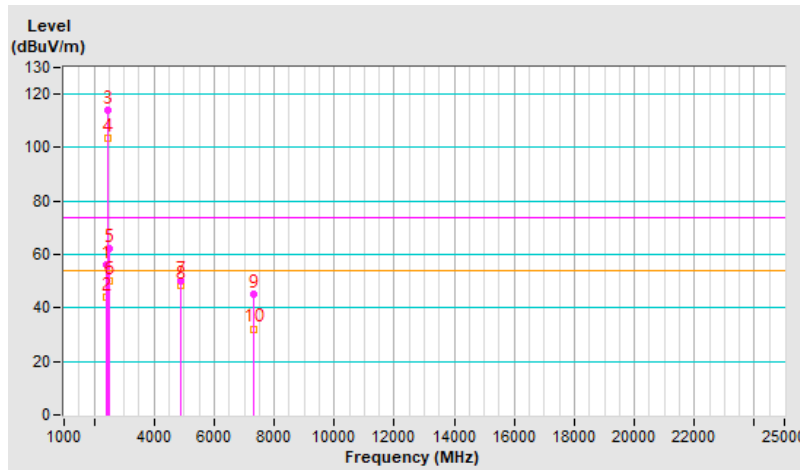

RF Mode	802.11n (HT20)	Channel	CH 11 : 2462 MHz
Frequency Range	1 GHz ~ 25 GHz	Detector Function & Bandwidth	Peak (PK), RB = 1 MHz, VB = 3 MHz Peak (AV), RB = 1 MHz, VB = 10 Hz
Input Power (System)	120 Vac, 60 Hz	Environmental Conditions	25°C, 75% RH
Tested By	Louis Yang		

Antenna Polarity & Test Distance : Horizontal at 3 m								
No	Frequency (MHz)	Emission Level (dBuV/m)	Limit (dBuV/m)	Margin (dB)	Antenna Height (m)	Table Angle (Degree)	Raw Value (dBuV)	Correction Factor (dB/m)
1	*2462.00	103.2 PK			3.76 H	137	105.5	-2.3
2	*2462.00	92.9 AV			3.76 H	137	95.2	-2.3
3	2483.50	61.8 PK	74.0	-12.2	3.76 H	137	64.1	-2.3
4	2483.50	48.7 AV	54.0	-5.3	3.76 H	137	51.0	-2.3
5	4924.00	43.7 PK	74.0	-30.3	1.11 H	45	41.9	1.8
6	4924.00	36.3 AV	54.0	-17.7	1.11 H	45	34.5	1.8
7	7386.00	44.9 PK	74.0	-29.1	1.17 H	252	37.3	7.6
8	7386.00	32.2 AV	54.0	-21.8	1.17 H	252	24.6	7.6

Remarks:

1. Emission Level(dBuV/m) = Raw Value(dBuV) + Correction Factor(dB/m)
2. Correction Factor(dB/m) = Antenna Factor(dB/m) + Cable Factor(dB) – Pre-Amplifier Factor(dB)
3. Margin value = Emission Level – Limit value
4. The other emission levels were very low against the limit.
5. " * " : Fundamental frequency, the limit was restricted at the RF Output Power.

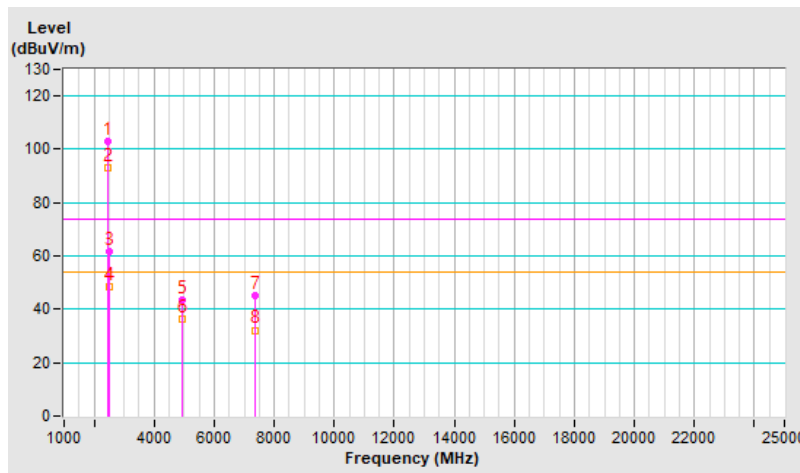

RF Mode	802.11n (HT20)	Channel	CH 11 : 2462 MHz
Frequency Range	1 GHz ~ 25 GHz	Detector Function & Bandwidth	Peak (PK), RB = 1 MHz, VB = 3 MHz Peak (AV), RB = 1 MHz, VB = 10 Hz
Input Power (System)	120 Vac, 60 Hz	Environmental Conditions	25°C, 75% RH
Tested By	Louis Yang		

Antenna Polarity & Test Distance : Vertical at 3 m								
No	Frequency (MHz)	Emission Level (dBuV/m)	Limit (dBuV/m)	Margin (dB)	Antenna Height (m)	Table Angle (Degree)	Raw Value (dBuV)	Correction Factor (dB/m)
1	*2462.00	108.0 PK			1.70 V	24	110.3	-2.3
2	*2462.00	98.5 AV			1.70 V	24	100.8	-2.3
3	2483.50	66.9 PK	74.0	-7.1	1.70 V	24	69.2	-2.3
4	2483.50	52.4 AV	54.0	-1.6	1.70 V	24	54.7	-2.3
5	4924.00	44.6 PK	74.0	-29.4	2.01 V	0	42.8	1.8
6	4924.00	41.9 AV	54.0	-12.1	2.01 V	0	40.1	1.8
7	7386.00	46.1 PK	74.0	-27.9	3.07 V	341	38.5	7.6
8	7386.00	44.3 AV	54.0	-9.7	3.07 V	341	36.7	7.6

Remarks:

1. Emission Level(dBuV/m) = Raw Value(dBuV) + Correction Factor(dB/m)
2. Correction Factor(dB/m) = Antenna Factor(dB/m) + Cable Factor(dB) – Pre-Amplifier Factor(dB)
3. Margin value = Emission Level – Limit value
4. The other emission levels were very low against the limit.
5. " * " : Fundamental frequency, the limit was restricted at the RF Output Power.

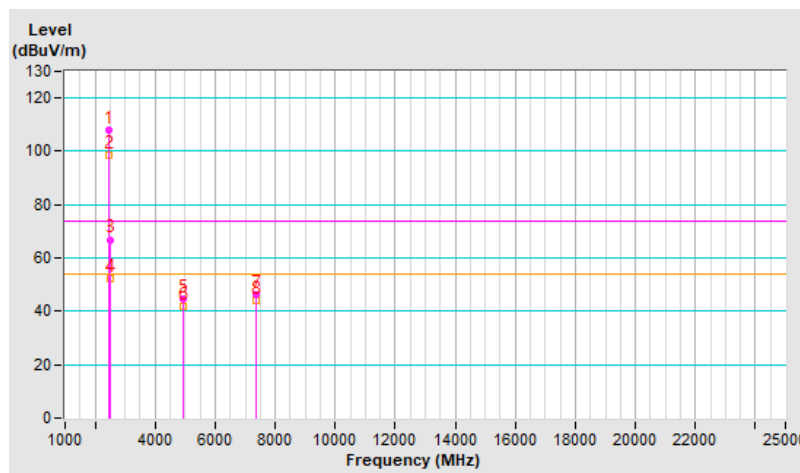

Plot of Band Edge

Frequency Range	2.31 GHz ~ 2.5 GHz	Detector Function & Bandwidth	Peak (PK), RB = 1 MHz, VB = 3 MHz Peak (AV), RB = 1 MHz, VB = 10 Hz
-----------------	--------------------	-------------------------------	--

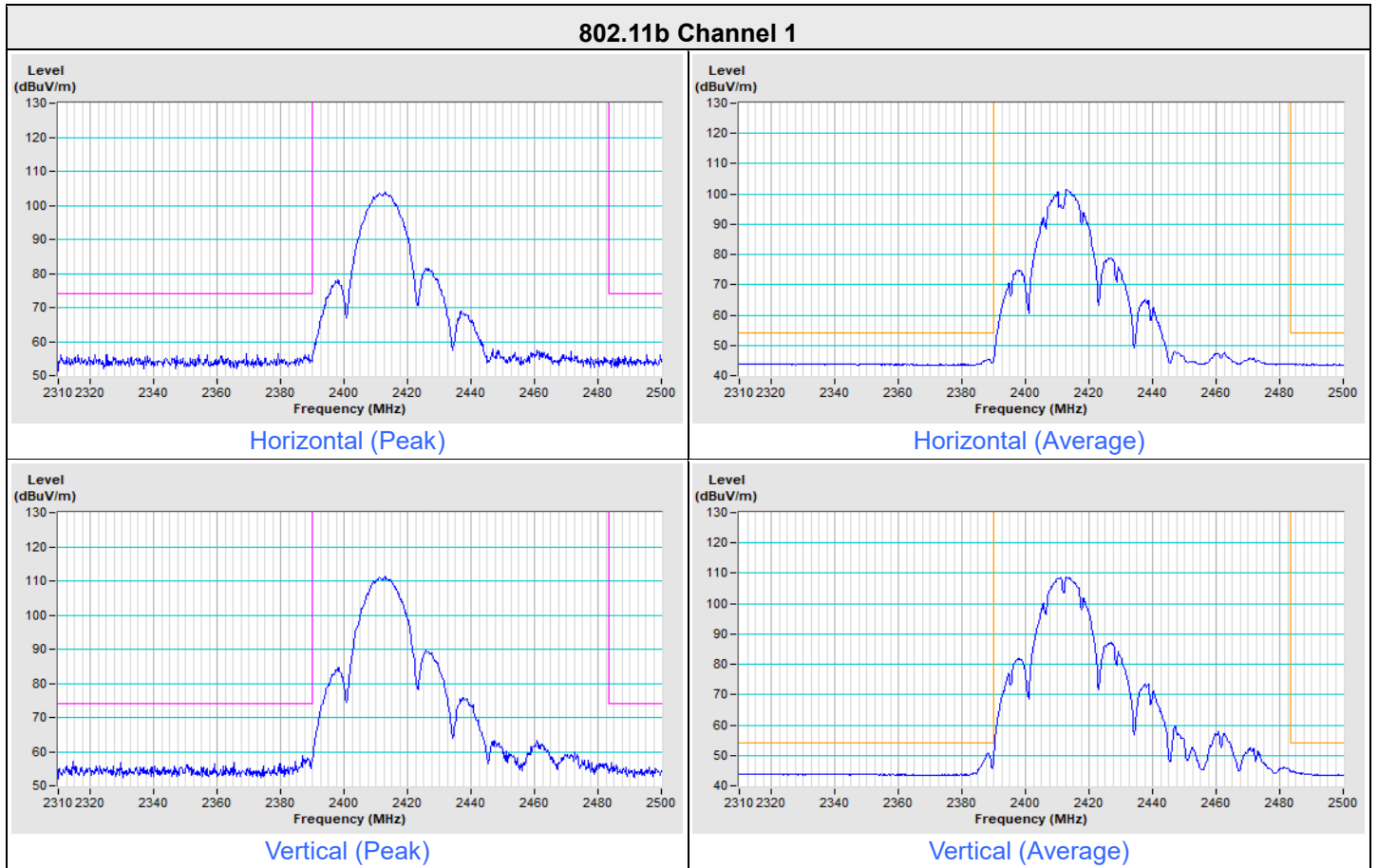

802.11b Channel 11

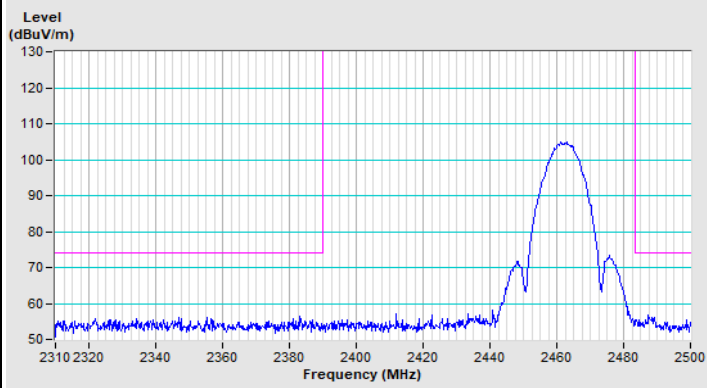

Horizontal (Peak)

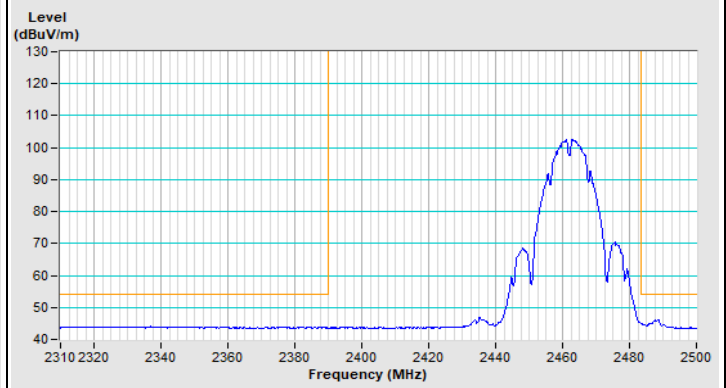

Horizontal (Average)

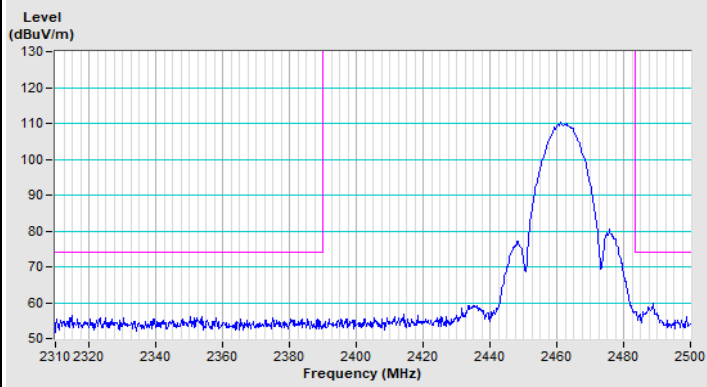

Vertical (Peak)

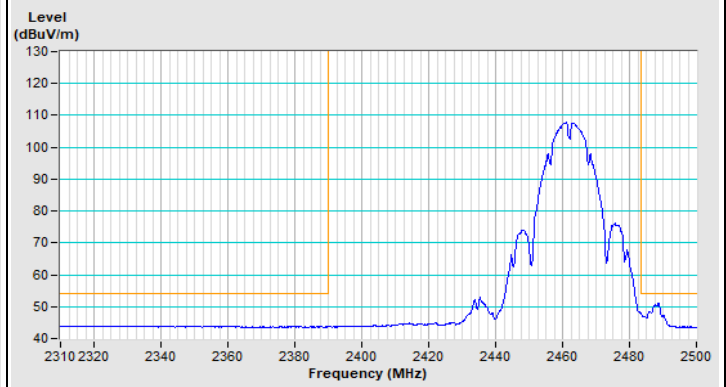

Vertical (Average)

Frequency Range	2.31 GHz ~ 2.5 GHz	Detector Function & Bandwidth	Peak (PK), RB = 1 MHz, VB = 3 MHz Peak (AV), RB = 1 MHz, VB = 10 Hz
-----------------	--------------------	-------------------------------	--

802.11g Channel 1

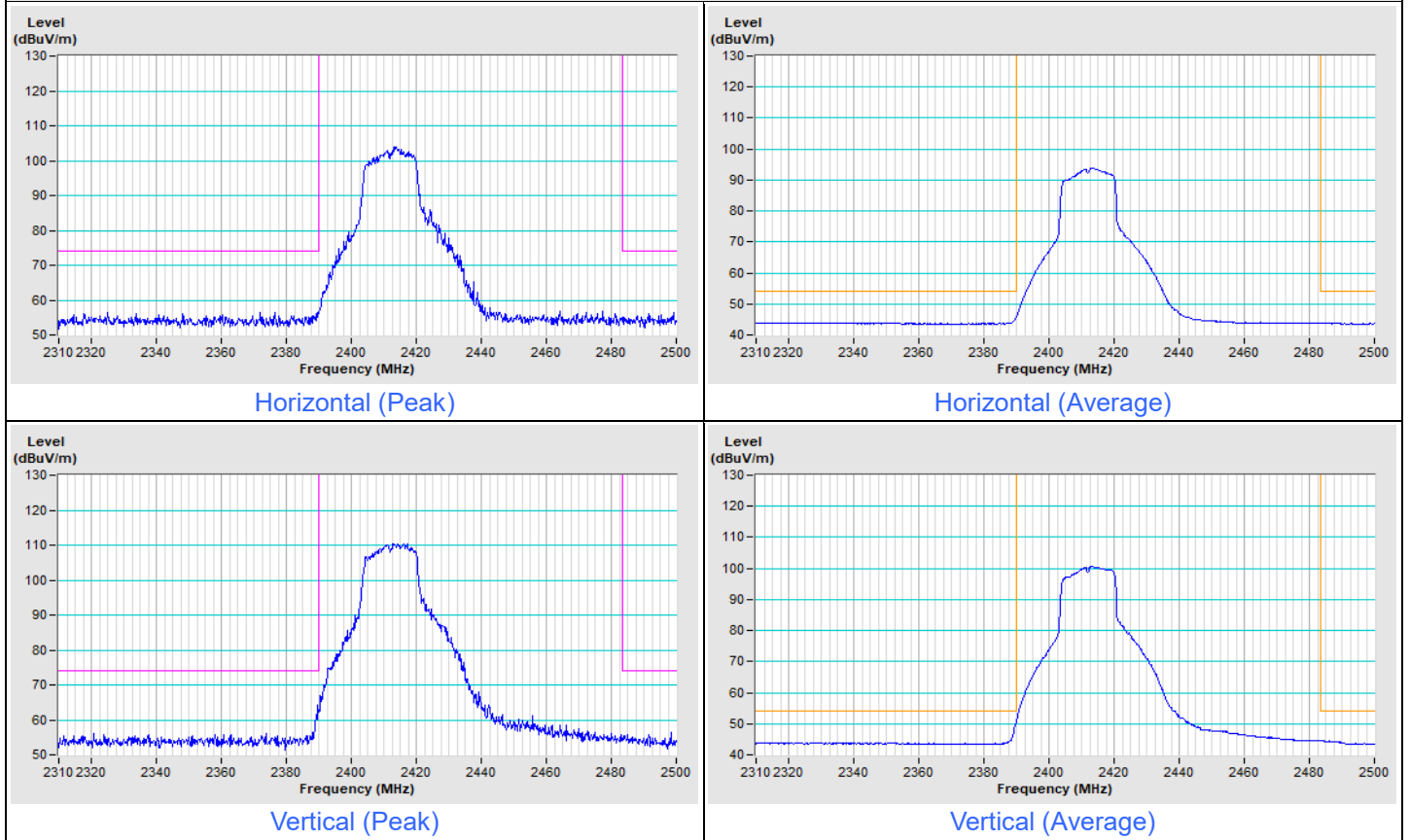

802.11g Channel 11

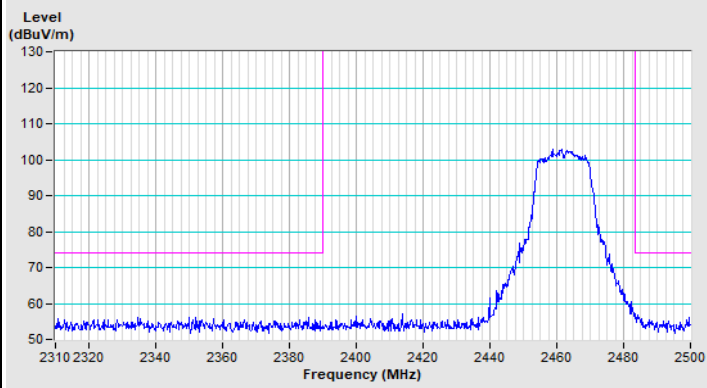

Horizontal (Peak)

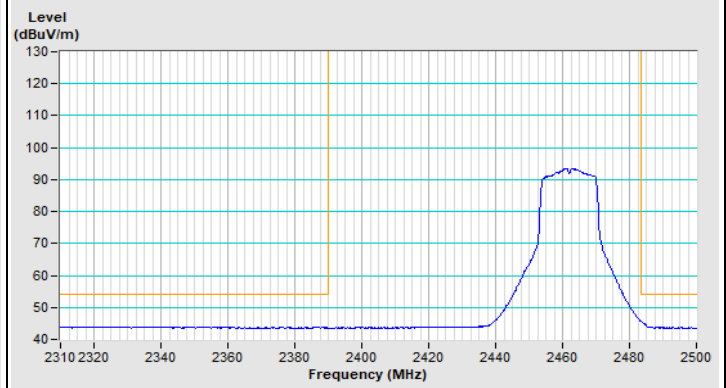

Horizontal (Average)

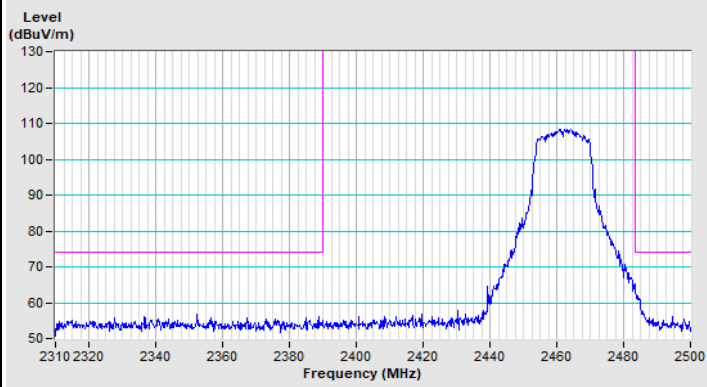

Vertical (Peak)

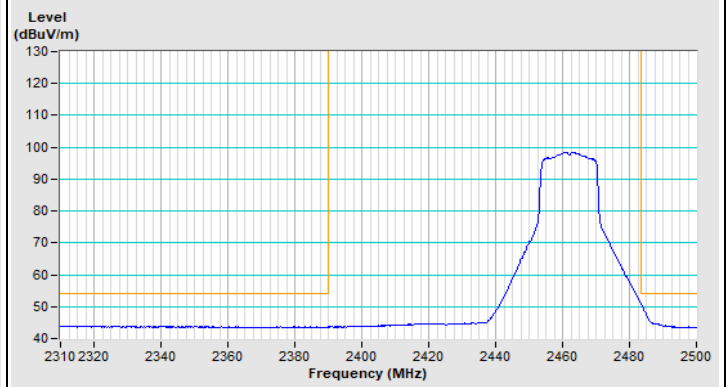

Vertical (Average)

Frequency Range	2.31 GHz ~ 2.5 GHz	Detector Function & Bandwidth	Peak (PK), RB = 1 MHz, VB = 3 MHz Peak (AV), RB = 1 MHz, VB = 10 Hz
-----------------	--------------------	-------------------------------	--

802.11n (HT20) Channel 1

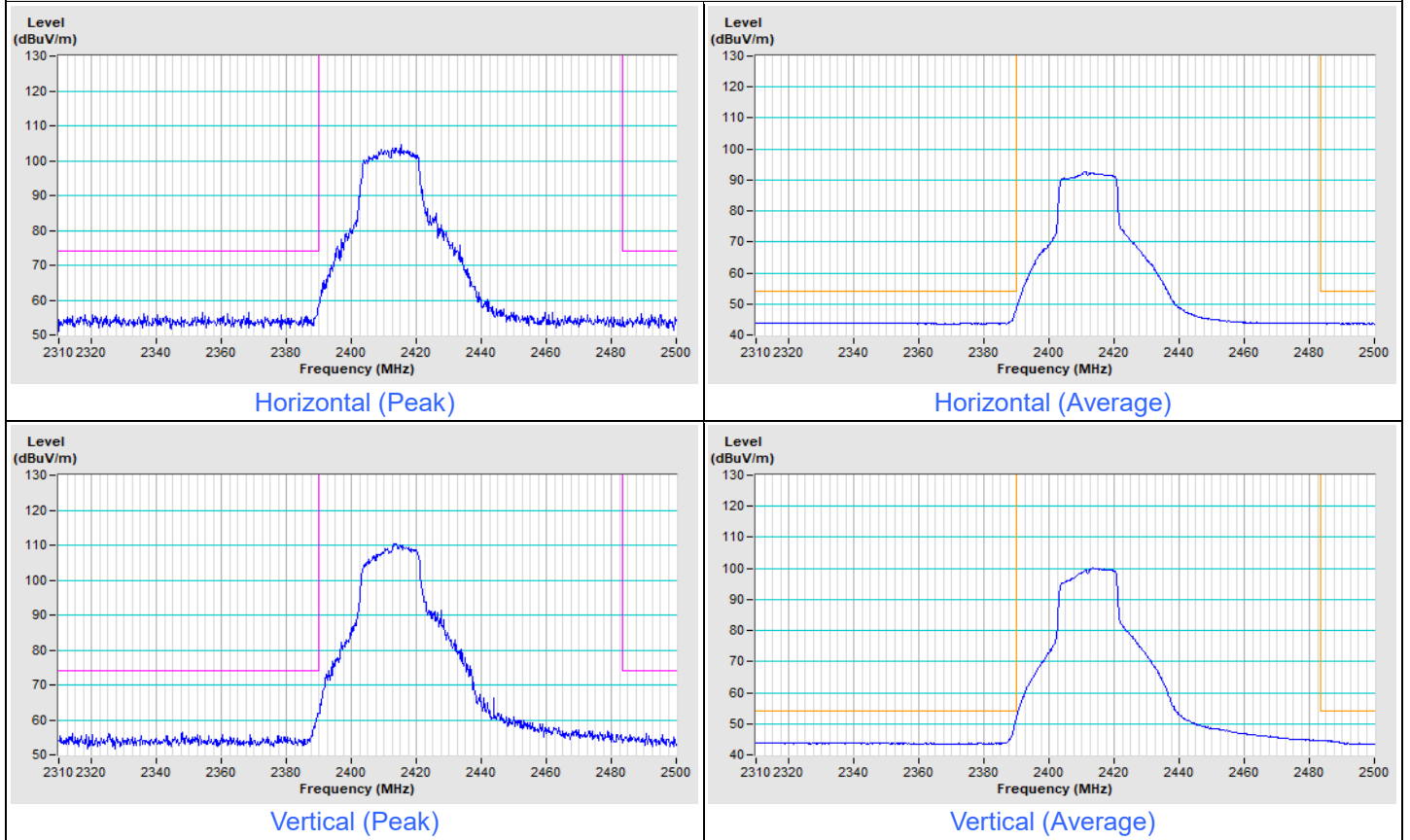

802.11n (HT20) Channel 11

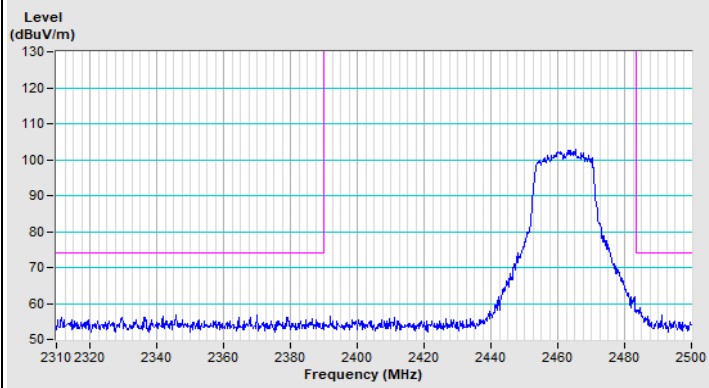

Horizontal (Peak)

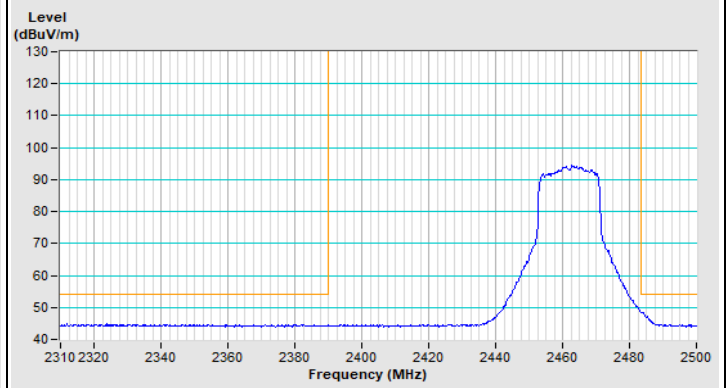

Horizontal (Average)

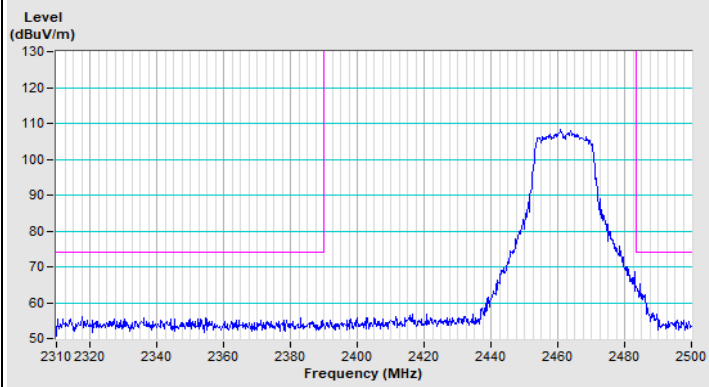

Vertical (Peak)

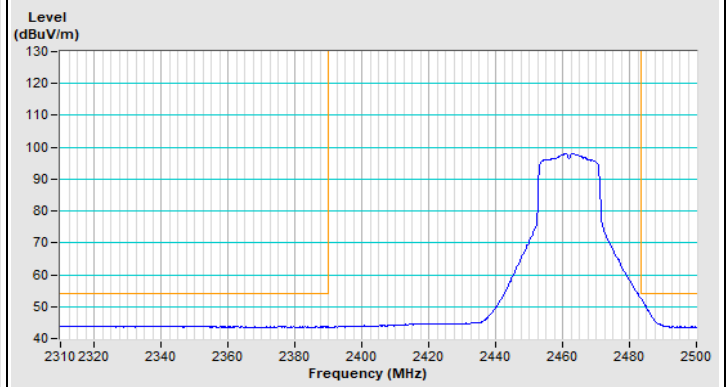

Vertical (Average)

8 Pictures of Test Arrangements

Please refer to the attached file (Test Setup Photo)

9 Information of the Testing Laboratories

We, Bureau Veritas Consumer Products Services (H.K.) Ltd., Taoyuan Branch, were founded in 1988 to provide our best service in EMC, Radio, Telecom and Safety consultation. Our laboratories are FCC recognized accredited test firms and accredited according to ISO/IEC 17025.

If you have any comments, please feel free to contact us at the following:

Lin Kou EMC/RF Lab

Tel: 886-2-26052180

Fax: 886-2-26051924

Hsin Chu EMC/RF/Telecom Lab

Tel: 886-3-6668565

Fax: 886-3-6668323

Hwa Ya EMC/RF/Safety Lab

Tel: 886-3-3183232

Fax: 886-3-3270892

Email: service.adt@bureauveritas.com

Web Site: <http://ee.bureauveritas.com.tw>

The address and road map of all our labs can be found in our web site also.

--- END ---