

## FCC Test Report

**Report No.:** RFBEOE-WTW-P23060395-5

**FCC ID:** MQT-AT150E18U

**Test Model:** XCL\_AT-150-E-18U

**Received Date:** 2023/6/15

**Test Date:** 2023/7/6 ~ 2023/7/24

**Issued Date:** 2023/9/1

**Applicant:** XAC AUTOMATION CORP.

**Address:** 4F, No. 30, INDUSTRY E. RD. IX, SCIENCE-BASED INDUSTRIAL  
PARK,HSINCHU,TAIWAN

**Issued By:** Bureau Veritas Consumer Products Services (H.K.) Ltd., Taoyuan Branch  
Hsin Chu Laboratory

**Lab Address:** E-2, No.1, Li Hsin 1st Road, Hsinchu Science Park, Hsinchu City 300,  
Taiwan

**Test Location:** E-2, No.1, Li Hsin 1st Road, Hsinchu Science Park, Hsinchu City 300,  
Taiwan

**FCC Registration /  
Designation Number:** 723255 / TW2022



This report is governed by, and incorporates by reference, the Conditions of Testing as posted at the date of issuance of this report at <http://www.bureauveritas.com/home/about-us/our-business/cps/about-us/terms-conditions/> and is intended for your exclusive use. Any copying or replication of this report to or for any other person or entity, or use of our name or trademark, is permitted only with our prior written permission. This report sets forth our findings solely with respect to the test samples identified herein. The results set forth in this report are not indicative or representative of the quality or characteristics of the lot from which a test sample was taken or any similar or identical product unless specifically and expressly noted. Our report includes all of the tests requested by you and the results thereof based upon the information that you provided to us. Measurement uncertainty is only provided upon request for accredited tests. Statements of conformity are based on simple acceptance criteria without taking measurement uncertainty into account, unless otherwise requested in writing. You have 60 days from date of issuance of this report to notify us of any material error or omission caused by our negligence or if you require measurement uncertainty; provided, however, that such notice shall be in writing and shall specifically address the issue you wish to raise. A failure to raise such issue within the prescribed time shall constitute your unqualified acceptance of the completeness of this report, the tests conducted and the correctness of the report contents.

## Table of Contents

<b>Release Control Record .....</b>	<b>3</b>
<b>1 Certificate of Conformity .....</b>	<b>4</b>
<b>2 Summary of Test Results .....</b>	<b>5</b>
2.1 Measurement Uncertainty .....	5
2.2 Modification Record .....	5
<b>3 General Information .....</b>	<b>6</b>
3.1 General Description of EUT .....	6
3.2 Description of Test Modes .....	8
3.2.1 Test Mode Applicability and Tested Channel Detail .....	8
3.3 Description of Support Units .....	10
3.3.1 Configuration of System under Test .....	11
3.4 General Description of Applied Standards .....	12
<b>4 Test Types and Results .....</b>	<b>13</b>
4.1 Radiated Emission Measurement .....	13
4.1.1 Limits of Radiated Emission Measurement .....	13
4.1.2 Test Instruments .....	14
4.1.3 Test Procedures .....	16
4.1.4 Deviation from Test Standard .....	16
4.1.5 Test Setup .....	17
4.1.6 EUT Operating Conditions .....	17
4.1.7 Test Results .....	18
4.2 Conducted Emission Measurement .....	32
4.2.1 Limits of Conducted Emission Measurement .....	32
4.2.2 Test Instruments .....	32
4.2.3 Test Procedures .....	33
4.2.4 Deviation from Test Standard .....	33
4.2.5 Test Setup .....	33
4.2.6 EUT Operating Conditions .....	33
4.2.7 Test Results .....	34
4.3 Frequency Stability .....	36
4.3.1 Limits of Frequency Stability Measurement .....	36
4.3.2 Test Setup .....	36
4.3.3 Test Instruments .....	36
4.3.4 Test Procedure .....	36
4.3.5 Deviation from Test Standard .....	36
4.3.6 EUT Operating Conditions .....	36
4.3.7 Test Result .....	37
4.4 20dB Bandwidth .....	38
4.4.1 Limits of 20dB bandwidth Measurement .....	38
4.4.2 Test Setup .....	38
4.4.3 Test Instruments .....	38
4.4.4 Test Procedures .....	38
4.4.5 Deviation from Test Standard .....	38
4.4.6 EUT Operating Conditions .....	38
4.4.7 Test Results .....	39
<b>5 Pictures of Test Arrangements .....</b>	<b>40</b>
<b>Appendix – Information of the Testing Laboratories .....</b>	<b>41</b>

### Release Control Record

Issue No.	Description	Date Issued
RFBEOE-WTW-P23060395-5	Original release.	2023/9/1

## 1 Certificate of Conformity

**Product:** Terminal

**Brand:** XAC

**Test Model:** xCL\_AT-150-E-18U

**Sample Status:** Engineering sample

**Applicant:** XAC AUTOMATION CORP.

**Test Date:** 2023/7/6 ~ 2023/7/24

**Standards:** 47 CFR FCC Part 15, Subpart C (Section 15.225)

47 CFR FCC Part 15, Subpart C (Section 15.215)

ANSI C63.10:2013

The above equipment has been tested by **Bureau Veritas Consumer Products Services (H.K.) Ltd., Taoyuan Branch**, and found compliance with the requirement of the above standards. The test record, data evaluation & Equipment Under Test (EUT) configurations represented herein are true and accurate accounts of the measurements of the sample's EMC characteristics under the conditions specified in this report.

**Prepared by :**                     Vito Lung                    , **Date:**                     2023/9/1                      
Vito Lung / Specialist

**Approved by :**                                         , **Date:**                     2023/9/1                      
May Chen / Manager

## 2 Summary of Test Results

47 CFR FCC Part 15, Subpart C (Section 15.225, 15.215)			
FCC Clause	Test Item	Result	Remarks
15.207	Conducted emission test	Pass	Meet the requirement of limit. Minimum passing margin is 14.85 dB at 0.60703 MHz.
15.225 (a)	The field strength of any emissions within the band 13.553-13.567 MHz	Pass	Meet the requirement of limit. Minimum passing margin is -25.86 dB at 13.773 MHz.
15.225 (b)	The field strength of any emissions within the bands 13.410-13.553 MHz and 13.567-13.710 MHz	Pass	Meet the requirement of limit.
15.225 (c)	The field strength of any emissions within the bands 13.110-13.410 MHz and 13.710-14.010 MHz	Pass	Meet the requirement of limit.
15.225 (d)	The field strength of any emissions appearing outside of the 13.110-14.010 MHz band	Pass	Meet the requirement of limit. Minimum passing margin is -10 dB at 32.76 MHz.
15.225 (e)	The frequency tolerance	Pass	Meet the requirement of limit.
15.215 (c)	20dB Bandwidth	Pass	Meet the requirement of limit.
15.203	Antenna Requirement	Pass	No antenna connector is used.

Note: Determining compliance based on the results of the compliance measurement, not taking into account measurement instrumentation uncertainty.

### 2.1 Measurement Uncertainty

Where relevant, the following measurement uncertainty levels have been estimated for tests performed on the EUT as specified in CISPR 16-4-2:

Measurement	Frequency	Expanded Uncertainty (k=2) ( $\pm$ )
Conducted Emissions at mains ports	150kHz ~ 30MHz	1.9 dB
Radiated Emissions up to 1 GHz	9kHz ~ 30MHz	3.1 dB
	30MHz ~ 1GHz	5.1 dB

### 2.2 Modification Record

There were no modifications required for compliance.

### 3 General Information

#### 3.1 General Description of EUT

Product	Terminal
Brand	XAC
Test Model	xCL_AT-150-E-18U
Status of EUT	Engineering sample
Power Supply Rating	3.88 Vdc from Battery / DC 5V from USB type C or DC 9V from PIGO PIN
Modulation Type	ASK
Transfer Rate	Refer to Note 4
Operating Frequency	13.56 MHz
Number of Channel	1
Antenna Type	Refer to Note
Antenna Connector	Refer to Note

Note:

1. All models are listed as below.

Brand	Model	Difference
XAC	xCL_AT-150-E-18U	For marketing purpose.
Uniform Industrial Corp.	PIXIE-5EU2NSU2W	

From the above models, model: xCL\_AT-150-E-18U was selected as representative model for the test and its data was recorded in this report.

2. The EUT uses following accessories.

Battery 1		
Brand	Model	Power Rating
IES	IDS155GA	3.88V, 3780mAh

3. The EUT has below radios as following table:

Radio 1	Radio 2	Radio 3
WLAN 2.4GHz + WLAN 5GHz + Bluetooth	WWAN(LTE)	NFC

4. Simultaneously transmission condition.

Condition	Technology			
1	WWAN(LTE)	WLAN (2.4 GHz)	WLAN (5 GHz)	NFC
2	WWAN(LTE)	WLAN (5 GHz)	Bluetooth	NFC

Note: The emission of the simultaneous operation has been evaluated and no non-compliance was found.

5. The EUT has one type according to NFC technology as following table:

Mode	Type	Modulation	Data rate
Active	A	ASK	106 kbit/s

6. The antenna information is listed as below.

RF Chain NO.	Brand	Model	Antenna Net Gain(dBi)	Frequency range	Antenna Type	Connector Type
NFC	XAC	RTOS	5	13.56 MHz	Loop	None

7. For the radiated emissions, the EUT was pre-tested under the following modes:

Test Mode	Description
<b>Mode A</b>	Power from battery
Mode B	Power POGO Ping
Mode C	<b>Power USB type C</b>

Note: From the above modes, the worst case was found in **Mode C**. Therefore only the test data of the mode was recorded in this report.

8. For the conducted emissions, the EUT was pre-tested under the following modes:

Test Mode	Description
Mode A	Power POGO Ping
Mode B	<b>Power USB type C</b>

Note: From the above modes, the worst case was found in **Mode B**. Therefore only the test data of the mode was recorded in this report.

9. Only radiated measurements are used to show compliance with FCC limits for fundamental and spurious emissions.

10. The above EUT information is declared by manufacturer and for more detailed features description, please refer to the manufacturer's specifications or user's manual.

### 3.2 Description of Test Modes

One channel was provided to this EUT:

Channel	Frequency (MHz)
1	13.56

#### 3.2.1 Test Mode Applicability and Tested Channel Detail

EUT Configure Mode	Applicable to				Description
	RE	PLC	FS	EB	
-	√	√	√	√	-

Where

**RE:** Radiated Emission

**PLC:** Power Line Conducted Emission

**FS:** Frequency Stability

**EB:** 20dB Bandwidth measurement

**Note:** The EUT had been pre-tested on the positioned of each 3 axis. The worst case was found when positioned on **X-plane**.

#### **Radiated Emission Test:**

- Pre-Scan has been conducted to determine the worst-case mode from all possible combinations between available modulations, data rates and antenna ports (if EUT with antenna diversity architecture).
- Following channel(s) was (were) selected for the final test as listed below.

Available Channel	Tested Channel	Modulation Type
1	1	ASK

#### **Power Line Conducted Emission Test:**

- Pre-Scan has been conducted to determine the worst-case mode from all possible combinations between available modulations, data rates and antenna ports (if EUT with antenna diversity architecture).
- Following channel(s) was (were) selected for the final test as listed below.

Available Channel	Tested Channel	Modulation Type
1	1	ASK

#### **Frequency Stability:**

- Pre-Scan has been conducted to determine the worst-case mode from all possible combinations between available modulations, data rates and antenna ports (if EUT with antenna diversity architecture).
- Following channel(s) was (were) selected for the final test as listed below.

Available Channel	Tested Channel	Modulation Type
1	1	ASK



**20dB Bandwidth:**

- Pre-Scan has been conducted to determine the worst-case mode from all possible combinations between available modulations, data rates and antenna ports (if EUT with antenna diversity architecture).
- Following channel(s) was (were) selected for the final test as listed below.

Available Channel	Tested Channel	Modulation Type
1	1	ASK

**Test Condition:**

Applicable to	Environmental Conditions	Input Power	Tested By
<b>RE</b>	20deg. C, 70%RH	120Vac, 60Hz	Ryan Du
	25deg. C, 65%RH		
<b>PLC</b>	25deg. C, 75%RH	120Vac, 60Hz	Ryan Du
<b>FS</b>	25deg. C, 60%RH	120Vac, 60Hz	Kevin Ko
<b>EB</b>	25deg. C, 60%RH	120Vac, 60Hz	Kevin Ko

### 3.3 Description of Support Units

The EUT has been tested as an independent unit together with other necessary accessories or support units. The following support units or accessories were used to form a representative test configuration during the tests.

ID	Product	Brand	Model No.	Serial No.	FCC ID	Remarks
A	Adapter	MASS POWER	NBS10B050200VUU	NA	NA	Supplied by applicant
B	SIM Card	XAC	NA	NA	NA	Supplied by applicant
C	SIM Card	XAC	NA	NA	NA	Supplied by applicant
D	IC Card	XAC	NA	NA	NA	Supplied by applicant
E	Test Card	XAC	NA	NA	NA	Supplied by applicant
F	Credit Card	Cathay	NA	NA	NA	Provided by Lab
G	Earphone	Amkor	IE2	NA	NA	Provided by Lab
H	SAM Card	XAC	NA	NA	NA	Supplied by applicant
I	SAM Card	XAC	NA	NA	NA	Supplied by applicant

ID	Cable Descriptions	Qty.	Length (m)	Shielding (Yes/No)	Cores (Qty.)	Remarks
1	USB Type A to USB Type C cable	1	1.2	Yes	0	Supplied by applicant
2	Audio Cable	1	1.2	No	0	Provided by Lab

### 3.3.1 Configuration of System under Test

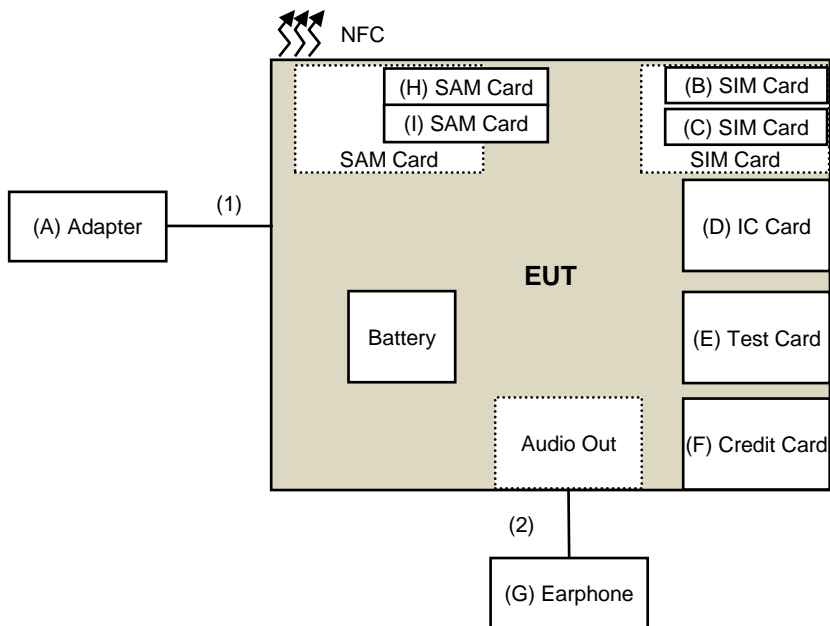

Remote Site

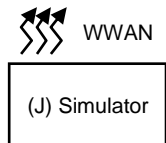

### 3.4 General Description of Applied Standards

The EUT is a RF Product. According to the specifications of the manufacturer, it must comply with the requirements of the following standards:

**FCC Part 15, Subpart C (15.225)**

**FCC Part 15, Subpart C (15.215)**

ANSI C63.10-2013

All test items have been performed and recorded as per the above standards.

## 4 Test Types and Results

### 4.1 Radiated Emission Measurement

#### 4.1.1 Limits of Radiated Emission Measurement

(a) The field strength of any emissions within the band 13.553-13.567 MHz shall not exceed 15,848 microvolts/meter at 30 meters.

(b) Within the bands 13.410-13.553 MHz and 13.567-13.710 MHz, the field strength of any emissions shall not exceed 334 microvolts/meter at 30 meters.

(c) Within the bands 13.110-13.410 MHz and 13.710-14.010 MHz the field strength of any emissions shall not exceed 106 microvolts/meter at 30 meters.

(d) The field strength of any emissions appearing outside of the 13.110-14.010 MHz band shall not exceed the general radiated emission limits in §15.209 as below table:

Frequencies (MHz)	Field Strength (microvolts/meter)	Measurement Distance (meters)
0.009 ~ 0.490	2400/F(kHz)	300
0.490 ~ 1.705	24000/F(kHz)	30
1.705 ~ 30.0	30	30
30 ~ 88	100	3
88 ~ 216	150	3
216 ~ 960	200	3
Above 960	500	3

#### Note:

1. The lower limit shall apply at the transition frequencies.
2. Emission level (dBuV/m) = 20 log Emission level (uV/m).
3. The emission limits shown in the above table are based on measurements employing a CISPR quasi-peak detector except for the frequency bands 9–90 kHz, 110–490 kHz and above 1000 MHz. Radiated emission limits in these three bands are based on measurements employing an average detector.
4. For frequencies above 1000MHz, the field strength limits are based on average detector, however, the peak field strength of any emission shall not exceed the maximum permitted average limits, specified above by more than 20dB under any condition of modulation.

#### 4.1.2 Test Instruments

##### For Radiated Emission test:

Description & Manufacturer	Model No.	Serial No.	Calibrated Date	Calibrated Until
EMI Test Receiver R&S	ESR3	102528	2023/2/10	2024/2/9
PXA Signal Analyzer Keysight	N9030B	MY57141948	2023/5/19	2024/5/18
Software	ADT_Radiated_V8.7.0 8	NA	NA	NA
Boresight Antenna Tower & Turn Table Max-Full	MF-7802BS	MF780208530	NA	NA
Preamplifier Agilent	8447D	2944A10636	2023/3/12	2024/3/11
Loop Antenna Electro-Metrics	EM-6879	264	2023/2/21	2024/2/20
RF Coaxial Cable JYEBO	5D-FB	LOOPCAB- 001	2022/12/19	2023/12/18
RF Coaxial Cable JYEBO	5D-FB	LOOPCAB- 002	2022/12/19	2023/12/18
MXA Signal Analyzer Keysight	N9020B	MY60112410	2023/3/6	2024/3/5
Preamplifier EMCI	EMC330N	980538	2023/4/6	2024/4/5
Bi_Log Antenna Schwarzbeck	VULB 9168	9168-0842	2022/10/24	2023/10/23
RF Coaxial Cable COMMATE/PEWC	8D	966-5-1	2023/2/18	2024/2/17
RF Coaxial Cable COMMATE/PEWC	8D	966-5-2	2023/4/6	2024/4/5
RF Coaxial Cable COMMATE/PEWC	8D	966-5-3	2023/2/18	2024/2/17
Fixed Attenuator Mini-Circuits	UNAT-5+	PAD-ATT5-02	2022/12/28	2023/12/27
Horn Antenna Schwarzbeck	BBHA 9120D	9120D-1819	2022/11/13	2023/11/12
Preamplifier EMCI	EMC12630SE	980509	2023/4/7	2024/4/6
RF Coaxial Cable EMCI	EMC104-SM-SM-1500	180503	2023/4/7	2024/4/6
RF Coaxial Cable EMCI	EMC104-SM-SM-2000	180501	2023/4/7	2024/4/6
RF Coaxial Cable EMCI	EMC104-SM-SM-6000	180506	2023/4/7	2024/4/6
Preamplifier EMCI	EMC184045SE	980387	2022/12/28	2023/12/27
Horn Antenna Schwarzbeck	BBHA 9170	9170-739	2022/11/13	2023/11/12
RF Coaxial Cable EMCI	EMC102-KM-KM-1200	160924	2022/12/28	2023/12/27
RF Coaxial Cable EMCI	EMC-KM-KM-4000	200214	2023/2/20	2024/2/19

##### Note:

1. The test was performed in 966 Chamber No. 5.
2. The calibration interval of the above test instruments is 12 months and the calibrations are traceable to NML/ROC and NIST/USA.
3. Tested Date: 2023/7/6 ~ 2023/7/17

**For other test items:**

Description & Manufacturer	Model No.	Serial No.	Calibrated Date	Calibrated Until
MXA Signal Analyzer Keysight	N9020B	MY60112409	2023/2/18	2024/2/17
Fixed Attenuator Woken	MDCS18N-10	MDCS18N-10-01	2023/3/27	2024/3/26
Software	ADT_RF Test Software V6.6.5.4	NA	NA	NA
DC POWER SUPPLY Topward	6603D	795558	NA	NA
Temperature & Humidity Chamber Giant Force	GTH-150-40-SP- AR	MAA0812-008	2022/12/26	2023/12/25
True RMS Clamp Meter Fluke	325	31130711WS	2023/6/8	2024/6/7

**Note:**

1. The test was performed in Oven room 2.
2. The calibration interval of the above test instruments is 12 months and the calibrations are traceable to NML/ROC and NIST/USA.
3. Tested Date: 2023/7/24

#### 4.1.3 Test Procedures

##### **For Radiated Emission below 30MHz**

- a. The EUT was placed on the top of a rotating table 0.8 meters above the ground at a 3 meter chamber room. The table was rotated 360 degrees to determine the position of the highest radiation.
- b. The EUT was set 3 meters away from the interference-receiving antenna, which was mounted on the top of a variable-height antenna tower.
- c. Parallel, perpendicular, and ground-parallel orientations of the antenna are set to make the measurement.
- d. For each suspected emission, the EUT was arranged to its worst case and the rotatable table was turned from 0 degrees to 360 degrees to find the maximum reading.
- e. The test-receiver system was set to Quasi-Peak or Peak / Average Detect Function and Specified Bandwidth with Maximum Hold Mode.

##### **Note:**

1. The resolution bandwidth of test receiver/spectrum analyzer is 200Hz at frequency below 150kHz.
2. The resolution bandwidth of test receiver/spectrum analyzer is 9kHz at frequency 150kHz ~ 30MHz.

##### **For Radiated Emission above 30MHz**

- a. The EUT was placed on the top of a rotating table 0.8 meters above the ground at 3 meter chamber room for test. The table was rotated 360 degrees to determine the position of the highest radiation.
- b. The EUT was set 3 meters away from the interference-receiving antenna, which was mounted on the top of a variable-height antenna tower.
- c. The height of antenna is varied from one meter to four meters above the ground to determine the maximum value of the field strength. Both horizontal and vertical polarizations of the antenna are set to make the measurement.
- d. For each suspected emission, the EUT was arranged to its worst case and then the antenna was tuned to heights from 1 meter to 4 meters and the rotatable table was turned from 0 degrees to 360 degrees to find the maximum reading.
- e. The test-receiver system was set to quasi-peak detect function and specified bandwidth with maximum hold mode when the test frequency is below 1 GHz.

##### **Note:**

1. The resolution bandwidth of test receiver/spectrum analyzer is 120kHz for Quasi-peak detection (QP) at frequency below 1GHz.
2. All modes of operation were investigated and the worst-case emissions are reported.

#### 4.1.4 Deviation from Test Standard

No deviation.



#### 4.1.5 Test Setup

##### For Radiated Emission below 30MHz

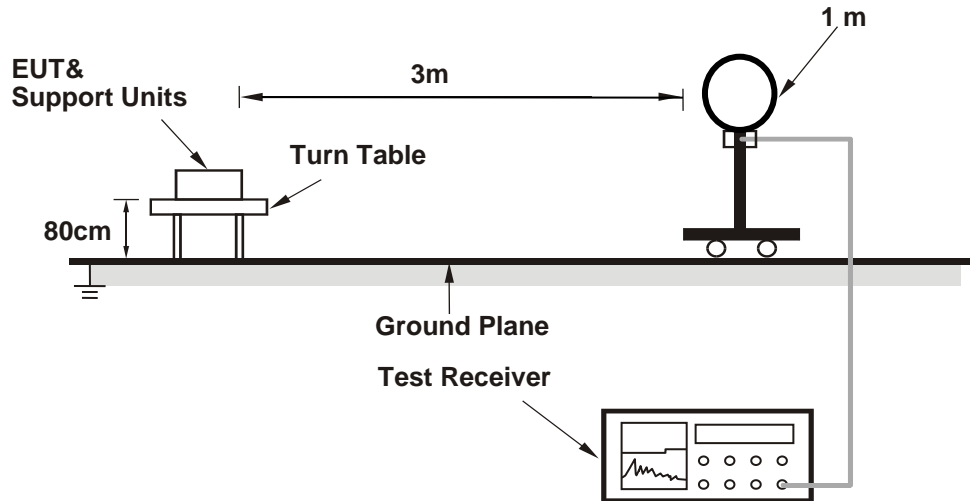

##### For Radiated Emission 30MHz to 1GHz

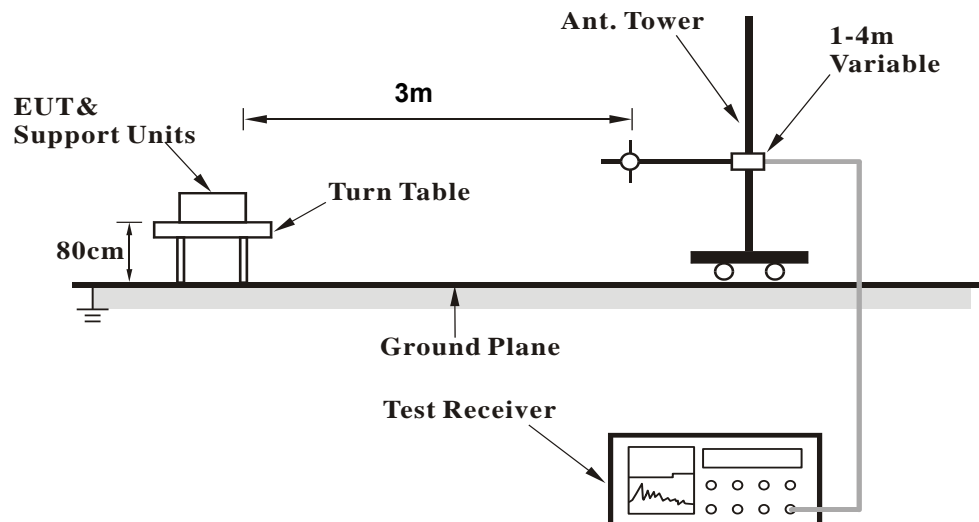

For the actual test configuration, please refer to the attached file (Test Setup Photo).

#### 4.1.6 EUT Operating Conditions

- Placed the EUT on the testing table.
- Set the EUT under transmission condition continuously at specific channel frequency.

4.1.7 Test Results

Type A

Below 30MHz Data:

<b>Frequency Range</b>	13.11MHz ~ 14.01MHz	<b>Detector Function &amp; Bandwidth</b>	Quasi-Peak (QP), 9kHz
------------------------	---------------------	--	-----------------------

Antenna Polarity : Parallel								
No	Frequency (MHz)	Emission Level (dBuV/m)	Limit (dBuV/m)	Margin (dB)	Antenna Height (m)	Table Angle (Degree)	Raw Value (dBuV)	Correction Factor (dB/m)
1	13.351	9.40 QP	40.51	-31.11	1.00	170	52.11	-42.71
2	13.494	14.13 QP	50.47	-36.34	1.00	190	56.86	-42.73
3	*13.560	36.06 QP	84.00	-47.94	1.00	179	78.80	-42.74
4	13.627	15.26 QP	50.47	-35.21	1.00	167	58.01	-42.75
5	13.771	13.16 QP	40.51	-27.35	1.00	183	55.94	-42.78

Remarks:

1. Emission Level(dBuV/m) = Raw Value(dBuV) + Correction Factor(dB/m)
2. Correction Factor(dB/m) = Antenna Factor(dB/m) + Cable Factor(dB) – Pre-Amplifier Factor(dB) + Distance Factor
3. Margin value = Emission Level – Limit value
4. The other emission levels were very low against the limit.
5. " \* ": Fundamental frequency.
6. The test distance for 0.49 ~ 30 MHz is 3 m, extrapolate the measured field strength to a distance of 30 meters.  
Distance factor@3m =  $40 \cdot \log(3/30) = -40\text{dB}$

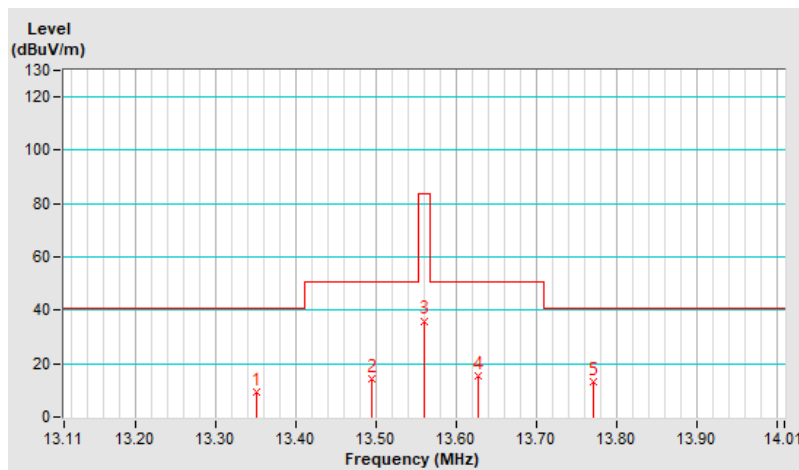

<b>Frequency Range</b>	13.11MHz ~ 14.01MHz	<b>Detector Function &amp; Bandwidth</b>	Quasi-Peak (QP), 9kHz
------------------------	---------------------	--	-----------------------

Antenna Polarity : Perpendicular								
No	Frequency (MHz)	Emission Level (dBuV/m)	Limit (dBuV/m)	Margin (dB)	Antenna Height (m)	Table Angle (Degree)	Raw Value (dBuV)	Correction Factor (dB/m)
1	13.348	1.42 QP	40.51	-39.09	1.00	250	44.13	-42.71
2	13.495	5.09 QP	50.47	-45.38	1.00	263	47.82	-42.73
3	*13.560	26.82 QP	84.00	-57.18	1.00	271	69.56	-42.74
4	13.624	5.83 QP	50.47	-44.64	1.00	260	48.58	-42.75
5	13.772	4.39 QP	40.51	-36.12	1.00	271	47.17	-42.78

**Remarks:**

1. Emission Level(dBuV/m) = Raw Value(dBuV) + Correction Factor(dB/m)
2. Correction Factor(dB/m) = Antenna Factor(dB/m) + Cable Factor(dB) – Pre-Amplifier Factor(dB) + Distance Factor
3. Margin value = Emission Level – Limit value
4. The other emission levels were very low against the limit.
5. " \* ": Fundamental frequency.
6. The test distance for 0.49 ~ 30 MHz is 3 m, extrapolate the measured field strength to a distance of 30 meters.  
Distance factor@3m =  $40 \cdot \log(3/30) = -40\text{dB}$

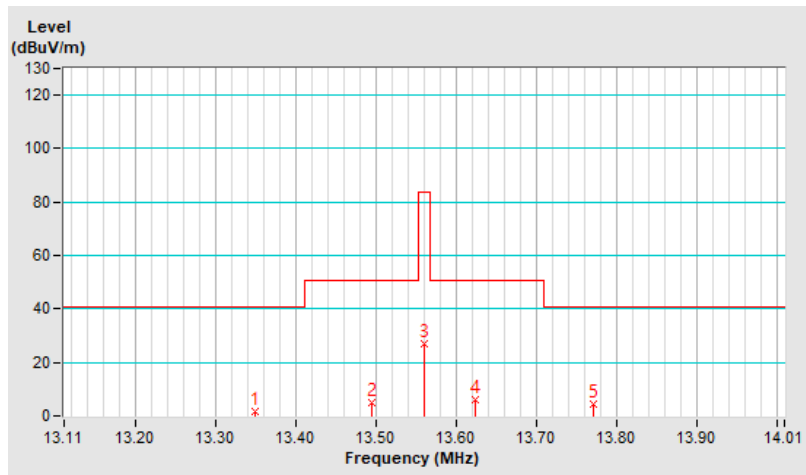

<b>Frequency Range</b>	13.11MHz ~ 14.01MHz	<b>Detector Function &amp; Bandwidth</b>	Quasi-Peak (QP), 9kHz
------------------------	---------------------	--	-----------------------

Antenna Polarity : Ground-parallel								
No	Frequency (MHz)	Emission Level (dBuV/m)	Limit (dBuV/m)	Margin (dB)	Antenna Height (m)	Table Angle (Degree)	Raw Value (dBuV)	Correction Factor (dB/m)
1	13.349	10.79 QP	40.51	-29.72	1.00	194	53.50	-42.71
2	13.494	15.59 QP	50.47	-34.88	1.00	192	58.32	-42.73
3	*13.560	37.34 QP	84.00	-46.66	1.00	170	80.08	-42.74
4	13.629	16.75 QP	50.47	-33.72	1.00	175	59.50	-42.75
5	13.773	14.65 QP	40.51	-25.86	1.00	193	57.43	-42.78

**Remarks:**

1. Emission Level(dBuV/m) = Raw Value(dBuV) + Correction Factor(dB/m)
2. Correction Factor(dB/m) = Antenna Factor(dB/m) + Cable Factor(dB) – Pre-Amplifier Factor(dB) + Distance Factor
3. Margin value = Emission Level – Limit value
4. The other emission levels were very low against the limit.
5. " \* ": Fundamental frequency.
6. The test distance for 0.49 ~ 30 MHz is 3 m, extrapolate the measured field strength to a distance of 30 meters.  
Distance factor@3m =  $40 \cdot \log(3/30) = -40\text{dB}$

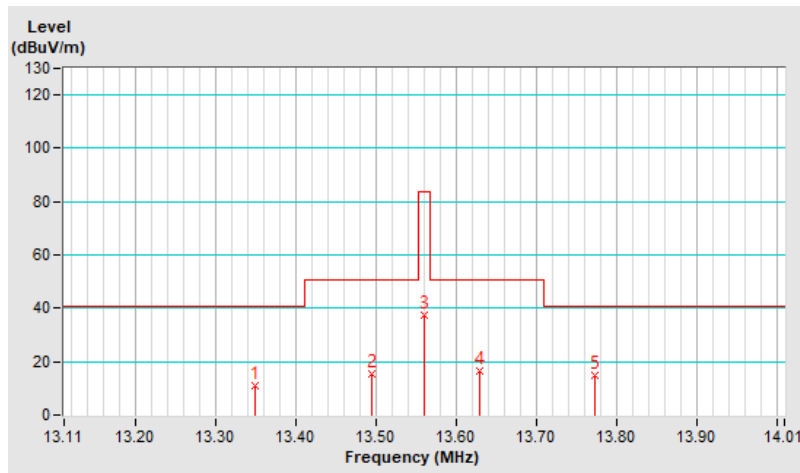

<b>Frequency Range</b>	9kHz ~ 150kHz	<b>Detector Function &amp; Bandwidth</b>	Peak (PK) / Average (AV), 200Hz
------------------------	---------------	--	---------------------------------

Antenna Polarity : Parallel								
No	Frequency (MHz)	Emission Level (dBuV/m)	Limit (dBuV/m)	Margin (dB)	Antenna Height (m)	Table Angle (Degree)	Raw Value (dBuV)	Correction Factor (dB/m)
1	0.009	20.62 PK	68.52	-47.90	1.00	136	63.75	-43.13
2	0.009	-2.77 AV	48.52	-51.29	1.00	136	40.36	-43.13
3	0.018	11.51 PK	62.50	-50.99	1.00	360	59.11	-47.60
4	0.018	-14.61 AV	42.50	-57.11	1.00	360	32.99	-47.60
5	0.032	2.28 PK	57.50	-55.22	1.00	166	54.69	-52.41
6	0.032	-23.38 AV	37.50	-60.88	1.00	166	29.03	-52.41

**Remarks:**

1. Emission Level(dBuV/m) = Raw Value(dBuV) + Correction Factor(dB/m)
2. Correction Factor(dB/m) = Antenna Factor(dB/m) + Cable Factor(dB) – Pre-Amplifier Factor(dB) + Distance Factor
3. Margin value = Emission Level – Limit value
4. The other emission levels were very low against the limit.
5. The test distance for below 0.49 MHz is 3 m, extrapolate the measured field strength to a distance of 300 meters.  
Distance factor@3m =  $40 \cdot \log(3/300) = -80\text{dB}$

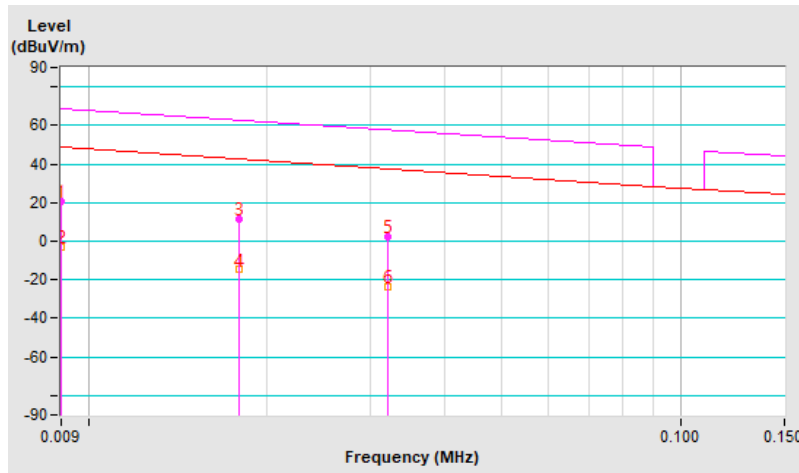

<b>Frequency Range</b>	9kHz ~ 150kHz	<b>Detector Function &amp; Bandwidth</b>	Peak (PK) / Average (AV), 200Hz
------------------------	---------------	--	---------------------------------

Antenna Polarity : Perpendicular								
No	Frequency (MHz)	Emission Level (dBuV/m)	Limit (dBuV/m)	Margin (dB)	Antenna Height (m)	Table Angle (Degree)	Raw Value (dBuV)	Correction Factor (dB/m)
1	0.009	19.73 PK	68.52	-48.79	1.00	178	62.86	-43.13
2	0.009	-2.75 AV	48.52	-51.27	1.00	178	40.38	-43.13
3	0.013	14.76 PK	65.32	-50.56	1.00	168	60.38	-45.62
4	0.013	-10.29 AV	45.32	-55.61	1.00	168	35.33	-45.62
5	0.030	2.38 PK	58.06	-55.68	1.00	40	54.27	-51.89
6	0.030	-21.93 AV	38.06	-59.99	1.00	40	29.96	-51.89

**Remarks:**

1. Emission Level(dBuV/m) = Raw Value(dBuV) + Correction Factor(dB/m)
2. Correction Factor(dB/m) = Antenna Factor(dB/m) + Cable Factor(dB) – Pre-Amplifier Factor(dB) + Distance Factor
3. Margin value = Emission Level – Limit value
4. The other emission levels were very low against the limit.
5. The test distance for below 0.49 MHz is 3 m, extrapolate the measured field strength to a distance of 300 meters.  
Distance factor@3m =  $40 \cdot \log(3/300) = -80\text{dB}$

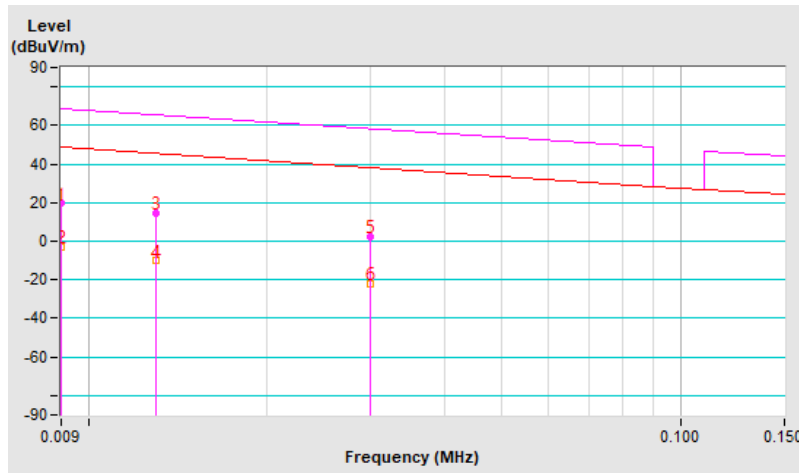

<b>Frequency Range</b>	9kHz ~ 150kHz	<b>Detector Function &amp; Bandwidth</b>	Peak (PK) / Average (AV), 200Hz
------------------------	---------------	--	---------------------------------

Antenna Polarity : Ground-parallel								
No	Frequency (MHz)	Emission Level (dBuV/m)	Limit (dBuV/m)	Margin (dB)	Antenna Height (m)	Table Angle (Degree)	Raw Value (dBuV)	Correction Factor (dB/m)
1	0.009	19.89 PK	68.52	-48.63	1.00	124	63.02	-43.13
2	0.009	-2.47 AV	48.52	-50.99	1.00	124	40.66	-43.13
3	0.014	14.35 PK	64.68	-50.33	1.00	334	60.36	-46.01
4	0.014	-11.12 AV	44.68	-55.80	1.00	334	34.89	-46.01
5	0.021	9.44 PK	61.16	-51.72	1.00	154	58.18	-48.74
6	0.021	-17.23 AV	41.16	-58.39	1.00	154	31.51	-48.74

**Remarks:**

1. Emission Level(dBuV/m) = Raw Value(dBuV) + Correction Factor(dB/m)
2. Correction Factor(dB/m) = Antenna Factor(dB/m) + Cable Factor(dB) – Pre-Amplifier Factor(dB) + Distance Factor
3. Margin value = Emission Level – Limit value
4. The other emission levels were very low against the limit.
5. The test distance for below 0.49 MHz is 3 m, extrapolate the measured field strength to a distance of 300 meters.  
Distance factor@3m =  $40 \cdot \log(3/300) = -80\text{dB}$

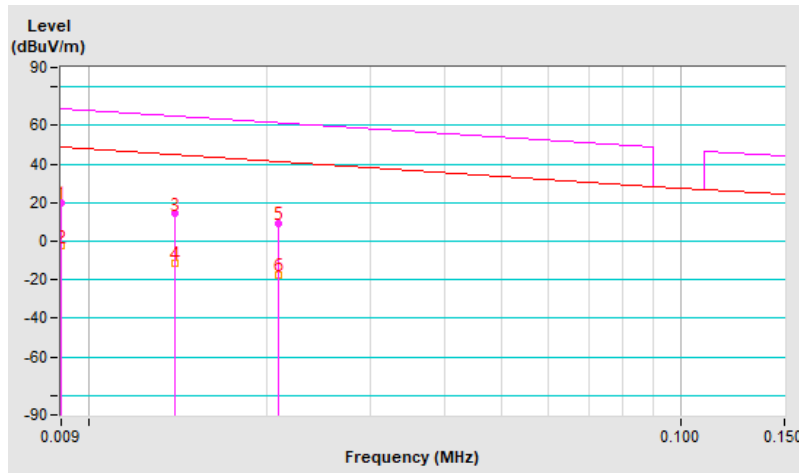

<b>Frequency Range</b>	150kHz ~ 490kHz	<b>Detector Function &amp; Bandwidth</b>	Peak (PK) / Average (AV), 9kHz
------------------------	-----------------	--	--------------------------------

Antenna Polarity : Parallel								
No	Frequency (MHz)	Emission Level (dBuV/m)	Limit (dBuV/m)	Margin (dB)	Antenna Height (m)	Table Angle (Degree)	Raw Value (dBuV)	Correction Factor (dB/m)
1	0.153	-18.03 PK	43.91	-61.94	1.00	271	47.82	-65.85
2	0.153	-41.31 AV	23.91	-65.22	1.00	271	24.54	-65.85
3	0.200	-24.26 PK	41.58	-65.84	1.00	269	43.46	-67.72
4	0.200	-44.06 AV	21.58	-65.64	1.00	269	23.66	-67.72
5	0.305	-35.60 PK	37.92	-73.52	1.00	37	36.25	-71.85
6	0.305	-50.12 AV	17.92	-68.04	1.00	37	21.73	-71.85

**Remarks:**

1. Emission Level(dBuV/m) = Raw Value(dBuV) + Correction Factor(dB/m)
2. Correction Factor(dB/m) = Antenna Factor(dB/m) + Cable Factor(dB) – Pre-Amplifier Factor(dB) + Distance Factor
3. Margin value = Emission Level – Limit value
4. The other emission levels were very low against the limit.
5. The test distance for below 0.49 MHz is 3 m, extrapolate the measured field strength to a distance of 300 meters.  
Distance factor@3m =  $40 \cdot \log(3/300) = -80\text{dB}$

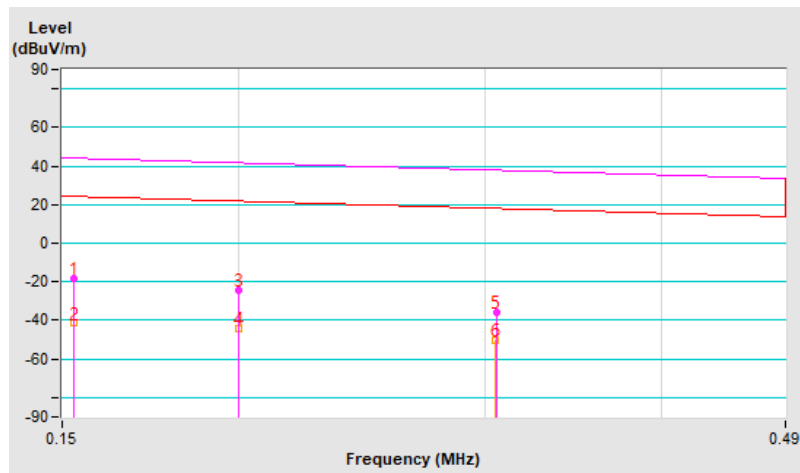



<b>Frequency Range</b>	150kHz ~ 490kHz	<b>Detector Function &amp; Bandwidth</b>	Peak (PK) / Average (AV), 9kHz
------------------------	-----------------	--	--------------------------------

Antenna Polarity : Perpendicular								
No	Frequency (MHz)	Emission Level (dBuV/m)	Limit (dBuV/m)	Margin (dB)	Antenna Height (m)	Table Angle (Degree)	Raw Value (dBuV)	Correction Factor (dB/m)
1	0.150	-19.60 PK	44.08	-63.68	1.00	169	46.13	-65.73
2	0.150	-29.91 AV	24.08	-53.99	1.00	169	35.82	-65.73
3	0.186	-23.15 PK	42.21	-65.36	1.00	69	44.01	-67.16
4	0.186	-43.39 AV	22.21	-65.60	1.00	69	23.77	-67.16
5	0.280	-30.78 PK	38.66	-69.44	1.00	220	40.18	-70.96
6	0.280	-49.10 AV	18.66	-67.76	1.00	220	21.86	-70.96

**Remarks:**

1. Emission Level(dBuV/m) = Raw Value(dBuV) + Correction Factor(dB/m)
2. Correction Factor(dB/m) = Antenna Factor(dB/m) + Cable Factor(dB) – Pre-Amplifier Factor(dB) + Distance Factor
3. Margin value = Emission Level – Limit value
4. The other emission levels were very low against the limit.
5. The test distance for below 0.49 MHz is 3 m, extrapolate the measured field strength to a distance of 300 meters.  
Distance factor@3m =  $40 \cdot \log(3/300) = -80\text{dB}$

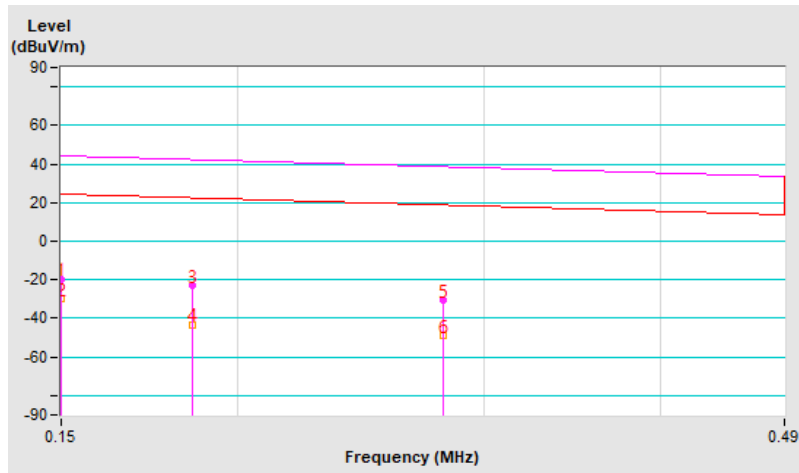

<b>Frequency Range</b>	150kHz ~ 490kHz	<b>Detector Function &amp; Bandwidth</b>	Peak (PK) / Average (AV), 9kHz
------------------------	-----------------	--	--------------------------------

Antenna Polarity : Ground-parallel								
No	Frequency (MHz)	Emission Level (dBuV/m)	Limit (dBuV/m)	Margin (dB)	Antenna Height (m)	Table Angle (Degree)	Raw Value (dBuV)	Correction Factor (dB/m)
1	0.152	-18.88 PK	43.96	-62.84	1.00	222	46.93	-65.81
2	0.152	-41.16 AV	23.96	-65.12	1.00	222	24.65	-65.81
3	0.206	-24.44 PK	41.33	-65.77	1.00	278	43.52	-67.96
4	0.206	-44.63 AV	21.33	-65.96	1.00	278	23.33	-67.96
5	0.249	-28.97 PK	39.68	-68.65	1.00	287	40.73	-69.70
6	0.249	-43.62 AV	19.68	-63.30	1.00	287	26.08	-69.70

**Remarks:**

1. Emission Level(dBuV/m) = Raw Value(dBuV) + Correction Factor(dB/m)
2. Correction Factor(dB/m) = Antenna Factor(dB/m) + Cable Factor(dB) – Pre-Amplifier Factor(dB) + Distance Factor
3. Margin value = Emission Level – Limit value
4. The other emission levels were very low against the limit.
5. The test distance for below 0.49 MHz is 3 m, extrapolate the measured field strength to a distance of 300 meters.  
Distance factor@3m =  $40 \cdot \log(3/300) = -80\text{dB}$

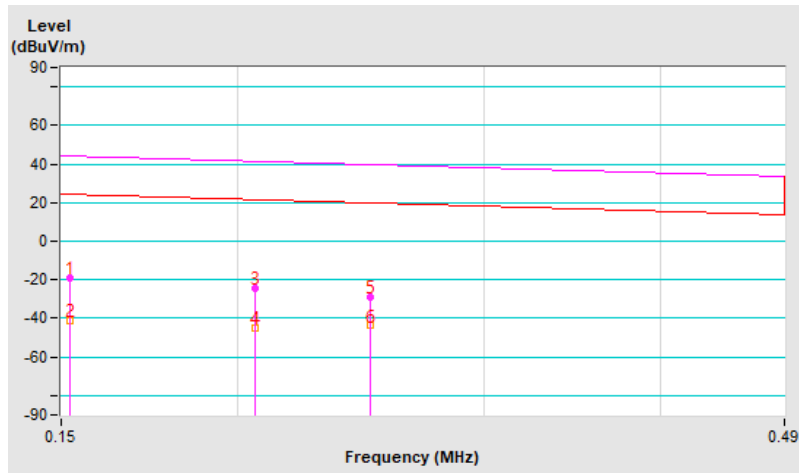

<b>Frequency Range</b>	490kHz ~ 30MHz	<b>Detector Function &amp; Bandwidth</b>	Quasi-Peak (QP), 9kHz
------------------------	----------------	--	-----------------------

Antenna Polarity : Parallel								
No	Frequency (MHz)	Emission Level (dBuV/m)	Limit (dBuV/m)	Margin (dB)	Antenna Height (m)	Table Angle (Degree)	Raw Value (dBuV)	Correction Factor (dB/m)
1	0.692	3.27 QP	30.80	-27.53	1.00	271	40.08	-36.81
2	1.473	-5.49 QP	24.23	-29.72	1.00	301	34.65	-40.14
3	2.214	-9.99 QP	29.54	-39.53	1.00	292	31.77	-41.76
4	3.178	-11.05 QP	29.54	-40.59	1.00	327	32.56	-43.61
5	7.910	-10.67 QP	29.54	-40.21	1.00	58	32.27	-42.94
6	23.673	-11.71 QP	29.54	-41.25	1.00	210	31.25	-42.96

**Remarks:**

1. Emission Level(dBuV/m) = Raw Value(dBuV) + Correction Factor(dB/m)
2. Correction Factor(dB/m) = Antenna Factor(dB/m) + Cable Factor(dB) – Pre-Amplifier Factor(dB) + Distance Factor
3. Margin value = Emission Level – Limit value
4. The other emission levels were very low against the limit.
5. The test distance for 0.49 ~ 30 MHz is 3 m, extrapolate the measured field strength to a distance of 30 meters.  
Distance factor@3m =  $40 \cdot \log(3/30) = -40\text{dB}$

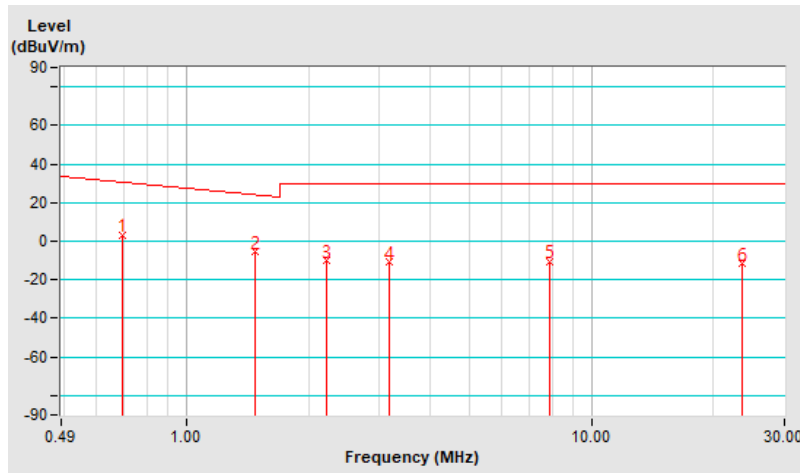

<b>Frequency Range</b>	490kHz ~ 30MHz	<b>Detector Function &amp; Bandwidth</b>	Quasi-Peak (QP), 9kHz
------------------------	----------------	--	-----------------------

Antenna Polarity : Perpendicular								
No	Frequency (MHz)	Emission Level (dBuV/m)	Limit (dBuV/m)	Margin (dB)	Antenna Height (m)	Table Angle (Degree)	Raw Value (dBuV)	Correction Factor (dB/m)
1	0.528	-4.93 QP	33.15	-38.08	1.00	266	30.65	-35.58
2	0.795	-9.49 QP	29.59	-39.08	1.00	24	28.09	-37.58
3	2.421	-16.09 QP	29.54	-45.63	1.00	71	26.15	-42.24
4	3.033	-16.60 QP	29.54	-46.14	1.00	122	26.96	-43.56
5	9.522	-14.44 QP	29.54	-43.98	1.00	351	27.95	-42.39
6	27.863	-14.35 QP	29.54	-43.89	1.00	327	27.86	-42.21

**Remarks:**

1. Emission Level(dBuV/m) = Raw Value(dBuV) + Correction Factor(dB/m)
2. Correction Factor(dB/m) = Antenna Factor(dB/m) + Cable Factor(dB) – Pre-Amplifier Factor(dB) + Distance Factor
3. Margin value = Emission Level – Limit value
4. The other emission levels were very low against the limit.
5. The test distance for 0.49 ~ 30 MHz is 3 m, extrapolate the measured field strength to a distance of 30 meters.  
Distance factor@3m =  $40 \cdot \log(3/30) = -40\text{dB}$

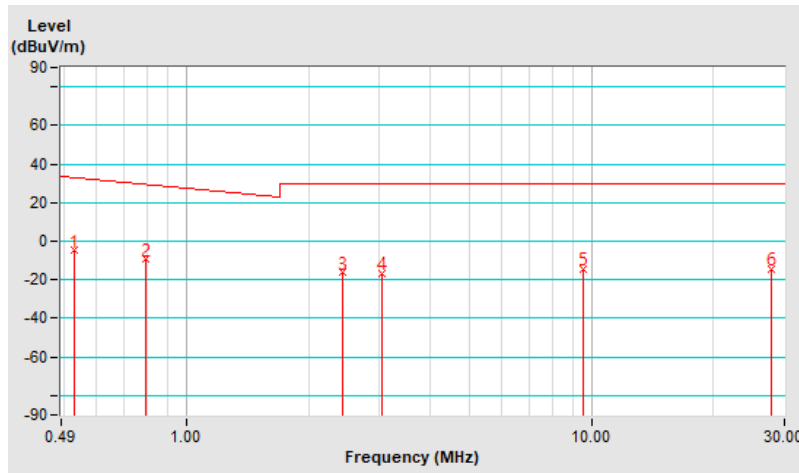

<b>Frequency Range</b>	490kHz ~ 30MHz	<b>Detector Function &amp; Bandwidth</b>	Quasi-Peak (QP), 9kHz
------------------------	----------------	--	-----------------------

Antenna Polarity : Ground-parallel								
No	Frequency (MHz)	Emission Level (dBuV/m)	Limit (dBuV/m)	Margin (dB)	Antenna Height (m)	Table Angle (Degree)	Raw Value (dBuV)	Correction Factor (dB/m)
1	0.496	-3.95 QP	33.69	-37.64	1.00	59	31.35	-35.30
2	0.733	-7.40 QP	30.30	-37.70	1.00	144	29.72	-37.12
3	2.985	-11.50 QP	29.54	-41.04	1.00	342	32.04	-43.54
4	4.607	-12.51 QP	29.54	-42.05	1.00	96	31.34	-43.85
5	10.340	-1.20 QP	29.54	-30.74	1.00	234	41.08	-42.28
6	23.162	-8.15 QP	29.54	-37.69	1.00	88	34.90	-43.05

**Remarks:**

1. Emission Level(dBuV/m) = Raw Value(dBuV) + Correction Factor(dB/m)
2. Correction Factor(dB/m) = Antenna Factor(dB/m) + Cable Factor(dB) – Pre-Amplifier Factor(dB) + Distance Factor
3. Margin value = Emission Level – Limit value
4. The other emission levels were very low against the limit.
5. The test distance for 0.49 ~ 30 MHz is 3 m, extrapolate the measured field strength to a distance of 30 meters.  
Distance factor@3m =  $40 \cdot \log(3/30) = -40\text{dB}$

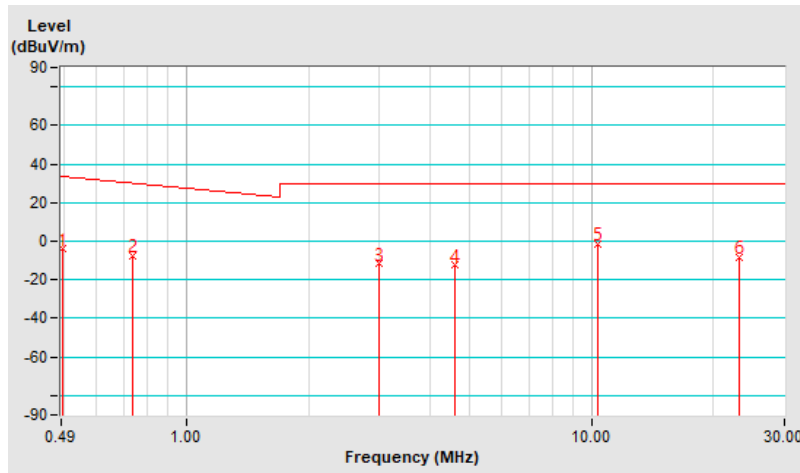

**Above 30MHz Data:**

<b>Frequency Range</b>	30MHz ~ 1GHz	<b>Detector Function</b>	Quasi-Peak (QP), 120kHz
------------------------	--------------	--------------------------	-------------------------

Antenna Polarity & Test Distance : Horizontal at 3 m								
No	Frequency (MHz)	Emission Level (dBuV/m)	Limit (dBuV/m)	Margin (dB)	Antenna Height (m)	Table Angle (Degree)	Raw Value (dBuV)	Correction Factor (dB/m)
1	32.33	25.1 QP	40.0	-14.9	3.00 H	326	38.2	-13.1
2	132.02	24.4 QP	43.5	-19.1	2.00 H	253	37.7	-13.3
3	179.46	24.1 QP	43.5	-19.4	2.00 H	129	37.8	-13.7
4	288.17	19.9 QP	46.0	-26.1	1.00 H	339	31.8	-11.9
5	409.35	22.1 QP	46.0	-23.9	1.00 H	287	30.8	-8.7
6	600.97	26.1 QP	46.0	-19.9	3.00 H	332	30.1	-4.0

**Remarks:**

1. Emission Level(dBuV/m) = Raw Value(dBuV) + Correction Factor(dB/m)
2. Correction Factor(dB/m) = Antenna Factor(dB/m) + Cable Factor(dB) – Pre-Amplifier Factor(dB)
3. Margin value = Emission Level – Limit value
4. The other emission levels were very low against the limit.

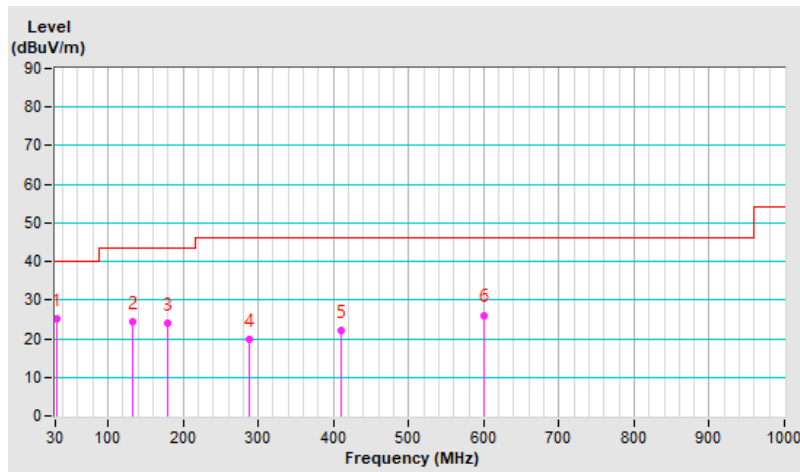

<b>Frequency Range</b>	30MHz ~ 1GHz	<b>Detector Function</b>	Quasi-Peak (QP), 120kHz
------------------------	--------------	--------------------------	-------------------------

Antenna Polarity & Test Distance : Vertical at 3 m								
No	Frequency (MHz)	Emission Level (dBuV/m)	Limit (dBuV/m)	Margin (dB)	Antenna Height (m)	Table Angle (Degree)	Raw Value (dBuV)	Correction Factor (dB/m)
1	32.76	30.0 QP	40.0	-10.0	1.00 V	231	43.1	-13.1
2	59.51	26.5 QP	40.0	-13.5	1.00 V	86	39.5	-13.0
3	74.95	25.3 QP	40.0	-14.7	1.00 V	303	41.1	-15.8
4	131.33	20.0 QP	43.5	-23.5	1.00 V	18	33.3	-13.3
5	266.44	17.5 QP	46.0	-28.5	1.00 V	297	30.2	-12.7
6	477.38	22.8 QP	46.0	-23.2	3.00 V	33	29.8	-7.0

**Remarks:**

1. Emission Level(dBuV/m) = Raw Value(dBuV) + Correction Factor(dB/m)
2. Correction Factor(dB/m) = Antenna Factor(dB/m) + Cable Factor(dB) – Pre-Amplifier Factor(dB)
3. Margin value = Emission Level – Limit value
4. The other emission levels were very low against the limit.

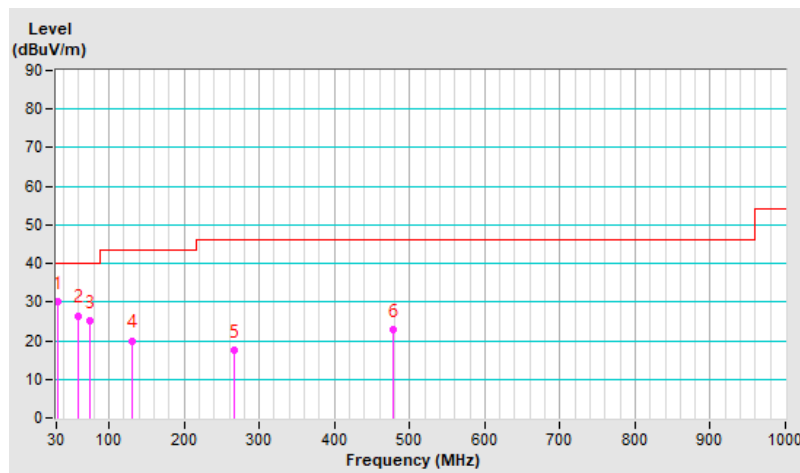

## 4.2 Conducted Emission Measurement

### 4.2.1 Limits of Conducted Emission Measurement

Frequency (MHz)	Conducted Limit (dBuV)	
	Quasi-peak	Average
0.15 - 0.5	66 - 56	56 - 46
0.50 - 5.0	56	46
5.0 - 30.0	60	50

- Note: 1. The lower limit shall apply at the transition frequencies.  
 2. The limit decreases in line with the logarithm of the frequency in the range of 0.15 to 0.50MHz.  
 3. All emanations from a class A/B digital device or system, including any network of conductors and apparatus connected thereto, shall not exceed the level of field strengths specified above.

### 4.2.2 Test Instruments

Description & Manufacturer	Model No.	Serial No.	Calibrated Date	Calibrated Until
EMI Test Receiver R&S	ESCS 30	847124/029	2022/10/14	2023/10/13
LISN R&S	ESH3-Z5	848773/004	2022/10/18	2023/10/17
50 ohm terminal resistance NA	NA	EMC-01	2022/9/27	2023/9/26
RF Coaxial Cable JYEBO	5D-FB	COCCAB-001	2022/8/24	2023/8/23
Fixed Attenuator STI	STI02-2200-10	005	2022/8/24	2023/8/23
Software BVADT	BVADT_Cond_V7.3.7.4	NA	NA	NA

Note:

1. The test was performed in Conduction 1.
2. The calibration interval of the above test instruments is 12 months and the calibrations are traceable to NML/ROC and NIST/USA.
3. Tested Date: 2023/7/17



#### 4.2.3 Test Procedures

- The EUT was placed 0.4 meters from the conducting wall of the shielded room with EUT being connected to the power mains through a line impedance stabilization network (LISN). Other support units were connected to the power mains through another LISN. The two LISNs provide 50 ohm/ 50uH of coupling impedance for the measuring instrument.
- Both lines of the power mains connected to the EUT were checked for maximum conducted interference.
- The frequency range from 150kHz to 30MHz was searched. Emission levels under (Limit - 20dB) was not recorded.

**Note:** The resolution bandwidth and video bandwidth of test receiver is 9kHz for quasi-peak detection (QP) and average detection (AV) at frequency 0.15MHz-30MHz.

#### 4.2.4 Deviation from Test Standard

No deviation.

#### 4.2.5 Test Setup

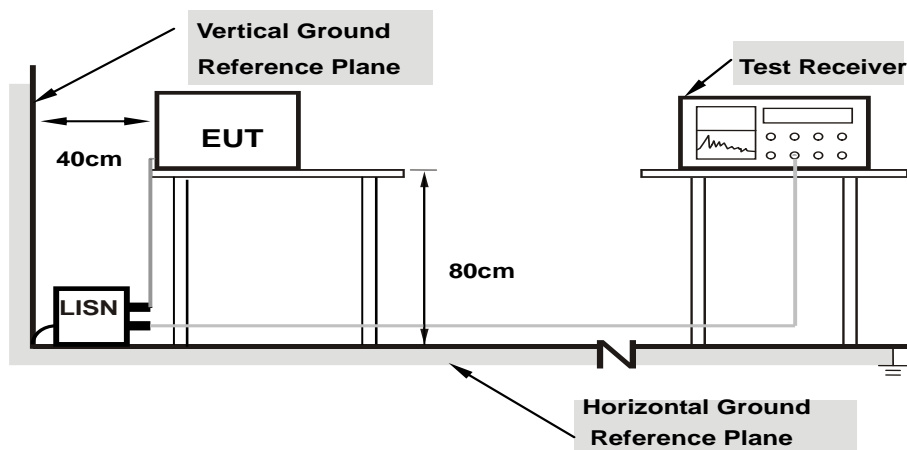

- Note:**
- Support units were connected to second LISN.
  - Both of LISNs (AMN) are 80 cm from EUT and at least 80 from other units and other metal planes

For the actual test configuration, please refer to the attached file (Test Setup Photo).

#### 4.2.6 EUT Operating Conditions

Same as 4.1.6.

#### 4.2.7 Test Results

<b>Frequency Range</b>	150kHz ~ 30MHz	<b>Detector Function &amp; Resolution Bandwidth</b>	Quasi-Peak (QP) / Average (AV), 9kHz
------------------------	----------------	---	--------------------------------------

Phase Of Power : Line (L)										
No	Frequency (MHz)	Correction Factor (dB)	Reading Value (dBuV)		Emission Level (dBuV)		Limit (dBuV)		Margin (dB)	
			Q.P.	AV.	Q.P.	AV.	Q.P.	AV.	Q.P.	AV.
1	0.15781	9.95	36.09	20.46	46.04	30.41	65.58	55.58	-19.54	-25.17
2	0.16953	9.95	34.41	19.04	44.36	28.99	64.98	54.98	-20.62	-25.99
3	0.60313	9.97	23.53	13.41	33.50	23.38	56.00	46.00	-22.50	-22.62
4	0.82578	9.99	18.14	5.50	28.13	15.49	56.00	46.00	-27.87	-30.51
5	10.73047	10.69	21.60	11.35	32.29	22.04	60.00	50.00	-27.71	-27.96
6	16.99219	11.04	25.83	13.56	36.87	24.60	60.00	50.00	-23.13	-25.40

**Remarks:**

1. Q.P. and AV. are abbreviations of quasi-peak and average individually.
2. The emission levels of other frequencies were very low against the limit.
3. Margin value = Emission level – Limit value
4. Correction factor = Insertion loss + Cable loss
5. Emission Level = Correction Factor + Reading Value

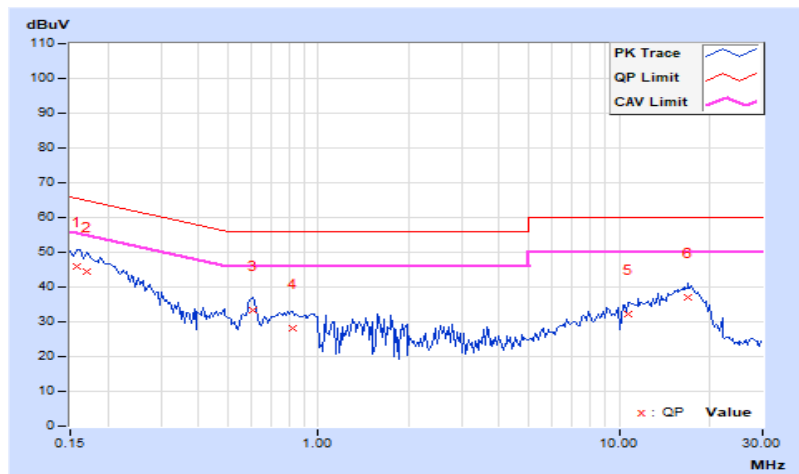

<b>Frequency Range</b>	150kHz ~ 30MHz	<b>Detector Function &amp; Resolution Bandwidth</b>	Quasi-Peak (QP) / Average (AV), 9kHz
------------------------	----------------	---	--------------------------------------

Phase Of Power : Neutral (N)										
No	Frequency (MHz)	Correction Factor (dB)	Reading Value (dBuV)		Emission Level (dBuV)		Limit (dBuV)		Margin (dB)	
			Q.P.	AV.	Q.P.	AV.	Q.P.	AV.	Q.P.	AV.
1	0.15000	10.00	37.98	23.26	47.98	33.26	66.00	56.00	-18.02	-22.74
2	0.20078	10.00	33.99	20.73	43.99	30.73	63.58	53.58	-19.59	-22.85
<b>3</b>	<b>0.60703</b>	<b>10.02</b>	<b>29.75</b>	<b>21.13</b>	<b>39.77</b>	<b>31.15</b>	<b>56.00</b>	<b>46.00</b>	<b>-16.23</b>	<b>-14.85</b>
4	0.80234	10.04	20.68	13.60	30.72	23.64	56.00	46.00	-25.28	-22.36
5	10.32031	10.66	24.15	14.98	34.81	25.64	60.00	50.00	-25.19	-24.36
6	17.20703	10.93	24.33	16.78	35.26	27.71	60.00	50.00	-24.74	-22.29

**Remarks:**

1. Q.P. and AV. are abbreviations of quasi-peak and average individually.
2. The emission levels of other frequencies were very low against the limit.
3. Margin value = Emission level – Limit value
4. Correction factor = Insertion loss + Cable loss
5. Emission Level = Correction Factor + Reading Value

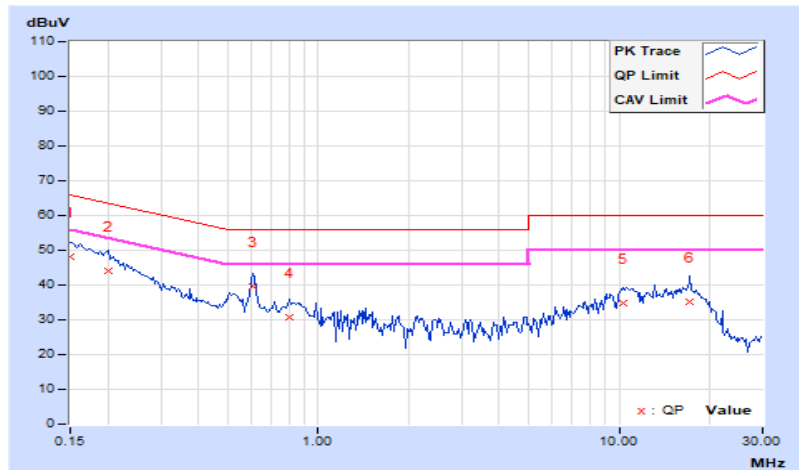

### 4.3 Frequency Stability

#### 4.3.1 Limits of Frequency Stability Measurement

The frequency tolerance of the carrier signal shall be maintained within +/- 0.01% of the operating frequency over a temperature variation of -20 degrees to 50 degrees C at normal supply voltage, and for a variation in the primary supply voltage from 85% to 115% of the rated supply voltage at a temperature of 20 degrees C.

#### 4.3.2 Test Setup

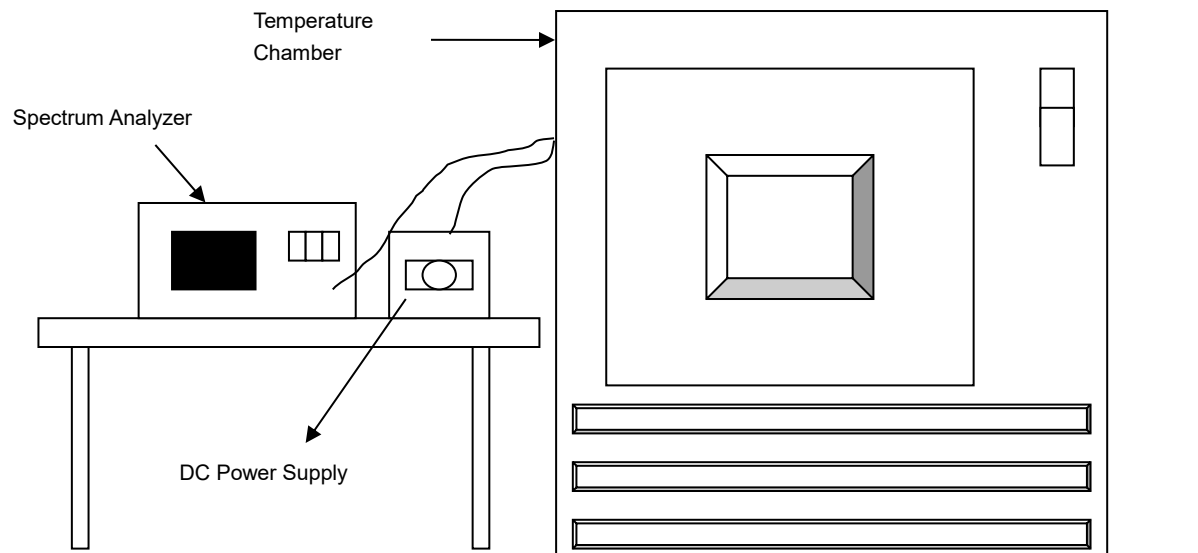

#### 4.3.3 Test Instruments

Refer to section 4.1.2 to get information of above instrument.

#### 4.3.4 Test Procedure

- a. The EUT was placed inside the environmental test chamber and powered by nominal DC voltage.
- b. Turn the EUT on and couple its output to a spectrum analyzer.
- c. Turn the EUT off and set the chamber to the highest temperature specified.
- d. Allow sufficient time (approximately 30 min) for the temperature of the chamber to stabilize, turn the EUT on and measure the operating frequency after 2, 5, and 10 Minutes.
- e. Repeat step (d) with the temperature chamber set to the next desired temperature until measurements down to the lowest specified temperature have been completed.
- f. The test chamber was allowed to stabilize at +20 degree C for a minimum of 30 Minutes. The supply voltage was then adjusted on the EUT from 85% to 115% and the frequency record.

#### 4.3.5 Deviation from Test Standard

No deviation.

#### 4.3.6 EUT Operating Conditions

Set the EUT transmit at un-modulation mode to test frequency stability.

## 4.3.7 Test Result

Frequency Stability Versus Temp.									
Operating Frequency: 13.56 MHz									
TEMP. (°C)	Power Supply (Vdc)	0 Minute		2 Minutes		5 Minutes		10 Minutes	
		Measured Frequency (MHz)	Frequency Drift (%)	Measured Frequency (MHz)	Frequency Drift (%)	Measured Frequency (MHz)	Frequency Drift (%)	Measured Frequency (MHz)	Frequency Drift (%)
50	3.88	13.55995	-0.00037	13.55995	-0.00037	13.55994	-0.00044	13.55994	-0.00044
40	3.88	13.55999	-0.00007	13.56	0.00000	13.55998	-0.00015	13.55999	-0.00007
30	3.88	13.56002	0.00015	13.56002	0.00015	13.56003	0.00022	13.56001	0.00007
20	3.88	13.55995	-0.00037	13.55996	-0.00029	13.55996	-0.00029	13.55996	-0.00029
10	3.88	13.56002	0.00015	13.56001	0.00007	13.56002	0.00015	13.56001	0.00007
0	3.88	13.56002	0.00015	13.56002	0.00015	13.56002	0.00015	13.56004	0.00029

Frequency Stability Versus Voltage									
Operating Frequency: 13.56 MHz									
TEMP. (°C)	Power Supply (Vdc)	0 Minute		2 Minutes		5 Minutes		10 Minutes	
		Measured Frequency (MHz)	Frequency Drift (%)	Measured Frequency (MHz)	Frequency Drift (%)	Measured Frequency (MHz)	Frequency Drift (%)	Measured Frequency (MHz)	Frequency Drift (%)
20	4.462	13.55995	-0.00037	13.55996	-0.00029	13.55996	-0.00029	13.55996	-0.00029
	3.88	13.55995	-0.00037	13.55996	-0.00029	13.55996	-0.00029	13.55996	-0.00029
	3.298	13.55995	-0.00037	13.55996	-0.00029	13.55996	-0.00029	13.55996	-0.00029

#### 4.4 20dB Bandwidth

##### 4.4.1 Limits of 20dB BANDWIDTH Measurement

The 20dB bandwidth shall be specified in operating frequency band.

##### 4.4.2 Test Setup

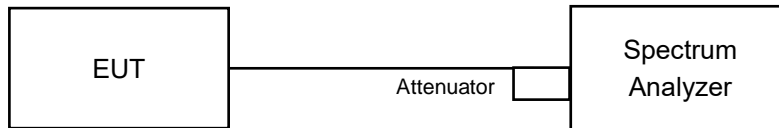

##### 4.4.3 Test Instruments

Refer to section 4.1.2 to get information of above instrument.

##### 4.4.4 Test Procedures

The bandwidth of the fundamental frequency was measured by spectrum analyzer with 10Hz RBW and 30Hz VBW. The 20dB bandwidth is defined as the total spectrum the power of which is higher than peak power minus 20dB.

##### 4.4.5 Deviation from Test Standard

No deviation.

##### 4.4.6 EUT Operating Conditions

Same as Item 4.1.6.

#### 4.4.7 Test Results

#### Type A

Operating Frequency Band (MHz)	20dB Bandwidth (MHz)	20dB Point (MHz)		Pass / Fail
		Lowest	Highest	
13.110 – 14.010	0.000204	13.560678	13.560882	Pass

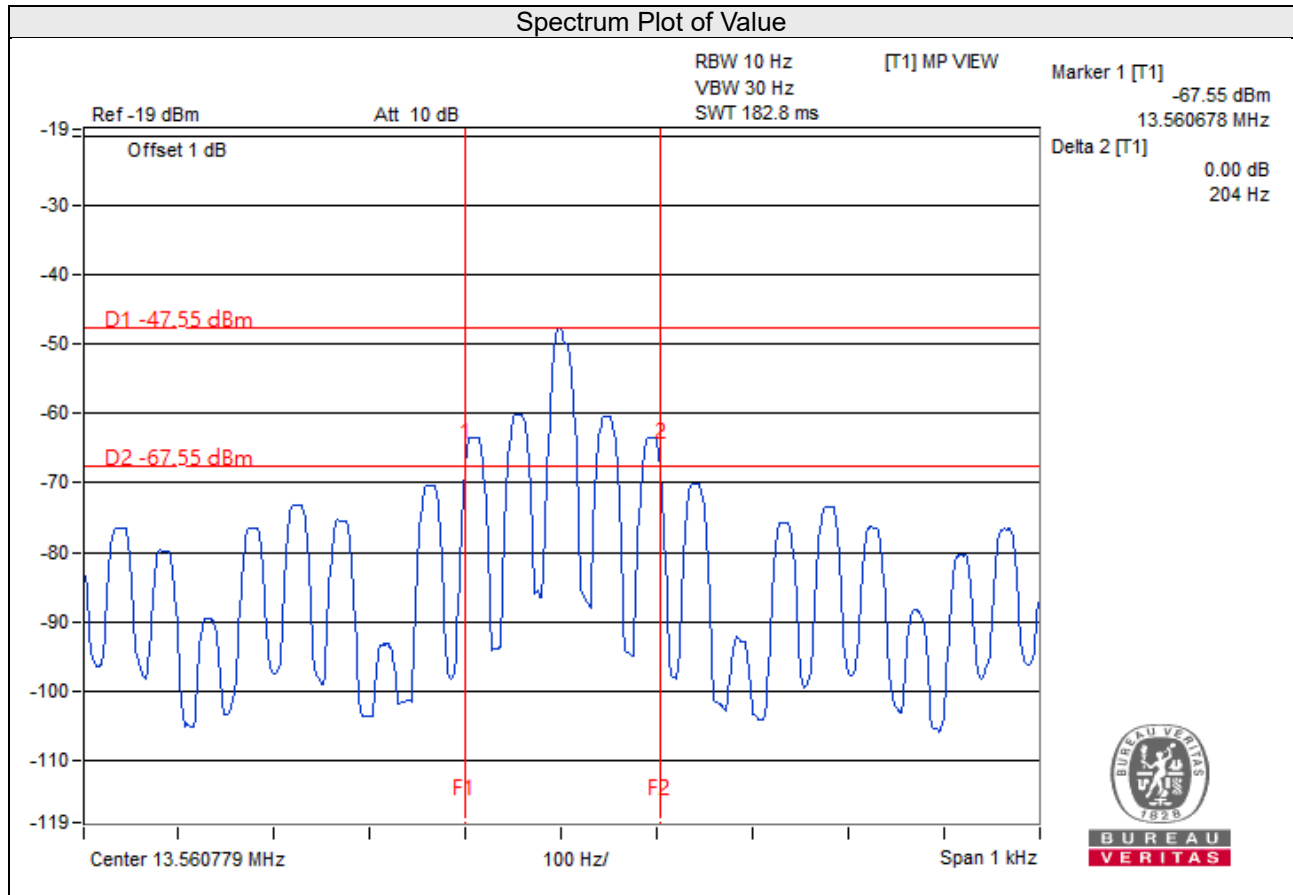

## 5 Pictures of Test Arrangements

Please refer to the attached file (Test Setup Photo).



## Appendix – Information of the Testing Laboratories

We, Bureau Veritas Consumer Products Services (H.K.) Ltd., Taoyuan Branch, were founded in 1988 to provide our best service in EMC, Radio, Telecom and Safety consultation. Our laboratories are FCC recognized accredited test firms and accredited according to ISO/IEC 17025.

If you have any comments, please feel free to contact us at the following:

**Lin Kou EMC/RF Lab**

Tel: 886-2-26052180

Fax: 886-2-26051924

**Hsin Chu EMC/RF/Telecom Lab**

Tel: 886-3-6668565

Fax: 886-3-6668323

**Hwa Ya EMC/RF/Safety Lab**

Tel: 886-3-3183232

Fax: 886-3-3270892

**Email:** [service.adt@tw.bureauveritas.com](mailto:service.adt@tw.bureauveritas.com)

**Web Site:** [www.bureauveritas-adt.com](http://www.bureauveritas-adt.com)

The address and road map of all our labs can be found in our web site also.

--- END ---