

FCC Test Report (PART 27)

Report No.: RF200630E06-7

FCC ID: MQT-AT100R6

Test Model: xCL_AT-100-R6-18U

Received Date: June 22, 2020

Test Date: July 10 to 27, 2020

Issued Date: Oct. 08, 2021

Applicant: XAC AUTOMATION CORP.

Address: 4F, No. 30, INDUSTRY E. RD. IX, SCIENCE-BASED INDUSTRIAL
PARK,HSINCHU,TAIWAN

Issued By: Bureau Veritas Consumer Products Services (H.K.) Ltd., Taoyuan Branch
Hsin Chu Laboratory

Lab Address: E-2, No.1, Li Hsin 1st Road, Hsinchu Science Park, Hsinchu City 300,
Taiwan

Test Location: E-2, No.1, Li Hsin 1st Road, Hsinchu Science Park, Hsinchu City 300,
Taiwan

**FCC Registration /
Designation Number:** 723255 / TW2022



This report is for your exclusive use. Any copying or replication of this report to or for any other person or entity, or use of our name or trademark, is permitted only with our prior written permission. This report sets forth our findings solely with respect to the test samples identified herein. The results set forth in this report are not indicative or representative of the quality or characteristics of the lot from which a test sample was taken or any similar or identical product unless specifically and expressly noted. Our report includes all of the tests requested by you and the results thereof based upon the information that you provided to us. You have 60 days from date of issuance of this report to notify us of any material error or omission caused by our negligence, provided, however, that such notice shall be in writing and shall specifically address the issue you wish to raise. A failure to raise such issue within the prescribed time shall constitute your unqualified acceptance of the completeness of this report, the tests conducted and the correctness of the report contents. Unless specifically mentioned, the uncertainty of measurement has been explicitly taken into account to declare the compliance or non-compliance to the specification.

Table of Contents

Release Control Record	4
1 Certificate of Conformity	5
2 Summary of Test Results	6
2.1 Measurement Uncertainty	6
2.2 Test Site and Instruments	7
3 General Information	9
3.1 General Description of EUT	9
3.2 Configuration of System under Test	12
3.2.1 Description of Support Units	13
3.3 Test Mode Applicability and Tested Channel Detail	14
3.4 EUT Operating Conditions	18
3.5 General Description of Applied Standards and references	18
4 Test Types and Results	19
4.1 Output Power Measurement	19
4.1.1 Limits of Output Power Measurement	19
4.1.2 Test Procedures	19
4.1.3 Test Setup	20
4.1.4 Test Results	21
4.2 Modulation characteristics Measurement	28
4.2.1 Limits of Modulation characteristics	28
4.2.2 Test Procedure	28
4.2.3 Test Setup	28
4.2.4 Test Results	29
4.3 Frequency Stability Measurement	30
4.3.1 Limits of Frequency Stability Measurement	30
4.3.2 Test Procedure	30
4.3.3 Test Setup	30
4.3.4 Test Results	31
4.4 Emission Bandwidth Measurement	33
4.4.1 Limits of Emission Bandwidth Measurement	33
4.4.2 Test Procedure	33
4.4.3 Test Setup	33
4.4.4 Test Results (-26dB Bandwidth)	34
4.4.5 Test Results (Occupied Bandwidth)	37
4.5 Channel Edge Measurement	40
4.5.1 Limits of Channel Edge Measurement	40
4.5.2 Test Setup	41
4.5.3 Test Procedures	41
4.5.4 Test Results	42
4.6 Peak to Average Ratio	52
4.6.1 Limits of Peak to Average Ratio Measurement	52
4.6.2 Test Setup	52
4.6.3 Test Procedures	52
4.6.4 Test Results	53
4.7 Conducted Spurious Emissions	56
4.7.1 Limits of Conducted Spurious Emissions Measurement	56
4.7.2 Test Setup	56
4.7.3 Test Procedure	56
4.7.4 Test Results	57
4.8 Radiated Emission Measurement	79
4.8.1 Limits of Radiated Emission Measurement	79
4.8.2 Test Procedure	79
4.8.3 Deviation from Test Standard	79

4.8.4 Test Setup.....	80
4.8.5 Test Results	81
5 Pictures of Test Arrangements.....	141
Appendix – Information of the Testing Laboratories	142

Release Control Record

Issue No.	Description	Date Issued
RF200630E06-7	Original release.	Oct. 08, 2021

1 Certificate of Conformity

Product: Terminal

Brand: XAC

Test Model: xCL_AT-100-R6-18U

Sample Status: ENGINEERING SAMPLE

Applicant: XAC AUTOMATION CORP.

Test Date: July 10 to 27, 2020

Standards: FCC Part 27, Subpart H / L
FCC Part 2

The above equipment has been tested by **Bureau Veritas Consumer Products Services (H.K.) Ltd., Taoyuan Branch**, and found compliance with the requirement of the above standards. The test record, data evaluation & Equipment Under Test (EUT) configurations represented herein are true and accurate accounts of the measurements of the sample's EMC characteristics under the conditions specified in this report.

Prepared by :  _____, **Date:** _____ Oct. 08, 2021
Claire Kuan / Specialist

Approved by :  _____, **Date:** _____ Oct. 08, 2021
Clark Lin / Technical Manager

2 Summary of Test Results

Applied Standard: FCC Part 27 & Part 2			
FCC Clause	Test Item	Result	Remarks
2.1046 27.50	Radiated Power	PASS	Meet the requirement of limit.
2.1047	Modulation characteristics	PASS	Meet the requirement
2.1055 27.54	Frequency Stability Stay with the authorized bands of operation	PASS	Meet the requirement of limit.
2.1049 27.53	Occupied Bandwidth	PASS	Meet the requirement of limit.
27.53	Band Edge Measurements	PASS	Meet the requirement of limit.
---	Peak To Average Ratio	PASS	Meet the requirement of limit.
2.1051 27.53	Conducted Spurious Emissions	PASS	Meet the requirement of limit.
2.1053 27.53	Radiated Spurious Emissions	PASS	Meet the requirement of limit. Minimum passing margin is -27.78dB at 3465 MHz.

Note:

Determining compliance based on the results of the compliance measurement, not taking into account measurement instrumentation uncertainty

2.1 Measurement Uncertainty

Where relevant, the following measurement uncertainty levels have been estimated for tests performed on the EUT as specified in CISPR 16-4-2:

Measurement	Frequency	Expanded Uncertainty (k=2) (\pm)
Radiated Emissions up to 1 GHz	9kHz ~ 30MHz	3.1 dB
	30MHz ~ 1GHz	5.1 dB
Radiated Emissions above 1 GHz	1GHz ~ 18GHz	5.1 dB
	18GHz ~ 40GHz	5.3 dB

2.2 Test Site and Instruments

For radiated spurious emissions test:

DESCRIPTION & MANUFACTURER	MODEL NO.	SERIAL NO.	CALIBRATED DATE	CALIBRATED UNTIL
Test Receiver R&S	ESR7	102026	Apr. 22, 2020	Apr. 21, 2021
Spectrum Analyzer Keysight	N9030B	MY57141948	May 22, 2020	May 21, 2021
Pre-Amplifier EMCI	EMC001340	980142	May 25, 2020	May 24, 2021
Loop Antenna Electro-Metrics	EM-6879	264	Feb. 18, 2020	Feb. 17, 2021
RF Cable	NA	LOOPCAB-001	Jan. 08, 2020	Jan. 07, 2021
RF Cable	NA	LOOPCAB-002	Jan. 08, 2020	Jan. 07, 2021
Pre-Amplifier EMCI	EMC330N	980538	Apr. 28, 2020	Apr. 27, 2021
Trilog Broadband Antenna SCHWARZBECK	VULB9168	9168-0842	Nov. 08, 2019	Nov. 07, 2020
RF Cable	8D	966-5-1	Apr. 29, 2020	Apr. 28, 2021
RF Cable	8D	966-5-2	Apr. 29, 2020	Apr. 28, 2021
RF Cable	8D	966-5-3	Apr. 29, 2020	Apr. 28, 2021
Fixed attenuator Mini-Circuits	UNAT-5+	PAD-ATT5-02	Jan. 14, 2020	Jan. 13, 2021
Horn_Antenna SCHWARZBECK	BBHA 9120D	9120D-1819	Nov. 24, 2019	Nov. 23, 2020
Pre-Amplifier EMCI	EMC12630SE	980509	Apr. 29, 2020	Apr. 28, 2021
RF Cable EMCI	EMC104-SM-SM-1500	180503	Apr. 29, 2020	Apr. 28, 2021
RF Cable EMCI	EMC104-SM-SM-2000	180501	Apr. 29, 2020	Apr. 28, 2021
RF Cable EMCI	EMC104-SM-SM-6000	180506	Apr. 29, 2020	Apr. 28, 2021
Pre-Amplifier EMCI	EMC184045SE	980387	Jan. 15, 2020	Jan. 14, 2021
Horn_Antenna SCHWARZBECK	BBHA 9170	BBHA9170519	Nov. 24, 2019	Nov. 23, 2020
RF Cable	EMC102-KM-KM-1200	160924	Jan. 15, 2020	Jan. 14, 2021
RF Cable	EMC-KM-KM-4000	200214	Mar. 11, 2020	Mar. 10, 2021
Software	ADT_Radiated_V8.7.08	NA	NA	NA
Boresight Antenna Tower & Turn Table Max-Full	MF-7802BS	MF780208530	NA	NA

Note:

1. The calibration interval of the above test instruments is 12 months and the calibrations are traceable to NML/ROC and NIST/USA.
2. The test was performed in 966 Chamber No. 5.
3. Tested Date: July 10 to 27, 2020

For other test items:

DESCRIPTION & MANUFACTURER	MODEL NO.	SERIAL NO.	CALIBRATED DATE	CALIBRATED UNTIL
Spectrum Analyzer R&S	FSV40	100964	May 29, 2020	May 28, 2021
Spectrum Analyzer Keysight	N9030A	MY54490679	July 17, 2019	July 16, 2020
Power meter Anritsu	ML2495A	1529002	July 26, 2019	July 25, 2020
Power sensor Anritsu	MA2411B	1339443	July 26, 2019	July 25, 2020
Fixed Attenuator Mini-Circuits	MDCS18N-10	MDCS18N-10-01	Apr. 14, 2020	Apr. 13, 2021
Mech Switch Absorptive Mini-Circuits	MSP4TA-18+	0140	Feb. 10, 2020	Feb. 09, 2021
FXD ATTEN Mini-Circuits	BW-S3W2+	MN71981	Feb. 10, 2020	Feb. 09, 2021
Software	ADT_RF Test Software V6.6.5.4	NA	NA	NA

- Note:**
1. The test was performed in Oven room 2.
 2. The calibration interval of the above test instruments is 12 months and the calibrations are traceable to NML/ROC and NIST/USA.
 3. Tested Date: July 10, 2020

3 General Information

3.1 General Description of EUT

Product	Terminal	
Brand	XAC	
Test Model	xCL_AT-100-R6-18U	
Status of EUT	ENGINEERING SAMPLE	
Power Supply Rating	Refer to note	
Modulation Type	LTE	QPSK, 16QAM
Operating Frequency	LTE Band 4	1710.7 ~ 1754.3 MHz
	LTE Band 12	699.7 ~ 715.3 MHz
Max. EIRP Power	LTE Band 4 (Channel Bandwidth 1.4MHz)	24.24dBm
	LTE Band 4 (Channel Bandwidth 3MHz)	24.19dBm
	LTE Band 4 (Channel Bandwidth 5MHz)	24.09dBm
	LTE Band 4 (Channel Bandwidth 10MHz)	24.21dBm
	LTE Band 4 (Channel Bandwidth 15MHz)	24.26dBm
	LTE Band 4 (Channel Bandwidth 20MHz)	24.31dBm
Max. ERP Power	LTE Band 12 (Channel Bandwidth 1.4MHz)	22.61dBm
	LTE Band 12 (Channel Bandwidth 3MHz)	22.70dBm
	LTE Band 12 (Channel Bandwidth 5MHz)	22.76dBm
	LTE Band 12 (Channel Bandwidth 10MHz)	22.78dBm

Emission Designator	LTE Band 4 (Channel Bandwidth 1.4MHz)	QPSK: 1M08G7D 16QAM: 1M08D7W	
	LTE Band 4 (Channel Bandwidth 3MHz)	QPSK: 2M69G7D 16QAM: 2M68D7W	
	LTE Band 4 (Channel Bandwidth 5MHz)	QPSK: 4M48G7D 16QAM: 4M48D7W	
	LTE Band 4 (Channel Bandwidth 10MHz)	QPSK: 8M94G7D 16QAM: 8M94D7W	
	LTE Band 4 (Channel Bandwidth 15MHz)	QPSK: 13M4G7D 16QAM: 13M4D7W	
	LTE Band 4 (Channel Bandwidth 20MHz)	QPSK: 17M9G7D 16QAM: 17M8D7W	
	LTE Band 12 (Channel Bandwidth 1.4MHz)	QPSK: 1M08G7D 16QAM: 1M08D7W	
	LTE Band 12 (Channel Bandwidth 3MHz)	QPSK: 2M69G7D 16QAM: 2M68D7W	
	LTE Band 12 (Channel Bandwidth 5MHz)	QPSK: 4M48G7D 16QAM: 4M48D7W	
	LTE Band 12 (Channel Bandwidth 10MHz)	QPSK: 8M96G7D 16QAM: 8M96D7W	
	Antenna Type	Refer to Note	
	Antenna Connector	Refer to Note	
Accessory Device	Battery (option) x1		
Data Cable Supplied	NA		

Note:

1. The EUT has three radios as following table:

Radio 1	Radio 2	Radio 3
WLAN(2.4GHz + 5GHz) + Bluetooth	WWAN(LTE + WCDMA)	NFC

2. Simultaneously transmission condition.

Condition	Technology	
1	WWAN	NFC
2	WWAN	Bluetooth
3	WLAN 2.4GHz	NFC
4	WLAN 5GHz	NFC
5	Bluetooth	NFC

Note: The emission of the simultaneous operation has been evaluated and no non-compliance was found.

3. The EUT power needs to be supplied from a power adapter and battery, the information is as below table:

Adapter (only for test, not for sale)		
Brand	Model No.	Spec.
DEE VAN ENTERPRISE CO., LTD	DSA-18PFCA-05 050300	Input: 100-240Vac, 0.6A, 50/60Hz Output: 5Vdc, 3A
Battery (option)		
Brand	Model No.	Spec.
Shenzhen Rishengzhi Electronics Technology Co., Ltd.	W001	Output: 3.6V, 6700mAh, 24.12Wh

4. The antennas provided to the EUT, please refer to the following table:

Antenna Set.	RF Chain No.	Brand	Model	Antenna Net Gain(dBi)	Frequency Range	Antenna Type	Connector Type
NFC	Main	XAC	RTOS	13	13.56MHz	wire	None
Wi-Fi BT	Main	AWAN	AYF6P-100002	2.29	2400MHz~2500MHz	PIFA	i-pex(MHF)
				2.77	5150MHz~5850MHz		
LTE	Main(B2) TX	AWAN	AXF6P-100015	2.11	1850 MHz to 1910 MHz	PIFA	i-pex(MHF)
	Main(B4) TX			1.33	1710 MHz to 1755 MHz		
	Main(B12) TX			1.46	699 MHz to 715 MHz		
	Main(B2) RX			2.69	1930 MHz to 1990 MHz		
	Main(B4) RX			0.66	2110 MHz to 2155 MHz		
	Main(B12) RX			2.64	729 MHz to 745 MHz		
	Aux(B2) RX	AWAN	AXF6P-100005	1.95	1930 MHz to 1990 MHz	PIFA	i-pex(MHF)
	Aux(B4) RX			2.96	2110 MHz to 2155 MHz		
	Aux(B12) RX			2.61	729 MHz to 746 MHz		
WCDMA	Main(B2) TX	AWAN	AXF6P-100015	2.11	1850 MHz to 1910 MHz	PIFA	i-pex(MHF)
	Main(B5) TX			0.32	824 MHz to 849 MHz		
	Main(B2) RX			2.69	1930 MHz to 1990 MHz		
	Main(B5) RX			2.53	869 MHz to 894 MHz		
	Aux(B2) RX	AWAN	AXF6P-100005	2.45	1930 MHz to 1990 MHz	PIFA	i-pex(MHF)
	Aux(B5) RX			1.23	869 MHz to 894 MHz		
GPS	Main	YAGEO	ANT8010JLD2B151	3.29	1575.42MHz	Chip	i-pex(MHF)

5. The EUT was pre-tested for radiated emission test under following test modes:

Pre-test Mode	Power
Mode A	Power from Adapter
Mode B	Power from Battery

From the above modes, the worst radiated test was found in **Mode A**.

6. The above EUT information is declared by manufacturer and for more detailed features description, please refer to the manufacturer's specifications or User's Manual.

7. The above Antenna information is declared by manufacturer and for more detailed features description, please refer to the manufacturer's specifications, the laboratory shall not be held responsible.

3.2 Configuration of System under Test

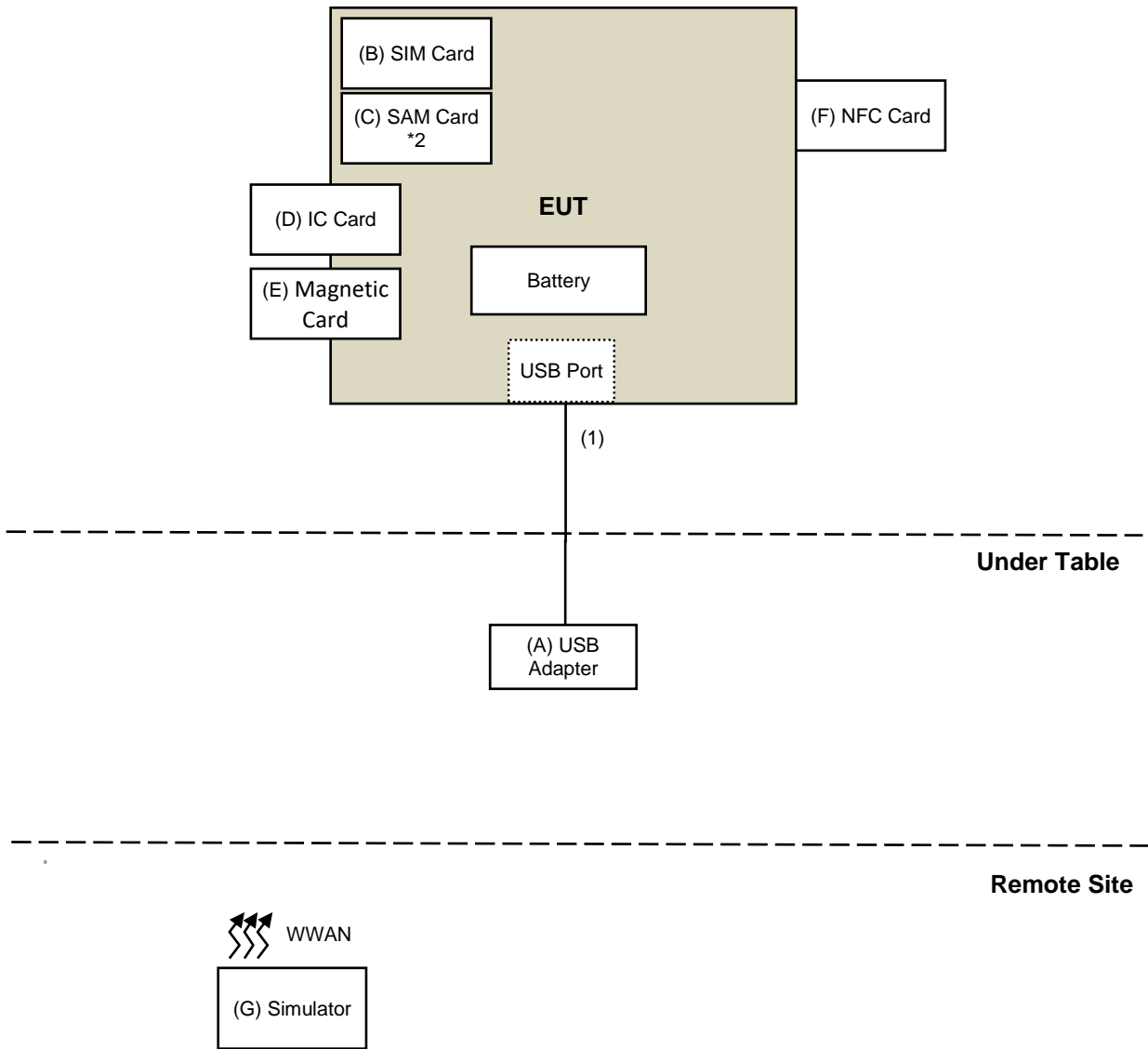

3.2.1 Description of Support Units

The EUT has been tested as an independent unit together with other necessary accessories or support units. The following support units or accessories were used to form a representative test configuration during the tests.

ID	Product	Brand	Model No.	Serial No.	FCC ID	Remarks
A.	USB Adapter	DEE VAN	DSA-18PFCA-05 050300	NA	NA	Supplied by client
B.	SIM Card	Keysight	NA	NA	NA	Provided by Lab
C.	SAM Card *2	XAC	NA	NA	NA	Supplied by client
D.	IC Card	XAC	NA	NA	NA	Supplied by client
E.	Magnetic Card	XAC	NA	NA	NA	Supplied by client
F.	NFC Card	XAC	NA	NA	NA	Supplied by client
G.	Simulator	Anritsu	MT8820C	6201127458	NA	Provided by Lab

Note:

1. All power cords of the above support units are non-shielded (1.8m).

ID	Descriptions	Qty.	Length (m)	Shielding (Yes/No)	Cores (Qty.)	Remarks
1.	USB Type C to USB Cable	1	1.2	Yes	0	Supplied by client

3.3 Test Mode Applicability and Tested Channel Detail

LTE Band 4

TEST ITEM	AVAILABLE CHANNEL	TESTED CHANNEL	CHANNEL BANDWIDTH	MODULATION	MODE
EIRP	19957 to 20393	19957, 20175, 20393	1.4MHz	QPSK/16QAM	1RB / 0 RB offset
	19965 to 20385	19965, 20175, 20385	3MHz	QPSK/16QAM	1RB / 0 RB offset
	19975 to 20375	19975, 20175, 20375	5MHz	QPSK/16QAM	1RB / 0 RB offset
	20000 to 20350	20000, 20175, 20350	10MHz	QPSK/16QAM	1RB / 0 RB offset
	20025 to 20325	20025, 20175, 20325	15MHz	QPSK/16QAM	1RB / 0 RB offset
	20050 to 20300	20050, 20175, 20300	20MHz	QPSK/16QAM	1RB / 0 RB offset
Frequency Stability	19957 to 20393	20175	1.4MHz	QPSK	-
	19965 to 20385	20175	3MHz	QPSK	-
	19975 to 20375	20175	5MHz	QPSK	-
	20000 to 20350	20175	10MHz	QPSK	-
	20025 to 20325	20175	15MHz	QPSK	-
	20050 to 20300	20175	20MHz	QPSK	-
Occupied Bandwidth	19957 to 20393	19957, 20175, 20393	1.4MHz	QPSK/16QAM	Full RB
	19965 to 20385	19965, 20175, 20385	3MHz	QPSK/16QAM	Full RB
	19975 to 20375	19975, 20175, 20375	5MHz	QPSK/16QAM	Full RB
	20000 to 20350	20000, 20175, 20350	10MHz	QPSK/16QAM	Full RB
	20025 to 20325	20025, 20175, 20325	15MHz	QPSK/16QAM	Full RB
	20050 to 20300	20050, 20175, 20300	20MHz	QPSK/16QAM	Full RB
Peak to Average Ratio	19957 to 20393	19957, 20175, 20393	1.4MHz	QPSK/16QAM	Full RB
	19965 to 20385	19965, 20175, 20385	3MHz	QPSK/16QAM	Full RB
	19975 to 20375	19975, 20175, 20375	5MHz	QPSK/16QAM	Full RB
	20000 to 20350	20000, 20175, 20350	10MHz	QPSK/16QAM	Full RB
	20025 to 20325	20025, 20175, 20325	15MHz	QPSK/16QAM	Full RB
	20050 to 20300	20050, 20175, 20300	20MHz	QPSK/16QAM	Full RB
Band Edge	19957 to 20393	19957	1.4MHz	QPSK	1 RB / 0 RB Offset
		20393			1 RB / 5 RB Offset
		19957, 20393			6 RB / 0 RB Offset
	19965 to 20385	19965	3MHz	QPSK	1 RB / 0 RB Offset
		20385			1 RB / 14 RB Offset
		19965, 20385			15 RB / 0 RB Offset
	19975 to 20375	19975	5MHz	QPSK	1 RB / 0 RB Offset
		20375			1 RB / 24 RB Offset
		19975, 20375			25 RB / 0 RB Offset
	20000 to 20350	20000	10MHz	QPSK	1 RB / 0 RB Offset
		20350			1 RB / 49 RB Offset
		20000, 20350			50 RB / 0 RB Offset
	20025 to 20325	20025	15MHz	QPSK	1 RB / 0 RB Offset
		20325			1 RB / 74 RB Offset
		20025, 20325			75 RB / 0 RB Offset
20050 to 20300	20050	20MHz	QPSK	1 RB / 0 RB Offset	
	20300			1 RB / 99 RB Offset	
	20050, 20300			100 RB / 0 RB Offset	

Conducted Emission	19957 to 20393	19957, 20175, 20393	1.4MHz	QPSK	1 RB / 0 RB Offset
	19965 to 20385	19965, 20175, 20385	3MHz	QPSK	1 RB / 0 RB Offset
	19975 to 20375	19975, 20175, 20375	5MHz	QPSK	1 RB / 0 RB Offset
	20000 to 20350	20000, 20175, 20350	10MHz	QPSK	1 RB / 0 RB Offset
	20025 to 20325	20025, 20175, 20325	15MHz	QPSK	1 RB / 0 RB Offset
	20050 to 20300	20050, 20175, 20300	20MHz	QPSK	1 RB / 0 RB Offset
Radiated Emission	19957 to 20393	19957, 20175, 20393	1.4MHz	QPSK	1 RB / 0 RB Offset
	19965 to 20385	19965, 20175, 20385	3MHz	QPSK	1 RB / 0 RB Offset
	19975 to 20375	19975, 20175, 20375	5MHz	QPSK	1 RB / 0 RB Offset
	20000 to 20350	20000, 20175, 20350	10MHz	QPSK	1 RB / 0 RB Offset
	20025 to 20325	20025, 20175, 20325	15MHz	QPSK	1 RB / 0 RB Offset
	20050 to 20300	20050, 20175, 20300	20MHz	QPSK	1 RB / 0 RB Offset

NOTE:

All supported modulation types were evaluated. The Worst case of QPSK was selected. Therefore, the Frequency Stability, Band Edge, Condcudeted Emission and Radiated Emission were presented under QPSK mode only.

Test Condition:

Test Item	Environmental Conditions	Input Power (System)	Tested By
EIRP	23deg. C, 62%RH	120Vac, 60Hz	Allen Chuang
Frequency Stability	23deg. C, 62%RH	120Vac, 60Hz	Allen Chuang
Occupied Bandwidth	23deg. C, 62%RH	120Vac, 60Hz	Allen Chuang
Band Edge	23deg. C, 62%RH	120Vac, 60Hz	Allen Chuang
Peak to Average Ratio	23deg. C, 62%RH	120Vac, 60Hz	Allen Chuang
Condcudeted Emission	23deg. C, 62%RH	120Vac, 60Hz	Allen Chuang
Radiated Emission Below 1GHz	25deg. C, 75%RH	120Vac, 60Hz	Nelson Teng
Radiated Emission Above 1GHz	25deg. C, 75%RH	120Vac, 60Hz	Nelson Teng

LTE Band 12

TEST ITEM	AVAILABLE CHANNEL	TESTED CHANNEL	CHANNEL BANDWIDTH	MODULATION	MODE
ERP	23017 to 23173	23017, 23095, 23173	1.4MHz	QPSK/16QAM	1RB / 0 RB offset
	23025 to 23165	23025, 23095, 23165	3MHz	QPSK/16QAM	1RB / 0 RB offset
	23035 to 23155	23035, 23095, 23155	5MHz	QPSK/16QAM	1RB / 0 RB offset
	23060 to 23130	23060, 23095, 23130	10MHz	QPSK/16QAM	1RB / 0 RB offset
Frequency Stability	23017 to 23173	23095	1.4MHz	QPSK	-
	23025 to 23165	23095	3MHz	QPSK	-
	23035 to 23155	23095	5MHz	QPSK	-
	23060 to 23130	23095	10MHz	QPSK	-
Occupied Bandwidth	23017 to 23173	23017, 23095, 23173	1.4MHz	QPSK/16QAM	Full RB
	23025 to 23165	23025, 23095, 23165	3MHz	QPSK/16QAM	Full RB
	23035 to 23155	23035, 23095, 23155	5MHz	QPSK/16QAM	Full RB
	23060 to 23130	23060, 23095, 23130	10MHz	QPSK/16QAM	Full RB
Peak to Average Ratio	23017 to 23173	23017, 23095, 23173	1.4MHz	QPSK/16QAM	Full RB
	23025 to 23165	23025, 23095, 23165	3MHz	QPSK/16QAM	Full RB
	23035 to 23155	23035, 23095, 23155	5MHz	QPSK/16QAM	Full RB
	23060 to 23130	23060, 23095, 23130	10MHz	QPSK/16QAM	Full RB
Band Edge	23017 to 23173	23017	1.4MHz	QPSK	1 RB / 0 RB Offset
		23173			1 RB / 5 RB Offset
		23017, 23173			6 RB / 0 RB Offset
	23025 to 23165	23025	3MHz	QPSK	1 RB / 0 RB Offset
		23165			1 RB / 14 RB Offset
		23025, 23165			15 RB / 0 RB Offset
	23035 to 23155	23035	5MHz	QPSK	1 RB / 0 RB Offset
		23155			1 RB / 24 RB Offset
		23035, 23155			25 RB / 0 RB Offset
	23060 to 23130	23060	10MHz	QPSK	1 RB / 0 RB Offset
		23130			1 RB / 49 RB Offset
		23060, 23130			50 RB / 0 RB Offset
Conducted Emission	23017 to 23173	23017, 23095, 23173	1.4MHz	QPSK	1RB / 0 RB offset
	23025 to 23165	23025, 23095, 23165	3MHz	QPSK	1RB / 0 RB offset
	23035 to 23155	23035, 23095, 23155	5MHz	QPSK	1RB / 0 RB offset
	23060 to 23130	23060, 23095, 23130	10MHz	QPSK	1RB / 0 RB offset
Radiated Emission	23017 to 23173	23017, 23095, 23173	1.4MHz	QPSK	1RB / 0 RB offset
	23025 to 23165	23025, 23095, 23165	3MHz	QPSK	1RB / 0 RB offset
	23035 to 23155	23035, 23095, 23155	5MHz	QPSK	1RB / 0 RB offset
	23060 to 23130	23060, 23095, 23130	10MHz	QPSK	1RB / 0 RB offset

NOTE:

All supported modulation types were evaluated. The Worst case of QPSK was selected. Therefore, the Frequency Stability, Band Edge, Condcudeted Emission and Radiated Emission were presented under QPSK mode only.

Test Condition:

Test Item	Environmental Conditions	Input Power (System)	Tested By
ERP	23deg. C, 62%RH	120Vac, 60Hz	Allen Chuang
Frequency Stability	23deg. C, 62%RH	120Vac, 60Hz	Allen Chuang
Occupied Bandwidth	23deg. C, 62%RH	120Vac, 60Hz	Allen Chuang
Band Edge	23deg. C, 62%RH	120Vac, 60Hz	Allen Chuang
Peak to Average Ratio	23deg. C, 62%RH	120Vac, 60Hz	Allen Chuang
Conducuted Emission	23deg. C, 62%RH	120Vac, 60Hz	Allen Chuang
Radiated Emission Below 1GHz	25deg. C, 75%RH	120Vac, 60Hz	Nelson Teng
Radiated Emission Above 1GHz	25deg. C, 75%RH	120Vac, 60Hz	Nelson Teng

3.4 EUT Operating Conditions

The communication simulator station system controlled a EUT to export maximum output power under transmission mode and specific channel frequency

3.5 General Description of Applied Standards and references

The EUT is a RF Product. According to the specifications of the manufacturer, it must comply with the requirements of the following standards and references:

Test standard:

FCC 47 CFR Part 2

FCC 47 CFR Part 27, Subpart H / L

ANSI/TIA/EIA-603-E 2016

ANSI 63.26-2015

All test items have been performed and recorded as per the above standards.

References Test Guidance :

KDB 971168 D01 Power Meas License Digital Systems v03r01

All test items have been performed as a reference to the above KDB test guidance.

4 Test Types and Results

4.1 Output Power Measurement

4.1.1 Limits of Output Power Measurement

For section 27.50(d)(4): Fixed, mobile, and portable (hand-held) stations operating in the 1710-1755 MHz band and mobile and portable stations operating in the 1695-1710 MHz and 1755-1780 MHz bands are limited to 1 watt EIRP.

For section 27.50(b)(10): Portable stations (hand-held devices) operating in the 698-787 MHz band are limited to 3 watts ERP.

4.1.2 Test Procedures

Conducted Power Measurement:

The EUT was set up for the maximum power with LTE link data modulation and link up with simulator. Set the EUT to transmit under low, middle and high channel and difference RB size/ RB offset for difference bandwidth record the power level shown on power meter.

EIRP / ERP Measurement:

- a. $EIRP = \text{Conducted Output power level} + \text{Antenna gain}$.
- b. ERP power can be calculated from EIRP power by subtracting the gain of dipole, $ERP \text{ power} = EIRP \text{ power} - 2.15dBi$.
- c. $ERP = \text{Conducted Output power level} + \text{Antenna gain (dBi)} - \text{Isotropically Factor (2.15dB)}$

4.1.3 Test Setup

Conducted Power Measurement:

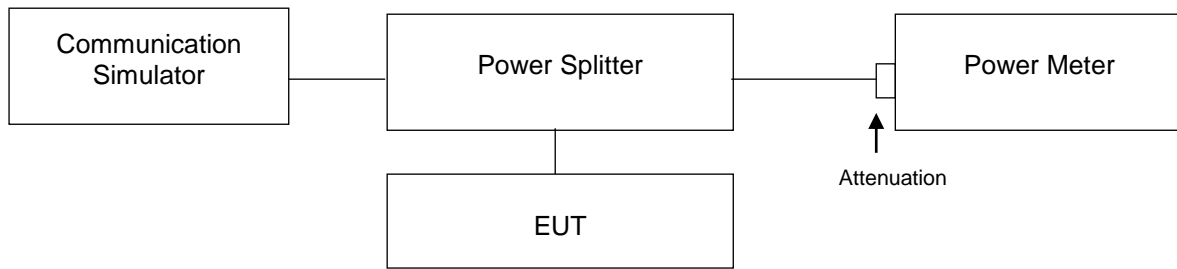

4.1.4 Test Results

CONDUCTED OUTPUT POWER (dBm)
LTE Band 4

Band / BW	RB Size	RB Offset	QPSK			3GPP MPR (dB)	16QAM			3GPP MPR (dB)
			Low CH	Mid CH	High CH		Low CH	Mid CH	High CH	
			19957	20175	20393		19957	20175	20393	
			1710.7	1732.5	1754.3		1710.7	1732.5	1754.3	
			MHz	MHz	MHz					
4 / 1.4M	1	0	22.46	22.91	22.80	0	21.28	21.73	21.68	1
	1	2	22.11	22.57	22.54	0	21.25	21.77	21.51	1
	1	5	21.93	22.19	22.34	0	20.78	21.22	21.28	1
	3	0	22.19	22.53	22.47	0	21.30	21.75	21.65	1
	3	1	21.97	22.58	22.41	0	21.14	21.54	21.47	1
	3	3	21.99	22.51	22.39	0	21.04	21.44	21.34	1
	6	0	21.08	21.57	21.57	1	20.18	20.57	20.65	2

Band / BW	RB Size	RB Offset	QPSK			3GPP MPR (dB)	16QAM			3GPP MPR (dB)
			Low CH	Mid CH	High CH		Low CH	Mid CH	High CH	
			19965	20175	20385		19965	20175	20385	
			1711.5	1732.5	1753.5		1711.5	1732.5	1753.5	
			MHz	MHz	MHz					
4 / 3M	1	0	22.42	22.86	22.73	0	21.31	21.59	21.63	1
	1	7	22.12	22.67	22.46	0	21.30	21.69	21.70	1
	1	14	21.87	22.37	22.26	0	20.87	21.20	21.30	1
	8	0	21.18	21.57	21.59	1	20.22	20.77	20.77	2
	8	3	21.08	21.51	21.51	1	20.13	20.59	20.38	2
	8	7	21.13	21.55	21.31	1	20.05	20.48	20.44	2
	15	0	21.14	21.56	21.59	1	20.15	20.63	20.48	2

Band / BW	RB Size	RB Offset	QPSK			3GPP MPR (dB)	16QAM			3GPP MPR (dB)
			Low CH	Mid CH	High CH		Low CH	Mid CH	High CH	
			19975	20175	20375		19975	20175	20375	
			1712.5	1732.5	1752.5		1712.5	1732.5	1752.5	
			MHz	MHz	MHz					
4 / 5M	1	0	22.36	22.76	22.57	0	21.32	21.71	21.66	1
	1	12	22.17	22.61	22.54	0	21.31	21.65	21.65	1
	1	24	21.88	22.38	22.14	0	20.91	21.35	21.33	1
	12	0	21.07	21.58	21.37	1	20.36	20.74	20.75	2
	12	6	21.16	21.42	21.41	1	20.18	20.61	20.51	2
	12	13	20.92	21.54	21.24	1	20.00	20.51	20.54	2
	25	0	21.19	21.50	21.46	1	20.17	20.65	20.56	2

Band / BW	RB Size	RB Offset	QPSK			3GPP MPR (dB)	16QAM			3GPP MPR (dB)	
			Low CH	Mid CH	High CH		Low CH	Mid CH	High CH		
			20000	20175	20350		20000	20175	20350		
			1715	1732.5	1750		1715	1732.5	1750		
			MHz	MHz	MHz						
4 / 10M	1	0	22.47	22.88	22.81	0	21.21	21.70	21.73	1	
	1	24	22.21	22.56	22.56	0	21.21	21.61	21.71	1	
	1	49	21.79	22.29	22.29	0	20.94	21.29	21.15	1	
	25	0	21.08	21.60	21.50	1	20.44	20.79	20.81	2	
	25	12	21.12	21.61	21.59	1	20.07	20.40	20.51	2	
	25	25	20.93	21.47	21.50	1	20.10	20.49	20.40	2	
	50	0	21.03	21.55	21.46	1	20.16	20.69	20.51	2	

Band / BW	RB Size	RB Offset	QPSK			3GPP MPR (dB)	16QAM			3GPP MPR (dB)	
			Low CH	Mid CH	High CH		Low CH	Mid CH	High CH		
			20025	20175	20325		20025	20175	20325		
			1717.5	1732.5	1747.5		1717.5	1732.5	1747.5		
			MHz	MHz	MHz						
4 / 15M	1	0	22.55	22.93	22.88	0	21.39	21.79	21.76	1	
	1	37	22.23	22.74	22.69	0	21.26	21.77	21.68	1	
	1	74	21.92	22.41	22.30	0	20.91	21.39	21.36	1	
	36	0	21.23	21.59	21.60	1	20.43	20.84	20.84	2	
	36	19	21.13	21.65	21.57	1	20.12	20.61	20.61	2	
	36	39	21.03	21.46	21.46	1	20.11	20.52	20.51	2	
	75	0	21.19	21.62	21.59	1	20.25	20.71	20.59	2	

Band / BW	RB Size	RB Offset	QPSK			3GPP MPR (dB)	16QAM			3GPP MPR (dB)	
			Low CH	Mid CH	High CH		Low CH	Mid CH	High CH		
			20050	20175	20300		20050	20175	20300		
			1720	1732.5	1745		1720	1732.5	1745		
			MHz	MHz	MHz						
4 / 20M	1	0	22.55	22.98	22.94	0	21.39	21.82	21.78	1	
	1	50	22.31	22.74	22.70	0	21.36	21.79	21.75	1	
	1	99	21.98	22.41	22.37	0	20.99	21.42	21.38	1	
	50	0	21.26	21.69	21.65	1	20.45	20.88	20.84	2	
	50	25	21.22	21.65	21.61	1	20.22	20.65	20.61	2	
	50	50	21.13	21.56	21.52	1	20.16	20.59	20.55	2	
	100	0	21.23	21.66	21.62	1	20.28	20.71	20.67	2	

LTE Band 12

Band / BW	RB Size	RB Offset	QPSK			3GPP MPR (dB)	16QAM			3GPP MPR (dB)	
			Low CH	Mid CH	High CH		Low CH	Mid CH	High CH		
			23017	23095	23173		23017	23095	23173		
			699.7	707.5	715.3		699.7	707.5	715.3		
			MHz	MHz	MHz						
12 / 1.4M	1	0	23.05	22.92	23.30	0	22.05	21.98	22.26	1	
	1	2	22.86	22.86	23.30	0	21.92	21.83	22.28	1	
	1	5	23.03	22.80	23.28	0	21.92	21.75	22.27	1	
	3	0	23.19	23.06	23.43	0	22.06	22.05	22.36	1	
	3	1	23.14	22.92	23.32	0	21.96	21.84	22.35	1	
	3	3	22.83	22.67	23.36	0	21.94	21.82	22.15	1	
	6	0	22.10	22.17	22.42	1	20.93	20.83	21.21	2	

Band / BW	RB Size	RB Offset	QPSK			3GPP MPR (dB)	16QAM			3GPP MPR (dB)	
			Low CH	Mid CH	High CH		Low CH	Mid CH	High CH		
			23025	23095	23165		23025	23095	23165		
			700.5	707.5	714.5		700.5	707.5	714.5		
			MHz	MHz	MHz						
12 / 3M	1	0	23.04	23.01	23.39	0	22.10	22.04	22.31	1	
	1	7	23.06	22.93	23.31	0	22.03	22.01	22.36	1	
	1	14	23.06	22.99	23.27	0	22.02	21.88	22.25	1	
	8	0	22.22	22.13	22.38	1	21.13	21.12	21.38	2	
	8	3	22.16	22.03	22.40	1	21.09	20.94	21.39	2	
	8	7	21.97	21.83	22.38	1	21.00	20.89	21.22	2	
	15	0	22.26	22.23	22.43	1	20.99	20.91	21.33	2	

Band / BW	RB Size	RB Offset	QPSK			3GPP MPR (dB)	16QAM			3GPP MPR (dB)	
			Low CH	Mid CH	High CH		Low CH	Mid CH	High CH		
			23035	23095	23155		23035	23095	23155		
			701.5	707.5	713.5		701.5	707.5	713.5		
			MHz	MHz	MHz						
12 / 5M	1	0	23.08	23.04	23.45	0	22.19	22.13	22.41	1	
	1	12	23.09	22.99	23.41	0	22.07	22.04	22.39	1	
	1	24	23.09	22.99	23.36	0	22.02	21.94	22.32	1	
	12	0	22.27	22.18	22.47	1	21.14	21.13	21.47	2	
	12	6	22.16	22.13	22.42	1	21.14	20.99	21.48	2	
	12	13	22.04	21.92	22.42	1	21.02	20.92	21.31	2	
	25	0	22.32	22.31	22.45	1	21.01	20.96	21.36	2	

Band / BW	RB Size	RB Offset	QPSK			3GPP MPR (dB)	16QAM			3GPP MPR (dB)	
			Low CH	Mid CH	High CH		Low CH	Mid CH	High CH		
			23060	23095	23130		23060	23095	23130		
			704	707.5	711		704	707.5	711		
			MHz	MHz	MHz						
12 / 10M	1	0	23.12	23.06	23.47	0	22.19	22.13	22.44	1	
	1	24	23.10	23.04	23.45	0	22.12	22.06	22.47	1	
	1	49	23.09	23.03	23.44	0	22.07	22.01	22.42	1	
	25	0	22.32	22.26	22.48	1	21.20	21.14	21.45	2	
	25	12	22.23	22.17	22.47	1	21.15	21.09	21.50	2	
	25	25	22.07	22.01	22.42	1	21.04	20.98	21.39	2	
	50	0	22.29	22.25	22.45	1	21.08	21.02	21.43	2	

EIRP / ERP POWER
LTE Band 4

Band / BW	RB Size	RB Offset	QPSK			3GPP MPR (dB)	16QAM			3GPP MPR (dB)
			Low CH	Mid CH	High CH		Low CH	Mid CH	High CH	
			19957	20175	20393		19957	20175	20393	
			1710.7	1732.5	1754.3		1710.7	1732.5	1754.3	
MHz	MHz	MHz	MHz	MHz	MHz					
4 / 1.4M	1	0	22.46	22.91	22.80	0	21.28	21.73	21.68	1
Gain (dBi)		1.33	1.33	1.33	1.33		1.33	1.33		
Max EIRP Power (dBm)		23.79	24.24	24.13	22.61		23.06	23.01		

Band / BW	RB Size	RB Offset	QPSK			3GPP MPR (dB)	16QAM			3GPP MPR (dB)
			Low CH	Mid CH	High CH		Low CH	Mid CH	High CH	
			19965	20175	20385		19965	20175	20385	
			1711.5	1732.5	1753.5		1711.5	1732.5	1753.5	
MHz	MHz	MHz	MHz	MHz	MHz					
4 / 3M	1	0	22.42	22.86	22.73	0	21.31	21.59	21.63	1
Gain (dBi)		1.33	1.33	1.33	1.33		1.33			
Max EIRP Power (dBm)		23.75	24.19	24.06	22.64		22.92	22.96		

Band / BW	RB Size	RB Offset	QPSK			3GPP MPR (dB)	16QAM			3GPP MPR (dB)
			Low CH	Mid CH	High CH		Low CH	Mid CH	High CH	
			19975	20175	20375		19975	20175	20375	
			1712.5	1732.5	1752.5		1712.5	1732.5	1752.5	
MHz	MHz	MHz	MHz	MHz	MHz					
4 / 5M	1	0	22.36	22.76	22.57	0	21.32	21.71	21.66	1
Gain (dBi)		1.33	1.33	1.33	1.33		1.33			
Max EIRP Power (dBm)		23.69	24.09	23.90	22.65		23.04	22.99		

Band / BW	RB Size	RB Offset	QPSK			3GPP MPR (dB)	16QAM			3GPP MPR (dB)
			Low CH	Mid CH	High CH		Low CH	Mid CH	High CH	
			20000	20175	20350		20000	20175	20350	
			1715	1732.5	1750		1715	1732.5	1750	
MHz	MHz	MHz	MHz	MHz	MHz					
4 / 10M	1	0	22.47	22.88	22.81	0	21.21	21.70	21.73	1
Gain (dBi)		1.33	1.33	1.33	1.33		1.33			
Max EIRP Power (dBm)		23.80	24.21	24.14	22.54		23.03	23.06		

Band / BW	RB Size	RB Offset	QPSK			3GPP MPR (dB)	16QAM			3GPP MPR (dB)
			Low CH	Mid CH	High CH		Low CH	Mid CH	High CH	
			20025	20175	20325		20025	20175	20325	
			1717.5	1732.5	1747.5		1717.5	1732.5	1747.5	
			MHz	MHz	MHz		MHz	MHz	MHz	
4 / 15M	1	0	22.55	22.93	22.88	0	21.39	21.79	21.76	1
Gain (dBi)			1.33	1.33	1.33		1.33	1.33	1.33	
Max EIRP Power (dBm)			23.88	24.26	24.21		22.72	23.12	23.09	

Band / BW	RB Size	RB Offset	QPSK			3GPP MPR (dB)	16QAM			3GPP MPR (dB)
			Low CH	Mid CH	High CH		Low CH	Mid CH	High CH	
			20050	20175	20300		20050	20175	20300	
			1720	1732.5	1745		1720	1732.5	1745	
			MHz	MHz	MHz		MHz	MHz	MHz	
4 / 20M	1	0	22.55	22.98	22.94	0	21.39	21.82	21.78	1
Gain (dBi)			1.33	1.33	1.33		1.33	1.33	1.33	
Max EIRP Power (dBm)			23.88	24.31	24.27		22.72	23.15	23.11	

LTE Band 12

Band / BW	RB Size	RB Offset	QPSK			3GPP MPR (dB)	16QAM			3GPP MPR (dB)
			Low CH	Mid CH	High CH		Low CH	Mid CH	High CH	
			23017	23095	23173		23017	23095	23173	
			699.7	707.5	715.3		699.7	707.5	715.3	
			MHz	MHz	MHz		MHz	MHz	MHz	
12 / 1.4M	1	0	23.05	22.92	23.30	0	22.05	21.98	22.26	1
Gain (dBi)		1.46	1.46	1.46	1.46		1.46	1.46		
Isotropically Factor (dBc)		2.15	2.15	2.15	2.15		2.15	2.15		
Max ERP Power (dBm)		22.36	22.23	22.61	21.36		21.29	21.57		

Band / BW	RB Size	RB Offset	QPSK			3GPP MPR (dB)	16QAM			3GPP MPR (dB)
			Low CH	Mid CH	High CH		Low CH	Mid CH	High CH	
			23025	23095	23165		23025	23095	23165	
			700.5	707.5	714.5		700.5	707.5	714.5	
			MHz	MHz	MHz		MHz	MHz	MHz	
12 / 3M	1	0	23.04	23.01	23.39	0	22.10	22.04	22.31	1
Gain (dBi)		1.46	1.46	1.46	1.46		1.46	1.46		
Isotropically Factor (dBc)		2.15	2.15	2.15	2.15		2.15	2.15		
Max ERP Power (dBm)		22.35	22.32	22.70	21.41		21.35	21.62		

Band / BW	RB Size	RB Offset	QPSK			3GPP MPR (dB)	16QAM			3GPP MPR (dB)
			Low CH	Mid CH	High CH		Low CH	Mid CH	High CH	
			23035	23095	23155		23035	23095	23155	
			701.5	707.5	713.5		701.5	707.5	713.5	
			MHz	MHz	MHz		MHz	MHz	MHz	
12 / 5M	1	0	23.08	23.04	23.45	0	22.19	22.13	22.41	1
Gain (dBi)		1.46	1.46	1.46	1.46		1.46	1.46		
Isotropically Factor (dBc)		2.15	2.15	2.15	2.15		2.15	2.15		
Max ERP Power (dBm)		22.39	22.35	22.76	21.50		21.44	21.72		

Band / BW	RB Size	RB Offset	QPSK			3GPP MPR (dB)	16QAM			3GPP MPR (dB)
			Low CH	Mid CH	High CH		Low CH	Mid CH	High CH	
			23060	23095	23130		23060	23095	23130	
			704	707.5	711		704	707.5	711	
			MHz	MHz	MHz		MHz	MHz	MHz	
12 / 10M	1	0	23.12	23.06	23.47	0	22.19	22.13	22.44	1
Gain (dBi)		1.46	1.46	1.46	1.46		1.46	1.46		
Isotropically Factor (dBc)		2.15	2.15	2.15	2.15		2.15	2.15		
Max ERP Power (dBm)		22.43	22.37	22.78	21.50		21.44	21.75		

4.2 Modulation characteristics Measurement

4.2.1 Limits of Modulation characteristics

N/A

4.2.2 Test Procedure

Connect the EUT to Communication Simulator via the antenna connector. The frequency band is set as EUT supported Modulation and Channels, the EUT output is matched with 50 ohm load, the waveform quality and constellation of the EUT was tested.

4.2.3 Test Setup



4.3 Frequency Stability Measurement

4.3.1 Limits of Frequency Stability Measurement

The frequency stability shall be sufficient to ensure that the fundamental emissions stay within the authorized bands of operation.

According to the FCC part 2.1055 shall be tested the frequency stability. The rule is defined that "The frequency stability shall be sufficient to ensure that the fundamental emission stays within the authorized frequency block." The test extreme voltage is according to the 2.1055(d)(1) Vary primary supply voltage from 85 to 115 percent of the nominal value for other than hand carried battery equipment and the extreme temperature rule is comply with specification of EUT $-30^{\circ}\text{C} \sim 50^{\circ}\text{C}$.

4.3.2 Test Procedure

- Device is placed at the oven room. The oven room could control the temperatures and humidity. Power warm up is at least 15 min and power applied should perform before recording frequency error.
- EUT is connected the external power supply to control the AC input power. The test voltage range is from minimum to maximum working voltage. Each step shall be record the frequency error rate.
- The temperature range step is 10 degrees in this test items. All temperature levels shall be hold the $\pm 0.5^{\circ}\text{C}$ during the measurement testing. The each temperature step shall be at least 0.5 hours, consider the EUT could be test under the stability condition.

NOTE: The frequency error was recorded frequency error from the communication simulator.

4.3.3 Test Setup

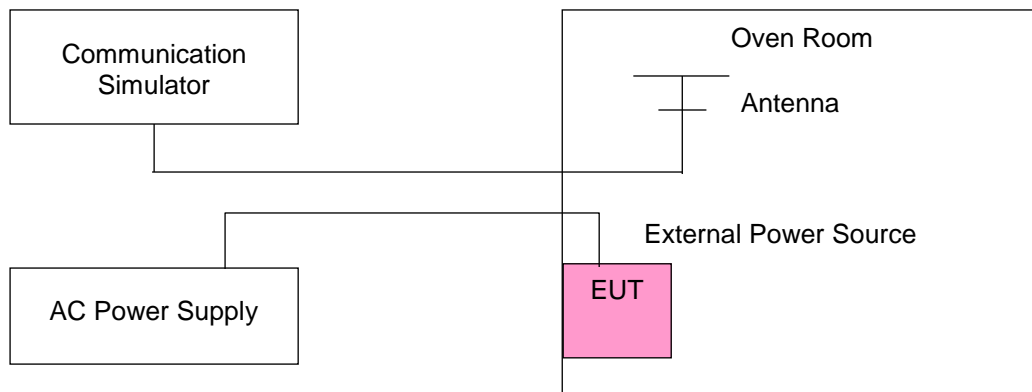

4.3.4 Test Results

LTE Band 4

Voltage (Volts)	Frequency Error (MHz)												Limit (MHz)	
	1.4MHz		3MHz		5MHz		10MHz		15MHz		20MHz			
	Low	High	Low	High	Low	High	Low	High	Low	High	Low	High	Low Edge	High Edge
102	1710.160009	1754.839993	1710.159996	1754.839997	1710.259993	1754.750009	1710.539996	1754.479999	1710.809991	1754.220005	1711.119990	1753.960006	1710	1755
138	1710.159997	1754.839999	1710.160001	1754.840005	1710.260008	1754.750009	1710.540009	1754.480008	1710.809995	1754.219997	1711.119996	1753.959998	1710	1755

Temp. (°C)	Frequency Error (MHz)												Limit (MHz)	
	1.4MHz		3MHz		5MHz		10MHz		15MHz		20MHz			
	Low	High	Low	High	Low	High	Low	High	Low	High	Low	High	Low	High
50	1710.160009	1754.840009	1710.159991	1754.840005	1710.260002	1754.749991	1710.539994	1754.479998	1710.810006	1754.220008	1711.119992	1753.960006	1710	1755
40	1710.160002	1754.839991	1710.160005	1754.840009	1710.260002	1754.749999	1710.539993	1754.480005	1710.810005	1754.220005	1711.119996	1753.959998	1710	1755
30	1710.159992	1754.840003	1710.160002	1754.840001	1710.259997	1754.750009	1710.539996	1754.480000	1710.810005	1754.220008	1711.120006	1753.959995	1710	1755
20	1710.160009	1754.839995	1710.159991	1754.839990	1710.259992	1754.749992	1710.540001	1754.479993	1710.810001	1754.219990	1711.119991	1753.959991	1710	1755
10	1710.160003	1754.839990	1710.160001	1754.839993	1710.260005	1754.750006	1710.540006	1754.479996	1710.809997	1754.219990	1711.120001	1753.959998	1710	1755
0	1710.160009	1754.839990	1710.159994	1754.839998	1710.260006	1754.750009	1710.539995	1754.480006	1710.809999	1754.220001	1711.119995	1753.959998	1710	1755
-10	1710.159992	1754.840000	1710.160006	1754.840009	1710.260009	1754.750004	1710.540004	1754.480002	1710.810008	1754.220002	1711.120009	1753.960004	1710	1755
-20	1710.160008	1754.840008	1710.159993	1754.839990	1710.259997	1754.750000	1710.539997	1754.479996	1710.809991	1754.220002	1711.120008	1753.959992	1710	1755
-30	1710.159991	1754.839996	1710.160001	1754.839998	1710.259991	1754.750007	1710.540003	1754.479994	1710.810000	1754.219995	1711.119990	1753.960001	1710	1755

LTE Band 12

Voltage (Volts)	Frequency Error (MHz)								Limit (MHz)	
	1.4MHz		3MHz		5MHz		10MHz			
	Low	High	Low	High	Low	High	Low	High	Low Edge	High Edge
102	699.159996	715.840005	699.159995	715.839995	699.269996	715.739992	699.539995	715.460003	699	716
138	699.160004	715.839996	699.159992	715.840007	699.269991	715.739993	699.540005	715.460009	699	716

Temp. (°C)	Frequency Error (MHz)								Limit (MHz)	
	1.4MHz		3MHz		5MHz		10MHz			
	Low	High	Low	High	Low	High	Low	High	Low Edge	High Edge
50	699.159990	715.840000	699.160003	715.839990	699.269992	715.739991	699.540009	715.459993	699	716
40	699.159997	715.840004	699.159999	715.840000	699.270005	715.739999	699.540005	715.460004	699	716
30	699.159990	715.840007	699.159997	715.839992	699.270003	715.740000	699.539992	715.460007	699	716
20	699.160006	715.839998	699.160007	715.839997	699.270006	715.740002	699.539997	715.459990	699	716
10	699.160009	715.840005	699.159996	715.839995	699.269993	715.740004	699.539999	715.460009	699	716
0	699.159998	715.839990	699.159998	715.840007	699.270005	715.740002	699.540008	715.460000	699	716
-10	699.159997	715.840002	699.160008	715.839997	699.270003	715.740000	699.540008	715.460008	699	716
-20	699.159995	715.840007	699.159992	715.839999	699.270000	715.740004	699.539993	715.459990	699	716
-30	699.160003	715.839994	699.160005	715.840001	699.270000	715.739996	699.540005	715.459999	699	716

4.4 Emission Bandwidth Measurement

4.4.1 Limits of Emission Bandwidth Measurement

-26dB Bandwidth

According to FCC 27.53 specified that emission bandwidth is defined as the width of the signal between two points, one below the carrier center frequency and one above the carrier center frequency, outside of which all emissions are attenuated at least 26dB below the transmitter power.

Occupied Bandwidth

The EUT makes a call to the communication simulator. All measurements were done at low, middle and high operational frequency range. The communication simulator station system controlled a EUT to export maximum output power under transmission mode and specific channel frequency. Use OBW measurement function of Spectrum analyzer to measure 99 % occupied bandwidth.

4.4.2 Test Procedure

The transmitter output was connected to the spectrum analyzer through an attenuator. The bandwidth of the fundamental frequency was measured by spectrum analyzer with $RBW \geq 1\% \times OBW$ and $VBW \geq 3 \times VBW$.

4.4.3 Test Setup

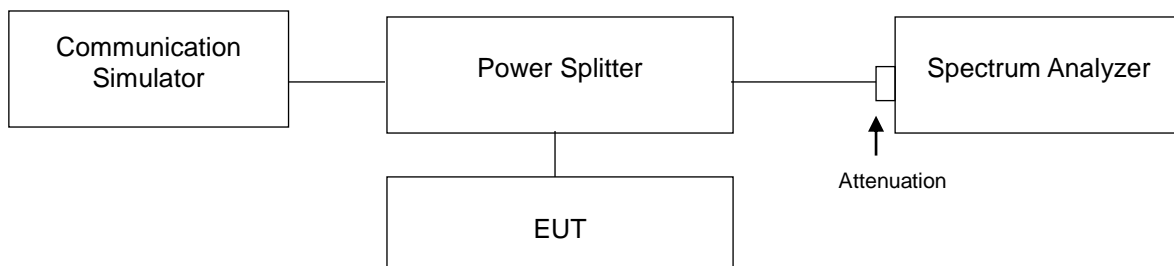

4.4.4 Test Results (-26dB Bandwidth)

LTE Band 4							
Channel Bandwidth 1.4MHz				Channel Bandwidth 3MHz			
Channel	Frequency (MHz)	-26dB Bandwidth (MHz)		Channel	Frequency (MHz)	-26dB Bandwidth (MHz)	
		QPSK	16QAM			QPSK	16QAM
19957	1710.7	1.25	1.23	19965	1711.5	2.97	2.91
20175	1732.5	1.24	1.26	20175	1732.5	2.93	2.92
20393	1754.3	1.25	1.25	20385	1753.5	2.95	2.93
Channel Bandwidth 5MHz				Channel Bandwidth 10MHz			
Channel	Frequency (MHz)	-26dB Bandwidth (MHz)		Channel	Frequency (MHz)	-26dB Bandwidth (MHz)	
		QPSK	16QAM			QPSK	16QAM
19975	1712.5	4.87	4.93	20000	1715	9.70	9.75
20175	1732.5	4.92	4.90	20175	1732.5	9.64	9.70
20375	1752.5	4.94	4.89	20350	1750	9.72	9.72
Channel Bandwidth 15MHz				Channel Bandwidth 20MHz			
Channel	Frequency (MHz)	-26dB Bandwidth (MHz)		Channel	Frequency (MHz)	-26dB Bandwidth (MHz)	
		QPSK	16QAM			QPSK	16QAM
20025	1717.5	14.39	14.50	20050	1720	19.17	19.20
20175	1732.5	14.38	14.33	20175	1732.5	19.05	18.95
20325	1747.5	14.53	14.49	20300	1745	19.15	19.22

Spectrum Plot of Worst Value

1.4MHz / 16QAM

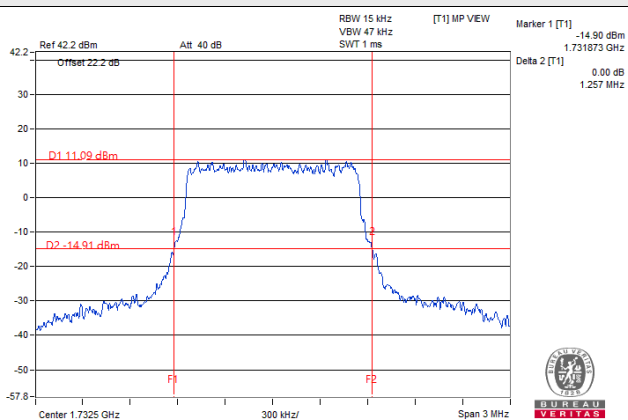

3MHz / QPSK

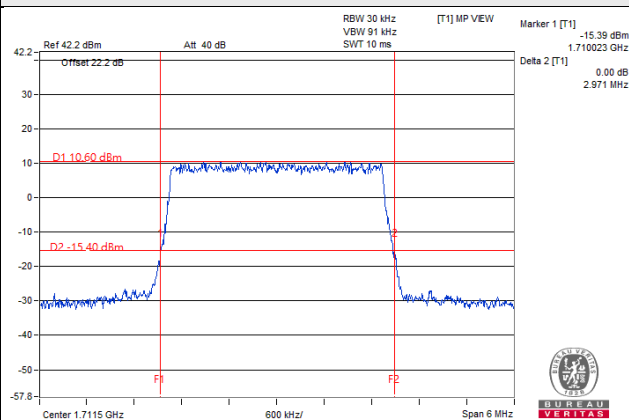

5MHz / QPSK

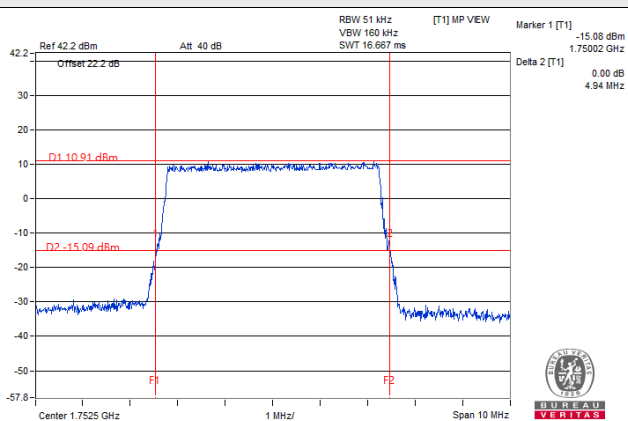

10MHz / 16QAM

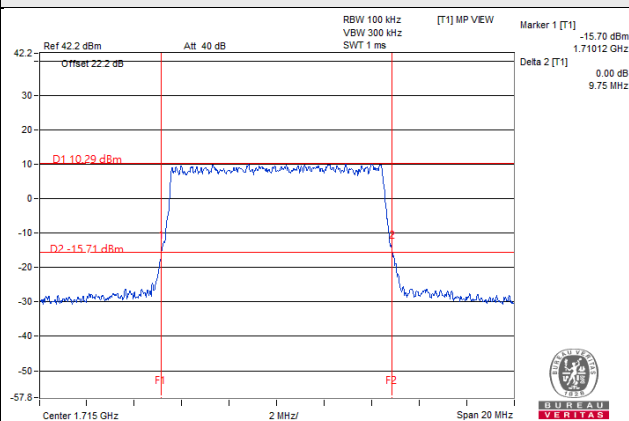

15MHz / QPSK

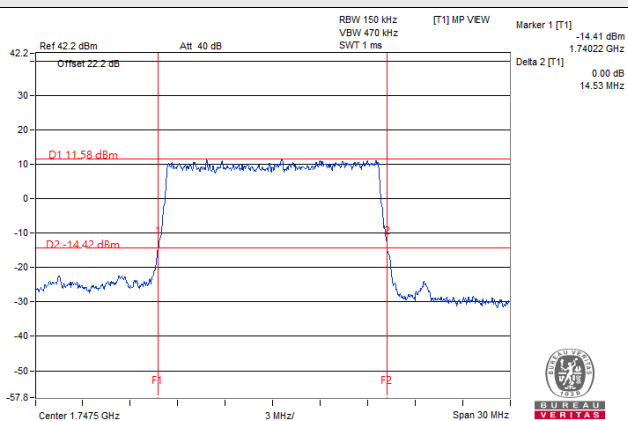

20MHz / 16QAM

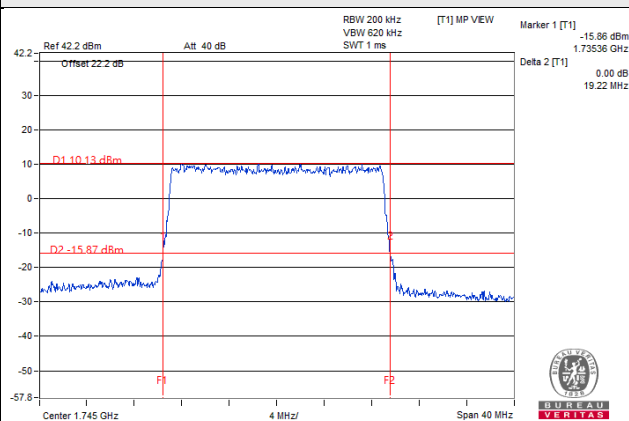

LTE Band 12							
Channel Bandwidth 1.4MHz				Channel Bandwidth 3MHz			
Channel	Frequency (MHz)	-26dB Bandwidth (MHz)		Channel	Frequency (MHz)	-26dB Bandwidth (MHz)	
		QPSK	16QAM			QPSK	16QAM
23017	699.7	1.23	1.24	23025	700.5	2.96	2.92
23095	707.5	1.25	1.24	23095	707.5	2.96	2.93
23173	715.3	1.24	1.24	23165	714.5	2.95	2.92
Channel Bandwidth 5MHz				Channel Bandwidth 10MHz			
Channel	Frequency (MHz)	-26dB Bandwidth (MHz)		Channel	Frequency (MHz)	-26dB Bandwidth (MHz)	
		QPSK	16QAM			QPSK	16QAM
23035	701.5	4.88	4.90	23060	704	9.68	9.62
23095	707.5	4.96	4.92	23095	707.5	9.76	9.81
23155	713.5	4.88	4.87	23130	711	9.67	9.66

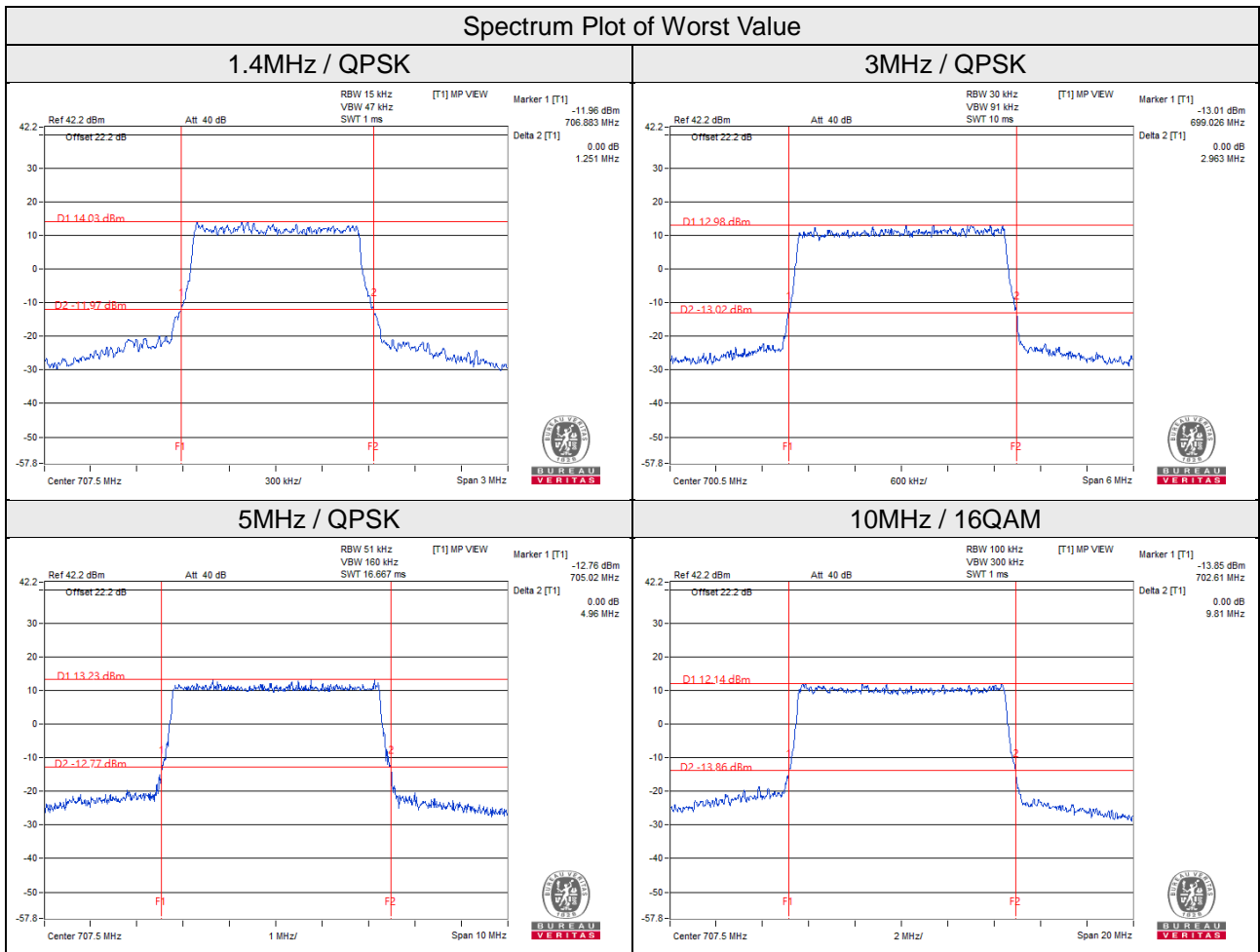

4.4.5 Test Results (Occupied Bandwidth)

LTE Band 4							
Channel Bandwidth 1.4MHz				Channel Bandwidth 3MHz			
Channel	Frequency (MHz)	Occupied Bandwidth (MHz)		Channel	Frequency (MHz)	Occupied Bandwidth (MHz)	
		QPSK	16QAM			QPSK	16QAM
19957	1710.7	1.08	1.08	19965	1711.5	2.68	2.68
20175	1732.5	1.08	1.08	20175	1732.5	2.68	2.68
20393	1754.3	1.08	1.08	20385	1753.5	2.69	2.68
Channel Bandwidth 5MHz				Channel Bandwidth 10MHz			
Channel	Frequency (MHz)	Occupied Bandwidth (MHz)		Channel	Frequency (MHz)	Occupied Bandwidth (MHz)	
		QPSK	16QAM			QPSK	16QAM
19975	1712.5	4.47	4.46	20000	1715	8.94	8.94
20175	1732.5	4.47	4.48	20175	1732.5	8.94	8.94
20375	1752.5	4.48	4.48	20350	1750	8.94	8.94
Channel Bandwidth 15MHz				Channel Bandwidth 20MHz			
Channel	Frequency (MHz)	Occupied Bandwidth (MHz)		Channel	Frequency (MHz)	Occupied Bandwidth (MHz)	
		QPSK	16QAM			QPSK	16QAM
20025	1717.5	13.41	13.44	20050	1720	17.84	17.84
20175	1732.5	13.38	13.41	20175	1732.5	17.88	17.76
20325	1747.5	13.44	13.44	20300	1745	17.92	17.84

Spectrum Plot of Worst Value

1.4MHz / QPSK

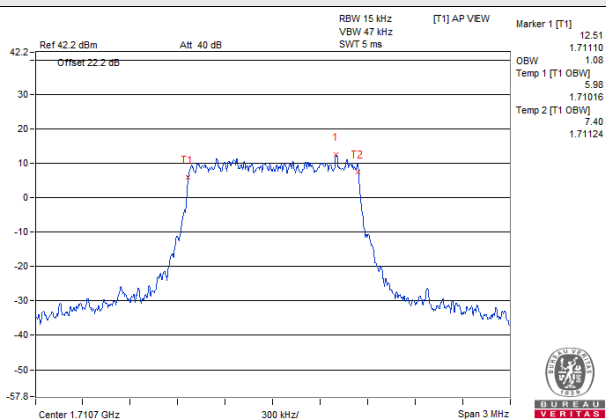

3MHz / QPSK

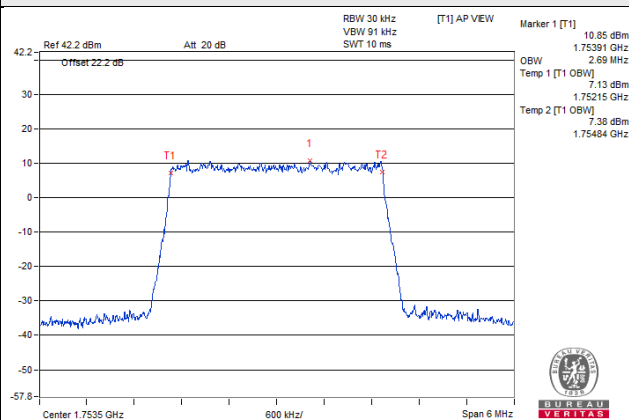

5MHz / QPSK

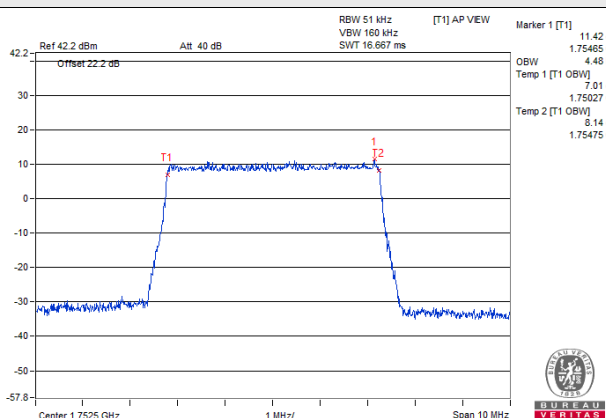

10MHz / QPSK

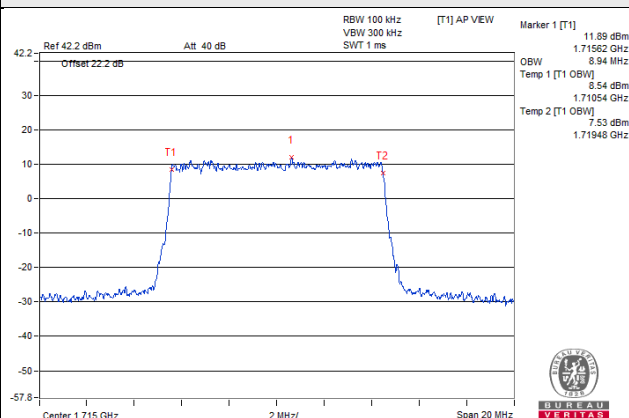

15MHz / QPSK

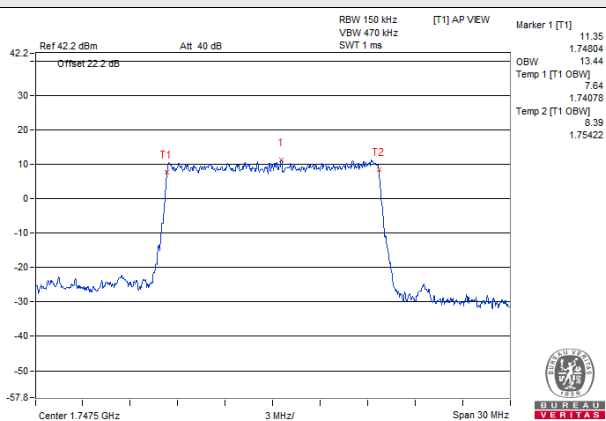

20MHz / QPSK

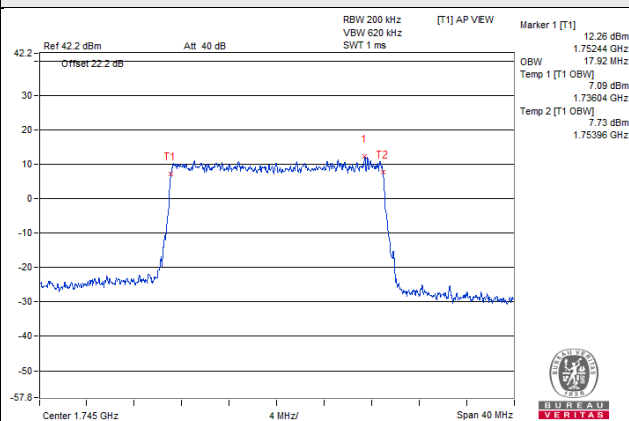

LTE Band 12							
Channel Bandwidth 1.4MHz				Channel Bandwidth 3MHz			
Channel	Frequency (MHz)	Occupied Bandwidth (MHz)		Channel	Frequency (MHz)	Occupied Bandwidth (MHz)	
		QPSK	16QAM			QPSK	16QAM
23017	699.7	1.08	1.08	23025	700.5	2.68	2.68
23095	707.5	1.08	1.08	23095	707.5	2.69	2.68
23173	715.3	1.08	1.08	23165	714.5	2.69	2.68
Channel Bandwidth 5MHz				Channel Bandwidth 10MHz			
Channel	Frequency (MHz)	Occupied Bandwidth (MHz)		Channel	Frequency (MHz)	Occupied Bandwidth (MHz)	
		QPSK	16QAM			QPSK	16QAM
23035	701.5	4.48	4.48	23060	704	8.92	8.92
23095	707.5	4.48	4.47	23095	707.5	8.96	8.96
23155	713.5	4.48	4.47	23130	711	8.92	8.94

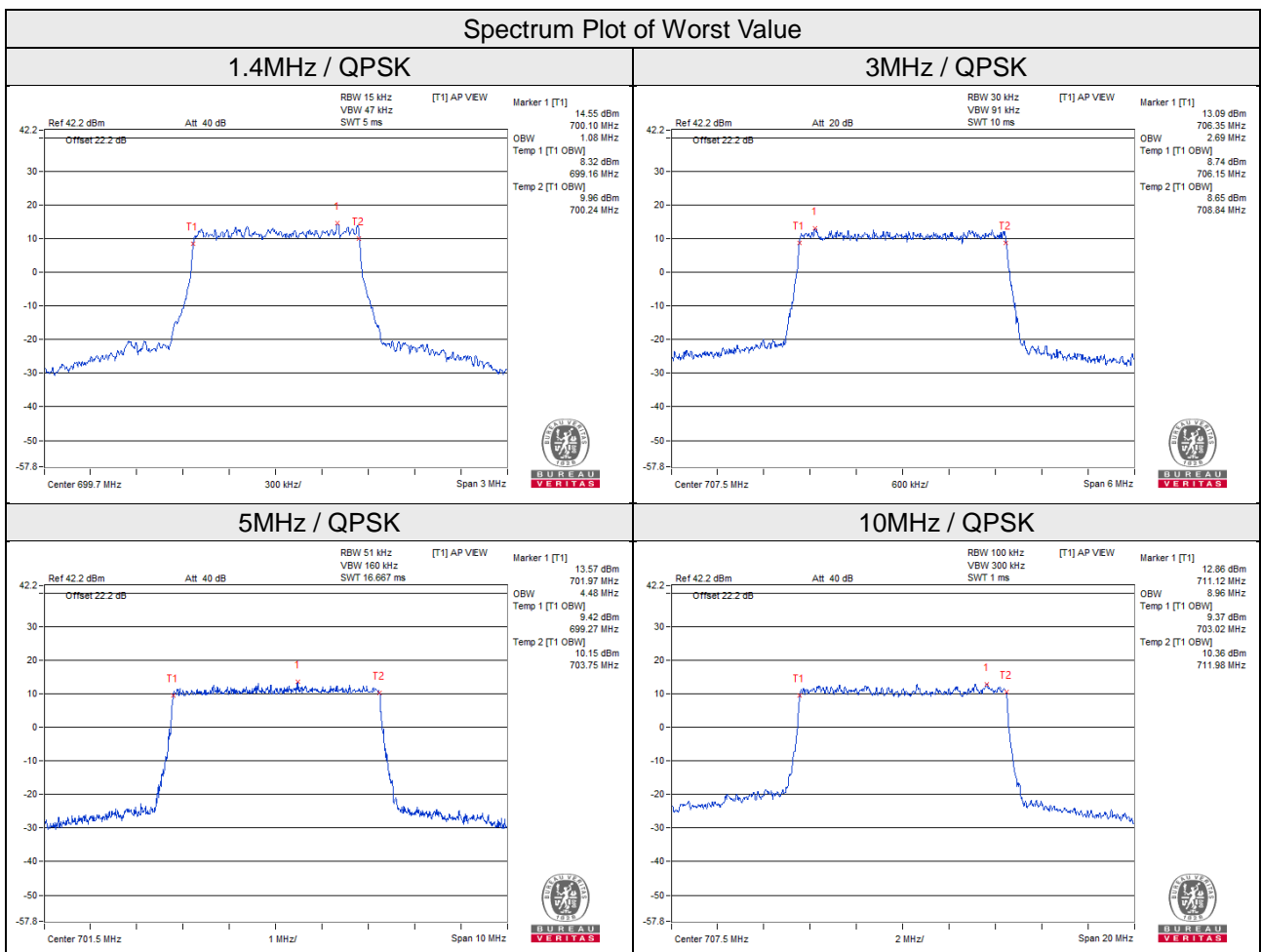

4.5 Channel Edge Measurement

4.5.1 Limits of Channel Edge Measurement

For Subpart L : LTE Band 4

According to FCC 27.53(h) AWS emission limits— General protection levels. Except as otherwise specified below, for operations in the 1695-1710 MHz, 1710-1755 MHz, 1755-1780 MHz, 1915-1920 MHz, 1995-2000 MHz, 2000-2020 MHz, 2110-2155 MHz, 2155-2180 MHz, and 2180-2200 bands, the power of any emission outside a licensee's frequency block shall be attenuated below the transmitter power (P) in watts by at least $43 + 10 \log_{10}(P)$ dB.

For Subpart H : LTE Band 12

According to FCC 27.53(g) For operations in the 600 MHz band and the 698-746 MHz band, the power of any emission outside a licensee's frequency band(s) of operation shall be attenuated below the transmitter power (P) within the licensed band(s) of operation, measured in watts, by at least $43 + 10 \log(P)$ dB. Compliance with this provision is based on the use of measurement instrumentation employing a resolution bandwidth of 100 kilohertz or greater. However, in the 100 kilohertz bands immediately outside and adjacent to a licensee's frequency block, a resolution bandwidth of at least 30 kHz may be employed.

4.5.2 Test Setup

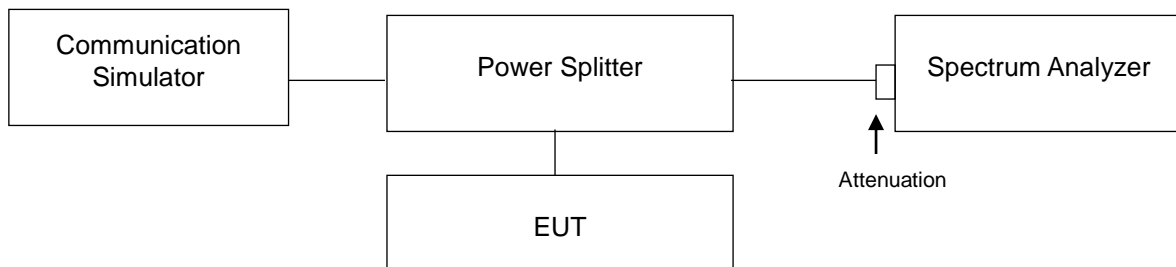

4.5.3 Test Procedures

- a. All measurements were done at low and high operational frequency range.
- b. The center frequency of spectrum is the band edge frequency and s RB of the spectrum is >1% emission bandwidth and VB of the spectrum is $\geq 3*RB$.
- c. Record the max trace plot into the test report.

4.5.4 Test Results

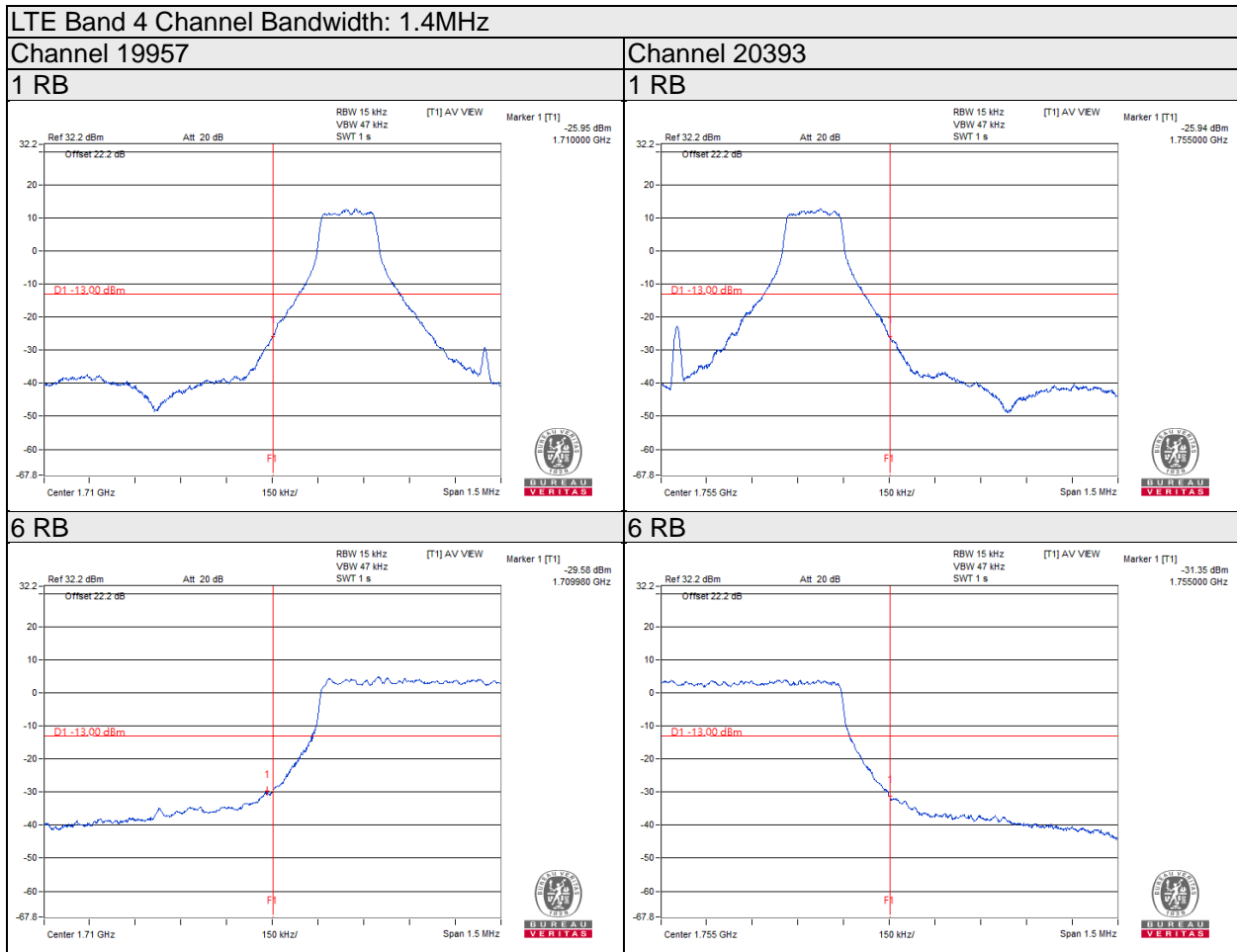

LTE Band 4 Channel Bandwidth: 3MHz

Channel 19965

1 RB

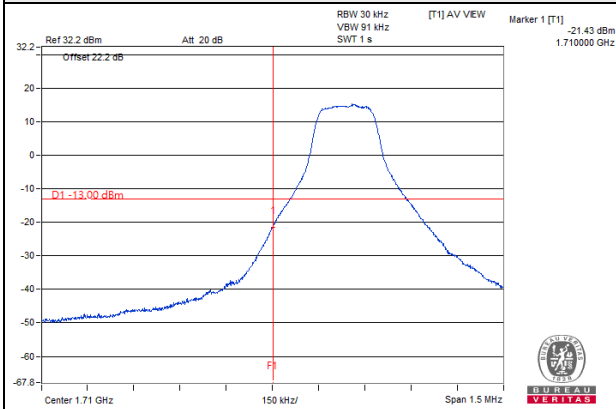

Channel 20385

1 RB

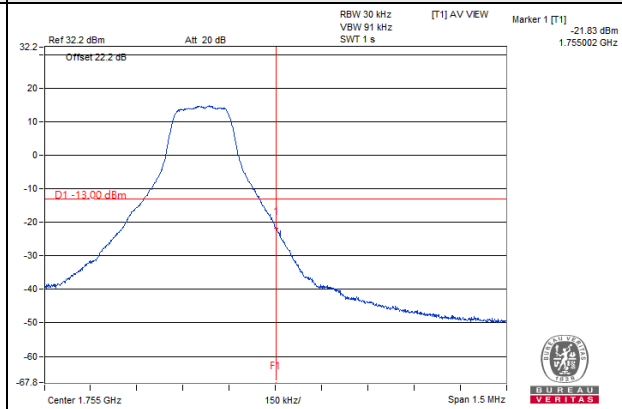

15 RB

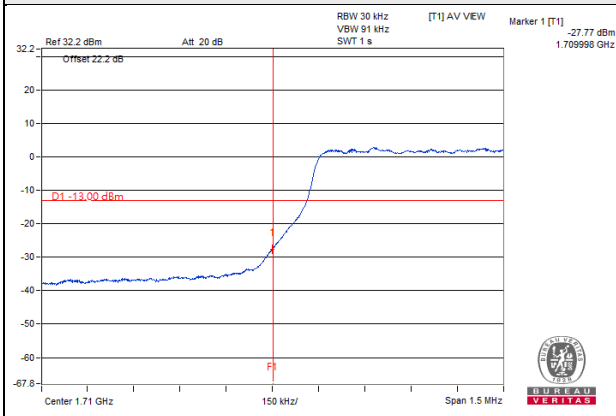

15 RB

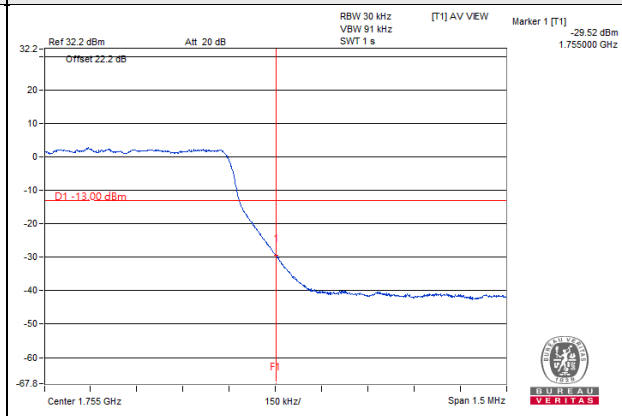

LTE Band 4 Channel Bandwidth: 5MHz

Channel 19975

1 RB

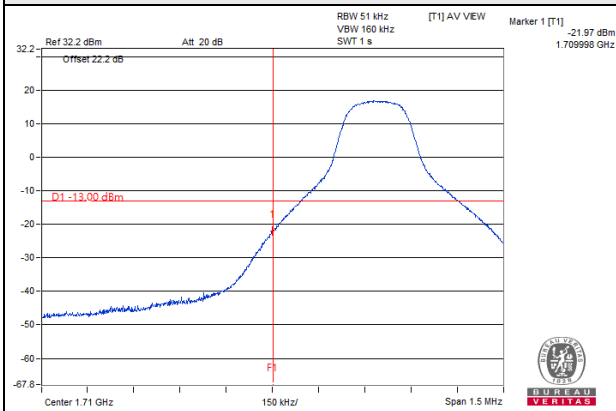

Channel 20375

1 RB

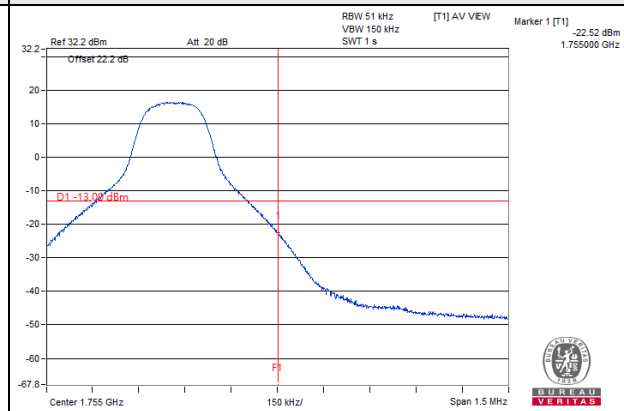

25 RB

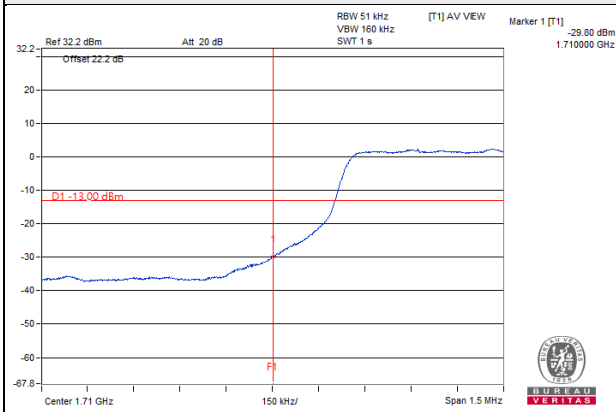

25 RB

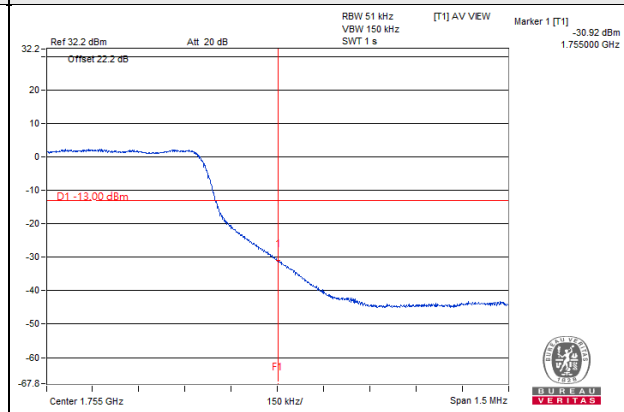

LTE Band 4 Channel Bandwidth: 10MHz

Channel 20000

1 RB

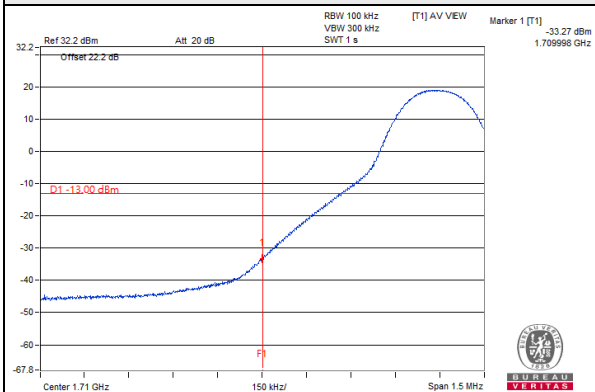

Channel 20350

1 RB

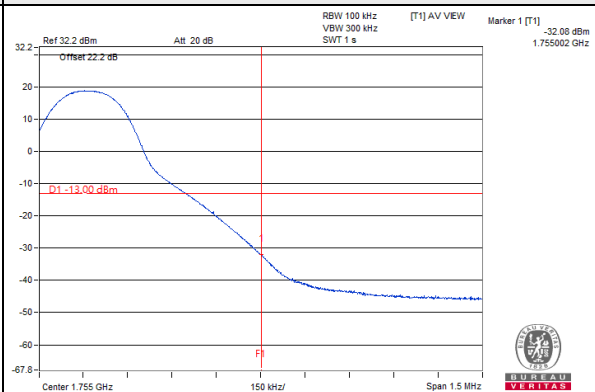

50 RB

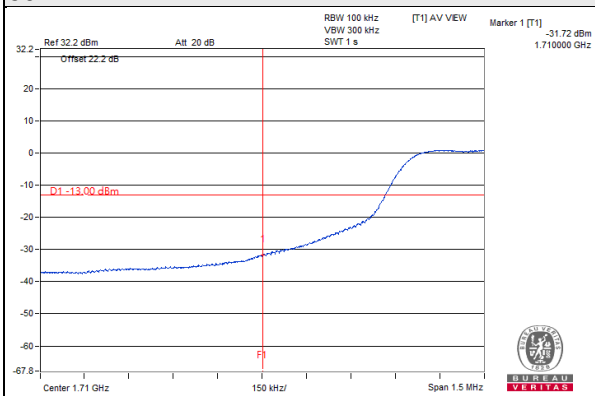

50 RB

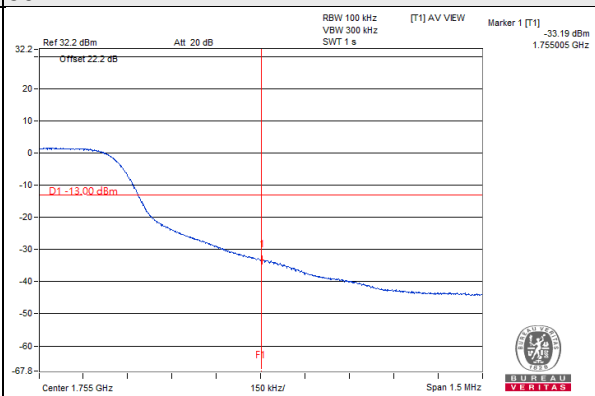

LTE Band 4 Channel Bandwidth: 15MHz

Channel 20025

1 RB

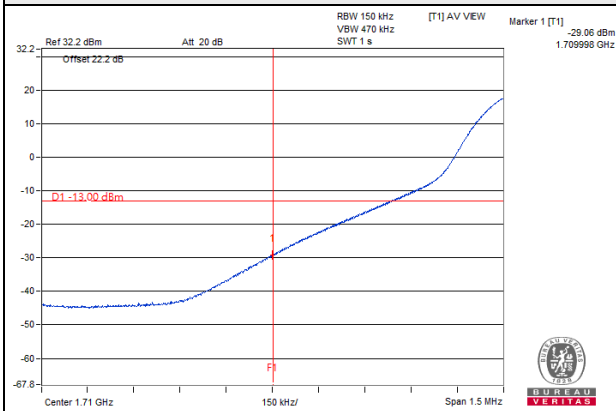

Channel 20325

1 RB

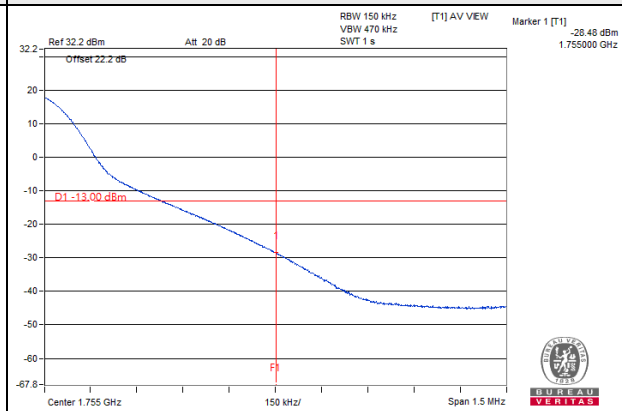

75 RB

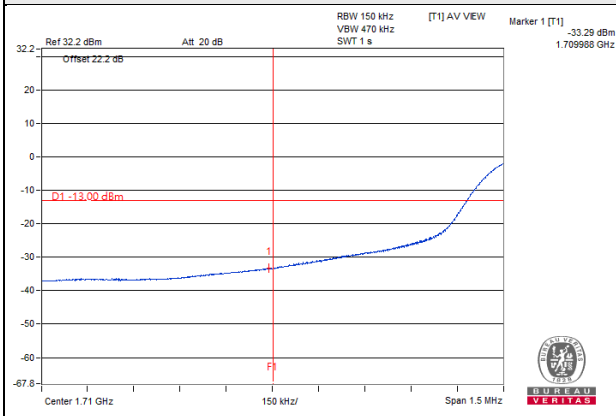

75 RB

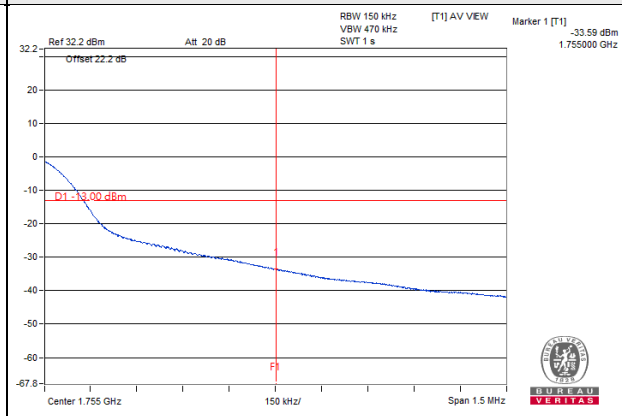

LTE Band 4 Channel Bandwidth: 20MHz

Channel 20050

1 RB

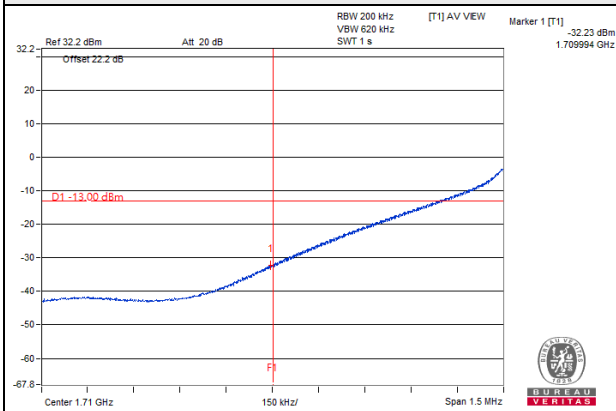

Channel 20300

1 RB

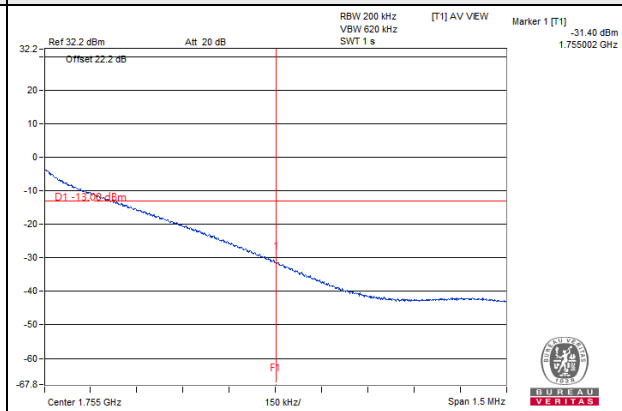

100 RB

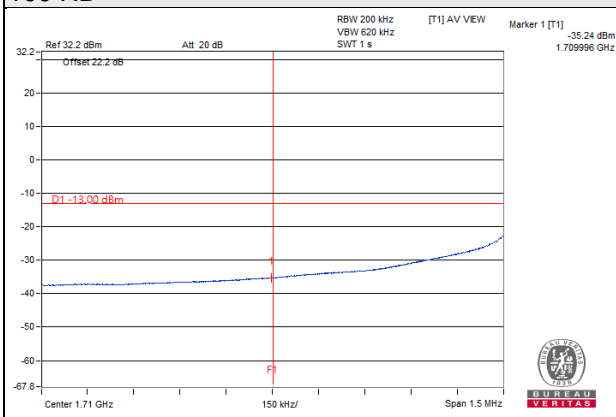

100 RB

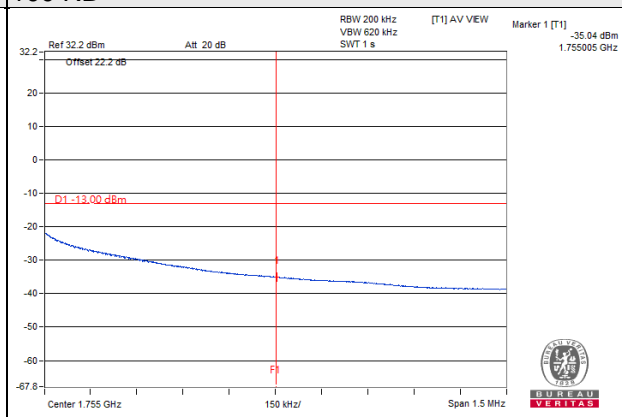

LTE Band 12 Channel Bandwidth: 1.4MHz

Channel 23017

1 RB

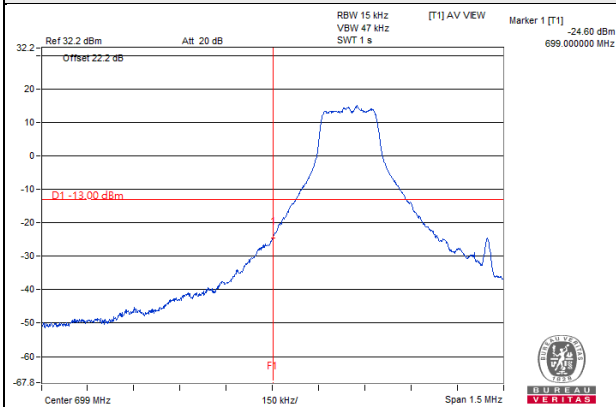

Channel 23173

1 RB

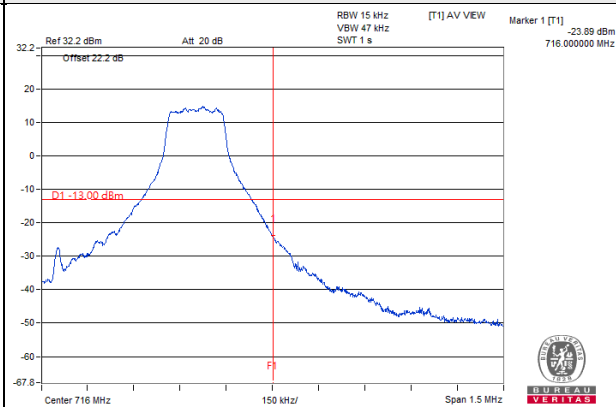

6 RB

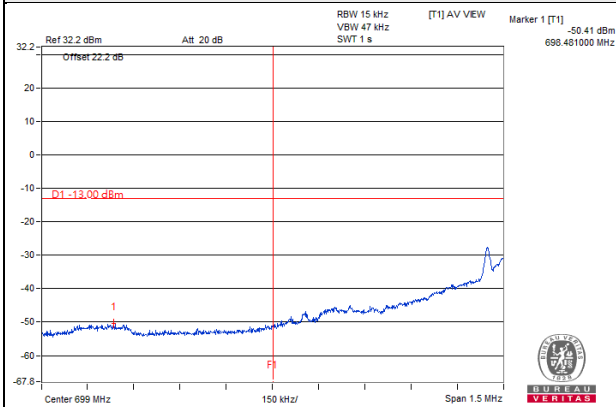

6 RB

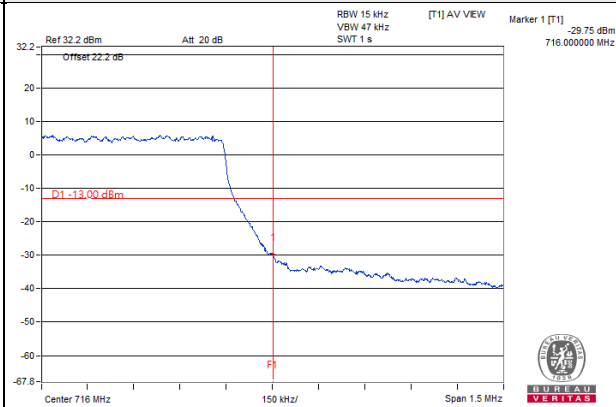

LTE Band 12 Channel Bandwidth: 3MHz

Channel 23025

1 RB

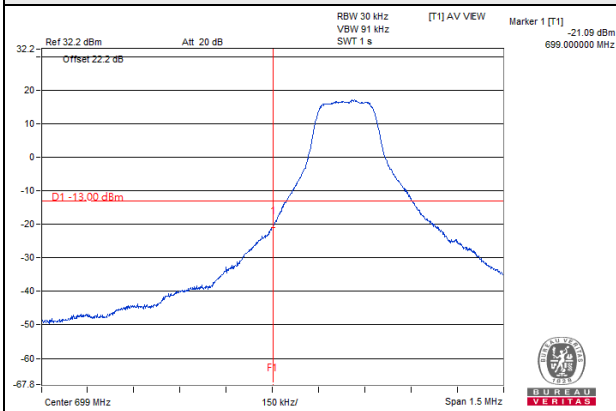

Channel 23165

1 RB

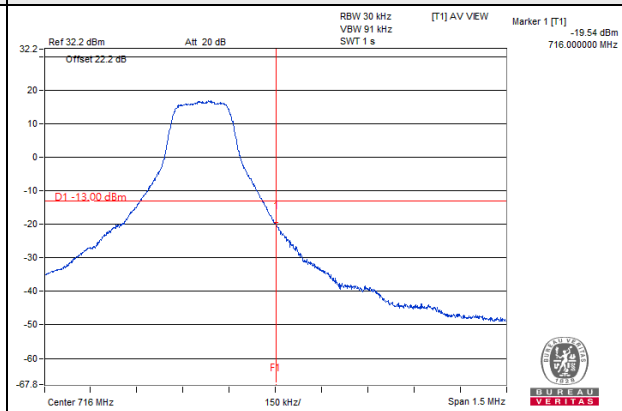

15 RB

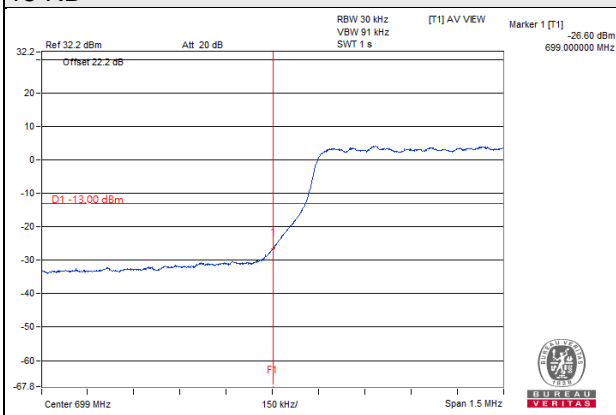

15 RB

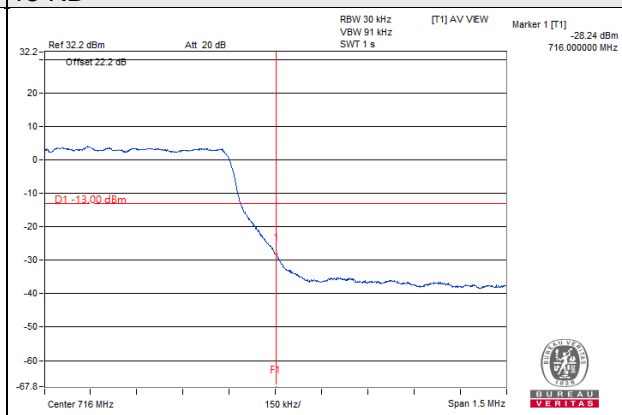

LTE Band 12 Channel Bandwidth: 5MHz

Channel 23035

1 RB

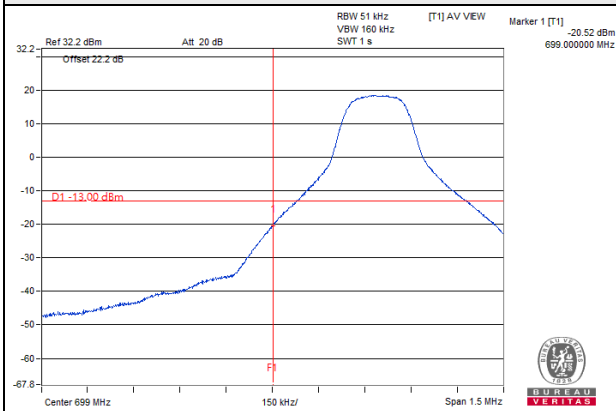

Channel 23155

1 RB

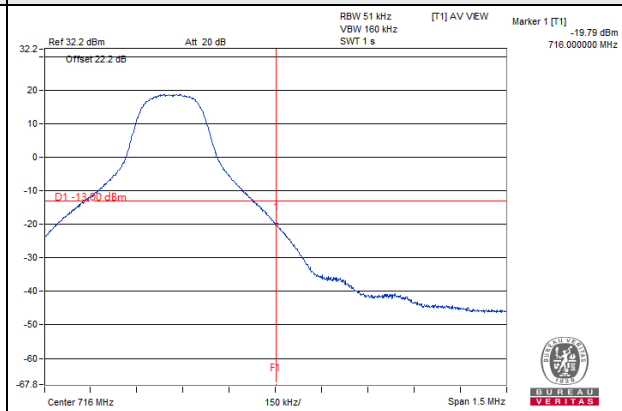

25 RB

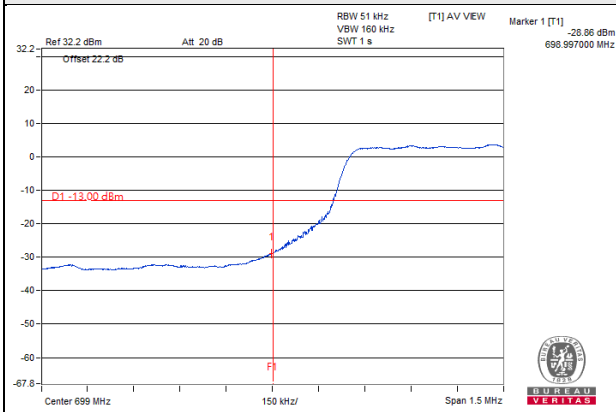

25 RB

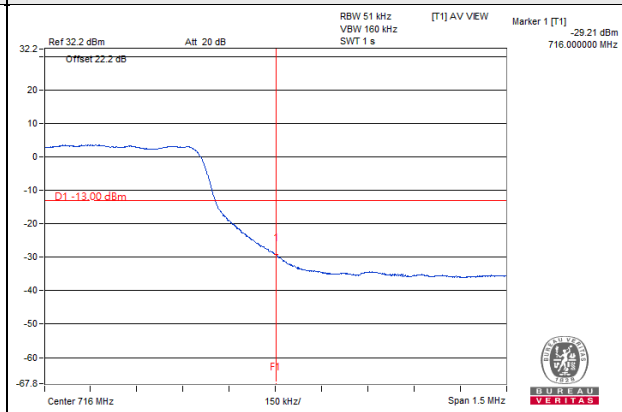

LTE Band 12 Channel Bandwidth: 10MHz

Channel 23060

1 RB

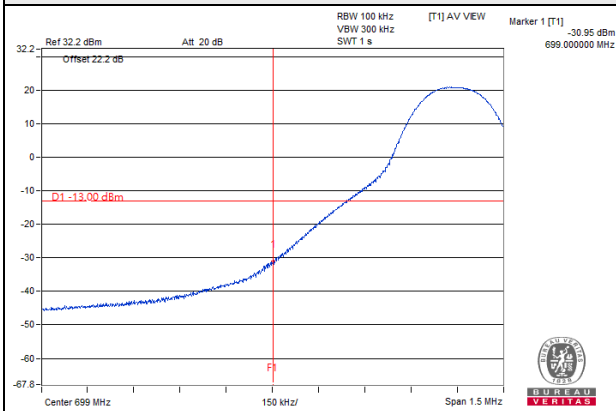

Channel 23130

1 RB

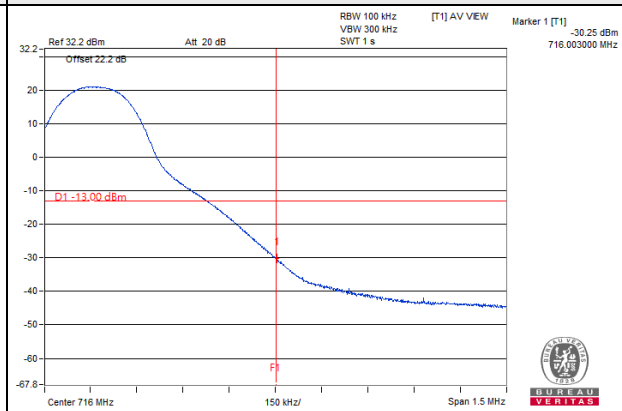

50 RB

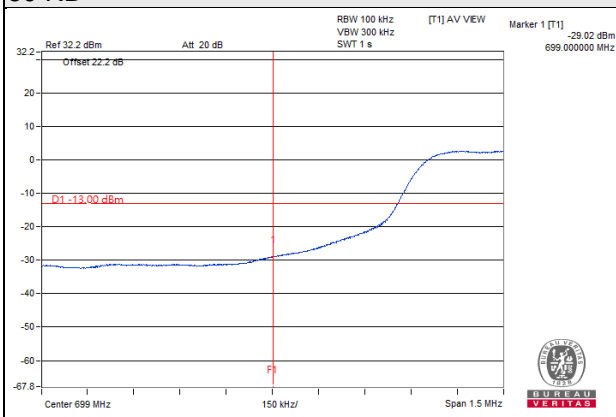

50 RB

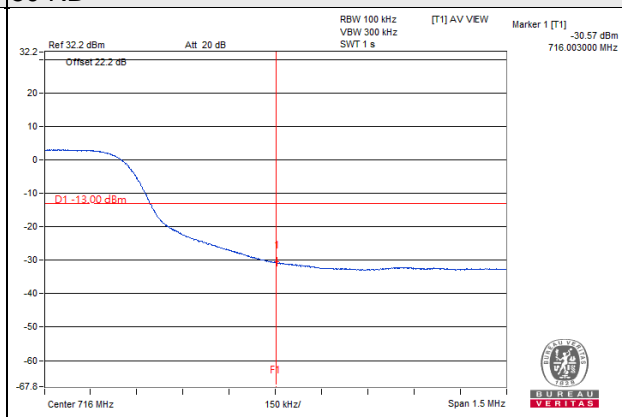

4.6 Peak to Average Ratio

4.6.1 Limits of Peak to Average Ratio Measurement

In measuring transmissions in this band using an average power technique, the peak to-average ratio (PAR) of the transmission may not exceed 13 dB

4.6.2 Test Setup

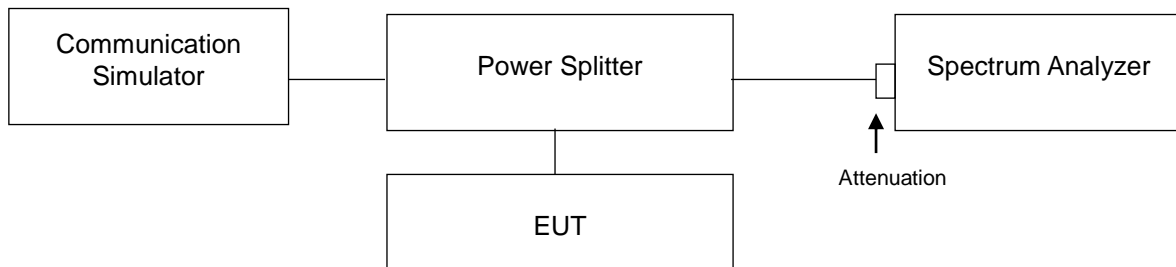

4.6.3 Test Procedures

1. Set resolution/measurement bandwidth \geq signal's occupied bandwidth;
2. Set the number of counts to a value that stabilizes the measured CCDF curve;
3. Record the maximum PAPR level associated with a probability of 0.1%.

4.6.4 Test Results

LTE Band 4							
Channel Bandwidth 1.4MHz				Channel Bandwidth 3MHz			
Channel	Frequency (MHz)	Peak To Average Ratio (dB)		Channel	Frequency (MHz)	Peak To Average Ratio (dB)	
		QPSK	16QAM			QPSK	16QAM
19957	1710.7	4.97	5.77	19965	1711.5	5.01	5.84
20175	1732.5	4.91	5.66	20175	1732.5	4.90	5.77
20393	1754.3	4.99	5.86	20385	1753.5	5.07	5.95
Channel Bandwidth 5MHz				Channel Bandwidth 10MHz			
Channel	Frequency (MHz)	Peak To Average Ratio (dB)		Channel	Frequency (MHz)	Peak To Average Ratio (dB)	
		QPSK	16QAM			QPSK	16QAM
19975	1712.5	5.20	6.01	20000	1715	5.10	5.92
20175	1732.5	4.93	5.75	20175	1732.5	4.91	5.73
20375	1752.5	5.15	6.00	20350	1750	5.12	5.95
Channel Bandwidth 15MHz				Channel Bandwidth 20MHz			
Channel	Frequency (MHz)	Peak To Average Ratio (dB)		Channel	Frequency (MHz)	Peak To Average Ratio (dB)	
		QPSK	16QAM			QPSK	16QAM
20025	1717.5	5.38	6.02	20050	1720	5.12	5.90
20175	1732.5	5.10	5.77	20175	1732.5	4.88	5.68
20325	1747.5	5.35	6.00	20300	1745	5.17	5.89

Spectrum Plot of Worst Value

1.4MHz / 16QAM

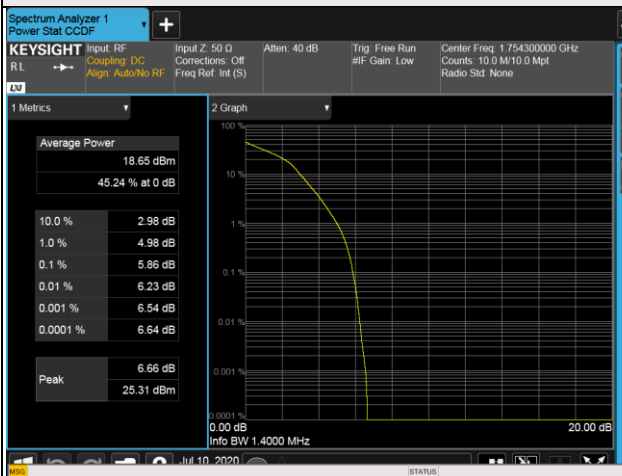

3MHz / 16QAM

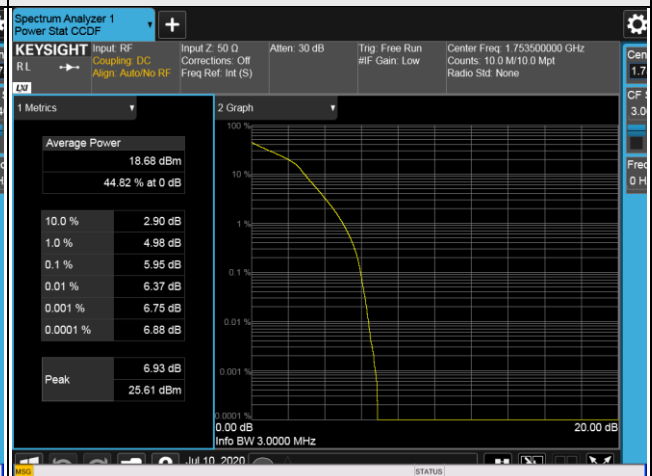

5MHz / 16QAM

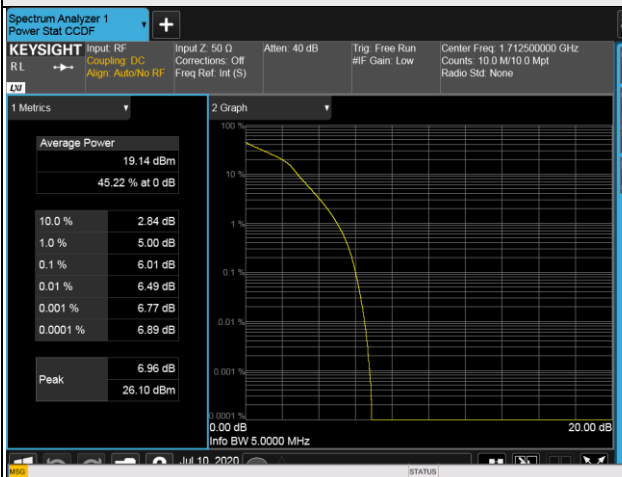

10MHz / 16QAM



15MHz / 16QAM

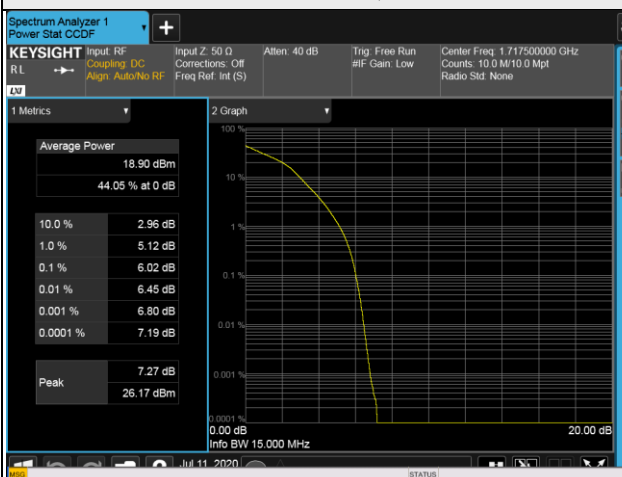

20MHz / 16QAM

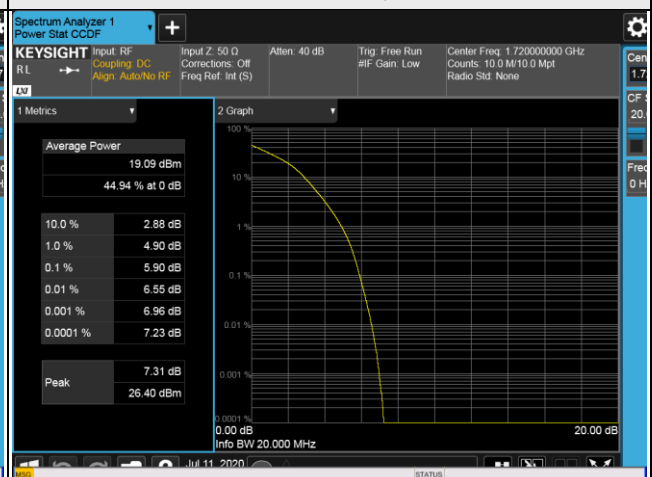

LTE Band 12							
Channel Bandwidth 1.4MHz				Channel Bandwidth 3MHz			
Channel	Frequency (MHz)	Peak To Average Ratio (dB)		Channel	Frequency (MHz)	Peak To Average Ratio (dB)	
		QPSK	16QAM			QPSK	16QAM
23017	699.7	5.70	6.49	23025	700.5	5.55	6.43
23095	707.5	5.68	6.49	23095	707.5	5.64	6.50
23173	715.3	5.42	6.21	23165	714.5	5.39	6.24
Channel Bandwidth 5MHz				Channel Bandwidth 10MHz			
Channel	Frequency (MHz)	Peak To Average Ratio (dB)		Channel	Frequency (MHz)	Peak To Average Ratio (dB)	
		QPSK	16QAM			QPSK	16QAM
23035	701.5	5.53	6.38	23060	704	5.55	6.40
23095	707.5	5.73	6.57	23095	707.5	5.74	6.55
23155	713.5	5.45	6.30	23130	711	5.51	6.39

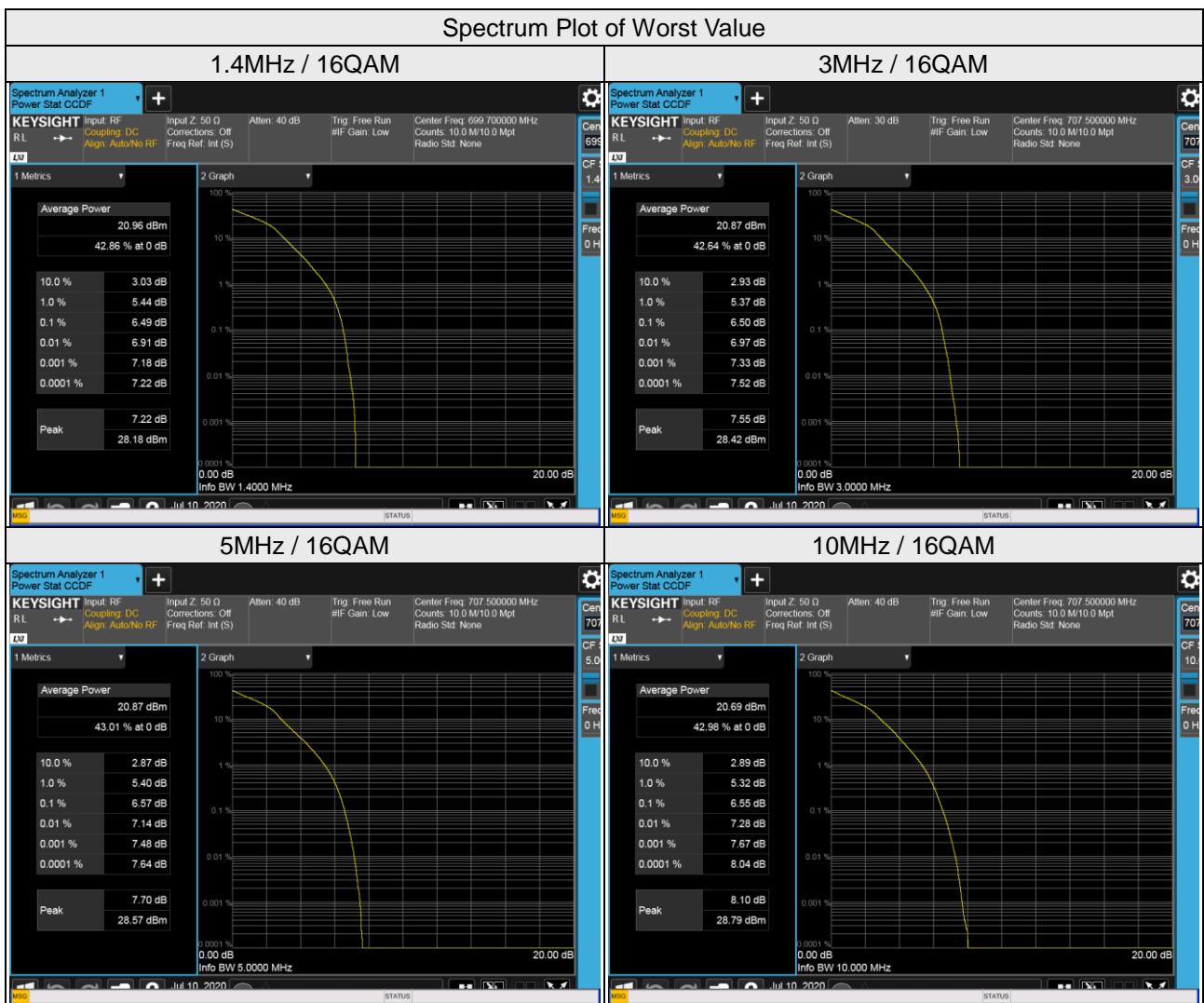

4.7 Conducted Spurious Emissions

4.7.1 Limits of Conducted Spurious Emissions Measurement

According to FCC 27.53(g) For operations in the 600 MHz band and the 698-746 MHz band, the power of any emission outside a licensee's frequency band(s) of operation shall be attenuated below the transmitter power (P) within the licensed band(s) of operation, measured in watts, by at least $43 + 10 \log (P)$ dB. Compliance with this provision is based on the use of measurement instrumentation employing a resolution bandwidth of 100 kilohertz or greater. However, in the 100 kilohertz bands immediately outside and adjacent to a licensee's frequency block, a resolution bandwidth of at least 30 kHz may be employed.

According to FCC 27.53(h) AWS emission limits— General protection levels. Except as otherwise specified below, for operations in the 1695-1710 MHz, 1710-1755 MHz, 1755-1780 MHz, 1915-1920 MHz, 1995-2000 MHz, 2000-2020 MHz, 2110-2155 MHz, 2155-2180 MHz, and 2180-2200 bands, the power of any emission outside a licensee's frequency block shall be attenuated below the transmitter power (P) in watts by at least $43 + 10 \log_{10} (P)$ dB.

4.7.2 Test Setup

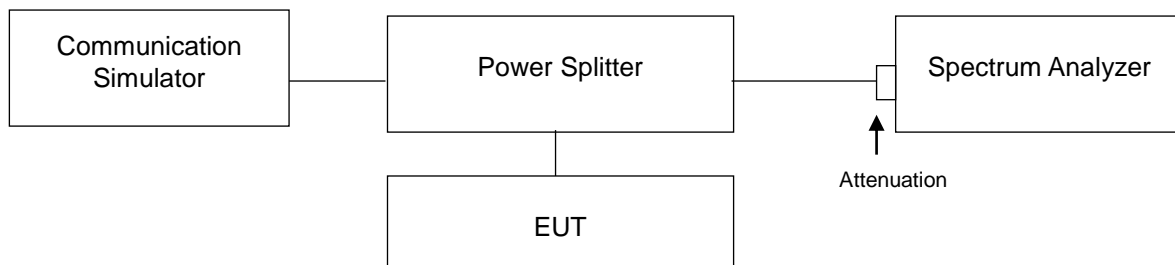

4.7.3 Test Procedure

- a. All measurements were done at 3 channels: low, middle and high operational frequency range.
- b. When the spectrum scanned from 9 kHz to the tenth harmonic of the highest fundamental frequency, it shall be connected to the 20dB pad attenuated the carried frequency.

4.7.4 Test Results

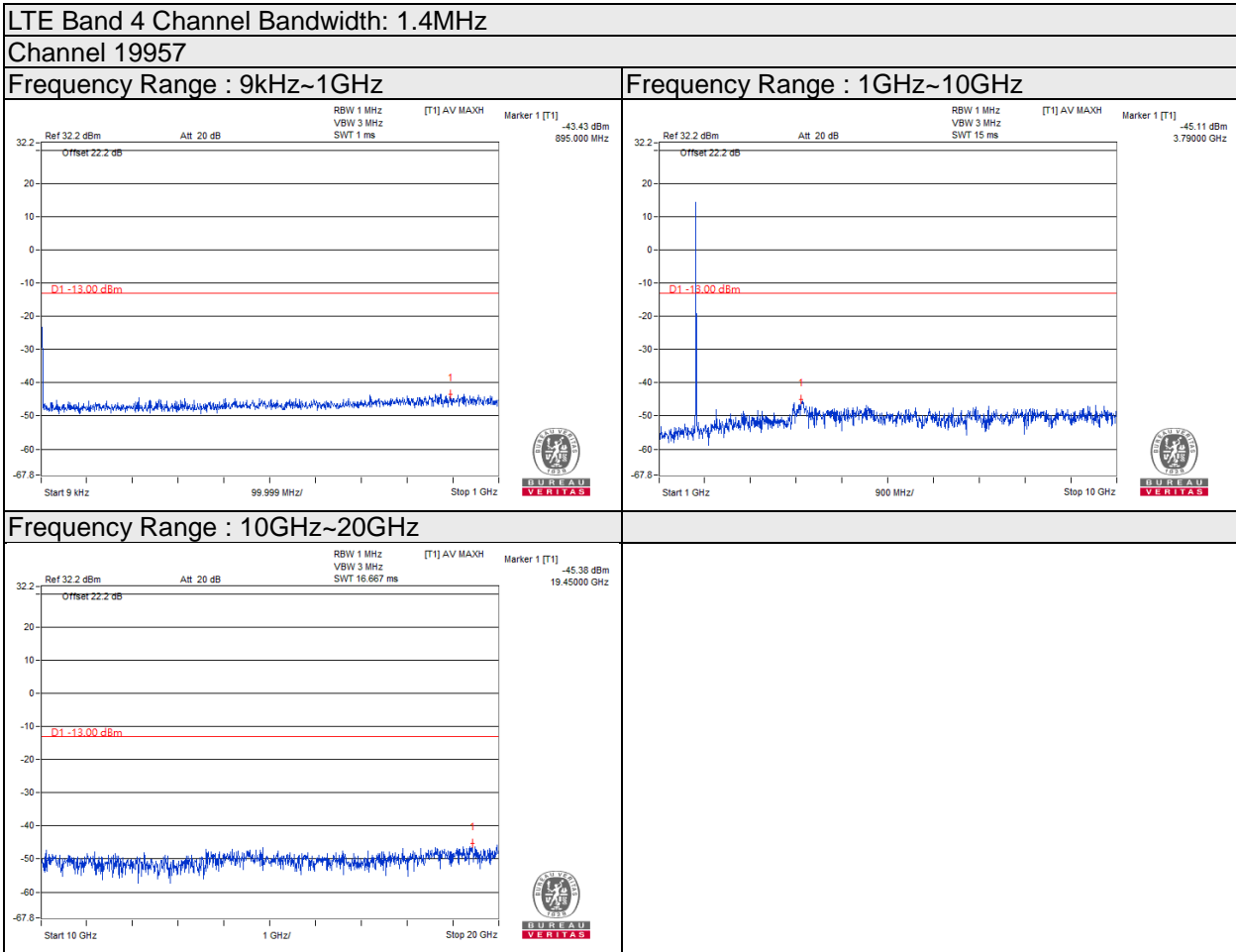

Note: The signal of 9kHz is IF signal from test instrument.

LTE Band 4 Channel Bandwidth: 1.4MHz

Channel 20175

Frequency Range : 9kHz~1GHz

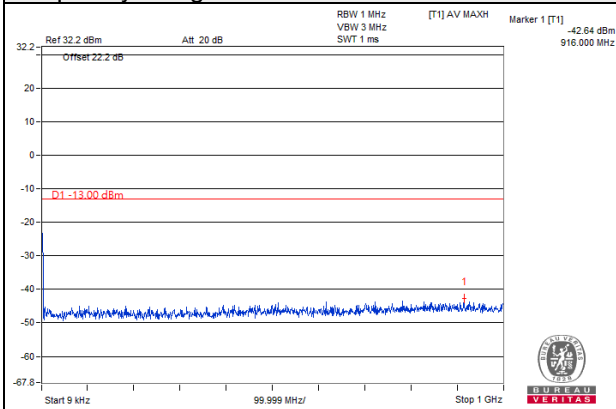

Frequency Range : 1GHz~10GHz

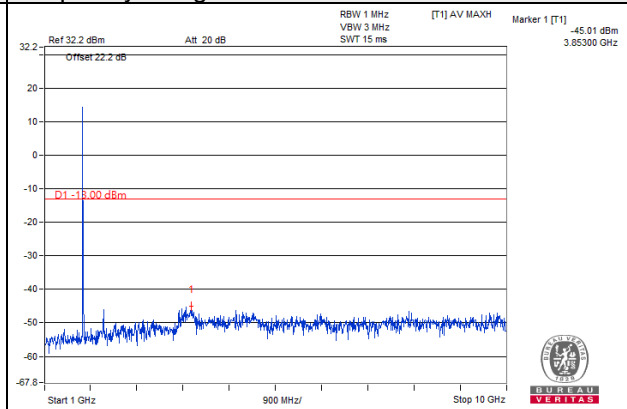

Frequency Range : 10GHz~20GHz

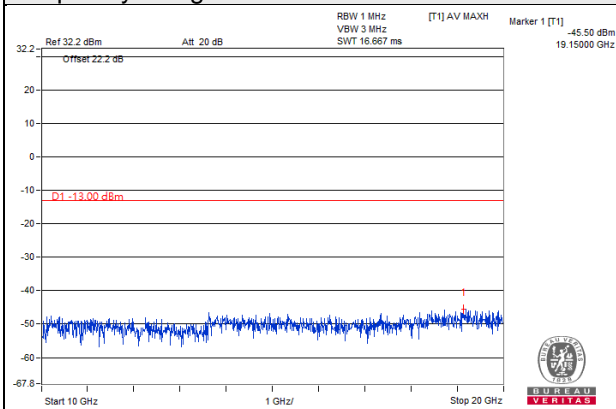

Note: The signal of 9kHz is IF signal from test instrument.

LTE Band 4 Channel Bandwidth: 1.4MHz

Channel 20393

Frequency Range : 9kHz~1GHz

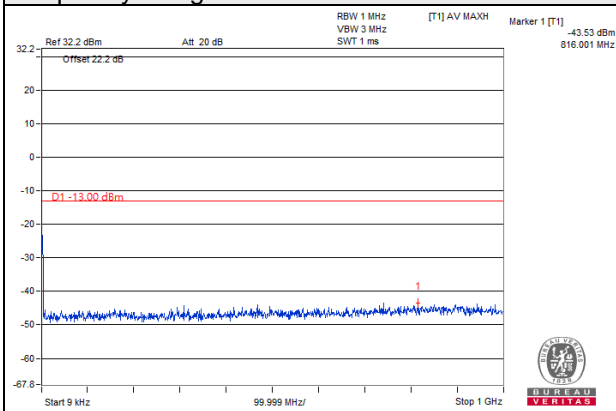

Frequency Range : 1GHz~10GHz

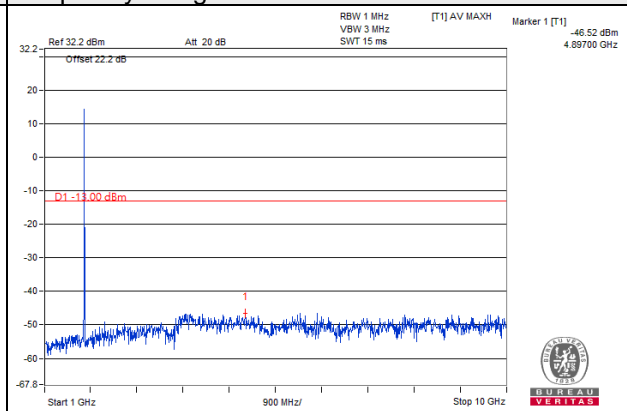

Frequency Range : 10GHz~20GHz

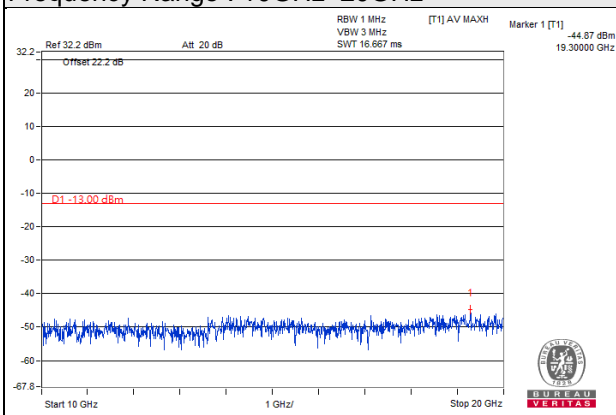

Note: The signal of 9kHz is IF signal from test instrument.

LTE Band 4 Channel Bandwidth: 3MHz

Channel 19965

Frequency Range : 9kHz~1GHz

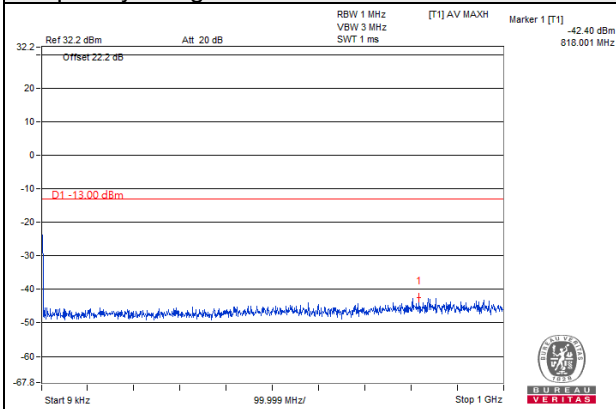

Frequency Range : 1GHz~10GHz

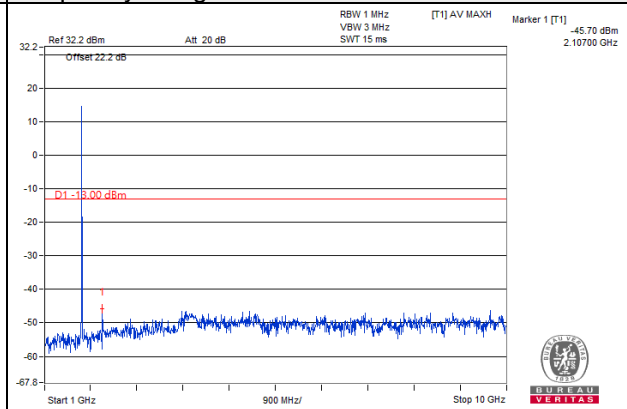

Frequency Range : 10GHz~20GHz

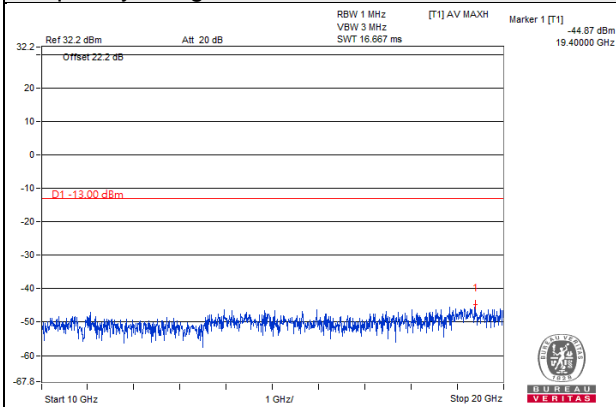

Note: The signal of 9kHz is IF signal from test instrument.

LTE Band 4 Channel Bandwidth: 3MHz

Channel 20175

Frequency Range : 9kHz~1GHz

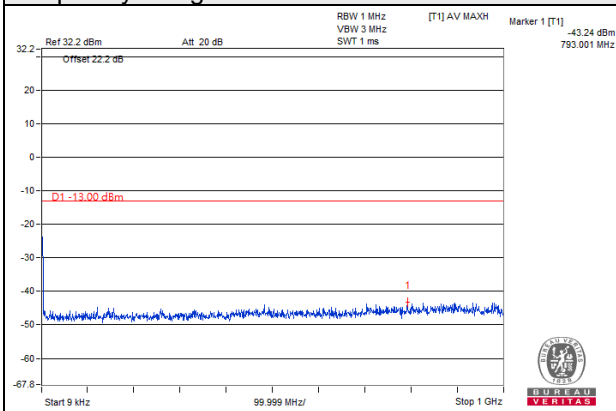

Frequency Range : 1GHz~10GHz

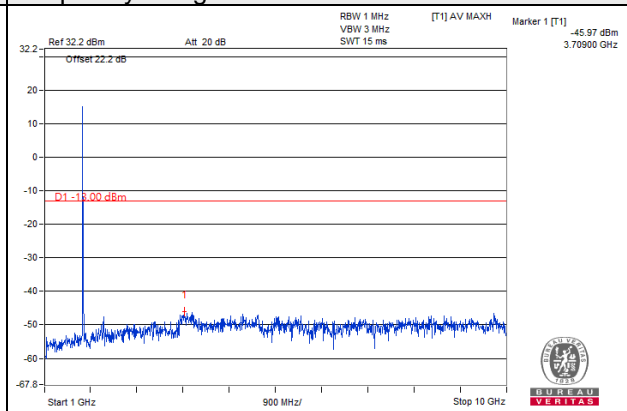

Frequency Range : 10GHz~20GHz

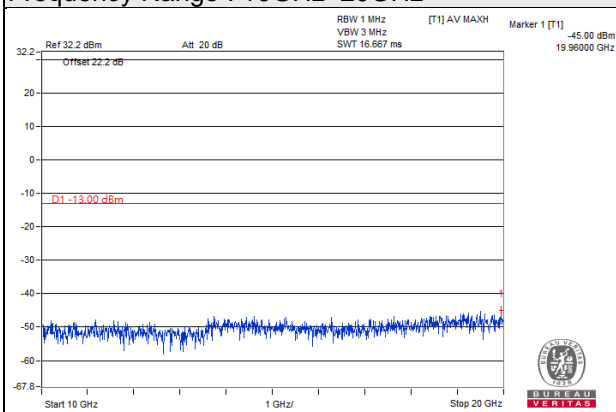

Note: The signal of 9kHz is IF signal from test instrument.

LTE Band 4 Channel Bandwidth: 3MHz

Channel 20385

Frequency Range : 9kHz~1GHz

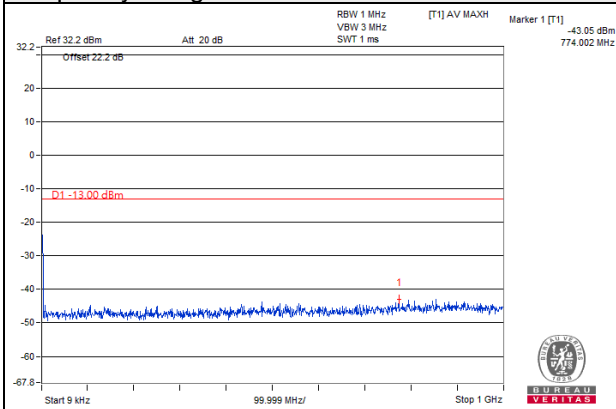

Frequency Range : 1GHz~10GHz

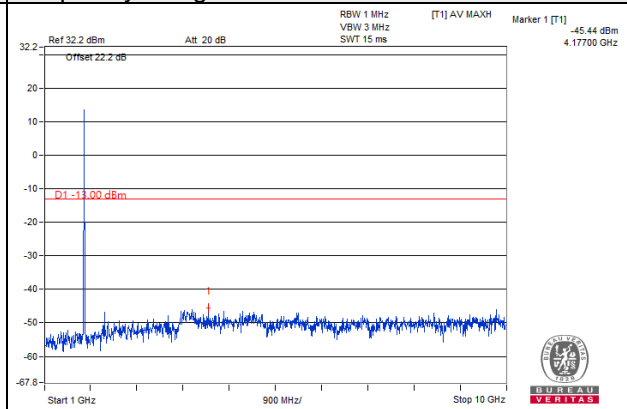

Frequency Range : 10GHz~20GHz

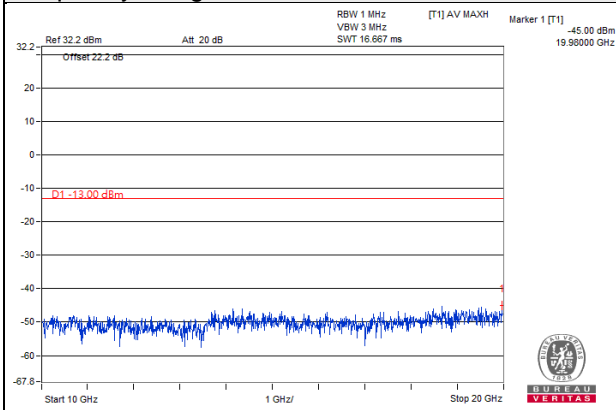

Note: The signal of 9kHz is IF signal from test instrument.

LTE Band 4 Channel Bandwidth: 5MHz

Channel 19975

Frequency Range : 9kHz~1GHz

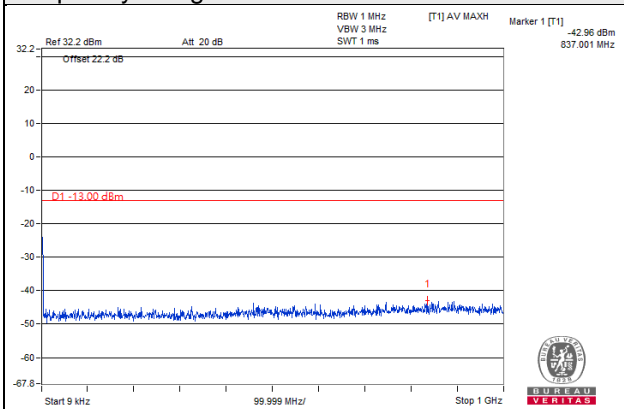

Frequency Range : 1GHz~10GHz

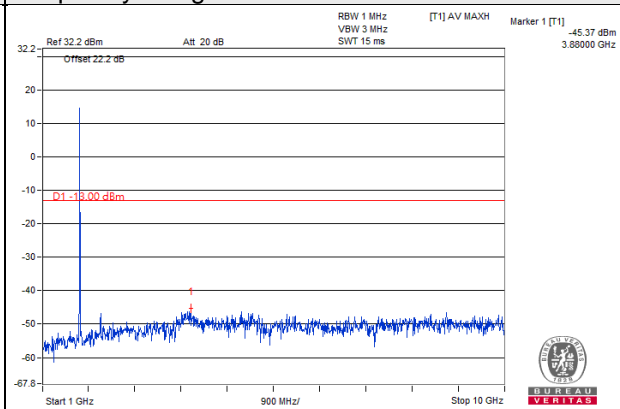

Frequency Range : 10GHz~20GHz

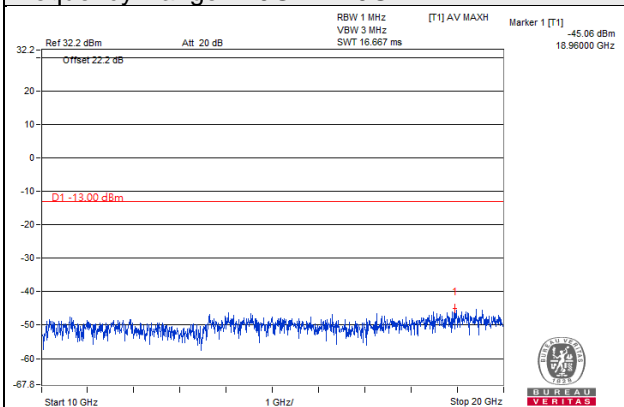

Note: The signal of 9kHz is IF signal from test instrument.

LTE Band 4 Channel Bandwidth: 5MHz

Channel 20175

Frequency Range : 9kHz~1GHz

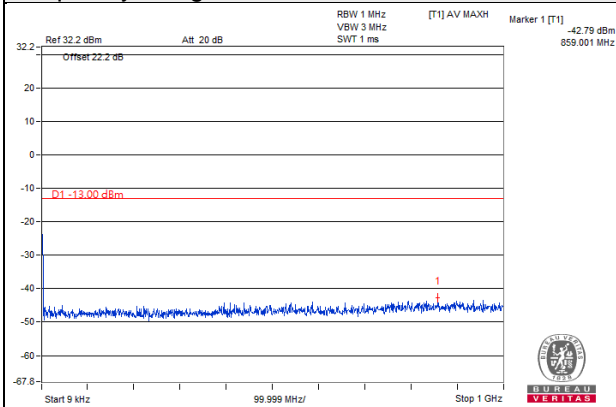

Frequency Range : 1GHz~10GHz

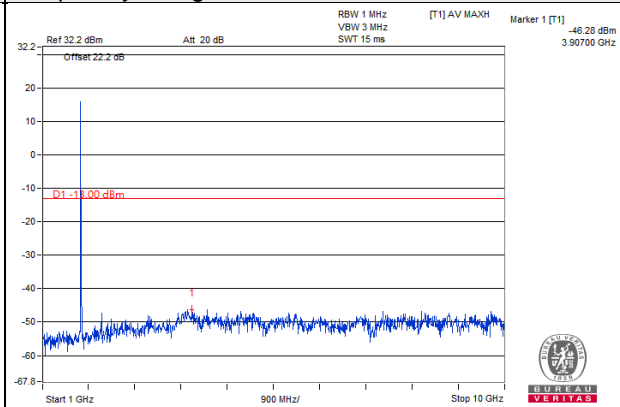

Frequency Range : 10GHz~20GHz

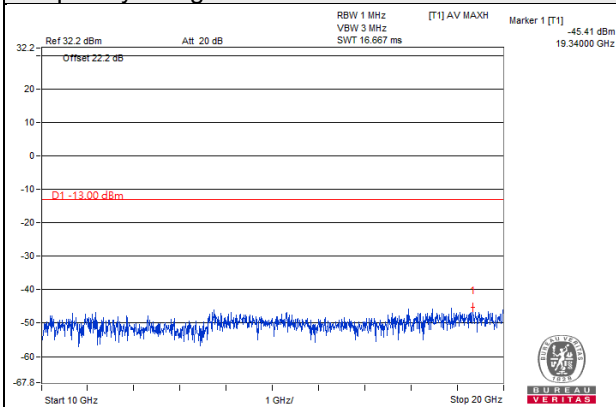

Note: The signal of 9kHz is IF signal from test instrument.

LTE Band 4 Channel Bandwidth: 5MHz

Channel 20375

Frequency Range : 9kHz~1GHz

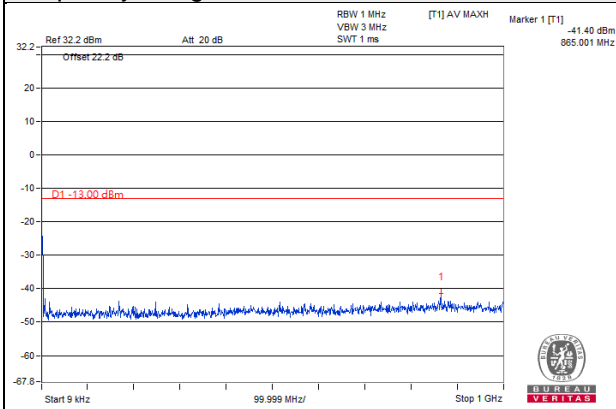

Frequency Range : 1GHz~10GHz

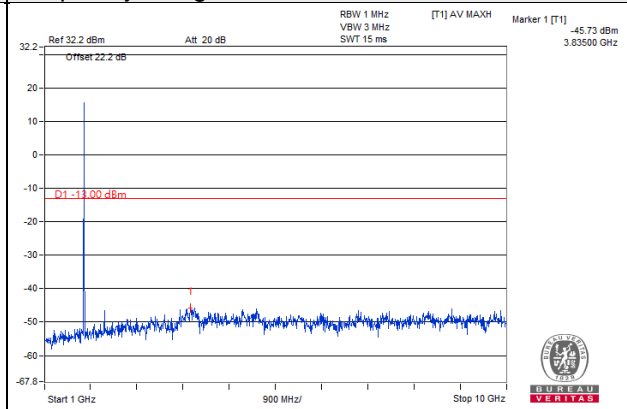

Frequency Range : 10GHz~20GHz

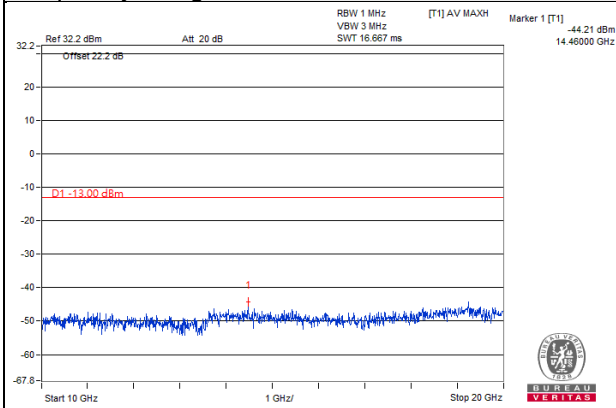

Note: The signal of 9kHz is IF signal from test instrument.

LTE Band 4 Channel Bandwidth: 10MHz

Channel 20000

Frequency Range : 9kHz~1GHz

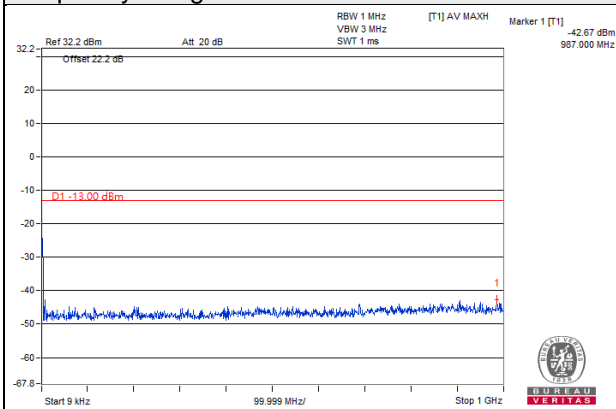

Frequency Range : 1GHz~10GHz

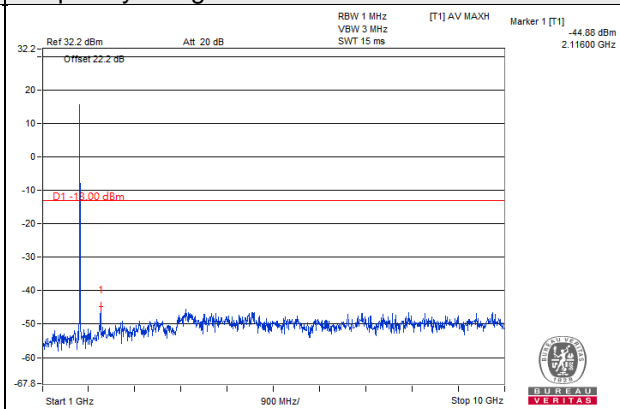

Frequency Range : 10GHz~20GHz

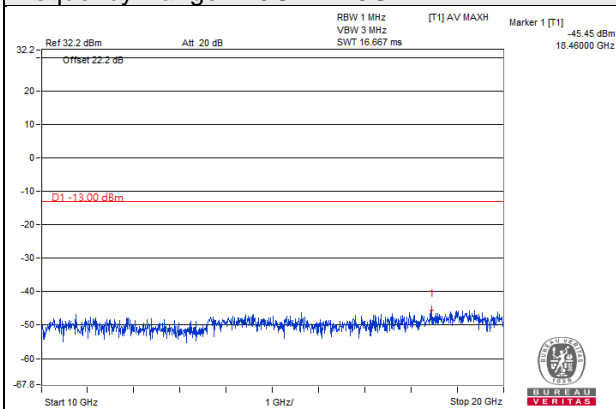

Note: The signal of 9kHz is IF signal from test instrument.

LTE Band 4 Channel Bandwidth: 10MHz

Channel 20175

Frequency Range : 9kHz~1GHz

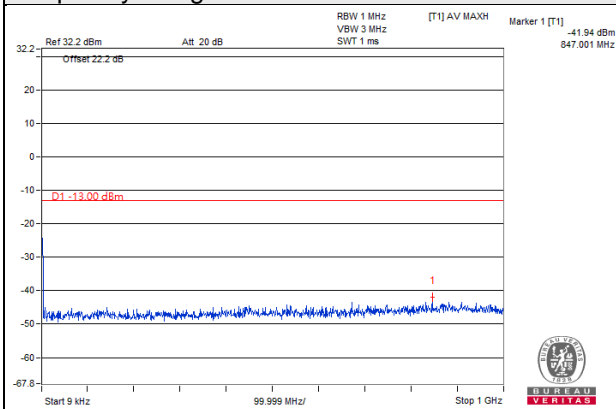

Frequency Range : 1GHz~10GHz

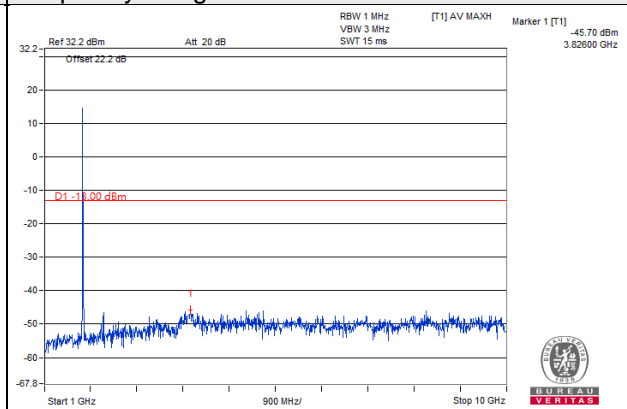

Frequency Range : 10GHz~20GHz

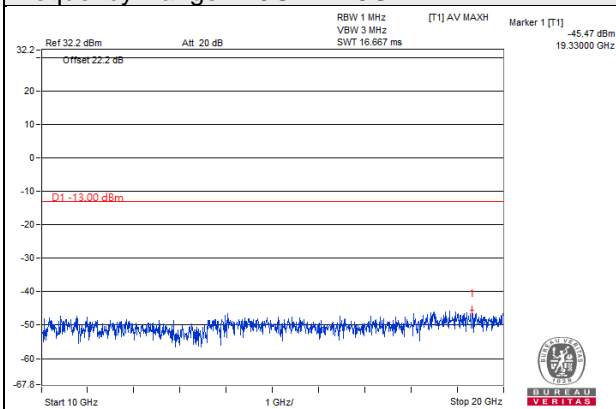

Note: The signal of 9kHz is IF signal from test instrument.

LTE Band 4 Channel Bandwidth: 10MHz

Channel 20350

Frequency Range : 9kHz~1GHz

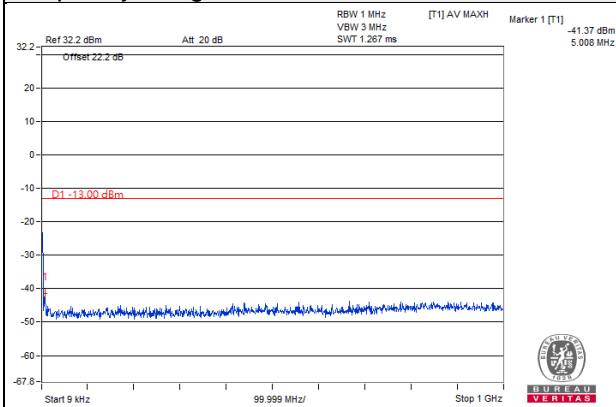

Frequency Range : 1GHz~10GHz

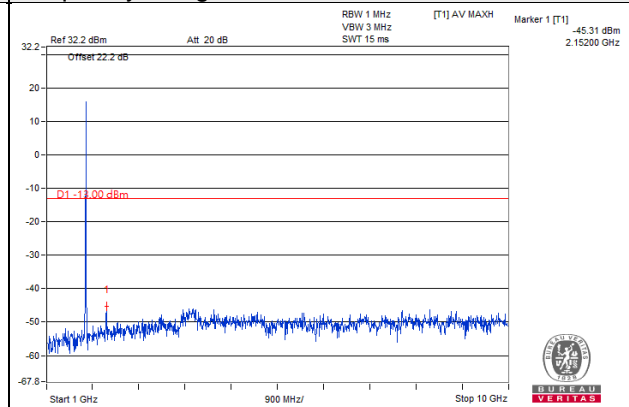

Frequency Range : 10GHz~20GHz

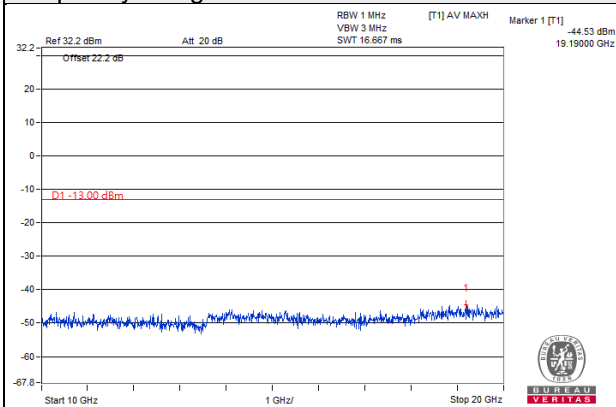

Note: The signal of 9kHz is IF signal from test instrument.

LTE Band 4 Channel Bandwidth: 15MHz

Channel 20025

Frequency Range : 9kHz~1GHz

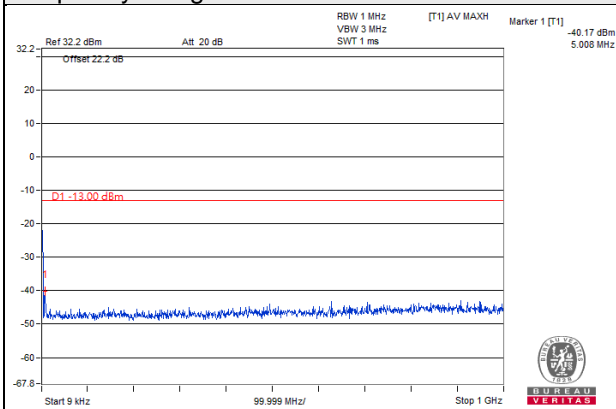

Frequency Range : 1GHz~10GHz

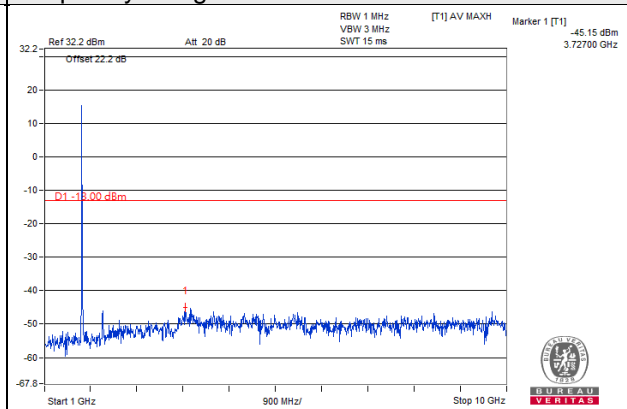

Frequency Range : 10GHz~20GHz

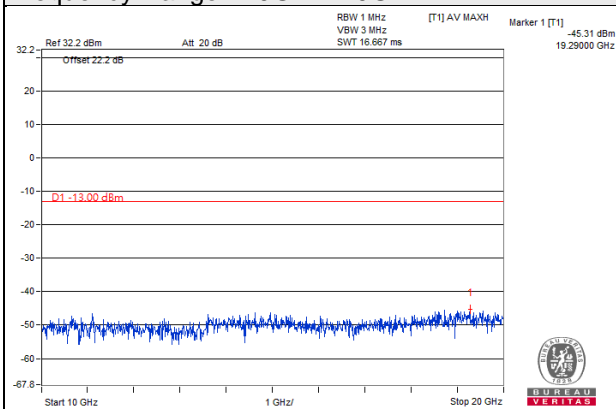

Note: The signal of 9kHz is IF signal from test instrument.

LTE Band 4 Channel Bandwidth: 15MHz

Channel 20175

Frequency Range : 9kHz~1GHz

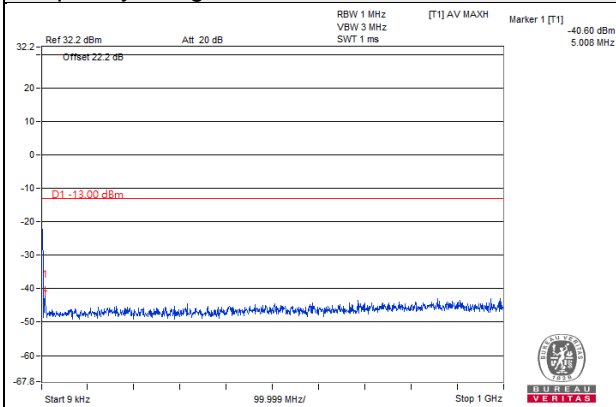

Frequency Range : 1GHz~10GHz

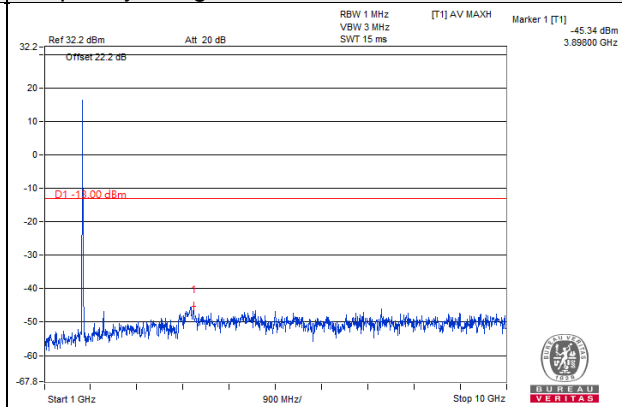

Frequency Range : 10GHz~20GHz

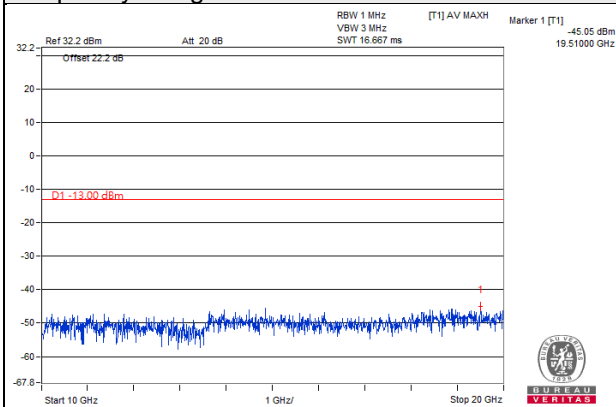

Note: The signal of 9kHz is IF signal from test instrument.

LTE Band 4 Channel Bandwidth: 15MHz

Channel 20325

Frequency Range : 9kHz~1GHz

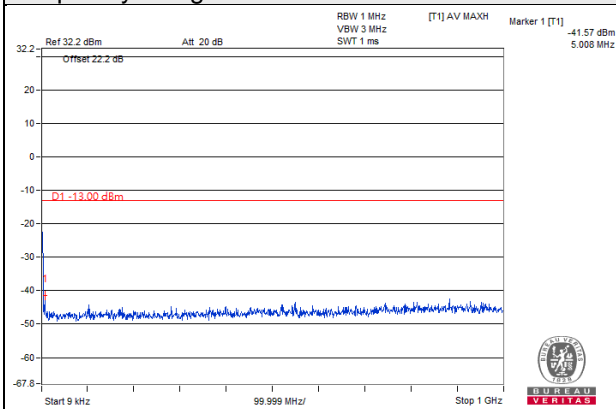

Frequency Range : 1GHz~10GHz

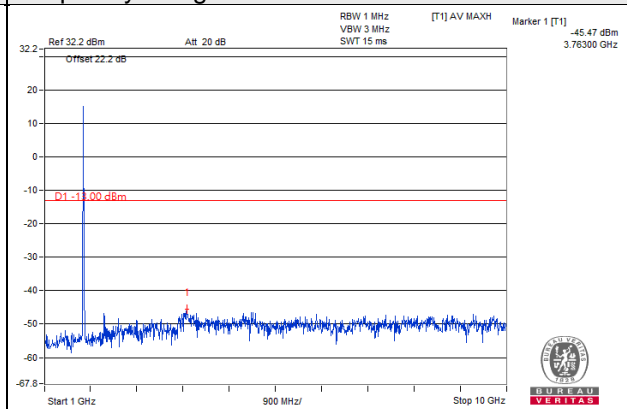

Frequency Range : 10GHz~20GHz

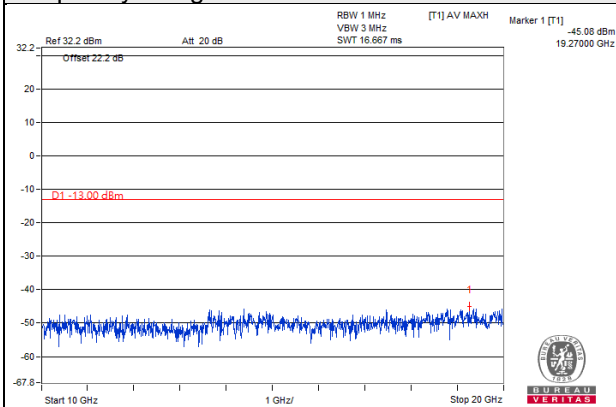

Note: The signal of 9kHz is IF signal from test instrument.

LTE Band 4 Channel Bandwidth: 20MHz

Channel 20050

Frequency Range : 9kHz~1GHz

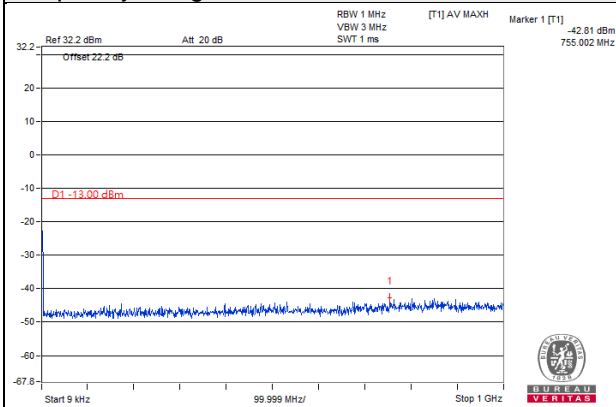

Frequency Range : 1GHz~10GHz

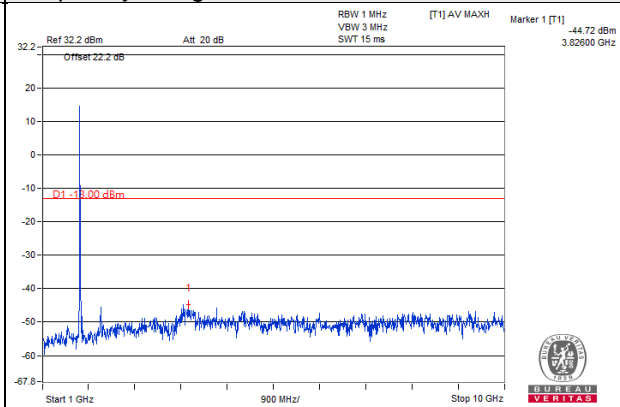

Frequency Range : 10GHz~20GHz

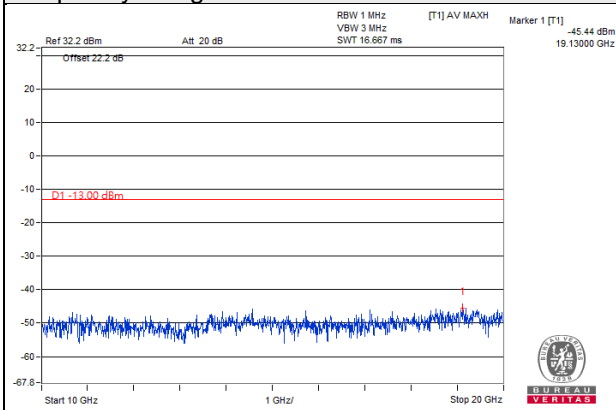

Note: The signal of 9kHz is IF signal from test instrument.

LTE Band 4 Channel Bandwidth: 20MHz

Channel 20175

Frequency Range : 9kHz~1GHz

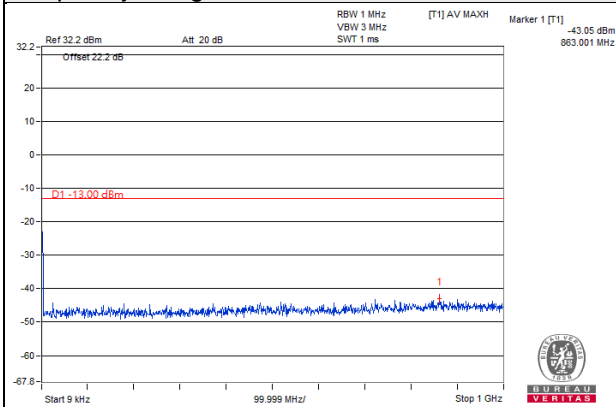

Frequency Range : 1GHz~10GHz

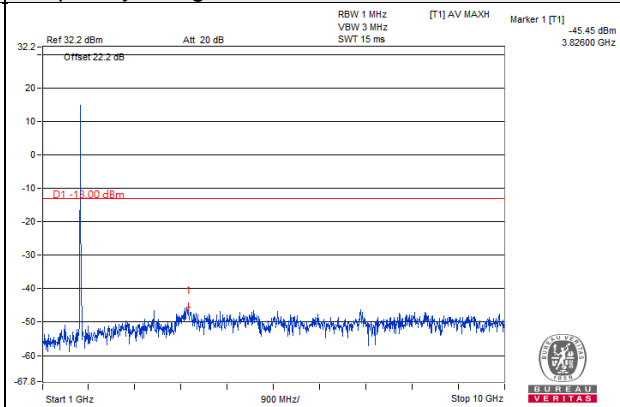

Frequency Range : 10GHz~20GHz

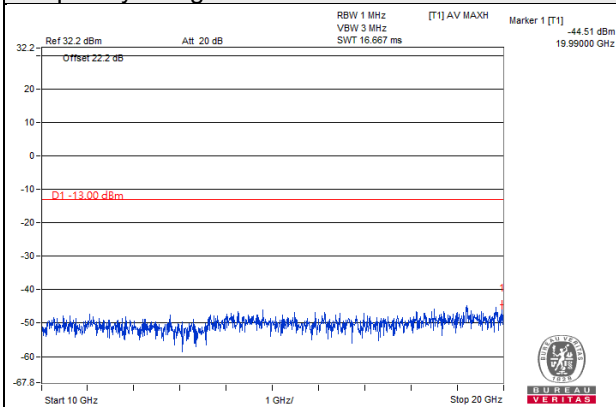

Note: The signal of 9kHz is IF signal from test instrument.

LTE Band 4 Channel Bandwidth: 20MHz

Channel 20300

Frequency Range : 9kHz~1GHz

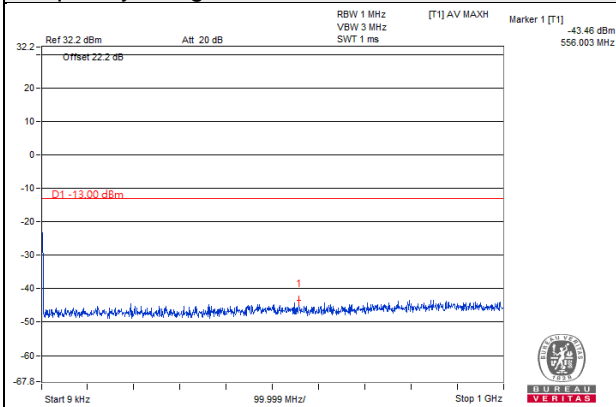

Frequency Range : 1GHz~10GHz

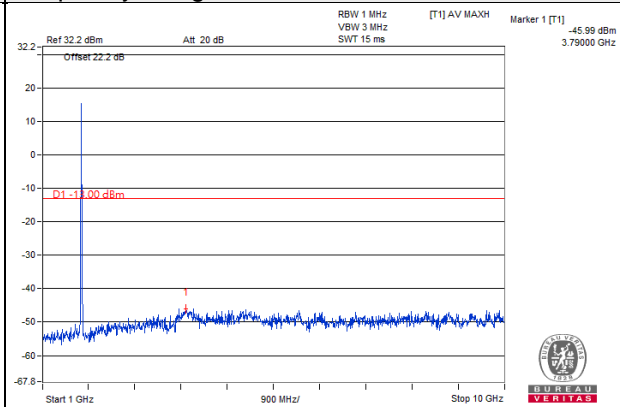

Frequency Range : 10GHz~20GHz

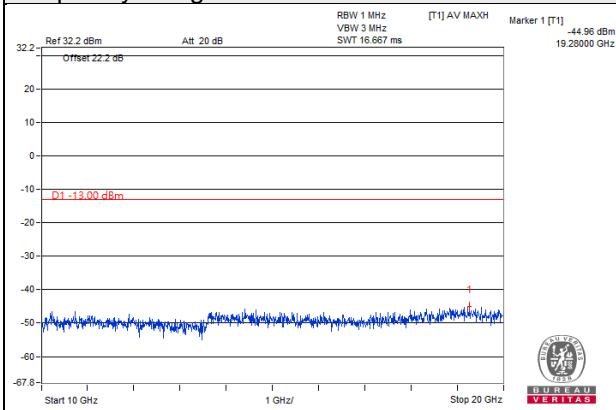

Note: The signal of 9kHz is IF signal from test instrument.

LTE Band 12 Channel Bandwidth: 1.4MHz

Channel 23017

Frequency Range : 9kHz~1GHz

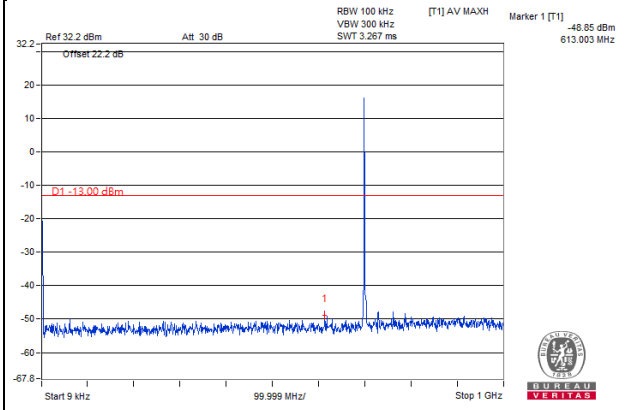

Frequency Range : 1GHz~10GHz

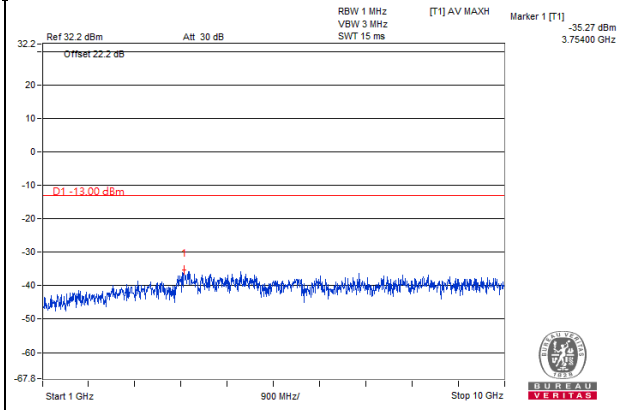

Channel 23095

Frequency Range : 9kHz~1GHz

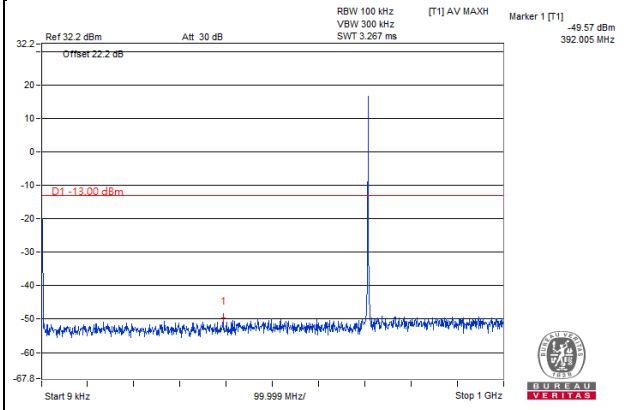

Frequency Range : 1GHz~10GHz

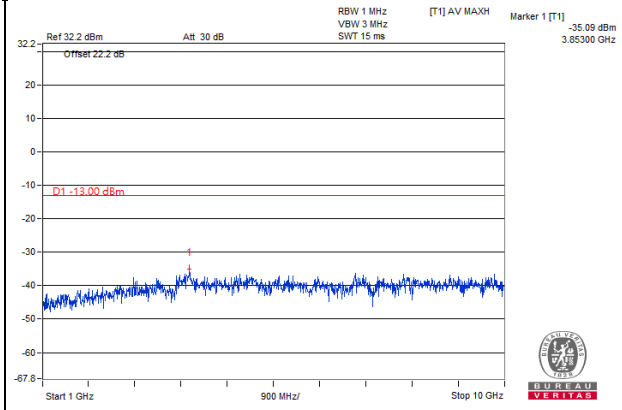

Channel 23173

Frequency Range : 9kHz~1GHz

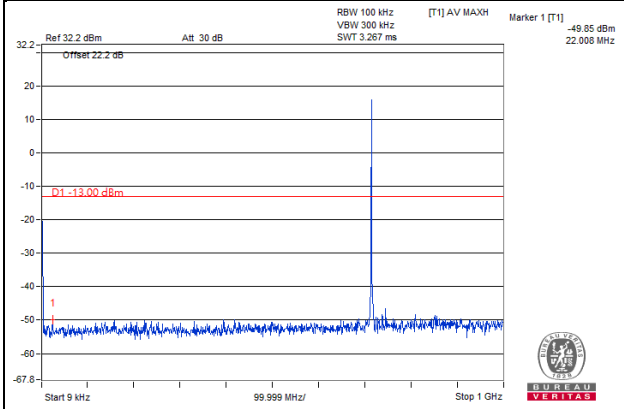

Frequency Range : 1GHz~10GHz

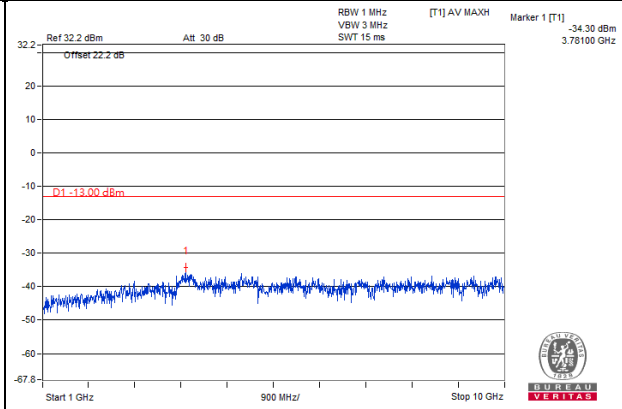

Note: The signal of 9kHz is IF signal from test instrument.

LTE Band 12 Channel Bandwidth: 3MHz

Channel 23025

Frequency Range : 9kHz~1GHz

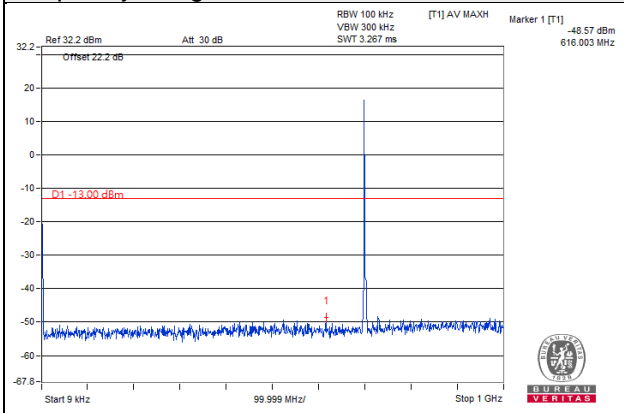

Frequency Range : 1GHz~10GHz

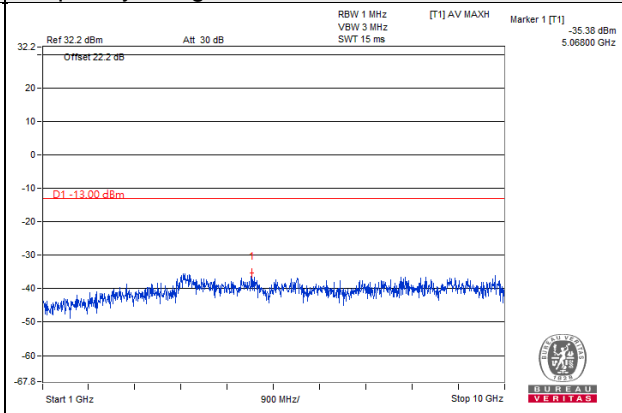

Channel 23095

Frequency Range : 9kHz~1GHz

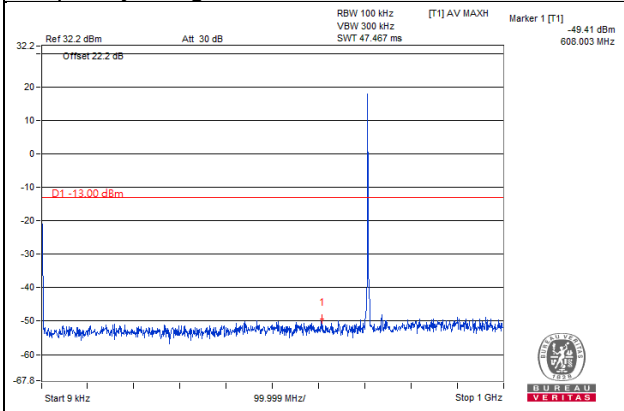

Frequency Range : 1GHz~10GHz

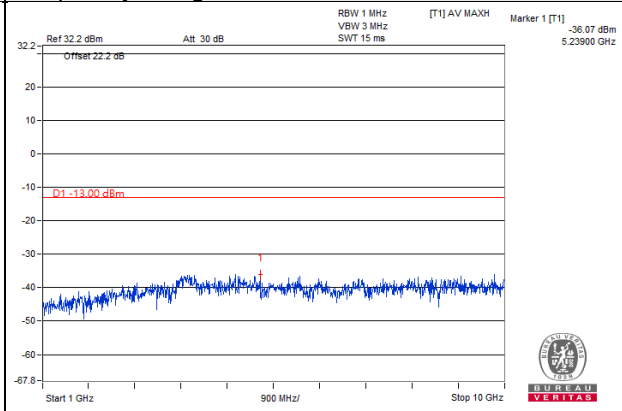

Channel 23165

Frequency Range : 9kHz~1GHz

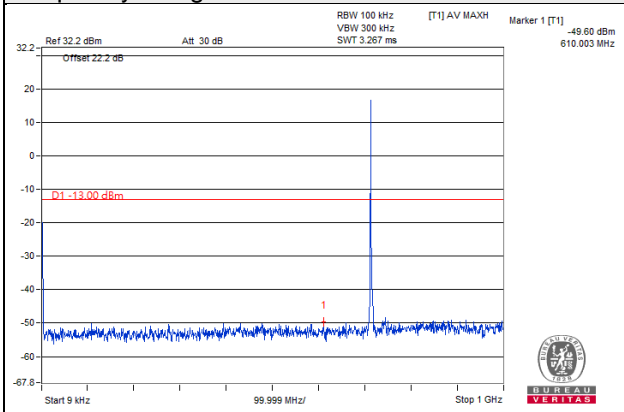

Frequency Range : 1GHz~10GHz

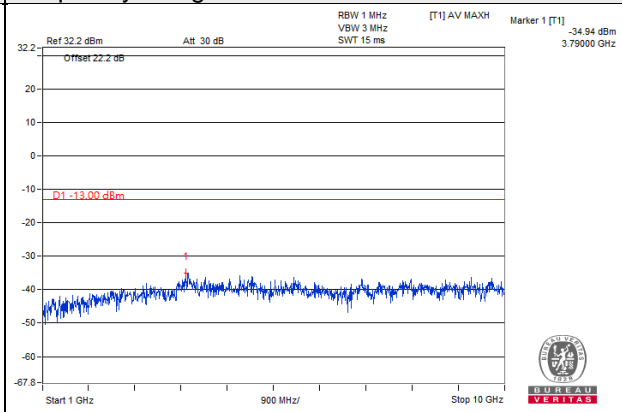

Note: The signal of 9kHz is IF signal from test instrument.

LTE Band 12 Channel Bandwidth: 5MHz

Channel 23035

Frequency Range : 9kHz~1GHz

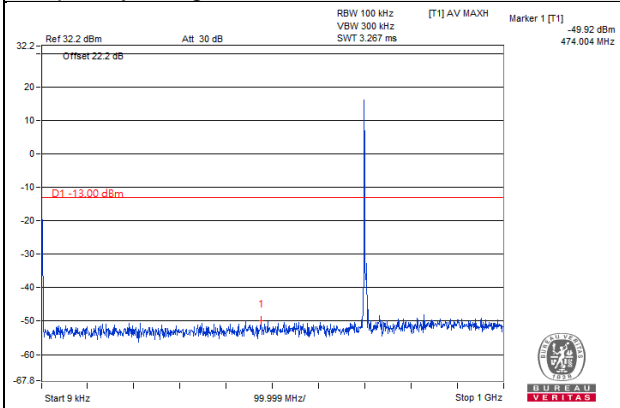

Frequency Range : 1GHz~10GHz

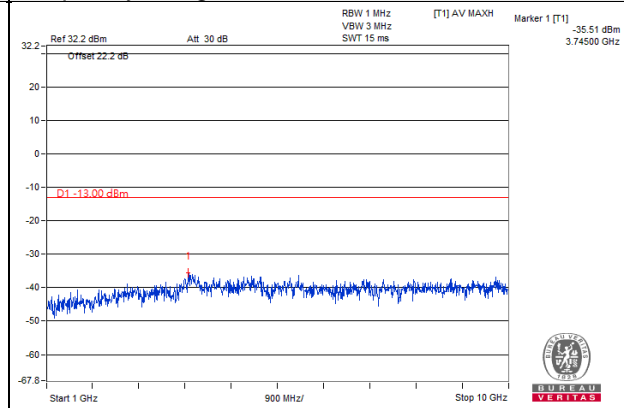

Channel 23095

Frequency Range : 9kHz~1GHz

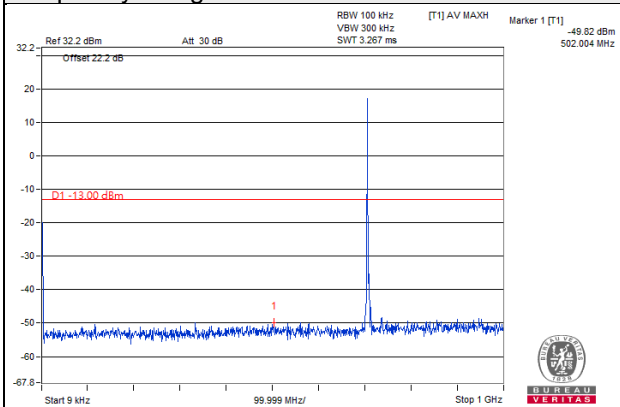

Frequency Range : 1GHz~10GHz

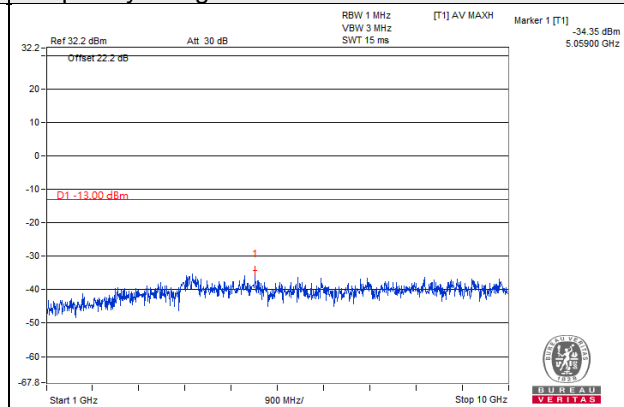

Channel 23155

Frequency Range : 9kHz~1GHz

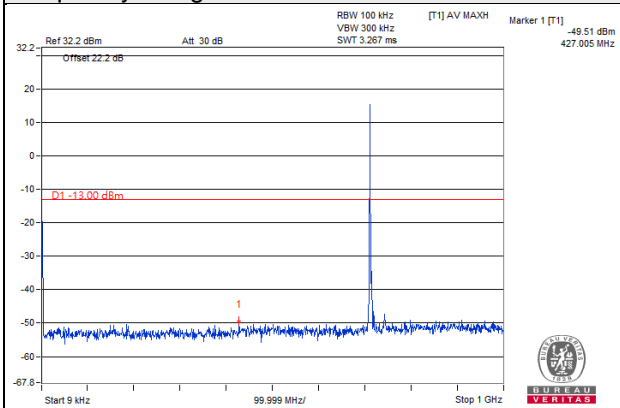

Frequency Range : 1GHz~10GHz

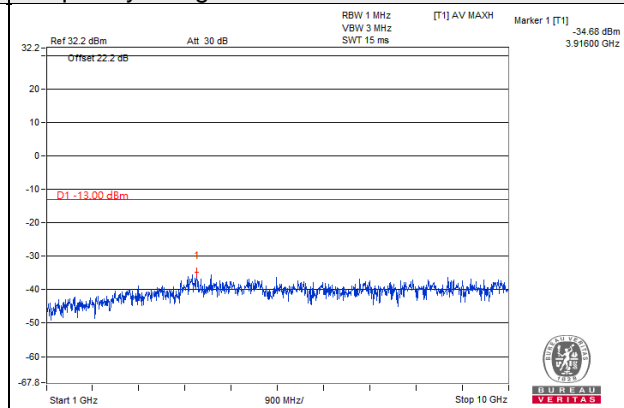

Note: The signal of 9kHz is IF signal from test instrument.

LTE Band 12 Channel Bandwidth: 10MHz

Channel 23060

Frequency Range : 9kHz~1GHz

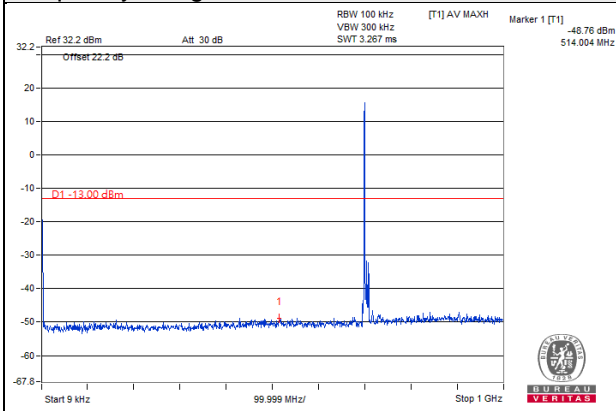

Frequency Range : 1GHz~10GHz

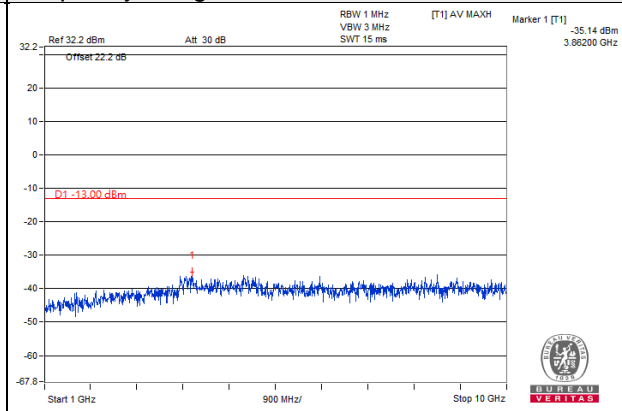

Channel 23095

Frequency Range : 9kHz~1GHz

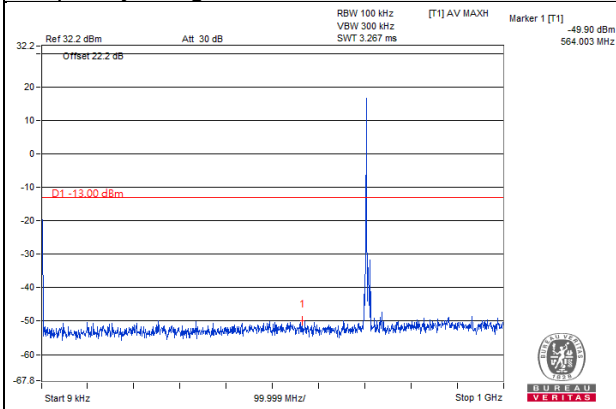

Frequency Range : 1GHz~10GHz

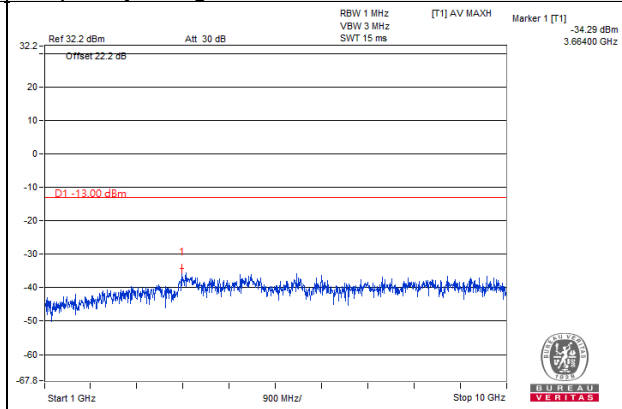

Channel 23130

Frequency Range : 9kHz~1GHz

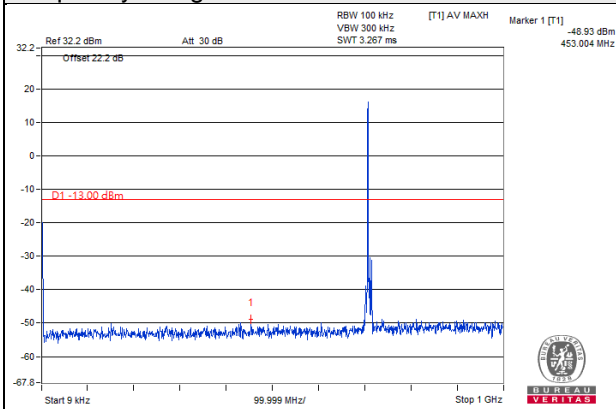

Frequency Range : 1GHz~10GHz

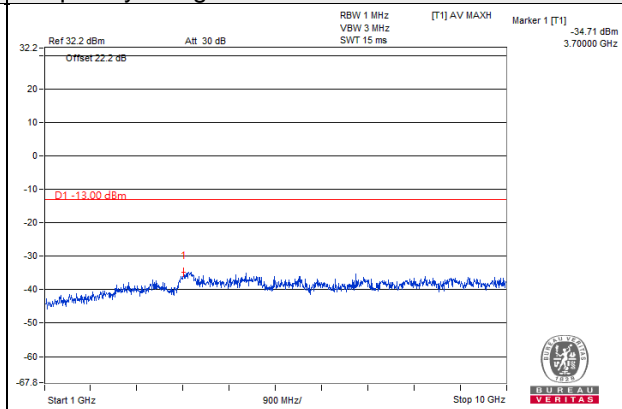

Note: The signal of 9kHz is IF signal from test instrument.

4.8 Radiated Emission Measurement

4.8.1 Limits of Radiated Emission Measurement

According to FCC 27.53(g) For operations in the 600 MHz band and the 698-746 MHz band, the power of any emission outside a licensee's frequency band(s) of operation shall be attenuated below the transmitter power (P) within the licensed band(s) of operation, measured in watts, by at least $43 + 10 \log(P)$ dB. Compliance with this provision is based on the use of measurement instrumentation employing a resolution bandwidth of 100 kilohertz or greater. However, in the 100 kilohertz bands immediately outside and adjacent to a licensee's frequency block, a resolution bandwidth of at least 30 kHz may be employed.

According to FCC 27.53(h) AWS emission limits— General protection levels. Except as otherwise specified below, for operations in the 1695-1710 MHz, 1710-1755 MHz, 1755-1780 MHz, 1915-1920 MHz, 1995-2000 MHz, 2000-2020 MHz, 2110-2155 MHz, 2155-2180 MHz, and 2180-2200 bands, the power of any emission outside a licensee's frequency block shall be attenuated below the transmitter power (P) in watts by at least $43 + 10 \log_{10}(P)$ dB.

4.8.2 Test Procedure

- a. The power was measured with Spectrum Analyzer. All measurements were done at 3 channels (low, middle and high channel of operational frequency range.)
- b. Substitution method is used for EIRP measurement. In the semi-anechoic chamber, EUT placed on the 0.8m/1.5m height of Turn Table, rotated the table around 360 degrees to search the maximum radiation power and receiver antenna shall be rotated vertical and horizontal polarization and moved height from 1m to 4m to find the maximum polar radiated power. The "Read Value" is the spectrum reading the maximum power value.
- c. Follow ANSI 63.26 section 5.2.7 d), $EIRP \text{ Value (dBm)} = \text{Read Value (dB}\mu\text{V/m)} - \text{Correction Factor @ 3m}$
- d. $\text{Correction Factor (dB) @ 3m} = 20\log(D) - 104.8$; where D is the measurement distance @ 3m = -95.26dB
- e. ERP power can be calculated from EIRP power by subtracting the gain of dipole, $ERP \text{ power} = EIRP \text{ power} - 2.15\text{dBi}$

NOTE: The resolution bandwidth and video bandwidth of test receiver/spectrum analyzer is 1MHz/3MHz.

4.8.3 Deviation from Test Standard

No deviation.

4.8.4 Test Setup

<Frequency Range below 1GHz>

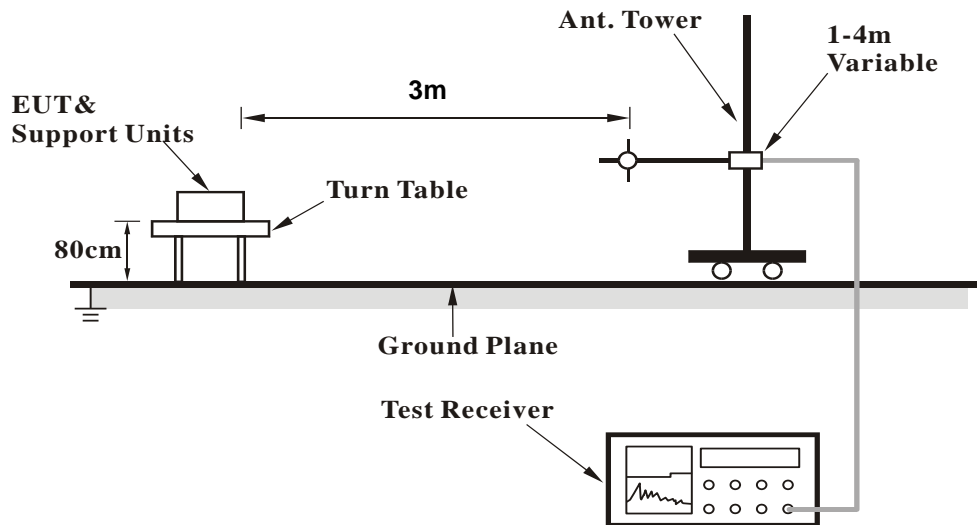

<Frequency Range above 1GHz>

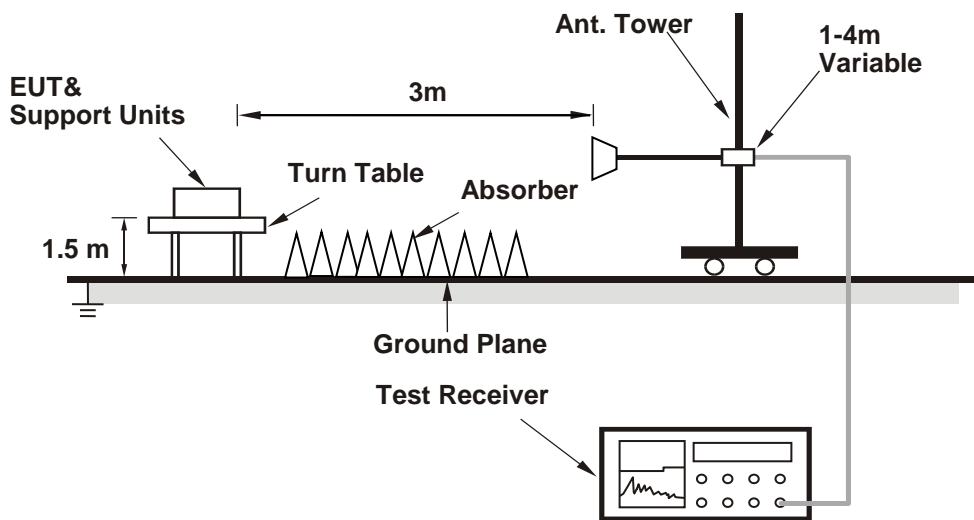

For the actual test configuration, please refer to the attached file (Test Setup Photo).

4.8.5 Test Results

Below 1GHz

LTE Band 4: 1.4MHz

Mode	TX channel 19957	Frequency Range	Below 1000 MHz
------	------------------	-----------------	----------------

Antenna Polarity & Test Distance: Horizontal at 3 M						
No.	Freq. (MHz)	Reading (dB μ V/m)	Correction Factor (dB)	Emission Value (dBm)	Limit (dBm)	Margin (dB)
1	74.18	27.93	-95.26	-67.33	-13	-54.33
2	149.91	30.9	-95.26	-64.36	-13	-51.36
3	205.41	32.21	-95.26	-63.05	-13	-50.05
4	296.01	35.85	-95.26	-59.41	-13	-46.41
5	406.64	37.29	-95.26	-57.97	-13	-44.97
6	645.84	36.57	-95.26	-58.69	-13	-45.69
Antenna Polarity & Test Distance: Vertical at 3 M						
No.	Freq. (MHz)	Reading (dB μ V/m)	Correction Factor (dB)	Emission Value (dBm)	Limit (dBm)	Margin (dB)
1	83.83	28.74	-95.26	-66.52	-13	-53.52
2	154.62	31.47	-95.26	-63.79	-13	-50.79
3	200.68	31.5	-95.26	-63.76	-13	-50.76
4	293.23	37.06	-95.26	-58.20	-13	-45.20
5	405.31	33.8	-95.26	-61.46	-13	-48.46
6	658.85	35.38	-95.26	-59.88	-13	-46.88

Remarks:

1. Follow ANSI 63.26 section 5.2.7 d), Emission Value (dBm) = E (dB μ V/m) - Correction Factor @ 3m.
2. Correction Factor (dB) = 20log(D) - 104.8; where D is the measurement distance @ 3m.

Mode	TX channel 20175	Frequency Range	Below 1000 MHz
------	------------------	-----------------	----------------

Antenna Polarity & Test Distance: Horizontal at 3 M

No.	Freq. (MHz)	Reading (dB μ V/m)	Correction Factor (dB)	Emission Value (dBm)	Limit (dBm)	Margin (dB)
1	74.1	27.47	-95.26	-67.79	-13	-54.79
2	150.11	30.54	-95.26	-64.72	-13	-51.72
3	205.1	32.42	-95.26	-62.84	-13	-49.84
4	296.85	35.21	-95.26	-60.05	-13	-47.05
5	406.68	37.1	-95.26	-58.16	-13	-45.16
6	645.6	37.4	-95.26	-57.86	-13	-44.86

Antenna Polarity & Test Distance: Vertical at 3 M

No.	Freq. (MHz)	Reading (dB μ V/m)	Correction Factor (dB)	Emission Value (dBm)	Limit (dBm)	Margin (dB)
1	83.77	28.72	-95.26	-66.54	-13	-53.54
2	154.4	31.61	-95.26	-63.65	-13	-50.65
3	199.91	31.66	-95.26	-63.60	-13	-50.60
4	293.51	37.49	-95.26	-57.77	-13	-44.77
5	405.28	34.17	-95.26	-61.09	-13	-48.09
6	658.99	34.99	-95.26	-60.27	-13	-47.27

Remarks:

1. Follow ANSI 63.26 section 5.2.7 d), Emission Value (dBm) = E (dB μ V/m) - Correction Factor @ 3m.
2. Correction Factor (dB) = $20\log(D) - 104.8$; where D is the measurement distance @ 3m.

Mode	TX channel 20393	Frequency Range	Below 1000 MHz
------	------------------	-----------------	----------------

Antenna Polarity & Test Distance: Horizontal at 3 M

No.	Freq. (MHz)	Reading (dB μ V/m)	Correction Factor (dB)	Emission Value (dBm)	Limit (dBm)	Margin (dB)
1	73.99	27.67	-95.26	-67.59	-13	-54.59
2	149.5	30.66	-95.26	-64.60	-13	-51.60
3	205.01	32.2	-95.26	-63.06	-13	-50.06
4	296.02	35.43	-95.26	-59.83	-13	-46.83
5	406.57	37.42	-95.26	-57.84	-13	-44.84
6	645.75	37.02	-95.26	-58.24	-13	-45.24

Antenna Polarity & Test Distance: Vertical at 3 M

No.	Freq. (MHz)	Reading (dB μ V/m)	Correction Factor (dB)	Emission Value (dBm)	Limit (dBm)	Margin (dB)
1	84.09	28.66	-95.26	-66.60	-13	-53.60
2	154.39	32.1	-95.26	-63.16	-13	-50.16
3	199.92	31.13	-95.26	-64.13	-13	-51.13
4	293.41	37.54	-95.26	-57.72	-13	-44.72
5	405.35	34.38	-95.26	-60.88	-13	-47.88
6	658.56	35.47	-95.26	-59.79	-13	-46.79

Remarks:

1. Follow ANSI 63.26 section 5.2.7 d), Emission Value (dBm) = E (dB μ V/m) - Correction Factor @ 3m.
2. Correction Factor (dB) = $20\log(D) - 104.8$; where D is the measurement distance @ 3m.

LTE Band 4: 3MHz

Mode	TX channel 19965	Frequency Range	Below 1000 MHz
------	------------------	-----------------	----------------

Antenna Polarity & Test Distance: Horizontal at 3 M

No.	Freq. (MHz)	Reading (dB μ V/m)	Correction Factor (dB)	Emission Value (dBm)	Limit (dBm)	Margin (dB)
1	74.08	27.59	-95.26	-67.67	-13	-54.67
2	150.16	30.25	-95.26	-65.01	-13	-52.01
3	205.37	32.22	-95.26	-63.04	-13	-50.04
4	296.65	35.74	-95.26	-59.52	-13	-46.52
5	406.83	37.39	-95.26	-57.87	-13	-44.87
6	645.86	37.16	-95.26	-58.10	-13	-45.10

Antenna Polarity & Test Distance: Vertical at 3 M

No.	Freq. (MHz)	Reading (dB μ V/m)	Correction Factor (dB)	Emission Value (dBm)	Limit (dBm)	Margin (dB)
1	83.82	28.52	-95.26	-66.74	-13	-53.74
2	154.91	31.88	-95.26	-63.38	-13	-50.38
3	200.28	31.72	-95.26	-63.54	-13	-50.54
4	293.76	36.77	-95.26	-58.49	-13	-45.49
5	405.3	33.66	-95.26	-61.60	-13	-48.60
6	658.26	35.12	-95.26	-60.14	-13	-47.14

Remarks:

1. Follow ANSI 63.26 section 5.2.7 d), Emission Value (dBm) = E (dB μ V/m) - Correction Factor @ 3m.
2. Correction Factor (dB) = $20\log(D) - 104.8$; where D is the measurement distance @ 3m.

Mode	TX channel 20175	Frequency Range	Below 1000 MHz
------	------------------	-----------------	----------------

Antenna Polarity & Test Distance: Horizontal at 3 M

No.	Freq. (MHz)	Reading (dB μ V/m)	Correction Factor (dB)	Emission Value (dBm)	Limit (dBm)	Margin (dB)
1	73.57	27.15	-95.26	-68.11	-13	-55.11
2	150.2	30.19	-95.26	-65.07	-13	-52.07
3	204.63	31.98	-95.26	-63.28	-13	-50.28
4	296.16	35.13	-95.26	-60.13	-13	-47.13
5	406.05	37.41	-95.26	-57.85	-13	-44.85
6	645.78	37.51	-95.26	-57.75	-13	-44.75

Antenna Polarity & Test Distance: Vertical at 3 M

No.	Freq. (MHz)	Reading (dB μ V/m)	Correction Factor (dB)	Emission Value (dBm)	Limit (dBm)	Margin (dB)
1	83.9	29.21	-95.26	-66.05	-13	-53.05
2	154.32	31.5	-95.26	-63.76	-13	-50.76
3	200.07	31.33	-95.26	-63.93	-13	-50.93
4	293.92	36.69	-95.26	-58.57	-13	-45.57
5	405.22	33.82	-95.26	-61.44	-13	-48.44
6	658.76	35.42	-95.26	-59.84	-13	-46.84

Remarks:

1. Follow ANSI 63.26 section 5.2.7 d), Emission Value (dBm) = E (dB μ V/m) - Correction Factor @ 3m.
2. Correction Factor (dB) = 20log(D) - 104.8; where D is the measurement distance @ 3m.

Mode	TX channel 20385	Frequency Range	Below 1000 MHz
------	------------------	-----------------	----------------

Antenna Polarity & Test Distance: Horizontal at 3 M

No.	Freq. (MHz)	Reading (dB μ V/m)	Correction Factor (dB)	Emission Value (dBm)	Limit (dBm)	Margin (dB)
1	73.92	27.45	-95.26	-67.81	-13	-54.81
2	150.27	30.23	-95.26	-65.03	-13	-52.03
3	205.56	32.19	-95.26	-63.07	-13	-50.07
4	296.43	35.73	-95.26	-59.53	-13	-46.53
5	406.93	36.85	-95.26	-58.41	-13	-45.41
6	646.51	36.58	-95.26	-58.68	-13	-45.68

Antenna Polarity & Test Distance: Vertical at 3 M

No.	Freq. (MHz)	Reading (dB μ V/m)	Correction Factor (dB)	Emission Value (dBm)	Limit (dBm)	Margin (dB)
1	84.16	29.18	-95.26	-66.08	-13	-53.08
2	154.18	32.16	-95.26	-63.10	-13	-50.10
3	200.25	30.95	-95.26	-64.31	-13	-51.31
4	293.24	37.03	-95.26	-58.23	-13	-45.23
5	405.14	34.19	-95.26	-61.07	-13	-48.07
6	658.67	35.03	-95.26	-60.23	-13	-47.23

Remarks:

1. Follow ANSI 63.26 section 5.2.7 d), Emission Value (dBm) = E (dB μ V/m) - Correction Factor @ 3m.
2. Correction Factor (dB) = $20\log(D) - 104.8$; where D is the measurement distance @ 3m.

LTE Band 4: 5MHz

Mode	TX channel 19975	Frequency Range	Below 1000 MHz
------	------------------	-----------------	----------------

Antenna Polarity & Test Distance: Horizontal at 3 M

No.	Freq. (MHz)	Reading (dB μ V/m)	Correction Factor (dB)	Emission Value (dBm)	Limit (dBm)	Margin (dB)
1	73.94	27.45	-95.26	-67.81	-13	-54.81
2	150.14	30.42	-95.26	-64.84	-13	-51.84
3	205.49	32.62	-95.26	-62.64	-13	-49.64
4	296.52	35.63	-95.26	-59.63	-13	-46.63
5	406.15	37.28	-95.26	-57.98	-13	-44.98
6	645.67	37.44	-95.26	-57.82	-13	-44.82

Antenna Polarity & Test Distance: Vertical at 3 M

No.	Freq. (MHz)	Reading (dB μ V/m)	Correction Factor (dB)	Emission Value (dBm)	Limit (dBm)	Margin (dB)
1	83.94	28.75	-95.26	-66.51	-13	-53.51
2	154.26	31.89	-95.26	-63.37	-13	-50.37
3	200.03	31.27	-95.26	-63.99	-13	-50.99
4	293.42	36.8	-95.26	-58.46	-13	-45.46
5	405.33	34.59	-95.26	-60.67	-13	-47.67
6	658.41	35.47	-95.26	-59.79	-13	-46.79

Remarks:

1. Follow ANSI 63.26 section 5.2.7 d), Emission Value (dBm) = E (dB μ V/m) - Correction Factor @ 3m.
2. Correction Factor (dB) = 20log(D) - 104.8; where D is the measurement distance @ 3m.

Mode	TX channel 20175	Frequency Range	Below 1000 MHz
------	------------------	-----------------	----------------

Antenna Polarity & Test Distance: Horizontal at 3 M

No.	Freq. (MHz)	Reading (dB μ V/m)	Correction Factor (dB)	Emission Value (dBm)	Limit (dBm)	Margin (dB)
1	74.32	27.81	-95.26	-67.45	-13	-54.45
2	150.12	30.81	-95.26	-64.45	-13	-51.45
3	205.12	32.13	-95.26	-63.13	-13	-50.13
4	296.76	35.65	-95.26	-59.61	-13	-46.61
5	406.23	37.74	-95.26	-57.52	-13	-44.52
6	645.95	37.01	-95.26	-58.25	-13	-45.25

Antenna Polarity & Test Distance: Vertical at 3 M

No.	Freq. (MHz)	Reading (dB μ V/m)	Correction Factor (dB)	Emission Value (dBm)	Limit (dBm)	Margin (dB)
1	83.38	28.88	-95.26	-66.38	-13	-53.38
2	154.91	32.05	-95.26	-63.21	-13	-50.21
3	200.23	31.63	-95.26	-63.63	-13	-50.63
4	293.51	37.41	-95.26	-57.85	-13	-44.85
5	405.35	33.69	-95.26	-61.57	-13	-48.57
6	658.69	35.71	-95.26	-59.55	-13	-46.55

Remarks:

1. Follow ANSI 63.26 section 5.2.7 d), Emission Value (dBm) = E (dB μ V/m) - Correction Factor @ 3m.
2. Correction Factor (dB) = $20\log(D) - 104.8$; where D is the measurement distance @ 3m.

Mode	TX channel 20375	Frequency Range	Below 1000 MHz
------	------------------	-----------------	----------------

Antenna Polarity & Test Distance: Horizontal at 3 M

No.	Freq. (MHz)	Reading (dB μ V/m)	Correction Factor (dB)	Emission Value (dBm)	Limit (dBm)	Margin (dB)
1	73.57	27.4	-95.26	-67.86	-13	-54.86
2	149.69	30.14	-95.26	-65.12	-13	-52.12
3	204.69	32.74	-95.26	-62.52	-13	-49.52
4	296.6	35.39	-95.26	-59.87	-13	-46.87
5	406.59	37.36	-95.26	-57.90	-13	-44.90
6	646.03	36.6	-95.26	-58.66	-13	-45.66

Antenna Polarity & Test Distance: Vertical at 3 M

No.	Freq. (MHz)	Reading (dB μ V/m)	Correction Factor (dB)	Emission Value (dBm)	Limit (dBm)	Margin (dB)
1	84.15	28.68	-95.26	-66.58	-13	-53.58
2	154.96	32.09	-95.26	-63.17	-13	-50.17
3	200.07	31.4	-95.26	-63.86	-13	-50.86
4	293.63	36.92	-95.26	-58.34	-13	-45.34
5	405.68	33.86	-95.26	-61.40	-13	-48.40
6	659.16	35.83	-95.26	-59.43	-13	-46.43

Remarks:

1. Follow ANSI 63.26 section 5.2.7 d), Emission Value (dBm) = E (dB μ V/m) - Correction Factor @ 3m.
2. Correction Factor (dB) = 20log(D) - 104.8; where D is the measurement distance @ 3m.

LTE Band 4: 10MHz

Mode	TX channel 20000	Frequency Range	Below 1000 MHz
------	------------------	-----------------	----------------

Antenna Polarity & Test Distance: Horizontal at 3 M

No.	Freq. (MHz)	Reading (dB μ V/m)	Correction Factor (dB)	Emission Value (dBm)	Limit (dBm)	Margin (dB)
1	73.49	27.38	-95.26	-67.88	-13	-54.88
2	150.19	30.3	-95.26	-64.96	-13	-51.96
3	205.53	31.83	-95.26	-63.43	-13	-50.43
4	296.09	35.36	-95.26	-59.90	-13	-46.90
5	406.2	36.96	-95.26	-58.30	-13	-45.30
6	646.4	36.66	-95.26	-58.60	-13	-45.60

Antenna Polarity & Test Distance: Vertical at 3 M

No.	Freq. (MHz)	Reading (dB μ V/m)	Correction Factor (dB)	Emission Value (dBm)	Limit (dBm)	Margin (dB)
1	84.24	28.56	-95.26	-66.70	-13	-53.70
2	154.66	31.99	-95.26	-63.27	-13	-50.27
3	199.73	31.79	-95.26	-63.47	-13	-50.47
4	293.54	37.02	-95.26	-58.24	-13	-45.24
5	405.35	33.66	-95.26	-61.60	-13	-48.60
6	658.33	35.52	-95.26	-59.74	-13	-46.74

Remarks:

1. Follow ANSI 63.26 section 5.2.7 d), Emission Value (dBm) = E (dB μ V/m) - Correction Factor @ 3m.
2. Correction Factor (dB) = 20log(D) - 104.8; where D is the measurement distance @ 3m.

Mode	TX channel 20175	Frequency Range	Below 1000 MHz
------	------------------	-----------------	----------------

Antenna Polarity & Test Distance: Horizontal at 3 M

No.	Freq. (MHz)	Reading (dB μ V/m)	Correction Factor (dB)	Emission Value (dBm)	Limit (dBm)	Margin (dB)
1	73.98	27.65	-95.26	-67.61	-13	-54.61
2	149.63	30.61	-95.26	-64.65	-13	-51.65
3	204.88	32.6	-95.26	-62.66	-13	-49.66
4	296.15	35.33	-95.26	-59.93	-13	-46.93
5	406.37	37.75	-95.26	-57.51	-13	-44.51
6	645.72	37.37	-95.26	-57.89	-13	-44.89

Antenna Polarity & Test Distance: Vertical at 3 M

No.	Freq. (MHz)	Reading (dB μ V/m)	Correction Factor (dB)	Emission Value (dBm)	Limit (dBm)	Margin (dB)
1	84.21	28.92	-95.26	-66.34	-13	-53.34
2	154.77	31.69	-95.26	-63.57	-13	-50.57
3	200.44	30.95	-95.26	-64.31	-13	-51.31
4	293.48	37.09	-95.26	-58.17	-13	-45.17
5	405.55	33.69	-95.26	-61.57	-13	-48.57
6	658.89	35.45	-95.26	-59.81	-13	-46.81

Remarks:

1. Follow ANSI 63.26 section 5.2.7 d), Emission Value (dBm) = E (dB μ V/m) - Correction Factor @ 3m.
2. Correction Factor (dB) = 20log(D) - 104.8; where D is the measurement distance @ 3m.

Mode	TX channel 20350	Frequency Range	Below 1000 MHz
------	------------------	-----------------	----------------

Antenna Polarity & Test Distance: Horizontal at 3 M

No.	Freq. (MHz)	Reading (dB μ V/m)	Correction Factor (dB)	Emission Value (dBm)	Limit (dBm)	Margin (dB)
1	73.82	27.81	-95.26	-67.45	-13	-54.45
2	149.72	30.46	-95.26	-64.80	-13	-51.80
3	205.23	32.59	-95.26	-62.67	-13	-49.67
4	296.34	35.83	-95.26	-59.43	-13	-46.43
5	406.51	37.68	-95.26	-57.58	-13	-44.58
6	645.83	36.56	-95.26	-58.70	-13	-45.70

Antenna Polarity & Test Distance: Vertical at 3 M

No.	Freq. (MHz)	Reading (dB μ V/m)	Correction Factor (dB)	Emission Value (dBm)	Limit (dBm)	Margin (dB)
1	83.97	29.3	-95.26	-65.96	-13	-52.96
2	154.45	32	-95.26	-63.26	-13	-50.26
3	199.99	31.67	-95.26	-63.59	-13	-50.59
4	293.4	36.7	-95.26	-58.56	-13	-45.56
5	405.61	33.68	-95.26	-61.58	-13	-48.58
6	658.48	35.25	-95.26	-60.01	-13	-47.01

Remarks:

1. Follow ANSI 63.26 section 5.2.7 d), Emission Value (dBm) = E (dB μ V/m) - Correction Factor @ 3m.
2. Correction Factor (dB) = $20\log(D) - 104.8$; where D is the measurement distance @ 3m.

LTE Band 4: 15MHz

Mode	TX channel 20025	Frequency Range	Below 1000 MHz
------	------------------	-----------------	----------------

Antenna Polarity & Test Distance: Horizontal at 3 M

No.	Freq. (MHz)	Reading (dB μ V/m)	Correction Factor (dB)	Emission Value (dBm)	Limit (dBm)	Margin (dB)
1	74.1	27.21	-95.26	-68.05	-13	-55.05
2	149.43	31.04	-95.26	-64.22	-13	-51.22
3	205.46	32.19	-95.26	-63.07	-13	-50.07
4	296.2	35.07	-95.26	-60.19	-13	-47.19
5	406.66	37.45	-95.26	-57.81	-13	-44.81
6	646.3	37.15	-95.26	-58.11	-13	-45.11

Antenna Polarity & Test Distance: Vertical at 3 M

No.	Freq. (MHz)	Reading (dB μ V/m)	Correction Factor (dB)	Emission Value (dBm)	Limit (dBm)	Margin (dB)
1	84.14	29.38	-95.26	-65.88	-13	-52.88
2	154.91	31.71	-95.26	-63.55	-13	-50.55
3	200.63	31.7	-95.26	-63.56	-13	-50.56
4	293.22	36.9	-95.26	-58.36	-13	-45.36
5	404.95	34.22	-95.26	-61.04	-13	-48.04
6	658.9	35.82	-95.26	-59.44	-13	-46.44

Remarks:

1. Follow ANSI 63.26 section 5.2.7 d), Emission Value (dBm) = E (dB μ V/m) - Correction Factor @ 3m.
2. Correction Factor (dB) = $20\log(D) - 104.8$; where D is the measurement distance @ 3m.

Mode	TX channel 20175	Frequency Range	Below 1000 MHz
------	------------------	-----------------	----------------

Antenna Polarity & Test Distance: Horizontal at 3 M

No.	Freq. (MHz)	Reading (dB μ V/m)	Correction Factor (dB)	Emission Value (dBm)	Limit (dBm)	Margin (dB)
1	74.34	27.34	-95.26	-67.92	-13	-54.92
2	149.96	31.01	-95.26	-64.25	-13	-51.25
3	205	32.33	-95.26	-62.93	-13	-49.93
4	296.13	35.26	-95.26	-60.00	-13	-47.00
5	406.56	37.54	-95.26	-57.72	-13	-44.72
6	645.69	36.95	-95.26	-58.31	-13	-45.31

Antenna Polarity & Test Distance: Vertical at 3 M

No.	Freq. (MHz)	Reading (dB μ V/m)	Correction Factor (dB)	Emission Value (dBm)	Limit (dBm)	Margin (dB)
1	83.54	28.85	-95.26	-66.41	-13	-53.41
2	155.13	32.18	-95.26	-63.08	-13	-50.08
3	199.77	31.52	-95.26	-63.74	-13	-50.74
4	293.58	37.43	-95.26	-57.83	-13	-44.83
5	405.74	33.91	-95.26	-61.35	-13	-48.35
6	659.07	35.3	-95.26	-59.96	-13	-46.96

Remarks:

1. Follow ANSI 63.26 section 5.2.7 d), Emission Value (dBm) = E (dB μ V/m) - Correction Factor @ 3m.
2. Correction Factor (dB) = $20\log(D) - 104.8$; where D is the measurement distance @ 3m.

Mode	TX channel 20325	Frequency Range	Below 1000 MHz
------	------------------	-----------------	----------------

Antenna Polarity & Test Distance: Horizontal at 3 M

No.	Freq. (MHz)	Reading (dB μ V/m)	Correction Factor (dB)	Emission Value (dBm)	Limit (dBm)	Margin (dB)
1	73.69	27.32	-95.26	-67.94	-13	-54.94
2	150.2	30.42	-95.26	-64.84	-13	-51.84
3	205.32	31.82	-95.26	-63.44	-13	-50.44
4	296.15	35.59	-95.26	-59.67	-13	-46.67
5	406.51	37.02	-95.26	-58.24	-13	-45.24
6	645.58	37.22	-95.26	-58.04	-13	-45.04

Antenna Polarity & Test Distance: Vertical at 3 M

No.	Freq. (MHz)	Reading (dB μ V/m)	Correction Factor (dB)	Emission Value (dBm)	Limit (dBm)	Margin (dB)
1	84.15	28.79	-95.26	-66.47	-13	-53.47
2	154.47	31.49	-95.26	-63.77	-13	-50.77
3	200.7	31.06	-95.26	-64.20	-13	-51.20
4	293.19	36.98	-95.26	-58.28	-13	-45.28
5	405.2	34.24	-95.26	-61.02	-13	-48.02
6	658.51	35.58	-95.26	-59.68	-13	-46.68

Remarks:

1. Follow ANSI 63.26 section 5.2.7 d), Emission Value (dBm) = E (dB μ V/m) - Correction Factor @ 3m.
2. Correction Factor (dB) = 20log(D) - 104.8; where D is the measurement distance @ 3m.

LTE Band 4: 20MHz

Mode	TX channel 20050	Frequency Range	Below 1000 MHz
------	------------------	-----------------	----------------

Antenna Polarity & Test Distance: Horizontal at 3 M

No.	Freq. (MHz)	Reading (dB μ V/m)	Correction Factor (dB)	Emission Value (dBm)	Limit (dBm)	Margin (dB)
1	73.54	27.03	-95.26	-68.23	-13	-55.23
2	150.04	31.04	-95.26	-64.22	-13	-51.22
3	205.59	32.5	-95.26	-62.76	-13	-49.76
4	296.23	35	-95.26	-60.26	-13	-47.26
5	406.47	36.9	-95.26	-58.36	-13	-45.36
6	645.53	37.26	-95.26	-58.00	-13	-45.00

Antenna Polarity & Test Distance: Vertical at 3 M

No.	Freq. (MHz)	Reading (dB μ V/m)	Correction Factor (dB)	Emission Value (dBm)	Limit (dBm)	Margin (dB)
1	83.73	28.63	-95.26	-66.63	-13	-53.63
2	154.76	31.87	-95.26	-63.39	-13	-50.39
3	200.65	31.2	-95.26	-64.06	-13	-51.06
4	293.98	37.21	-95.26	-58.05	-13	-45.05
5	405.23	33.84	-95.26	-61.42	-13	-48.42
6	658.29	35.82	-95.26	-59.44	-13	-46.44

Remarks:

1. Follow ANSI 63.26 section 5.2.7 d), Emission Value (dBm) = E (dB μ V/m) - Correction Factor @ 3m.
2. Correction Factor (dB) = 20log(D) - 104.8; where D is the measurement distance @ 3m.

Mode	TX channel 20175	Frequency Range	Below 1000 MHz
------	------------------	-----------------	----------------

Antenna Polarity & Test Distance: Horizontal at 3 M

No.	Freq. (MHz)	Reading (dB μ V/m)	Correction Factor (dB)	Emission Value (dBm)	Limit (dBm)	Margin (dB)
1	74.37	27.61	-95.26	-67.65	-13	-54.65
2	149.49	30.89	-95.26	-64.37	-13	-51.37
3	205.14	32.48	-95.26	-62.78	-13	-49.78
4	296.12	35.59	-95.26	-59.67	-13	-46.67
5	406.53	37.12	-95.26	-58.14	-13	-45.14
6	645.62	37.11	-95.26	-58.15	-13	-45.15

Antenna Polarity & Test Distance: Vertical at 3 M

No.	Freq. (MHz)	Reading (dB μ V/m)	Correction Factor (dB)	Emission Value (dBm)	Limit (dBm)	Margin (dB)
1	83.95	29.35	-95.26	-65.91	-13	-52.91
2	154.4	32.02	-95.26	-63.24	-13	-50.24
3	200.46	31.35	-95.26	-63.91	-13	-50.91
4	293.85	37.34	-95.26	-57.92	-13	-44.92
5	404.89	34.63	-95.26	-60.63	-13	-47.63
6	659.17	35.66	-95.26	-59.60	-13	-46.60

Remarks:

1. Follow ANSI 63.26 section 5.2.7 d), Emission Value (dBm) = E (dB μ V/m) - Correction Factor @ 3m.
2. Correction Factor (dB) = 20log(D) - 104.8; where D is the measurement distance @ 3m.

Mode	TX channel 20300	Frequency Range	Below 1000 MHz
------	------------------	-----------------	----------------

Antenna Polarity & Test Distance: Horizontal at 3 M

No.	Freq. (MHz)	Reading (dB μ V/m)	Correction Factor (dB)	Emission Value (dBm)	Limit (dBm)	Margin (dB)
1	73.51	27.47	-95.26	-67.79	-13	-54.79
2	149.47	30.12	-95.26	-65.14	-13	-52.14
3	204.91	32.73	-95.26	-62.53	-13	-49.53
4	296.79	35.81	-95.26	-59.45	-13	-46.45
5	406.25	37.42	-95.26	-57.84	-13	-44.84
6	645.66	37.49	-95.26	-57.77	-13	-44.77

Antenna Polarity & Test Distance: Vertical at 3 M

No.	Freq. (MHz)	Reading (dB μ V/m)	Correction Factor (dB)	Emission Value (dBm)	Limit (dBm)	Margin (dB)
1	83.3	28.6	-95.26	-66.66	-13	-53.66
2	154.29	32.4	-95.26	-62.86	-13	-49.86
3	199.96	31.2	-95.26	-64.06	-13	-51.06
4	293.87	37.63	-95.26	-57.63	-13	-44.63
5	405.41	34.32	-95.26	-60.94	-13	-47.94
6	658.58	35.35	-95.26	-59.91	-13	-46.91

Remarks:

1. Follow ANSI 63.26 section 5.2.7 d), Emission Value (dBm) = E (dB μ V/m) - Correction Factor @ 3m.
2. Correction Factor (dB) = $20\log(D) - 104.8$; where D is the measurement distance @ 3m.

LTE Band 12: 1.4MHz

Mode	TX channel 23017	Frequency Range	Below 1000 MHz
------	------------------	-----------------	----------------

Antenna Polarity & Test Distance: Horizontal at 3 M

No.	Freq. (MHz)	Reading (dB μ V/m)	Correction Factor (dB)	Emission Value (dBm)	Limit (dBm)	Margin (dB)
1	74.3	27.31	-95.26	-67.95	-13	-54.95
2	149.68	30.34	-95.26	-64.92	-13	-51.92
3	205.31	32.39	-95.26	-62.87	-13	-49.87
4	296.77	35.63	-95.26	-59.63	-13	-46.63
5	406.6	37.12	-95.26	-58.14	-13	-45.14
6	645.99	36.78	-95.26	-58.48	-13	-45.48

Antenna Polarity & Test Distance: Vertical at 3 M

No.	Freq. (MHz)	Reading (dB μ V/m)	Correction Factor (dB)	Emission Value (dBm)	Limit (dBm)	Margin (dB)
1	83.59	28.42	-95.26	-66.84	-13	-53.84
2	154.31	31.82	-95.26	-63.44	-13	-50.44
3	200.61	31	-95.26	-64.26	-13	-51.26
4	293.68	36.73	-95.26	-58.53	-13	-45.53
5	405.83	33.79	-95.26	-61.47	-13	-48.47
6	658.8	35.4	-95.26	-59.86	-13	-46.86

Remarks:

1. Follow ANSI 63.26 section 5.2.7 d), Emission Value (dBm) = E (dB μ V/m) - Correction Factor @ 3m.
2. Correction Factor (dB) = 20log(D) - 104.8; where D is the measurement distance @ 3m.

Mode	TX channel 23095	Frequency Range	Below 1000 MHz
------	------------------	-----------------	----------------

Antenna Polarity & Test Distance: Horizontal at 3 M

No.	Freq. (MHz)	Reading (dB μ V/m)	Correction Factor (dB)	Emission Value (dBm)	Limit (dBm)	Margin (dB)
1	74.23	27.22	-95.26	-68.04	-13	-55.04
2	149.46	30.69	-95.26	-64.57	-13	-51.57
3	205.11	31.8	-95.26	-63.46	-13	-50.46
4	296.63	35.93	-95.26	-59.33	-13	-46.33
5	406.84	37.66	-95.26	-57.60	-13	-44.60
6	645.64	37.43	-95.26	-57.83	-13	-44.83

Antenna Polarity & Test Distance: Vertical at 3 M

No.	Freq. (MHz)	Reading (dB μ V/m)	Correction Factor (dB)	Emission Value (dBm)	Limit (dBm)	Margin (dB)
1	83.91	28.77	-95.26	-66.49	-13	-53.49
2	155.12	32.37	-95.26	-62.89	-13	-49.89
3	200.69	31.87	-95.26	-63.39	-13	-50.39
4	293.09	37.36	-95.26	-57.90	-13	-44.90
5	405	33.74	-95.26	-61.52	-13	-48.52
6	658.52	35.17	-95.26	-60.09	-13	-47.09

Remarks:

1. Follow ANSI 63.26 section 5.2.7 d), Emission Value (dBm) = E (dB μ V/m) - Correction Factor @ 3m.
2. Correction Factor (dB) = 20log(D) - 104.8; where D is the measurement distance @ 3m.

Mode	TX channel 23173	Frequency Range	Below 1000 MHz
------	------------------	-----------------	----------------

Antenna Polarity & Test Distance: Horizontal at 3 M

No.	Freq. (MHz)	Reading (dB μ V/m)	Correction Factor (dB)	Emission Value (dBm)	Limit (dBm)	Margin (dB)
1	74.12	28.02	-95.26	-67.24	-13	-54.24
2	150	30.97	-95.26	-64.29	-13	-51.29
3	205.56	32.19	-95.26	-63.07	-13	-50.07
4	296.5	35.28	-95.26	-59.98	-13	-46.98
5	406.56	37.71	-95.26	-57.55	-13	-44.55
6	645.62	36.7	-95.26	-58.56	-13	-45.56

Antenna Polarity & Test Distance: Vertical at 3 M

No.	Freq. (MHz)	Reading (dB μ V/m)	Correction Factor (dB)	Emission Value (dBm)	Limit (dBm)	Margin (dB)
1	84.15	28.62	-95.26	-66.64	-13	-53.64
2	154.22	32.04	-95.26	-63.22	-13	-50.22
3	199.91	31.89	-95.26	-63.37	-13	-50.37
4	293.79	37.34	-95.26	-57.92	-13	-44.92
5	405.83	34	-95.26	-61.26	-13	-48.26
6	658.76	35.38	-95.26	-59.88	-13	-46.88

Remarks:

1. Follow ANSI 63.26 section 5.2.7 d), Emission Value (dBm) = E (dB μ V/m) - Correction Factor @ 3m.
2. Correction Factor (dB) = $20\log(D) - 104.8$; where D is the measurement distance @ 3m.

LTE Band 12: 3MHz

Mode	TX channel 23025	Frequency Range	Below 1000 MHz
------	------------------	-----------------	----------------

Antenna Polarity & Test Distance: Horizontal at 3 M

No.	Freq. (MHz)	Reading (dB μ V/m)	Correction Factor (dB)	Emission Value (dBm)	Limit (dBm)	Margin (dB)
1	73.95	27.14	-95.26	-68.12	-13	-55.12
2	149.45	30.77	-95.26	-64.49	-13	-51.49
3	204.8	32.23	-95.26	-63.03	-13	-50.03
4	296.46	35.43	-95.26	-59.83	-13	-46.83
5	406.68	37.35	-95.26	-57.91	-13	-44.91
6	645.79	37.38	-95.26	-57.88	-13	-44.88

Antenna Polarity & Test Distance: Vertical at 3 M

No.	Freq. (MHz)	Reading (dB μ V/m)	Correction Factor (dB)	Emission Value (dBm)	Limit (dBm)	Margin (dB)
1	83.57	29.09	-95.26	-66.17	-13	-53.17
2	154.73	31.77	-95.26	-63.49	-13	-50.49
3	200.11	31.25	-95.26	-64.01	-13	-51.01
4	293.3	37.09	-95.26	-58.17	-13	-45.17
5	405.1	34.24	-95.26	-61.02	-13	-48.02
6	659.01	35.42	-95.26	-59.84	-13	-46.84

Remarks:

1. Follow ANSI 63.26 section 5.2.7 d), Emission Value (dBm) = E (dB μ V/m) - Correction Factor @ 3m.
2. Correction Factor (dB) = 20log(D) - 104.8; where D is the measurement distance @ 3m.

Mode	TX channel 23095	Frequency Range	Below 1000 MHz
------	------------------	-----------------	----------------

Antenna Polarity & Test Distance: Horizontal at 3 M

No.	Freq. (MHz)	Reading (dB μ V/m)	Correction Factor (dB)	Emission Value (dBm)	Limit (dBm)	Margin (dB)
1	73.69	27.13	-95.26	-68.13	-13	-55.13
2	150.25	31.04	-95.26	-64.22	-13	-51.22
3	205.36	32.52	-95.26	-62.74	-13	-49.74
4	296.53	35.8	-95.26	-59.46	-13	-46.46
5	406.37	37.67	-95.26	-57.59	-13	-44.59
6	645.84	36.96	-95.26	-58.30	-13	-45.30

Antenna Polarity & Test Distance: Vertical at 3 M

No.	Freq. (MHz)	Reading (dB μ V/m)	Correction Factor (dB)	Emission Value (dBm)	Limit (dBm)	Margin (dB)
1	83.41	28.75	-95.26	-66.51	-13	-53.51
2	155.07	31.56	-95.26	-63.70	-13	-50.70
3	200.58	31.12	-95.26	-64.14	-13	-51.14
4	293.99	36.66	-95.26	-58.60	-13	-45.60
5	405.63	34.04	-95.26	-61.22	-13	-48.22
6	658.67	35.22	-95.26	-60.04	-13	-47.04

Remarks:

1. Follow ANSI 63.26 section 5.2.7 d), Emission Value (dBm) = E (dB μ V/m) - Correction Factor @ 3m.
2. Correction Factor (dB) = 20log(D) - 104.8; where D is the measurement distance @ 3m.

Mode	TX channel 23165	Frequency Range	Below 1000 MHz
------	------------------	-----------------	----------------

Antenna Polarity & Test Distance: Horizontal at 3 M

No.	Freq. (MHz)	Reading (dB μ V/m)	Correction Factor (dB)	Emission Value (dBm)	Limit (dBm)	Margin (dB)
1	73.88	28.01	-95.26	-67.25	-13	-54.25
2	150.32	30.78	-95.26	-64.48	-13	-51.48
3	205.12	31.85	-95.26	-63.41	-13	-50.41
4	296.22	35.05	-95.26	-60.21	-13	-47.21
5	406.11	36.88	-95.26	-58.38	-13	-45.38
6	646.37	37.26	-95.26	-58.00	-13	-45.00

Antenna Polarity & Test Distance: Vertical at 3 M

No.	Freq. (MHz)	Reading (dB μ V/m)	Correction Factor (dB)	Emission Value (dBm)	Limit (dBm)	Margin (dB)
1	84.16	29.14	-95.26	-66.12	-13	-53.12
2	155.13	31.6	-95.26	-63.66	-13	-50.66
3	200.38	31.35	-95.26	-63.91	-13	-50.91
4	293.21	37.27	-95.26	-57.99	-13	-44.99
5	405.78	34.45	-95.26	-60.81	-13	-47.81
6	659.03	35.7	-95.26	-59.56	-13	-46.56

Remarks:

1. Follow ANSI 63.26 section 5.2.7 d), Emission Value (dBm) = E (dB μ V/m) - Correction Factor @ 3m.
2. Correction Factor (dB) = $20\log(D) - 104.8$; where D is the measurement distance @ 3m.

LTE Band 12: 5MHz

Mode	TX channel 23035	Frequency Range	Below 1000 MHz
------	------------------	-----------------	----------------

Antenna Polarity & Test Distance: Horizontal at 3 M

No.	Freq. (MHz)	Reading (dB μ V/m)	Correction Factor (dB)	Emission Value (dBm)	Limit (dBm)	Margin (dB)
1	73.7	27.6	-95.26	-67.66	-13	-54.66
2	150.27	30.46	-95.26	-64.80	-13	-51.80
3	205.22	32.66	-95.26	-62.60	-13	-49.60
4	295.94	35.09	-95.26	-60.17	-13	-47.17
5	406.54	37.01	-95.26	-58.25	-13	-45.25
6	645.99	37.29	-95.26	-57.97	-13	-44.97

Antenna Polarity & Test Distance: Vertical at 3 M

No.	Freq. (MHz)	Reading (dB μ V/m)	Correction Factor (dB)	Emission Value (dBm)	Limit (dBm)	Margin (dB)
1	84.14	28.78	-95.26	-66.48	-13	-53.48
2	154.74	31.9	-95.26	-63.36	-13	-50.36
3	200.43	31.54	-95.26	-63.72	-13	-50.72
4	293.55	37.41	-95.26	-57.85	-13	-44.85
5	405.02	34.55	-95.26	-60.71	-13	-47.71
6	659.18	35.51	-95.26	-59.75	-13	-46.75

Remarks:

1. Follow ANSI 63.26 section 5.2.7 d), Emission Value (dBm) = E (dB μ V/m) - Correction Factor @ 3m.
2. Correction Factor (dB) = $20\log(D) - 104.8$; where D is the measurement distance @ 3m.

Mode	TX channel 23095	Frequency Range	Below 1000 MHz
------	------------------	-----------------	----------------

Antenna Polarity & Test Distance: Horizontal at 3 M

No.	Freq. (MHz)	Reading (dB μ V/m)	Correction Factor (dB)	Emission Value (dBm)	Limit (dBm)	Margin (dB)
1	74.38	27.84	-95.26	-67.42	-13	-54.42
2	150.34	31.02	-95.26	-64.24	-13	-51.24
3	204.94	31.86	-95.26	-63.40	-13	-50.40
4	296	35.57	-95.26	-59.69	-13	-46.69
5	406.27	37.7	-95.26	-57.56	-13	-44.56
6	646.01	36.75	-95.26	-58.51	-13	-45.51

Antenna Polarity & Test Distance: Vertical at 3 M

No.	Freq. (MHz)	Reading (dB μ V/m)	Correction Factor (dB)	Emission Value (dBm)	Limit (dBm)	Margin (dB)
1	83.27	28.92	-95.26	-66.34	-13	-53.34
2	154.52	32.2	-95.26	-63.06	-13	-50.06
3	199.95	31.44	-95.26	-63.82	-13	-50.82
4	293.16	37.19	-95.26	-58.07	-13	-45.07
5	405.02	34.3	-95.26	-60.96	-13	-47.96
6	658.82	35.64	-95.26	-59.62	-13	-46.62

Remarks:

1. Follow ANSI 63.26 section 5.2.7 d), Emission Value (dBm) = E (dB μ V/m) - Correction Factor @ 3m.
2. Correction Factor (dB) = 20log(D) - 104.8; where D is the measurement distance @ 3m.

Mode	TX channel 23155	Frequency Range	Below 1000 MHz
------	------------------	-----------------	----------------

Antenna Polarity & Test Distance: Horizontal at 3 M

No.	Freq. (MHz)	Reading (dB μ V/m)	Correction Factor (dB)	Emission Value (dBm)	Limit (dBm)	Margin (dB)
1	74.24	27.75	-95.26	-67.51	-13	-54.51
2	150.17	30.54	-95.26	-64.72	-13	-51.72
3	204.66	32.27	-95.26	-62.99	-13	-49.99
4	296.12	35.67	-95.26	-59.59	-13	-46.59
5	406.76	37.58	-95.26	-57.68	-13	-44.68
6	646.29	36.89	-95.26	-58.37	-13	-45.37

Antenna Polarity & Test Distance: Vertical at 3 M

No.	Freq. (MHz)	Reading (dB μ V/m)	Correction Factor (dB)	Emission Value (dBm)	Limit (dBm)	Margin (dB)
1	83.46	29.09	-95.26	-66.17	-13	-53.17
2	154.94	32.28	-95.26	-62.98	-13	-49.98
3	200.44	31.7	-95.26	-63.56	-13	-50.56
4	293.62	37.45	-95.26	-57.81	-13	-44.81
5	405.77	34.06	-95.26	-61.20	-13	-48.20
6	658.25	35.32	-95.26	-59.94	-13	-46.94

Remarks:

1. Follow ANSI 63.26 section 5.2.7 d), Emission Value (dBm) = E (dB μ V/m) - Correction Factor @ 3m.
2. Correction Factor (dB) = $20\log(D) - 104.8$; where D is the measurement distance @ 3m.

LTE Band 12: 10MHz

Mode	TX channel 23060	Frequency Range	Below 1000 MHz
------	------------------	-----------------	----------------

Antenna Polarity & Test Distance: Horizontal at 3 M

No.	Freq. (MHz)	Reading (dB μ V/m)	Correction Factor (dB)	Emission Value (dBm)	Limit (dBm)	Margin (dB)
1	74.32	27.51	-95.26	-67.75	-13	-54.75
2	149.81	30.76	-95.26	-64.50	-13	-51.50
3	205.34	32.11	-95.26	-63.15	-13	-50.15
4	296.24	35.96	-95.26	-59.30	-13	-46.30
5	407.02	37.01	-95.26	-58.25	-13	-45.25
6	645.67	36.85	-95.26	-58.41	-13	-45.41

Antenna Polarity & Test Distance: Vertical at 3 M

No.	Freq. (MHz)	Reading (dB μ V/m)	Correction Factor (dB)	Emission Value (dBm)	Limit (dBm)	Margin (dB)
1	83.93	28.59	-95.26	-66.67	-13	-53.67
2	154.19	31.64	-95.26	-63.62	-13	-50.62
3	200.31	31.13	-95.26	-64.13	-13	-51.13
4	293.64	36.83	-95.26	-58.43	-13	-45.43
5	405.32	33.79	-95.26	-61.47	-13	-48.47
6	658.3	35.79	-95.26	-59.47	-13	-46.47

Remarks:

1. Follow ANSI 63.26 section 5.2.7 d), Emission Value (dBm) = E (dB μ V/m) - Correction Factor @ 3m.
2. Correction Factor (dB) = $20\log(D) - 104.8$; where D is the measurement distance @ 3m.

Mode	TX channel 23095	Frequency Range	Below 1000 MHz
------	------------------	-----------------	----------------

Antenna Polarity & Test Distance: Horizontal at 3 M

No.	Freq. (MHz)	Reading (dB μ V/m)	Correction Factor (dB)	Emission Value (dBm)	Limit (dBm)	Margin (dB)
1	74.27	28	-95.26	-67.26	-13	-54.26
2	149.81	31.1	-95.26	-64.16	-13	-51.16
3	205.14	31.79	-95.26	-63.47	-13	-50.47
4	296.66	35.79	-95.26	-59.47	-13	-46.47
5	406.28	37.63	-95.26	-57.63	-13	-44.63
6	646.25	37.55	-95.26	-57.71	-13	-44.71

Antenna Polarity & Test Distance: Vertical at 3 M

No.	Freq. (MHz)	Reading (dB μ V/m)	Correction Factor (dB)	Emission Value (dBm)	Limit (dBm)	Margin (dB)
1	83.82	29.04	-95.26	-66.22	-13	-53.22
2	154.4	31.87	-95.26	-63.39	-13	-50.39
3	200.53	31.62	-95.26	-63.64	-13	-50.64
4	293.22	37.23	-95.26	-58.03	-13	-45.03
5	405.78	34.35	-95.26	-60.91	-13	-47.91
6	658.83	35.78	-95.26	-59.48	-13	-46.48

Remarks:

1. Follow ANSI 63.26 section 5.2.7 d), Emission Value (dBm) = E (dB μ V/m) - Correction Factor @ 3m.
2. Correction Factor (dB) = $20\log(D) - 104.8$; where D is the measurement distance @ 3m.

Mode	TX channel 23130	Frequency Range	Below 1000 MHz
------	------------------	-----------------	----------------

Antenna Polarity & Test Distance: Horizontal at 3 M

No.	Freq. (MHz)	Reading (dB μ V/m)	Correction Factor (dB)	Emission Value (dBm)	Limit (dBm)	Margin (dB)
1	74.27	27.57	-95.26	-67.69	-13	-54.69
2	150.21	30.54	-95.26	-64.72	-13	-51.72
3	205.29	32.52	-95.26	-62.74	-13	-49.74
4	296.68	35.15	-95.26	-60.11	-13	-47.11
5	406.62	37.67	-95.26	-57.59	-13	-44.59
6	646.27	36.78	-95.26	-58.48	-13	-45.48

Antenna Polarity & Test Distance: Vertical at 3 M

No.	Freq. (MHz)	Reading (dB μ V/m)	Correction Factor (dB)	Emission Value (dBm)	Limit (dBm)	Margin (dB)
1	83.37	29.09	-95.26	-66.17	-13	-53.17
2	154.27	31.62	-95.26	-63.64	-13	-50.64
3	200.3	30.93	-95.26	-64.33	-13	-51.33
4	293.13	36.93	-95.26	-58.33	-13	-45.33
5	405.15	34.64	-95.26	-60.62	-13	-47.62
6	658.45	35.7	-95.26	-59.56	-13	-46.56

Remarks:

1. Follow ANSI 63.26 section 5.2.7 d), Emission Value (dBm) = E (dB μ V/m) - Correction Factor @ 3m.
2. Correction Factor (dB) = $20\log(D) - 104.8$; where D is the measurement distance @ 3m.

ABOVE 1GHz

LTE Band 4: 1.4MHz

Mode	TX channel 19957	Frequency Range	Above 1000 MHz
------	------------------	-----------------	----------------

Antenna Polarity & Test Distance: Horizontal at 3 M

No.	Freq. (MHz)	Reading (dB μ V/m)	Correction Factor (dB)	Emission Value (dBm)	Limit (dBm)	Margin (dB)
1	3421.4	46.57	-95.26	-48.69	-13	-35.69
2	5132.1	45	-95.26	-50.26	-13	-37.26
3	6842.8	48.46	-95.26	-46.80	-13	-33.80
4	8553.5	50.06	-95.26	-45.20	-13	-32.20

Antenna Polarity & Test Distance: Vertical at 3 M

No.	Freq. (MHz)	Reading (dB μ V/m)	Correction Factor (dB)	Emission Value (dBm)	Limit (dBm)	Margin (dB)
1	3421.4	54.17	-95.26	-41.09	-13	-28.09
2	5132.1	44.43	-95.26	-50.83	-13	-37.83
3	6842.8	48.07	-95.26	-47.19	-13	-34.19
4	8553.5	51.35	-95.26	-43.91	-13	-30.91

Remarks:

1. Follow ANSI 63.26 section 5.2.7 d), Emission Value (dBm) = E (dB μ V/m) - Correction Factor @ 3m.
2. Correction Factor (dB) = 20log(D) - 104.8; where D is the measurement distance @ 3m.

Mode	TX channel 20175	Frequency Range	Above 1000 MHz
------	------------------	-----------------	----------------

Antenna Polarity & Test Distance: Horizontal at 3 M

No.	Freq. (MHz)	Reading (dB μ V/m)	Correction Factor (dB)	Emission Value (dBm)	Limit (dBm)	Margin (dB)
1	3465	45.96	-95.26	-49.30	-13	-36.30
2	5197.5	45.21	-95.26	-50.05	-13	-37.05
3	6930	48.62	-95.26	-46.64	-13	-33.64
4	8662.5	50.29	-95.26	-44.97	-13	-31.97

Antenna Polarity & Test Distance: Vertical at 3 M

No.	Freq. (MHz)	Reading (dB μ V/m)	Correction Factor (dB)	Emission Value (dBm)	Limit (dBm)	Margin (dB)
1	3465	53.65	-95.26	-41.61	-13	-28.61
2	5197.5	44.38	-95.26	-50.88	-13	-37.88
3	6930	47.34	-95.26	-47.92	-13	-34.92
4	8662.5	50.76	-95.26	-44.50	-13	-31.50

Remarks:

1. Follow ANSI 63.26 section 5.2.7 d), Emission Value (dBm) = E (dB μ V/m) - Correction Factor @ 3m.
2. Correction Factor (dB) = 20log(D) - 104.8; where D is the measurement distance @ 3m.

Mode	TX channel 20393	Frequency Range	Above 1000 MHz
------	------------------	-----------------	----------------

Antenna Polarity & Test Distance: Horizontal at 3 M

No.	Freq. (MHz)	Reading (dB μ V/m)	Correction Factor (dB)	Emission Value (dBm)	Limit (dBm)	Margin (dB)
1	3508.6	46.81	-95.26	-48.45	-13	-35.45
2	5262.9	44.75	-95.26	-50.51	-13	-37.51
3	7017.2	48.03	-95.26	-47.23	-13	-34.23
4	8771.5	50.77	-95.26	-44.49	-13	-31.49

Antenna Polarity & Test Distance: Vertical at 3 M

No.	Freq. (MHz)	Reading (dB μ V/m)	Correction Factor (dB)	Emission Value (dBm)	Limit (dBm)	Margin (dB)
1	3508.6	53.71	-95.26	-41.55	-13	-28.55
2	5262.9	43.73	-95.26	-51.53	-13	-38.53
3	7017.2	47.94	-95.26	-47.32	-13	-34.32
4	8771.5	51.05	-95.26	-44.21	-13	-31.21

Remarks:

1. Follow ANSI 63.26 section 5.2.7 d), Emission Value (dBm) = E (dB μ V/m) - Correction Factor @ 3m.
2. Correction Factor (dB) = 20log(D) - 104.8; where D is the measurement distance @ 3m.

LTE Band 4: 3MHz

Mode	TX channel 19965	Frequency Range	Above 1000 MHz
------	------------------	-----------------	----------------

Antenna Polarity & Test Distance: Horizontal at 3 M

No.	Freq. (MHz)	Reading (dB μ V/m)	Correction Factor (dB)	Emission Value (dBm)	Limit (dBm)	Margin (dB)
1	3423	46.2	-95.26	-49.06	-13	-36.06
2	5134.5	45.27	-95.26	-49.99	-13	-36.99
3	6846	48.26	-95.26	-47.00	-13	-34.00
4	8557.5	49.99	-95.26	-45.27	-13	-32.27

Antenna Polarity & Test Distance: Vertical at 3 M

No.	Freq. (MHz)	Reading (dB μ V/m)	Correction Factor (dB)	Emission Value (dBm)	Limit (dBm)	Margin (dB)
1	3423	53.66	-95.26	-41.60	-13	-28.60
2	5134.5	44.55	-95.26	-50.71	-13	-37.71
3	6846	47.57	-95.26	-47.69	-13	-34.69
4	8557.5	50.62	-95.26	-44.64	-13	-31.64

Remarks:

1. Follow ANSI 63.26 section 5.2.7 d), Emission Value (dBm) = E (dB μ V/m) - Correction Factor @ 3m.
2. Correction Factor (dB) = $20\log(D) - 104.8$; where D is the measurement distance @ 3m.

Mode	TX channel 20175	Frequency Range	Above 1000 MHz
------	------------------	-----------------	----------------

Antenna Polarity & Test Distance: Horizontal at 3 M

No.	Freq. (MHz)	Reading (dB μ V/m)	Correction Factor (dB)	Emission Value (dBm)	Limit (dBm)	Margin (dB)
1	3465	45.99	-95.26	-49.27	-13	-36.27
2	5197.5	45.35	-95.26	-49.91	-13	-36.91
3	6930	48.57	-95.26	-46.69	-13	-33.69
4	8662.5	50.18	-95.26	-45.08	-13	-32.08

Antenna Polarity & Test Distance: Vertical at 3 M

No.	Freq. (MHz)	Reading (dB μ V/m)	Correction Factor (dB)	Emission Value (dBm)	Limit (dBm)	Margin (dB)
1	3465	53.81	-95.26	-41.45	-13	-28.45
2	5197.5	44.4	-95.26	-50.86	-13	-37.86
3	6930	47.41	-95.26	-47.85	-13	-34.85
4	8662.5	51.02	-95.26	-44.24	-13	-31.24

Remarks:

1. Follow ANSI 63.26 section 5.2.7 d), Emission Value (dBm) = E (dB μ V/m) - Correction Factor @ 3m.
2. Correction Factor (dB) = 20log(D) - 104.8; where D is the measurement distance @ 3m.

Mode	TX channel 20385	Frequency Range	Above 1000 MHz
------	------------------	-----------------	----------------

Antenna Polarity & Test Distance: Horizontal at 3 M

No.	Freq. (MHz)	Reading (dB μ V/m)	Correction Factor (dB)	Emission Value (dBm)	Limit (dBm)	Margin (dB)
1	3507	46.45	-95.26	-48.81	-13	-35.81
2	5260.5	44.69	-95.26	-50.57	-13	-37.57
3	7014	48.01	-95.26	-47.25	-13	-34.25
4	8767.5	50.34	-95.26	-44.92	-13	-31.92

Antenna Polarity & Test Distance: Vertical at 3 M

No.	Freq. (MHz)	Reading (dB μ V/m)	Correction Factor (dB)	Emission Value (dBm)	Limit (dBm)	Margin (dB)
1	3507	53.92	-95.26	-41.34	-13	-28.34
2	5260.5	44.06	-95.26	-51.20	-13	-38.20
3	7014	47.26	-95.26	-48.00	-13	-35.00
4	8767.5	50.5	-95.26	-44.76	-13	-31.76

Remarks:

1. Follow ANSI 63.26 section 5.2.7 d), Emission Value (dBm) = E (dB μ V/m) - Correction Factor @ 3m.
2. Correction Factor (dB) = 20log(D) - 104.8; where D is the measurement distance @ 3m.

LTE Band 4: 5MHz

Mode	TX channel 19975	Frequency Range	Above 1000 MHz
------	------------------	-----------------	----------------

Antenna Polarity & Test Distance: Horizontal at 3 M

No.	Freq. (MHz)	Reading (dB μ V/m)	Correction Factor (dB)	Emission Value (dBm)	Limit (dBm)	Margin (dB)
1	3425	46.43	-95.26	-48.83	-13	-35.83
2	5137.5	45.02	-95.26	-50.24	-13	-37.24
3	6850	47.9	-95.26	-47.36	-13	-34.36
4	8562.5	50.83	-95.26	-44.43	-13	-31.43

Antenna Polarity & Test Distance: Vertical at 3 M

No.	Freq. (MHz)	Reading (dB μ V/m)	Correction Factor (dB)	Emission Value (dBm)	Limit (dBm)	Margin (dB)
1	3425	53.92	-95.26	-41.34	-13	-28.34
2	5137.5	43.89	-95.26	-51.37	-13	-38.37
3	6850	47.38	-95.26	-47.88	-13	-34.88
4	8562.5	51.24	-95.26	-44.02	-13	-31.02

Remarks:

1. Follow ANSI 63.26 section 5.2.7 d), Emission Value (dBm) = E (dB μ V/m) - Correction Factor @ 3m.
2. Correction Factor (dB) = $20\log(D) - 104.8$; where D is the measurement distance @ 3m.

Mode	TX channel 20175	Frequency Range	Above 1000 MHz
------	------------------	-----------------	----------------

Antenna Polarity & Test Distance: Horizontal at 3 M

No.	Freq. (MHz)	Reading (dB μ V/m)	Correction Factor (dB)	Emission Value (dBm)	Limit (dBm)	Margin (dB)
1	3465	46.66	-95.26	-48.60	-13	-35.60
2	5197.5	45.36	-95.26	-49.90	-13	-36.90
3	6930	48.28	-95.26	-46.98	-13	-33.98
4	8662.5	50.27	-95.26	-44.99	-13	-31.99

Antenna Polarity & Test Distance: Vertical at 3 M

No.	Freq. (MHz)	Reading (dB μ V/m)	Correction Factor (dB)	Emission Value (dBm)	Limit (dBm)	Margin (dB)
1	3465	54.3	-95.26	-40.96	-13	-27.96
2	5197.5	44.47	-95.26	-50.79	-13	-37.79
3	6930	47.19	-95.26	-48.07	-13	-35.07
4	8662.5	50.98	-95.26	-44.28	-13	-31.28

Remarks:

1. Follow ANSI 63.26 section 5.2.7 d), Emission Value (dBm) = E (dB μ V/m) - Correction Factor @ 3m.
2. Correction Factor (dB) = 20log(D) - 104.8; where D is the measurement distance @ 3m.

Mode	TX channel 20375	Frequency Range	Above 1000 MHz
------	------------------	-----------------	----------------

Antenna Polarity & Test Distance: Horizontal at 3 M

No.	Freq. (MHz)	Reading (dB μ V/m)	Correction Factor (dB)	Emission Value (dBm)	Limit (dBm)	Margin (dB)
1	3505	46.02	-95.26	-49.24	-13	-36.24
2	5257.5	45.15	-95.26	-50.11	-13	-37.11
3	7010	48.47	-95.26	-46.79	-13	-33.79
4	8762.5	50.45	-95.26	-44.81	-13	-31.81

Antenna Polarity & Test Distance: Vertical at 3 M

No.	Freq. (MHz)	Reading (dB μ V/m)	Correction Factor (dB)	Emission Value (dBm)	Limit (dBm)	Margin (dB)
1	3505	54.38	-95.26	-40.88	-13	-27.88
2	5257.5	44.09	-95.26	-51.17	-13	-38.17
3	7010	47.69	-95.26	-47.57	-13	-34.57
4	8762.5	50.85	-95.26	-44.41	-13	-31.41

Remarks:

1. Follow ANSI 63.26 section 5.2.7 d), Emission Value (dBm) = E (dB μ V/m) - Correction Factor @ 3m.
2. Correction Factor (dB) = 20log(D) - 104.8; where D is the measurement distance @ 3m.

LTE Band 4: 10MHz

Mode	TX channel 20000	Frequency Range	Above 1000 MHz
------	------------------	-----------------	----------------

Antenna Polarity & Test Distance: Horizontal at 3 M

No.	Freq. (MHz)	Reading (dB μ V/m)	Correction Factor (dB)	Emission Value (dBm)	Limit (dBm)	Margin (dB)
1	3430	46.06	-95.26	-49.20	-13	-36.20
2	5145	45.11	-95.26	-50.15	-13	-37.15
3	6860	47.85	-95.26	-47.41	-13	-34.41
4	8575	50.58	-95.26	-44.68	-13	-31.68

Antenna Polarity & Test Distance: Vertical at 3 M

No.	Freq. (MHz)	Reading (dB μ V/m)	Correction Factor (dB)	Emission Value (dBm)	Limit (dBm)	Margin (dB)
1	3430	53.56	-95.26	-41.70	-13	-28.70
2	5145	43.57	-95.26	-51.69	-13	-38.69
3	6860	47.3	-95.26	-47.96	-13	-34.96
4	8575	51.29	-95.26	-43.97	-13	-30.97

Remarks:

1. Follow ANSI 63.26 section 5.2.7 d), Emission Value (dBm) = E (dB μ V/m) - Correction Factor @ 3m.
2. Correction Factor (dB) = 20log(D) - 104.8; where D is the measurement distance @ 3m.

Mode	TX channel 20175	Frequency Range	Above 1000 MHz
------	------------------	-----------------	----------------

Antenna Polarity & Test Distance: Horizontal at 3 M

No.	Freq. (MHz)	Reading (dB μ V/m)	Correction Factor (dB)	Emission Value (dBm)	Limit (dBm)	Margin (dB)
1	3465	46.3	-95.26	-48.96	-13	-35.96
2	5197.5	44.76	-95.26	-50.50	-13	-37.50
3	6930	48.38	-95.26	-46.88	-13	-33.88
4	8662.5	50.79	-95.26	-44.47	-13	-31.47

Antenna Polarity & Test Distance: Vertical at 3 M

No.	Freq. (MHz)	Reading (dB μ V/m)	Correction Factor (dB)	Emission Value (dBm)	Limit (dBm)	Margin (dB)
1	3465	53.81	-95.26	-41.45	-13	-28.45
2	5197.5	44.48	-95.26	-50.78	-13	-37.78
3	6930	47.91	-95.26	-47.35	-13	-34.35
4	8662.5	50.44	-95.26	-44.82	-13	-31.82

Remarks:

1. Follow ANSI 63.26 section 5.2.7 d), Emission Value (dBm) = E (dB μ V/m) - Correction Factor @ 3m.
2. Correction Factor (dB) = 20log(D) - 104.8; where D is the measurement distance @ 3m.

Mode	TX channel 20350	Frequency Range	Above 1000 MHz
------	------------------	-----------------	----------------

Antenna Polarity & Test Distance: Horizontal at 3 M

No.	Freq. (MHz)	Reading (dB μ V/m)	Correction Factor (dB)	Emission Value (dBm)	Limit (dBm)	Margin (dB)
1	3500	46.67	-95.26	-48.59	-13	-35.59
2	5250	45.02	-95.26	-50.24	-13	-37.24
3	7000	47.99	-95.26	-47.27	-13	-34.27
4	8750	50.76	-95.26	-44.50	-13	-31.50

Antenna Polarity & Test Distance: Vertical at 3 M

No.	Freq. (MHz)	Reading (dB μ V/m)	Correction Factor (dB)	Emission Value (dBm)	Limit (dBm)	Margin (dB)
1	3500	53.86	-95.26	-41.40	-13	-28.40
2	5250	43.83	-95.26	-51.43	-13	-38.43
3	7000	47.69	-95.26	-47.57	-13	-34.57
4	8750	50.9	-95.26	-44.36	-13	-31.36

Remarks:

1. Follow ANSI 63.26 section 5.2.7 d), Emission Value (dBm) = E (dB μ V/m) - Correction Factor @ 3m.
2. Correction Factor (dB) = 20log(D) - 104.8; where D is the measurement distance @ 3m.

LTE Band 4: 15MHz

Mode	TX channel 20025	Frequency Range	Above 1000 MHz
------	------------------	-----------------	----------------

Antenna Polarity & Test Distance: Horizontal at 3 M

No.	Freq. (MHz)	Reading (dB μ V/m)	Correction Factor (dB)	Emission Value (dBm)	Limit (dBm)	Margin (dB)
1	3435	46.68	-95.26	-48.58	-13	-35.58
2	5152.5	44.76	-95.26	-50.50	-13	-37.50
3	6870	48.15	-95.26	-47.11	-13	-34.11
4	8587.5	50.82	-95.26	-44.44	-13	-31.44

Antenna Polarity & Test Distance: Vertical at 3 M

No.	Freq. (MHz)	Reading (dB μ V/m)	Correction Factor (dB)	Emission Value (dBm)	Limit (dBm)	Margin (dB)
1	3435	54.3	-95.26	-40.96	-13	-27.96
2	5152.5	44.31	-95.26	-50.95	-13	-37.95
3	6870	47.36	-95.26	-47.90	-13	-34.90
4	8587.5	51.33	-95.26	-43.93	-13	-30.93

Remarks:

1. Follow ANSI 63.26 section 5.2.7 d), Emission Value (dBm) = E (dB μ V/m) - Correction Factor @ 3m.
2. Correction Factor (dB) = $20\log(D) - 104.8$; where D is the measurement distance @ 3m.

Mode	TX channel 20175	Frequency Range	Above 1000 MHz
------	------------------	-----------------	----------------

Antenna Polarity & Test Distance: Horizontal at 3 M

No.	Freq. (MHz)	Reading (dB μ V/m)	Correction Factor (dB)	Emission Value (dBm)	Limit (dBm)	Margin (dB)
1	3465	46.74	-95.26	-48.52	-13	-35.52
2	5197.5	45.2	-95.26	-50.06	-13	-37.06
3	6930	48.06	-95.26	-47.20	-13	-34.20
4	8662.5	50.04	-95.26	-45.22	-13	-32.22

Antenna Polarity & Test Distance: Vertical at 3 M

No.	Freq. (MHz)	Reading (dB μ V/m)	Correction Factor (dB)	Emission Value (dBm)	Limit (dBm)	Margin (dB)
1	3465	54.48	-95.26	-40.78	-13	-27.78
2	5197.5	44.51	-95.26	-50.75	-13	-37.75
3	6930	47.77	-95.26	-47.49	-13	-34.49
4	8662.5	50.54	-95.26	-44.72	-13	-31.72

Remarks:

1. Follow ANSI 63.26 section 5.2.7 d), Emission Value (dBm) = E (dB μ V/m) - Correction Factor @ 3m.
2. Correction Factor (dB) = 20log(D) - 104.8; where D is the measurement distance @ 3m.

Mode	TX channel 20325	Frequency Range	Above 1000 MHz
------	------------------	-----------------	----------------

Antenna Polarity & Test Distance: Horizontal at 3 M

No.	Freq. (MHz)	Reading (dB μ V/m)	Correction Factor (dB)	Emission Value (dBm)	Limit (dBm)	Margin (dB)
1	3495	46.91	-95.26	-48.35	-13	-35.35
2	5242.5	44.83	-95.26	-50.43	-13	-37.43
3	6990	48.15	-95.26	-47.11	-13	-34.11
4	8737.5	50.71	-95.26	-44.55	-13	-31.55

Antenna Polarity & Test Distance: Vertical at 3 M

No.	Freq. (MHz)	Reading (dB μ V/m)	Correction Factor (dB)	Emission Value (dBm)	Limit (dBm)	Margin (dB)
1	3495	54.22	-95.26	-41.04	-13	-28.04
2	5242.5	43.82	-95.26	-51.44	-13	-38.44
3	6990	47.81	-95.26	-47.45	-13	-34.45
4	8737.5	50.58	-95.26	-44.68	-13	-31.68

Remarks:

1. Follow ANSI 63.26 section 5.2.7 d), Emission Value (dBm) = E (dB μ V/m) - Correction Factor @ 3m.
2. Correction Factor (dB) = 20log(D) - 104.8; where D is the measurement distance @ 3m.

LTE Band 4: 20MHz

Mode	TX channel 20050	Frequency Range	Above 1000 MHz
------	------------------	-----------------	----------------

Antenna Polarity & Test Distance: Horizontal at 3 M

No.	Freq. (MHz)	Reading (dB μ V/m)	Correction Factor (dB)	Emission Value (dBm)	Limit (dBm)	Margin (dB)
1	3440	46.67	-95.26	-48.59	-13	-35.59
2	5160	45.18	-95.26	-50.08	-13	-37.08
3	6880	48.43	-95.26	-46.83	-13	-33.83
4	8600	50.42	-95.26	-44.84	-13	-31.84

Antenna Polarity & Test Distance: Vertical at 3 M

No.	Freq. (MHz)	Reading (dB μ V/m)	Correction Factor (dB)	Emission Value (dBm)	Limit (dBm)	Margin (dB)
1	3440	53.84	-95.26	-41.42	-13	-28.42
2	5160	44.49	-95.26	-50.77	-13	-37.77
3	6880	47.88	-95.26	-47.38	-13	-34.38
4	8600	51.42	-95.26	-43.84	-13	-30.84

Remarks:

1. Follow ANSI 63.26 section 5.2.7 d), Emission Value (dBm) = E (dB μ V/m) - Correction Factor @ 3m.
2. Correction Factor (dB) = $20\log(D) - 104.8$; where D is the measurement distance @ 3m.

Mode	TX channel 20175	Frequency Range	Above 1000 MHz
------	------------------	-----------------	----------------

Antenna Polarity & Test Distance: Horizontal at 3 M

No.	Freq. (MHz)	Reading (dB μ V/m)	Correction Factor (dB)	Emission Value (dBm)	Limit (dBm)	Margin (dB)
1	3465	46.45	-95.26	-48.81	-13	-35.81
2	5197.5	44.89	-95.26	-50.37	-13	-37.37
3	6930	48.22	-95.26	-47.04	-13	-34.04
4	8662.5	50.57	-95.26	-44.69	-13	-31.69

Antenna Polarity & Test Distance: Vertical at 3 M

No.	Freq. (MHz)	Reading (dB μ V/m)	Correction Factor (dB)	Emission Value (dBm)	Limit (dBm)	Margin (dB)
1	3465	54.35	-95.26	-40.91	-13	-27.91
2	5197.5	44.37	-95.26	-50.89	-13	-37.89
3	6930	47.57	-95.26	-47.69	-13	-34.69
4	8662.5	51.25	-95.26	-44.01	-13	-31.01

Remarks:

1. Follow ANSI 63.26 section 5.2.7 d), Emission Value (dBm) = E (dB μ V/m) - Correction Factor @ 3m.
2. Correction Factor (dB) = 20log(D) - 104.8; where D is the measurement distance @ 3m.

Mode	TX channel 20300	Frequency Range	Above 1000 MHz
------	------------------	-----------------	----------------

Antenna Polarity & Test Distance: Horizontal at 3 M

No.	Freq. (MHz)	Reading (dB μ V/m)	Correction Factor (dB)	Emission Value (dBm)	Limit (dBm)	Margin (dB)
1	3490	46.04	-95.26	-49.22	-13	-36.22
2	5235	45.19	-95.26	-50.07	-13	-37.07
3	6980	48.45	-95.26	-46.81	-13	-33.81
4	8725	50.38	-95.26	-44.88	-13	-31.88

Antenna Polarity & Test Distance: Vertical at 3 M

No.	Freq. (MHz)	Reading (dB μ V/m)	Correction Factor (dB)	Emission Value (dBm)	Limit (dBm)	Margin (dB)
1	3490	54.39	-95.26	-40.87	-13	-27.87
2	5235	43.77	-95.26	-51.49	-13	-38.49
3	6980	47.3	-95.26	-47.96	-13	-34.96
4	8725	50.57	-95.26	-44.69	-13	-31.69

Remarks:

1. Follow ANSI 63.26 section 5.2.7 d), Emission Value (dBm) = E (dB μ V/m) - Correction Factor @ 3m.
2. Correction Factor (dB) = 20log(D) - 104.8; where D is the measurement distance @ 3m.

LTE Band 12: 1.4MHz

Mode	TX channel 23017	Frequency Range	Above 1000 MHz
------	------------------	-----------------	----------------

Antenna Polarity & Test Distance: Horizontal at 3 M

No.	Freq. (MHz)	Reading (dB μ V/m)	Correction Factor (dB)	Emission Value (dBm)	Limit (dBm)	Margin (dB)
1	1399.4	46.95	-95.26	-48.31	-13	-35.31
2	2099.1	43.71	-95.26	-51.55	-13	-38.55
3	2798.8	48.53	-95.26	-46.73	-13	-33.73
4	3498.5	50.44	-95.26	-44.82	-13	-31.82

Antenna Polarity & Test Distance: Vertical at 3 M

No.	Freq. (MHz)	Reading (dB μ V/m)	Correction Factor (dB)	Emission Value (dBm)	Limit (dBm)	Margin (dB)
1	1399.4	53.81	-95.26	-41.45	-13	-28.45
2	2099.1	43.15	-95.26	-52.11	-13	-39.11
3	2798.8	47.48	-95.26	-47.78	-13	-34.78
4	3498.5	50.66	-95.26	-44.60	-13	-31.60

Remarks:

1. Follow ANSI 63.26 section 5.2.7 d), Emission Value (dBm) = E (dB μ V/m) - Correction Factor @ 3m.
2. Correction Factor (dB) = $20\log(D) - 104.8$; where D is the measurement distance @ 3m.

Mode	TX channel 23095	Frequency Range	Above 1000 MHz
------	------------------	-----------------	----------------

Antenna Polarity & Test Distance: Horizontal at 3 M

No.	Freq. (MHz)	Reading (dB μ V/m)	Correction Factor (dB)	Emission Value (dBm)	Limit (dBm)	Margin (dB)
1	1415	46.97	-95.26	-48.29	-13	-35.29
2	2122.5	43.81	-95.26	-51.45	-13	-38.45
3	2830	48.91	-95.26	-46.35	-13	-33.35
4	3537.5	50.5	-95.26	-44.76	-13	-31.76

Antenna Polarity & Test Distance: Vertical at 3 M

No.	Freq. (MHz)	Reading (dB μ V/m)	Correction Factor (dB)	Emission Value (dBm)	Limit (dBm)	Margin (dB)
1	1415	54.03	-95.26	-41.23	-13	-28.23
2	2122.5	43.25	-95.26	-52.01	-13	-39.01
3	2830	47.68	-95.26	-47.58	-13	-34.58
4	3537.5	50.34	-95.26	-44.92	-13	-31.92

Remarks:

1. Follow ANSI 63.26 section 5.2.7 d), Emission Value (dBm) = E (dB μ V/m) - Correction Factor @ 3m.
2. Correction Factor (dB) = 20log(D) - 104.8; where D is the measurement distance @ 3m.

Mode	TX channel 23173	Frequency Range	Above 1000 MHz
------	------------------	-----------------	----------------

Antenna Polarity & Test Distance: Horizontal at 3 M

No.	Freq. (MHz)	Reading (dB μ V/m)	Correction Factor (dB)	Emission Value (dBm)	Limit (dBm)	Margin (dB)
1	1430.6	46.58	-95.26	-48.68	-13	-35.68
2	2145.9	43.33	-95.26	-51.93	-13	-38.93
3	2861.2	48.69	-95.26	-46.57	-13	-33.57
4	3576.5	50.47	-95.26	-44.79	-13	-31.79

Antenna Polarity & Test Distance: Vertical at 3 M

No.	Freq. (MHz)	Reading (dB μ V/m)	Correction Factor (dB)	Emission Value (dBm)	Limit (dBm)	Margin (dB)
1	1430.6	54.11	-95.26	-41.15	-13	-28.15
2	2145.9	42.97	-95.26	-52.29	-13	-39.29
3	2861.2	47.26	-95.26	-48.00	-13	-35.00
4	3576.5	50.56	-95.26	-44.70	-13	-31.70

Remarks:

1. Follow ANSI 63.26 section 5.2.7 d), Emission Value (dBm) = E (dB μ V/m) - Correction Factor @ 3m.
2. Correction Factor (dB) = 20log(D) - 104.8; where D is the measurement distance @ 3m.

LTE Band 12: 3MHz

Mode	TX channel 23025	Frequency Range	Above 1000 MHz
------	------------------	-----------------	----------------

Antenna Polarity & Test Distance: Horizontal at 3 M

No.	Freq. (MHz)	Reading (dB μ V/m)	Correction Factor (dB)	Emission Value (dBm)	Limit (dBm)	Margin (dB)
1	1401	46.48	-95.26	-48.78	-13	-35.78
2	2101.5	43.8	-95.26	-51.46	-13	-38.46
3	2802	48.08	-95.26	-47.18	-13	-34.18
4	3502.5	50.59	-95.26	-44.67	-13	-31.67

Antenna Polarity & Test Distance: Vertical at 3 M

No.	Freq. (MHz)	Reading (dB μ V/m)	Correction Factor (dB)	Emission Value (dBm)	Limit (dBm)	Margin (dB)
1	1401	54.15	-95.26	-41.11	-13	-28.11
2	2101.5	42.66	-95.26	-52.60	-13	-39.60
3	2802	47.49	-95.26	-47.77	-13	-34.77
4	3502.5	50.43	-95.26	-44.83	-13	-31.83

Remarks:

1. Follow ANSI 63.26 section 5.2.7 d), Emission Value (dBm) = E (dB μ V/m) - Correction Factor @ 3m.
2. Correction Factor (dB) = $20\log(D) - 104.8$; where D is the measurement distance @ 3m.

Mode	TX channel 23095	Frequency Range	Above 1000 MHz
------	------------------	-----------------	----------------

Antenna Polarity & Test Distance: Horizontal at 3 M

No.	Freq. (MHz)	Reading (dB μ V/m)	Correction Factor (dB)	Emission Value (dBm)	Limit (dBm)	Margin (dB)
1	1415	46.9	-95.26	-48.36	-13	-35.36
2	2122.5	43.61	-95.26	-51.65	-13	-38.65
3	2830	48.85	-95.26	-46.41	-13	-33.41
4	3537.5	50.02	-95.26	-45.24	-13	-32.24

Antenna Polarity & Test Distance: Vertical at 3 M

No.	Freq. (MHz)	Reading (dB μ V/m)	Correction Factor (dB)	Emission Value (dBm)	Limit (dBm)	Margin (dB)
1	1415	53.34	-95.26	-41.92	-13	-28.92
2	2122.5	42.92	-95.26	-52.34	-13	-39.34
3	2830	47.47	-95.26	-47.79	-13	-34.79
4	3537.5	50.43	-95.26	-44.83	-13	-31.83

Remarks:

1. Follow ANSI 63.26 section 5.2.7 d), Emission Value (dBm) = E (dB μ V/m) - Correction Factor @ 3m.
2. Correction Factor (dB) = 20log(D) - 104.8; where D is the measurement distance @ 3m.

Mode	TX channel 23165	Frequency Range	Above 1000 MHz
------	------------------	-----------------	----------------

Antenna Polarity & Test Distance: Horizontal at 3 M

No.	Freq. (MHz)	Reading (dB μ V/m)	Correction Factor (dB)	Emission Value (dBm)	Limit (dBm)	Margin (dB)
1	1429	47.02	-95.26	-48.24	-13	-35.24
2	2143.5	43.83	-95.26	-51.43	-13	-38.43
3	2858	48.07	-95.26	-47.19	-13	-34.19
4	3572.5	49.97	-95.26	-45.29	-13	-32.29

Antenna Polarity & Test Distance: Vertical at 3 M

No.	Freq. (MHz)	Reading (dB μ V/m)	Correction Factor (dB)	Emission Value (dBm)	Limit (dBm)	Margin (dB)
1	1429	53.82	-95.26	-41.44	-13	-28.44
2	2143.5	42.65	-95.26	-52.61	-13	-39.61
3	2858	47.45	-95.26	-47.81	-13	-34.81
4	3572.5	50.24	-95.26	-45.02	-13	-32.02

Remarks:

1. Follow ANSI 63.26 section 5.2.7 d), Emission Value (dBm) = E (dB μ V/m) - Correction Factor @ 3m.
2. Correction Factor (dB) = 20log(D) - 104.8; where D is the measurement distance @ 3m.

LTE Band 12: 5MHz

Mode	TX channel 23035	Frequency Range	Above 1000 MHz
------	------------------	-----------------	----------------

Antenna Polarity & Test Distance: Horizontal at 3 M

No.	Freq. (MHz)	Reading (dB μ V/m)	Correction Factor (dB)	Emission Value (dBm)	Limit (dBm)	Margin (dB)
1	1403	47.3	-95.26	-47.96	-13	-34.96
2	2104.5	44.16	-95.26	-51.10	-13	-38.10
3	2806	48.28	-95.26	-46.98	-13	-33.98
4	3507.5	50.73	-95.26	-44.53	-13	-31.53

Antenna Polarity & Test Distance: Vertical at 3 M

No.	Freq. (MHz)	Reading (dB μ V/m)	Correction Factor (dB)	Emission Value (dBm)	Limit (dBm)	Margin (dB)
1	1403	54.07	-95.26	-41.19	-13	-28.19
2	2104.5	43.02	-95.26	-52.24	-13	-39.24
3	2806	47.45	-95.26	-47.81	-13	-34.81
4	3507.5	50.18	-95.26	-45.08	-13	-32.08

Remarks:

1. Follow ANSI 63.26 section 5.2.7 d), Emission Value (dBm) = E (dB μ V/m) - Correction Factor @ 3m.
2. Correction Factor (dB) = $20\log(D) - 104.8$; where D is the measurement distance @ 3m.

Mode	TX channel 23095	Frequency Range	Above 1000 MHz
------	------------------	-----------------	----------------

Antenna Polarity & Test Distance: Horizontal at 3 M

No.	Freq. (MHz)	Reading (dB μ V/m)	Correction Factor (dB)	Emission Value (dBm)	Limit (dBm)	Margin (dB)
1	1415	47.25	-95.26	-48.01	-13	-35.01
2	2122.5	43.97	-95.26	-51.29	-13	-38.29
3	2830	48.8	-95.26	-46.46	-13	-33.46
4	3537.5	50.83	-95.26	-44.43	-13	-31.43

Antenna Polarity & Test Distance: Vertical at 3 M

No.	Freq. (MHz)	Reading (dB μ V/m)	Correction Factor (dB)	Emission Value (dBm)	Limit (dBm)	Margin (dB)
1	1415	53.84	-95.26	-41.42	-13	-28.42
2	2122.5	43.19	-95.26	-52.07	-13	-39.07
3	2830	47.54	-95.26	-47.72	-13	-34.72
4	3537.5	50.99	-95.26	-44.27	-13	-31.27

Remarks:

1. Follow ANSI 63.26 section 5.2.7 d), Emission Value (dBm) = E (dB μ V/m) - Correction Factor @ 3m.
2. Correction Factor (dB) = 20log(D) - 104.8; where D is the measurement distance @ 3m.

Mode	TX channel 23155	Frequency Range	Above 1000 MHz
------	------------------	-----------------	----------------

Antenna Polarity & Test Distance: Horizontal at 3 M

No.	Freq. (MHz)	Reading (dB μ V/m)	Correction Factor (dB)	Emission Value (dBm)	Limit (dBm)	Margin (dB)
1	1427	46.87	-95.26	-48.39	-13	-35.39
2	2140.5	43.47	-95.26	-51.79	-13	-38.79
3	2854	48.06	-95.26	-47.20	-13	-34.20
4	3567.5	50.46	-95.26	-44.80	-13	-31.80

Antenna Polarity & Test Distance: Vertical at 3 M

No.	Freq. (MHz)	Reading (dB μ V/m)	Correction Factor (dB)	Emission Value (dBm)	Limit (dBm)	Margin (dB)
1	1427	53.61	-95.26	-41.65	-13	-28.65
2	2140.5	43.13	-95.26	-52.13	-13	-39.13
3	2854	47.28	-95.26	-47.98	-13	-34.98
4	3567.5	50.72	-95.26	-44.54	-13	-31.54

Remarks:

1. Follow ANSI 63.26 section 5.2.7 d), Emission Value (dBm) = E (dB μ V/m) - Correction Factor @ 3m.
2. Correction Factor (dB) = $20\log(D) - 104.8$; where D is the measurement distance @ 3m.

LTE Band 12: 10MHz

Mode	TX channel 23060	Frequency Range	Above 1000 MHz
------	------------------	-----------------	----------------

Antenna Polarity & Test Distance: Horizontal at 3 M

No.	Freq. (MHz)	Reading (dB μ V/m)	Correction Factor (dB)	Emission Value (dBm)	Limit (dBm)	Margin (dB)
1	1408	46.51	-95.26	-48.75	-13	-35.75
2	2112	44.06	-95.26	-51.20	-13	-38.20
3	2816	48.79	-95.26	-46.47	-13	-33.47
4	3520	50.28	-95.26	-44.98	-13	-31.98

Antenna Polarity & Test Distance: Vertical at 3 M

No.	Freq. (MHz)	Reading (dB μ V/m)	Correction Factor (dB)	Emission Value (dBm)	Limit (dBm)	Margin (dB)
1	1408	54.23	-95.26	-41.03	-13	-28.03
2	2112	43.23	-95.26	-52.03	-13	-39.03
3	2816	47.43	-95.26	-47.83	-13	-34.83
4	3520	51.12	-95.26	-44.14	-13	-31.14

Remarks:

1. Follow ANSI 63.26 section 5.2.7 d), Emission Value (dBm) = E (dB μ V/m) - Correction Factor @ 3m.
2. Correction Factor (dB) = $20\log(D) - 104.8$; where D is the measurement distance @ 3m.

Mode	TX channel 23095	Frequency Range	Above 1000 MHz
------	------------------	-----------------	----------------

Antenna Polarity & Test Distance: Horizontal at 3 M

No.	Freq. (MHz)	Reading (dB μ V/m)	Correction Factor (dB)	Emission Value (dBm)	Limit (dBm)	Margin (dB)
1	1415	46.83	-95.26	-48.43	-13	-35.43
2	2122.5	43.41	-95.26	-51.85	-13	-38.85
3	2830	48.06	-95.26	-47.20	-13	-34.20
4	3537.5	50.83	-95.26	-44.43	-13	-31.43

Antenna Polarity & Test Distance: Vertical at 3 M

No.	Freq. (MHz)	Reading (dB μ V/m)	Correction Factor (dB)	Emission Value (dBm)	Limit (dBm)	Margin (dB)
1	1415	53.63	-95.26	-41.63	-13	-28.63
2	2122.5	43.51	-95.26	-51.75	-13	-38.75
3	2830	47.87	-95.26	-47.39	-13	-34.39
4	3537.5	50.26	-95.26	-45.00	-13	-32.00

Remarks:

1. Follow ANSI 63.26 section 5.2.7 d), Emission Value (dBm) = E (dB μ V/m) - Correction Factor @ 3m.
2. Correction Factor (dB) = 20log(D) - 104.8; where D is the measurement distance @ 3m.

Mode	TX channel 23130	Frequency Range	Above 1000 MHz
------	------------------	-----------------	----------------

Antenna Polarity & Test Distance: Horizontal at 3 M

No.	Freq. (MHz)	Reading (dB μ V/m)	Correction Factor (dB)	Emission Value (dBm)	Limit (dBm)	Margin (dB)
1	1422	46.46	-95.26	-48.80	-13	-35.80
2	2133	43.95	-95.26	-51.31	-13	-38.31
3	2844	48.52	-95.26	-46.74	-13	-33.74
4	3555	50.39	-95.26	-44.87	-13	-31.87

Antenna Polarity & Test Distance: Vertical at 3 M

No.	Freq. (MHz)	Reading (dB μ V/m)	Correction Factor (dB)	Emission Value (dBm)	Limit (dBm)	Margin (dB)
1	1422	53.32	-95.26	-41.94	-13	-28.94
2	2133	43.31	-95.26	-51.95	-13	-38.95
3	2844	47.37	-95.26	-47.89	-13	-34.89
4	3555	51.07	-95.26	-44.19	-13	-31.19

Remarks:

1. Follow ANSI 63.26 section 5.2.7 d), Emission Value (dBm) = E (dB μ V/m) - Correction Factor @ 3m.
2. Correction Factor (dB) = 20log(D) - 104.8; where D is the measurement distance @ 3m.

5 Pictures of Test Arrangements

Please refer to the attached file (Test Setup Photo).

Appendix – Information of the Testing Laboratories

We, Bureau Veritas Consumer Products Services (H.K.) Ltd., Taoyuan Branch, were founded in 1988 to provide our best service in EMC, Radio, Telecom and Safety consultation. Our laboratories are accredited and approved according to ISO/IEC 17025.

If you have any comments, please feel free to contact us at the following:

Lin Kou EMC/RF Lab

Tel: 886-2-26052180

Fax: 886-2-26051924

Hsin Chu EMC/RF Lab/Telecom Lab

Tel: 886-3-6668565

Fax: 886-3-6668323

Hwa Ya EMC/RF/Safety

Tel: 886-3-3183232

Fax: 886-3-3270892

Email: service.adt@tw.bureauveritas.com

Web Site: www.bureauveritas-adt.com

The address and road map of all our labs can be found in our web site also.

--- END ---