

FCC Test Report (PART 22)

Report No.: RF200630E06-5

FCC ID: MQT-AT100R6

Test Model: xCL_AT-100-R6-18U

Received Date: June 22, 2020

Test Date: July 10 to 19, 2020

Issued Date: Oct. 08, 2021

Applicant: XAC AUTOMATION CORP.

Address: 4F, No. 30, INDUSTRY E. RD. IX, SCIENCE-BASED INDUSTRIAL
PARK,HSINCHU,TAIWAN

Issued By: Bureau Veritas Consumer Products Services (H.K.) Ltd., Taoyuan Branch
Hsin Chu Laboratory

Lab Address: E-2, No.1, Li Hsin 1st Road, Hsinchu Science Park, Hsinchu City 300,
Taiwan

Test Location: E-2, No.1, Li Hsin 1st Road, Hsinchu Science Park, Hsinchu City 300,
Taiwan

**FCC Registration /
Designation Number:** 723255 / TW2022



This report is for your exclusive use. Any copying or replication of this report to or for any other person or entity, or use of our name or trademark, is permitted only with our prior written permission. This report sets forth our findings solely with respect to the test samples identified herein. The results set forth in this report are not indicative or representative of the quality or characteristics of the lot from which a test sample was taken or any similar or identical product unless specifically and expressly noted. Our report includes all of the tests requested by you and the results thereof based upon the information that you provided to us. You have 60 days from date of issuance of this report to notify us of any material error or omission caused by our negligence, provided, however, that such notice shall be in writing and shall specifically address the issue you wish to raise. A failure to raise such issue within the prescribed time shall constitute your unqualified acceptance of the completeness of this report, the tests conducted and the correctness of the report contents. Unless specific mention, the uncertainty of measurement has been explicitly taken into account to declare the compliance or non-compliance to the specification.

Table of Contents

Release Control Record	4
1 Certificate of Conformity	5
2 Summary of Test Results	6
2.1 Measurement Uncertainty	6
2.2 Test Site and Instruments	7
3 General Information	9
3.1 General Description of EUT	9
3.2 Configuration of System under Test	11
3.2.1 Description of Support Units	12
3.3 Test Mode Applicability and Tested Channel Detail	13
3.4 EUT Operating Conditions	13
3.5 General Description of Applied Standards and references	14
4 Test Types and Results	15
4.1 Output Power Measurement	15
4.1.1 Limits of Output Power Measurement	15
4.1.2 Test Procedures	15
4.1.3 Test Setup	15
4.1.4 Test Results	16
4.2 Modulation Characteristics Measurement	17
4.2.1 Limits of Modulation Characteristics	17
4.2.2 Test Procedure	17
4.2.3 Test Setup	17
4.2.4 Test Results	18
4.3 Frequency Stability Measurement	19
4.3.1 Limits of Frequency Stability Measurement	19
4.3.2 Test Procedure	19
4.3.3 Test Setup	19
4.3.4 Test Results	20
4.4 Occupied Bandwidth Measurement	21
4.4.1 Test Procedure	21
4.4.2 Test Setup	21
4.4.3 Test Result (-26dB Bandwidth)	22
4.4.4 Test Result (Occupied Bandwidth)	23
4.5 Band Edge Measurement	24
4.5.1 Limits of Band Edge Measurement	24
4.5.2 Test Setup	24
4.5.3 Test Procedures	24
4.5.4 Test Results	25
4.6 Peak to Average Ratio	26
4.5.1 Limits of Peak to Average Ratio Measurement	26
4.5.2 Test Setup	26
4.5.3 Test Procedures	26
4.5.4 Test Results	27
4.7 Conducted Spurious Emissions	28
4.7.1 Limits of Conducted Spurious Emissions Measurement	28
4.7.2 Test Setup	28
4.7.3 Test Procedure	28
4.7.4 Test Results	29
4.8 Radiated Emission Measurement	30
4.8.1 Limits of Radiated Emission Measurement	30
4.8.2 Test Procedure	30
4.8.3 Deviation from Test Standard	30
4.8.4 Test Setup	31

4.8.5 Test Results	32
5 Pictures of Test Arrangements.....	38
Appendix – Information of the Testing Laboratories	39

Release Control Record

Issue No.	Description	Date Issued
RF200630E06-5	Original release.	Oct. 08, 2021

1 Certificate of Conformity

Product: Terminal

Brand: XAC

Test Model: xCL_AT-100-R6-18U

Sample Status: ENGINEERING SAMPLE

Applicant: XAC AUTOMATION CORP.

Test Date: July 10 to 19, 2020

Standards: FCC Part 22, Subpart H

The above equipment has been tested by **Bureau Veritas Consumer Products Services (H.K.) Ltd., Taoyuan Branch**, and found compliance with the requirement of the above standards. The test record, data evaluation & Equipment Under Test (EUT) configurations represented herein are true and accurate accounts of the measurements of the sample's EMC characteristics under the conditions specified in this report.

Prepared by :  _____, **Date:** _____ Oct. 08, 2021
Claire Kuan / Specialist

Approved by :  _____, **Date:** _____ Oct. 08, 2021
Clark Lin / Technical Manager

2 Summary of Test Results

Applied Standard: FCC Part 22 & Part 2			
FCC Clause	Test Item	Result	Remarks
2.1046 22.913 (a)	Effective radiated power	PASS	Meet the requirement of limit.
22.913(d)	Peak to Average Ratio	PASS	Meet the requirement of limit.
2.1047	Modulation characteristics	PASS	Meet the requirement
2.1055 22.355	Frequency Stability	PASS	Meet the requirement of limit.
2.1049	Occupied Bandwidth	PASS	Meet the requirement of limit.
22.917	Band Edge Measurements	PASS	Meet the requirement of limit.
2.1051 22.917	Conducted Spurious Emissions	PASS	Meet the requirement of limit.
2.1053 22.917	Radiated Spurious Emissions	PASS	Meet the requirement of limit. Minimum passing margin is -27.14 dB at 1652.8 MHz.

Note: Determining compliance based on the results of the compliance measurement, not taking into account measurement instrumentation uncertainty.

2.1 Measurement Uncertainty

Where relevant, the following measurement uncertainty levels have been estimated for tests performed on the EUT as specified in CISPR 16-4-2:

Measurement	Frequency	Expanded Uncertainty (k=2) (\pm)
Radiated Emissions up to 1 GHz	9kHz ~ 30MHz	3.1 dB
	30MHz ~ 1GHz	5.1 dB
Radiated Emissions above 1 GHz	1GHz ~ 18GHz	5.1 dB
	18GHz ~ 40GHz	5.3 dB

2.2 Test Site and Instruments

For radiated spurious emissions test:

DESCRIPTION & MANUFACTURER	MODEL NO.	SERIAL NO.	CALIBRATED DATE	CALIBRATED UNTIL
Test Receiver R&S	ESR7	102026	Apr. 22, 2020	Apr. 21, 2021
Spectrum Analyzer Keysight	N9030B	MY57141948	May 22, 2020	May 21, 2021
Pre-Amplifier EMCI	EMC001340	980142	May 25, 2020	May 24, 2021
Loop Antenna Electro-Metrics	EM-6879	264	Feb. 18, 2020	Feb. 17, 2021
RF Cable	NA	LOOPCAB-001	Jan. 08, 2020	Jan. 07, 2021
RF Cable	NA	LOOPCAB-002	Jan. 08, 2020	Jan. 07, 2021
Pre-Amplifier EMCI	EMC330N	980538	Apr. 28, 2020	Apr. 27, 2021
Trilog Broadband Antenna SCHWARZBECK	VULB9168	9168-0842	Nov. 08, 2019	Nov. 07, 2020
RF Cable	8D	966-5-1	Apr. 29, 2020	Apr. 28, 2021
RF Cable	8D	966-5-2	Apr. 29, 2020	Apr. 28, 2021
RF Cable	8D	966-5-3	Apr. 29, 2020	Apr. 28, 2021
Fixed attenuator Mini-Circuits	UNAT-5+	PAD-ATT5-02	Jan. 14, 2020	Jan. 13, 2021
Horn_Antenna SCHWARZBECK	BBHA 9120D	9120D-1819	Nov. 24, 2019	Nov. 23, 2020
Pre-Amplifier EMCI	EMC12630SE	980509	Apr. 29, 2020	Apr. 28, 2021
RF Cable EMCI	EMC104-SM-SM-1500	180503	Apr. 29, 2020	Apr. 28, 2021
RF Cable EMCI	EMC104-SM-SM-2000	180501	Apr. 29, 2020	Apr. 28, 2021
RF Cable EMCI	EMC104-SM-SM-6000	180506	Apr. 29, 2020	Apr. 28, 2021
Pre-Amplifier EMCI	EMC184045SE	980387	Jan. 15, 2020	Jan. 14, 2021
Horn_Antenna SCHWARZBECK	BBHA 9170	BBHA9170519	Nov. 24, 2019	Nov. 23, 2020
RF Cable	EMC102-KM-KM-1200	160924	Jan. 15, 2020	Jan. 14, 2021
RF Cable	EMC-KM-KM-4000	200214	Mar. 11, 2020	Mar. 10, 2021
Software	ADT_Radiated_V8.7.08	NA	NA	NA
Boresight Antenna Tower & Turn Table Max-Full	MF-7802BS	MF780208530	NA	NA

Note:

1. The calibration interval of the above test instruments is 12 months and the calibrations are traceable to NML/ROC and NIST/USA.
2. The test was performed in 966 Chamber No. 5.
3. Tested Date: July 10, 2020

For other test items:

DESCRIPTION & MANUFACTURER	MODEL NO.	SERIAL NO.	CALIBRATED DATE	CALIBRATED UNTIL
Spectrum Analyzer R&S	FSV40	100964	May 29, 2020	May 28, 2021
Spectrum Analyzer Keysight	N9030A	MY54490679	July 13, 2020	July 12, 2021
Power meter Anritsu	ML2495A	1529002	July 26, 2019	July 25, 2020
Power sensor Anritsu	MA2411B	1339443	July 26, 2019	July 25, 2020
Fixed Attenuator Mini-Circuits	MDCS18N-10	MDCS18N-10-01	Apr. 14, 2020	Apr. 13, 2021
Mech Switch Absorptive Mini-Circuits	MSP4TA-18+	0140	Feb. 10, 2020	Feb. 09, 2021
FXD ATTEN Mini-Circuits	BW-S3W2+	MN71981	Feb. 10, 2020	Feb. 09, 2021
Software	ADT_RF Test Software V6.6.5.4	NA	NA	NA

- Note:**
1. The test was performed in Oven room 2.
 2. The calibration interval of the above test instruments is 12 months and the calibrations are traceable to NML/ROC and NIST/USA.
 3. Tested Date: July 19, 2020

3 General Information

3.1 General Description of EUT

Product	Terminal	
Brand	XAC	
Test Model	xCL_AT-100-R6-18U	
Status of EUT	ENGINEERING SAMPLE	
Power Supply Rating	Refer to note	
Modulation Type	WCDMA, HSDPA, HSUPA	BPSK
Operating Frequency	WCDMA, HSDPA, HSUPA	826.4 MHz ~ 846.6 MHz
Max. ERP Power	WCDMA B5: 21.12 dBm	
Emission Designator	WCDMA B5: 4M18F9W	
Antenna Type	Refer to Note	
Antenna Connector	Refer to Note	
Accessory Device	Battery (option) x1	
Data Cable Supplied	NA	

Note:

1. The EUT has three radios as following table:

Radio 1	Radio 2	Radio 3
WLAN(2.4GHz + 5GHz) + Bluetooth	WWAN(LTE + WCDMA)	NFC

2. Simultaneously transmission condition.

Condition	Technology	
1	WWAN	NFC
2	WWAN	Bluetooth
3	WLAN 2.4GHz	NFC
4	WLAN 5GHz	NFC
5	Bluetooth	NFC

Note: The emission of the simultaneous operation has been evaluated and no non-compliance was found.

3. The EUT power needs to be supplied from a power adapter and battery, the information is as below table:

Adapter (only for test, not for sale)		
Brand	Model No.	Spec.
DEE VAN ENTERPRISE CO., LTD	DSA-18PFCA-05 050300	Input: 100-240Vac, 0.6A, 50/60Hz Output: 5Vdc, 3A
Battery (option)		
Brand	Model No.	Spec.
Shenzhen Rishengzhi Electronics Technology Co., Ltd.	W001	Output: 3.6V, 6700mAh, 24.12Wh

4. The antennas provided to the EUT, please refer to the following table:

Antenna Set.	RF Chain No.	Brand	Model	Antenna Net Gain(dBi)	Frequency Range	Antenna Type	Connector Type
NFC	Main	XAC	RTOS	13	13.56MHz	wire	None
Wi-Fi BT	Main	AWAN	AYF6P-100002	2.29	2400MHz~2500MHz	PIFA	i-pex(MHF)
				2.77	5150MHz~5850MHz		
LTE	Main(B2) TX	AWAN	AXF6P-100015	2.11	1850 MHz to 1910 MHz	PIFA	i-pex(MHF)
	Main(B4) TX			1.33	1710 MHz to 1755 MHz		
	Main(B12) TX			1.46	699 MHz to 715 MHz		
	Main(B2) RX			2.69	1930 MHz to 1990 MHz		
	Main(B4) RX			0.66	2110 MHz to 2155 MHz		
	Main(B12) RX			2.64	729 MHz to 745 MHz		
	Aux(B2) RX	AWAN	AXF6P-100005	1.95	1930 MHz to 1990 MHz	PIFA	i-pex(MHF)
	Aux(B4) RX			2.96	2110 MHz to 2155 MHz		
	Aux(B12) RX			2.61	729 MHz to 746 MHz		
WCDMA	Main(B2) TX	AWAN	AXF6P-100015	2.11	1850 MHz to 1910 MHz	PIFA	i-pex(MHF)
	Main(B5) TX			0.32	824 MHz to 849 MHz		
	Main(B2) RX			2.69	1930 MHz to 1990 MHz		
	Main(B5) RX			2.53	869 MHz to 894 MHz		
	Aux(B2) RX	AWAN	AXF6P-100005	2.45	1930 MHz to 1990 MHz	PIFA	i-pex(MHF)
	Aux(B5) RX			1.23	869 MHz to 894 MHz		
GPS	Main	YAGEO	ANT8010JLD2B151	3.29	1575.42MHz	Chip	i-pex(MHF)

5. The EUT was pre-tested for radiated emission test under following test modes:

Pre-test Mode	Power
Mode A	Power from Adapter
Mode B	Power from Battery

From the above modes, the worst radiated test was found in **Mode A**.

6. The above EUT information is declared by manufacturer and for more detailed features description, please refer to the manufacturer's specifications or User's Manual.

7. The above Antenna information is declared by manufacturer and for more detailed features description, please refer to the manufacturer's specifications, the laboratory shall not be held responsible.

3.2 Configuration of System under Test

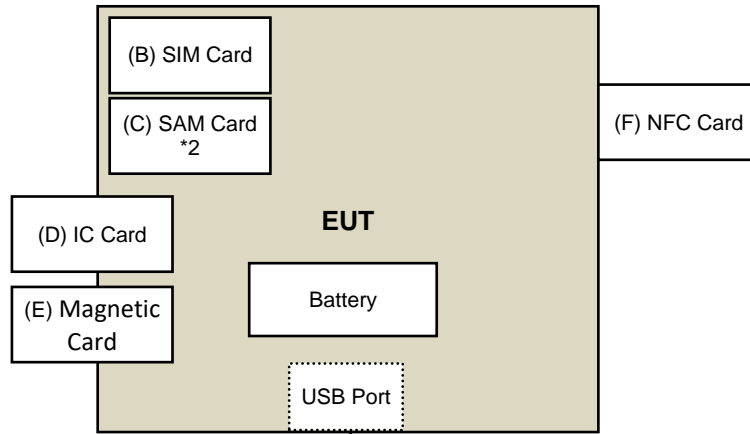

(1)

Under Table

(A) USB
Adapter

Remote Site

WWAN

(G) Simulator

3.2.1 Description of Support Units

The EUT has been tested as an independent unit together with other necessary accessories or support units. The following support units or accessories were used to form a representative test configuration during the tests.

ID	Product	Brand	Model No.	Serial No.	FCC ID	Remarks
A.	USB Adapter	DEE VAN	DSA-18PFCA-05 050300	NA	NA	Supplied by client
B.	SIM Card	Keysight	NA	NA	NA	Provided by Lab
C.	SAM Card *2	XAC	NA	NA	NA	Supplied by client
D.	IC Card	XAC	NA	NA	NA	Supplied by client
E.	Magnetic Card	XAC	NA	NA	NA	Supplied by client
F.	NFC Card	XAC	NA	NA	NA	Supplied by client
G.	Simulator	Anritsu	MT8820C	6201127458	NA	Provided by Lab

Note:

1. All power cords of the above support units are non-shielded (1.8m).

ID	Descriptions	Qty.	Length (m)	Shielding (Yes/No)	Cores (Qty.)	Remarks
1.	USB Type C to USB Cable	1	1.2	Yes	0	Supplied by client

3.3 Test Mode Applicability and Tested Channel Detail

WCDMA B5

Test Item	Available Channel	Tested Channel	Mode
ERP	4132 to 4233	4132, 4182, 4233	WCDMA
Frequency Stability	4132 to 4233	4182	WCDMA
Occupied Bandwidth	4132 to 4233	4132, 4182, 4233	WCDMA
Peak to Average Ratio	4132 to 4233	4132, 4182, 4233	WCDMA
Band Edge	4132 to 4233	4132, 4233	WCDMA
Conducted Emission	4132 to 4233	4132, 4182, 4233	WCDMA
Radiated Emission Below 1GHz	4132 to 4233	4132, 4182, 4233	WCDMA
Radiated Emission Above 1GHz	4132 to 4233	4132, 4182, 4233	WCDMA

Test Condition:

Test Item	Environmental Conditions	Input Power (System)	Tested By
ERP	23deg. C, 62%RH	120Vac, 60Hz	Allen Chuang
Frequency Stability	23deg. C, 62%RH	120Vac, 60Hz	Allen Chuang
Occupied Bandwidth	23deg. C, 62%RH	120Vac, 60Hz	Allen Chuang
Band Edge	23deg. C, 62%RH	120Vac, 60Hz	Allen Chuang
Peak to Average Ratio	23deg. C, 62%RH	120Vac, 60Hz	Allen Chuang
Condcudeted Emission	23deg. C, 62%RH	120Vac, 60Hz	Allen Chuang
Radiated Emission Below 1GHz	25deg. C, 75%RH	120Vac, 60Hz	Nelson Teng
Radiated Emission Above 1GHz	25deg. C, 75%RH	120Vac, 60Hz	Nelson Teng

3.4 EUT Operating Conditions

The communication simulator station system controlled a EUT to export maximum output power under transmission mode and specific channel frequency

3.5 General Description of Applied Standards and references

The EUT is a RF Product. According to the specifications of the manufacturer, it must comply with the requirements of the following standards and references:

Test standard:

FCC 47 CFR Part 2

FCC 47 CFR Part 22, Subpart H

ANSI/TIA/EIA-603-E 2016

ANSI 63.26-2015

All test items have been performed and recorded as per the above standards.

References Test Guidance :

KDB 971168 D01 Power Meas License Digital Systems v03r01

All test items have been performed as a reference to the above KDB test guidance.

4 Test Types and Results

4.1 Output Power Measurement

4.1.1 Limits of Output Power Measurement

Mobile / Portable station are limited to 7 watts e.r.p.

4.1.2 Test Procedures

Conducted Power Measurement:

The EUT was set up for the maximum power with WCDMA link data modulation and link up with simulator. Set the EUT to transmit under low, middle and high channel and difference RB size/ RB offset for difference bandwidth record the power level shown on power meter.

EIRP / ERP Measurement:

- EIRP = Conducted Output power level + Antenna gain.
- ERP power can be calculated form EIRP power by subtracting the gain of dipole, ERP power = EIRP power - 2.15dBi.
- ERP = Conducted Output power level + Antenna gain (dBi) - Isotropically Factor (2.15dB).

4.1.3 Test Setup

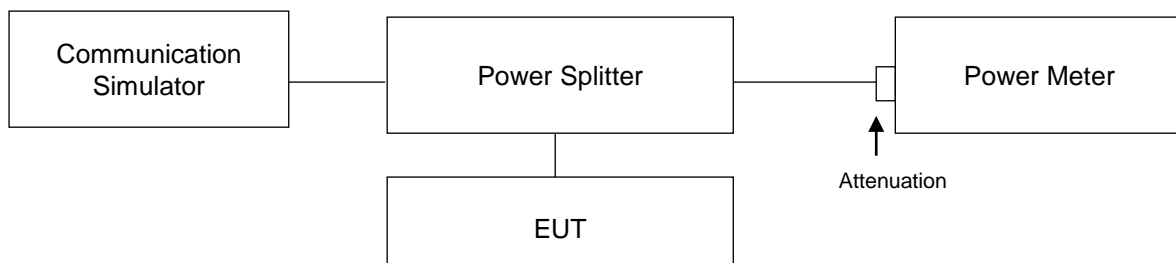

For the actual test configuration, please refer to the attached file (Test Setup Photo).

4.1.4 Test Results

CONDUCTED OUTPUT POWER (dBm)

WCDMA B5

Band	WCDMA B5		
Channel	4132	4182	4233
Frequency (MHz)	826.4	836.4	846.6
RMC	22.82	22.95	22.85
HSDPA Subtest-1	22.30	22.43	22.33
HSDPA Subtest-2	22.28	22.41	22.31
HSDPA Subtest-3	21.81	21.94	21.84
HSDPA Subtest-4	21.78	21.91	21.81
HSUPA Subtest-1	21.64	21.77	21.67
HSUPA Subtest-2	20.28	20.41	20.31
HSUPA Subtest-3	21.15	21.28	21.18
HSUPA Subtest-4	20.59	20.72	20.62
HSUPA Subtest-5	22.30	22.43	22.33

ERP POWER

WCDMA B5

Band	WCDMA B5		
Channel	4132	4182	4233
Frequency (MHz)	826.4	836.4	846.6
RMC	22.82	22.95	22.85
Gain (dBi)	0.32	0.32	0.32
Isotropically Factor (dB)	2.15	2.15	2.15
Max. ERP Power (dBm)	20.99	21.12	21.02

4.2 Modulation Characteristics Measurement

4.2.1 Limits of Modulation Characteristics

N/A

4.2.2 Test Procedure

Connect the EUT to Communication Simulator via the antenna connector, The frequency band is set as EUT supported Modulation and Channels, the EUT output is matched with 50 ohm load, the waveform quality and constellation of the EUT was tested.

4.2.3 Test Setup



4.2.4 Test Results

WCDMA B5

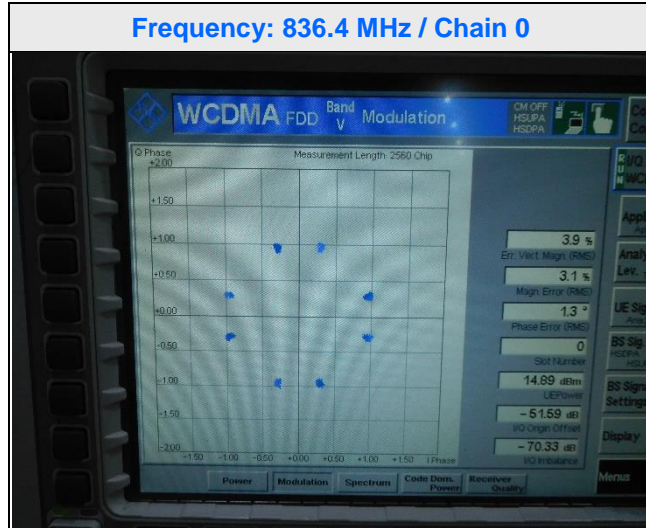

4.3 Frequency Stability Measurement

4.3.1 Limits of Frequency Stability Measurement

1.5 ppm is for base and fixed station. 2.5 ppm is for mobile station.

4.3.2 Test Procedure

- a. Device is placed at the oven room. The oven room could control the temperatures and humidity. Power warm up is at least 15 min and power applied should perform before recording frequency error.
- b. EUT is connected the external power supply to control the AC input power. The test voltage range is from minimum to maximum working voltage. Each step shall be record the frequency error rate.
- c. The temperature range step is 10 degrees in this test items. All temperature levels shall be hold the ± 0.5 °C during the measurement testing. The each temperature step shall be at least 0.5 hours, consider the EUT could be test under the stability condition.

NOTE: The frequency error was recorded frequency error from the communication simulator.

4.3.3 Test Setup

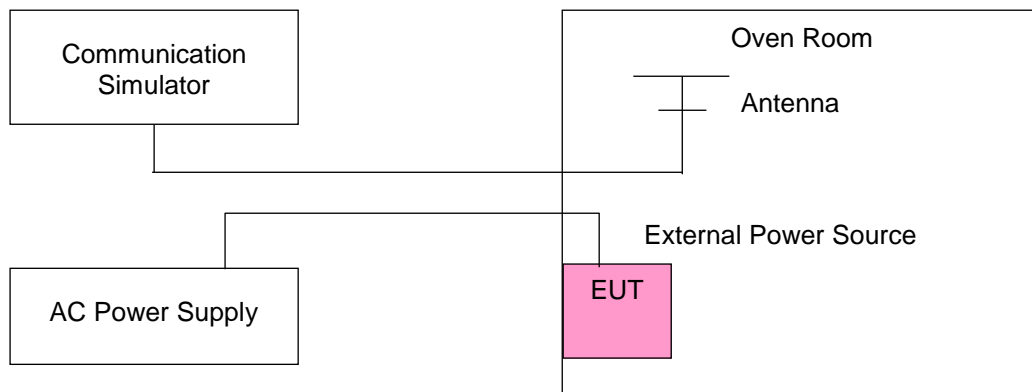

4.3.4 Test Results

WCDMA B5

Frequency Error vs. Voltage

Voltage (Volts)	Frequency Error (ppm)	Limit (ppm)	PASS/FAIL
	WCDMA B5		
102	-0.040	2.5	PASS
138	0.004	2.5	PASS

Frequency Error vs. Temperature.

TEMP. (°C)	Frequency Error (ppm)	Limit (ppm)	PASS/FAIL
	WCDMA B5		
50	-0.034	2.5	PASS
40	0.044	2.5	PASS
30	0.000	2.5	PASS
20	0.024	2.5	PASS
10	0.021	2.5	PASS
0	-0.032	2.5	PASS
-10	0.050	2.5	PASS
-20	0.056	2.5	PASS
-30	-0.018	2.5	PASS

4.4 Occupied Bandwidth Measurement

4.4.1 Test Procedure

All measurements were done at low, middle and high operational frequency range. The communication simulator station system controlled a EUT to export maximum output power under transmission mode and specific channel frequency. The bandwidth of the fundamental frequency was measured by spectrum analyzer with $RBW \geq 1\% \times OBW$ and $VBW \geq 3 \times VBW$.

Occupied Bandwidth Measurement:

Use OBW measurement function of Spectrum analyzer to measure 99 % occupied bandwidth.

26dB Bandwidth Measurement:

The emission bandwidth is defined as the width of the signal between two points, one below the carrier center frequency and one above the carrier center frequency, outside of which all emission are attenuated at least 26dB below the transmitter power.

4.4.2 Test Setup

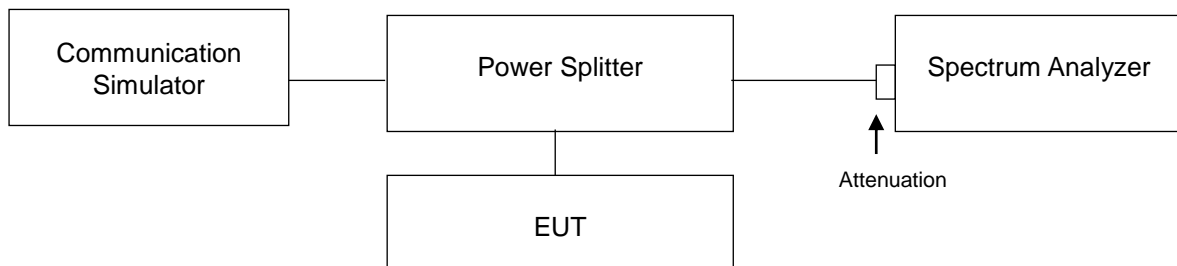

4.4.3 Test Result (-26dB Bandwidth)

Channel	Freq. (MHz)	-26dB Bandwidth (MHz)
		WCDMA B5
4132	826.4	4.73
4182	836.4	4.71
4233	846.6	4.64

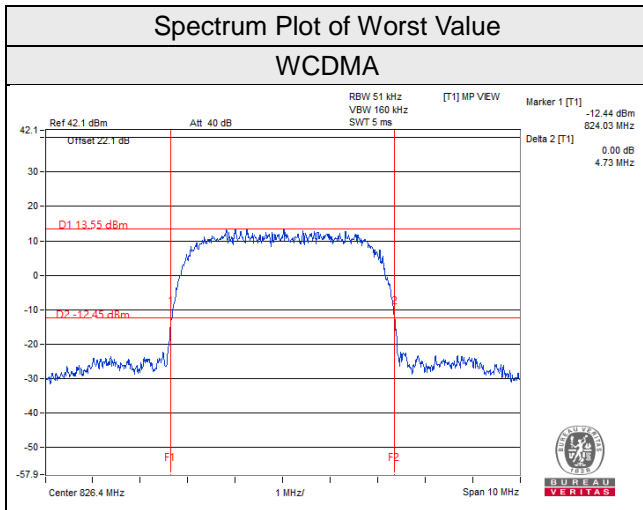

4.4.4 Test Result (Occupied Bandwidth)

Channel	Freq. (MHz)	99% Occupied Bandwidth (MHz)
		WCDMA
4132	826.4	4.18
4182	836.4	4.15
4233	846.6	4.13

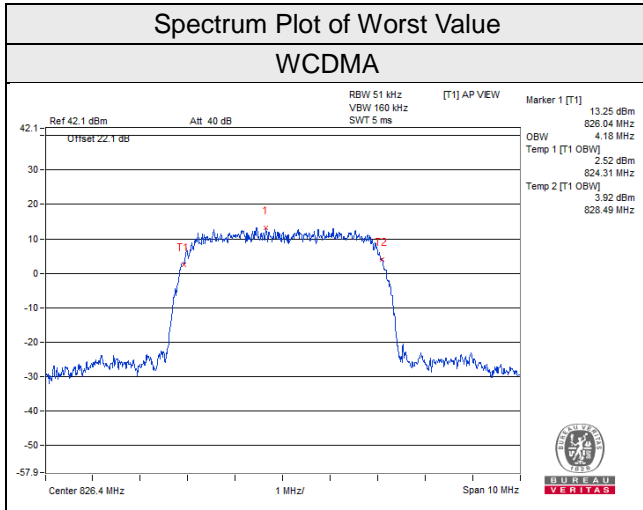

4.5 Band Edge Measurement

4.5.1 Limits of Band Edge Measurement

Power of any emission outside of the authorized operating frequency ranges must be attenuated below the transmitting power (P) by a factor of at least $43 + 10 \log(P)$ dB. In the 1 MHz bands immediately outside and adjacent to the frequency block a resolution bandwidth of at least one percent of the emission bandwidth of the fundamental emission of the transmitter may be employed.

4.5.2 Test Setup

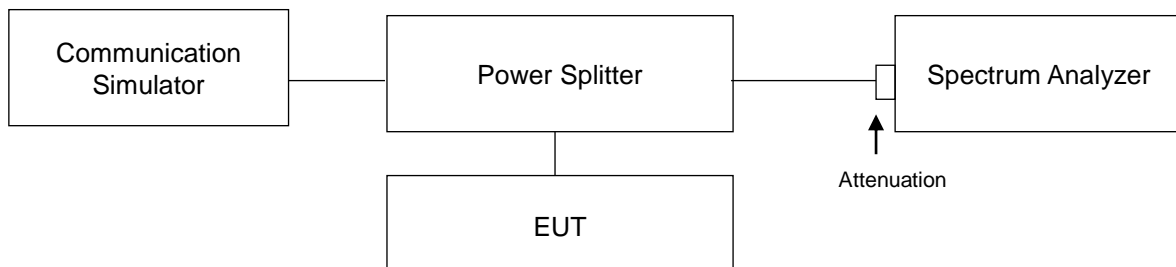

4.5.3 Test Procedures

- All measurements were done at low and high operational frequency range.
- The center frequency of spectrum is the band edge frequency and RB of the spectrum is $>1\%$ Emission Bandwidth and VB of the spectrum is $\geq 3*RB$.
- Record the max trace plot into the test report.

4.5.4 Test Results

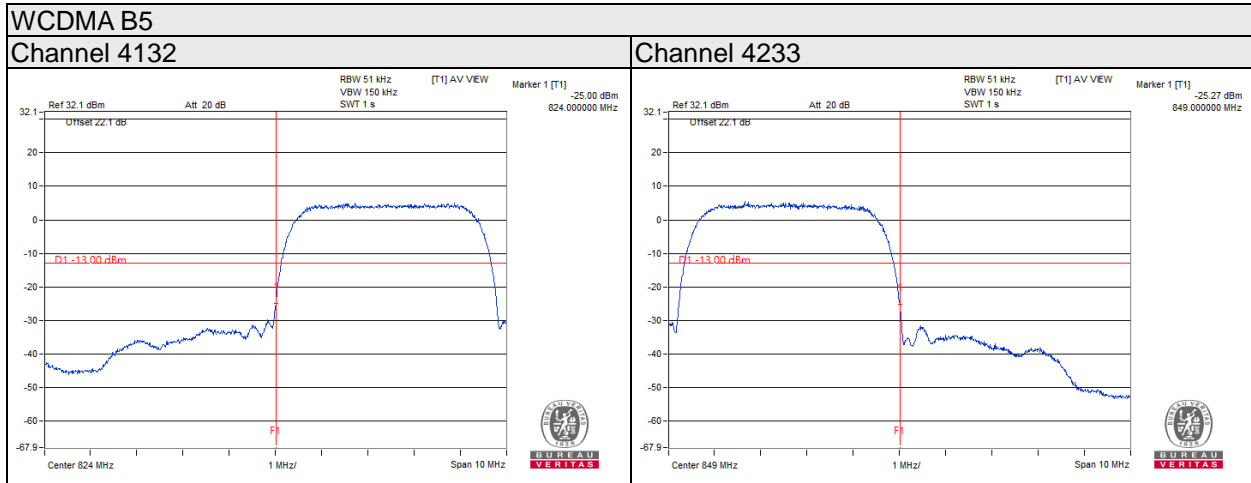

4.6 Peak to Average Ratio

4.5.1 Limits of Peak to Average Ratio Measurement

In measuring transmissions in this band using an average power technique, the peak to-average ratio (PAR) of the transmission may not exceed 13 dB

4.5.2 Test Setup

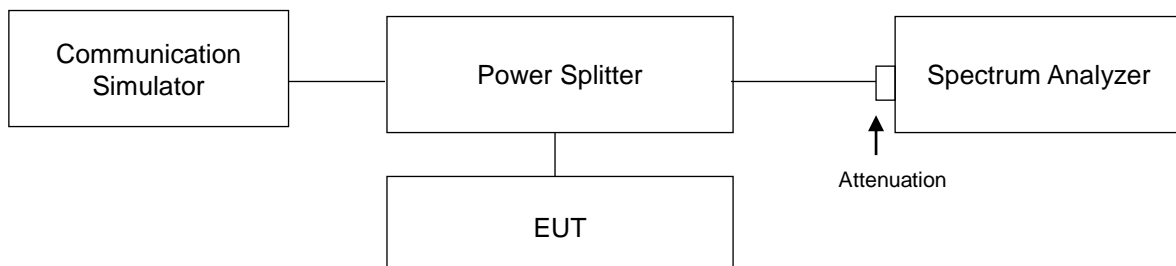

4.5.3 Test Procedures

1. Set resolution measurement bandwidth \geq signal's occupied bandwidth;
2. Set the number of counts to a value that stabilizes the measured CCDF curve;
3. Record the maximum PAPR level associated with a probability of 0.1%.

4.5.4 Test Results

Channel	Freq. (MHz)	Peak to Average Ratio (dB)
		WCDMA B5
4132	826.4	2.96
4183	836.4	2.88
4233	846.6	2.91

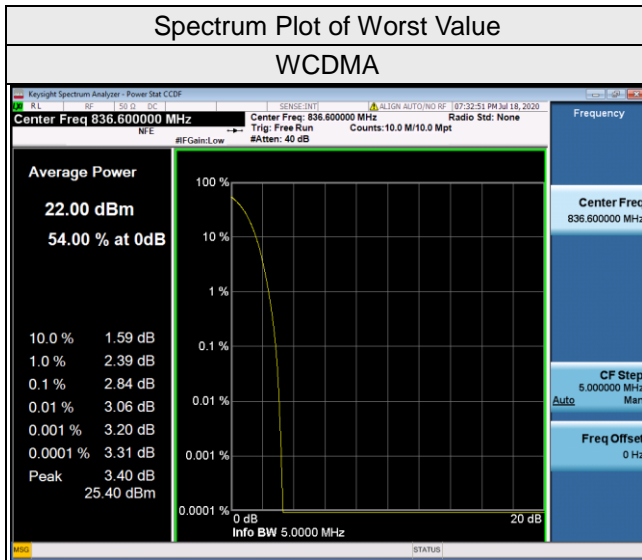

4.7 Conducted Spurious Emissions

4.7.1 Limits of Conducted Spurious Emissions Measurement

The power of any emission outside of the authorized operating frequency ranges must be attenuated below the transmitting power (P) by a factor of at least $43 + 10 \log(P)$ dB. The emission limit equal to -13dBm .

4.7.2 Test Setup

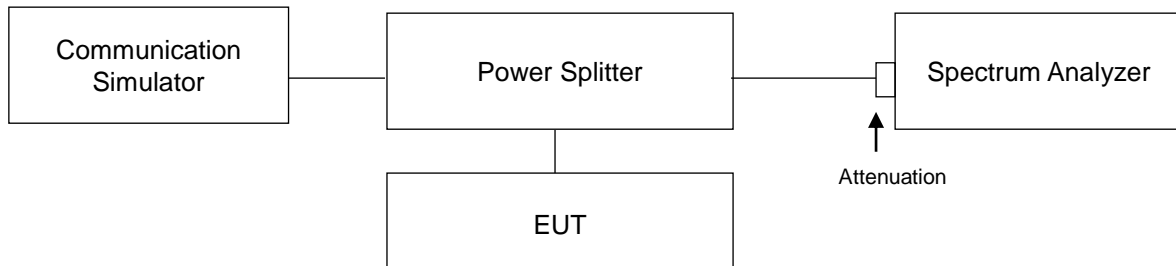

4.7.3 Test Procedure

- a. All measurements were done at 3 channels: low, middle and high operational frequency range.
- b. When the spectrum scanned from 9 kHz to the tenth harmonic of the highest fundamental frequency, it shall be connected to the 20dB pad attenuated the carried frequency.

4.7.4 Test Results



Note: The signal of 9kHz is IF signal from test instrument.

4.8 Radiated Emission Measurement

4.8.1 Limits of Radiated Emission Measurement

The power of any emission outside of the authorized operating frequency ranges must be attenuated below the transmitting power (P) by a factor of at least $43 + 10 \log(P)$ dB. The emission limit equal to -13dBm .

4.8.2 Test Procedure

- a. The power was measured with Spectrum Analyzer.
- b. Substitution method is used for EIRP measurement. In the semi-anechoic chamber, EUT placed on the 0.8m/1.5m height of Turn Table, rotated the table around 360 degrees to search the maximum radiation power and receiver antenna shall be rotated vertical and horizontal polarization and moved height from 1m to 4m to find the maximum polar radiated power. The "Read Value" is the spectrum reading the maximum power value.
- c. Follow ANSI 63.26 section 5.2.7 d), $\text{EIRP Value (dBm)} = \text{Read Value (dB}\mu\text{V/m)} - \text{Correction Factor @ 3m}$
- d. $\text{Correction Factor (dB) @ 3m} = 20\log(D) - 104.8$; where D is the measurement distance @3m $= -95.26\text{dB}$
- e. ERP power can be calculated form EIRP power by subtracting the gain of dipole, $\text{ERP power} = \text{EIRP power} - 2.15\text{dBi}$.

NOTE: The resolution bandwidth and video bandwidth of test receiver/spectrum analyzer is 1MHz/3MHz.

4.8.3 Deviation from Test Standard

No deviation.

4.8.4 Test Setup
For Below 1GHz

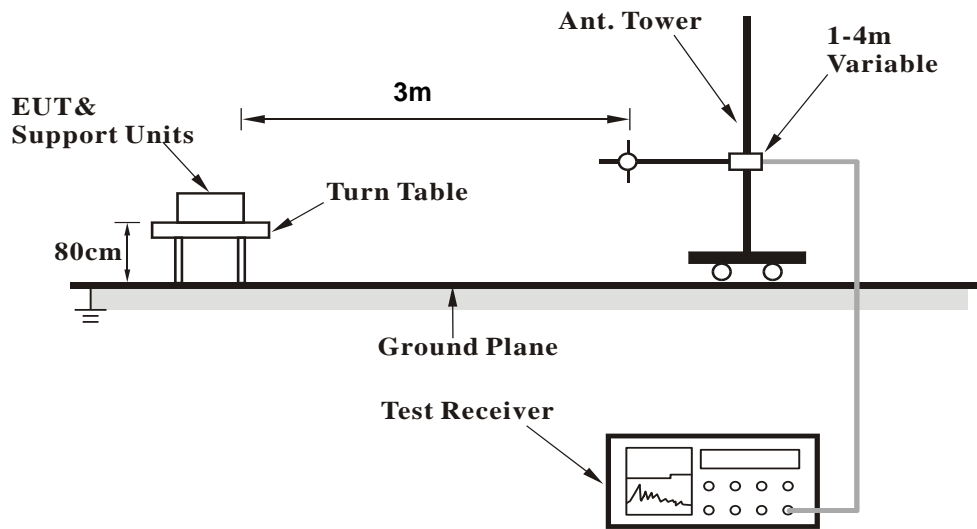

For Above 1GHz:

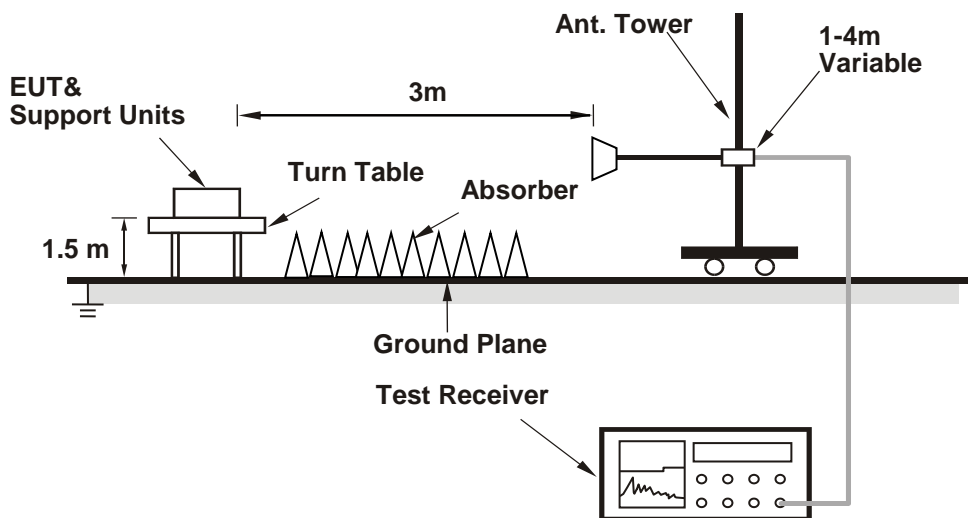

For the actual test configuration, please refer to the attached file (Test Setup Photo).

4.8.5 Test Results

Below 1GHz

WCDMA B5:

Mode	TX channel 4132	Frequency Range	Below 1000 MHz
------	-----------------	-----------------	----------------

Antenna Polarity & Test Distance: Horizontal at 3 M

No.	Freq. (MHz)	Reading (dB μ V/m)	Correction Factor (dB)	Emission Value (dBm)	Limit (dBm)	Margin (dB)
1	73.59	27.44	-95.26	-67.82	-13	-54.82
2	149.55	30.89	-95.26	-64.37	-13	-51.37
3	204.84	32.73	-95.26	-62.53	-13	-49.53
4	296.22	35.37	-95.26	-59.89	-13	-46.89
5	406.51	37.18	-95.26	-58.08	-13	-45.08
6	645.51	36.66	-95.26	-58.60	-13	-45.60

Antenna Polarity & Test Distance: Vertical at 3 M

No.	Freq. (MHz)	Reading (dB μ V/m)	Correction Factor (dB)	Emission Value (dBm)	Limit (dBm)	Margin (dB)
1	83.49	28.73	-95.26	-66.53	-13	-53.53
2	154.24	31.77	-95.26	-63.49	-13	-50.49
3	200.22	31.57	-95.26	-63.69	-13	-50.69
4	293.56	36.99	-95.26	-58.27	-13	-45.27
5	404.96	33.86	-95.26	-61.40	-13	-48.40
6	659.07	35.47	-95.26	-59.79	-13	-46.79

Remarks:

1. Follow ANSI 63.26 section 5.2.7 d), Emission Value (dBm) = E (dB μ V/m) - Correction Factor @ 3m.
2. Correction Factor (dB) = 20log(D) - 104.8; where D is the measurement distance @3m

Mode	TX channel 4182	Frequency Range	Below 1000 MHz
------	-----------------	-----------------	----------------

Antenna Polarity & Test Distance: Horizontal at 3 M

No.	Freq. (MHz)	Reading (dB μ V/m)	Correction Factor (dB)	Emission Value (dBm)	Limit (dBm)	Margin (dB)
1	74.23	27.7	-95.26	-67.56	-13	-54.56
2	149.9	30.79	-95.26	-64.47	-13	-51.47
3	204.7	31.85	-95.26	-63.41	-13	-50.41
4	296.26	35.45	-95.26	-59.81	-13	-46.81
5	406.4	36.99	-95.26	-58.27	-13	-45.27
6	645.68	37.4	-95.26	-57.86	-13	-44.86

Antenna Polarity & Test Distance: Vertical at 3 M

No.	Freq. (MHz)	Reading (dB μ V/m)	Correction Factor (dB)	Emission Value (dBm)	Limit (dBm)	Margin (dB)
1	83.77	28.67	-95.26	-66.59	-13	-53.59
2	154.51	32.25	-95.26	-63.01	-13	-50.01
3	199.88	31.78	-95.26	-63.48	-13	-50.48
4	293.08	37.6	-95.26	-57.66	-13	-44.66
5	405.55	33.65	-95.26	-61.61	-13	-48.61
6	658.75	35.57	-95.26	-59.69	-13	-46.69

Remarks:

1. Follow ANSI 63.26 section 5.2.7 d), Emission Value (dBm) = E (dB μ V/m) - Correction Factor @ 3m.
2. Correction Factor (dB) = 20log(D) - 104.8; where D is the measurement distance @3m.

Mode	TX channel 4233	Frequency Range	Below 1000 MHz
------	-----------------	-----------------	----------------

Antenna Polarity & Test Distance: Horizontal at 3 M

No.	Freq. (MHz)	Reading (dB μ V/m)	Correction Factor (dB)	Emission Value (dBm)	Limit (dBm)	Margin (dB)
1	73.59	27.66	-95.26	-67.60	-13	-54.60
2	149.56	31.08	-95.26	-64.18	-13	-51.18
3	204.65	32.71	-95.26	-62.55	-13	-49.55
4	296.1	34.98	-95.26	-60.28	-13	-47.28
5	406.2	37.71	-95.26	-57.55	-13	-44.55
6	645.7	37.54	-95.26	-57.72	-13	-44.72

Antenna Polarity & Test Distance: Vertical at 3 M

No.	Freq. (MHz)	Reading (dB μ V/m)	Correction Factor (dB)	Emission Value (dBm)	Limit (dBm)	Margin (dB)
1	83.67	28.43	-95.26	-66.83	-13	-53.83
2	154.35	32.01	-95.26	-63.25	-13	-50.25
3	200.09	30.92	-95.26	-64.34	-13	-51.34
4	293.39	36.93	-95.26	-58.33	-13	-45.33
5	405.12	34.25	-95.26	-61.01	-13	-48.01
6	658.81	35.89	-95.26	-59.37	-13	-46.37

Remarks:

1. Follow ANSI 63.26 section 5.2.7 d), Emission Value (dBm) = E (dB μ V/m) - Correction Factor @ 3m.
2. Correction Factor (dB) = 20log(D) - 104.8; where D is the measurement distance @3m.

Above 1GHz
WCDMA B5:

Mode	TX channel 4132	Frequency Range	Above 1000 MHz
------	-----------------	-----------------	----------------

Antenna Polarity & Test Distance: Horizontal at 3 M

No.	Freq. (MHz)	Reading (dB μ V/m)	Correction Factor (dB)	Emission Value (dBm)	Limit (dBm)	Margin (dB)
1	1652.8	46.74	-95.26	-48.52	-13	-35.52
2	2479.2	45.08	-95.26	-50.18	-13	-37.18
3	3305.6	48.51	-95.26	-46.75	-13	-33.75
4	4132	49.5	-95.26	-45.76	-13	-32.76

Antenna Polarity & Test Distance: Vertical at 3 M

No.	Freq. (MHz)	Reading (dB μ V/m)	Correction Factor (dB)	Emission Value (dBm)	Limit (dBm)	Margin (dB)
1	1652.8	55.12	-95.26	-40.14	-13	-27.14
2	2479.2	44.2	-95.26	-51.06	-13	-38.06
3	3305.6	48.23	-95.26	-47.03	-13	-34.03
4	4132	51.33	-95.26	-43.93	-13	-30.93

Remarks:

1. Follow ANSI 63.26 section 5.2.7 d), Emission Value (dBm) = E (dB μ V/m) - Correction Factor @ 3m.
2. Correction Factor (dB) = 20log(D) – 104.8; where D is the measurement distance @3m.

Mode	TX channel 4182	Frequency Range	Above 1000 MHz
------	-----------------	-----------------	----------------

Antenna Polarity & Test Distance: Horizontal at 3 M

No.	Freq. (MHz)	Reading (dB μ V/m)	Correction Factor (dB)	Emission Value (dBm)	Limit (dBm)	Margin (dB)
1	1672.8	46.51	-95.26	-48.75	-13	-35.75
2	2509.2	45.35	-95.26	-49.91	-13	-36.91
3	3345.6	48.51	-95.26	-46.75	-13	-33.75
4	4182	49.03	-95.26	-46.23	-13	-33.23

Antenna Polarity & Test Distance: Vertical at 3 M

No.	Freq. (MHz)	Reading (dB μ V/m)	Correction Factor (dB)	Emission Value (dBm)	Limit (dBm)	Margin (dB)
1	1672.8	54.79	-95.26	-40.47	-13	-27.47
2	2509.2	43.76	-95.26	-51.50	-13	-38.50
3	3345.6	47.8	-95.26	-47.46	-13	-34.46
4	4182	51.63	-95.26	-43.63	-13	-30.63

Remarks:

1. Follow ANSI 63.26 section 5.2.7 d), Emission Value (dBm) = E (dB μ V/m) - Correction Factor @ 3m.
2. Correction Factor (dB) = 20log(D) - 104.8; where D is the measurement distance @3m.

Mode	TX channel 4233	Frequency Range	Above 1000 MHz
------	-----------------	-----------------	----------------

Antenna Polarity & Test Distance: Horizontal at 3 M

No.	Freq. (MHz)	Reading (dB μ V/m)	Correction Factor (dB)	Emission Value (dBm)	Limit (dBm)	Margin (dB)
1	1693.2	46.65	-95.26	-48.61	-13	-35.61
2	2539.8	44.67	-95.26	-50.59	-13	-37.59
3	3386.4	48.12	-95.26	-47.14	-13	-34.14
4	4233	49.88	-95.26	-45.38	-13	-32.38

Antenna Polarity & Test Distance: Vertical at 3 M

No.	Freq. (MHz)	Reading (dB μ V/m)	Correction Factor (dB)	Emission Value (dBm)	Limit (dBm)	Margin (dB)
1	1693.2	55.05	-95.26	-40.21	-13	-27.21
2	2539.8	43.75	-95.26	-51.51	-13	-38.51
3	3386.4	48	-95.26	-47.26	-13	-34.26
4	4233	50.9	-95.26	-44.36	-13	-31.36

Remarks:

1. Follow ANSI 63.26 section 5.2.7 d), Emission Value (dBm) = E (dB μ V/m) - Correction Factor @ 3m.
2. Correction Factor (dB) = 20log(D) - 104.8; where D is the measurement distance @3m.

5 Pictures of Test Arrangements

Please refer to the attached file (Test Setup Photo).

Appendix – Information of the Testing Laboratories

We, Bureau Veritas Consumer Products Services (H.K.) Ltd., Taoyuan Branch, were founded in 1988 to provide our best service in EMC, Radio, Telecom and Safety consultation. Our laboratories are accredited and approved according to ISO/IEC 17025.

If you have any comments, please feel free to contact us at the following:

Lin Kou EMC/RF Lab

Tel: 886-2-26052180

Fax: 886-2-26051924

Hsin Chu EMC/RF/Telecom Lab

Tel: 886-3-6668565

Fax: 886-3-6668323

Hwa Ya EMC/RF/Safety Lab

Tel: 886-3-3183232

Fax: 886-3-3270892

Email: service.adt@tw.bureauveritas.com

Web Site: www.bureauveritas-adt.com

The address and road map of all our labs can be found in our web site also.

--- END ---