

FCC Test Report (NFC)

Report No.: RF200630E06-4

FCC ID: MQT-AT100R6

Test Model: xCL_AT-100-R6-18U

Received Date: June 30, 2020

Test Date: July 13 to Aug. 18, 2020

Issued Date: Oct. 23, 2020

Applicant: XAC AUTOMATION CORP.

Address: 4F, No. 30, INDUSTRY E. RD. IX, SCIENCE-BASED INDUSTRIAL
PARK,HSINCHU,TAIWAN

Issued By: Bureau Veritas Consumer Products Services (H.K.) Ltd., Taoyuan Branch
Hsin Chu Laboratory

Lab Address: E-2, No.1, Li Hsin 1st Road, Hsinchu Science Park, Hsinchu City 300,
Taiwan

Test Location: E-2, No.1, Li Hsin 1st Road, Hsinchu Science Park, Hsinchu City 300,
Taiwan

**FCC Registration /
Designation Number:** 723255 / TW2022



This report is for your exclusive use. Any copying or replication of this report to or for any other person or entity, or use of our name or trademark, is permitted only with our prior written permission. This report sets forth our findings solely with respect to the test samples identified herein. The results set forth in this report are not indicative or representative of the quality or characteristics of the lot from which a test sample was taken or any similar or identical product unless specifically and expressly noted. Our report includes all of the tests requested by you and the results thereof based upon the information that you provided to us. You have 60 days from date of issuance of this report to notify us of any material error or omission caused by our negligence, provided, however, that such notice shall be in writing and shall specifically address the issue you wish to raise. A failure to raise such issue within the prescribed time shall constitute your unqualified acceptance of the completeness of this report, the tests conducted and the correctness of the report contents. Unless specific mention, the uncertainty of measurement has been explicitly taken into account to declare the compliance or non-compliance to the specification.

Table of Contents

Release Control Record	3
1 Certificate of Conformity	4
2 Summary of Test Results	5
2.1 Measurement Uncertainty	5
2.2 Modification Record	5
3 General Information	6
3.1 General Description of EUT (NFC)	6
3.2 Description of Test Modes	8
3.2.1 Test Mode Applicability and Tested Channel Detail	9
3.3 Description of Support Units	11
3.3.1 Configuration of System under Test	12
3.4 General Description of Applied Standards	13
4 Test Types and Results	14
4.1 Radiated Emission Measurement	14
4.1.1 Limits of Radiated Emission Measurement	14
4.1.2 Test Instruments	15
4.1.3 Test Procedures	18
4.1.4 Deviation from Test Standard	18
4.1.5 Test Setup	19
4.1.6 EUT Operating Conditions	19
4.1.7 Test Results	20
4.2 Conducted Emission Measurement	34
4.2.1 Limits of Conducted Emission Measurement	34
4.2.2 Test Instruments	34
4.2.3 Test Procedures	35
4.2.4 Deviation from Test Standard	35
4.2.5 Test Setup	36
4.2.6 EUT Operating Conditions	36
4.2.7 Test Results	37
4.3 Frequency Stability	39
4.3.1 Limits of Frequency Stability Measurement	39
4.3.2 Test Setup	39
4.3.3 Test Instruments	39
4.3.4 Test Procedure	39
4.3.5 Deviation from Test Standard	39
4.3.6 EUT Operating Conditions	40
4.3.7 Test Result	40
4.4 20dB Bandwidth	41
4.4.1 Limits of 20dB bandwidth Measurement	41
4.4.2 Test Setup	41
4.4.3 Test Instruments	41
4.4.4 Test Procedures	41
4.4.5 Deviation from Test Standard	41
4.4.6 EUT Operating Conditions	41
4.4.7 Test Results	42
5 Pictures of Test Arrangements	43
Appendix – Information of the Testing Laboratories	44



Release Control Record

Issue No.	Description	Date Issued
RF200630E06-4	Original release.	Oct. 23, 2020

1 Certificate of Conformity

Product: Terminal

Brand: XAC

Test Model: xCL_AT-100-R6-18U

Sample Status: ENGINEERING SAMPLE

Applicant: XAC AUTOMATION CORP.

Test Date: July 13 to Aug. 18, 2020

Standards: 47 CFR FCC Part 15, Subpart C (Section 15.225)
47 CFR FCC Part 15, Subpart C (Section 15.215)
ANSI C63.10:2013

The above equipment has been tested by **Bureau Veritas Consumer Products Services (H.K.) Ltd., Taoyuan Branch**, and found compliance with the requirement of the above standards. The test record, data evaluation & Equipment Under Test (EUT) configurations represented herein are true and accurate accounts of the measurements of the sample's EMC characteristics under the conditions specified in this report.

Prepared by : Joyce Kuo , **Date:** Oct. 23, 2020
Joyce Kuo / Specialist

Approved by : Clark Lin , **Date:** Oct. 23, 2020
Clark Lin / Technical Manager

2 Summary of Test Results

47 CFR FCC Part 15, Subpart C (Section 15.225, 15.215)			
FCC Clause	Test Item	Result	Remarks
15.207	Conducted emission test	PASS	Meet the requirement of limit. Minimum passing margin is -19.41dB at 0.37656MHz.
15.225 (a)	The field strength of any emissions within the band 13.553-13.567 MHz	PASS	Meet the requirement of limit. Minimum passing margin is -22.72dB at 29.238MHz.
15.225 (b)	The field strength of any emissions within the bands 13.410-13.553 MHz and 13.567-13.710 MHz	PASS	Meet the requirement of limit.
15.225 (c)	The field strength of any emissions within the bands 13.110-13.410 MHz and 13.710-14.010 MHz	PASS	Meet the requirement of limit.
15.225 (d)	The field strength of any emissions appearing outside of the 13.110-14.010 MHz band	PASS	Meet the requirement of limit. Minimum passing margin is -7.7dB at 66.77MHz.
15.225 (e)	The frequency tolerance	PASS	Meet the requirement of limit.
15.215 (c)	20dB Bandwidth	PASS	Meet the requirement of limit.
15.203	Antenna Requirement	PASS	No antenna connector is used.

2.1 Measurement Uncertainty

Where relevant, the following measurement uncertainty levels have been estimated for tests performed on the EUT as specified in CISPR 16-4-2:

Measurement	Frequency	Expanded Uncertainty (k=2) (±)
Conducted Emissions at mains ports	150kHz ~ 30MHz	1.9 dB
Conducted emissions	-	2.5 dB
Radiated Emissions up to 1 GHz	9kHz ~ 30MHz	3.1 dB
	30MHz ~ 1GHz	5.4 dB

2.2 Modification Record

There were no modifications required for compliance.

3 General Information

3.1 General Description of EUT (NFC)

Product	Terminal
Brand	XAC
Test Model	xCL_AT-100-R6-18U
Status of EUT	ENGINEERING SAMPLE
Power Supply Rating	Refer to note
Modulation Type	ASK
Operating Frequency	13.56MHz
Number of Channel	1
Antenna Type	Refer to Note
Antenna Connector	Refer to Note
Accessory Device	Battery x1 (Option)
Data Cable Supplied	NA

Note:

1. The EUT has three radios as following table:

Radio 1	Radio 2	Radio 3
WLAN(2.4GHz + 5GHz) + Bluetooth	WWAN(LTE + WCDMA)	NFC

2. Simultaneously transmission condition.

Condition	Technology	
1	WWAN	NFC
2	WWAN	Bluetooth
3	WLAN 2.4GHz	NFC
4	WLAN 5GHz	NFC
5	Bluetooth	NFC

Note: The emission of the simultaneous operation has been evaluated and no non-compliance was found.

3. The EUT must be supplied power adapter and battery as following table:

Adapter (Only test not for sale)		
Brand	Model	Specification
DEE VAN ENTERPRISE CO., LTD	DSA-18PFCA-05 050300	AC Input: 100-240Vac, 0.6A, 50-60Hz DC Output: 5Vdc, 3A
Battery (Option)		
Brand	Model	Specification
Shenzhen Rishengzhi Electronics Technology Co., Ltd.	W001	3.6V, 6700mAh, 24.12Wh

4. The antennas provided to the EUT, please refer to the following table:

Antenna Set.	RF Chain NO.	Brand	Model (NCC 必填)	Antenna Net Gain(dBi)	Frequency range	Antenna Type	Connector Type
NFC	Main	XAC	RTOS	13	13.56MHz	wire	None
Wi-Fi BT	Main	AWAN	AYF6P-100002	2.29	2400MHz~2500MHz	PIFA	i-pex(MHF)
				2.77	5150MHz~5850MHz		
LTE	Main(B2) TX	AWAN	AXF6P-100015	2.11	1850 MHz to 1910 MHz	PIFA	i-pex(MHF)
	Main(B4) TX			1.33	1710 MHz to 1755 MHz		
	Main(B12) TX			1.46	699 MHz to 715 MHz		
	Main(B2) RX			2.69	1930 MHz to 1990 MHz		
	Main(B4) RX			0.66	2110 MHz to 2155 MHz		
	Main(B12) RX			2.64	729 MHz to 745 MHz		
	Aux(B2) RX	AWAN	AXF6P-100005	1.95	1930 MHz to 1990 MHz	PIFA	i-pex(MHF)
	Aux(B4) RX			2.96	2110 MHz to 2155 MHz		
	Aux(B12) RX			2.61	729 MHz to 746 MHz		
WCDMA	Main(B2) TX	AWAN	AXF6P-100015	2.11	1850 MHz to 1910 MHz	PIFA	i-pex(MHF)
	Main(B5) TX			0.32	824 MHz to 849 MHz		
	Main(B2) RX			2.69	1930 MHz to 1990 MHz		
	Main(B5) RX			2.53	869 MHz to 894 MHz		
	Aux(B2) RX	AWAN	AXF6P-100005	2.45	1930 MHz to 1990 MHz	PIFA	i-pex(MHF)
	Aux(B5) RX			1.23	869 MHz to 894 MHz		
GPS	Main	YAGEO	ANT8010JLD2B151	3.29	1575.42MHz	Chip	i-pex(MHF)

5. The EUT was pre-tested for radiated emission test under following test modes:

Pre-test Mode	Power
Mode A	Power from Adapter
Mode B	Power from Battery
From the above modes, the worst radiated test was found in Mode A .	

6. The EUT was pre-tested for conducted emission test under following test modes:

Pre-test Mode	Power
Mode A	Power from Adapter
Mode B	Power from Laptop
From the above modes, the worst conducted emission test was found in Mode A .	

7. The above EUT information is declared by manufacturer and for more detailed features description, please refers to the manufacturer's specifications or user's manual.

8. The above Antenna information is declared by manufacturer and for more detailed features description, please refer to the manufacturer's specifications, the laboratory shall not be held responsible.

3.2 Description of Test Modes

One channel was provided to this EUT:

Channel	Frequency (MHz)
1	13.56

3.2.1 Test Mode Applicability and Tested Channel Detail

EUT Configure Mode	Applicable to				Description
	RE	PLC	FS	EB	
-	√	√	√	√	-

Where

RE≥1G: Radiated Emission

PLC: Power Line Conducted Emission

FS: Frequency Stability

EB: 20dB Bandwidth measurement

Radiated Emission Test:

- Pre-Scan has been conducted to determine the worst-case mode from all possible combinations between available modulations, data rates and antenna ports (if EUT with antenna diversity architecture).
- Following channel(s) was (were) selected for the final test as listed below.

Available Channel	Tested Channel	Modulation Type
1	1	ASK

Power Line Conducted Emission Test:

- Pre-Scan has been conducted to determine the worst-case mode from all possible combinations between available modulations, data rates and antenna ports (if EUT with antenna diversity architecture).
- Following channel(s) was (were) selected for the final test as listed below.

Available Channel	Tested Channel	Modulation Type
1	1	ASK

Frequency Stability:

- Pre-Scan has been conducted to determine the worst-case mode from all possible combinations between available modulations, data rates and antenna ports (if EUT with antenna diversity architecture).
- Following channel(s) was (were) selected for the final test as listed below.

Available Channel	Tested Channel	Modulation Type
1	1	ASK

20dB Bandwidth:

- Pre-Scan has been conducted to determine the worst-case mode from all possible combinations between available modulations, data rates and antenna ports (if EUT with antenna diversity architecture).
- Following channel(s) was (were) selected for the final test as listed below.

Available Channel	Tested Channel	Modulation Type
1	1	ASK

Test Condition:

Applicable to	Environmental Conditions	Input Power (System)	Tested By
RE	23deg. C, 69%RH	120Vac, 60Hz	Nelson Teng
PLC	25deg. C, 75%RH	120Vac, 60Hz	Nelson Teng
FS	25deg. C, 60%RH	120Vac, 60Hz	Kevin Ko
EB	25deg. C, 60%RH	120Vac, 60Hz	Kevin Ko

3.3 Description of Support Units

The EUT has been tested as an independent unit together with other necessary accessories or support units. The following support units or accessories were used to form a representative test configuration during the tests.

ID	Product	Brand	Model No.	Serial No.	FCC ID	Remarks
A.	USB Adapter	DEE VAN	DSA-18PFCA-05 050300	NA	NA	Supplied by client
B.	SIM Card	Keysight	NA	NA	NA	Provided by Lab
C.	SAM Card *2	XAC	NA	NA	NA	Supplied by client
D.	IC Card	XAC	NA	NA	NA	Supplied by client
E.	Magnetic Card	XAC	NA	NA	NA	Supplied by client
F.	NFC Card	XAC	NA	NA	NA	Supplied by client

ID	Descriptions	Qty.	Length (m)	Shielding (Yes/No)	Cores (Qty.)	Remarks
1.	USB Type C to USB Cable	1	1.2	Yes	0	Supplied by client

3.3.1 Configuration of System under Test

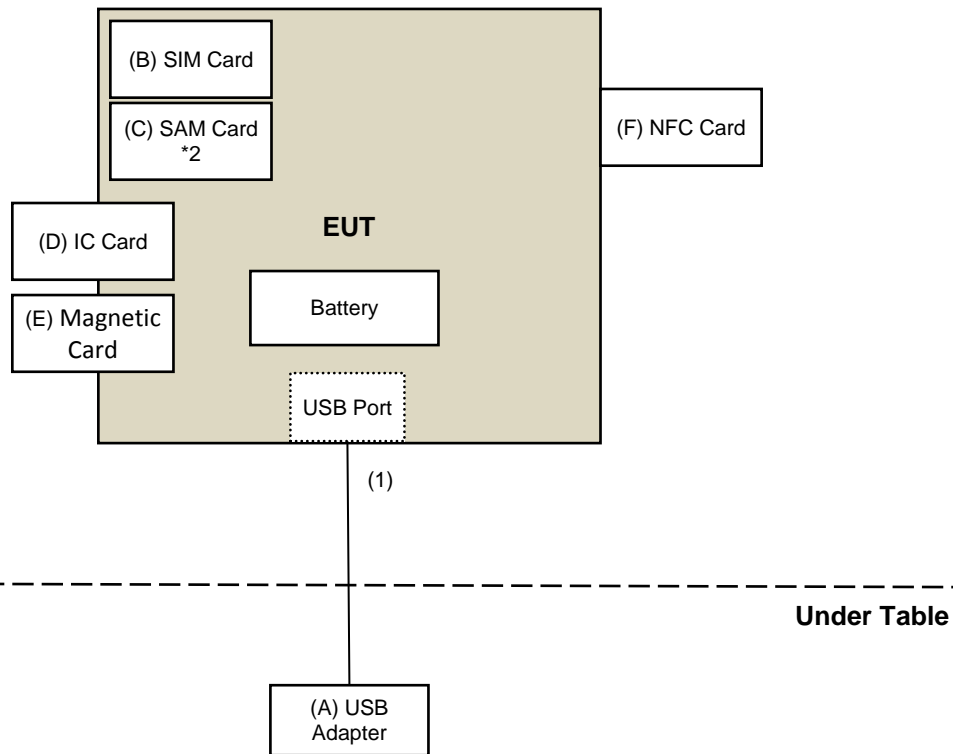

3.4 General Description of Applied Standards

The EUT is a RF Product. According to the specifications of the manufacturer, it must comply with the requirements of the following standards:

FCC Part 15, Subpart C (15.225)

FCC Part 15, Subpart C (15.215)

ANSI C63.10-2013

All test items have been performed and recorded as per the above standards.

4 Test Types and Results

4.1 Radiated Emission Measurement

4.1.1 Limits of Radiated Emission Measurement

(a) The field strength of any emissions within the band 13.553-13.567 MHz shall not exceed 15,848 microvolts/meter at 30 meters.

(b) Within the bands 13.410-13.553 MHz and 13.567-13.710 MHz, the field strength of any emissions shall not exceed 334 microvolts/meter at 30 meters.

(c) Within the bands 13.110-13.410 MHz and 13.710-14.010 MHz the field strength of any emissions shall not exceed 106 microvolts/meter at 30 meters.

(d) The field strength of any emissions appearing outside of the 13.110-14.010 MHz band shall not exceed the general radiated emission limits in §15.209 as below table:

Frequencies (MHz)	Field Strength (microvolts/meter)	Measurement Distance (meters)
0.009 ~ 0.490	2400/F(kHz)	300
0.490 ~ 1.705	24000/F(kHz)	30
1.705 ~ 30.0	30	30
30 ~ 88	100	3
88 ~ 216	150	3
216 ~ 960	200	3
Above 960	500	3

Note:

1. The lower limit shall apply at the transition frequencies.
2. Emission level (dBuV/m) = 20 log Emission level (uV/m).
3. The emission limits shown in the above table are based on measurements employing a CISPR quasi-peak detector except for the frequency bands 9–90 kHz, 110–490 kHz and above 1000 MHz. Radiated emission limits in these three bands are based on measurements employing an average detector.
4. For frequencies above 1000MHz, the field strength limits are based on average detector, however, the peak field strength of any emission shall not exceed the maximum permitted average limits, specified above by more than 20dB under any condition of modulation.

4.1.2 Test Instruments

For Emission (Above 1GHz):

DESCRIPTION & MANUFACTURER	MODEL NO.	SERIAL NO.	CALIBRATED DATE	CALIBRATED UNTIL
Test Receiver Agilent	N9038A	MY51210202	Dec. 13, 2019	Dec. 12, 2020
Horn_Antenna SCHWARZBECK	BBHA 9120D	9120D-783	Nov. 24, 2019	Nov. 23, 2020
Pre-Amplifier EMCI	EMC 12630 SE	980638	Apr. 08, 2020	Apr. 07, 2021
RF Cable	EMC104-SM-SM-1200	160923	Jan. 15, 2020	Jan. 14, 2021
RF Cable	EMC104-SM-SM-2000	180502	Apr. 29, 2020	Apr. 28, 2021
RF Cable	EMC104-SM-SM-6000	180418	Apr. 29, 2020	Apr. 28, 2021
Pre-Amplifier EMCI	EMC184045SE	980387	Jan. 15, 2020	Jan. 14, 2021
Horn_Antenna SCHWARZBECK	BBHA 9170	BBHA9170519	Nov. 24, 2019	Nov. 23, 2020
RF Cable	EMC102-KM-KM-1200	160924	Jan. 15, 2020	Jan. 14, 2021
RF Cable	EMC-KM-KM-4000	200214	Mar. 11, 2020	Mar. 10, 2021
Software	ADT_Radiated_V8.7.08	NA	NA	NA
Boresight Antenna Tower & Turn Table Max-Full	MF-7802BS	MF780208530	NA	NA

Note:

1. The calibration interval of the above test instruments is 12 months and the calibrations are traceable to NML/ROC and NIST/USA.
2. The test was performed in 966 Chamber No. 4.
3. Tested Date: July 27, 2020

For Emission (Below 1GHz):

DESCRIPTION & MANUFACTURER	MODEL NO.	SERIAL NO.	CALIBRATED DATE	CALIBRATED UNTIL
Test Receiver Agilent	N9038A	MY51210202	Dec. 13, 2019	Dec. 12, 2020
Pre-Amplifier EMCI	EMC001340	980142	May 25, 2020	May 24, 2021
Loop Antenna Electro-Metrics	EM-6879	264	Feb. 18, 2020	Feb. 17, 2021
RF Cable	NA	LOOPCAB-001	Jan. 08, 2020	Jan. 07, 2021
RF Cable	NA	LOOPCAB-002	Jan. 08, 2020	Jan. 07, 2021
Pre-Amplifier Mini-Circuits	ZFL-1000VH2B	AMP-ZFL-01	Oct. 23, 2019	Oct. 22, 2020
Trilog Broadband Antenna SCHWARZBECK	VULB 9168	9168-406	Nov. 11, 2019	Nov. 10, 2020
RF Cable	8D	966-4-1	Mar. 18, 2020	Mar. 17, 2021
RF Cable	8D	966-4-2	Mar. 18, 2020	Mar. 17, 2021
RF Cable	8D	966-4-3	Mar. 18, 2020	Mar. 17, 2021
Fixed attenuator Mini-Circuits	UNAT-5+	PAD-3m-4-01	Sep. 26, 2019	Sep. 25, 2020
Software	ADT_Radiated_V8.7.08	NA	NA	NA
Boresight Antenna Tower & Turn Table Max-Full	MF-7802BS	MF780208530	NA	NA

Note:

1. The calibration interval of the above test instruments is 12 months and the calibrations are traceable to NML/ROC and NIST/USA.
2. The test was performed in 966 Chamber No. 4.
3. Tested Date: Aug. 18, 2020

For other test:

DESCRIPTION & MANUFACTURER	MODEL NO.	SERIAL NO.	CALIBRATED DATE	CALIBRATED UNTIL
Spectrum Analyzer R&S	FSV40	100964	May 29, 2020	May 28, 2021
AC Power Source Extech Electronics	6205	1440452	NA	NA
Temperature & Humidity Chamber Giant Force	GTH-150-40-SP-AR	MAA0812-008	Jan. 16, 2020	Jan. 15, 2021
True RMS Clamp Meter FLUKE	325	31130711WS	June 06, 2020	June 05, 2021
Voltage Meter FLUKE	179	89610322	Sep. 25, 2019	Sep. 24, 2020
Software	ADT_RF Test Software V6.6.5.4	NA	NA	NA

- NOTE:**
1. The test was performed in Oven room 2.
 2. The calibration interval of the above test instruments is 12 months and the calibrations are traceable to NML/ROC and NIST/USA.
 3. Tested Date: Aug. 18, 2020

4.1.3 Test Procedures

For Radiated emission below 30MHz

- a. The EUT was placed on the top of a rotating table 0.8 meters above the ground at a 3 meter chamber room. The table was rotated 360 degrees to determine the position of the highest radiation.
- b. The EUT was set 3 meters away from the interference-receiving antenna, which was mounted on the top of a variable-height antenna tower.
- c. Parallel, perpendicular, and ground-parallel orientations of the antenna are set to make the measurement.
- d. For each suspected emission, the EUT was arranged to its worst case and the rotatable table was turned from 0 degrees to 360 degrees to find the maximum reading.
- e. The test-receiver system was set to Quasi-Peak or Average Detects Function and Specified Bandwidth with Maximum Hold Mode.

Note:

1. The resolution bandwidth and video bandwidth of test receiver/spectrum analyzer is 9kHz at frequency below 30MHz.

For Radiated emission above 30MHz

- a. The EUT was placed on the top of a rotating table 0.8 meters above the ground at 3 meter chamber room for test. The table was rotated 360 degrees to determine the position of the highest radiation.
- b. The EUT was set 3 meters away from the interference-receiving antenna, which was mounted on the top of a variable-height antenna tower.
- c. The height of antenna is varied from one meter to four meters above the ground to determine the maximum value of the field strength. Both horizontal and vertical polarizations of the antenna are set to make the measurement.
- d. For each suspected emission, the EUT was arranged to its worst case and then the antenna was tuned to heights from 1 meter to 4 meters and the rotatable table was turned from 0 degrees to 360 degrees to find the maximum reading.
- e. The test-receiver system was set to quasi-peak detect function and specified bandwidth with maximum hold mode when the test frequency is below 1 GHz.

Note:

1. The resolution bandwidth and video bandwidth of test receiver/spectrum analyzer is 120kHz for Quasi-peak detection (QP) at frequency below 1GHz.
2. All modes of operation were investigated and the worst-case emissions are reported.

4.1.4 Deviation from Test Standard

No deviation.

4.1.5 Test Setup

For Radiated emission below 30MHz

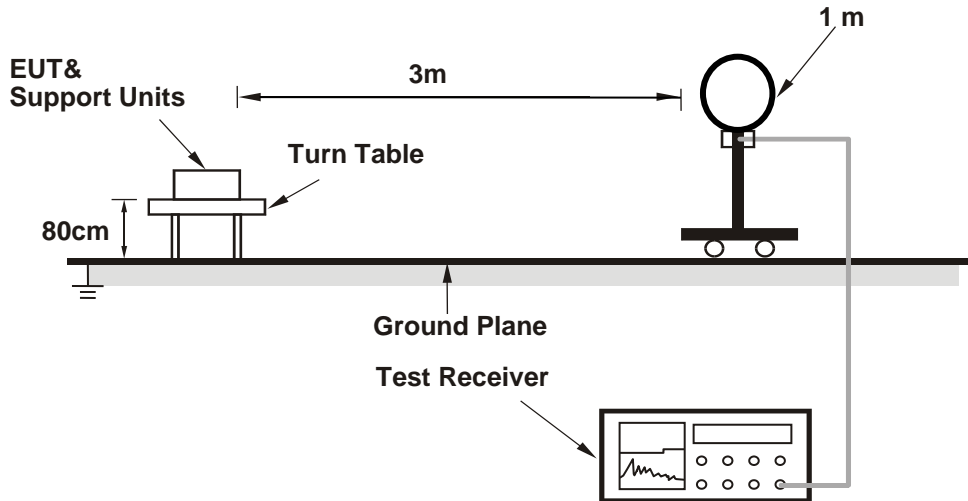

For Radiated emission 30MHz to 1GHz

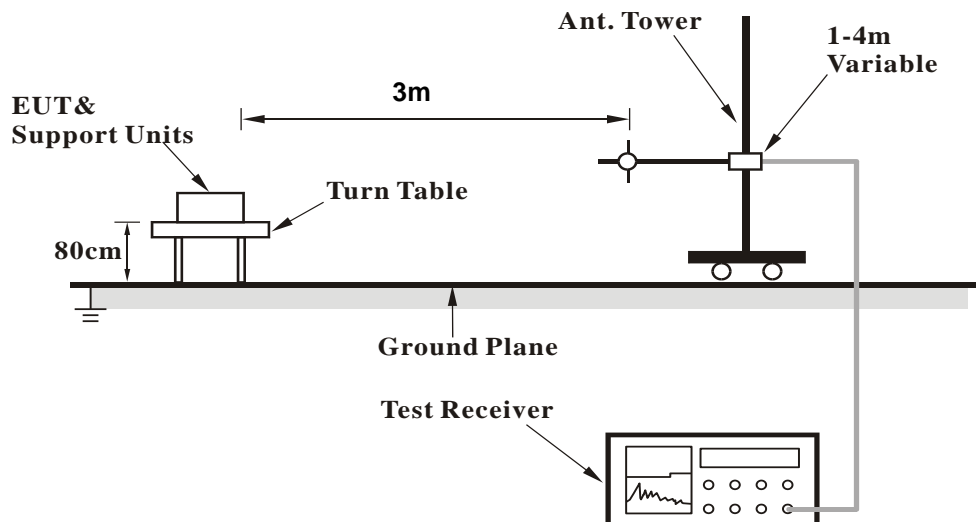

For the actual test configuration, please refer to the attached file (Test Setup Photo).

4.1.6 EUT Operating Conditions

- Placed the EUT on the testing table.
- Set the EUT under transmission condition continuously at specific channel frequency.

4.1.7 Test Results

Frequency Range	13.11 ~ 14.01MHz	Detector Function	Quasi-Peak
-----------------	------------------	-------------------	------------

Antenna Polarity : Parallel								
No	Frequency (MHz)	Emission Level (dBuV/m)	Limit (dBuV/m)	Margin (dB)	Antenna Height (m)	Table Angle (Degree)	Raw Value (dBuV)	Correction Factor (dB/m)
1	13.351	7.85 QP	40.51	-32.66	1.00	165	51.35	-43.50
2	13.493	12.70 QP	50.47	-37.77	1.00	176	56.22	-43.52
3	*13.560	32.24 QP	84.00	-51.76	1.00	176	75.78	-43.54
4	13.629	13.18 QP	50.47	-37.29	1.00	196	56.73	-43.55
5	13.773	11.68 QP	40.51	-28.83	1.00	188	55.25	-43.57

Remarks:

1. Emission Level(dBuV/m) = Raw Value(dBuV) + Correction Factor(dB/m)
2. Correction Factor(dB/m) = Antenna Factor(dB/m) + Cable Factor(dB) – Pre-Amplifier Factor(dB) + Distance Factor
3. Margin value = Emission Level – Limit value
4. The other emission levels were very low against the limit.
5. " * ": Fundamental frequency.
6. The test distance for 0.49 ~ 30MHz is 3m, extrapolate the measured field strength to a distance of 30 meters.
Distance factor@3m = $40 \cdot \log(3/30) = -40\text{dB}$

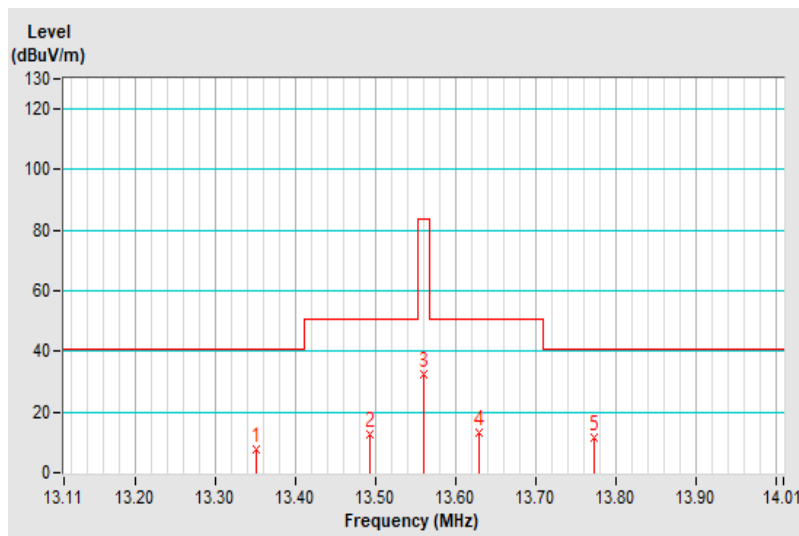

Frequency Range	13.11 ~ 14.01MHz	Detector Function	Quasi-Peak
-----------------	------------------	-------------------	------------

Antenna Polarity : Perpendicular								
No	Frequency (MHz)	Emission Level (dBuV/m)	Limit (dBuV/m)	Margin (dB)	Antenna Height (m)	Table Angle (Degree)	Raw Value (dBuV)	Correction Factor (dB/m)
1	13.350	-1.88 QP	40.51	-42.39	1.00	284	41.62	-43.50
2	13.493	2.23 QP	50.47	-48.24	1.00	287	45.75	-43.52
3	*13.560	24.22 QP	84.00	-59.78	1.00	272	67.76	-43.54
4	13.627	3.13 QP	50.47	-47.34	1.00	263	46.68	-43.55
5	13.773	1.94 QP	40.51	-38.57	1.00	261	45.51	-43.57

Remarks:

1. Emission Level(dBuV/m) = Raw Value(dBuV) + Correction Factor(dB/m)
2. Correction Factor(dB/m) = Antenna Factor(dB/m) + Cable Factor(dB) – Pre-Amplifier Factor(dB) + Distance Factor
3. Margin value = Emission Level – Limit value
4. The other emission levels were very low against the limit.
5. " * ": Fundamental frequency.
6. The test distance for 0.49 ~ 30MHz is 3m, extrapolate the measured field strength to a distance of 30 meters.
Distance factor@3m = $40 \cdot \log(3/30) = -40\text{dB}$

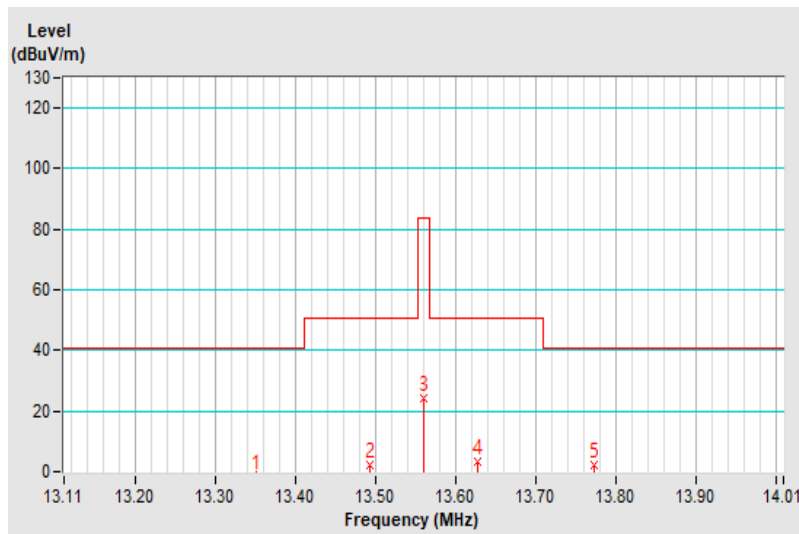

Frequency Range	13.11 ~ 14.01MHz	Detector Function	Quasi-Peak
-----------------	------------------	-------------------	------------

Antenna Polarity : Ground-parallel								
No	Frequency (MHz)	Emission Level (dBuV/m)	Limit (dBuV/m)	Margin (dB)	Antenna Height (m)	Table Angle (Degree)	Raw Value (dBuV)	Correction Factor (dB/m)
1	13.349	7.37 QP	40.51	-33.14	1.00	128	50.87	-43.50
2	13.491	7.37 QP	50.47	-43.10	1.00	128	50.89	-43.52
3	*13.560	33.55 QP	84.00	-50.45	1.00	171	77.09	-43.54
4	13.630	12.60 QP	50.47	-37.87	1.00	192	56.15	-43.55
5	13.773	10.65 QP	40.51	-29.86	1.00	192	54.22	-43.57

Remarks:

1. Emission Level(dBuV/m) = Raw Value(dBuV) + Correction Factor(dB/m)
2. Correction Factor(dB/m) = Antenna Factor(dB/m) + Cable Factor(dB) – Pre-Amplifier Factor(dB) + Distance Factor
3. Margin value = Emission Level – Limit value
4. The other emission levels were very low against the limit.
5. " * ": Fundamental frequency.
6. The test distance for 0.49 ~ 30MHz is 3m, extrapolate the measured field strength to a distance of 30 meters.
Distance factor@3m = $40 \cdot \log(3/30) = -40\text{dB}$

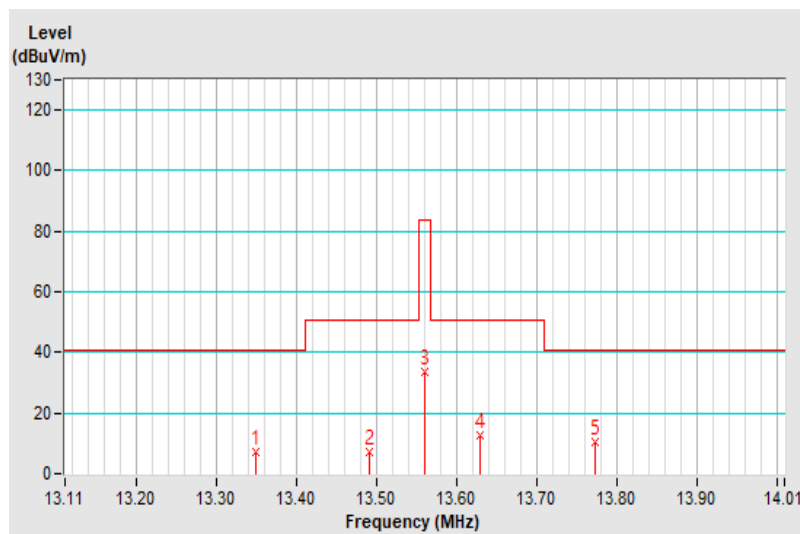

Frequency Range	9kHz ~ 150kHz	Detector Function	Peak/Average
-----------------	---------------	-------------------	--------------

Antenna Polarity : Parallel								
No	Frequency (MHz)	Emission Level (dBuV/m)	Limit (dBuV/m)	Margin (dB)	Antenna Height (m)	Table Angle (Degree)	Raw Value (dBuV)	Correction Factor (dB/m)
1	0.012	18.68 PK	66.02	-47.34	1.00	275	63.19	-44.51
2	0.012	14.86 AV	46.02	-31.16	1.00	275	59.37	-44.51
3	0.015	14.92 PK	64.08	-49.16	1.00	173	60.83	-45.91
4	0.015	12.87 AV	44.08	-31.21	1.00	173	58.78	-45.91
5	0.024	6.69 PK	60.00	-53.31	1.00	20	56.66	-49.97
6	0.024	4.77 AV	40.00	-35.23	1.00	20	54.74	-49.97
7	0.043	-3.21 PK	54.93	-58.14	1.00	244	52.17	-55.38
8	0.043	-5.08 AV	34.93	-40.01	1.00	244	50.30	-55.38
9	0.055	-7.78 PK	52.79	-60.57	1.00	300	49.83	-57.61
10	0.055	-9.62 AV	32.80	-42.42	1.00	300	47.99	-57.61
11	0.119	-19.98 PK	46.09	-66.07	1.00	347	44.61	-64.59
12	0.119	-21.90 AV	26.09	-47.99	1.00	347	42.69	-64.59

Remarks:

1. Emission Level(dBuV/m) = Raw Value(dBuV) + Correction Factor(dB/m)
2. Correction Factor(dB/m) = Antenna Factor(dB/m) + Cable Factor(dB) – Pre-Amplifier Factor(dB) + Distance Factor
3. Margin value = Emission Level – Limit value
4. The other emission levels were very low against the limit.
5. The test distance for below 0.49MHz is 3m, extrapolate the measured field strength to a distance of 300 meters.

Distance factor@3m = $40 \cdot \log(3/300) = -80\text{dB}$

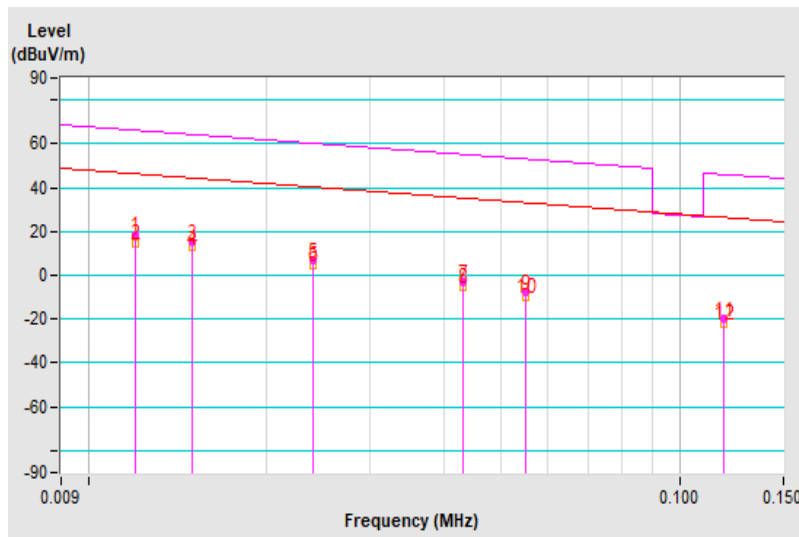

Frequency Range	150kHz ~ 490kHz	Detector Function	Peak/Average
-----------------	-----------------	-------------------	--------------

Antenna Polarity : Parallel								
No	Frequency (MHz)	Emission Level (dBuV/m)	Limit (dBuV/m)	Margin (dB)	Antenna Height (m)	Table Angle (Degree)	Raw Value (dBuV)	Correction Factor (dB/m)
1	0.152	-15.38 QP	23.96	-39.34	1.00	149	50.58	-65.96
2	0.180	-16.24 QP	22.50	-38.74	1.00	48	50.88	-67.12
3	0.228	-22.52 QP	20.44	-42.96	1.00	232	46.59	-69.11
4	0.250	-26.18 QP	19.64	-45.82	1.00	181	43.85	-70.03
5	0.330	-31.62 QP	17.23	-48.85	1.00	323	40.99	-72.61
6	0.392	-36.48 QP	15.74	-52.22	1.00	160	37.19	-73.67

Remarks:

1. Emission Level(dBuV/m) = Raw Value(dBuV) + Correction Factor(dB/m)
2. Correction Factor(dB/m) = Antenna Factor(dB/m) + Cable Factor(dB) – Pre-Amplifier Factor(dB) + Distance Factor
3. Margin value = Emission Level – Limit value
4. The other emission levels were very low against the limit.
5. The test distance for below 0.49MHz is 3m, extrapolate the measured field strength to a distance of 300 meters.
Distance factor@3m = $40 \cdot \log(3/300) = -80\text{dB}$

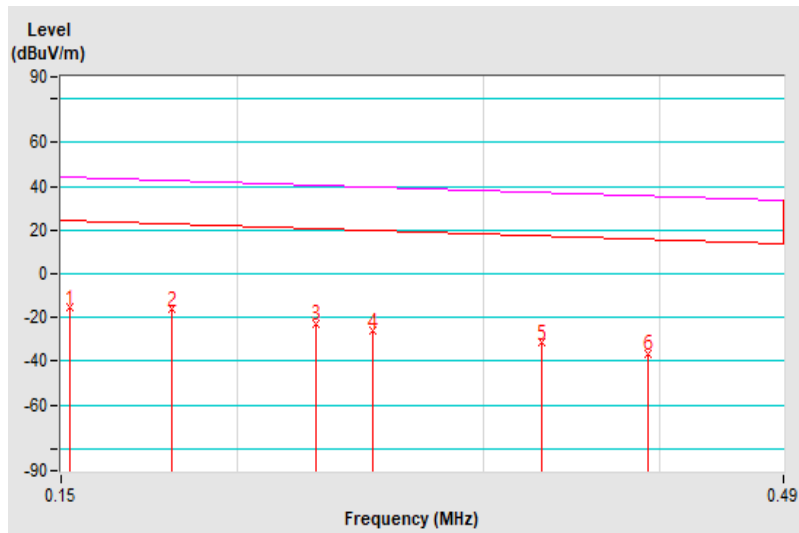

Frequency Range	490kHz ~ 30MHz	Detector Function	Peak/Average
-----------------	----------------	-------------------	--------------

Antenna Polarity : Parallel								
No	Frequency (MHz)	Emission Level (dBuV/m)	Limit (dBuV/m)	Margin (dB)	Antenna Height (m)	Table Angle (Degree)	Raw Value (dBuV)	Correction Factor (dB/m)
1	0.684	-2.74 QP	30.90	-33.64	1.00	225	34.22	-36.96
2	2.899	-10.27 QP	29.54	-39.81	1.00	287	33.28	-43.55
3	4.734	-8.79 QP	29.54	-38.33	1.00	157	35.07	-43.86
4	6.003	-11.15 QP	29.54	-40.69	1.00	34	32.53	-43.68
5	23.129	5.41 QP	29.54	-24.13	1.00	344	49.37	-43.96
6	27.157	5.85 QP	29.54	-23.69	1.00	1	49.14	-43.29

Remarks:

1. Emission Level(dBuV/m) = Raw Value(dBuV) + Correction Factor(dB/m)
2. Correction Factor(dB/m) = Antenna Factor(dB/m) + Cable Factor(dB) – Pre-Amplifier Factor(dB) + Distance Factor
3. Margin value = Emission Level – Limit value
4. The other emission levels were very low against the limit.
5. The test distance for 0.49 ~ 30MHz is 3m, extrapolate the measured field strength to a distance of 30 meters.
Distance factor@3m = $40 \cdot \log(3/30) = -40\text{dB}$

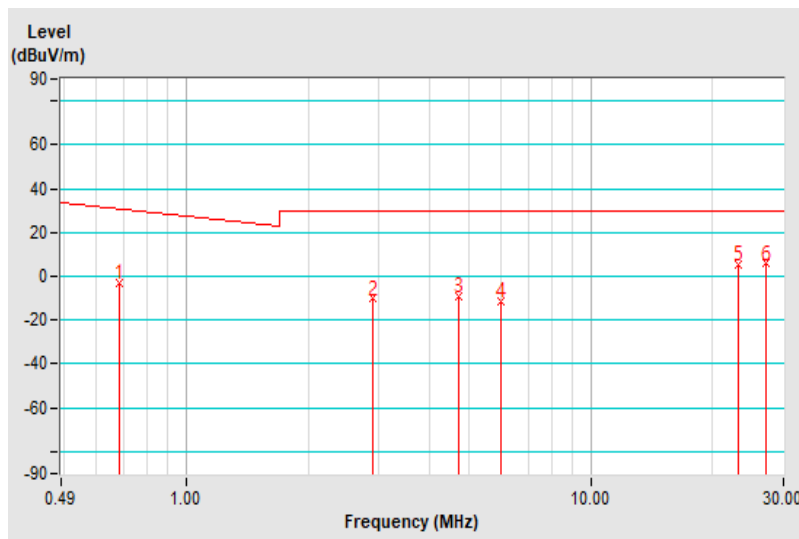

Frequency Range	9kHz ~ 150kHz	Detector Function	Peak/Average
-----------------	---------------	-------------------	--------------

Antenna Polarity : Perpendicular								
No	Frequency (MHz)	Emission Level (dBuV/m)	Limit (dBuV/m)	Margin (dB)	Antenna Height (m)	Table Angle (Degree)	Raw Value (dBuV)	Correction Factor (dB/m)
1	0.010	20.65 PK	67.60	-46.95	1.00	88	64.22	-43.57
2	0.010	18.74 AV	47.60	-28.86	1.00	88	62.31	-43.57
3	0.014	15.92 PK	64.68	-48.76	1.00	35	61.37	-45.45
4	0.014	13.88 AV	44.68	-30.80	1.00	35	59.33	-45.45
5	0.021	8.76 PK	61.16	-52.40	1.00	55	57.45	-48.69
6	0.021	6.66 AV	41.16	-34.50	1.00	55	55.35	-48.69
7	0.034	2.28 PK	56.97	-54.69	1.00	198	55.69	-53.41
8	0.034	0.39 AV	36.97	-36.58	1.00	198	53.80	-53.41
9	0.052	-7.46 PK	53.28	-60.74	1.00	0	49.73	-57.19
10	0.052	-9.31 AV	33.28	-42.59	1.00	0	47.88	-57.19
11	0.125	-20.64 PK	45.66	-66.30	1.00	60	44.20	-64.84
12	0.125	-22.57 AV	25.66	-48.23	1.00	60	42.27	-64.84

Remarks:

1. Emission Level(dBuV/m) = Raw Value(dBuV) + Correction Factor(dB/m)
2. Correction Factor(dB/m) = Antenna Factor(dB/m) + Cable Factor(dB) – Pre-Amplifier Factor(dB) + Distance Factor
3. Margin value = Emission Level – Limit value
4. The other emission levels were very low against the limit.
5. The test distance for below 0.49MHz is 3m, extrapolate the measured field strength to a distance of 300 meters.

Distance factor@3m = $40 \cdot \log(3/300) = -80\text{dB}$

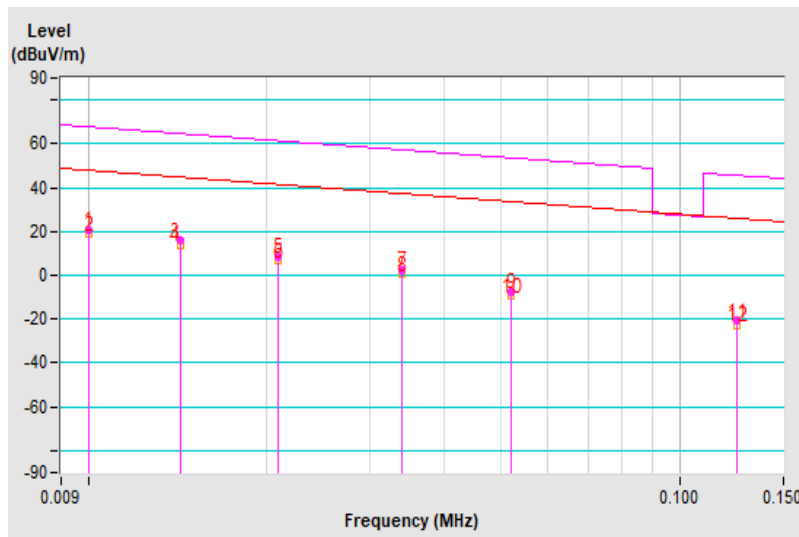

Frequency Range	150kHz ~ 490kHz	Detector Function	Peak/Average
-----------------	-----------------	-------------------	--------------

Antenna Polarity : Perpendicular								
No	Frequency (MHz)	Emission Level (dBuV/m)	Limit (dBuV/m)	Margin (dB)	Antenna Height (m)	Table Angle (Degree)	Raw Value (dBuV)	Correction Factor (dB/m)
1	0.164	-15.08 QP	23.31	-38.39	1.00	58	51.38	-66.46
2	0.204	-19.66 QP	21.41	-41.07	1.00	360	48.46	-68.12
3	0.244	-25.79 QP	19.85	-45.64	1.00	347	43.98	-69.77
4	0.317	-31.84 QP	17.58	-49.42	1.00	78	40.56	-72.40
5	0.378	-34.68 QP	16.05	-50.73	1.00	360	38.74	-73.42
6	0.413	-34.52 QP	15.28	-49.80	1.00	58	39.50	-74.02

Remarks:

1. Emission Level(dBuV/m) = Raw Value(dBuV) + Correction Factor(dB/m)
2. Correction Factor(dB/m) = Antenna Factor(dB/m) + Cable Factor(dB) – Pre-Amplifier Factor(dB) + Distance Factor
3. Margin value = Emission Level – Limit value
4. The other emission levels were very low against the limit.
5. The test distance for below 0.49MHz is 3m, extrapolate the measured field strength to a distance of 300 meters.
Distance factor@3m = $40 \cdot \log(3/300) = -80\text{dB}$

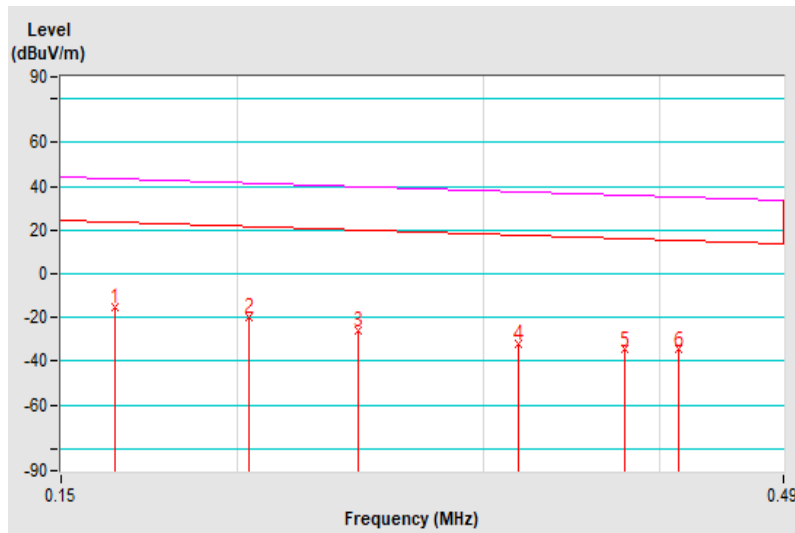

Frequency Range	490kHz ~ 30MHz	Detector Function	Quasi-Peak
-----------------	----------------	-------------------	------------

Antenna Polarity : Perpendicular								
No	Frequency (MHz)	Emission Level (dBuV/m)	Limit (dBuV/m)	Margin (dB)	Antenna Height (m)	Table Angle (Degree)	Raw Value (dBuV)	Correction Factor (dB/m)
1	0.602	-2.38 QP	32.01	-34.39	1.00	45	33.94	-36.32
2	2.869	-12.94 QP	29.54	-42.48	1.00	27	30.56	-43.50
3	4.684	-12.45 QP	29.54	-41.99	1.00	338	31.40	-43.85
4	5.951	-15.12 QP	29.54	-44.66	1.00	252	28.57	-43.69
5	23.129	-1.20 QP	29.54	-30.74	1.00	298	42.76	-43.96
6	27.160	2.09 QP	29.54	-27.45	1.00	146	45.38	-43.29

Remarks:

1. Emission Level(dBuV/m) = Raw Value(dBuV) + Correction Factor(dB/m)
2. Correction Factor(dB/m) = Antenna Factor(dB/m) + Cable Factor(dB) – Pre-Amplifier Factor(dB) + Distance Factor
3. Margin value = Emission Level – Limit value
4. The other emission levels were very low against the limit.
5. The test distance for 0.49 ~ 30MHz is 3m, extrapolate the measured field strength to a distance of 30 meters.
Distance factor@3m = $40 \cdot \log(3/30) = -40\text{dB}$

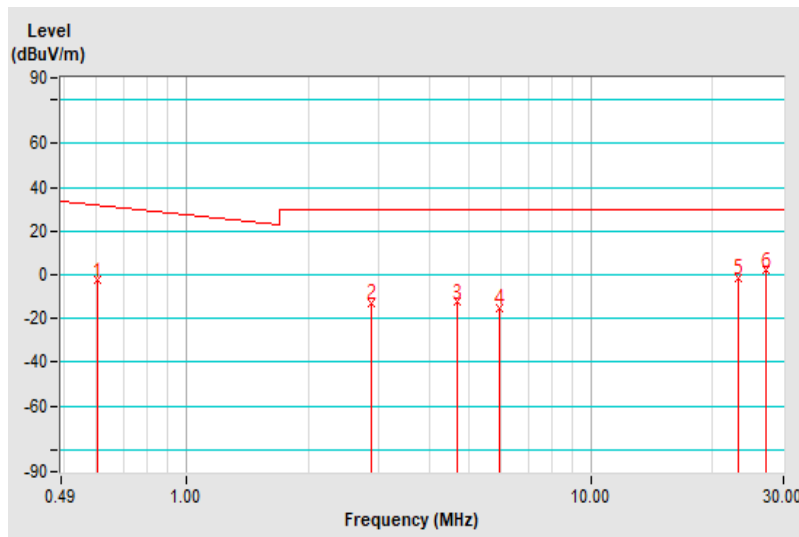

Frequency Range	9kHz ~ 150kHz	Detector Function	Peak/Average
-----------------	---------------	-------------------	--------------

Antenna Polarity : Ground-parallel								
No	Frequency (MHz)	Emission Level (dBuV/m)	Limit (dBuV/m)	Margin (dB)	Antenna Height (m)	Table Angle (Degree)	Raw Value (dBuV)	Correction Factor (dB/m)
1	0.009	20.93 PK	68.52	-47.59	1.00	245	63.59	-42.66
2	0.009	18.85 AV	48.52	-29.67	1.00	245	61.51	-42.66
3	0.014	15.13 PK	64.68	-49.55	1.00	290	60.58	-45.45
4	0.014	13.25 AV	44.68	-31.43	1.00	290	58.70	-45.45
5	0.018	10.95 PK	62.50	-51.55	1.00	335	58.27	-47.32
6	0.018	8.84 AV	42.50	-33.66	1.00	335	56.16	-47.32
7	0.026	4.50 PK	59.30	-54.80	1.00	140	55.32	-50.82
8	0.026	2.72 AV	39.30	-36.58	1.00	140	53.54	-50.82
9	0.043	-2.65 PK	54.93	-57.58	1.00	71	52.73	-55.38
10	0.043	-4.52 AV	34.93	-39.45	1.00	71	50.86	-55.38
11	0.115	-20.80 PK	46.38	-67.18	1.00	266	43.63	-64.43
12	0.115	-22.65 AV	26.39	-49.04	1.00	266	41.78	-64.43

Remarks:

1. Emission Level(dBuV/m) = Raw Value(dBuV) + Correction Factor(dB/m)
2. Correction Factor(dB/m) = Antenna Factor(dB/m) + Cable Factor(dB) – Pre-Amplifier Factor(dB) + Distance Factor
3. Margin value = Emission Level – Limit value
4. The other emission levels were very low against the limit.
5. The test distance for below 0.49MHz is 3m, extrapolate the measured field strength to a distance of 300 meters.
Distance factor@3m = $40 \cdot \log(3/300) = -80\text{dB}$

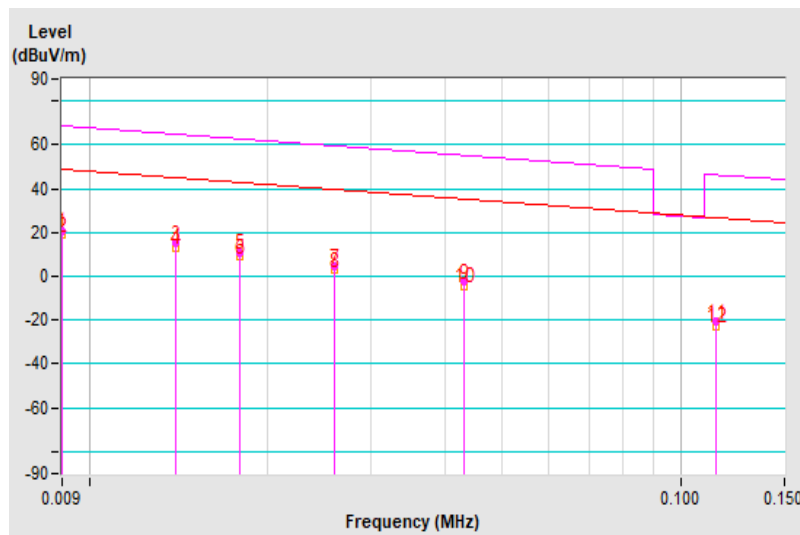

Frequency Range	150kHz ~ 490kHz	Detector Function	Peak/Average
-----------------	-----------------	-------------------	--------------

Antenna Polarity : Ground-parallel								
No	Frequency (MHz)	Emission Level (dBuV/m)	Limit (dBuV/m)	Margin (dB)	Antenna Height (m)	Table Angle (Degree)	Raw Value (dBuV)	Correction Factor (dB/m)
1	0.153	-15.59 QP	23.91	-39.50	1.00	119	50.41	-66.00
2	0.169	-15.99 QP	23.04	-39.03	1.00	0	50.67	-66.66
3	0.195	-17.98 QP	21.80	-39.78	1.00	60	49.76	-67.74
4	0.255	-26.54 QP	19.47	-46.01	1.00	82	43.70	-70.24
5	0.333	-33.56 QP	17.15	-50.71	1.00	360	39.09	-72.65
6	0.394	-35.00 QP	15.69	-50.69	1.00	338	38.69	-73.69

Remarks:

1. Emission Level(dBuV/m) = Raw Value(dBuV) + Correction Factor(dB/m)
2. Correction Factor(dB/m) = Antenna Factor(dB/m) + Cable Factor(dB) – Pre-Amplifier Factor(dB) + Distance Factor
3. Margin value = Emission Level – Limit value
4. The other emission levels were very low against the limit.
5. The test distance for below 0.49MHz is 3m, extrapolate the measured field strength to a distance of 300 meters.
Distance factor@3m = $40 \cdot \log(3/300) = -80\text{dB}$

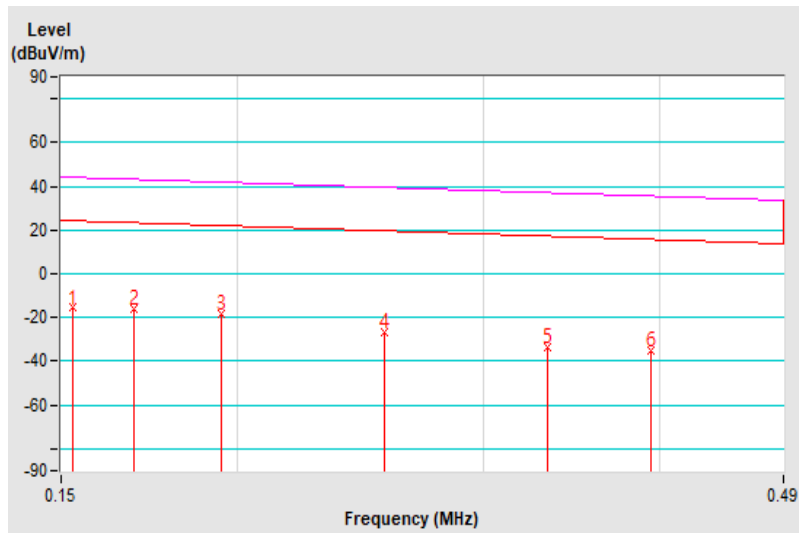

Frequency Range	490kHz ~ 30MHz	Detector Function	Quasi-Peak
-----------------	----------------	-------------------	------------

Antenna Polarity : Ground-parallel								
No	Frequency (MHz)	Emission Level (dBuV/m)	Limit (dBuV/m)	Margin (dB)	Antenna Height (m)	Table Angle (Degree)	Raw Value (dBuV)	Correction Factor (dB/m)
1	0.999	-2.48 QP	27.61	-30.09	1.00	103	36.94	-39.42
2	2.852	-5.56 QP	29.54	-35.10	1.00	207	37.90	-43.46
3	4.723	-6.55 QP	29.54	-36.09	1.00	50	37.31	-43.86
4	9.162	-9.00 QP	29.54	-38.54	1.00	2	34.08	-43.08
5	23.129	5.80 QP	29.54	-23.74	1.00	360	49.76	-43.96
6	29.238	6.82 QP	29.54	-22.72	1.00	266	49.79	-42.97

Remarks:

1. Emission Level(dBuV/m) = Raw Value(dBuV) + Correction Factor(dB/m)
2. Correction Factor(dB/m) = Antenna Factor(dB/m) + Cable Factor(dB) – Pre-Amplifier Factor(dB) + Distance Factor
3. Margin value = Emission Level – Limit value
4. The other emission levels were very low against the limit.
5. The test distance for 0.49 ~ 30MHz is 3m, extrapolate the measured field strength to a distance of 30 meters.
Distance factor@3m = $40 \cdot \log(3/30) = -40\text{dB}$

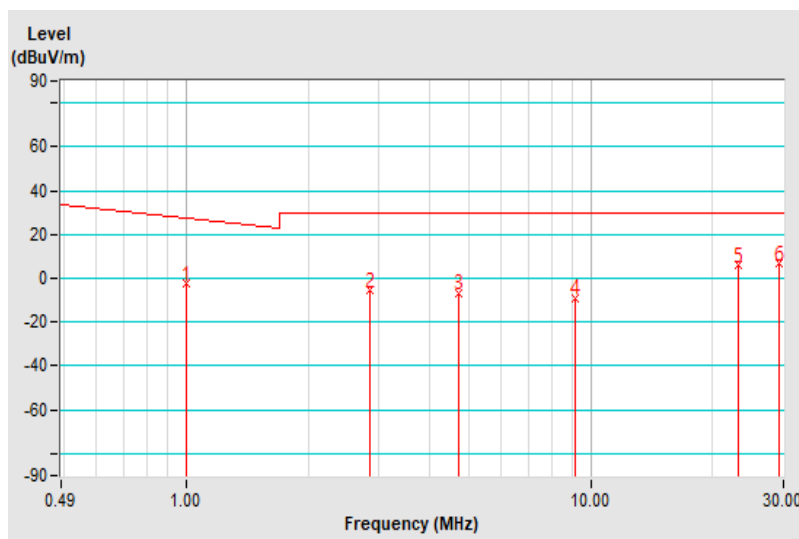

Frequency Range	30MHz ~ 1000MHz	Detector Function	Quasi-Peak
-----------------	-----------------	-------------------	------------

Antenna Polarity & Test Distance : Horizontal at 3 m								
No	Frequency (MHz)	Emission Level (dBuV/m)	Limit (dBuV/m)	Margin (dB)	Antenna Height (m)	Table Angle (Degree)	Raw Value (dBuV)	Correction Factor (dB/m)
1	36.37	28.3 QP	40.0	-11.7	3.00 H	191	37.2	-8.9
2	66.55	30.8 QP	40.0	-9.2	4.00 H	14	40.0	-9.2
3	105.42	28.4 QP	43.5	-15.1	3.00 H	105	39.5	-11.1
4	396.06	31.5 QP	46.0	-14.5	1.50 H	235	35.4	-3.9
5	434.00	33.1 QP	46.0	-12.9	1.00 H	261	35.7	-2.6
6	777.21	34.8 QP	46.0	-11.2	1.00 H	267	29.8	5.0

Remarks:

1. Emission Level(dBuV/m) = Raw Value(dBuV) + Correction Factor(dB/m)
2. Correction Factor(dB/m) = Antenna Factor(dB/m) + Cable Factor(dB) – Pre-Amplifier Factor(dB)
3. Margin value = Emission Level – Limit value
4. The other emission levels were very low against the limit of frequency range 30MHz~1000MHz.

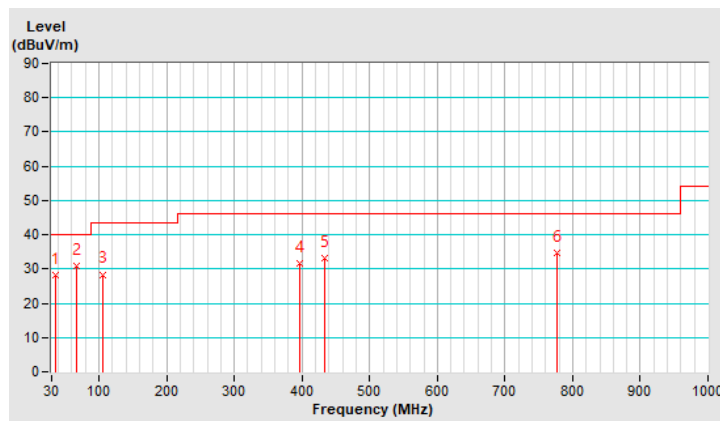

Frequency Range	30MHz ~ 1000MHz	Detector Function	Quasi-Peak
-----------------	-----------------	-------------------	------------

Antenna Polarity & Test Distance : Vertical at 3 m								
No	Frequency (MHz)	Emission Level (dBuV/m)	Limit (dBuV/m)	Margin (dB)	Antenna Height (m)	Table Angle (Degree)	Raw Value (dBuV)	Correction Factor (dB/m)
1	40.32	27.7 QP	40.0	-12.3	1.50 V	360	36.0	-8.3
2	66.77	32.3 QP	40.0	-7.7	1.00 V	356	41.5	-9.2
3	106.97	26.0 QP	43.5	-17.5	2.00 V	0	36.8	-10.8
4	348.65	29.9 QP	46.0	-16.1	2.50 V	307	35.2	-5.3
5	433.90	31.0 QP	46.0	-15.0	1.00 V	21	33.6	-2.6
6	854.06	34.8 QP	46.0	-11.2	4.00 V	28	28.9	5.9

Remarks:

1. Emission Level(dBuV/m) = Raw Value(dBuV) + Correction Factor(dB/m)
2. Correction Factor(dB/m) = Antenna Factor(dB/m) + Cable Factor(dB) – Pre-Amplifier Factor(dB)
3. Margin value = Emission Level – Limit value
4. The other emission levels were very low against the limit of frequency range 30MHz~1000MHz.

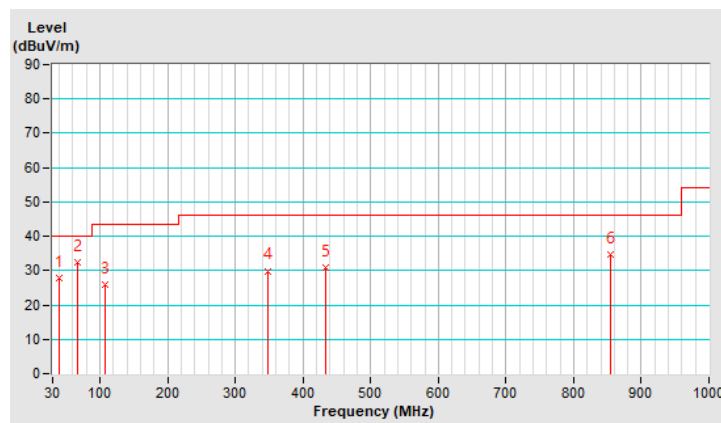

4.2 Conducted Emission Measurement

4.2.1 Limits of Conducted Emission Measurement

Frequency (MHz)	Conducted Limit (dBuV)	
	Quasi-peak	Average
0.15 - 0.5	66 - 56	56 - 46
0.50 - 5.0	56	46
5.0 - 30.0	60	50

- Note: 1. The lower limit shall apply at the transition frequencies.
 2. The limit decreases in line with the logarithm of the frequency in the range of 0.15 to 0.50MHz.
 3. All emanations from a class A/B digital device or system, including any network of conductors and apparatus connected thereto, shall not exceed the level of field strengths specified above.

4.2.2 Test Instruments

DESCRIPTION & MANUFACTURER	MODEL NO.	SERIAL NO.	CALIBRATED DATE	CALIBRATED UNTIL
Test Receiver R&S	ESCS 30	847124/029	Oct. 23, 2019	Oct. 22, 2020
Line-Impedance Stabilization Network (for EUT) R&S	ESH3-Z5	848773/004	Oct. 23, 2019	Oct. 22, 2020
Line-Impedance Stabilization Network (for Peripheral) R&S	ESH3-Z5	835239/001	Mar. 19, 2020	Mar. 18, 2021
50 ohms Terminator	50	3	Oct. 23, 2019	Oct. 22, 2020
RF Cable	5D-FB	COCCAB-001	Sep. 27, 2019	Sep. 26, 2020
Fixed attenuator EMCI	STI02-2200-10	005	Aug. 30, 2019	Aug. 29, 2020
Software BVADT	BVADT_Cond_V7.3.7.4	NA	NA	NA

Note:

- The calibration interval of the above test instruments are 12 months and the calibrations are traceable to NML/ROC and NIST/USA.
- The test was performed in Conduction 1.
- Tested Date: July 13, 2020

4.2.3 Test Procedures

- a. The EUT was placed 0.4 meters from the conducting wall of the shielded room with EUT being connected to the power mains through a line impedance stabilization network (LISN). Other support units were connected to the power mains through another LISN. The two LISNs provide 50 ohm/ 50uH of coupling impedance for the measuring instrument.
- b. Both lines of the power mains connected to the EUT were checked for maximum conducted interference.
- c. The frequency range from 150kHz to 30MHz was searched. Emission levels under (Limit - 20dB) was not recorded.

Note: The resolution bandwidth and video bandwidth of test receiver is 9kHz for quasi-peak detection (QP) and average detection (AV) at frequency 0.15MHz-30MHz.

4.2.4 Deviation from Test Standard

No deviation.

4.2.5 Test Setup

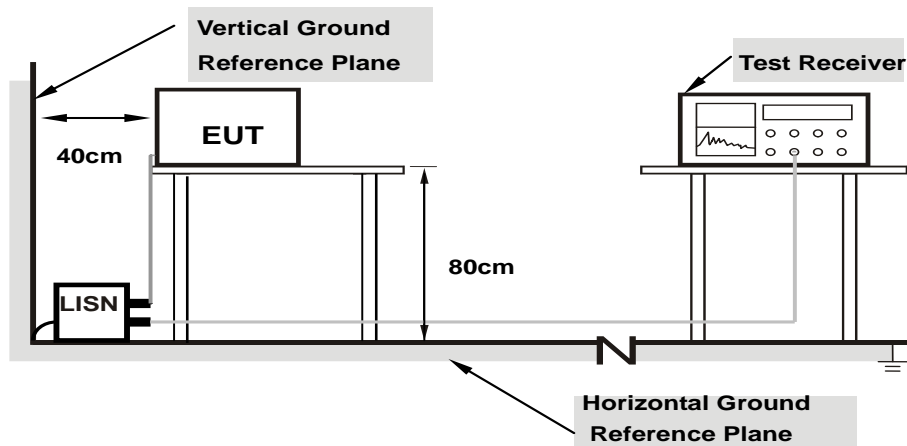

Note: 1.Support units were connected to second LISN.

2.Both of LISNs (AMN) are 80 cm from EUT and at least 80 from other units and other metal planes

For the actual test configuration, please refer to the attached file (Test Setup Photo).

4.2.6 EUT Operating Conditions

Same as 4.1.6.

4.2.7 Test Results

Phase	Line (L)	Detector Function	Quasi-Peak (QP) / Average (AV)
-------	----------	-------------------	--------------------------------

No	Freq. [MHz]	Corr. Factor (dB)	Reading Value [dB (uV)]		Emission Level [dB (uV)]		Limit [dB (uV)]		Margin (dB)	
			Q.P.	AV.	Q.P.	AV.	Q.P.	AV.	Q.P.	AV.
			1	0.15000	10.02	28.41	14.66	38.43	24.68	66.00
2	0.16953	10.03	23.43	8.25	33.46	18.28	64.98	54.98	-31.52	-36.70
3	0.20078	10.04	18.18	4.44	28.22	14.48	63.58	53.58	-35.36	-39.10
4	0.37266	10.06	12.46	7.75	22.52	17.81	58.44	48.44	-35.92	-30.63
5	1.07422	10.11	13.55	10.30	23.66	20.41	56.00	46.00	-32.34	-25.59
6	1.53906	10.15	11.38	8.05	21.53	18.20	56.00	46.00	-34.47	-27.80

Remarks:

1. Q.P. and AV. are abbreviations of quasi-peak and average individually.
2. The emission levels of other frequencies were very low against the limit.
3. Margin value = Emission level – Limit value
4. Correction factor = Insertion loss + Cable loss
5. Emission Level = Correction Factor + Reading Value

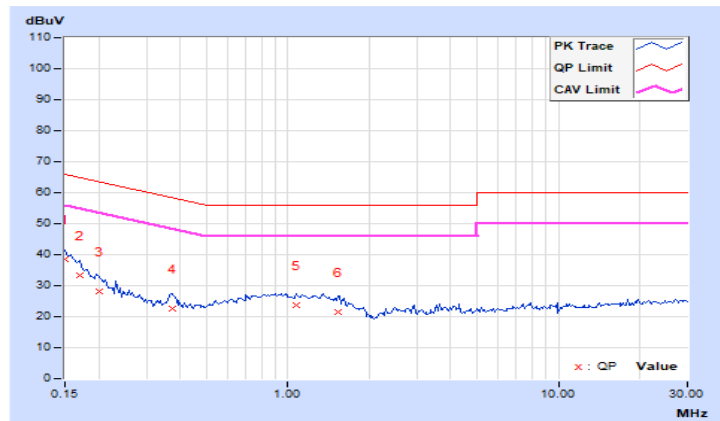

Phase	Neutral (N)	Detector Function	Quasi-Peak (QP) / Average (AV)
-------	-------------	-------------------	--------------------------------

No	Freq. [MHz]	Corr.	Reading Value		Emission Level		Limit		Margin	
		Factor	[dB (uV)]		[dB (uV)]		[dB (uV)]		(dB)	
		(dB)	Q.P.	AV.	Q.P.	AV.	Q.P.	AV.	Q.P.	AV.
1	0.15000	10.02	29.70	15.87	39.72	25.89	66.00	56.00	-26.28	-30.11
2	0.20078	10.04	21.36	10.64	31.40	20.68	63.58	53.58	-32.18	-32.90
3	0.23984	10.04	20.75	12.93	30.79	22.97	62.10	52.10	-31.31	-29.13
4	0.37656	10.06	22.60	18.88	32.66	28.94	58.35	48.35	-25.69	-19.41
5	0.89609	10.12	16.85	13.09	26.97	23.21	56.00	46.00	-29.03	-22.79
6	1.38672	10.16	18.04	13.90	28.20	24.06	56.00	46.00	-27.80	-21.94

Remarks:

1. Q.P. and AV. are abbreviations of quasi-peak and average individually.
2. The emission levels of other frequencies were very low against the limit.
3. Margin value = Emission level – Limit value
4. Correction factor = Insertion loss + Cable loss
5. Emission Level = Correction Factor + Reading Value

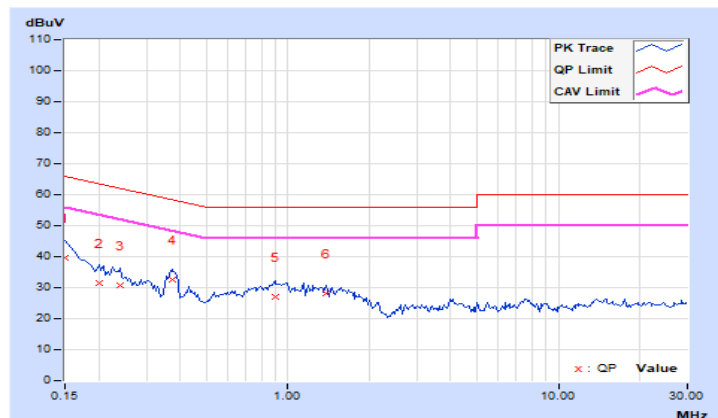

4.3 Frequency Stability

4.3.1 Limits of Frequency Stability Measurement

The frequency tolerance of the carrier signal shall be maintained within $\pm 0.01\%$ of the operating frequency over a temperature variation of -20 degrees to 50 degrees C at normal supply voltage, and for a variation in the primary supply voltage from 85% to 115% of the rated supply voltage at a temperature of 20 degrees C.

4.3.2 Test Setup

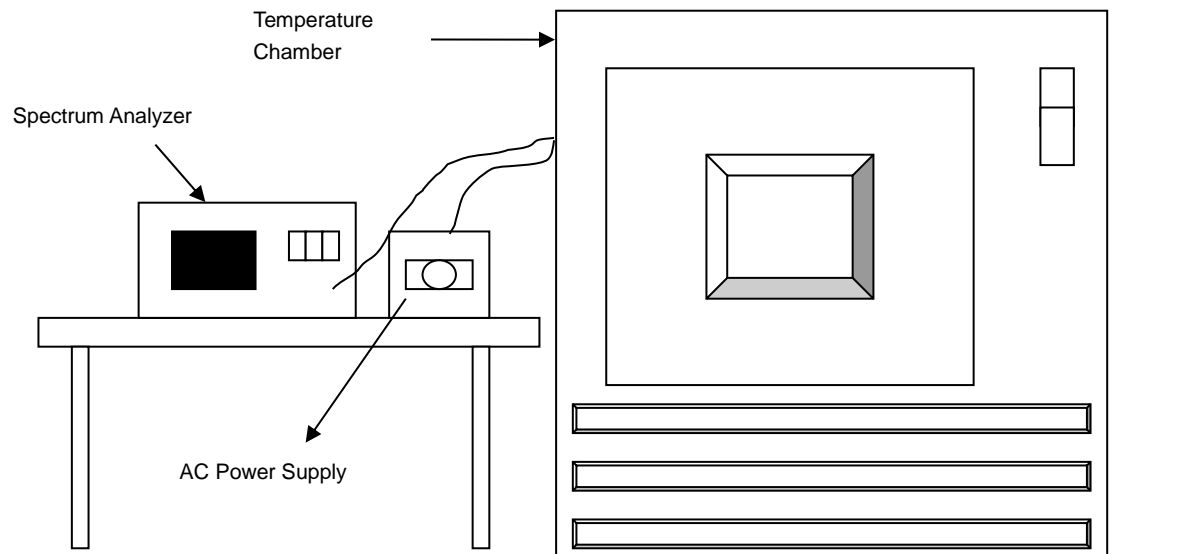

4.3.3 Test Instruments

Refer to section 4.1.2 to get information of above instrument.

4.3.4 Test Procedure

- a. The EUT was placed inside the environmental test chamber and powered by nominal AC voltage.
- b. Turned the EUT on and coupled its output to a spectrum analyzer.
- c. Turned the EUT off and set the chamber to the highest temperature specified.
- d. Allowed sufficient time (approximately 30 min) for the temperature of the chamber to stabilize then turned the EUT on and measured the operating frequency after 2, 5, and 10 minutes.
- e. Repeated step 2 and 3 with the temperature chamber set to the lowest temperature.
- f. The test chamber was allowed to stabilize at $+20$ degree C for a minimum of 30 minutes. The supply voltage was then adjusted on the EUT from 85% to 115% and the frequency record.

4.3.5 Deviation from Test Standard

No deviation.

4.3.6 EUT Operating Conditions

Same as Item 4.1.6.

4.3.7 Test Result

Frequency Stability Versus Temp.									
TEMP. (°C)	Power Supply (Vac)	0 Minute		2 Minutes		5 Minutes		10 Minutes	
		Measured Frequency	Frequency Drift	Measured Frequency	Frequency Drift	Measured Frequency	Frequency Drift	Measured Frequency	Frequency Drift
		(MHz)	%	(MHz)	%	(MHz)	%	(MHz)	%
50	120	13.56002	0.00015	13.56002	0.00015	13.56001	0.00007	13.56002	0.00015
40	120	13.55995	-0.00037	13.55996	-0.00029	13.55995	-0.00037	13.55996	-0.00029
30	120	13.55999	-0.00007	13.56001	0.00007	13.55999	-0.00007	13.56001	0.00007
20	120	13.55995	-0.00037	13.55995	-0.00037	13.55996	-0.00029	13.55995	-0.00037
10	120	13.56004	0.00029	13.56004	0.00029	13.56005	0.00037	13.56005	0.00037
0	120	13.55995	-0.00037	13.55997	-0.00022	13.55997	-0.00022	13.55997	-0.00022
-10	120	13.56006	0.00044	13.56006	0.00044	13.56005	0.00037	13.56004	0.00029
-20	120	13.55995	-0.00037	13.55994	-0.00044	13.55993	-0.00052	13.55995	-0.00037

Frequency Stability Versus Voltage									
TEMP. (°C)	Power Supply (Vac)	0 Minute		2 Minutes		5 Minutes		10 Minutes	
		Measured Frequency	Frequency Drift	Measured Frequency	Frequency Drift	Measured Frequency	Frequency Drift	Measured Frequency	Frequency Drift
		(MHz)	%	(MHz)	%	(MHz)	%	(MHz)	%
20	138	13.55995	-0.00037	13.55995	-0.00037	13.55996	-0.00029	13.55995	-0.00037
	120	13.55995	-0.00037	13.55995	-0.00037	13.55996	-0.00029	13.55995	-0.00037
	102	13.55995	-0.00037	13.55995	-0.00037	13.55996	-0.00029	13.55995	-0.00037

4.4 20dB Bandwidth

4.4.1 Limits of 20dB BANDWIDTH Measurement

The 20dB bandwidth shall be specified in operating frequency band.

4.4.2 Test Setup

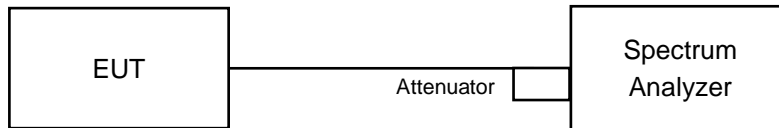

4.4.3 Test Instruments

Refer to section 4.1.2 to get information of above instrument.

4.4.4 Test Procedures

The bandwidth of the fundamental frequency was measured by spectrum analyzer with 10kHz RBW and 30kHz VBW. The 20dB bandwidth is defined as the total spectrum the power of which is higher than peak power minus 20dB.

4.4.5 Deviation from Test Standard

No deviation.

4.4.6 EUT Operating Conditions

Same as Item 4.1.6.

4.4.7 Test Results

20dBc Point (Low) (MHz)	20dBc Point (High) (MHz)	Operating Frequency Band (MHz)	Pass/Fail
13.560625	13.560843	13.11 – 14.01	Pass

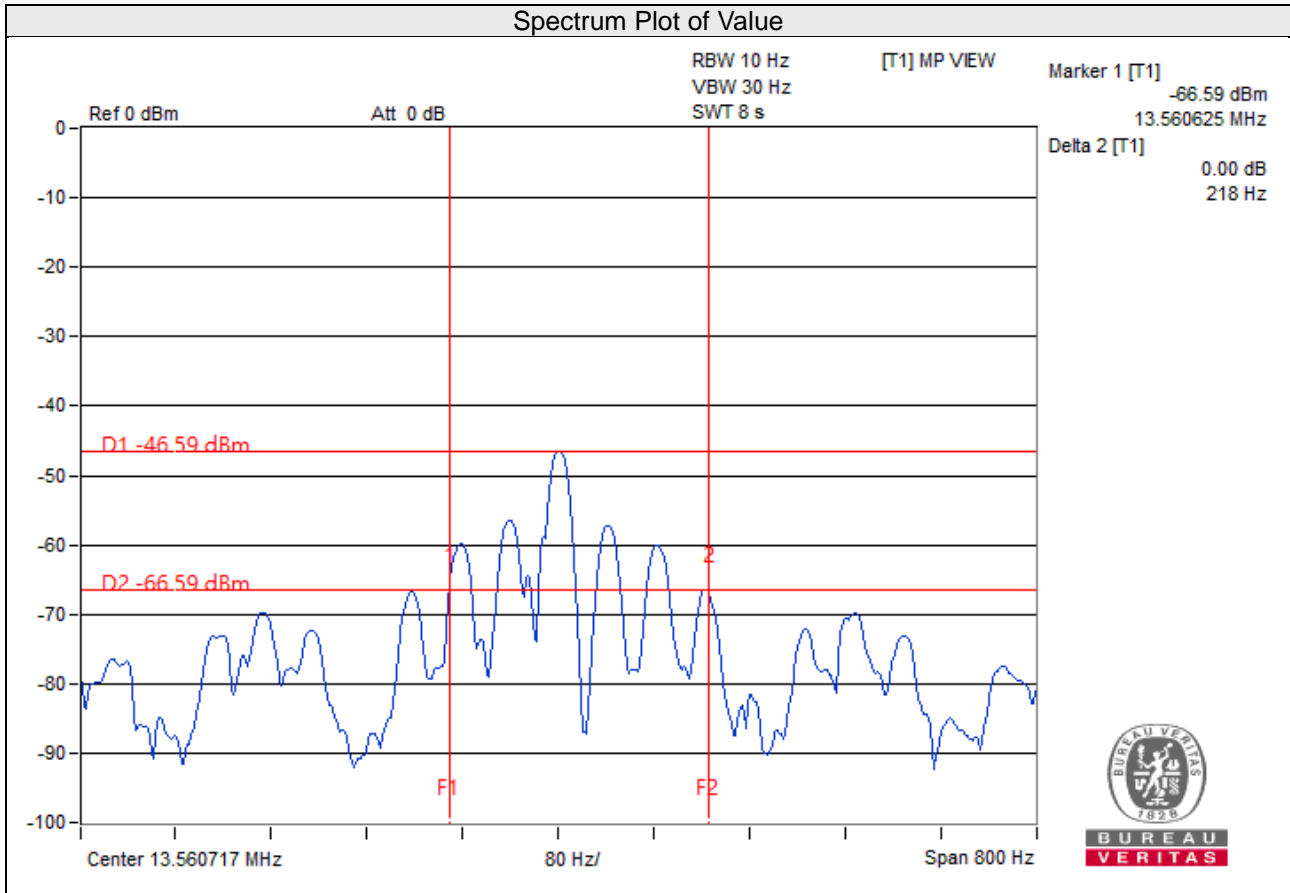

5 Pictures of Test Arrangements

Please refer to the attached file (Test Setup Photo).

Appendix – Information of the Testing Laboratories

We, Bureau Veritas Consumer Products Services (H.K.) Ltd., Taoyuan Branch, were founded in 1988 to provide our best service in EMC, Radio, Telecom and Safety consultation. Our laboratories are FCC recognized accredited test firms and accredited according to ISO/IEC 17025.

If you have any comments, please feel free to contact us at the following:

Lin Kou EMC/RF Lab

Tel: 886-2-26052180

Fax: 886-2-26051924

Hsin Chu EMC/RF/Telecom Lab

Tel: 886-3-6668565

Fax: 886-3-6668323

Hwa Ya EMC/RF/Safety Lab

Tel: 886-3-3183232

Fax: 886-3-3270892

Email: service.adt@tw.bureauveritas.com

Web Site: www.bureauveritas-adt.com

The address and road map of all our labs can be found in our web site also.

--- END ---