

FCC Test Report

Report No.: RF171201E03

FCC ID: MQT-AP10

Test Model: xCL_AP-10

Received Date: Dec. 01, 2017

Test Date: Dec. 06 to 13, 2017

Issued Date: Dec. 21, 2017

Applicant: XAC AUTOMATION CORP.

Address: 4F, No. 30, INDUSTRY E. RD. IX, SCIENCE-BASED INDUSTRIAL
PARK,HSINCHU,TAIWAN

Issued By: Bureau Veritas Consumer Products Services (H.K.) Ltd., Taoyuan Branch
Hsin Chu Laboratory

Lab Address: E-2, No.1, Li Hsin 1st Road, Hsinchu Science Park, Hsinchu City 300,
Taiwan R.O.C.

Test Location : E-2, No.1, Li Hsin 1st Road, Hsinchu Science Park, Hsinchu City 300,
Taiwan R.O.C.

**FCC Registration /
Designation Number:** 723255 / TW2022



This report is for your exclusive use. Any copying or replication of this report to or for any other person or entity, or use of our name or trademark, is permitted only with our prior written permission. This report sets forth our findings solely with respect to the test samples identified herein. The results set forth in this report are not indicative or representative of the quality or characteristics of the lot from which a test sample was taken or any similar or identical product unless specifically and expressly noted. Our report includes all of the tests requested by you and the results thereof based upon the information that you provided to us. You have 60 days from date of issuance of this report to notify us of any material error or omission caused by our negligence, provided, however, that such notice shall be in writing and shall specifically address the issue you wish to raise. A failure to raise such issue within the prescribed time shall constitute your unqualified acceptance of the completeness of this report, the tests conducted and the correctness of the report contents. Unless specific mention, the uncertainty of measurement has been explicitly taken into account to declare the compliance or non-compliance to the specification. The report must not be used by the client to claim product certification, approval, or endorsement by TAF or any government agencies.

Table of Contents

Release Control Record	3
1 Certificate of Conformity	4
2 Summary of Test Results	5
2.1 Measurement Uncertainty	5
2.2 Modification Record	5
3 General Information	6
3.1 General Description of EUT	6
3.2 Description of Test Modes	8
3.2.1 Test Mode Applicability and Tested Channel Detail	9
3.3 Description of Support Units	11
3.3.1 Configuration of System under Test	12
3.4 General Description of Applied Standards	18
4 Test Types and Results	19
4.1 Radiated Emission Measurement	19
4.1.1 Limits of Radiated Emission Measurement	19
4.1.2 Test Instruments	20
4.1.3 Test Procedures	21
4.1.4 Deviation from Test Standard	21
4.1.5 Test Setup	22
4.1.6 EUT Operating Conditions	23
4.1.7 Test Results	24
4.2 Conducted Emission Measurement	28
4.2.1 Limits of Conducted Emission Measurement	28
4.2.2 Test Instruments	28
4.2.3 Test Procedures	29
4.2.4 Deviation from Test Standard	29
4.2.5 TEST SETUP	29
4.2.6 EUT Operating Conditions	29
4.2.7 Test Results (Mode 1)	30
4.2.8 Test Results (Mode 2)	32
4.2.9 Test Results (Mode 3)	34
4.2.10 Test Results (Mode 4)	36
4.2.11 Test Results (Mode 5)	38
4.2.12 Test Results (Mode 6)	40
4.3 Frequency Stability	42
4.3.1 Limits of Frequency Stability Measurement	42
4.3.2 Test Setup	42
4.3.3 Test Instruments	42
4.3.4 Test Procedure	42
4.3.5 Deviation from Test Standard	42
4.3.6 EUT Operating Conditions	43
4.3.7 Test Result	43
4.4 20dB bandwidth	44
4.4.1 Limits of 20dB bandwidth Measurement	44
4.4.2 Test Setup	44
4.4.3 Test Instruments	44
4.4.4 Test Procedures	44
4.4.5 Deviation from Test Standard	44
4.4.6 EUT Operating Conditions	44
4.4.7 Test Results	45
5 Pictures of Test Arrangements	46
Appendix – Information on the Testing Laboratories	47

Release Control Record

Issue No.	Description	Date Issued
RF171201E03	Original release.	Dec. 21, 2017

1 Certificate of Conformity

Product: PINPAD

Brand: XAC

Test Model: xCL_AP-10

Sample Status: ENGINEERING SAMPLE

Applicant: XAC AUTOMATION CORP.

Test Date: Dec. 06 to 13, 2017

Standards: 47 CFR FCC Part 15, Subpart C (Section 15.225)
47 CFR FCC Part 15, Subpart C (Section 15.215)
ANSI C63.10:2013

The above equipment has been tested by **Bureau Veritas Consumer Products Services (H.K.) Ltd., Taoyuan Branch**, and found compliance with the requirement of the above standards. The test record, data evaluation & Equipment Under Test (EUT) configurations represented herein are true and accurate accounts of the measurements of the sample's EMC characteristics under the conditions specified in this report.

Prepared by :  , **Date:** Dec. 21, 2017
Claire Kuan / Specialist

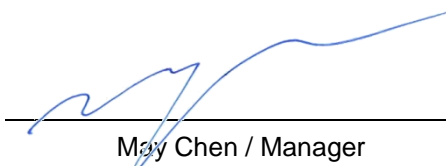
Approved by :  , **Date:** Dec. 21, 2017
May Chen / Manager

2 Summary of Test Results

47 CFR FCC Part 15, Subpart C (SECTION 15.225, 15.215)			
FCC Clause	Test Item	Result	Remarks
15.207	Conducted emission test	PASS	Meet the requirement of limit. Minimum passing margin is -0.77dB at 0.26719MHz.
15.225 (a)	The field strength of any emissions within the band 13.553-13.567 MHz	PASS	Meet the requirement of limit.
15.225 (b)	The field strength of any emissions within the bands 13.410-13.553 MHz and 13.567-13.710 MHz	PASS	Meet the requirement of limit.
15.225 (c)	The field strength of any emissions within the bands 13.110-13.410 MHz and 13.710-14.010 MHz	PASS	Meet the requirement of limit.
15.225 (d)	The field strength of any emissions appearing outside of the 13.110-14.010 MHz band	PASS	Meet the requirement of limit. Minimum passing margin is -0.40dB at 35.58MHz.
15.225 (e)	The frequency tolerance	PASS	Meet the requirement of limit.
15.215 (c)	20dB Bandwidth	PASS	Meet the requirement of limit.
15.203	Antenna Requirement	PASS	No antenna connector is used.

2.1 Measurement Uncertainty

Where relevant, the following measurement uncertainty levels have been estimated for tests performed on the EUT as specified in CISPR 16-4-2:

Measurement	Frequency	Expanded Uncertainty (k=2) (\pm)
Conducted Emissions at mains ports	150kHz ~ 30MHz	1.84 dB
Radiated Emissions up to 1 GHz	30MHz ~ 1GHz	5.32 dB
Radiated Emissions above 1 GHz	1GHz ~ 6GHz	5.14 dB
	6GHz ~ 18GHz	5.04 dB
	18GHz ~ 40GHz	5.25 dB

2.2 Modification Record

There were no modifications required for compliance.

3 General Information

3.1 General Description of EUT

Product	PINPAD
Brand	XAC
Test Model	xCL_AP-10
Status of EUT	ENGINEERING SAMPLE
Power Supply Rating	5Vdc from USB interface
Modulation Type	ASK
Operating Frequency	13.56MHz
Number of Channel	1
Antenna Type	Refer to Note
Antenna Connector	Refer to Note
Accessory Device	NA
Data Cable Supplied	CABLE POWER-USB(A)/MINI USB(B) cable x 1 (1.2m, Shielded) CABLE POWER-DB9/MINI USB(B) cable x 1 (1.2m, Shielded) xCL_AP-10 ETHERNET CABLE x 1 (2m, Shielded)

Note:

1. The EUT needs to be supplied from a power adapter or POE, the information is as below table:

Power adapter (only for test not for sale)		
Brand	Model Name	Specification
MOSO	MSA-C2000IC5.0-12W-US	Input: AC100-240V, 0.5A, 50/60Hz Output: DC 5V, 2A DC output cable (Unshielded, 1.2 m)
POE (only for test not for sale)		
Brand	Model Name	Specification
FO Shan Great Power Co, Ltd	GRT-480050	Input: AC100-240V, 0.8A, 50/60Hz Output: DC 48V, 500mA
*POE is assembly with POE cable for test, the information is as below table:		
Brand	Model Name	Specification
XAC	xCL_AP-10 ETHERNET CABLE	Input: 48V, 270mA for POE Equipment; 5V, 2.0A for AC Adapter Output: DC 5V, 2.0A

2. The antenna provided to the EUT, please refer to the following table:

Brand	Model	Antenna Net Gain(dBi)	Frequency rang (MHz)	Antenna type	Connector type
XAC	ASM T103P	13	13.56	Wire	none

3. For radiated emissions, the EUT was pre-tested under the following modes:

Test Mode	Description
Mode A	xCL_AP-10 ETHERNET CABLE (USB) /MINI USB(B) cable for POE
Mode B	CABLE POWER-USB(A)/MINI USB(B) cable for Power adapter
Mode C	CABLE POWER-DB9/MINI USB(B) cable for Power adapter
Mode D	xCL_AP-10 ETHERNET CABLE (USB) /MINI USB(B) cable for Power adapter
Mode E	xCL_AP-10 ETHERNET CABLE (RS232) /MINI USB(B) cable for Power adapter

From the above modes, the worst case was found in **Mode A**. Therefore only the test data of the mode was recorded in this report.

4. The above EUT information is declared by manufacturer and for more detailed features description, please refer to the manufacturer's specifications or user's manual.

3.2 Description of Test Modes

One channel was provided to this EUT:

Channel	FREQ. (MHz)
1	13.56

3.2.1 Test Mode Applicability and Tested Channel Detail

EUT CONFIGURE MODE	APPLICABLE TO				DESCRIPTION
	RE	PLC	FS	EB	
1	√	√	√	√	xCL_AP-10 ETHERNET CABLE (USB) /MINI USB(B) cable for POE
2	-	√	-	-	CABLE POWER-USB(A)/MINI USB(B) cable for Power adapter
3	-	√	-	-	CABLE POWER-DB9/MINI USB(B) cable for Power adapter
4	-	√	-	-	xCL_AP-10 ETHERNET CABLE (USB) /MINI USB(B) cable for Power adapter
5	-	√	-	-	xCL_AP-10 ETHERNET CABLE (RS232) /MINI USB(B) cable for Power adapter
6	-	√	-	-	xCL_AP-10 ETHERNET CABLE (RS232) /MINI USB(B) cable for POE

Where **RE:** Radiated Emission
FS: Frequency Stability

PLC: Power Line Conducted Emission
EB: 20dB Bandwidth measurement

NOTE: "-" means no effect.

RADIATED EMISSION TEST:

- Pre-Scan has been conducted to determine the worst-case mode from all possible combinations between available modulations, data rates and antenna ports (if EUT with antenna diversity architecture).
- Following channel(s) was (were) selected for the final test as listed below.

AVAILABLE CHANNEL	TESTED CHANNEL	MODULATION TYPE
1	1	ASK

POWER LINE CONDUCTED EMISSION TEST:

- Pre-Scan has been conducted to determine the worst-case mode from all possible combinations between available modulations, data rates and antenna ports (if EUT with antenna diversity architecture).
- Following channel(s) was (were) selected for the final test as listed below.

AVAILABLE CHANNEL	TESTED CHANNEL	MODULATION TYPE
1	1	ASK

FREQUENCY STABILITY:

- Pre-Scan has been conducted to determine the worst-case mode from all possible combinations between available modulations, data rates and antenna ports (if EUT with antenna diversity architecture).
- Following channel(s) was (were) selected for the final test as listed below.

AVAILABLE CHANNEL	TESTED CHANNEL	MODULATION TYPE
1	1	ASK

20dB BANDWIDTH:

- Pre-Scan has been conducted to determine the worst-case mode from all possible combinations between available modulations, data rates and antenna ports (if EUT with antenna diversity architecture).
- Following channel(s) was (were) selected for the final test as listed below.

AVAILABLE CHANNEL	TESTED CHANNEL	MODULATION TYPE
1	1	ASK

TEST CONDITION:

Applicable To	Environmental Conditions	Input Power (System)	Tested By
RE	23deg. C, 69%RH	120Vac, 60Hz	Robert Cheng
PLC	25deg. C, 75%RH	120Vac, 60Hz	Andy Ho
FS	25deg. C, 60%RH	120Vac, 60Hz	Anderson Chen
EB	25deg. C, 60%RH	120Vac, 60Hz	Anderson Chen

3.3 Description of Support Units

The EUT has been tested as an independent unit together with other necessary accessories or support units. The following support units or accessories were used to form a representative test configuration during the tests.

ID	Product	Brand	Model No.	Serial No.	FCC ID	Remarks
A.	SAM Card	NA	NA	NA	NA	Supplied by client
B.	SAM Card	NA	NA	NA	NA	Supplied by client
C.	Laptop	DELL	E6420	B92T3R1	FCC DoC	Provided by Lab
D.	Adapter	MOSO	MSA-C2000IC5.0-12W-US	NA	NA	Supplied by client
E.	PoE Adapter	FO Shan Great Power	GRT-480050	NA	NA	Supplied by client
F.	Laptop	DELL	E6420	482T3R1	FCC DoC	Provided by Lab
G.	NFC Card	XAC	NA	NA	NA	Supplied by client

Note:

1. All power cords of the above support units are non-shielded (1.8m).

ID	Descriptions	Qty.	Length (m)	Shielding (Yes/No)	Cores (Qty.)	Remarks
1.	CABLE POWER-USB(A)/MINI USB(B) cable (Y type)	1	1.2	Yes	0	Supplied by client
2.	DC Cable	1	1.2	No	0	Supplied by client
3.	RS-232 Cable	1	1.8	Yes	0	Provided by Lab
4.	xCL_AP-10 ETHERNET Cable (USB) /MINI USB(B)(Y type)	1	1.9	Yes	0	Supplied by client
5.	xCL_AP-10 ETHERNET Cable (RS232)/MINI USB(B) (Y type)	1	1.9	Yes	0	Supplied by client
6.	RJ-45 Cable	1	10	No	0	Provided by Lab
7.	RJ-45 Cable	1	3	No	0	Provided by Lab
8.	CABLE POWER-DB9/MINI USB(B) cable (Y type)	1	1.2	Yes	0	Supplied by client

3.3.1 Configuration of System under Test

For conducted test mode 1:

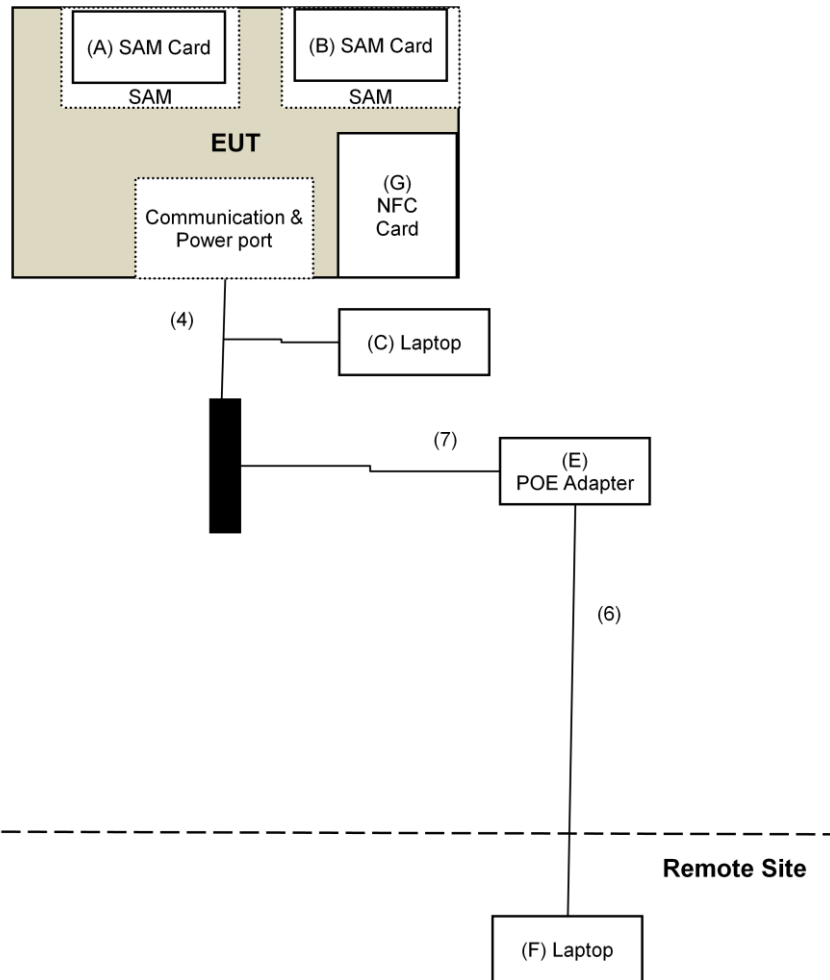

For radiated test mode 1:

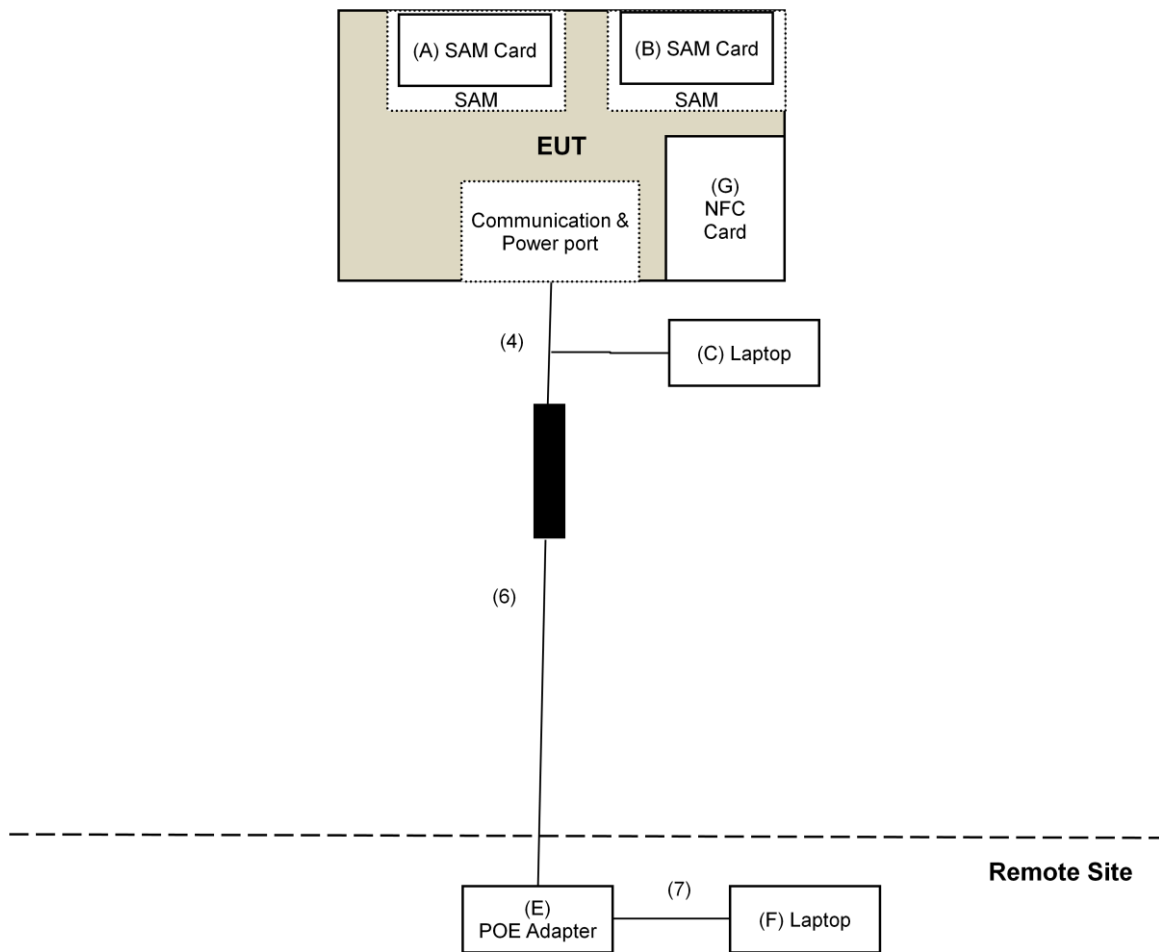

For conducted and radiated test mode 2:

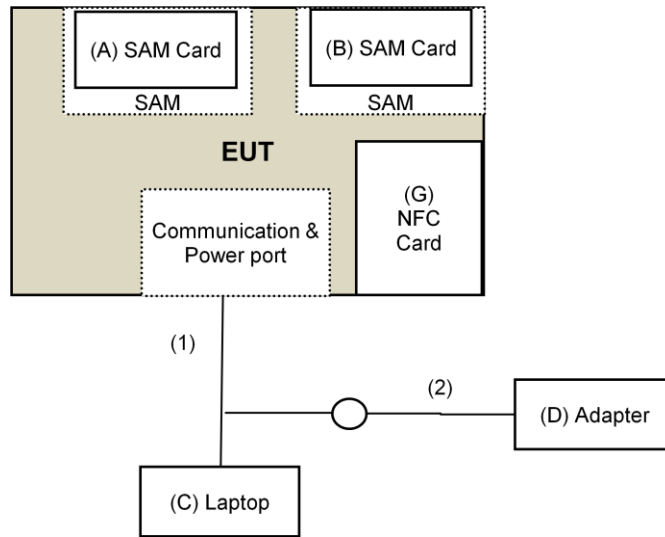

For Mode 3:

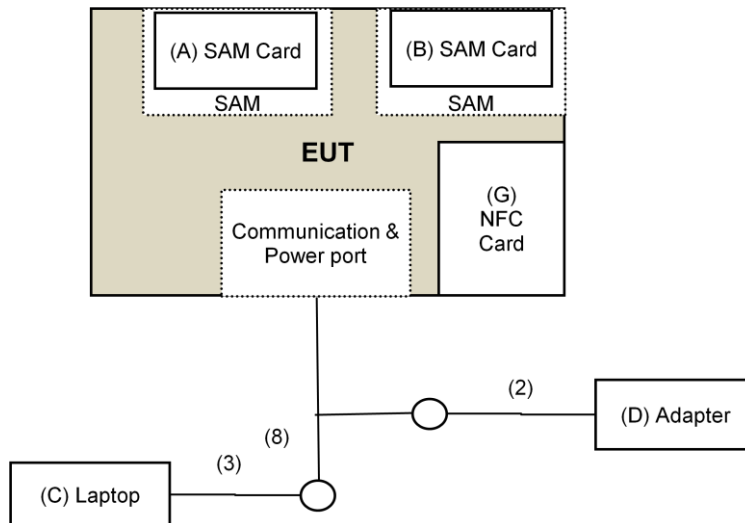

For Mode 4:

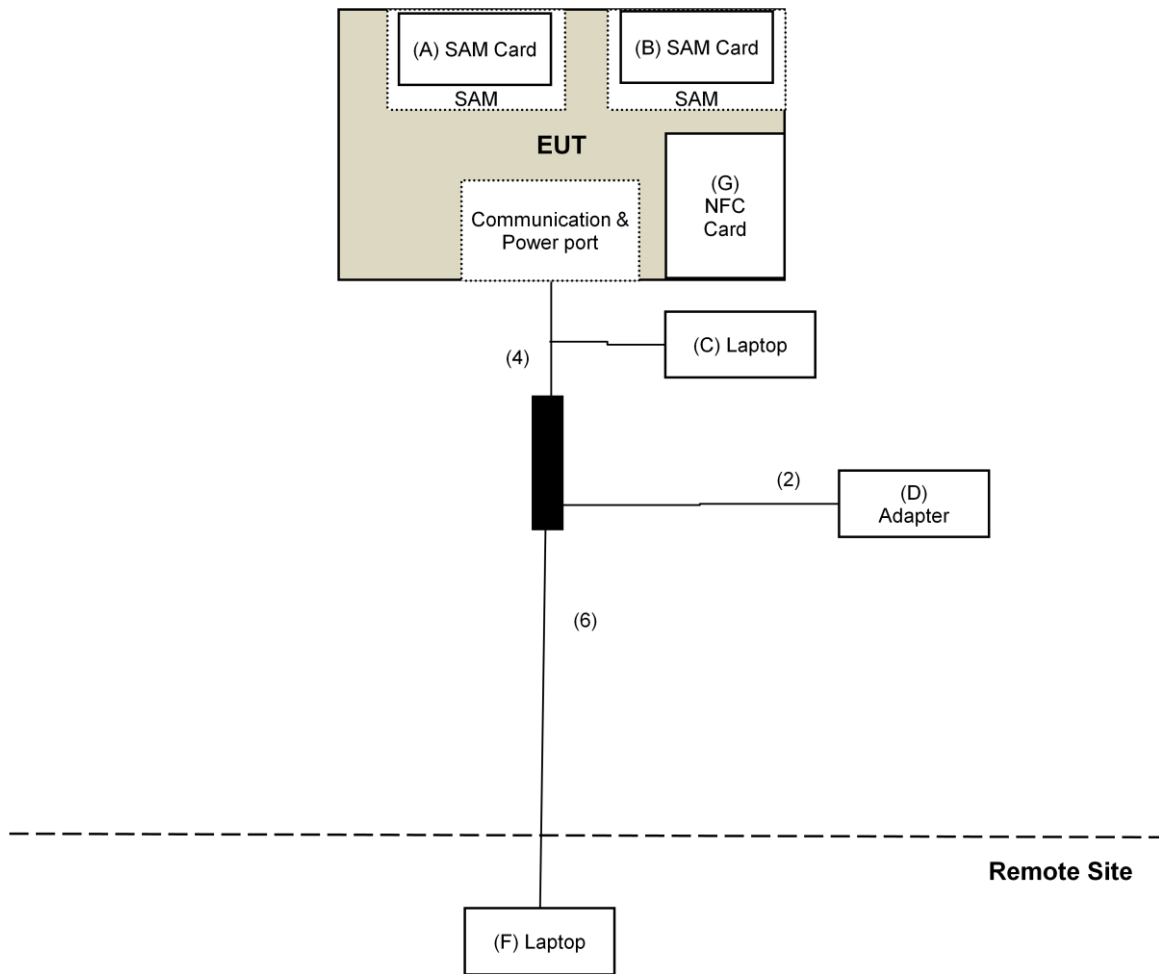

For Mode 5:

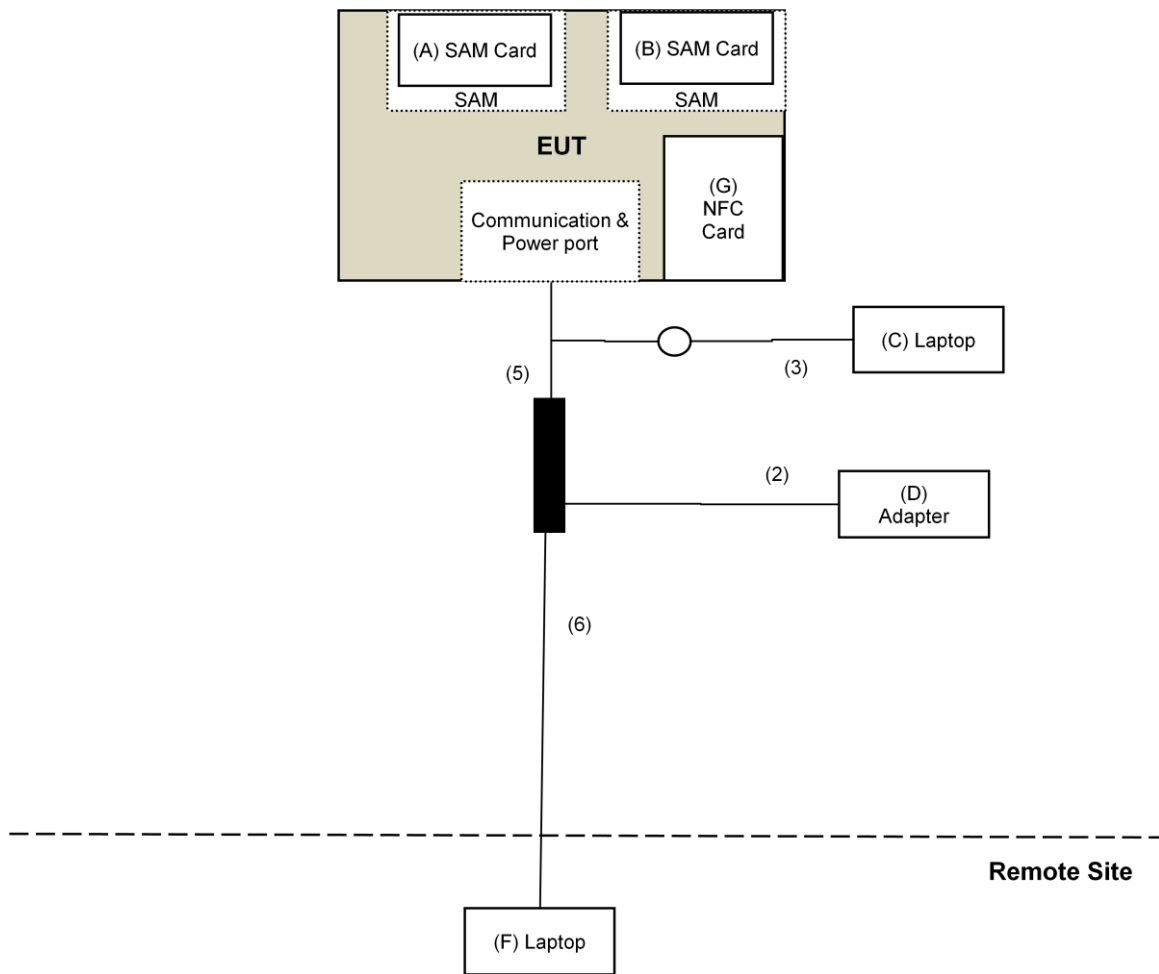

For Mode 6:

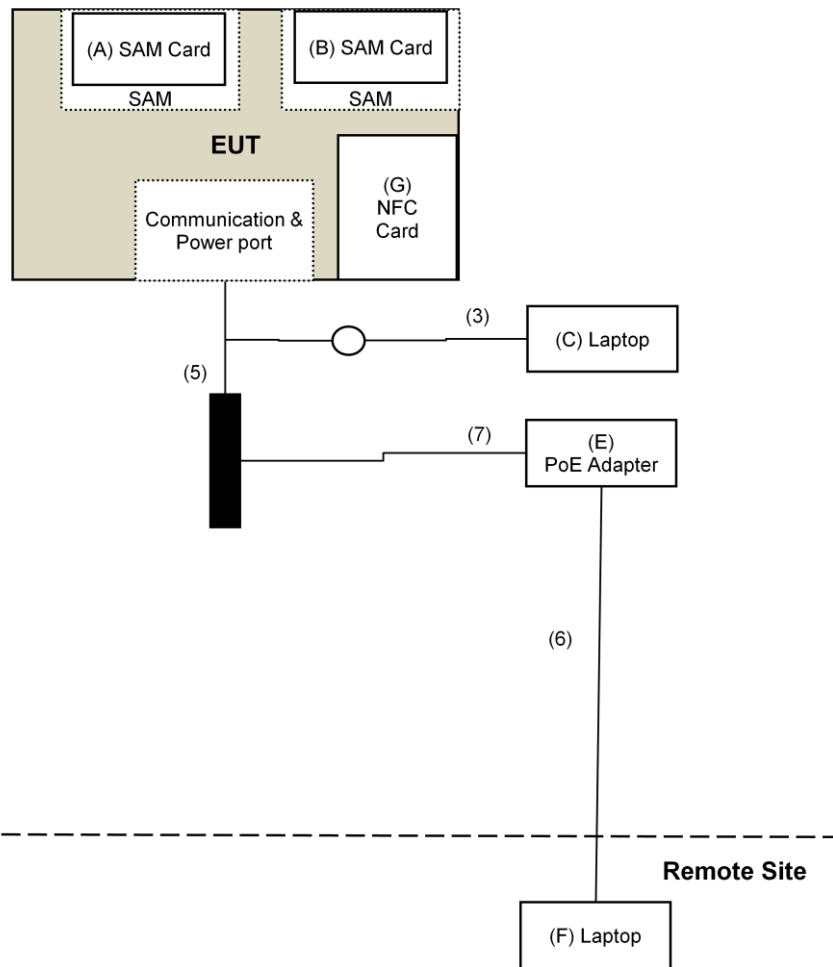

3.4 General Description of Applied Standards

The EUT is a RF Product. According to the specifications of the manufacturer, it must comply with the requirements of the following standards:

FCC Part 15, Subpart C (15.225)

FCC Part 15, Subpart C (15.215)

ANSI C63.10-2013

All test items have been performed and recorded as per the above standards.

4 Test Types and Results

4.1 Radiated Emission Measurement

4.1.1 Limits of Radiated Emission Measurement

(a) The field strength of any emissions within the band 13.553-13.567 MHz shall not exceed 15,848 microvolts/meter at 30 meters.

(b) Within the bands 13.410-13.553 MHz and 13.567-13.710 MHz, the field strength of any emissions shall not exceed 334 microvolts/meter at 30 meters.

(c) Within the bands 13.110-13.410 MHz and 13.710-14.010 MHz the field strength of any emissions shall not exceed 106 microvolts/meter at 30 meters.

(d) The field strength of any emissions appearing outside of the 13.110-14.010 MHz band shall not exceed the general radiated emission limits in §15.209 as below table:

Frequencies (MHz)	Field Strength (microvolts/meter)	Measurement Distance (meters)
0.009 ~ 0.490	2400/F(kHz)	300
0.490 ~ 1.705	24000/F(kHz)	30
1.705 ~ 30.0	30	30
30 ~ 88	100	3
88 ~ 216	150	3
216 ~ 960	200	3
Above 960	500	3

NOTE:

1. The lower limit shall apply at the transition frequencies.
2. Emission level (dBuV/m) = 20 log Emission level (uV/m).
3. For frequencies above 1000MHz, the field strength limits are based on average detector, however, the peak field strength of any emission shall not exceed the maximum permitted average limits, specified above by more than 20dB under any condition of modulation.
4. Follow FCC part 15.33, the spectrum shall be investigated from the lowest radio frequency signal generated in the device, without going below 9 kHz, up to the tenth harmonic of the highest fundamental frequency or to 40GHz, whichever is lower.

4.1.2 Test Instruments

DESCRIPTION & MANUFACTURER	MODEL NO.	SERIAL NO.	CALIBRATED DATE	CALIBRATED UNTIL
Test Receiver Agilent	N9038A	MY50010156	July 12, 2017	July 11, 2018
Pre-Amplifier ^(*) EMCI	EMC001340	980142	Jan. 20, 2016	Jan. 19, 2018
Loop Antenna ^(*) Electro-Metrics	EM-6879	264	Dec. 16, 2016	Dec. 15, 2018
RF Cable	NA	LOOPCAB-001 LOOPCAB-002	Jan. 17, 2017	Jan. 16, 2018
Pre-Amplifier Mini-Circuits	ZFL-1000VH2B	AMP-ZFL-05	May 06, 2017	May 05, 2018
Trilog Broadband Antenna SCHWARZBECK	VULB 9168	9168-361	Dec. 29, 2016	Dec. 28, 2017
RF Cable	8D	966-3-1 966-3-2 966-3-3	Apr. 01, 2017	Mar. 31, 2018
Fixed attenuator Mini-Circuits	UNAT-5+	PAD-3m-3-01	Oct. 03, 2017	Oct. 02, 2018
Software	ADT_Radiated_V8.7.08	NA	NA	NA
Antenna Tower & Turn Table Max-Full	MF-7802	MF780208406	NA	NA
Spectrum Analyzer Agilent	E4446A	MY48250253	Dec. 21, 2016	Dec. 20, 2017
AC Power Source Extech Electronics	6205	1440452	NA	NA
Temperature & Humidity Chamber Giant Force	GTH-150-40-SP-AR	MAA0812-008	Jan. 11, 2017	Jan. 10, 2018
True RMS Clamp Meter FLUKE	325	31130711WS	May 29, 2017	May 28, 2018

Note:

1. The calibration interval of the above test instruments is 12 months and the calibrations are traceable to NML/ROC and NIST/USA.
2. *The calibration interval of the above test instruments is 24 months and the calibrations are traceable to NML/ROC and NIST/USA.
3. The test was performed in 966 Chamber No. 3.
4. The CANADA Site Registration No. is 20331-1
5. Loop antenna was used for all emissions below 30 MHz.
6. Tested Date: Dec. 06, 2017

4.1.3 Test Procedures

For Radiated emission below 30MHz

- a. The EUT was placed on the top of a rotating table 0.8 meters above the ground at a 3 meter chamber room. The table was rotated 360 degrees to determine the position of the highest radiation.
- b. The EUT was set 3 meters away from the interference-receiving antenna, which was mounted on the top of a variable-height antenna tower.
- c. Both X and Y axes of the antenna are set to make the measurement.
- d. For each suspected emission, the EUT was arranged to its worst case and the rotatable table was turned from 0 degrees to 360 degrees to find the maximum reading.
- e. The test-receiver system was set to Quasi-Peak Detect Function and Specified Bandwidth with Maximum Hold Mode.

NOTE:

1. The resolution bandwidth and video bandwidth of test receiver/spectrum analyzer is 9kHz at frequency below 30MHz.

For Radiated emission above 30MHz

- a. The EUT was placed on the top of a rotating table 0.8 meters (for 30MHz ~ 1GHz) above the ground at 3 meter chamber room for test. The table was rotated 360 degrees to determine the position of the highest radiation.
- b. The EUT was set 3 meters away from the interference-receiving antenna, which was mounted on the top of a variable-height antenna tower.
- c. The height of antenna is varied from one meter to four meters above the ground to determine the maximum value of the field strength. Both horizontal and vertical polarizations of the antenna are set to make the measurement.
- d. For each suspected emission, the EUT was arranged to its worst case and then the antenna was tuned to heights from 1 meter to 4 meters and the rotatable table was turned from 0 degrees to 360 degrees to find the maximum reading.
- e. The test-receiver system was set to quasi-peak detect function and specified bandwidth with maximum hold mode when the test frequency is below 1 GHz.

Note:

1. The resolution bandwidth and video bandwidth of test receiver/spectrum analyzer is 120kHz for Quasi-peak detection (QP) at frequency above 30MHz.
2. All modes of operation were investigated and the worst-case emissions are reported.

4.1.4 Deviation from Test Standard

No deviation.

4.1.5 Test Setup

For Radiated emission below 30MHz

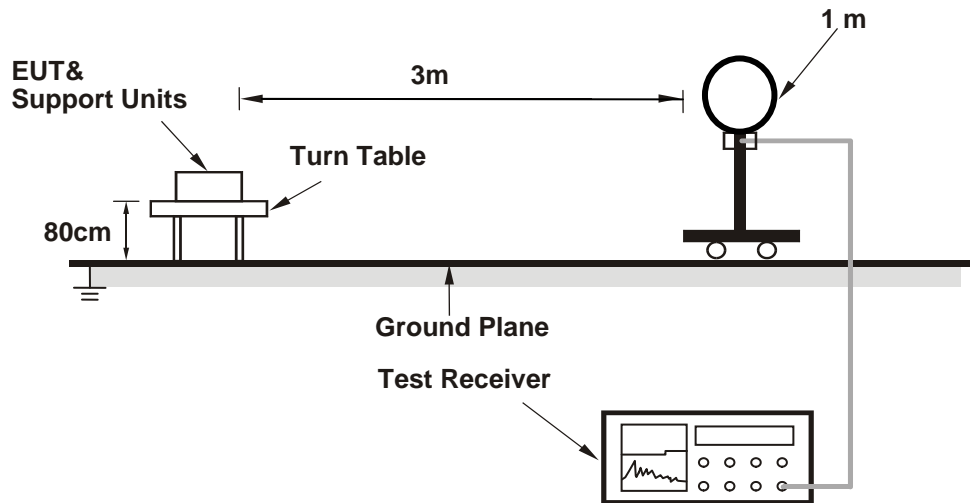

For Radiated emission 30MHz to 1GHz

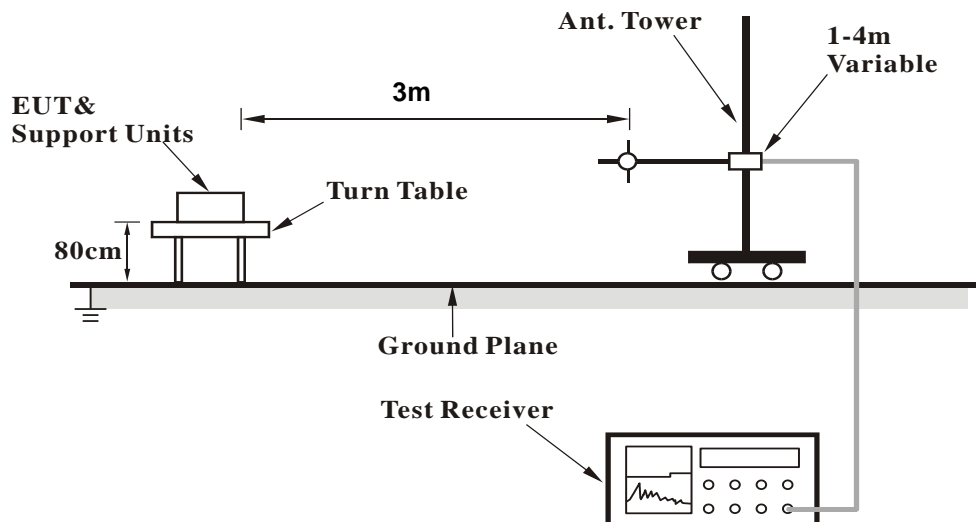

For the actual test configuration, please refer to the attached file (Test Setup Photo).

4.1.6 EUT Operating Conditions

- a. Placed the EUT on the testing table.
- b. Set the EUT under transmission condition continuously at specific channel frequency.

4.1.7 Test Results

Frequency Range	13.110 ~ 14.010MHz	Detector Function	Quasi-Peak
-----------------	--------------------	-------------------	------------

Antenna Polarity & Test Distance: Loop Antenna Open At 3m								
No.	Freq. (MHz)	Emission Level (dBuV/m)	Limit (dBuV/m)	Margin (dB)	Antenna Height (m)	Table Angle (Degree)	Raw Value (dBuV)	Correction Factor (dB/m)
1	13.35	45.21 QP	80.50	-35.29	1.00	30	48.50	-3.29
2	13.46	47.99 QP	90.47	-42.48	1.00	42	51.30	-3.31
3	*13.56	64.95 QP	124.00	-59.05	1.00	60	68.27	-3.32
4	13.66	49.28 QP	90.47	-41.19	1.00	29	52.62	-3.34
5	13.77	47.53 QP	80.50	-32.97	1.00	45	50.88	-3.35

- REMARKS:**
1. Emission level(dBuV/m)=Raw Value(dBuV) + Correction Factor(dB/m)
 2. Correction Factor(dB/m) = Antenna Factor (dB/m) + Cable Factor (dB) – Pre-Amplifier Factor(dB)
 3. The other emission levels were very low against the limit.
 4. Margin value = Emission level – Limit value.
 5. Above limits have been translated by the formula
 6. " * " : Fundamental frequency.

The measured field strength was extrapolated to distance 30 meters, using the formula that the limit of field strength varies as the inverse distance square (40dB per decade of distance)

Example:

$$\begin{aligned}
 13.56\text{MHz} &= 15848\text{uV/m} && 30\text{m} \\
 &= 84\text{dBuV/m} && 30\text{m} \\
 &= 84+20\log(30/3)^2 && 3\text{m} \\
 &= 124\text{dBuV/m}
 \end{aligned}$$

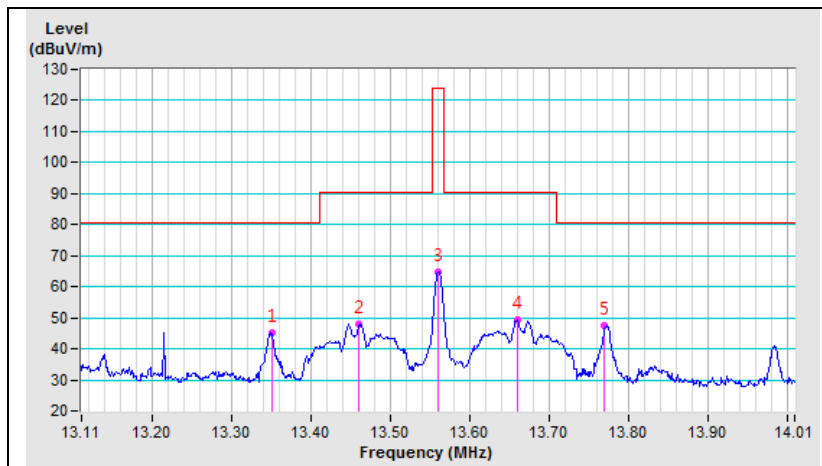

Frequency Range	13.110 ~ 14.010MHz	Detector Function	Quasi-Peak
-----------------	--------------------	-------------------	------------

Antenna Polarity & Test Distance: Loop Antenna Close At 3m								
No.	Freq. (MHz)	Emission Level (dBuV/m)	Limit (dBuV/m)	Margin (dB)	Antenna Height (m)	Table Angle (Degree)	Raw Value (dBuV)	Correction Factor (dB/m)
1	13.35	30.36 QP	80.50	-50.14	1.00	125	33.65	-3.29
2	13.46	33.44 QP	90.47	-57.03	1.00	130	36.75	-3.31
3	*13.56	50.49 QP	124.00	-73.51	1.00	160	53.81	-3.32
4	13.66	35.72 QP	90.47	-54.75	1.00	123	39.06	-3.34
5	13.77	32.34 QP	80.50	-48.16	1.00	131	35.69	-3.35

- REMARKS:**
1. Emission level(dBuV/m)=Raw Value(dBuV) + Correction Factor(dB/m)
 2. Correction Factor(dB/m) = Antenna Factor (dB/m) + Cable Factor (dB) – Pre-Amplifier Factor(dB)
 3. The other emission levels were very low against the limit.
 4. Margin value = Emission level – Limit value.
 5. Above limits have been translated by the formula
 6. " * ": Fundamental frequency.

The measured field strength was extrapolated to distance 30 meters, using the formula that the limit of field strength varies as the inverse distance square (40dB per decade of distance)

Example:

$$\begin{aligned}
 13.56\text{MHz} &= 15848\mu\text{V/m} && 30\text{m} \\
 &= 84\text{dBuV/m} && 30\text{m} \\
 &= 84+20\log(30/3)^2 && 3\text{m} \\
 &= 124\text{dBuV/m}
 \end{aligned}$$

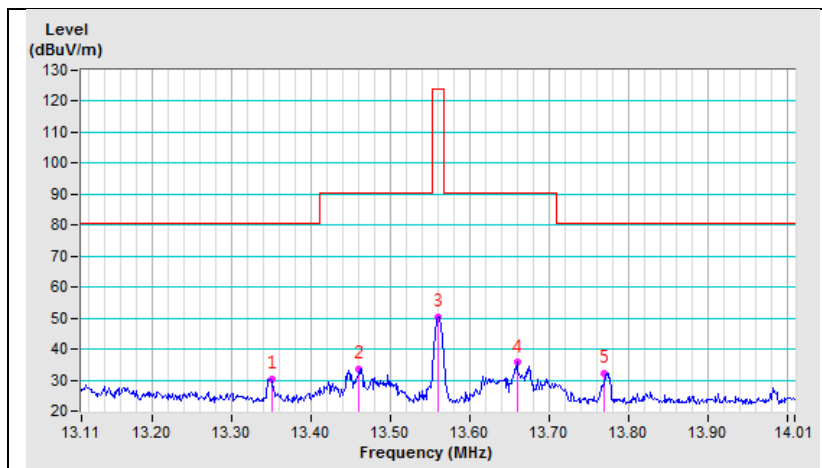

Frequency Range	Below 30MHz	Detector Function	Quasi-Peak
-----------------	-------------	-------------------	------------

Antenna Polarity & Test Distance: Loop Antenna Open At 3m								
NO.	FREQ. (MHz)	EMISSION LEVEL (dBuV/m)	LIMIT (dBuV/m)	MARGIN (dB)	ANTENNA HEIGHT (m)	TABLE ANGLE (Degree)	RAW VALUE (dBuV)	CORRECTION FACTOR (dB/m)
1	10.03	39.72 QP	69.50	-29.78	1.00	60	42.55	-2.83
2	11.77	42.36 QP	69.50	-27.14	1.00	75	45.44	-3.08
3	23.37	40.79 QP	69.50	-28.71	1.00	90	44.38	-3.59
4	24.15	47.77 QP	69.50	-21.73	1.00	80	51.18	-3.41
5	24.60	50.91 QP	69.50	-18.59	1.00	75	54.20	-3.29
6	29.70	42.44 QP	69.50	-27.06	1.00	90	44.68	-2.24
Antenna Polarity & Test Distance: Loop Antenna Close At 3m								
NO.	FREQ. (MHz)	EMISSION LEVEL (dBuV/m)	LIMIT (dBuV/m)	MARGIN (dB)	ANTENNA HEIGHT (m)	TABLE ANGLE (Degree)	RAW VALUE (dBuV)	CORRECTION FACTOR (dB/m)
1	10.09	31.93 QP	69.50	-37.57	1.00	35	34.77	-2.84
2	11.77	35.22 QP	69.50	-34.28	1.00	60	38.30	-3.08
3	23.67	36.50 QP	69.50	-33.00	1.00	99	40.02	-3.52
4	24.24	39.78 QP	69.50	-29.72	1.00	80	43.17	-3.39
5	25.38	42.46 QP	69.50	-27.04	1.00	90	45.59	-3.13
6	29.91	37.95 QP	69.50	-31.55	1.00	80	40.16	-2.21

REMARKS:

1. Emission Level(dBuV/m) = Raw Value(dBuV) + Correction Factor(dB/m)
2. Correction Factor(dB/m) = Antenna Factor(dB/m) + Cable Factor(dB)
– Pre-Amplifier Factor (dB)
3. The other emission levels were very low against the limit.
4. Margin value = Emission Level – Limit value

Frequency Range	30MHz ~ 1000MHz	Detector Function	Quasi-Peak
-----------------	-----------------	-------------------	------------

Antenna Polarity & Test Distance: Horizontal At 3 M								
NO.	FREQ. (MHz)	EMISSION LEVEL (dBuV/m)	LIMIT (dBuV/m)	MARGIN (dB)	ANTENNA HEIGHT (m)	TABLE ANGLE (Degree)	RAW VALUE (dBuV)	CORRECTION FACTOR (dB/m)
1	36.33	34.80 QP	40.00	-5.20	3.00 H	0	43.90	-9.10
2	316.05	28.40 QP	46.00	-17.60	1.00 H	289	35.30	-6.90
3	352.60	28.70 QP	46.00	-17.30	1.00 H	0	35.20	-6.50
4	481.03	31.40 QP	46.00	-14.60	1.00 H	0	34.80	-3.40
5	612.58	29.90 QP	46.00	-16.10	3.00 H	277	30.70	-0.80
6	945.49	32.90 QP	46.00	-13.10	3.00 H	4	29.10	3.80
Antenna Polarity & Test Distance: Vertical At 3 M								
NO.	FREQ. (MHz)	EMISSION LEVEL (dBuV/m)	LIMIT (dBuV/m)	MARGIN (dB)	ANTENNA HEIGHT (m)	TABLE ANGLE (Degree)	RAW VALUE (dBuV)	CORRECTION FACTOR (dB/m)
1	35.58	39.60 QP	40.00	-0.40	2.00 V	0	48.70	-9.10
2	50.39	39.10 QP	40.00	-0.90	1.00 V	129	47.40	-8.30
3	224.99	23.90 QP	46.00	-22.10	1.00 V	144	34.90	-11.00
4	310.35	27.00 QP	46.00	-19.00	2.00 V	0	34.10	-7.10
5	479.91	30.90 QP	46.00	-15.10	1.00 V	191	34.40	-3.50
6	913.91	32.20 QP	46.00	-13.80	1.00 V	313	28.80	3.40

REMARKS:

1. Emission Level(dBuV/m) = Raw Value(dBuV) + Correction Factor(dB/m)
2. Correction Factor(dB/m) = Antenna Factor(dB/m) + Cable Factor(dB) – Pre-Amplifier Factor(dB)
3. The other emission levels were very low against the limit.
4. Margin value = Emission Level – Limit value

4.2 Conducted Emission Measurement

4.2.1 Limits of Conducted Emission Measurement

Frequency (MHz)	Conducted Limit (dBuV)	
	Quasi-peak	Average
0.15 - 0.5	66 - 56	56 - 46
0.50 - 5.0	56	46
5.0 - 30.0	60	50

Note: 1. The lower limit shall apply at the transition frequencies.

2. The limit decreases in line with the logarithm of the frequency in the range of 0.15 to 0.50MHz.

3. All emanations from a class A/B digital device or system, including any network of conductors and apparatus connected thereto, shall not exceed the level of field strengths specified above.

4.2.2 Test Instruments

DESCRIPTION & MANUFACTURER	MODEL NO.	SERIAL NO.	CALIBRATED DATE	CALIBRATED UNTIL
Test Receiver R&S	ESCS 30	847124/029	Nov. 01, 2017	Oct. 31, 2018
Line-Impedance Stabilization Network (for EUT) R&S	ESH3-Z5	848773/004	Nov. 15, 20167	Nov. 14, 2018
Line-Impedance Stabilization Network (for Peripheral) R&S	ENV216	100072	June 03, 2017	June 02, 2018
50 ohms Terminator	N/A	EMC-02	Sep. 22, 2017	Sep. 21, 2018
RF Cable	5D-FB	COCCAB-001	Sep. 29, 2017	Sep. 28, 2018
10 dB PAD Mini-Circuits	HAT-10+	CONATT-004	June 18, 2017	June 17, 2018
Software BVADT	BVADT_Cond_ V7.3.7.4	NA	NA	NA

Note:

1. The calibration interval of the above test instruments are 12 months and the calibrations are traceable to NML/ROC and NIST/USA.
2. The test was performed in Shielded Room No. 1.
3. Tested Date: Dec. 13, 2017

4.2.3 Test Procedures

- The EUT was placed 0.4 meters from the conducting wall of the shielded room with EUT being connected to the power mains through a line impedance stabilization network (LISN). Other support units were connected to the power mains through another LISN. The two LISNs provide 50 ohm/ 50uH of coupling impedance for the measuring instrument.
- Both lines of the power mains connected to the EUT were checked for maximum conducted interference.
- The frequency range from 150kHz to 30MHz was searched. Emission levels under (Limit - 20dB) was not recorded.

NOTE: The resolution bandwidth and video bandwidth of test receiver is 9kHz for quasi-peak detection (QP) and average detection (AV) at frequency 0.15MHz-30MHz.

4.2.4 Deviation from Test Standard

No deviation.

4.2.5 TEST SETUP

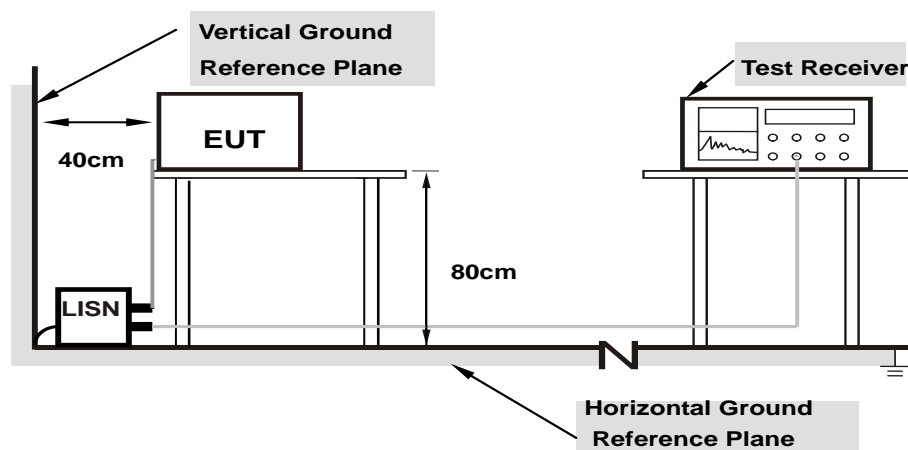

Note: 1.Support units were connected to second LISN.

For the actual test configuration, please refer to the attached file (Test Setup Photo).

4.2.6 EUT Operating Conditions

Same as 4.1.6.

4.2.7 Test Results (Mode 1)

Phase	Line (L)	Detector Function	Quasi-Peak (QP) / Average (AV)
-------	----------	-------------------	--------------------------------

No	Freq. [MHz]	Corr.	Reading Value		Emission Level		Limit		Margin	
		Factor (dB)	[dB (uV)]		[dB (uV)]		[dB (uV)]		(dB)	
		Q.P.	AV.	Q.P.	AV.	Q.P.	AV.	Q.P.	AV.	
1	0.15000	10.09	41.16	27.07	51.25	37.16	66.00	56.00	-14.75	-18.84
2	0.17344	10.08	36.24	22.78	46.32	32.86	64.79	54.79	-18.47	-21.93
3	0.33359	10.10	37.95	30.07	48.05	40.17	59.36	49.36	-11.31	-9.19
4	14.15234	11.13	28.19	24.47	39.32	35.60	60.00	50.00	-20.68	-14.40
5	18.30469	11.46	32.57	28.26	44.03	39.72	60.00	50.00	-15.97	-10.28
6	23.12891	11.63	32.22	30.67	43.85	42.30	60.00	50.00	-16.15	-7.70

REMARKS:

1. Q.P. and AV. are abbreviations of quasi-peak and average individually.
2. The emission levels of other frequencies were very low against the limit.
3. Margin value = Emission level - Limit value
4. Correction factor = Insertion loss + Cable loss
5. Emission Level = Correction Factor + Reading Value.

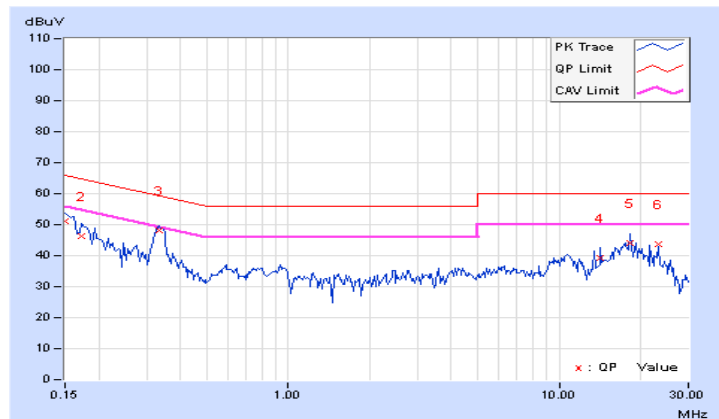

Phase	Neutral (N)	Detector Function	Quasi-Peak (QP) / Average (AV)
-------	-------------	-------------------	--------------------------------

No	Freq. [MHz]	Corr.	Reading Value		Emission Level		Limit		Margin	
		Factor	[dB (uV)]		[dB (uV)]		[dB (uV)]		(dB)	
		(dB)	Q.P.	AV.	Q.P.	AV.	Q.P.	AV.	Q.P.	AV.
1	0.15000	10.08	41.99	27.39	52.07	37.47	66.00	56.00	-13.93	-18.53
2	0.18516	10.05	35.15	21.77	45.20	31.82	64.25	54.25	-19.05	-22.43
3	0.33750	10.10	37.39	30.01	47.49	40.11	59.26	49.26	-11.77	-9.15
4	0.94688	10.13	25.61	18.37	35.74	28.50	56.00	46.00	-20.26	-17.50
5	10.79297	10.76	31.25	25.99	42.01	36.75	60.00	50.00	-17.99	-13.25
6	18.30859	11.20	31.93	27.28	43.13	38.48	60.00	50.00	-16.87	-11.52

REMARKS:

1. Q.P. and AV. are abbreviations of quasi-peak and average individually.
2. The emission levels of other frequencies were very low against the limit.
3. Margin value = Emission level - Limit value
4. Correction factor = Insertion loss + Cable loss
5. Emission Level = Correction Factor + Reading Value.

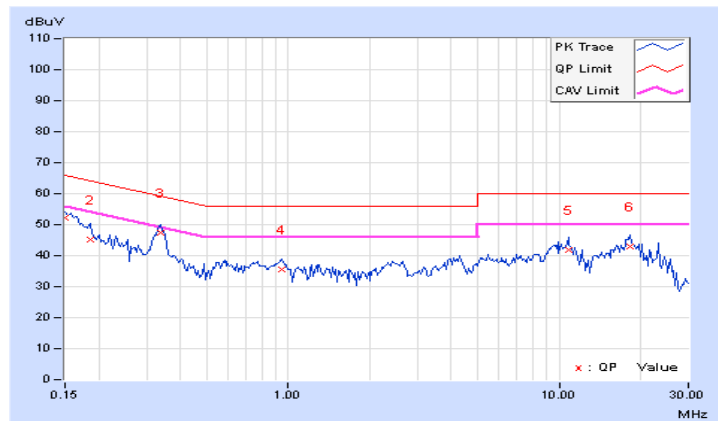

4.2.8 Test Results (Mode 2)

Phase	Line (L)	Detector Function	Quasi-Peak (QP) / Average (AV)
-------	----------	-------------------	--------------------------------

No	Freq. [MHz]	Corr. Factor	Reading Value [dB (uV)]		Emission Level [dB (uV)]		Limit [dB (uV)]		Margin (dB)	
		(dB)	Q.P.	AV.	Q.P.	AV.	Q.P.	AV.	Q.P.	AV.
	1	0.15000	10.09	44.77	33.65	54.86	43.74	66.00	56.00	-11.14
2	0.18906	10.07	40.53	26.70	50.60	36.77	64.08	54.08	-13.48	-17.31
3	0.45469	10.12	32.19	24.21	42.31	34.33	56.79	46.79	-14.48	-12.46
4	0.86484	10.16	19.82	12.73	29.98	22.89	56.00	46.00	-26.02	-23.11
5	2.59375	10.23	15.62	5.52	25.85	15.75	56.00	46.00	-30.15	-30.25
6	25.87500	11.67	29.22	25.36	40.89	37.03	60.00	50.00	-19.11	-12.97

REMARKS:

1. Q.P. and AV. are abbreviations of quasi-peak and average individually.
2. The emission levels of other frequencies were very low against the limit.
3. Margin value = Emission level - Limit value
4. Correction factor = Insertion loss + Cable loss
5. Emission Level = Correction Factor + Reading Value.

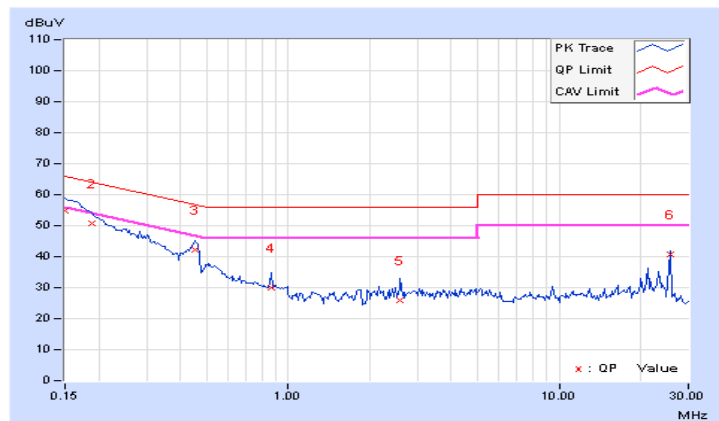

Phase	Neutral (N)	Detector Function	Quasi-Peak (QP) / Average (AV)
-------	-------------	-------------------	--------------------------------

No	Freq. [MHz]	Corr.	Reading Value		Emission Level		Limit		Margin	
		Factor	[dB (uV)]		[dB (uV)]		[dB (uV)]		(dB)	
		(dB)	Q.P.	AV.	Q.P.	AV.	Q.P.	AV.	Q.P.	AV.
1	0.15000	10.08	43.78	30.43	53.86	40.51	66.00	56.00	-12.14	-15.49
2	0.18516	10.05	40.04	27.61	50.09	37.66	64.25	54.25	-14.16	-16.59
3	0.27109	10.07	32.21	18.85	42.28	28.92	61.08	51.08	-18.80	-22.16
4	0.44688	10.12	29.58	19.32	39.70	29.44	56.93	46.93	-17.23	-17.49
5	0.87266	10.13	19.45	10.57	29.58	20.70	56.00	46.00	-26.42	-25.30
6	25.87109	11.28	24.81	22.40	36.09	33.68	60.00	50.00	-23.91	-16.32

REMARKS:

1. Q.P. and AV. are abbreviations of quasi-peak and average individually.
2. The emission levels of other frequencies were very low against the limit.
3. Margin value = Emission level - Limit value
4. Correction factor = Insertion loss + Cable loss
5. Emission Level = Correction Factor + Reading Value.

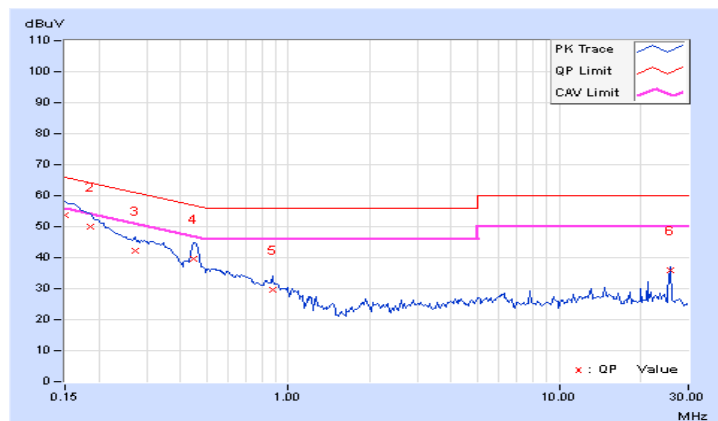

4.2.9 Test Results (Mode 3)

Phase	Line (L)	Detector Function	Quasi-Peak (QP) / Average (AV)
-------	----------	-------------------	--------------------------------

No	Freq. [MHz]	Corr.	Reading Value		Emission Level		Limit		Margin	
		Factor (dB)	[dB (uV)]		[dB (uV)]		[dB (uV)]		(dB)	
			Q.P.	AV.	Q.P.	AV.	Q.P.	AV.	Q.P.	AV.
1	0.15781	10.08	43.55	33.11	53.63	43.19	65.58	55.58	-11.95	-12.39
2	0.17734	10.08	50.51	32.00	60.59	42.08	64.61	54.61	-4.02	-12.53
3	0.20078	10.07	37.85	28.54	47.92	38.61	63.58	53.58	-15.66	-14.97
4	0.26719	10.09	47.09	25.37	57.18	35.46	61.20	51.20	-4.02	-15.74
5	0.35313	10.11	43.07	23.88	53.18	33.99	58.89	48.89	-5.71	-14.90
6	0.41563	10.12	34.81	23.20	44.93	33.32	57.54	47.54	-12.61	-14.22
7	0.44688	10.12	44.39	25.39	54.51	35.51	56.93	46.93	-2.42	-11.42
8	0.53281	10.13	37.55	18.47	47.68	28.60	56.00	46.00	-8.32	-17.40
9	0.62266	10.14	35.24	14.77	45.38	24.91	56.00	46.00	-10.62	-21.09
10	0.70859	10.15	32.45	16.34	42.60	26.49	56.00	46.00	-13.40	-19.51
11	0.91953	10.16	35.34	11.53	45.50	21.69	56.00	46.00	-10.50	-24.31
12	1.06641	10.17	26.85	12.59	37.02	22.76	56.00	46.00	-18.98	-23.24
13	1.19922	10.17	23.74	9.69	33.91	19.86	56.00	46.00	-22.09	-26.14
14	1.34375	10.17	32.60	9.78	42.77	19.95	56.00	46.00	-13.23	-26.05
15	1.51563	10.17	21.39	10.11	31.56	20.28	56.00	46.00	-24.44	-25.72
16	1.81641	10.17	20.10	11.63	30.27	21.80	56.00	46.00	-25.73	-24.20

REMARKS:

1. Q.P. and AV. are abbreviations of quasi-peak and average individually.
2. The emission levels of other frequencies were very low against the limit.
3. Margin value = Emission level - Limit value
4. Correction factor = Insertion loss + Cable loss
5. Emission Level = Correction Factor + Reading Value.

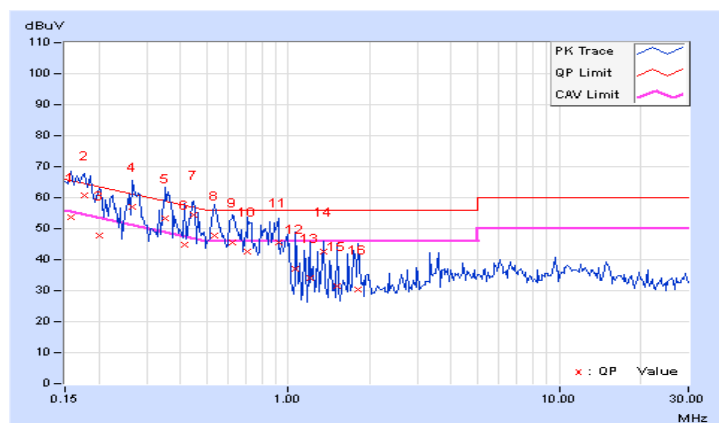

Phase	Neutral (N)	Detector Function	Quasi-Peak (QP) / Average (AV)
-------	-------------	-------------------	--------------------------------

No	Freq. [MHz]	Corr.	Reading Value		Emission Level		Limit		Margin	
		Factor	[dB (uV)]		[dB (uV)]		[dB (uV)]		(dB)	
		(dB)	Q.P.	AV.	Q.P.	AV.	Q.P.	AV.	Q.P.	AV.
1	0.16562	10.06	43.24	30.20	53.30	40.26	65.18	55.18	-11.88	-14.92
2	0.17734	10.06	52.07	32.52	62.13	42.58	64.61	54.61	-2.48	-12.03
3	0.19687	10.04	38.29	30.35	48.33	40.39	63.74	53.74	-15.41	-13.35
4	0.26719	10.07	50.36	27.57	60.43	37.64	61.20	51.20	-0.77	-13.56
5	0.32969	10.09	37.77	19.86	47.86	29.95	59.46	49.46	-11.60	-19.51
6	0.39219	10.12	42.30	22.17	52.42	32.29	58.02	48.02	-5.60	-15.73
7	0.44297	10.12	42.19	23.44	52.31	33.56	57.01	47.01	-4.70	-13.45
8	0.50547	10.12	36.49	15.75	46.61	25.87	56.00	46.00	-9.39	-20.13
9	0.56797	10.12	42.47	15.42	52.59	25.54	56.00	46.00	-3.41	-20.46
10	0.64219	10.12	31.70	14.26	41.82	24.38	56.00	46.00	-14.18	-21.62
11	0.71641	10.13	33.17	12.37	43.30	22.50	56.00	46.00	-12.70	-23.50
12	0.80625	10.13	31.10	10.91	41.23	21.04	56.00	46.00	-14.77	-24.96
13	0.97422	10.13	28.51	8.20	38.64	18.33	56.00	46.00	-17.36	-27.67
14	1.35156	10.16	22.99	6.99	33.15	17.15	56.00	46.00	-22.85	-28.85

REMARKS:

1. Q.P. and AV. are abbreviations of quasi-peak and average individually.
2. The emission levels of other frequencies were very low against the limit.
3. Margin value = Emission level - Limit value
4. Correction factor = Insertion loss + Cable loss
5. Emission Level = Correction Factor + Reading Value.

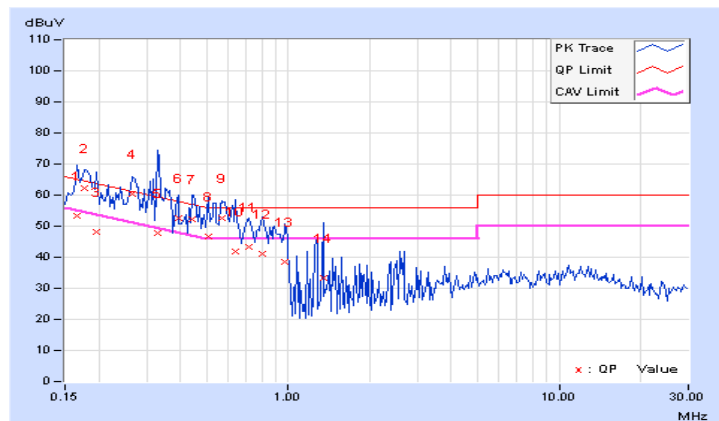

4.2.10 Test Results (Mode 4)

Phase	Line (L)	Detector Function	Quasi-Peak (QP) / Average (AV)
-------	----------	-------------------	--------------------------------

No	Freq. [MHz]	Corr. Factor	Reading Value [dB (uV)]		Emission Level [dB (uV)]		Limit [dB (uV)]		Margin (dB)	
		(dB)	Q.P.	AV.	Q.P.	AV.	Q.P.	AV.	Q.P.	AV.
	1	0.15000	10.09	44.81	33.91	54.90	44.00	66.00	56.00	-11.10
2	0.20078	10.07	46.40	27.97	56.47	38.04	63.58	53.58	-7.11	-15.54
3	0.22812	10.08	46.08	26.61	56.16	36.69	62.52	52.52	-6.36	-15.83
4	0.27109	10.09	40.33	23.89	50.42	33.98	61.08	51.08	-10.66	-17.10
5	0.32188	10.10	37.38	22.28	47.48	32.38	59.66	49.66	-12.18	-17.28
6	0.37266	10.11	42.69	19.57	52.80	29.68	58.44	48.44	-5.64	-18.76
7	0.51328	10.13	35.69	21.57	45.82	31.70	56.00	46.00	-10.18	-14.30
8	0.61094	10.14	33.07	14.79	43.21	24.93	56.00	46.00	-12.79	-21.07
9	0.77109	10.15	29.58	11.62	39.73	21.77	56.00	46.00	-16.27	-24.23
10	0.99766	10.17	24.86	10.83	35.03	21.00	56.00	46.00	-20.97	-25.00
11	1.06250	10.17	31.29	10.64	41.46	20.81	56.00	46.00	-14.54	-25.19
12	1.25781	10.17	22.60	10.21	32.77	20.38	56.00	46.00	-23.23	-25.62
13	1.62109	10.17	21.65	7.69	31.82	17.86	56.00	46.00	-24.18	-28.14
14	1.77734	10.17	19.67	10.04	29.84	20.21	56.00	46.00	-26.16	-25.79
15	1.93359	10.17	19.00	9.19	29.17	19.36	56.00	46.00	-26.83	-26.64
16	2.32813	10.20	18.41	8.35	28.61	18.55	56.00	46.00	-27.39	-27.45

REMARKS:

1. Q.P. and AV. are abbreviations of quasi-peak and average individually.
2. The emission levels of other frequencies were very low against the limit.
3. Margin value = Emission level - Limit value
4. Correction factor = Insertion loss + Cable loss
5. Emission Level = Correction Factor + Reading Value.

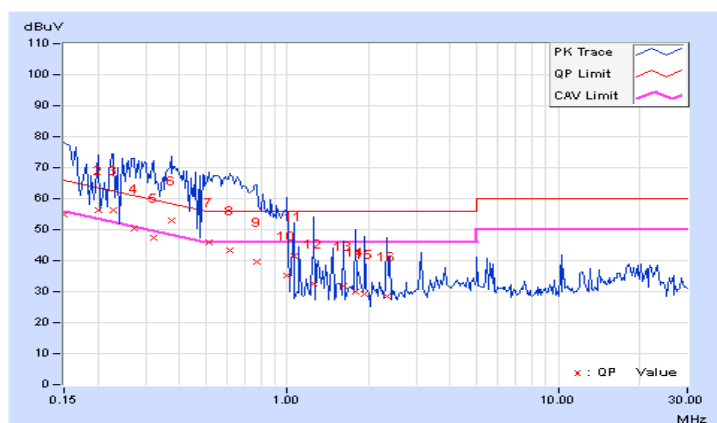

Phase	Neutral (N)	Detector Function	Quasi-Peak (QP) / Average (AV)
-------	-------------	-------------------	--------------------------------

No	Freq. [MHz]	Corr.	Reading Value		Emission Level		Limit		Margin	
		Factor	[dB (uV)]		[dB (uV)]		[dB (uV)]		(dB)	
		(dB)	Q.P.	AV.	Q.P.	AV.	Q.P.	AV.	Q.P.	AV.
1	0.15391	10.07	46.32	31.15	56.39	41.22	65.79	55.79	-9.40	-14.57
2	0.17734	10.06	38.72	26.41	48.78	36.47	64.61	54.61	-15.83	-18.14
3	0.22031	10.05	34.60	23.45	44.65	33.50	62.81	52.81	-18.16	-19.31
4	0.31406	10.09	41.15	21.82	51.24	31.91	59.86	49.86	-8.62	-17.95
5	0.42344	10.12	33.22	17.08	43.34	27.20	57.38	47.38	-14.04	-20.18
6	0.58359	10.12	31.61	13.53	41.73	23.65	56.00	46.00	-14.27	-22.35
7	0.78672	10.13	26.27	9.53	36.40	19.66	56.00	46.00	-19.60	-26.34
8	1.08984	10.14	23.49	7.21	33.63	17.35	56.00	46.00	-22.37	-28.65
9	1.64063	10.18	22.19	6.33	32.37	16.51	56.00	46.00	-23.63	-29.49
10	1.78516	10.19	18.27	7.75	28.46	17.94	56.00	46.00	-27.54	-28.06
11	1.97656	10.21	18.74	6.00	28.95	16.21	56.00	46.00	-27.05	-29.79
12	3.23438	10.24	15.45	4.54	25.69	14.78	56.00	46.00	-30.31	-31.22
13	9.33984	10.66	13.12	6.96	23.78	17.62	60.00	50.00	-36.22	-32.38

REMARKS:

1. Q.P. and AV. are abbreviations of quasi-peak and average individually.
2. The emission levels of other frequencies were very low against the limit.
3. Margin value = Emission level - Limit value
4. Correction factor = Insertion loss + Cable loss
5. Emission Level = Correction Factor + Reading Value.

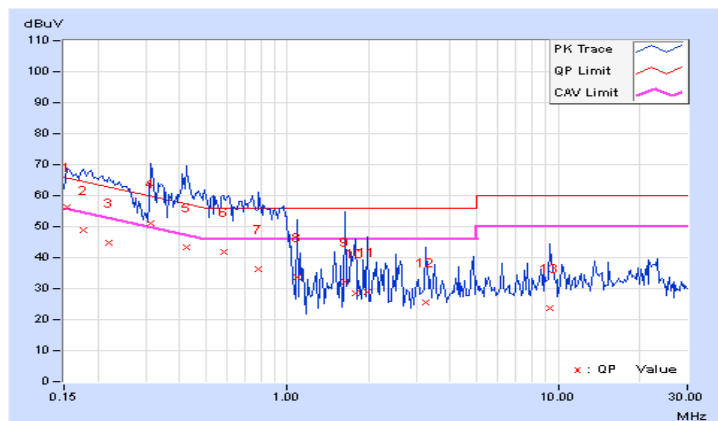

4.2.11 Test Results (Mode 5)

Phase	Line (L)	Detector Function	Quasi-Peak (QP) / Average (AV)
-------	----------	-------------------	--------------------------------

No	Freq. [MHz]	Corr.	Reading Value		Emission Level		Limit		Margin	
		Factor	[dB (uV)]		[dB (uV)]		[dB (uV)]		(dB)	
	(dB)	Q.P.	AV.	Q.P.	AV.	Q.P.	AV.	Q.P.	AV.	
1	0.15000	10.09	46.56	34.47	56.65	44.56	66.00	56.00	-9.35	-11.44
2	0.17344	10.08	41.90	31.60	51.98	41.68	64.79	54.79	-12.81	-13.11
3	0.29453	10.09	32.54	21.61	42.63	31.70	60.40	50.40	-17.77	-18.70
4	0.33750	10.10	30.04	19.52	40.14	29.62	59.26	49.26	-19.12	-19.64
5	0.48984	10.13	26.10	14.81	36.23	24.94	56.17	46.17	-19.94	-21.23
6	0.56406	10.13	20.90	13.10	31.03	23.23	56.00	46.00	-24.97	-22.77
7	0.65391	10.14	19.37	10.71	29.51	20.85	56.00	46.00	-26.49	-25.15
8	0.81797	10.15	17.68	8.82	27.83	18.97	56.00	46.00	-28.17	-27.03
9	0.95469	10.17	15.04	6.52	25.21	16.69	56.00	46.00	-30.79	-29.31

REMARKS:

1. Q.P. and AV. are abbreviations of quasi-peak and average individually.
2. The emission levels of other frequencies were very low against the limit.
3. Margin value = Emission level - Limit value
4. Correction factor = Insertion loss + Cable loss
5. Emission Level = Correction Factor + Reading Value.

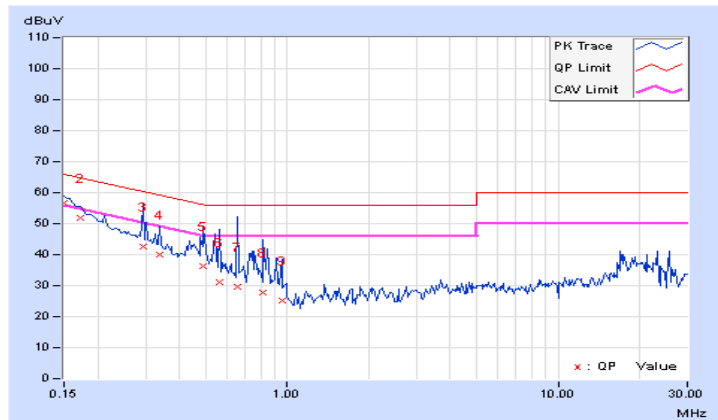

Phase	Neutral (N)	Detector Function	Quasi-Peak (QP) / Average (AV)
-------	-------------	-------------------	--------------------------------

No	Freq. [MHz]	Corr.	Reading Value		Emission Level		Limit		Margin	
		Factor	[dB (uV)]		[dB (uV)]		[dB (uV)]		(dB)	
		(dB)	Q.P.	AV.	Q.P.	AV.	Q.P.	AV.	Q.P.	AV.
1	0.15000	10.08	47.80	34.61	57.88	44.69	66.00	56.00	-8.12	-11.31
2	0.21250	10.05	37.97	26.10	48.02	36.15	63.11	53.11	-15.09	-16.96
3	0.25547	10.06	34.32	23.86	44.38	33.92	61.58	51.58	-17.20	-17.66
4	0.32188	10.09	32.55	19.93	42.64	30.02	59.66	49.66	-17.02	-19.64
5	0.38438	10.11	26.03	15.73	36.14	25.84	58.18	48.18	-22.04	-22.34
6	0.52500	10.12	30.26	12.48	40.38	22.60	56.00	46.00	-15.62	-23.40
7	0.61875	10.12	21.43	9.18	31.55	19.30	56.00	46.00	-24.45	-26.70
8	0.74766	10.13	17.65	4.83	27.78	14.96	56.00	46.00	-28.22	-31.04
9	0.81797	10.13	18.89	6.15	29.02	16.28	56.00	46.00	-26.98	-29.72
10	0.88047	10.13	15.60	3.32	25.73	13.45	56.00	46.00	-30.27	-32.55
11	0.94688	10.13	15.85	2.18	25.98	12.31	56.00	46.00	-30.02	-33.69

REMARKS:

1. Q.P. and AV. are abbreviations of quasi-peak and average individually.
2. The emission levels of other frequencies were very low against the limit.
3. Margin value = Emission level - Limit value
4. Correction factor = Insertion loss + Cable loss
5. Emission Level = Correction Factor + Reading Value.

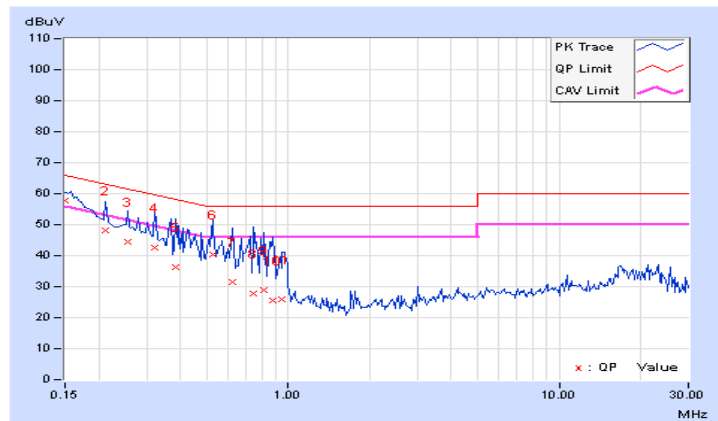

4.2.12 Test Results (Mode 6)

Phase	Line (L)	Detector Function	Quasi-Peak (QP) / Average (AV)
-------	----------	-------------------	--------------------------------

No	Freq. [MHz]	Corr. Factor	Reading Value [dB (uV)]		Emission Level [dB (uV)]		Limit [dB (uV)]		Margin (dB)	
		(dB)	Q.P.	AV.	Q.P.	AV.	Q.P.	AV.	Q.P.	AV.
	1	0.15000	10.09	38.99	24.81	49.08	34.90	66.00	56.00	-16.92
2	0.24375	10.08	26.86	13.52	36.94	23.60	61.97	51.97	-25.03	-28.37
3	0.32578	10.10	37.49	31.49	47.59	41.59	59.56	49.56	-11.97	-7.97
4	10.61328	10.84	28.65	22.75	39.49	33.59	60.00	50.00	-20.51	-16.41
5	17.93750	11.43	30.62	25.82	42.05	37.25	60.00	50.00	-17.95	-12.75
6	23.12891	11.63	31.52	30.41	43.15	42.04	60.00	50.00	-16.85	-7.96

REMARKS:

1. Q.P. and AV. are abbreviations of quasi-peak and average individually.
2. The emission levels of other frequencies were very low against the limit.
3. Margin value = Emission level - Limit value
4. Correction factor = Insertion loss + Cable loss
5. Emission Level = Correction Factor + Reading Value.

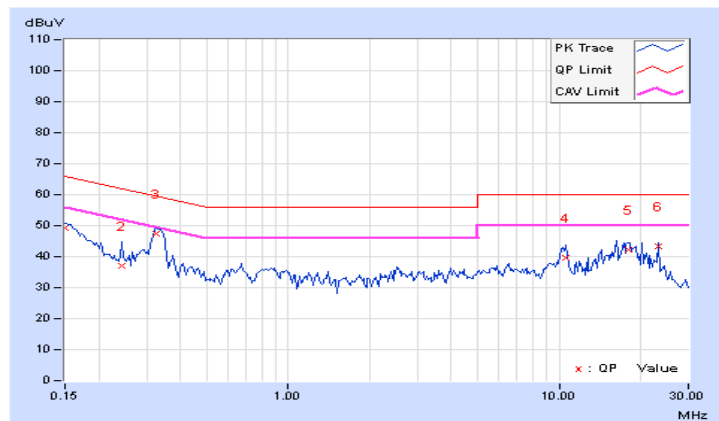

Phase	Neutral (N)	Detector Function	Quasi-Peak (QP) / Average (AV)
-------	-------------	-------------------	--------------------------------

No	Freq. [MHz]	Corr.	Reading Value		Emission Level		Limit		Margin	
		Factor	[dB (uV)]		[dB (uV)]		[dB (uV)]		(dB)	
		(dB)	Q.P.	AV.	Q.P.	AV.	Q.P.	AV.	Q.P.	AV.
1	0.15391	10.07	38.37	26.74	48.44	36.81	65.79	55.79	-17.35	-18.98
2	0.32188	10.09	36.86	32.00	46.95	42.09	59.66	49.66	-12.71	-7.57
3	0.66953	10.12	26.49	20.06	36.61	30.18	56.00	46.00	-19.39	-15.82
4	10.26563	10.73	32.54	25.90	43.27	36.63	60.00	50.00	-16.73	-13.37
5	17.69531	11.16	33.43	29.19	44.59	40.35	60.00	50.00	-15.41	-9.65
6	23.12891	11.28	31.38	30.21	42.66	41.49	60.00	50.00	-17.34	-8.51

REMARKS:

1. Q.P. and AV. are abbreviations of quasi-peak and average individually.
2. The emission levels of other frequencies were very low against the limit.
3. Margin value = Emission level - Limit value
4. Correction factor = Insertion loss + Cable loss
5. Emission Level = Correction Factor + Reading Value.

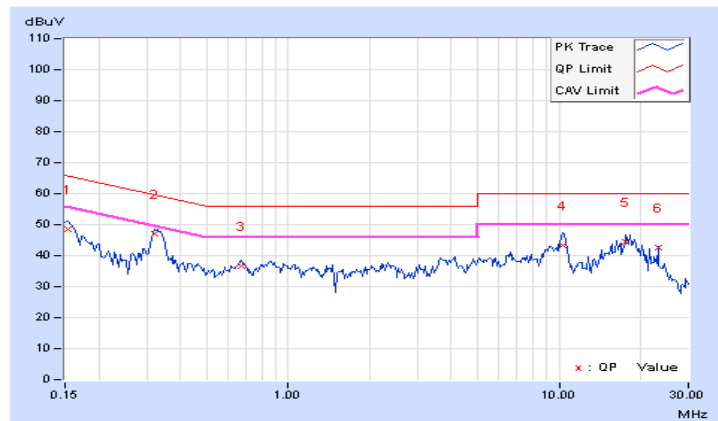

4.3 Frequency Stability

4.3.1 Limits of Frequency Stability Measurement

The frequency tolerance of the carrier signal shall be maintained within $\pm 0.01\%$ of the operating frequency over a temperature variation of -20 degrees to 50 degrees C at normal supply voltage, and for a variation in the primary supply voltage from 85% to 115% of the rated supply voltage at a temperature of 20 degrees C.

4.3.2 Test Setup

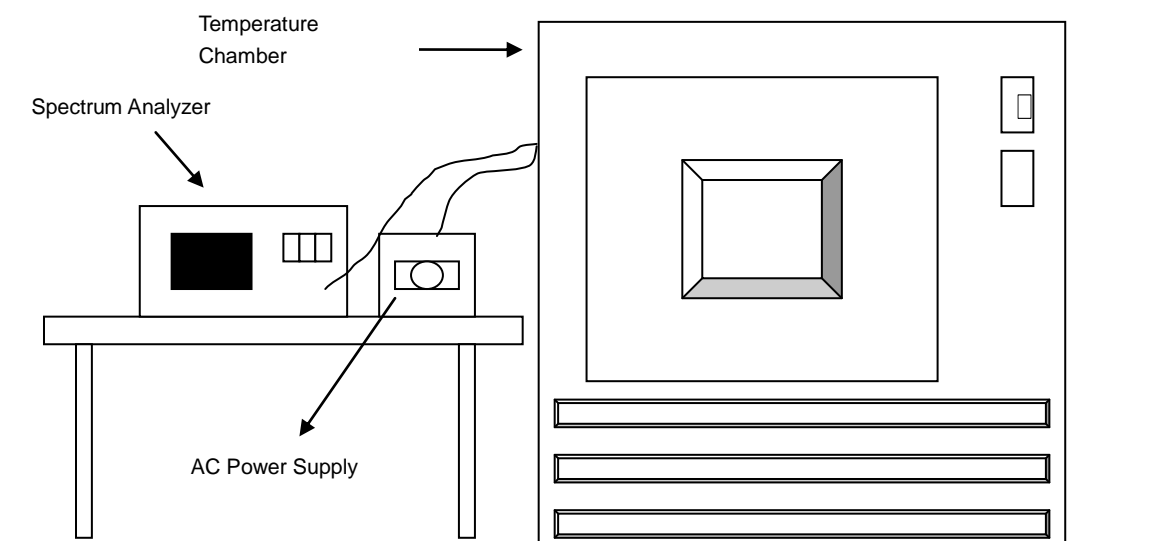

4.3.3 Test Instruments

Refer to section 4.1.2 to get information of above instrument.

4.3.4 Test Procedure

- The EUT was placed inside the environmental test chamber and powered by nominal AC voltage.
- Turned the EUT on and coupled its output to a spectrum analyzer.
- Turned the EUT off and set the chamber to the highest temperature specified.
- Allowed sufficient time (approximately 30 min) for the temperature of the chamber to stabilize then turned the EUT on and measured the operating frequency after 2, 5, and 10 minutes.
- Repeated step 2 and 3 with the temperature chamber set to the lowest temperature.
- The test chamber was allowed to stabilize at $+20$ degree C for a minimum of 30 minutes. The supply voltage was then adjusted on the EUT from 85% to 115% and the frequency record.

4.3.5 Deviation from Test Standard

No deviation.

4.3.6 EUT Operating Conditions

Same as Item 4.1.6.

4.3.7 Test Result

Frequency Stability Versus Temp.									
TEMP. (°C)	Power Supply (Vac)	0 Minute		2 Minutes		5 Minutes		10 Minutes	
		Measured Frequency	Frequency Drift	Measured Frequency	Frequency Drift	Measured Frequency	Frequency Drift	Measured Frequency	Frequency Drift
		(MHz)	%	(MHz)	%	(MHz)	%	(MHz)	%
50	120	13.55994	-0.00044	13.55995	-0.00037	13.55995	-0.00037	13.55994	-0.00044
40	120	13.56005	0.00037	13.56004	0.00029	13.56004	0.00029	13.56004	0.00029
30	120	13.55994	-0.00044	13.55994	-0.00044	13.55994	-0.00044	13.55995	-0.00037
20	120	13.55998	-0.00015	13.55999	-0.00007	13.56	0.00000	13.56	0.00000
10	120	13.55997	-0.00022	13.55998	-0.00015	13.55999	-0.00007	13.55997	-0.00022
0	120	13.56007	0.00052	13.56005	0.00037	13.56005	0.00037	13.56006	0.00044
-10	120	13.56004	0.00029	13.56003	0.00022	13.56002	0.00015	13.56003	0.00022
-20	120	13.56005	0.00037	13.56006	0.00044	13.56006	0.00044	13.56006	0.00044
-30	120	13.56001	0.00007	13.56002	0.00015	13.56001	0.00007	13.56	0.00000

Frequency Stability Versus Voltage									
TEMP. (°C)	Power Supply (Vdc)	0 Minute		2 Minutes		5 Minutes		10 Minutes	
		Measured Frequency	Frequency Drift	Measured Frequency	Frequency Drift	Measured Frequency	Frequency Drift	Measured Frequency	Frequency Drift
		(MHz)	%	(MHz)	%	(MHz)	%	(MHz)	%
20	138	13.55998	-0.00015	13.55999	-0.00007	13.56	0.00000	13.56	0.00000
	120	13.55998	-0.00015	13.55999	-0.00007	13.56	0.00000	13.56	0.00000
	102	13.55998	-0.00015	13.55999	-0.00007	13.56	0.00000	13.56	0.00000

4.4 20dB bandwidth

4.4.1 Limits of 20dB BANDWIDTH Measurement

The 20dB bandwidth shall be specified in operating frequency band.

4.4.2 Test Setup

Same as Item 4.1.5.

4.4.3 Test Instruments

Refer to section 4.1.2 to get information of above instrument.

4.4.4 Test Procedures

The bandwidth of the fundamental frequency was measured by spectrum analyzer with 10HzRBW and 30Hz VBW. The 20dB bandwidth is defined as the total spectrum the power of which is higher than peak power minus 20dB.

4.4.5 Deviation from Test Standard

No deviation.

4.4.6 EUT Operating Conditions

Same as Item 4.1.6.

4.4.7 Test Results

20dBc point (Low)	20dBc point (High)	Operating frequency band (MHz)	Pass/Fail
13.560502MHz	13.560707MHz	13.11 – 14.01	PASS

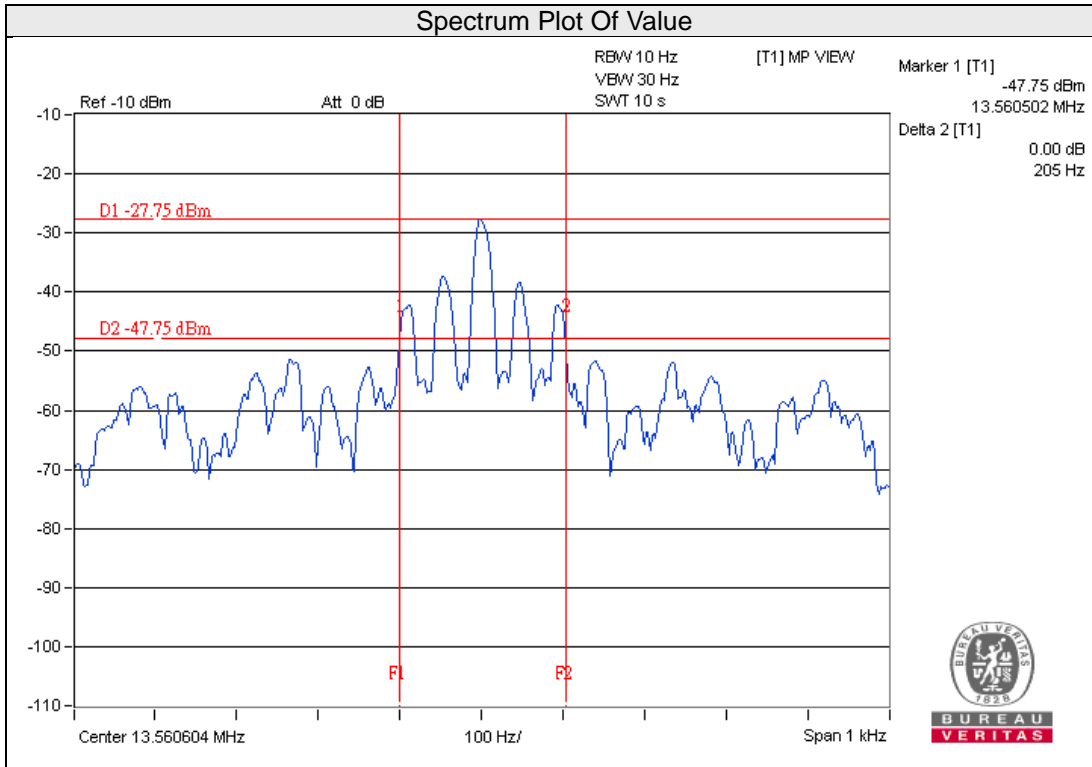

5 Pictures of Test Arrangements

Please refer to the attached file (Test Setup Photo).

Appendix – Information on the Testing Laboratories

We, Bureau Veritas Consumer Products Services (H.K.) Ltd., Taoyuan Branch, were founded in 1988 to provide our best service in EMC, Radio, Telecom and Safety consultation. Our laboratories are FCC recognized accredited test firms and accredited according to ISO/IEC 17025.

If you have any comments, please feel free to contact us at the following:

Linko EMC/RF Lab

Tel: 886-2-26052180

Fax: 886-2-26051924

Hsin Chu EMC/RF/Telecom Lab

Tel: 886-3-6668565

Fax: 886-3-6668323

Hwa Ya EMC/RF/Safety Lab

Tel: 886-3-3183232

Fax: 886-3-3270892

Email: service.adt@tw.bureauveritas.com

Web Site: www.bureauveritas-adt.com

The address and road map of all our labs can be found in our web site also.

--- END ---