

## FCC Test Report (WLAN-5GHz)

**Report No.:** RF160509E03-1

**FCC ID:** MQT-200I15YXF

**Test Model:** xCE\_E200I-15YXF

**Series Model:** xCE\_E200I-15NXF, xCE\_E200I-15YXX, xCE\_E200I-15NXX

**Received Date:** May 09, 2016

**Test Date:** May 20 to June 07, 2016

**Issued Date:** Aug. 12, 2016

**Applicant:** XAC AUTOMATION CORP.

**Address:** 4F, No. 30, INDUSTRY E. RD. IX, SCIENCE-BASED INDUSTRIAL  
PARK,HSINCHU,TAIWAN

**Issued By:** Bureau Veritas Consumer Products Services (H.K.) Ltd., Taoyuan Branch  
Hsin Chu Laboratory

**Lab Address:** E-2, No.1, Li Hsin 1st Road, Hsinchu Science Park, Hsinchu City 300,  
Taiwan R.O.C.

**Test Location (1):** E-2, No.1, Li Hsin 1st Road, Hsinchu Science Park, Hsinchu City 300,  
Taiwan R.O.C.

**Test Location (2):** No. 49, Ln. 206, Wende Rd., Shangshan Tsuen, Chiung Lin Hsiang, Hsin  
Chu Hsien 307, Taiwan R.O.C.



This report is for your exclusive use. Any copying or replication of this report to or for any other person or entity, or use of our name or trademark, is permitted only with our prior written permission. This report sets forth our findings solely with respect to the test samples identified herein. The results set forth in this report are not indicative or representative of the quality or characteristics of the lot from which a test sample was taken or any similar or identical product unless specifically and expressly noted. Our report includes all of the tests requested by you and the results thereof based upon the information that you provided to us. You have 60 days from date of issuance of this report to notify us of any material error or omission caused by our negligence, provided, however, that such notice shall be in writing and shall specifically address the issue you wish to raise. A failure to raise such issue within the prescribed time shall constitute your unqualified acceptance of the completeness of this report, the tests conducted and the correctness of the report contents. Unless specific mention, the uncertainty of measurement has been explicitly taken into account to declare the compliance or non-compliance to the specification. The report must not be used by the client to claim product certification, approval, or endorsement by TAF or any government agencies.

## Table of Contents

<b>Release Control Record</b> .....	<b>4</b>
<b>1 Certificate of Conformity</b> .....	<b>5</b>
<b>2 Summary of Test Results</b> .....	<b>6</b>
2.1 Measurement Uncertainty .....	6
2.2 Modification Record .....	6
<b>3 General Information</b> .....	<b>7</b>
3.1 General Description of EUT (WLAN) .....	7
3.2 Description of Test Modes .....	9
3.2.1 Test Mode Applicability and Tested Channel Detail .....	11
3.3 Duty Cycle of Test Signal .....	13
3.4 Description of Support Units .....	14
3.4.1 Configuration of System under Test .....	15
3.5 General Description of Applied Standard .....	17
<b>4 Test Types and Results</b> .....	<b>18</b>
4.1 Radiated Emission and Bandedge Measurement .....	18
4.1.1 Limits of Radiated Emission and Bandedge Measurement .....	18
4.1.2 Test Instruments .....	20
4.1.3 Test Procedure .....	21
4.1.4 Deviation from Test Standard .....	21
4.1.5 Test Setup .....	22
4.1.6 EUT Operating Condition .....	22
4.1.7 Test Results .....	23
4.2 Conducted Emission Measurement .....	57
4.2.1 Limits of Conducted Emission Measurement .....	57
4.2.2 Test Instruments .....	57
4.2.3 Test Procedure .....	58
4.2.4 Deviation from Test Standard .....	58
4.2.5 Test Setup .....	58
4.2.6 EUT Operating Condition .....	58
4.2.7 Test Results (Mode 1) .....	59
4.2.8 Test Results (Mode 2) .....	61
4.3 Transmit Power Measurement .....	63
4.3.1 Limits of Transmit Power Measurement .....	63
4.3.2 Test Setup .....	63
4.3.3 Test Instruments .....	63
4.3.4 Test Procedure .....	64
4.3.5 Deviation from Test Standard .....	64
4.3.6 EUT Operating Condition .....	64
4.3.7 Test Result .....	65
4.4 Peak Power Spectral Density Measurement .....	72
4.4.1 Limits of Peak Power Spectral Density Measurement .....	72
4.4.2 Test Setup .....	72
4.4.3 Test Instruments .....	72
4.4.4 Test Procedure .....	72
4.4.5 Deviation from Test Standard .....	73
4.4.6 EUT Operating Condition .....	73
4.4.7 Test Results .....	74
4.5 Frequency Stability Measurement .....	79
4.5.1 Limits of Frequency Stability Measurement .....	79
4.5.2 Test Setup .....	79
4.5.3 Test Instruments .....	79
4.5.4 Test Procedure .....	79
4.5.5 Deviation from Test Standard .....	79

4.5.6 EUT Operating Condition .....	79
4.5.7 Test Results .....	80
4.6 6dB Bandwidth Measurement .....	81
4.6.1 Limits of 6dB Bandwidth Measurement .....	81
4.6.2 Test Setup .....	81
4.6.3 Test Instruments .....	81
4.6.4 Test Procedure .....	81
4.6.5 Deviation from Test Standard .....	81
4.6.6 EUT Operating Condition .....	81
4.6.7 Test Results .....	82
<b>5 Pictures of Test Arrangements .....</b>	<b>84</b>
<b>Annex A- Radiated Out of Band Emisison (OOBE) Measurement (For U-NII-3 band) .....</b>	<b>85</b>
<b>Appendix – Information on the Testing Laboratories .....</b>	<b>88</b>

### Release Control Record

Issue No.	Description	Date Issued
RF160509E03-1	Original release.	Aug. 12, 2016

## 1 Certificate of Conformity

**Product:** Terminal

**Brand:** XAC

**Test Model:** xCE\_E200I-15YXF

**Series Model:** xCE\_E200I-15NXF, xCE\_E200I-15YXX, xCE\_E200I-15NXX

**Sample Status:** ENGINEERING SAMPLE

**Applicant:** XAC AUTOMATION CORP.

**Test Date:** May 20 to June 07, 2016

**Standard:** 47 CFR FCC Part 15, Subpart E (Section 15.407)  
ANSI C63.10: 2013

The above equipment has been tested by **Bureau Veritas Consumer Products Services (H.K.) Ltd., Taoyuan Branch**, and found compliance with the requirement of the above standards. The test record, data evaluation & Equipment Under Test (EUT) configurations represented herein are true and accurate accounts of the measurements of the sample's EMC characteristics under the conditions specified in this report.

**Prepared by :**  , **Date:** Aug. 12, 2016  
Claire Kuan / Specialist

**Approved by :**  , **Date:** Aug. 12, 2016  
May Chen / Manager

## 2 Summary of Test Results

47 CFR FCC Part 15, Subpart E (SECTION 15.407)			
FCC Clause	Test Item	Result	Remarks
15.407(b)(6)	AC Power Conducted Emissions	Pass	Meet the requirement of limit. Minimum passing margin is -3.28dB at 0.43906MHz.
15.407(b) (1/2/3/4(i/ii)/6)	Radiated Emissions & Band Edge Measurement*	Pass	Meet the requirement of limit. Minimum passing margin is -0.8dB at 5350.00MHz.
15.407(a)(1/2/3)	Max Average Transmit Power	Pass	Meet the requirement of limit.
15.407(a)(1/2/3)	Peak Power Spectral Density	Pass	Meet the requirement of limit.
15.407(e)	6dB bandwidth	Pass	Meet the requirement of limit. (U-NII-3 Band only)
15.407(g)	Frequency Stability	Pass	Meet the requirement of limit.
15.203	Antenna Requirement	Pass	No antenna connector is used.

\*For U-NII-3 band compliance with rule part 15.407(b)(4)(i), the OOB test plots were recorded in Annex A.

### 2.1 Measurement Uncertainty

Where relevant, the following measurement uncertainty levels have been estimated for tests performed on the EUT as specified in CISPR 16-4-2:

Measurement	Frequency	Expanded Uncertainty (k=2) (±)
Conducted Emissions at mains ports	150kHz ~ 30MHz	1.83 dB
Radiated Emissions up to 1 GHz	30MHz ~ 1GHz	5.37 dB
Radiated Emissions above 1 GHz	1GHz ~ 6GHz	3.65 dB
	6GHz ~ 18GHz	3.88 dB
	18GHz ~ 40GHz	4.11 dB

### 2.2 Modification Record

There were no modifications required for compliance.

### 3 General Information

#### 3.1 General Description of EUT (WLAN)

Product	Terminal
Brand	XAC
Test Model	xCE_E200I-15YXF
Series Model	xCE_E200I-15NXF, xCE_E200I-15YXX, xCE_E200I-15NXX
Status of EUT	ENGINEERING SAMPLE
Power Supply Rating	DC 24V
Modulation Type	CCK, DQPSK, DBPSK for DSSS 64QAM, 16QAM, QPSK, BPSK for OFDM
Modulation Technology	DSSS, OFDM
Transfer Rate	802.11b: up to 11Mbps 802.11a/g: up to 54Mbps 802.11n: up to 150Mbps
Operating Frequency	<b>For 15.247</b> 2.412 ~ 2.462GHz
	<b>For 15.407</b> 5.18 ~ 5.24GHz, 5.26 ~ 5.32GHz, 5.5 ~ 5.7GHz, 5.745 ~ 5.825GHz
Number of Channel	<b>For 15.247</b> 11 for 802.11b, 802.11g, 802.11n (HT20) 7 for 802.11n (HT40)
	<b>For 15.407</b> 24 for 802.11b, 802.11g, 802.11n (HT20) 11 for 802.11n (HT40)
Output Power	<b>For 15.247</b> 802.11n (HT20): 80.168mW
	<b>For 15.407</b> <b>5.18 ~ 5.24GHz</b> 802.11n (HT40): 11.324mW <b>5.26 ~ 5.32GHz</b> 802.11n (HT40): 11.429mW <b>5.5 ~ 5.7GHz</b> 802.11n (HT40): 7.925mW <b>5.745 ~ 5.825GHz</b> 802.11n (HT40): 7.709mW
Antenna Type	Refer to Note
Antenna Connector	Refer to Note
Accessory Device	Adapter (Optional) x 1
Data Cable Supplied	NA

Note:

- All models are listed as below.

Brand	Model	Difference	
XAC	xCE_E200I-15YXF	with Modem	with camera
	xCE_E200I-15YXX		without camera
	xCE_E200I-15NXF	without Modem	with camera
	xCE_E200I-15NXX		without camera

From the above models, model: xCE\_E200I-15YXF was the worst case and it was selected as representative model for the test and its data was recorded in this report.

- There are WLAN and Bluetooth technology used for the EUT.
- For WLAN: 2.4GHz & 5GHz technology cannot transmit at same time.

4. WLAN and Bluetooth coexistence mode:

Condition	Technology	
1	WLAN (2.4GHz)	Bluetooth
2	WLAN (5GHz)	Bluetooth

**Note:** The emission of the simultaneous operation has been evaluated and no non-compliance was found.

5. The EUT power needs to be supplied from one power adapter, the information is as below table:

Brand	Model No.	Spec.
FSP GROUP INC	FSP060-DAAN2	Input: 100-240Vac, 1.5A, 50-60Hz Output: 24V, 2.5A DC cable: unshielded, 1.5m with one core

6. The antenna provided to the EUT, please refer to the following table:

Brand	Model	Antenna Type	Connector Type	Antenna Gain(dBi)	Frequency range
INPAQ	ACM3-5036-A1-CC-S	Chip	NA	3	2.4~2.4835GHz 5.15~5.85GHz

7. The EUT incorporates a SISO function.

2.4GHz			
Modulation Mode	Data Rate (MCS)	Tx & Rx Configuration	
802.11b	1 ~ 11Mbps	1TX	1RX
802.11g	6 ~ 54Mbps	1TX	1RX
802.11n (HT20)	MCS 0~7	1TX	1RX
802.11n (HT40)	MCS 0~7	1TX	1RX
5GHz			
Modulation Mode	Data Rate (MCS)	Tx & Rx Configuration	
802.11a	6 ~ 54Mbps	1TX	1RX
802.11n (HT20)	MCS 0~7	1TX	1RX
802.11n (HT40)	MCS 0~7	1TX	1RX

8. The EUT was pre-tested under following test modes:

Pre-test Mode	Description
Mode A	Adapter (FSP060-DAAN2)
Mode B	Print + Adapter (FSP120-AAAN2)

The worst radiated emission was found in **Mode A**. Therefore only the test data of the modes were recorded in this report.

9. The above EUT information is declared by manufacturer and for more detailed features description, please refer to the manufacturer's specifications or user's manual.



### 3.2 Description of Test Modes

#### FOR 5180 ~ 5240MHz

4 channels are provided for 802.11a, 802.11n (HT20):

Channel	Frequency	Channel	Frequency
36	5180 MHz	44	5220 MHz
40	5200 MHz	48	5240 MHz

2 channels are provided for 802.11n (HT40):

Channel	Frequency	Channel	Frequency
38	5190 MHz	46	5230 MHz

#### FOR 5260 ~ 5320MHz

4 channels are provided for 802.11a, 802.11n (HT20):

Channel	Frequency	Channel	Frequency
52	5260 MHz	60	5300 MHz
56	5280 MHz	64	5320 MHz

2 channels are provided for 802.11n (HT40):

Channel	Frequency	Channel	Frequency
54	5270 MHz	62	5310 MHz

#### FOR 5500 ~ 5700MHz

11 channels are provided for 802.11a, 802.11n (HT20):

Channel	Frequency	Channel	Frequency
100	5500 MHz	124	5620 MHz
104	5520 MHz	128	5640 MHz
108	5540 MHz	132	5660 MHz
112	5560 MHz	136	5680 MHz
116	5580 MHz	140	5700 MHz
120	5600 MHz		

5 channels are provided for 802.11n (HT40):

Channel	Frequency	Channel	Frequency
102	5510 MHz	126	5630 MHz
110	5550 MHz	134	5670 MHz
118	5590 MHz		

**FOR 5745 ~ 5825MHz:**

5 channels are provided for 802.11a, 802.11n (HT20):

Channel	Frequency	Channel	Frequency
149	5745MHz	161	5805MHz
153	5765MHz	165	5825MHz
157	5785MHz		

2 channels are provided for 802.11n (HT40):

Channel	Frequency	Channel	Frequency
151	5755MHz	159	5795MHz

### 3.2.1 Test Mode Applicability and Tested Channel Detail

EUT Configure Mode	Applicable To				Description
	RE $\geq$ 1G	RE $<$ 1G	PLC	APCM	
1	√	√	√	√	EUT with Adapter (FSP060-DAAN2)
2	-	-	√	-	EUT with Print + Adapter (FSP120-AAAN2)

Where **RE $\geq$ 1G**: Radiated Emission above 1GHz      **RE $<$ 1G**: Radiated Emission below 1GHz  
**PLC**: Power Line Conducted Emission      **APCM**: Antenna Port Conducted Measurement

**NOTE:** 1. "-" means no effect.

2. The EUT's monitor had been pre-tested on the positioned of each 3 axis. The worst case was found when positioned on Z-plane.

#### Radiated Emission Test (Above 1GHz):

- Pre-Scan has been conducted to determine the worst-case mode from all possible combinations between available modulations, data rates and antenna ports (if EUT with antenna diversity architecture).
- Following channel(s) was (were) selected for the final test as listed below.

Mode	FREQ. Band (MHz)	Available Channel	Tested Channel	Modulation Technology	Modulation Type	Data Rate (Mbps)
802.11a	5180-5240	36 to 48	36, 40, 48	OFDM	BPSK	6
802.11n (HT20)		36 to 48	36, 40, 48	OFDM	BPSK	6.5
802.11n (HT40)		38 to 46	38, 46	OFDM	BPSK	13.5
802.11a	5260-5320	52 to 64	52, 60, 64	OFDM	BPSK	6
802.11n (HT20)		52 to 64	52, 60, 64	OFDM	BPSK	6.5
802.11n (HT40)		54 to 62	54, 62	OFDM	BPSK	13.5
802.11a	5500-5700	100 to 140	100, 116, 140	OFDM	BPSK	6
802.11n (HT20)		100 to 140	100, 116, 140	OFDM	BPSK	6.5
802.11n (HT40)		102 to 134	102, 110, 134	OFDM	BPSK	13.5
802.11a	5745-5825	149 to 165	149, 157, 165	OFDM	BPSK	6
802.11n (HT20)		149 to 165	149, 157, 165	OFDM	BPSK	6.5
802.11n (HT40)		151 to 159	151, 159	OFDM	BPSK	13.5

#### Radiated Emission Test (Below 1GHz):

- Pre-Scan has been conducted to determine the worst-case mode from all possible combinations between available modulations, data rates and antenna ports (if EUT with antenna diversity architecture).
- Following channel(s) was (were) selected for the final test as listed below.

Mode	FREQ. Band (MHz)	Available Channel	Tested Channel	Modulation Technology	Modulation Type	Data Rate (Mbps)
802.11n (HT40)	5180-5320	36 to 64	54	OFDM	BPSK	13.5
	5500-5700	100 to 140				
	5745-5825	149 to 165				

**Power Line Conducted Emission Test:**

- Pre-Scan has been conducted to determine the worst-case mode from all possible combinations between available modulations, data rates and antenna ports (if EUT with antenna diversity architecture).
- Following channel(s) was (were) selected for the final test as listed below.

Mode	FREQ. Band (MHz)	Available Channel	Tested Channel	Modulation Technology	Modulation Type	Data Rate (Mbps)
802.11n (HT40)	5180-5320	36 to 64	54	OFDM	BPSK	13.5
	5500-5700	100 to 140				
	5745-5825	149 to 165				

**Antenna Port Conducted Measurement:**

- This item includes all test value of each mode, but only includes spectrum plot of worst value of each mode.
- Pre-Scan has been conducted to determine the worst-case mode from all possible combinations between available modulations, data rates and antenna ports (if EUT with antenna diversity architecture).
- Following channel(s) was (were) selected for the final test as listed below.

Mode	FREQ. Band (MHz)	Available Channel	Tested Channel	Modulation Technology	Modulation Type	Data Rate (Mbps)
802.11a	5180-5240	36 to 48	36, 40, 48	OFDM	BPSK	6
802.11n (HT20)		36 to 48	36, 40, 48	OFDM	BPSK	6.5
802.11n (HT40)		38 to 46	38, 46	OFDM	BPSK	13.5
802.11a	5260-5320	52 to 64	52, 60, 64	OFDM	BPSK	6
802.11n (HT20)		52 to 64	52, 60, 64	OFDM	BPSK	6.5
802.11n (HT40)		54 to 62	54, 62	OFDM	BPSK	13.5
802.11a	5500-5700	100 to 140	100, 116, 140	OFDM	BPSK	6
802.11n (HT20)		100 to 140	100, 116, 140	OFDM	BPSK	6.5
802.11n (HT40)		102 to 134	102, 110, 134	OFDM	BPSK	13.5
802.11a	5745-5825	149 to 165	149, 157, 165	OFDM	BPSK	6
802.11n (HT20)		149 to 165	149, 157, 165	OFDM	BPSK	6.5
802.11n (HT40)		151 to 159	151, 159	OFDM	BPSK	13.5

**Test Condition:**

Applicable To	Environmental Conditions	Input Power	Tested By
RE≥1G	25deg. C, 65%RH	120Vac, 60Hz	JyunChun Lin
RE<1G	23deg. C, 67%RH	120Vac, 60Hz	JyunChun Lin
PLC	24deg. C, 59%RH 25deg. C, 68%RH	120Vac, 60Hz	Bear Lee Arthur Yang
APCM	23deg. C, 65%RH	120Vac, 60Hz	Anderson Chen

### 3.3 Duty Cycle of Test Signal

Duty cycle of test signal is < 98 %, duty factor is required

**802.11a:** Duty cycle =  $2.725/3.055 = 0.892$ , Duty factor =  $10 * \log(1/0.892) = 0.5$

**802.11n (HT20):** Duty cycle =  $2.532/2.867 = 0.883$ , Duty factor =  $10 * \log(1/0.883) = 0.54$

**802.11n (HT40):** Duty cycle =  $1.233/1.561 = 0.79$ , Duty factor =  $10 * \log(1/0.79) = 1.02$

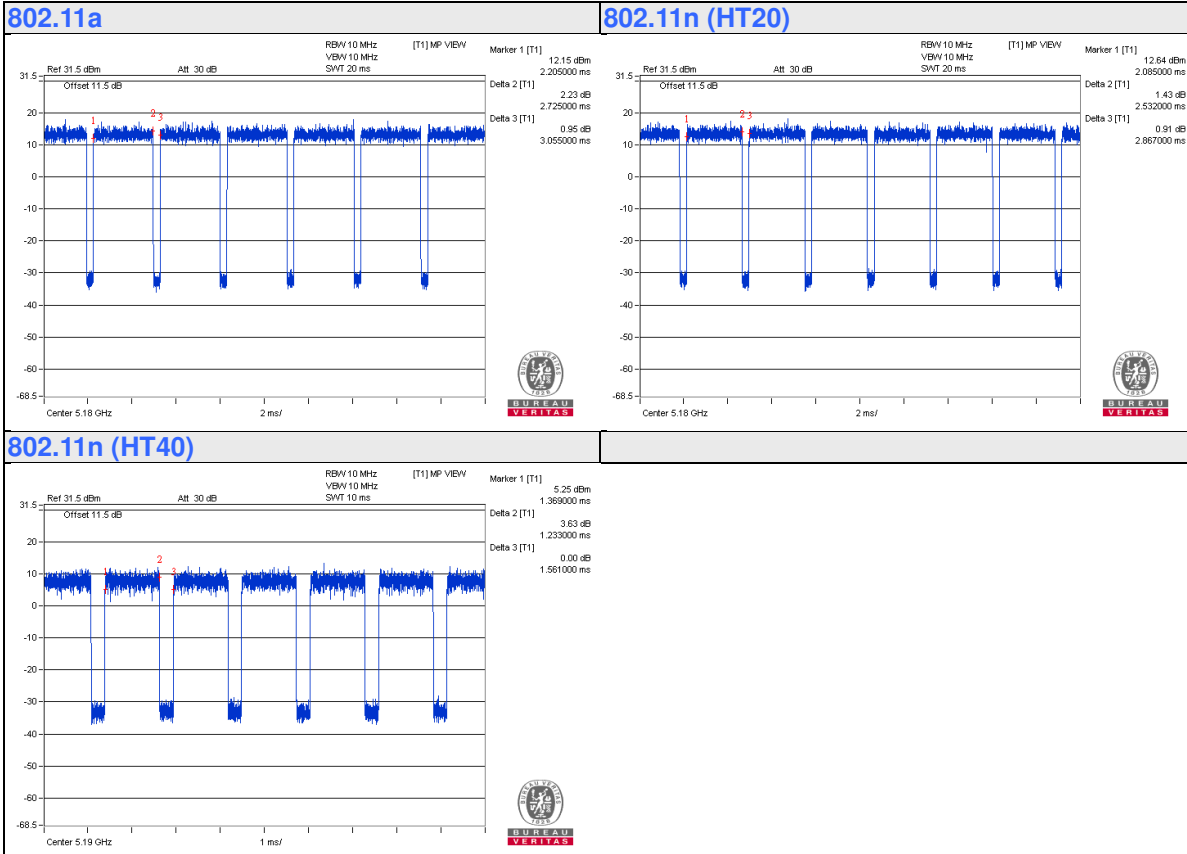

### 3.4 Description of Support Units

The EUT has been tested as an independent unit together with other necessary accessories or support units. The following support units or accessories were used to form a representative test configuration during the tests.

ID	Product	Brand	Model No.	Serial No.	FCC ID	Remarks
A.	iPod	Apple	MD778TA/A	CC4JMCMXF4T1	NA	Provided by Lab
B.	iPod	Apple	MD778TA/A	CC4JMJU0F4T1	NA	Provided by Lab
C.	iPod	Apple	MD778TA/A	CC4JD4CDF4T1	NA	Provided by Lab
D.	iPod	Apple	MD778TA/A	CC4JMJV2F4T1	NA	Provided by Lab
E.	iPod	Apple	MD778TA/A	CC4JMJTYF4T1	NA	Provided by Lab
F.	Notebook computer	DELL	PP32LA	GSLB32S	FCC DoC	Provided by Lab
G.	Earphone	XAC	TP72-SA	NA	NA	Supplied by client
H.	Micro SD	Sandisk	2G	NA	NA	Provided by Lab
I.	Adapter	FSP GROUP INC	FSP060-DAAN2	NA	NA	Supplied by client
J.	Print	XAC	TP72-SA	NA	NA	Supplied by client
K.	Adapter	FSP GROUP INC	FSP120-AAAN2	NA	NA	Supplied by client

Note:

1. All power cords of the above support units are non-shielded (1.8m).

ID	Descriptions	Qty.	Length (m)	Shielding (Yes/No)	Cores (Qty.)	Remarks
1.	DC	1	1.5	No	1	Supplied by client
2.	AC	1	1.8	No	0	Supplied by client
3.	RJ 11	1	1.5	No	0	Supplied by client
4.	RJ11 To RS232	1	1.5	No	0	Supplied by client
5.	RJ45	1	10	No	0	Provided by Lab
6.	RJ11 To RS232	1	1.5	No	0	Supplied by client
7.	RJ11 To RS232	1	1.5	No	0	Supplied by client
8.	USB	1	0.1	Yes	0	Provided by Lab
9.	USB	1	0.1	Yes	0	Provided by Lab
10.	USB	1	0.1	Yes	0	Provided by Lab
11.	USB	1	0.1	Yes	0	Provided by Lab
12.	USB	1	0.1	Yes	0	Provided by Lab
13.	Audio	1	1.3	No	0	Provided by Lab
14.	USB	1	1.8	Yes	0	Supplied by client
15.	DC	1	1	No	0	Supplied by client
16.	DC	1	1.5	No	1	Supplied by client
17.	AC	1	1.8	No	0	Supplied by client

### 3.4.1 Configuration of System under Test

#### ADAPTER MODE

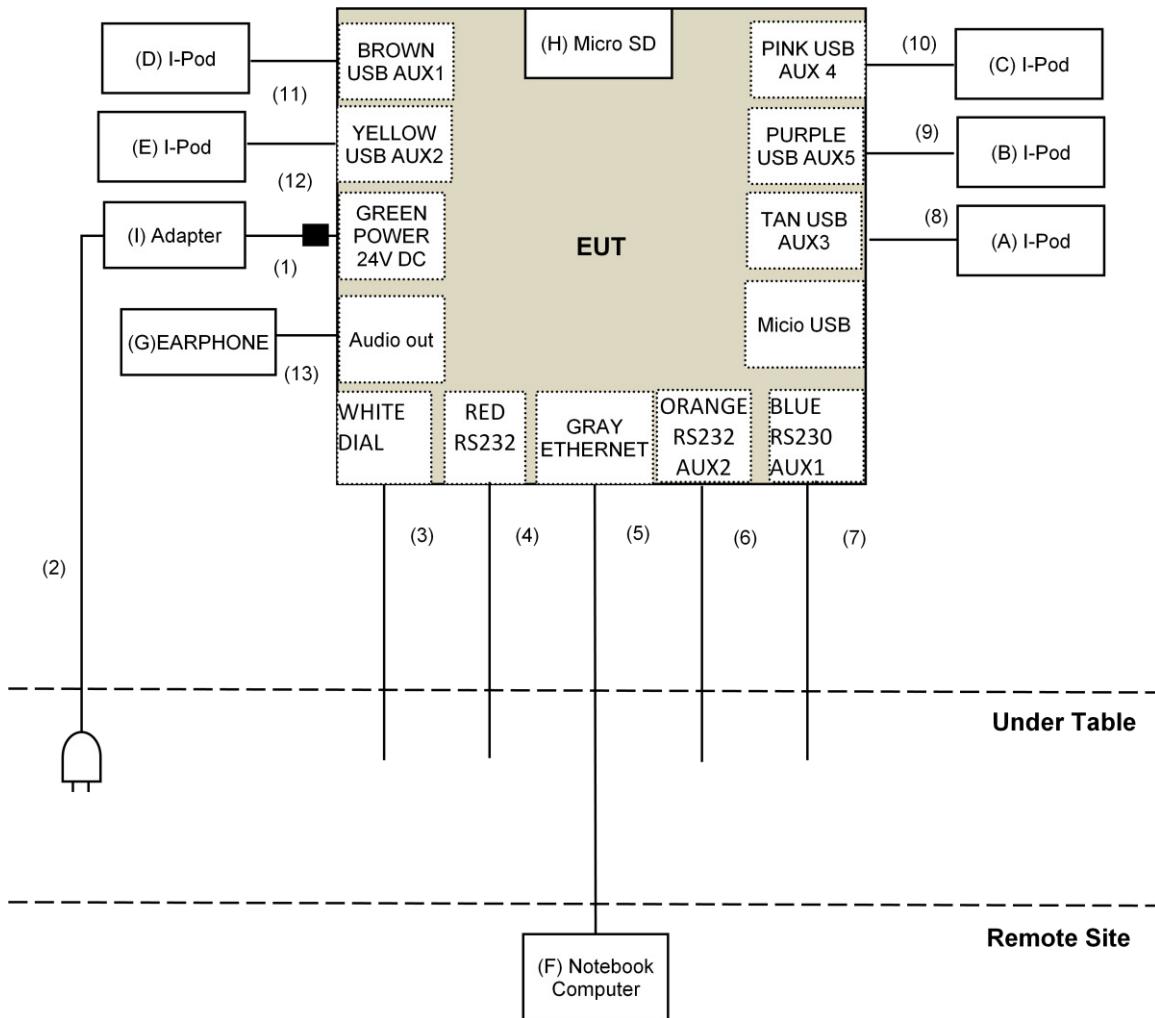

PRINT MODE

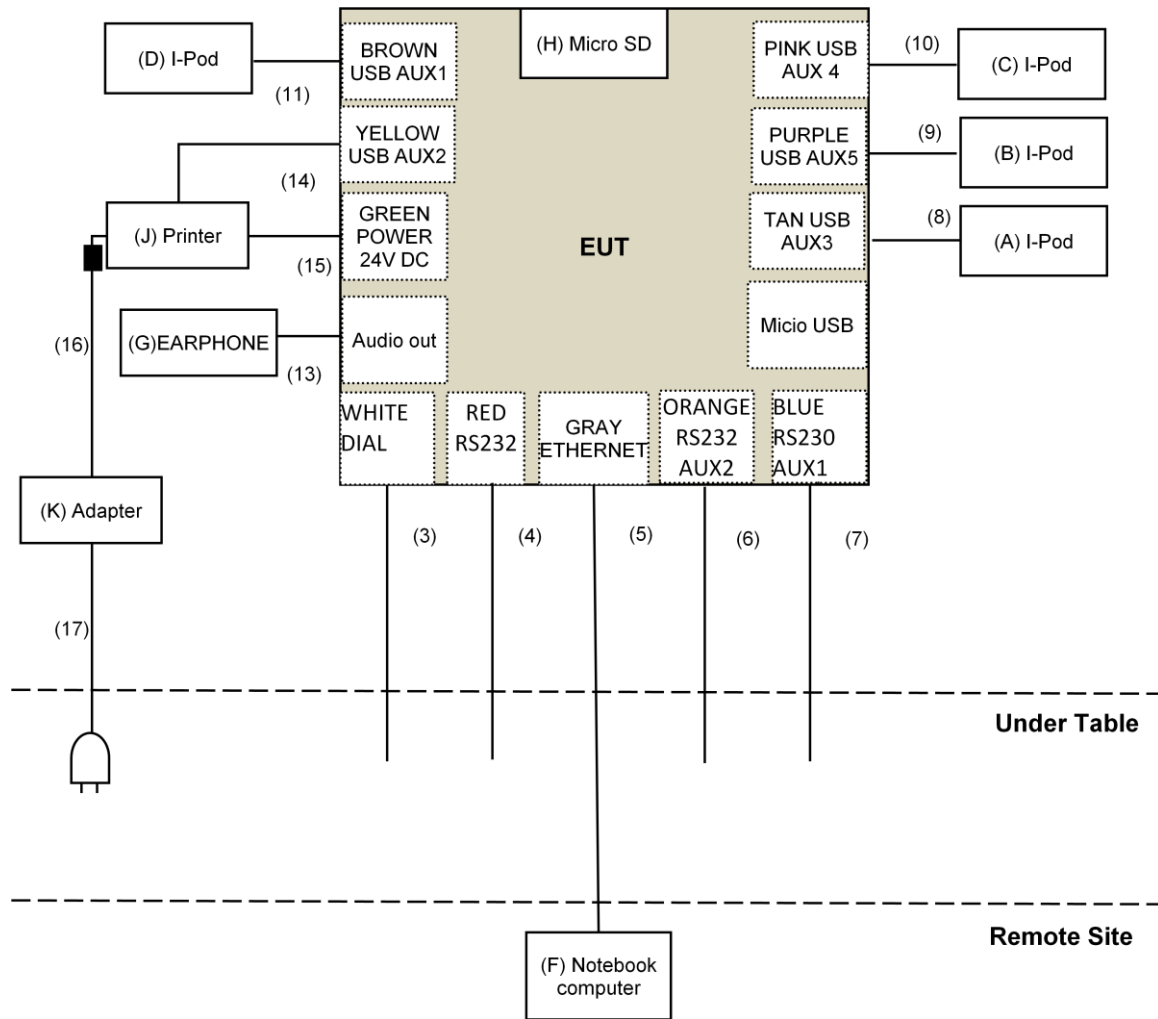



### 3.5 General Description of Applied Standard

The EUT is a RF Product. According to the specifications of the manufacturer, it must comply with the requirements of the following standards:

**FCC Part 15, Subpart E (15.407)**  
**KDB 789033 D02 General UNII Test Procedure New Rules v01r02**  
ANSI C63.10-2013

All test items have been performed and recorded as per the above standards.

## 4 Test Types and Results

### 4.1 Radiated Emission and Bandedge Measurement

#### 4.1.1 Limits of Radiated Emission and Bandedge Measurement

Radiated emissions which fall in the restricted bands must comply with the radiated emission limits specified as below table.

Frequencies (MHz)	Field Strength (microvolts/meter)	Measurement Distance (meters)
0.009 ~ 0.490	2400/F(kHz)	300
0.490 ~ 1.705	24000/F(kHz)	30
1.705 ~ 30.0	30	30
30 ~ 88	100	3
88 ~ 216	150	3
216 ~ 960	200	3
Above 960	500	3

#### NOTE:

1. The lower limit shall apply at the transition frequencies.
2. Emission level (dBuV/m) = 20 log Emission level (uV/m).
3. For frequencies above 1000MHz, the field strength limits are based on average detector, however, the peak field strength of any emission shall not exceed the maximum permitted average limits, specified above by more than 20dB under any condition of modulation.

#### Limits OF UNWANTED EMISSION OUT OF THE RESTRICTED Bands

Applicable To	Limit	
789033 D02 General UNII Test Procedure New Rules v01r02	FIELD STRENGTH at 3m	
	PK:74 (dBμV/m)	AV:54 (dBμV/m)
Applicable To	EIRP Limit	Equivalent Field Strength at 3m
15.407(b)(1)	PK:-27 (dBm/MHz)	PK:68.2(dBμV/m)
15.407(b)(2)		
15.407(b)(3)		
15.407(b)(4)(i)	PK:-27 (dBm/MHz) <sup>*1</sup> PK:10 (dBm/MHz) <sup>*2</sup> PK:15.6 (dBm/MHz) <sup>*3</sup> PK:27 (dBm/MHz) <sup>*4</sup>	PK: 68.2(dBμV/m) <sup>*1</sup> PK:105.2 (dBμV/m) <sup>*2</sup> PK: 110.8(dBμV/m) <sup>*3</sup> PK:122.2 (dBμV/m) <sup>*4</sup>
15.407(b)(4)(ii)	FIELD STRENGTH at 3m / § 15.247(d),	
	PK:74 (dBμV/m)	AV:54 (dBμV/m)
<sup>*1</sup> beyond 75 MHz or more above of the band edge. <sup>*2</sup> below the band edge increasing linearly to 10 dBm/MHz at 25 MHz above. <sup>*3</sup> below the band edge increasing linearly to a level of 15.6 dBm/MHz at 5 MHz above. <sup>*4</sup> from 5 MHz above or below the band edge increasing linearly to a level of 27 dBm/MHz at the band edge.		

**NOTE:**

The following formula is used to convert the equipment isotropic radiated power (eirp) to field strength:

$$E = \frac{1000000\sqrt{30P}}{3} \mu\text{V/m, where } P \text{ is the eirp (Watts).}$$

#### 4.1.2 Test Instruments

DESCRIPTION & MANUFACTURER	MODEL NO.	SERIAL NO.	CALIBRATED DATE	CALIBRATED UNTIL
Test Receiver Agilent	N9038A	MY51210105	July 24, 2015	July 23, 2016
Pre-Amplifier <sup>(*)</sup> EMCI	EMC001340	980142	Jan. 20, 2016	Jan. 19, 2018
Loop Antenna <sup>(*)</sup> Electro-Metrics	EM-6879	264	Dec. 16, 2014	Dec. 15, 2016
RF Cable	NA	LOOPCAB-001 LOOPCAB-002	Jan. 18, 2016	Jan. 17, 2017
Pre-Amplifier Mini-Circuits	ZFL-1000VH2 B	AMP-ZFL-03	Nov. 11, 2015	Nov. 10, 2016
Trilog Broadband Antenna SCHWARZBECK	VULB 9168	9168-360	Jan. 04, 2016	Jan. 03, 2017
RF Cable	8D-FB	CHGCAB-001 -1 CHGCAB-001 -2	Oct. 03, 2015	Oct. 02, 2016
	RF-141	CHGCAB-004	Oct. 03, 2015	Oct. 02, 2016
Horn_Antenna AISI	AIH.8018	000032009111 0	Jan. 19, 2016	Jan. 18, 2017
Pre-Amplifier Agilent	8449B	3008A02578	June 23, 2015	June 22, 2016
RF Cable	NA	131205 131216 131217 SNMY23684/ 4	Jan. 15, 2016	Jan. 14, 2017
Spectrum Analyzer Agilent	E4446A	MY48250254	Nov. 25, 2015	Nov. 24, 2016
Pre-Amplifier SPACEK LABS	SLKKa-48-6	9K16	Dec. 11, 2015	Dec. 10, 2016
Horn_Antenna SCHWARZBECK	BBHA 9170	9170-424	Jan. 18, 2016	Jan. 17, 2017
RF Cable	SUCOFLEX 102	36442/2 36434/2	Dec. 10, 2015	Dec.09, 2016
Software	ADT_Radiated _V8.7.07	NA	NA	NA
Antenna Tower & Turn Table CT	CM100	NA	NA	NA
Boresight Antenna Fixture	FBA-01	FBA-WD01	NA	NA
Spectrum Analyzer R&S	FSP40	100060	May 11, 2016	May 10, 2017
Temperature & Humidity Chamber Giant Force	GTH-150-40-S P-AR	MAA0812-00 8	Jan. 15, 2016	Jan. 14, 2017
True RMS Multimeter FLUKE	87III	73680266	Nov. 10, 2015	Nov. 09, 2016

**Note:**

1. The calibration interval of the above test instruments is 12 months and the calibrations are traceable to NML/ROC and NIST/USA.
2. The test was performed in 966 Chamber No. G.
3. The FCC Site Registration No. is 966073.
4. The CANADA Site Registration No. is IC 7450H-2.
5. Tested Date: May 20 to June 07, 2016

4.1.3 Test Procedure

- a. The EUT was placed on the top of a rotating table 0.8 meters (for below 1GHz) / 1.5 meters (for above 1GHz) above the ground at 3 meter chamber room for test. The table was rotated 360 degrees to determine the position of the highest radiation.
- b. The EUT was set 3 meters away from the interference-receiving antenna, which was mounted on the top of a variable-height antenna tower.
- c. The height of antenna is varied from one meter to four meters above the ground to determine the maximum value of the field strength. Both horizontal and vertical polarizations of the antenna are set to make the measurement.
- d. For each suspected emission, the EUT was arranged to its worst case and then the antenna was tuned to heights from 1 meter to 4 meters and the rotatable table was turned from 0 degrees to 360 degrees to find the maximum reading.
- e. The test-receiver system was set to quasi-peak detect function and specified bandwidth with maximum hold mode when the test frequency is below 1 GHz.
- f. The test-receiver system was set to peak and average detect function and specified bandwidth with maximum hold mode when the test frequency is above 1 GHz. If the peak reading value also meets average limit, measurement with the average detector is unnecessary.

**Note:**

1. The resolution bandwidth and video bandwidth of test receiver/spectrum analyzer is 120kHz for Quasi-peak detection (QP) at frequency below 1GHz.
2. The resolution bandwidth of test receiver/spectrum analyzer is 1 MHz and the video bandwidth is 3 MHz for Peak detection (PK) at frequency above 1GHz.
3. The resolution bandwidth of test receiver/spectrum analyzer is 1MHz and the video bandwidth is 3MHz for RMS Average (Duty cycle < 98%) for Average detection (AV) at frequency above 1GHz, then the measurement results was added to a correction factor ( $10 \log(1/\text{duty cycle})$ ).
4. The resolution bandwidth of test receiver/spectrum analyzer is 1MHz and the video bandwidth is 10Hz (Duty cycle  $\geq 98\%$ ) for Average detection (AV) at frequency above 1GHz.
5. All modes of operation were investigated and the worst-case emissions are reported.

4.1.4 Deviation from Test Standard

No deviation.

#### 4.1.5 Test Setup

##### <Frequency Range below 1GHz>

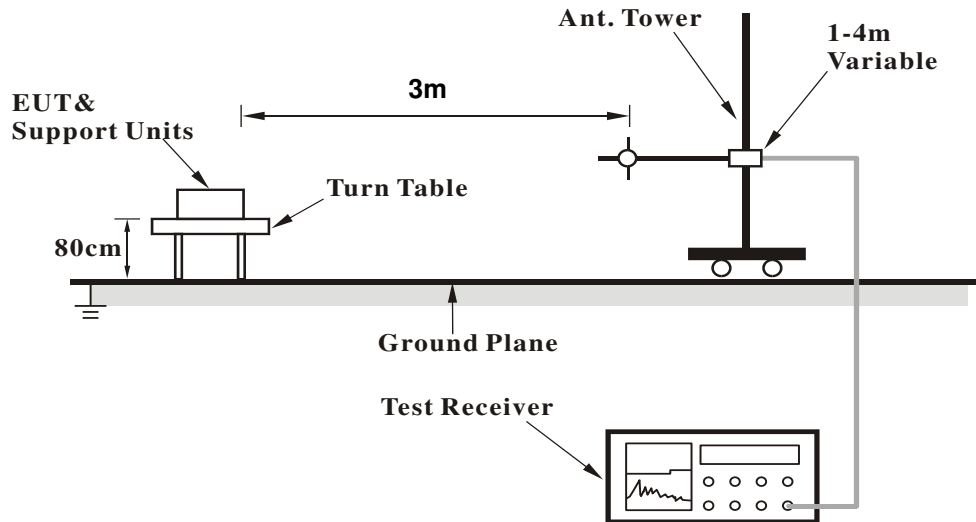

##### <Frequency Range above 1GHz>

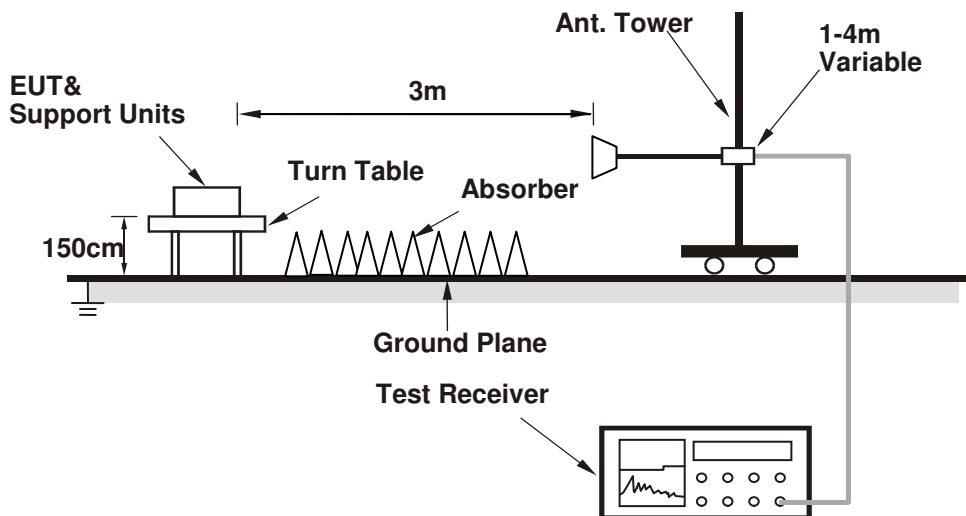

For the actual test configuration, please refer to the attached file (Test Setup Photo).

#### 4.1.6 EUT Operating Condition

1. Connect the EUT with the support unit F (Notebook Computer) which is placed on remote site.
2. The communication partner run test program "Run hyperterm terminal paste command" to enable EUT under transmission/receiving condition continuously at specific channel frequency.

4.1.7 Test Results

Above 1GHz Data :

802.11a

<b>CHANNEL</b>	TX Channel 36	<b>DETECTOR FUNCTION</b>	Peak (PK)
<b>FREQUENCY RANGE</b>	1GHz ~ 40GHz		Average (AV)

**ANTENNA POLARITY & TEST DISTANCE: HORIZONTAL AT 3 M**

NO.	FREQ. (MHz)	EMISSION LEVEL (dBuV/m)	LIMIT (dBuV/m)	MARGIN (dB)	ANTENNA HEIGHT (m)	TABLE ANGLE (Degree)	RAW VALUE (dBuV)	CORRECTION FACTOR (dB/m)
1	5150.00	59.80 PK	74.00	-14.20	1.48 H	334	49.50	10.30
2	5150.00	42.60 AV	54.00	-11.40	1.48 H	334	32.30	10.30
3	*5180.00	105.00 PK			1.48 H	334	94.40	10.60
4	*5180.00	94.20 AV			1.48 H	334	83.60	10.60
5	#10360.00	56.80 PK	74.00	-17.20	1.50 H	220	40.00	16.80
6	#10360.00	44.00 AV	54.00	-10.00	1.50 H	220	27.20	16.80
7	15540.00	61.00 PK	74.00	-13.00	1.62 H	262	38.50	22.50
8	15540.00	48.00 AV	54.00	-6.00	1.62 H	262	25.50	22.50

**ANTENNA POLARITY & TEST DISTANCE: VERTICAL AT 3 M**

NO.	FREQ. (MHz)	EMISSION LEVEL (dBuV/m)	LIMIT (dBuV/m)	MARGIN (dB)	ANTENNA HEIGHT (m)	TABLE ANGLE (Degree)	RAW VALUE (dBuV)	CORRECTION FACTOR (dB/m)
1	5150.00	60.60 PK	74.00	-13.40	1.77 V	27	50.30	10.30
2	5150.00	43.80 AV	54.00	-10.20	1.77 V	27	33.50	10.30
3	*5180.00	108.30 PK			1.77 V	27	97.70	10.60
4	*5180.00	97.70 AV			1.77 V	27	87.10	10.60
5	#10360.00	57.10 PK	74.00	-16.90	1.55 V	48	40.30	16.80
6	#10360.00	44.30 AV	54.00	-9.70	1.55 V	48	27.50	16.80
7	15540.00	60.60 PK	74.00	-13.40	1.48 V	62	38.10	22.50
8	15540.00	47.80 AV	54.00	-6.20	1.48 V	62	25.30	22.50

**REMARKS:**

1. Emission Level(dBuV/m) = Raw Value(dBuV) + Correction Factor(dB/m)
2. Correction Factor(dB/m) = Antenna Factor(dB/m) + Cable Factor(dB) – Pre-Amplifier Factor(dB)
3. The other emission levels were very low against the limit.
4. Margin value = Emission Level – Limit value
5. " \* " : Fundamental frequency.
6. " # " : The radiated frequency is out of the restricted band.

<b>CHANNEL</b>	TX Channel 40	<b>DETECTOR FUNCTION</b>	Peak (PK)
<b>FREQUENCY RANGE</b>	1GHz ~ 40GHz		Average (AV)

**ANTENNA POLARITY & TEST DISTANCE: HORIZONTAL AT 3 M**

NO.	FREQ. (MHz)	EMISSION LEVEL (dBuV/m)	LIMIT (dBuV/m)	MARGIN (dB)	ANTENNA HEIGHT (m)	TABLE ANGLE (Degree)	RAW VALUE (dBuV)	CORRECTION FACTOR (dB/m)
1	*5200.00	104.60 PK			1.43 H	324	93.90	10.70
2	*5200.00	94.00 AV			1.43 H	324	83.30	10.70
3	#10400.00	57.60 PK	74.00	-16.40	1.49 H	211	40.70	16.90
4	#10400.00	44.70 AV	54.00	-9.30	1.49 H	211	27.80	16.90
5	15600.00	60.30 PK	74.00	-13.70	1.61 H	251	37.80	22.50
6	15600.00	47.70 AV	54.00	-6.30	1.61 H	251	25.20	22.50

**ANTENNA POLARITY & TEST DISTANCE: VERTICAL AT 3 M**

NO.	FREQ. (MHz)	EMISSION LEVEL (dBuV/m)	LIMIT (dBuV/m)	MARGIN (dB)	ANTENNA HEIGHT (m)	TABLE ANGLE (Degree)	RAW VALUE (dBuV)	CORRECTION FACTOR (dB/m)
1	*5200.00	107.40 PK			1.74 V	27	96.70	10.70
2	*5200.00	97.30 AV			1.74 V	27	86.60	10.70
3	#10400.00	57.50 PK	74.00	-16.50	1.53 V	55	40.60	16.90
4	#10400.00	44.60 AV	54.00	-9.40	1.53 V	55	27.70	16.90
5	15600.00	59.90 PK	74.00	-14.10	1.52 V	48	37.40	22.50
6	15600.00	47.40 AV	54.00	-6.60	1.52 V	48	24.90	22.50

**REMARKS:**

1. Emission Level(dBuV/m) = Raw Value(dBuV) + Correction Factor(dB/m)
2. Correction Factor(dB/m) = Antenna Factor(dB/m) + Cable Factor(dB) – Pre-Amplifier Factor(dB)
3. The other emission levels were very low against the limit.
4. Margin value = Emission Level – Limit value
5. " \* ": Fundamental frequency.
6. " # ": The radiated frequency is out of the restricted band.



<b>CHANNEL</b>	TX Channel 48	<b>DETECTOR FUNCTION</b>	Peak (PK)
<b>FREQUENCY RANGE</b>	1GHz ~ 40GHz		Average (AV)

**ANTENNA POLARITY & TEST DISTANCE: HORIZONTAL AT 3 M**

NO.	FREQ. (MHz)	EMISSION LEVEL (dBuV/m)	LIMIT (dBuV/m)	MARGIN (dB)	ANTENNA HEIGHT (m)	TABLE ANGLE (Degree)	RAW VALUE (dBuV)	CORRECTION FACTOR (dB/m)
1	*5240.00	105.10 PK			1.46 H	331	94.40	10.70
2	*5240.00	94.00 AV			1.46 H	331	83.30	10.70
3	5350.00	60.20 PK	74.00	-13.80	1.46 H	331	49.60	10.60
4	5350.00	42.70 AV	54.00	-11.30	1.46 H	331	32.10	10.60
5	#10480.00	57.10 PK	74.00	-16.90	1.48 H	227	40.60	16.50
6	#10480.00	44.10 AV	54.00	-9.90	1.48 H	227	27.60	16.50
7	15720.00	60.60 PK	74.00	-13.40	1.60 H	250	38.00	22.60
8	15720.00	47.80 AV	54.00	-6.20	1.60 H	250	25.20	22.60

**ANTENNA POLARITY & TEST DISTANCE: VERTICAL AT 3 M**

NO.	FREQ. (MHz)	EMISSION LEVEL (dBuV/m)	LIMIT (dBuV/m)	MARGIN (dB)	ANTENNA HEIGHT (m)	TABLE ANGLE (Degree)	RAW VALUE (dBuV)	CORRECTION FACTOR (dB/m)
1	*5240.00	107.30 PK			1.75 V	24	96.60	10.70
2	*5240.00	97.30 AV			1.75 V	24	86.60	10.70
3	5350.00	54.90 PK	74.00	-19.10	1.75 V	24	44.30	10.60
4	5350.00	42.70 AV	54.00	-11.30	1.75 V	24	32.10	10.60
5	#10480.00	57.20 PK	74.00	-16.80	1.60 V	37	40.70	16.50
6	#10480.00	44.70 AV	54.00	-9.30	1.60 V	37	28.20	16.50
7	15720.00	60.80 PK	74.00	-13.20	1.51 V	78	38.20	22.60
8	15720.00	48.20 AV	54.00	-5.80	1.51 V	78	25.60	22.60

**REMARKS:**

1. Emission Level(dBuV/m) = Raw Value(dBuV) + Correction Factor(dB/m)
2. Correction Factor(dB/m) = Antenna Factor(dB/m) + Cable Factor(dB) – Pre-Amplifier Factor(dB)
3. The other emission levels were very low against the limit.
4. Margin value = Emission Level – Limit value
5. " \* ": Fundamental frequency.
6. " # ": The radiated frequency is out of the restricted band.

<b>CHANNEL</b>	TX Channel 52	<b>DETECTOR FUNCTION</b>	Peak (PK)
<b>FREQUENCY RANGE</b>	1GHz ~ 40GHz		Average (AV)

**ANTENNA POLARITY & TEST DISTANCE: HORIZONTAL AT 3 M**

NO.	FREQ. (MHz)	EMISSION LEVEL (dBuV/m)	LIMIT (dBuV/m)	MARGIN (dB)	ANTENNA HEIGHT (m)	TABLE ANGLE (Degree)	RAW VALUE (dBuV)	CORRECTION FACTOR (dB/m)
1	*5260.00	105.30 PK			1.46 H	322	94.70	10.60
2	*5260.00	94.30 AV			1.46 H	322	83.70	10.60
3	5350.00	60.40 PK	74.00	-13.60	1.46 H	322	49.80	10.60
4	5350.00	42.90 AV	54.00	-11.10	1.46 H	322	32.30	10.60
5	#10520.00	56.70 PK	74.00	-17.30	1.54 H	219	40.40	16.30
6	#10520.00	43.80 AV	54.00	-10.20	1.54 H	219	27.50	16.30
7	15780.00	60.90 PK	74.00	-13.10	1.66 H	262	38.50	22.40
8	15780.00	48.30 AV	54.00	-5.70	1.66 H	262	25.90	22.40

**ANTENNA POLARITY & TEST DISTANCE: VERTICAL AT 3 M**

NO.	FREQ. (MHz)	EMISSION LEVEL (dBuV/m)	LIMIT (dBuV/m)	MARGIN (dB)	ANTENNA HEIGHT (m)	TABLE ANGLE (Degree)	RAW VALUE (dBuV)	CORRECTION FACTOR (dB/m)
1	*5260.00	107.60 PK			1.74 V	25	97.00	10.60
2	*5260.00	97.40 AV			1.74 V	25	86.80	10.60
3	5350.00	55.80 PK	74.00	-18.20	1.74 V	25	45.20	10.60
4	5350.00	43.00 AV	54.00	-11.00	1.74 V	25	32.40	10.60
5	#10520.00	57.40 PK	74.00	-16.60	1.60 V	40	41.10	16.30
6	#10520.00	44.30 AV	54.00	-9.70	1.60 V	40	28.00	16.30
7	15780.00	61.10 PK	74.00	-12.90	1.44 V	70	38.70	22.40
8	15780.00	48.20 AV	54.00	-5.80	1.44 V	70	25.80	22.40

**REMARKS:**

1. Emission Level(dBuV/m) = Raw Value(dBuV) + Correction Factor(dB/m)
2. Correction Factor(dB/m) = Antenna Factor(dB/m) + Cable Factor(dB) – Pre-Amplifier Factor(dB)
3. The other emission levels were very low against the limit.
4. Margin value = Emission Level – Limit value
5. " \* ": Fundamental frequency.
6. " # ": The radiated frequency is out of the restricted band.

<b>CHANNEL</b>	TX Channel 60	<b>DETECTOR FUNCTION</b>	Peak (PK)
<b>FREQUENCY RANGE</b>	1GHz ~ 40GHz		Average (AV)

**ANTENNA POLARITY & TEST DISTANCE: HORIZONTAL AT 3 M**

NO.	FREQ. (MHz)	EMISSION LEVEL (dBuV/m)	LIMIT (dBuV/m)	MARGIN (dB)	ANTENNA HEIGHT (m)	TABLE ANGLE (Degree)	RAW VALUE (dBuV)	CORRECTION FACTOR (dB/m)
1	*5300.00	104.90 PK			1.48 H	331	94.30	10.60
2	*5300.00	94.00 AV			1.48 H	331	83.40	10.60
3	5350.00	59.90 PK	74.00	-14.10	1.48 H	331	49.30	10.60
4	5350.00	42.50 AV	54.00	-11.50	1.48 H	331	31.90	10.60
5	10600.00	57.30 PK	74.00	-16.70	1.50 H	220	41.10	16.20
6	10600.00	44.40 AV	54.00	-9.60	1.50 H	220	28.20	16.20
7	15900.00	61.10 PK	74.00	-12.90	1.64 H	276	38.60	22.50
8	15900.00	48.20 AV	54.00	-5.80	1.64 H	276	25.70	22.50

**ANTENNA POLARITY & TEST DISTANCE: VERTICAL AT 3 M**

NO.	FREQ. (MHz)	EMISSION LEVEL (dBuV/m)	LIMIT (dBuV/m)	MARGIN (dB)	ANTENNA HEIGHT (m)	TABLE ANGLE (Degree)	RAW VALUE (dBuV)	CORRECTION FACTOR (dB/m)
1	*5300.00	107.30 PK			1.68 V	23	96.70	10.60
2	*5300.00	97.50 AV			1.68 V	23	86.90	10.60
3	5350.00	56.30 PK	74.00	-17.70	1.68 V	23	45.70	10.60
4	5350.00	43.20 AV	54.00	-10.80	1.68 V	23	32.60	10.60
5	10600.00	57.10 PK	74.00	-16.90	1.50 V	62	40.90	16.20
6	10600.00	44.30 AV	54.00	-9.70	1.50 V	62	28.10	16.20
7	15900.00	60.60 PK	74.00	-13.40	1.51 V	55	38.10	22.50
8	15900.00	48.00 AV	54.00	-6.00	1.51 V	55	25.50	22.50

**REMARKS:**

1. Emission Level(dBuV/m) = Raw Value(dBuV) + Correction Factor(dB/m)
2. Correction Factor(dB/m) = Antenna Factor(dB/m) + Cable Factor(dB) – Pre-Amplifier Factor(dB)
3. The other emission levels were very low against the limit.
4. Margin value = Emission Level – Limit value
5. " \* ": Fundamental frequency.

<b>CHANNEL</b>	TX Channel 64	<b>DETECTOR FUNCTION</b>	Peak (PK)
<b>FREQUENCY RANGE</b>	1GHz ~ 40GHz		Average (AV)

**ANTENNA POLARITY & TEST DISTANCE: HORIZONTAL AT 3 M**

NO.	FREQ. (MHz)	EMISSION LEVEL (dBuV/m)	LIMIT (dBuV/m)	MARGIN (dB)	ANTENNA HEIGHT (m)	TABLE ANGLE (Degree)	RAW VALUE (dBuV)	CORRECTION FACTOR (dB/m)
1	*5320.00	104.70 PK			1.40 H	334	94.10	10.60
2	*5320.00	93.80 AV			1.40 H	334	83.20	10.60
3	5350.00	60.00 PK	74.00	-14.00	1.40 H	334	49.40	10.60
4	5350.00	42.70 AV	54.00	-11.30	1.40 H	334	32.10	10.60
5	10640.00	57.00 PK	74.00	-17.00	1.48 H	209	40.50	16.50
6	10640.00	44.30 AV	54.00	-9.70	1.48 H	209	27.80	16.50
7	15960.00	60.60 PK	74.00	-13.40	1.56 H	248	37.60	23.00
8	15960.00	48.00 AV	54.00	-6.00	1.56 H	248	25.00	23.00

**ANTENNA POLARITY & TEST DISTANCE: VERTICAL AT 3 M**

NO.	FREQ. (MHz)	EMISSION LEVEL (dBuV/m)	LIMIT (dBuV/m)	MARGIN (dB)	ANTENNA HEIGHT (m)	TABLE ANGLE (Degree)	RAW VALUE (dBuV)	CORRECTION FACTOR (dB/m)
1	*5320.00	107.40 PK			1.68 V	22	96.80	10.60
2	*5320.00	97.20 AV			1.68 V	22	86.60	10.60
3	5350.00	63.40 PK	74.00	-10.60	1.68 V	22	52.80	10.60
4	5350.00	44.90 AV	54.00	-9.10	1.68 V	22	34.30	10.60
5	10640.00	56.70 PK	74.00	-17.30	1.52 V	47	40.20	16.50
6	10640.00	43.90 AV	54.00	-10.10	1.52 V	47	27.40	16.50
7	15960.00	60.60 PK	74.00	-13.40	1.49 V	47	37.60	23.00
8	15960.00	47.70 AV	54.00	-6.30	1.49 V	47	24.70	23.00

**REMARKS:**

1. Emission Level(dBuV/m) = Raw Value(dBuV) + Correction Factor(dB/m)
2. Correction Factor(dB/m) = Antenna Factor(dB/m) + Cable Factor(dB) – Pre-Amplifier Factor(dB)
3. The other emission levels were very low against the limit.
4. Margin value = Emission Level – Limit value
5. " \* ": Fundamental frequency.

<b>CHANNEL</b>	TX Channel 100	<b>DETECTOR FUNCTION</b>	Peak (PK)
<b>FREQUENCY RANGE</b>	1GHz ~ 40GHz		Average (AV)

**ANTENNA POLARITY & TEST DISTANCE: HORIZONTAL AT 3 M**

NO.	FREQ. (MHz)	EMISSION LEVEL (dBuV/m)	LIMIT (dBuV/m)	MARGIN (dB)	ANTENNA HEIGHT (m)	TABLE ANGLE (Degree)	RAW VALUE (dBuV)	CORRECTION FACTOR (dB/m)
1	#5470.00	59.50 PK	74.00	-14.50	1.39 H	339	48.40	11.10
2	#5470.00	42.20 AV	54.00	-11.80	1.39 H	339	31.10	11.10
3	*5500.00	104.50 PK			1.39 H	339	93.30	11.20
4	*5500.00	93.20 AV			1.39 H	339	82.00	11.20
5	11000.00	57.20 PK	74.00	-16.80	1.47 H	207	40.00	17.20
6	11000.00	44.20 AV	54.00	-9.80	1.47 H	207	27.00	17.20
7	#16500.00	60.80 PK	74.00	-13.20	1.65 H	251	35.90	24.90
8	#16500.00	48.20 AV	54.00	-5.80	1.65 H	251	23.30	24.90

**ANTENNA POLARITY & TEST DISTANCE: VERTICAL AT 3 M**

NO.	FREQ. (MHz)	EMISSION LEVEL (dBuV/m)	LIMIT (dBuV/m)	MARGIN (dB)	ANTENNA HEIGHT (m)	TABLE ANGLE (Degree)	RAW VALUE (dBuV)	CORRECTION FACTOR (dB/m)
1	#5470.00	59.40 PK	74.00	-14.60	1.66 V	19	48.30	11.10
2	#5470.00	44.30 AV	54.00	-9.70	1.66 V	19	33.20	11.10
3	*5500.00	106.90 PK			1.66 V	19	95.70	11.20
4	*5500.00	96.70 AV			1.66 V	19	85.50	11.20
5	11000.00	57.40 PK	74.00	-16.60	1.61 V	41	40.20	17.20
6	11000.00	44.70 AV	54.00	-9.30	1.61 V	41	27.50	17.20
7	#16500.00	60.70 PK	74.00	-13.30	1.46 V	60	35.80	24.90
8	#16500.00	48.00 AV	54.00	-6.00	1.46 V	60	23.10	24.90

**REMARKS:**

1. Emission Level(dBuV/m) = Raw Value(dBuV) + Correction Factor(dB/m)
2. Correction Factor(dB/m) = Antenna Factor(dB/m) + Cable Factor(dB) – Pre-Amplifier Factor(dB)
3. The other emission levels were very low against the limit.
4. Margin value = Emission Level – Limit value
5. " \* ": Fundamental frequency.
6. " # ": The radiated frequency is out of the restricted band.

<b>CHANNEL</b>	TX Channel 116	<b>DETECTOR FUNCTION</b>	Peak (PK)
<b>FREQUENCY RANGE</b>	1GHz ~ 40GHz		Average (AV)

**ANTENNA POLARITY & TEST DISTANCE: HORIZONTAL AT 3 M**

NO.	FREQ. (MHz)	EMISSION LEVEL (dBuV/m)	LIMIT (dBuV/m)	MARGIN (dB)	ANTENNA HEIGHT (m)	TABLE ANGLE (Degree)	RAW VALUE (dBuV)	CORRECTION FACTOR (dB/m)
1	#5470.00	60.10 PK	74.00	-13.90	1.39 H	326	49.00	11.10
2	#5470.00	42.70 AV	54.00	-11.30	1.39 H	326	31.60	11.10
3	*5580.00	104.50 PK			1.39 H	326	93.20	11.30
4	*5580.00	93.30 AV			1.39 H	326	82.00	11.30
5	11160.00	56.50 PK	74.00	-17.50	1.53 H	225	38.70	17.80
6	11160.00	44.00 AV	54.00	-10.00	1.53 H	225	26.20	17.80
7	#16740.00	60.60 PK	74.00	-13.40	1.67 H	276	35.00	25.60
8	#16740.00	47.70 AV	54.00	-6.30	1.67 H	276	22.10	25.60

**ANTENNA POLARITY & TEST DISTANCE: VERTICAL AT 3 M**

NO.	FREQ. (MHz)	EMISSION LEVEL (dBuV/m)	LIMIT (dBuV/m)	MARGIN (dB)	ANTENNA HEIGHT (m)	TABLE ANGLE (Degree)	RAW VALUE (dBuV)	CORRECTION FACTOR (dB/m)
1	#5470.00	55.90 PK	74.00	-18.10	1.62 V	18	44.80	11.10
2	#5470.00	43.00 AV	54.00	-11.00	1.62 V	18	31.90	11.10
3	*5580.00	106.80 PK			1.62 V	18	95.50	11.30
4	*5580.00	96.70 AV			1.62 V	18	85.40	11.30
5	11160.00	57.00 PK	74.00	-17.00	1.57 V	35	39.20	17.80
6	11160.00	44.20 AV	54.00	-9.80	1.57 V	35	26.40	17.80
7	#16740.00	60.60 PK	74.00	-13.40	1.52 V	71	35.00	25.60
8	#16740.00	48.00 AV	54.00	-6.00	1.52 V	71	22.40	25.60

**REMARKS:**

1. Emission Level(dBuV/m) = Raw Value(dBuV) + Correction Factor(dB/m)
2. Correction Factor(dB/m) = Antenna Factor(dB/m) + Cable Factor(dB) – Pre-Amplifier Factor(dB)
3. The other emission levels were very low against the limit.
4. Margin value = Emission Level – Limit value
5. " \* ": Fundamental frequency.
6. " # ": The radiated frequency is out of the restricted band.

<b>CHANNEL</b>	TX Channel 140	<b>DETECTOR FUNCTION</b>	Peak (PK)
<b>FREQUENCY RANGE</b>	1GHz ~ 40GHz		Average (AV)

**ANTENNA POLARITY & TEST DISTANCE: HORIZONTAL AT 3 M**

NO.	FREQ. (MHz)	EMISSION LEVEL (dBuV/m)	LIMIT (dBuV/m)	MARGIN (dB)	ANTENNA HEIGHT (m)	TABLE ANGLE (Degree)	RAW VALUE (dBuV)	CORRECTION FACTOR (dB/m)
1	*5700.00	104.40 PK			1.40 H	319	92.90	11.50
2	*5700.00	93.30 AV			1.40 H	319	81.80	11.50
3	#5725.00	60.30 PK	74.00	-13.70	1.40 H	319	48.80	11.50
4	#5725.00	42.70 AV	54.00	-11.30	1.40 H	319	31.20	11.50
5	11400.00	57.40 PK	74.00	-16.60	1.48 H	234	39.80	17.60
6	11400.00	44.30 AV	54.00	-9.70	1.48 H	234	26.70	17.60
7	#17100.00	60.30 PK	74.00	-13.70	1.58 H	253	33.40	26.90
8	#17100.00	47.80 AV	54.00	-6.20	1.58 H	253	20.90	26.90

**ANTENNA POLARITY & TEST DISTANCE: VERTICAL AT 3 M**

NO.	FREQ. (MHz)	EMISSION LEVEL (dBuV/m)	LIMIT (dBuV/m)	MARGIN (dB)	ANTENNA HEIGHT (m)	TABLE ANGLE (Degree)	RAW VALUE (dBuV)	CORRECTION FACTOR (dB/m)
1	*5700.00	106.60 PK			1.83 V	19	95.10	11.50
2	*5700.00	96.60 AV			1.83 V	19	85.10	11.50
3	#5725.00	61.50 PK	74.00	-12.50	1.83 V	19	50.00	11.50
4	#5725.00	44.90 AV	54.00	-9.10	1.83 V	19	33.40	11.50
5	11400.00	57.00 PK	74.00	-17.00	1.50 V	36	39.40	17.60
6	11400.00	44.40 AV	54.00	-9.60	1.50 V	36	26.80	17.60
7	#17100.00	61.10 PK	74.00	-12.90	1.51 V	75	34.20	26.90
8	#17100.00	48.10 AV	54.00	-5.90	1.51 V	75	21.20	26.90

**REMARKS:**

1. Emission Level(dBuV/m) = Raw Value(dBuV) + Correction Factor(dB/m)
2. Correction Factor(dB/m) = Antenna Factor(dB/m) + Cable Factor(dB) – Pre-Amplifier Factor(dB)
3. The other emission levels were very low against the limit.
4. Margin value = Emission Level – Limit value
5. " \* ": Fundamental frequency.
6. " # ": The radiated frequency is out of the restricted band.

<b>CHANNEL</b>	TX Channel 149	<b>DETECTOR FUNCTION</b>	Peak (PK)
<b>FREQUENCY RANGE</b>	1GHz ~ 40GHz		Average (AV)

**ANTENNA POLARITY & TEST DISTANCE: HORIZONTAL AT 3 M**

NO.	FREQ. (MHz)	EMISSION LEVEL (dBuV/m)	LIMIT (dBuV/m)	MARGIN (dB)	ANTENNA HEIGHT (m)	TABLE ANGLE (Degree)	RAW VALUE (dBuV)	CORRECTION FACTOR (dB/m)
1	*5745.00	104.30 PK			1.43 H	326	92.60	11.70
2	*5745.00	93.10 AV			1.43 H	326	81.40	11.70
3	11490.00	56.70 PK	74.00	-17.30	1.51 H	220	38.80	17.90
4	11490.00	43.90 AV	54.00	-10.10	1.51 H	220	26.00	17.90
5	#17235.00	61.00 PK	74.00	-13.00	1.59 H	277	33.80	27.20
6	#17235.00	48.30 AV	54.00	-5.70	1.59 H	277	21.10	27.20

**ANTENNA POLARITY & TEST DISTANCE: VERTICAL AT 3 M**

NO.	FREQ. (MHz)	EMISSION LEVEL (dBuV/m)	LIMIT (dBuV/m)	MARGIN (dB)	ANTENNA HEIGHT (m)	TABLE ANGLE (Degree)	RAW VALUE (dBuV)	CORRECTION FACTOR (dB/m)
1	*5745.00	106.50 PK			1.83 V	18	94.80	11.70
2	*5745.00	96.40 AV			1.83 V	18	84.70	11.70
3	11490.00	57.00 PK	74.00	-17.00	1.53 V	59	39.10	17.90
4	11490.00	44.40 AV	54.00	-9.60	1.53 V	59	26.50	17.90
5	#17235.00	61.30 PK	74.00	-12.70	1.44 V	69	34.10	27.20
6	#17235.00	48.50 AV	54.00	-5.50	1.44 V	69	21.30	27.20

**REMARKS:**

1. Emission Level(dBuV/m) = Raw Value(dBuV) + Correction Factor(dB/m)
2. Correction Factor(dB/m) = Antenna Factor(dB/m) + Cable Factor(dB) – Pre-Amplifier Factor(dB)
3. The other emission levels were very low against the limit.
4. Margin value = Emission Level – Limit value
5. " \* ": Fundamental frequency.
6. " # ": The radiated frequency is out of the restricted band.



<b>CHANNEL</b>	TX Channel 157	<b>DETECTOR FUNCTION</b>	Peak (PK)
<b>FREQUENCY RANGE</b>	1GHz ~ 40GHz		Average (AV)

**ANTENNA POLARITY & TEST DISTANCE: HORIZONTAL AT 3 M**

NO.	FREQ. (MHz)	EMISSION LEVEL (dBuV/m)	LIMIT (dBuV/m)	MARGIN (dB)	ANTENNA HEIGHT (m)	TABLE ANGLE (Degree)	RAW VALUE (dBuV)	CORRECTION FACTOR (dB/m)
1	*5785.00	103.50 PK			1.44 H	327	91.60	11.90
2	*5785.00	92.40 AV			1.44 H	327	80.50	11.90
3	11570.00	57.50 PK	74.00	-16.50	1.44 H	222	39.50	18.00
4	11570.00	44.40 AV	54.00	-9.60	1.44 H	222	26.40	18.00
5	#17355.00	61.20 PK	74.00	-12.80	1.57 H	260	33.90	27.30
6	#17355.00	48.60 AV	54.00	-5.40	1.57 H	260	21.30	27.30

**ANTENNA POLARITY & TEST DISTANCE: VERTICAL AT 3 M**

NO.	FREQ. (MHz)	EMISSION LEVEL (dBuV/m)	LIMIT (dBuV/m)	MARGIN (dB)	ANTENNA HEIGHT (m)	TABLE ANGLE (Degree)	RAW VALUE (dBuV)	CORRECTION FACTOR (dB/m)
1	*5785.00	105.60 PK			1.83 V	17	93.70	11.90
2	*5785.00	95.50 AV			1.83 V	17	83.60	11.90
3	11570.00	57.40 PK	74.00	-16.60	1.56 V	64	39.40	18.00
4	11570.00	44.80 AV	54.00	-9.20	1.56 V	64	26.80	18.00
5	#17355.00	61.60 PK	74.00	-12.40	1.48 V	76	34.30	27.30
6	#17355.00	48.90 AV	54.00	-5.10	1.48 V	76	21.60	27.30

**REMARKS:**

1. Emission Level(dBuV/m) = Raw Value(dBuV) + Correction Factor(dB/m)
2. Correction Factor(dB/m) = Antenna Factor(dB/m) + Cable Factor(dB) – Pre-Amplifier Factor(dB)
3. The other emission levels were very low against the limit.
4. Margin value = Emission Level – Limit value
5. " \* ": Fundamental frequency.
6. " # ": The radiated frequency is out of the restricted band.

<b>CHANNEL</b>	TX Channel 165	<b>DETECTOR FUNCTION</b>	Peak (PK)
<b>FREQUENCY RANGE</b>	1GHz ~ 40GHz		Average (AV)

**ANTENNA POLARITY & TEST DISTANCE: HORIZONTAL AT 3 M**

NO.	FREQ. (MHz)	EMISSION LEVEL (dBuV/m)	LIMIT (dBuV/m)	MARGIN (dB)	ANTENNA HEIGHT (m)	TABLE ANGLE (Degree)	RAW VALUE (dBuV)	CORRECTION FACTOR (dB/m)
1	*5825.00	103.70 PK			1.47 H	327	91.80	11.90
2	*5825.00	92.80 AV			1.47 H	327	80.90	11.90
3	11650.00	57.10 PK	74.00	-16.90	1.46 H	222	39.10	18.00
4	11650.00	44.00 AV	54.00	-10.00	1.46 H	222	26.00	18.00
5	#17475.00	61.60 PK	74.00	-12.40	1.52 H	273	33.80	27.80
6	#17475.00	48.80 AV	54.00	-5.20	1.52 H	273	21.00	27.80

**ANTENNA POLARITY & TEST DISTANCE: VERTICAL AT 3 M**

NO.	FREQ. (MHz)	EMISSION LEVEL (dBuV/m)	LIMIT (dBuV/m)	MARGIN (dB)	ANTENNA HEIGHT (m)	TABLE ANGLE (Degree)	RAW VALUE (dBuV)	CORRECTION FACTOR (dB/m)
1	*5825.00	105.80 PK			2.03 V	15	93.90	11.90
2	*5825.00	96.00 AV			2.03 V	15	84.10	11.90
3	11650.00	57.30 PK	74.00	-16.70	1.56 V	62	39.30	18.00
4	11650.00	44.60 AV	54.00	-9.40	1.56 V	62	26.60	18.00
5	#17475.00	61.80 PK	74.00	-12.20	1.44 V	60	34.00	27.80
6	#17475.00	49.10 AV	54.00	-4.90	1.44 V	60	21.30	27.80

**REMARKS:**

1. Emission Level(dBuV/m) = Raw Value(dBuV) + Correction Factor(dB/m)
2. Correction Factor(dB/m) = Antenna Factor(dB/m) + Cable Factor(dB) – Pre-Amplifier Factor(dB)
3. The other emission levels were very low against the limit.
4. Margin value = Emission Level – Limit value
5. " \* ": Fundamental frequency.
6. " # ": The radiated frequency is out of the restricted band.

**802.11n (HT20)**

<b>CHANNEL</b>	TX Channel 36	<b>DETECTOR FUNCTION</b>	Peak (PK)
<b>FREQUENCY RANGE</b>	1GHz ~ 40GHz		Average (AV)

**ANTENNA POLARITY & TEST DISTANCE: HORIZONTAL AT 3 M**

NO.	FREQ. (MHz)	EMISSION LEVEL (dBuV/m)	LIMIT (dBuV/m)	MARGIN (dB)	ANTENNA HEIGHT (m)	TABLE ANGLE (Degree)	RAW VALUE (dBuV)	CORRECTION FACTOR (dB/m)
1	5150.00	60.20 PK	74.00	-13.80	1.48 H	350	49.90	10.30
2	5150.00	42.70 AV	54.00	-11.30	1.48 H	350	32.40	10.30
3	*5180.00	105.30 PK			1.48 H	350	94.70	10.60
4	*5180.00	94.50 AV			1.48 H	350	83.90	10.60
5	#10360.00	57.80 PK	74.00	-16.20	1.52 H	232	41.00	16.80
6	#10360.00	44.90 AV	54.00	-9.10	1.52 H	232	28.10	16.80
7	15540.00	60.80 PK	74.00	-13.20	1.65 H	294	38.30	22.50
8	15540.00	47.70 AV	54.00	-6.30	1.65 H	294	25.20	22.50

**ANTENNA POLARITY & TEST DISTANCE: VERTICAL AT 3 M**

NO.	FREQ. (MHz)	EMISSION LEVEL (dBuV/m)	LIMIT (dBuV/m)	MARGIN (dB)	ANTENNA HEIGHT (m)	TABLE ANGLE (Degree)	RAW VALUE (dBuV)	CORRECTION FACTOR (dB/m)
1	5150.00	62.30 PK	74.00	-11.70	1.71 V	27	52.00	10.30
2	5150.00	44.40 AV	54.00	-9.60	1.71 V	27	34.10	10.30
3	*5180.00	108.90 PK			1.71 V	27	98.30	10.60
4	*5180.00	97.80 AV			1.71 V	27	87.20	10.60
5	#10360.00	57.20 PK	74.00	-16.80	1.64 V	78	40.40	16.80
6	#10360.00	44.40 AV	54.00	-9.60	1.64 V	78	27.60	16.80
7	15540.00	60.20 PK	74.00	-13.80	1.46 V	52	37.70	22.50
8	15540.00	47.20 AV	54.00	-6.80	1.46 V	52	24.70	22.50

**REMARKS:**

- Emission Level(dBuV/m) = Raw Value(dBuV) + Correction Factor(dB/m)
- Correction Factor(dB/m) = Antenna Factor(dB/m) + Cable Factor(dB) – Pre-Amplifier Factor(dB)
- The other emission levels were very low against the limit.
- Margin value = Emission Level – Limit value
- " \* ": Fundamental frequency.
- " # ": The radiated frequency is out of the restricted band.

<b>CHANNEL</b>	TX Channel 40	<b>DETECTOR FUNCTION</b>	Peak (PK)
<b>FREQUENCY RANGE</b>	1GHz ~ 40GHz		Average (AV)

**ANTENNA POLARITY & TEST DISTANCE: HORIZONTAL AT 3 M**

NO.	FREQ. (MHz)	EMISSION LEVEL (dBuV/m)	LIMIT (dBuV/m)	MARGIN (dB)	ANTENNA HEIGHT (m)	TABLE ANGLE (Degree)	RAW VALUE (dBuV)	CORRECTION FACTOR (dB/m)
1	*5200.00	104.90 PK			1.46 H	348	94.20	10.70
2	*5200.00	94.20 AV			1.46 H	348	83.50	10.70
3	#10400.00	56.60 PK	74.00	-17.40	1.47 H	218	39.70	16.90
4	#10400.00	44.10 AV	54.00	-9.90	1.47 H	218	27.20	16.90
5	15600.00	61.00 PK	74.00	-13.00	1.63 H	275	38.50	22.50
6	15600.00	47.80 AV	54.00	-6.20	1.63 H	275	25.30	22.50

**ANTENNA POLARITY & TEST DISTANCE: VERTICAL AT 3 M**

NO.	FREQ. (MHz)	EMISSION LEVEL (dBuV/m)	LIMIT (dBuV/m)	MARGIN (dB)	ANTENNA HEIGHT (m)	TABLE ANGLE (Degree)	RAW VALUE (dBuV)	CORRECTION FACTOR (dB/m)
1	*5200.00	108.20 PK			1.70 V	27	97.50	10.70
2	*5200.00	97.70 AV			1.70 V	27	87.00	10.70
3	#10400.00	57.40 PK	74.00	-16.60	1.59 V	72	40.50	16.90
4	#10400.00	44.30 AV	54.00	-9.70	1.59 V	72	27.40	16.90
5	15600.00	60.30 PK	74.00	-13.70	1.43 V	45	37.80	22.50
6	15600.00	47.00 AV	54.00	-7.00	1.43 V	45	24.50	22.50

**REMARKS:**

1. Emission Level(dBuV/m) = Raw Value(dBuV) + Correction Factor(dB/m)
2. Correction Factor(dB/m) = Antenna Factor(dB/m) + Cable Factor(dB) – Pre-Amplifier Factor(dB)
3. The other emission levels were very low against the limit.
4. Margin value = Emission Level – Limit value
5. " \* ": Fundamental frequency.
6. " # ": The radiated frequency is out of the restricted band.

<b>CHANNEL</b>	TX Channel 48	<b>DETECTOR FUNCTION</b>	Peak (PK)
<b>FREQUENCY RANGE</b>	1GHz ~ 40GHz		Average (AV)

**ANTENNA POLARITY & TEST DISTANCE: HORIZONTAL AT 3 M**

NO.	FREQ. (MHz)	EMISSION LEVEL (dBuV/m)	LIMIT (dBuV/m)	MARGIN (dB)	ANTENNA HEIGHT (m)	TABLE ANGLE (Degree)	RAW VALUE (dBuV)	CORRECTION FACTOR (dB/m)
1	*5240.00	104.90 PK			1.54 H	322	94.20	10.70
2	*5240.00	94.30 AV			1.54 H	322	83.60	10.70
3	5350.00	60.10 PK	74.00	-13.90	1.54 H	322	49.50	10.60
4	5350.00	42.40 AV	54.00	-11.60	1.54 H	322	31.80	10.60
5	#10480.00	57.10 PK	74.00	-16.90	1.54 H	216	40.60	16.50
6	#10480.00	44.30 AV	54.00	-9.70	1.54 H	216	27.80	16.50
7	15720.00	61.20 PK	74.00	-12.80	1.61 H	272	38.60	22.60
8	15720.00	48.00 AV	54.00	-6.00	1.61 H	272	25.40	22.60

**ANTENNA POLARITY & TEST DISTANCE: VERTICAL AT 3 M**

NO.	FREQ. (MHz)	EMISSION LEVEL (dBuV/m)	LIMIT (dBuV/m)	MARGIN (dB)	ANTENNA HEIGHT (m)	TABLE ANGLE (Degree)	RAW VALUE (dBuV)	CORRECTION FACTOR (dB/m)
1	*5240.00	108.30 PK			1.71 V	23	97.60	10.70
2	*5240.00	97.70 AV			1.71 V	23	87.00	10.70
3	5350.00	55.30 PK	74.00	-18.70	1.71 V	23	44.70	10.60
4	5350.00	42.80 AV	54.00	-11.20	1.71 V	23	32.20	10.60
5	#10480.00	57.70 PK	74.00	-16.30	1.63 V	60	41.20	16.50
6	#10480.00	44.60 AV	54.00	-9.40	1.63 V	60	28.10	16.50
7	15720.00	60.40 PK	74.00	-13.60	1.43 V	64	37.80	22.60
8	15720.00	47.10 AV	54.00	-6.90	1.43 V	64	24.50	22.60

**REMARKS:**

1. Emission Level(dBuV/m) = Raw Value(dBuV) + Correction Factor(dB/m)
2. Correction Factor(dB/m) = Antenna Factor(dB/m) + Cable Factor(dB) – Pre-Amplifier Factor(dB)
3. The other emission levels were very low against the limit.
4. Margin value = Emission Level – Limit value
5. " \* ": Fundamental frequency.
6. " # ": The radiated frequency is out of the restricted band.

<b>CHANNEL</b>	TX Channel 52	<b>DETECTOR FUNCTION</b>	Peak (PK)
<b>FREQUENCY RANGE</b>	1GHz ~ 40GHz		Average (AV)

**ANTENNA POLARITY & TEST DISTANCE: HORIZONTAL AT 3 M**

NO.	FREQ. (MHz)	EMISSION LEVEL (dBuV/m)	LIMIT (dBuV/m)	MARGIN (dB)	ANTENNA HEIGHT (m)	TABLE ANGLE (Degree)	RAW VALUE (dBuV)	CORRECTION FACTOR (dB/m)
1	*5260.00	105.10 PK			1.47 H	337	94.50	10.60
2	*5260.00	94.50 AV			1.47 H	337	83.90	10.60
3	5350.00	55.10 PK	74.00	-18.90	1.47 H	337	44.50	10.60
4	5350.00	42.90 AV	54.00	-11.10	1.47 H	337	32.30	10.60
5	#10520.00	57.60 PK	74.00	-16.40	1.53 H	227	41.30	16.30
6	#10520.00	44.90 AV	54.00	-9.10	1.53 H	227	28.60	16.30
7	15780.00	61.40 PK	74.00	-12.60	1.57 H	277	39.00	22.40
8	15780.00	47.90 AV	54.00	-6.10	1.57 H	277	25.50	22.40

**ANTENNA POLARITY & TEST DISTANCE: VERTICAL AT 3 M**

NO.	FREQ. (MHz)	EMISSION LEVEL (dBuV/m)	LIMIT (dBuV/m)	MARGIN (dB)	ANTENNA HEIGHT (m)	TABLE ANGLE (Degree)	RAW VALUE (dBuV)	CORRECTION FACTOR (dB/m)
1	*5260.00	108.30 PK			1.71 V	23	97.70	10.60
2	*5260.00	97.80 AV			1.71 V	23	87.20	10.60
3	5350.00	55.60 PK	74.00	-18.40	1.71 V	23	45.00	10.60
4	5350.00	43.30 AV	54.00	-10.70	1.71 V	23	32.70	10.60
5	#10520.00	58.10 PK	74.00	-15.90	1.59 V	70	41.80	16.30
6	#10520.00	45.00 AV	54.00	-9.00	1.59 V	70	28.70	16.30
7	15780.00	60.40 PK	74.00	-13.60	1.45 V	53	38.00	22.40
8	15780.00	47.50 AV	54.00	-6.50	1.45 V	53	25.10	22.40

**REMARKS:**

1. Emission Level(dBuV/m) = Raw Value(dBuV) + Correction Factor(dB/m)
2. Correction Factor(dB/m) = Antenna Factor(dB/m) + Cable Factor(dB) – Pre-Amplifier Factor(dB)
3. The other emission levels were very low against the limit.
4. Margin value = Emission Level – Limit value
5. " \* ": Fundamental frequency.
6. " # ": The radiated frequency is out of the restricted band.

<b>CHANNEL</b>	TX Channel 60	<b>DETECTOR FUNCTION</b>	Peak (PK)
<b>FREQUENCY RANGE</b>	1GHz ~ 40GHz		Average (AV)

**ANTENNA POLARITY & TEST DISTANCE: HORIZONTAL AT 3 M**

NO.	FREQ. (MHz)	EMISSION LEVEL (dBuV/m)	LIMIT (dBuV/m)	MARGIN (dB)	ANTENNA HEIGHT (m)	TABLE ANGLE (Degree)	RAW VALUE (dBuV)	CORRECTION FACTOR (dB/m)
1	*5300.00	104.30 PK			1.48 H	329	93.70	10.60
2	*5300.00	93.80 AV			1.48 H	329	83.20	10.60
3	10600.00	57.00 PK	74.00	-17.00	1.53 H	208	40.80	16.20
4	10600.00	44.20 AV	54.00	-9.80	1.53 H	208	28.00	16.20
5	15900.00	61.30 PK	74.00	-12.70	1.55 H	284	38.80	22.50
6	15900.00	48.00 AV	54.00	-6.00	1.55 H	284	25.50	22.50

**ANTENNA POLARITY & TEST DISTANCE: VERTICAL AT 3 M**

NO.	FREQ. (MHz)	EMISSION LEVEL (dBuV/m)	LIMIT (dBuV/m)	MARGIN (dB)	ANTENNA HEIGHT (m)	TABLE ANGLE (Degree)	RAW VALUE (dBuV)	CORRECTION FACTOR (dB/m)
1	*5300.00	107.70 PK			1.71 V	21	97.10	10.60
2	*5300.00	97.20 AV			1.71 V	21	86.60	10.60
3	10600.00	57.30 PK	74.00	-16.70	1.62 V	74	41.10	16.20
4	10600.00	44.30 AV	54.00	-9.70	1.62 V	74	28.10	16.20
5	15900.00	60.70 PK	74.00	-13.30	1.37 V	51	38.20	22.50
6	15900.00	47.60 AV	54.00	-6.40	1.37 V	51	25.10	22.50

**REMARKS:**

1. Emission Level(dBuV/m) = Raw Value(dBuV) + Correction Factor(dB/m)
2. Correction Factor(dB/m) = Antenna Factor(dB/m) + Cable Factor(dB) – Pre-Amplifier Factor(dB)
3. The other emission levels were very low against the limit.
4. Margin value = Emission Level – Limit value
5. " \* ": Fundamental frequency.

<b>CHANNEL</b>	TX Channel 64	<b>DETECTOR FUNCTION</b>	Peak (PK)
<b>FREQUENCY RANGE</b>	1GHz ~ 40GHz		Average (AV)

**ANTENNA POLARITY & TEST DISTANCE: HORIZONTAL AT 3 M**

NO.	FREQ. (MHz)	EMISSION LEVEL (dBuV/m)	LIMIT (dBuV/m)	MARGIN (dB)	ANTENNA HEIGHT (m)	TABLE ANGLE (Degree)	RAW VALUE (dBuV)	CORRECTION FACTOR (dB/m)
1	*5320.00	104.20 PK			1.45 H	339	93.60	10.60
2	*5320.00	94.00 AV			1.45 H	339	83.40	10.60
3	5350.00	62.20 PK	74.00	-11.80	1.45 H	339	51.60	10.60
4	5350.00	43.80 AV	54.00	-10.20	1.45 H	339	33.20	10.60
5	10640.00	57.20 PK	74.00	-16.80	1.51 H	221	40.70	16.50
6	10640.00	44.50 AV	54.00	-9.50	1.51 H	221	28.00	16.50
7	15960.00	61.30 PK	74.00	-12.70	1.60 H	278	38.30	23.00
8	15960.00	48.10 AV	54.00	-5.90	1.60 H	278	25.10	23.00

**ANTENNA POLARITY & TEST DISTANCE: VERTICAL AT 3 M**

NO.	FREQ. (MHz)	EMISSION LEVEL (dBuV/m)	LIMIT (dBuV/m)	MARGIN (dB)	ANTENNA HEIGHT (m)	TABLE ANGLE (Degree)	RAW VALUE (dBuV)	CORRECTION FACTOR (dB/m)
1	*5320.00	107.90 PK			1.73 V	21	97.30	10.60
2	*5320.00	97.40 AV			1.73 V	21	86.80	10.60
3	5350.00	66.60 PK	74.00	-7.40	1.73 V	21	56.00	10.60
4	5350.00	46.00 AV	54.00	-8.00	1.73 V	21	35.40	10.60
5	10640.00	57.60 PK	74.00	-16.40	1.62 V	65	41.10	16.50
6	10640.00	44.70 AV	54.00	-9.30	1.62 V	65	28.20	16.50
7	15960.00	60.60 PK	74.00	-13.40	1.41 V	50	37.60	23.00
8	15960.00	47.50 AV	54.00	-6.50	1.41 V	50	24.50	23.00

**REMARKS:**

1. Emission Level(dBuV/m) = Raw Value(dBuV) + Correction Factor(dB/m)
2. Correction Factor(dB/m) = Antenna Factor(dB/m) + Cable Factor(dB) – Pre-Amplifier Factor(dB)
3. The other emission levels were very low against the limit.
4. Margin value = Emission Level – Limit value
5. " \* ": Fundamental frequency.



<b>CHANNEL</b>	TX Channel 100	<b>DETECTOR FUNCTION</b>	Peak (PK)
<b>FREQUENCY RANGE</b>	1GHz ~ 40GHz		Average (AV)

**ANTENNA POLARITY & TEST DISTANCE: HORIZONTAL AT 3 M**

NO.	FREQ. (MHz)	EMISSION LEVEL (dBuV/m)	LIMIT (dBuV/m)	MARGIN (dB)	ANTENNA HEIGHT (m)	TABLE ANGLE (Degree)	RAW VALUE (dBuV)	CORRECTION FACTOR (dB/m)
1	#5470.00	55.50 PK	74.00	-18.50	1.45 H	352	44.40	11.10
2	#5470.00	43.10 AV	54.00	-10.90	1.45 H	352	32.00	11.10
3	*5500.00	102.30 PK			1.45 H	352	91.10	11.20
4	*5500.00	92.50 AV			1.45 H	352	81.30	11.20
5	11000.00	57.80 PK	74.00	-16.20	1.46 H	251	40.60	17.20
6	11000.00	44.50 AV	54.00	-9.50	1.46 H	251	27.30	17.20
7	#16500.00	61.10 PK	74.00	-12.90	1.51 H	283	36.20	24.90
8	#16500.00	48.40 AV	54.00	-5.60	1.51 H	283	23.50	24.90

**ANTENNA POLARITY & TEST DISTANCE: VERTICAL AT 3 M**

NO.	FREQ. (MHz)	EMISSION LEVEL (dBuV/m)	LIMIT (dBuV/m)	MARGIN (dB)	ANTENNA HEIGHT (m)	TABLE ANGLE (Degree)	RAW VALUE (dBuV)	CORRECTION FACTOR (dB/m)
1	#5470.00	55.90 PK	74.00	-18.10	1.73 V	21	44.80	11.10
2	#5470.00	44.20 AV	54.00	-9.80	1.73 V	21	33.10	11.10
3	*5500.00	105.90 PK			1.73 V	21	94.70	11.20
4	*5500.00	96.10 AV			1.73 V	21	84.90	11.20
5	11000.00	57.70 PK	74.00	-16.30	1.59 V	53	40.50	17.20
6	11000.00	44.50 AV	54.00	-9.50	1.59 V	53	27.30	17.20
7	#16500.00	61.00 PK	74.00	-13.00	1.49 V	55	36.10	24.90
8	#16500.00	47.90 AV	54.00	-6.10	1.49 V	55	23.00	24.90

**REMARKS:**

1. Emission Level(dBuV/m) = Raw Value(dBuV) + Correction Factor(dB/m)
2. Correction Factor(dB/m) = Antenna Factor(dB/m) + Cable Factor(dB) – Pre-Amplifier Factor(dB)
3. The other emission levels were very low against the limit.
4. Margin value = Emission Level – Limit value
5. " \* ": Fundamental frequency.
6. " # ": The radiated frequency is out of the restricted band.

<b>CHANNEL</b>	TX Channel 116	<b>DETECTOR FUNCTION</b>	Peak (PK)
<b>FREQUENCY RANGE</b>	1GHz ~ 40GHz		Average (AV)

**ANTENNA POLARITY & TEST DISTANCE: HORIZONTAL AT 3 M**

NO.	FREQ. (MHz)	EMISSION LEVEL (dBuV/m)	LIMIT (dBuV/m)	MARGIN (dB)	ANTENNA HEIGHT (m)	TABLE ANGLE (Degree)	RAW VALUE (dBuV)	CORRECTION FACTOR (dB/m)
1	*5580.00	102.20 PK			1.43 H	340	90.90	11.30
2	*5580.00	92.30 AV			1.43 H	340	81.00	11.30
3	11600.00	57.50 PK	74.00	-16.50	1.47 H	246	39.50	18.00
4	11600.00	44.00 AV	54.00	-10.00	1.47 H	246	26.00	18.00
5	#16740.00	61.30 PK	74.00	-12.70	1.50 H	281	35.70	25.60
6	#16740.00	48.70 AV	54.00	-5.30	1.50 H	281	23.10	25.60

**ANTENNA POLARITY & TEST DISTANCE: VERTICAL AT 3 M**

NO.	FREQ. (MHz)	EMISSION LEVEL (dBuV/m)	LIMIT (dBuV/m)	MARGIN (dB)	ANTENNA HEIGHT (m)	TABLE ANGLE (Degree)	RAW VALUE (dBuV)	CORRECTION FACTOR (dB/m)
1	*5580.00	105.80 PK			1.73 V	19	94.50	11.30
2	*5580.00	95.70 AV			1.73 V	19	84.40	11.30
3	11160.00	57.10 PK	74.00	-16.90	1.61 V	61	39.30	17.80
4	11160.00	44.10 AV	54.00	-9.90	1.61 V	61	26.30	17.80
5	#16740.00	60.60 PK	74.00	-13.40	1.39 V	47	35.00	25.60
6	#16740.00	48.20 AV	54.00	-5.80	1.39 V	47	22.60	25.60

**REMARKS:**

1. Emission Level(dBuV/m) = Raw Value(dBuV) + Correction Factor(dB/m)
2. Correction Factor(dB/m) = Antenna Factor(dB/m) + Cable Factor(dB) – Pre-Amplifier Factor(dB)
3. The other emission levels were very low against the limit.
4. Margin value = Emission Level – Limit value
5. " \* ": Fundamental frequency.
6. " # ": The radiated frequency is out of the restricted band.

<b>CHANNEL</b>	TX Channel 140	<b>DETECTOR FUNCTION</b>	Peak (PK)
<b>FREQUENCY RANGE</b>	1GHz ~ 40GHz		Average (AV)

**ANTENNA POLARITY & TEST DISTANCE: HORIZONTAL AT 3 M**

NO.	FREQ. (MHz)	EMISSION LEVEL (dBuV/m)	LIMIT (dBuV/m)	MARGIN (dB)	ANTENNA HEIGHT (m)	TABLE ANGLE (Degree)	RAW VALUE (dBuV)	CORRECTION FACTOR (dB/m)
1	*5700.00	104.10 PK			1.47 H	346	92.60	11.50
2	*5700.00	93.80 AV			1.47 H	346	82.30	11.50
3	#5725.00	60.90 PK	74.00	-13.10	1.47 H	346	49.40	11.50
4	#5725.00	43.10 AV	54.00	-10.90	1.47 H	346	31.60	11.50
5	11400.00	57.40 PK	74.00	-16.60	1.48 H	236	39.80	17.60
6	11400.00	44.00 AV	54.00	-10.00	1.48 H	236	26.40	17.60
7	#17100.00	61.60 PK	74.00	-12.40	1.51 H	281	34.70	26.90
8	#17100.00	48.80 AV	54.00	-5.20	1.51 H	281	21.90	26.90

**ANTENNA POLARITY & TEST DISTANCE: VERTICAL AT 3 M**

NO.	FREQ. (MHz)	EMISSION LEVEL (dBuV/m)	LIMIT (dBuV/m)	MARGIN (dB)	ANTENNA HEIGHT (m)	TABLE ANGLE (Degree)	RAW VALUE (dBuV)	CORRECTION FACTOR (dB/m)
1	*5700.00	107.40 PK			1.81 V	19	95.90	11.50
2	*5700.00	96.70 AV			1.81 V	19	85.20	11.50
3	#5725.00	64.20 PK	74.00	-9.80	1.81 V	19	52.70	11.50
4	#5725.00	45.10 AV	54.00	-8.90	1.81 V	19	33.60	11.50
5	11400.00	57.50 PK	74.00	-16.50	1.60 V	56	39.90	17.60
6	11400.00	44.80 AV	54.00	-9.20	1.60 V	56	27.20	17.60
7	#17100.00	60.70 PK	74.00	-13.30	1.48 V	45	33.80	26.90
8	#17100.00	48.10 AV	54.00	-5.90	1.48 V	45	21.20	26.90

**REMARKS:**

1. Emission Level(dBuV/m) = Raw Value(dBuV) + Correction Factor(dB/m)
2. Correction Factor(dB/m) = Antenna Factor(dB/m) + Cable Factor(dB) – Pre-Amplifier Factor(dB)
3. The other emission levels were very low against the limit.
4. Margin value = Emission Level – Limit value
5. " \* ": Fundamental frequency.
6. " # ": The radiated frequency is out of the restricted band.

<b>CHANNEL</b>	TX Channel 149	<b>DETECTOR FUNCTION</b>	Peak (PK)
<b>FREQUENCY RANGE</b>	1GHz ~ 40GHz		Average (AV)

**ANTENNA POLARITY & TEST DISTANCE: HORIZONTAL AT 3 M**

NO.	FREQ. (MHz)	EMISSION LEVEL (dBuV/m)	LIMIT (dBuV/m)	MARGIN (dB)	ANTENNA HEIGHT (m)	TABLE ANGLE (Degree)	RAW VALUE (dBuV)	CORRECTION FACTOR (dB/m)
1	*5745.00	103.00 PK			1.47 H	325	91.30	11.70
2	*5745.00	93.00 AV			1.47 H	325	81.30	11.70
3	11490.00	57.00 PK	74.00	-17.00	1.45 H	231	39.10	17.90
4	11490.00	43.90 AV	54.00	-10.10	1.45 H	231	26.00	17.90
5	#17235.00	61.70 PK	74.00	-12.30	1.47 H	264	34.50	27.20
6	#17235.00	49.20 AV	54.00	-4.80	1.47 H	264	22.00	27.20

**ANTENNA POLARITY & TEST DISTANCE: VERTICAL AT 3 M**

NO.	FREQ. (MHz)	EMISSION LEVEL (dBuV/m)	LIMIT (dBuV/m)	MARGIN (dB)	ANTENNA HEIGHT (m)	TABLE ANGLE (Degree)	RAW VALUE (dBuV)	CORRECTION FACTOR (dB/m)
1	*5745.00	106.30 PK			1.76 V	17	94.60	11.70
2	*5745.00	95.80 AV			1.76 V	17	84.10	11.70
3	11490.00	57.20 PK	74.00	-16.80	1.57 V	50	39.30	17.90
4	11490.00	44.30 AV	54.00	-9.70	1.57 V	50	26.40	17.90
5	#17235.00	61.30 PK	74.00	-12.70	1.44 V	45	34.10	27.20
6	#17235.00	48.60 AV	54.00	-5.40	1.44 V	45	21.40	27.20

**REMARKS:**

1. Emission Level(dBuV/m) = Raw Value(dBuV) + Correction Factor(dB/m)
2. Correction Factor(dB/m) = Antenna Factor(dB/m) + Cable Factor(dB) – Pre-Amplifier Factor(dB)
3. The other emission levels were very low against the limit.
4. Margin value = Emission Level – Limit value
5. " \* ": Fundamental frequency.
6. " # ": The radiated frequency is out of the restricted band.

<b>CHANNEL</b>	TX Channel 157	<b>DETECTOR FUNCTION</b>	Peak (PK)
<b>FREQUENCY RANGE</b>	1GHz ~ 40GHz		Average (AV)

**ANTENNA POLARITY & TEST DISTANCE: HORIZONTAL AT 3 M**

NO.	FREQ. (MHz)	EMISSION LEVEL (dBuV/m)	LIMIT (dBuV/m)	MARGIN (dB)	ANTENNA HEIGHT (m)	TABLE ANGLE (Degree)	RAW VALUE (dBuV)	CORRECTION FACTOR (dB/m)
1	*5785.00	102.80 PK			1.41 H	326	90.90	11.90
2	*5785.00	92.90 AV			1.41 H	326	81.00	11.90
3	11570.00	56.50 PK	74.00	-17.50	1.46 H	206	38.50	18.00
4	11570.00	43.60 AV	54.00	-10.40	1.46 H	206	25.60	18.00
5	#17355.00	61.90 PK	74.00	-12.10	1.54 H	274	34.60	27.30
6	#17355.00	49.10 AV	54.00	-4.90	1.54 H	274	21.80	27.30

**ANTENNA POLARITY & TEST DISTANCE: VERTICAL AT 3 M**

NO.	FREQ. (MHz)	EMISSION LEVEL (dBuV/m)	LIMIT (dBuV/m)	MARGIN (dB)	ANTENNA HEIGHT (m)	TABLE ANGLE (Degree)	RAW VALUE (dBuV)	CORRECTION FACTOR (dB/m)
1	*5785.00	106.00 PK			2.15 V	17	94.10	11.90
2	*5785.00	95.40 AV			2.15 V	17	83.50	11.90
3	11570.00	56.90 PK	74.00	-17.10	1.55 V	77	38.90	18.00
4	11570.00	44.50 AV	54.00	-9.50	1.55 V	77	26.50	18.00
5	#17355.00	61.50 PK	74.00	-12.50	1.41 V	72	34.20	27.30
6	#17355.00	48.90 AV	54.00	-5.10	1.41 V	72	21.60	27.30

**REMARKS:**

1. Emission Level(dBuV/m) = Raw Value(dBuV) + Correction Factor(dB/m)
2. Correction Factor(dB/m) = Antenna Factor(dB/m) + Cable Factor(dB) – Pre-Amplifier Factor(dB)
3. The other emission levels were very low against the limit.
4. Margin value = Emission Level – Limit value
5. " \* ": Fundamental frequency.
6. " # ": The radiated frequency is out of the restricted band.

<b>CHANNEL</b>	TX Channel 165	<b>DETECTOR FUNCTION</b>	Peak (PK)
<b>FREQUENCY RANGE</b>	1GHz ~ 40GHz		Average (AV)

**ANTENNA POLARITY & TEST DISTANCE: HORIZONTAL AT 3 M**

NO.	FREQ. (MHz)	EMISSION LEVEL (dBuV/m)	LIMIT (dBuV/m)	MARGIN (dB)	ANTENNA HEIGHT (m)	TABLE ANGLE (Degree)	RAW VALUE (dBuV)	CORRECTION FACTOR (dB/m)
1	*5825.00	102.30 PK			1.54 H	327	90.40	11.90
2	*5825.00	92.50 AV			1.54 H	327	80.60	11.90
3	11650.00	56.90 PK	74.00	-17.10	1.40 H	225	38.90	18.00
4	11650.00	43.90 AV	54.00	-10.10	1.40 H	225	25.90	18.00
5	#17475.00	62.00 PK	74.00	-12.00	1.56 H	285	34.20	27.80
6	#17475.00	49.30 AV	54.00	-4.70	1.56 H	285	21.50	27.80

**ANTENNA POLARITY & TEST DISTANCE: VERTICAL AT 3 M**

NO.	FREQ. (MHz)	EMISSION LEVEL (dBuV/m)	LIMIT (dBuV/m)	MARGIN (dB)	ANTENNA HEIGHT (m)	TABLE ANGLE (Degree)	RAW VALUE (dBuV)	CORRECTION FACTOR (dB/m)
1	*5825.00	105.50 PK			2.15 V	15	93.60	11.90
2	*5825.00	95.10 AV			2.15 V	15	83.20	11.90
3	11650.00	57.60 PK	74.00	-16.40	1.53 V	51	39.60	18.00
4	11650.00	44.90 AV	54.00	-9.10	1.53 V	51	26.90	18.00
5	#17475.00	61.70 PK	74.00	-12.30	1.50 V	49	33.90	27.80
6	#17475.00	48.80 AV	54.00	-5.20	1.50 V	49	21.00	27.80

**REMARKS:**

1. Emission Level(dBuV/m) = Raw Value(dBuV) + Correction Factor(dB/m)
2. Correction Factor(dB/m) = Antenna Factor(dB/m) + Cable Factor(dB) – Pre-Amplifier Factor(dB)
3. The other emission levels were very low against the limit.
4. Margin value = Emission Level – Limit value
5. " \* ": Fundamental frequency.
6. " # ": The radiated frequency is out of the restricted band.

**802.11n (HT40)**

<b>CHANNEL</b>	TX Channel 38	<b>DETECTOR FUNCTION</b>	Peak (PK)
<b>FREQUENCY RANGE</b>	1GHz ~ 40GHz		Average (AV)

**ANTENNA POLARITY & TEST DISTANCE: HORIZONTAL AT 3 M**

NO.	FREQ. (MHz)	EMISSION LEVEL (dBuV/m)	LIMIT (dBuV/m)	MARGIN (dB)	ANTENNA HEIGHT (m)	TABLE ANGLE (Degree)	RAW VALUE (dBuV)	CORRECTION FACTOR (dB/m)
1	5150.00	67.10 PK	74.00	-6.90	1.57 H	332	56.80	10.30
2	5150.00	48.00 AV	54.00	-6.00	1.57 H	332	37.70	10.30
3	*5190.00	99.70 PK			1.57 H	332	89.00	10.70
4	*5190.00	89.10 AV			1.57 H	332	78.40	10.70
5	5350.00	54.00 PK	74.00	-20.00	1.57 H	332	43.40	10.60
6	5350.00	42.00 AV	54.00	-12.00	1.57 H	332	31.40	10.60
7	#10380.00	57.10 PK	74.00	-16.90	1.56 H	241	40.30	16.80
8	#10380.00	44.60 AV	54.00	-9.40	1.56 H	241	27.80	16.80
9	15570.00	62.00 PK	74.00	-12.00	1.54 H	275	39.40	22.60
10	15570.00	48.30 AV	54.00	-5.70	1.54 H	275	25.70	22.60

**ANTENNA POLARITY & TEST DISTANCE: VERTICAL AT 3 M**

NO.	FREQ. (MHz)	EMISSION LEVEL (dBuV/m)	LIMIT (dBuV/m)	MARGIN (dB)	ANTENNA HEIGHT (m)	TABLE ANGLE (Degree)	RAW VALUE (dBuV)	CORRECTION FACTOR (dB/m)
1	5150.00	69.50 PK	74.00	-4.50	1.74 V	26	59.20	10.30
2	5150.00	50.40 AV	54.00	-3.60	1.74 V	26	40.10	10.30
3	*5190.00	105.60 PK			1.74 V	26	94.90	10.70
4	*5190.00	94.70 AV			1.74 V	26	84.00	10.70
5	5350.00	54.20 PK	74.00	-19.80	1.74 V	26	43.60	10.60
6	5350.00	42.20 AV	54.00	-11.80	1.74 V	26	31.60	10.60
7	#10380.00	57.20 PK	74.00	-16.80	1.58 V	58	40.40	16.80
8	#10380.00	44.50 AV	54.00	-9.50	1.58 V	58	27.70	16.80
9	15570.00	61.20 PK	74.00	-12.80	1.53 V	48	38.60	22.60
10	15570.00	48.50 AV	54.00	-5.50	1.53 V	48	25.90	22.60

**REMARKS:**

- Emission Level(dBuV/m) = Raw Value(dBuV) + Correction Factor(dB/m)
- Correction Factor(dB/m) = Antenna Factor(dB/m) + Cable Factor(dB) – Pre-Amplifier Factor(dB)
- The other emission levels were very low against the limit.
- Margin value = Emission Level – Limit value
- " \* ": Fundamental frequency.
- " # ": The radiated frequency is out of the restricted band.

<b>CHANNEL</b>	TX Channel 46	<b>DETECTOR FUNCTION</b>	Peak (PK)
<b>FREQUENCY RANGE</b>	1GHz ~ 40GHz		Average (AV)

**ANTENNA POLARITY & TEST DISTANCE: HORIZONTAL AT 3 M**

NO.	FREQ. (MHz)	EMISSION LEVEL (dBuV/m)	LIMIT (dBuV/m)	MARGIN (dB)	ANTENNA HEIGHT (m)	TABLE ANGLE (Degree)	RAW VALUE (dBuV)	CORRECTION FACTOR (dB/m)
1	5150.00	54.80 PK	74.00	-19.20	1.55 H	323	44.50	10.30
2	5150.00	42.20 AV	54.00	-11.80	1.55 H	323	31.90	10.30
3	*5230.00	99.20 PK			1.55 H	323	88.50	10.70
4	*5230.00	88.80 AV			1.55 H	323	78.10	10.70
5	5350.00	54.30 PK	74.00	-19.70	1.55 H	323	43.70	10.60
6	5350.00	41.90 AV	54.00	-12.10	1.55 H	323	31.30	10.60
7	#10460.00	57.50 PK	74.00	-16.50	1.58 H	235	41.00	16.50
8	#10460.00	45.00 AV	54.00	-9.00	1.58 H	235	28.50	16.50
9	15690.00	61.80 PK	74.00	-12.20	1.53 H	271	39.20	22.60
10	15690.00	48.30 AV	54.00	-5.70	1.53 H	271	25.70	22.60

**ANTENNA POLARITY & TEST DISTANCE: VERTICAL AT 3 M**

NO.	FREQ. (MHz)	EMISSION LEVEL (dBuV/m)	LIMIT (dBuV/m)	MARGIN (dB)	ANTENNA HEIGHT (m)	TABLE ANGLE (Degree)	RAW VALUE (dBuV)	CORRECTION FACTOR (dB/m)
1	5150.00	54.90 PK	74.00	-19.10	1.74 V	25	44.60	10.30
2	5150.00	42.40 AV	54.00	-11.60	1.74 V	25	32.10	10.30
3	*5230.00	105.30 PK			1.74 V	25	94.60	10.70
4	*5230.00	94.20 AV			1.74 V	25	83.50	10.70
5	5350.00	55.10 PK	74.00	-18.90	1.74 V	25	44.50	10.60
6	5350.00	42.60 AV	54.00	-11.40	1.74 V	25	32.00	10.60
7	#10460.00	57.90 PK	74.00	-16.10	1.53 V	58	41.40	16.50
8	#10460.00	45.00 AV	54.00	-9.00	1.53 V	58	28.50	16.50
9	15690.00	61.30 PK	74.00	-12.70	1.46 V	43	38.70	22.60
10	15690.00	48.60 AV	54.00	-5.40	1.46 V	43	26.00	22.60

**REMARKS:**

- Emission Level(dBuV/m) = Raw Value(dBuV) + Correction Factor(dB/m)
- Correction Factor(dB/m) = Antenna Factor(dB/m) + Cable Factor(dB) – Pre-Amplifier Factor(dB)
- The other emission levels were very low against the limit.
- Margin value = Emission Level – Limit value
- " \* ": Fundamental frequency.
- " # ": The radiated frequency is out of the restricted band.



<b>CHANNEL</b>	TX Channel 54	<b>DETECTOR FUNCTION</b>	Peak (PK)
<b>FREQUENCY RANGE</b>	1GHz ~ 40GHz		Average (AV)

**ANTENNA POLARITY & TEST DISTANCE: HORIZONTAL AT 3 M**

NO.	FREQ. (MHz)	EMISSION LEVEL (dBuV/m)	LIMIT (dBuV/m)	MARGIN (dB)	ANTENNA HEIGHT (m)	TABLE ANGLE (Degree)	RAW VALUE (dBuV)	CORRECTION FACTOR (dB/m)
1	5150.00	54.20 PK	74.00	-19.80	1.61 H	317	43.90	10.30
2	5150.00	42.00 AV	54.00	-12.00	1.61 H	317	31.70	10.30
3	*5270.00	99.00 PK			1.61 H	317	88.30	10.70
4	*5270.00	88.60 AV			1.61 H	317	77.90	10.70
5	5350.00	55.00 PK	74.00	-19.00	1.61 H	317	44.40	10.60
6	5350.00	42.50 AV	54.00	-11.50	1.61 H	317	31.90	10.60
7	#10540.00	58.00 PK	74.00	-16.00	1.53 H	221	41.80	16.20
8	#10540.00	45.30 AV	54.00	-8.70	1.53 H	221	29.10	16.20
9	15810.00	61.60 PK	74.00	-12.40	1.56 H	290	39.30	22.30
10	15810.00	48.10 AV	54.00	-5.90	1.56 H	290	25.80	22.30

**ANTENNA POLARITY & TEST DISTANCE: VERTICAL AT 3 M**

NO.	FREQ. (MHz)	EMISSION LEVEL (dBuV/m)	LIMIT (dBuV/m)	MARGIN (dB)	ANTENNA HEIGHT (m)	TABLE ANGLE (Degree)	RAW VALUE (dBuV)	CORRECTION FACTOR (dB/m)
1	5150.00	54.60 PK	74.00	-19.40	1.74 V	23	44.30	10.30
2	5150.00	42.10 AV	54.00	-11.90	1.74 V	23	31.80	10.30
3	*5270.00	105.20 PK			1.74 V	23	94.50	10.70
4	*5270.00	94.20 AV			1.74 V	23	83.50	10.70
5	5350.00	56.10 PK	74.00	-17.90	1.74 V	23	45.50	10.60
6	5350.00	43.10 AV	54.00	-10.90	1.74 V	23	32.50	10.60
7	#10540.00	57.40 PK	74.00	-16.60	1.52 V	65	41.20	16.20
8	#10540.00	44.80 AV	54.00	-9.20	1.52 V	65	28.60	16.20
9	15810.00	61.20 PK	74.00	-12.80	1.47 V	46	38.90	22.30
10	15810.00	48.40 AV	54.00	-5.60	1.47 V	46	26.10	22.30

**REMARKS:**

1. Emission Level(dBuV/m) = Raw Value(dBuV) + Correction Factor(dB/m)
2. Correction Factor(dB/m) = Antenna Factor(dB/m) + Cable Factor(dB) – Pre-Amplifier Factor(dB)
3. The other emission levels were very low against the limit.
4. Margin value = Emission Level – Limit value
5. " \* ": Fundamental frequency.
6. " # ": The radiated frequency is out of the restricted band.

<b>CHANNEL</b>	TX Channel 62	<b>DETECTOR FUNCTION</b>	Peak (PK)
<b>FREQUENCY RANGE</b>	1GHz ~ 40GHz		Average (AV)

**ANTENNA POLARITY & TEST DISTANCE: HORIZONTAL AT 3 M**

NO.	FREQ. (MHz)	EMISSION LEVEL (dBuV/m)	LIMIT (dBuV/m)	MARGIN (dB)	ANTENNA HEIGHT (m)	TABLE ANGLE (Degree)	RAW VALUE (dBuV)	CORRECTION FACTOR (dB/m)
1	*5310.00	99.00 PK			1.59 H	320	88.40	10.60
2	*5310.00	88.70 AV			1.59 H	320	78.10	10.60
3	5350.00	69.60 PK	74.00	-4.40	1.59 H	320	59.00	10.60
4	5350.00	49.80 AV	54.00	-4.20	1.59 H	320	39.20	10.60
5	10620.00	57.90 PK	74.00	-16.10	1.51 H	214	41.70	16.20
6	10620.00	45.30 AV	54.00	-8.70	1.51 H	214	29.10	16.20
7	15930.00	61.60 PK	74.00	-12.40	1.57 H	281	38.80	22.80
8	15930.00	47.90 AV	54.00	-6.10	1.57 H	281	25.10	22.80

**ANTENNA POLARITY & TEST DISTANCE: VERTICAL AT 3 M**

NO.	FREQ. (MHz)	EMISSION LEVEL (dBuV/m)	LIMIT (dBuV/m)	MARGIN (dB)	ANTENNA HEIGHT (m)	TABLE ANGLE (Degree)	RAW VALUE (dBuV)	CORRECTION FACTOR (dB/m)
1	*5310.00	104.80 PK			1.66 V	21	94.20	10.60
2	*5310.00	94.20 AV			1.66 V	21	83.60	10.60
3	5350.00	73.10 PK	74.00	-0.90	1.66 V	21	62.50	10.60
4	<b>5350.00</b>	<b>53.20 AV</b>	<b>54.00</b>	<b>-0.80</b>	<b>1.66 V</b>	<b>21</b>	<b>42.60</b>	<b>10.60</b>
5	10620.00	58.00 PK	74.00	-16.00	1.53 V	42	41.80	16.20
6	10620.00	45.10 AV	54.00	-8.90	1.53 V	42	28.90	16.20
7	15930.00	61.60 PK	74.00	-12.40	1.46 V	37	38.80	22.80
8	15930.00	48.40 AV	54.00	-5.60	1.46 V	37	25.60	22.80

**REMARKS:**

1. Emission Level(dBuV/m) = Raw Value(dBuV) + Correction Factor(dB/m)
2. Correction Factor(dB/m) = Antenna Factor(dB/m) + Cable Factor(dB) – Pre-Amplifier Factor(dB)
3. The other emission levels were very low against the limit.
4. Margin value = Emission Level – Limit value
5. " \* ": Fundamental frequency.

<b>CHANNEL</b>	TX Channel 102	<b>DETECTOR FUNCTION</b>	Peak (PK)
<b>FREQUENCY RANGE</b>	1GHz ~ 40GHz		Average (AV)

**ANTENNA POLARITY & TEST DISTANCE: HORIZONTAL AT 3 M**

NO.	FREQ. (MHz)	EMISSION LEVEL (dBuV/m)	LIMIT (dBuV/m)	MARGIN (dB)	ANTENNA HEIGHT (m)	TABLE ANGLE (Degree)	RAW VALUE (dBuV)	CORRECTION FACTOR (dB/m)
1	#5470.00	65.10 PK	74.00	-8.90	1.56 H	342	54.00	11.10
2	#5470.00	43.40 AV	54.00	-10.60	1.56 H	342	32.30	11.10
3	*5510.00	97.20 PK			1.56 H	342	85.90	11.30
4	*5510.00	86.50 AV			1.56 H	342	75.20	11.30
5	11020.00	57.40 PK	74.00	-16.60	1.35 H	219	40.10	17.30
6	11020.00	44.40 AV	54.00	-9.60	1.35 H	219	27.10	17.30
7	#16530.00	61.40 PK	74.00	-12.60	1.60 H	299	36.50	24.90
8	#16530.00	48.60 AV	54.00	-5.40	1.60 H	299	23.70	24.90

**ANTENNA POLARITY & TEST DISTANCE: VERTICAL AT 3 M**

NO.	FREQ. (MHz)	EMISSION LEVEL (dBuV/m)	LIMIT (dBuV/m)	MARGIN (dB)	ANTENNA HEIGHT (m)	TABLE ANGLE (Degree)	RAW VALUE (dBuV)	CORRECTION FACTOR (dB/m)
1	#5470.00	68.80 PK	74.00	-5.20	1.66 V	21	57.70	11.10
2	#5470.00	46.10 AV	54.00	-7.90	1.66 V	21	35.00	11.10
3	*5510.00	102.60 PK			1.66 V	21	91.30	11.30
4	*5510.00	92.00 AV			1.66 V	21	80.70	11.30
5	11020.00	57.50 PK	74.00	-16.50	1.58 V	55	40.20	17.30
6	11020.00	44.90 AV	54.00	-9.10	1.58 V	55	27.60	17.30
7	#16530.00	61.80 PK	74.00	-12.20	1.48 V	63	36.90	24.90
8	#16530.00	48.70 AV	54.00	-5.30	1.48 V	63	23.80	24.90

**REMARKS:**

1. Emission Level(dBuV/m) = Raw Value(dBuV) + Correction Factor(dB/m)
2. Correction Factor(dB/m) = Antenna Factor(dB/m) + Cable Factor(dB) – Pre-Amplifier Factor(dB)
3. The other emission levels were very low against the limit.
4. Margin value = Emission Level – Limit value
5. " \* ": Fundamental frequency.
6. " # ": The radiated frequency is out of the restricted band.

<b>CHANNEL</b>	TX Channel 110	<b>DETECTOR FUNCTION</b>	Peak (PK)
<b>FREQUENCY RANGE</b>	1GHz ~ 40GHz		Average (AV)

**ANTENNA POLARITY & TEST DISTANCE: HORIZONTAL AT 3 M**

NO.	FREQ. (MHz)	EMISSION LEVEL (dBuV/m)	LIMIT (dBuV/m)	MARGIN (dB)	ANTENNA HEIGHT (m)	TABLE ANGLE (Degree)	RAW VALUE (dBuV)	CORRECTION FACTOR (dB/m)
1	#5470.00	56.30 PK	74.00	-17.70	1.55 H	319	45.20	11.10
2	#5470.00	42.60 AV	54.00	-11.40	1.55 H	319	31.50	11.10
3	*5550.00	98.10 PK			1.55 H	319	86.80	11.30
4	*5550.00	87.60 AV			1.55 H	319	76.30	11.30
5	11100.00	56.50 PK	74.00	-17.50	1.40 H	239	38.80	17.70
6	11100.00	43.70 AV	54.00	-10.30	1.40 H	239	26.00	17.70
7	#16650.00	61.90 PK	74.00	-12.10	1.57 H	270	36.70	25.20
8	#16650.00	49.10 AV	54.00	-4.90	1.57 H	270	23.90	25.20

**ANTENNA POLARITY & TEST DISTANCE: VERTICAL AT 3 M**

NO.	FREQ. (MHz)	EMISSION LEVEL (dBuV/m)	LIMIT (dBuV/m)	MARGIN (dB)	ANTENNA HEIGHT (m)	TABLE ANGLE (Degree)	RAW VALUE (dBuV)	CORRECTION FACTOR (dB/m)
1	#5470.00	58.50 PK	74.00	-15.50	1.63 V	19	47.40	11.10
2	#5470.00	43.80 AV	54.00	-10.20	1.63 V	19	32.70	11.10
3	*5550.00	103.50 PK			1.63 V	19	92.20	11.30
4	*5550.00	93.00 AV			1.63 V	19	81.70	11.30
5	11100.00	57.40 PK	74.00	-16.60	1.50 V	36	39.70	17.70
6	11100.00	44.80 AV	54.00	-9.20	1.50 V	36	27.10	17.70
7	#16650.00	61.30 PK	74.00	-12.70	1.53 V	59	36.10	25.20
8	#16650.00	48.50 AV	54.00	-5.50	1.53 V	59	23.30	25.20

**REMARKS:**

1. Emission Level(dBuV/m) = Raw Value(dBuV) + Correction Factor(dB/m)
2. Correction Factor(dB/m) = Antenna Factor(dB/m) + Cable Factor(dB) – Pre-Amplifier Factor(dB)
3. The other emission levels were very low against the limit.
4. Margin value = Emission Level – Limit value
5. " \* ": Fundamental frequency.
6. " # ": The radiated frequency is out of the restricted band.

<b>CHANNEL</b>	TX Channel 134	<b>DETECTOR FUNCTION</b>	Peak (PK)
<b>FREQUENCY RANGE</b>	1GHz ~ 40GHz		Average (AV)

**ANTENNA POLARITY & TEST DISTANCE: HORIZONTAL AT 3 M**

NO.	FREQ. (MHz)	EMISSION LEVEL (dBuV/m)	LIMIT (dBuV/m)	MARGIN (dB)	ANTENNA HEIGHT (m)	TABLE ANGLE (Degree)	RAW VALUE (dBuV)	CORRECTION FACTOR (dB/m)
1	*5670.00	98.70 PK			1.59 H	325	87.30	11.40
2	*5670.00	87.00 AV			1.59 H	325	75.60	11.40
3	#5725.00	56.10 PK	74.00	-17.90	1.59 H	325	44.60	11.50
4	#5725.00	42.30 AV	54.00	-11.70	1.59 H	325	30.80	11.50
5	11340.00	56.60 PK	74.00	-17.40	1.37 H	232	39.10	17.50
6	11340.00	43.50 AV	54.00	-10.50	1.37 H	232	26.00	17.50
7	#17010.00	61.60 PK	74.00	-12.40	1.59 H	295	34.90	26.70
8	#17010.00	48.90 AV	54.00	-5.10	1.59 H	295	22.20	26.70

**ANTENNA POLARITY & TEST DISTANCE: VERTICAL AT 3 M**

NO.	FREQ. (MHz)	EMISSION LEVEL (dBuV/m)	LIMIT (dBuV/m)	MARGIN (dB)	ANTENNA HEIGHT (m)	TABLE ANGLE (Degree)	RAW VALUE (dBuV)	CORRECTION FACTOR (dB/m)
1	*5670.00	103.00 PK			1.63 V	21	91.60	11.40
2	*5670.00	92.30 AV			1.63 V	21	80.90	11.40
3	#5725.00	58.10 PK	74.00	-15.90	1.63 V	21	46.60	11.50
4	#5725.00	44.80 AV	54.00	-9.20	1.63 V	21	33.30	11.50
5	11340.00	57.80 PK	74.00	-16.20	1.49 V	41	40.30	17.50
6	11340.00	45.20 AV	54.00	-8.80	1.49 V	41	27.70	17.50
7	#17010.00	61.50 PK	74.00	-12.50	1.52 V	47	34.80	26.70
8	#17010.00	48.70 AV	54.00	-5.30	1.52 V	47	22.00	26.70

**REMARKS:**

1. Emission Level(dBuV/m) = Raw Value(dBuV) + Correction Factor(dB/m)
2. Correction Factor(dB/m) = Antenna Factor(dB/m) + Cable Factor(dB) – Pre-Amplifier Factor(dB)
3. The other emission levels were very low against the limit.
4. Margin value = Emission Level – Limit value
5. " \* ": Fundamental frequency.
6. " # ": The radiated frequency is out of the restricted band.

<b>CHANNEL</b>	TX Channel 151	<b>DETECTOR FUNCTION</b>	Peak (PK)
<b>FREQUENCY RANGE</b>	1GHz ~ 40GHz		Average (AV)

**ANTENNA POLARITY & TEST DISTANCE: HORIZONTAL AT 3 M**

NO.	FREQ. (MHz)	EMISSION LEVEL (dBuV/m)	LIMIT (dBuV/m)	MARGIN (dB)	ANTENNA HEIGHT (m)	TABLE ANGLE (Degree)	RAW VALUE (dBuV)	CORRECTION FACTOR (dB/m)
1	*5755.00	96.70 PK			1.54 H	328	85.00	11.70
2	*5755.00	85.30 AV			1.54 H	328	73.60	11.70
3	11510.00	56.10 PK	74.00	-17.90	1.40 H	211	38.20	17.90
4	11510.00	43.40 AV	54.00	-10.60	1.40 H	211	25.50	17.90
5	#17265.00	62.20 PK	74.00	-11.80	1.54 H	289	34.90	27.30
6	#17265.00	49.30 AV	54.00	-4.70	1.54 H	289	22.00	27.30

**ANTENNA POLARITY & TEST DISTANCE: VERTICAL AT 3 M**

NO.	FREQ. (MHz)	EMISSION LEVEL (dBuV/m)	LIMIT (dBuV/m)	MARGIN (dB)	ANTENNA HEIGHT (m)	TABLE ANGLE (Degree)	RAW VALUE (dBuV)	CORRECTION FACTOR (dB/m)
1	*5755.00	102.50 PK			2.00 V	16	90.80	11.70
2	*5755.00	91.20 AV			2.00 V	16	79.50	11.70
3	11510.00	57.30 PK	74.00	-16.70	1.48 V	64	39.40	17.90
4	11510.00	44.40 AV	54.00	-9.60	1.48 V	64	26.50	17.90
5	#17265.00	62.40 PK	74.00	-11.60	1.51 V	45	35.10	27.30
6	#17265.00	49.20 AV	54.00	-4.80	1.51 V	45	21.90	27.30

**REMARKS:**

1. Emission Level(dBuV/m) = Raw Value(dBuV) + Correction Factor(dB/m)
2. Correction Factor(dB/m) = Antenna Factor(dB/m) + Cable Factor(dB) – Pre-Amplifier Factor(dB)
3. The other emission levels were very low against the limit.
4. Margin value = Emission Level – Limit value
5. " \* ": Fundamental frequency.
6. " # ": The radiated frequency is out of the restricted band.

<b>CHANNEL</b>	TX Channel 159	<b>DETECTOR FUNCTION</b>	Peak (PK)
<b>FREQUENCY RANGE</b>	1GHz ~ 40GHz		Average (AV)

**ANTENNA POLARITY & TEST DISTANCE: HORIZONTAL AT 3 M**

NO.	FREQ. (MHz)	EMISSION LEVEL (dBuV/m)	LIMIT (dBuV/m)	MARGIN (dB)	ANTENNA HEIGHT (m)	TABLE ANGLE (Degree)	RAW VALUE (dBuV)	CORRECTION FACTOR (dB/m)
1	*5795.00	97.00 PK			1.54 H	327	85.10	11.90
2	*5795.00	85.60 AV			1.54 H	327	73.70	11.90
3	11590.00	57.20 PK	74.00	-16.80	1.34 H	232	39.20	18.00
4	11590.00	44.10 AV	54.00	-9.90	1.34 H	232	26.10	18.00
5	#17385.00	62.60 PK	74.00	-11.40	1.55 H	289	35.20	27.40
6	#17385.00	49.80 AV	54.00	-4.20	1.55 H	289	22.40	27.40

**ANTENNA POLARITY & TEST DISTANCE: VERTICAL AT 3 M**

NO.	FREQ. (MHz)	EMISSION LEVEL (dBuV/m)	LIMIT (dBuV/m)	MARGIN (dB)	ANTENNA HEIGHT (m)	TABLE ANGLE (Degree)	RAW VALUE (dBuV)	CORRECTION FACTOR (dB/m)
1	*5795.00	102.80 PK			2.00 V	17	90.90	11.90
2	*5795.00	91.50 AV			2.00 V	17	79.60	11.90
3	11590.00	57.30 PK	74.00	-16.70	1.50 V	51	39.30	18.00
4	11590.00	44.80 AV	54.00	-9.20	1.50 V	51	26.80	18.00
5	#17385.00	62.00 PK	74.00	-12.00	1.46 V	61	34.60	27.40
6	#17385.00	49.20 AV	54.00	-4.80	1.46 V	61	21.80	27.40

**REMARKS:**

1. Emission Level(dBuV/m) = Raw Value(dBuV) + Correction Factor(dB/m)
2. Correction Factor(dB/m) = Antenna Factor(dB/m) + Cable Factor(dB) – Pre-Amplifier Factor(dB)
3. The other emission levels were very low against the limit.
4. Margin value = Emission Level – Limit value
5. " \* ": Fundamental frequency.
6. " # ": The radiated frequency is out of the restricted band.

**BELOW 1GHz DATA**
**802.11n (HT40)**

<b>CHANNEL</b>	TX Channel 54	<b>DETECTOR FUNCTION</b>	Quasi-Peak (QP)
<b>FREQUENCY RANGE</b>	Below 1GHz		

**ANTENNA POLARITY & TEST DISTANCE: HORIZONTAL AT 3 M**

NO.	FREQ. (MHz)	EMISSION LEVEL (dBuV/m)	LIMIT (dBuV/m)	MARGIN (dB)	ANTENNA HEIGHT (m)	TABLE ANGLE (Degree)	RAW VALUE (dBuV)	CORRECTION FACTOR (dB/m)
1	448.02	40.30 QP	46.00	-5.70	1.00 H	123	42.70	-2.40
2	464.03	42.40 QP	46.00	-3.60	1.00 H	117	44.50	-2.10
3	544.03	40.80 QP	46.00	-5.20	1.50 H	238	41.40	-0.60
4	560.03	40.40 QP	46.00	-5.60	1.50 H	247	40.70	-0.30
5	640.03	41.30 QP	46.00	-4.70	1.50 H	360	39.50	1.80
6	680.02	41.20 QP	46.00	-4.80	2.00 H	321	39.00	2.20

**ANTENNA POLARITY & TEST DISTANCE: VERTICAL AT 3 M**

NO.	FREQ. (MHz)	EMISSION LEVEL (dBuV/m)	LIMIT (dBuV/m)	MARGIN (dB)	ANTENNA HEIGHT (m)	TABLE ANGLE (Degree)	RAW VALUE (dBuV)	CORRECTION FACTOR (dB/m)
1	125.01	39.70 QP	43.50	-3.80	2.50 V	0	49.30	-9.60
2	448.02	41.00 QP	46.00	-5.00	1.00 V	333	43.40	-2.40
3	512.02	40.80 QP	46.00	-5.20	1.00 V	319	42.00	-1.20
4	544.03	42.80 QP	46.00	-3.20	1.00 V	360	43.40	-0.60
5	560.03	40.50 QP	46.00	-5.50	1.00 V	335	40.80	-0.30
6	640.03	40.20 QP	46.00	-5.80	1.00 V	154	38.40	1.80
7	680.05	41.20 QP	46.00	-4.80	1.50 V	0	39.00	2.20
8	726.02	40.80 QP	46.00	-5.20	1.50 V	0	38.00	2.80

**REMARKS:**

1. Emission Level(dBuV/m) = Raw Value(dBuV) + Correction Factor(dB/m)
2. Correction Factor(dB/m) = Antenna Factor(dB/m) + Cable Factor(dB) – Pre-Amplifier Factor(dB)
3. The other emission levels were very low against the limit.
4. Margin value = Emission Level – Limit value



## 4.2 Conducted Emission Measurement

### 4.2.1 Limits of Conducted Emission Measurement

Frequency (MHz)	Conducted Limit (dBuV)	
	Quasi-peak	Average
0.15 - 0.5	66 - 56	56 - 46
0.50 - 5.0	56	46
5.0 - 30.0	60	50

Note: 1. The lower limit shall apply at the transition frequencies.

2. The limit decreases in line with the logarithm of the frequency in the range of 0.15 to 0.50MHz.

### 4.2.2 Test Instruments

DESCRIPTION & MANUFACTURER	MODEL NO.	SERIAL NO.	CALIBRATED DATE	CALIBRATED UNTIL
Test Receiver R&S	ESCS 30	100375	May 09, 2016	May 08, 2017
Line-Impedance Stabilization Network (for EUT) SCHWARZBECK	NSLK-8127	8127-522	Sep. 01, 2015	Aug. 31, 2016
Line-Impedance Stabilization Network (for Peripheral ) R&S	ENV216	100072	June 11, 2015	June 10, 2016
RF Cable	5D-FB	COCCAB-001	Mar. 08, 2016	Mar. 07, 2017
10 dB PAD Mini-Circuits	HAT-10+	CONATT-002	Sep. 14, 2015	Sep. 13, 2016
50 ohms Terminator	N/A	EMC-03	Sep. 23, 2015	Sep. 22, 2016
50 ohms Terminator	N/A	EMC-02	Oct. 01, 2015	Sep. 30, 2016
50 ohms Terminator	E1-011315	13	Dec. 11 2015	Dec. 10 2016
Software BVADT	BVADT_Cond_ V7.3.7.3	NA	NA	NA

#### Note:

1. The calibration interval of the above test instruments are 12 months and the calibrations are traceable to NML/ROC and NIST/USA.
2. The test was performed in Shielded Room No. C.
3. The VCCI Con C Registration No. is C-3611.
4. Tested Date: May 26 to June 06, 2016

#### 4.2.3 Test Procedure

- The EUT was placed 0.4 meters from the conducting wall of the shielded room with EUT being connected to the power mains through a line impedance stabilization network (LISN). Other support units were connected to the power mains through another LISN. The two LISNs provide 50 ohm/ 50uH of coupling impedance for the measuring instrument.
- Both lines of the power mains connected to the EUT were checked for maximum conducted interference.
- The frequency range from 150kHz to 30MHz was searched. Emission levels under (Limit - 20dB) was not recorded.

**NOTE:** All modes of operation were investigated and the worst-case emissions are reported.

#### 4.2.4 Deviation from Test Standard

No deviation.

#### 4.2.5 Test Setup

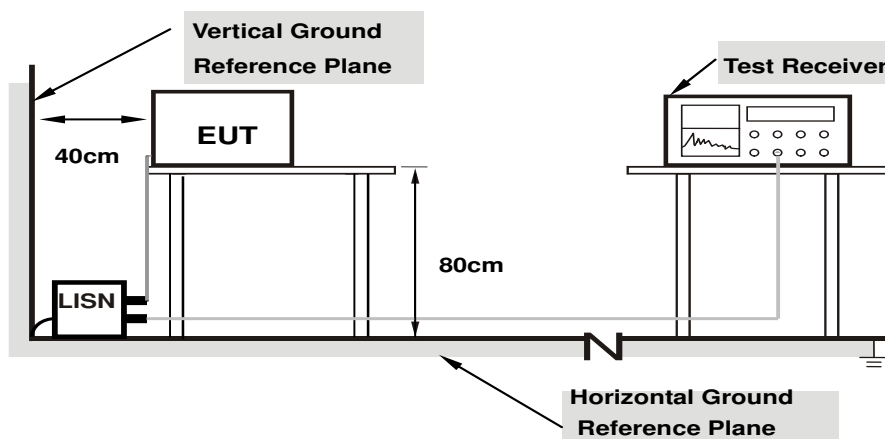

**Note: 1.** Support units were connected to second LISN.

For the actual test configuration, please refer to the attached file (Test Setup Photo).

#### 4.2.6 EUT Operating Condition

Same as 4.1.6.

#### 4.2.7 Test Results (Mode 1)

Phase	Line (L)	Detector Function	Quasi-Peak (QP) / Average (AV)
-------	----------	-------------------	--------------------------------

No	Freq. [MHz]	Corr.	Reading Value		Emission Level		Limit		Margin	
		Factor (dB)	[dB (uV)]		[dB (uV)]		[dB (uV)]		(dB)	
			Q.P.	AV.	Q.P.	AV.	Q.P.	AV.	Q.P.	AV.
1	0.15000	10.32	36.41	22.78	46.73	33.10	66.00	56.00	-19.27	-22.90
2	0.43516	10.30	39.02	32.97	49.32	43.27	57.15	47.15	-7.83	-3.88
3	0.86875	10.25	24.65	20.35	34.90	30.60	56.00	46.00	-21.10	-15.40
4	1.66797	10.25	18.91	13.22	29.16	23.47	56.00	46.00	-26.84	-22.53
5	14.26563	10.75	21.52	16.01	32.27	26.76	60.00	50.00	-27.73	-23.24
6	20.80859	10.97	28.73	26.85	39.70	37.82	60.00	50.00	-20.30	-12.18

#### REMARKS:

1. Q.P. and AV. are abbreviations of quasi-peak and average individually.
2. The emission levels of other frequencies were very low against the limit.
3. Margin value = Emission level - Limit value
4. Correction factor = Insertion loss + Cable loss
5. Emission Level = Correction Factor + Reading Value.

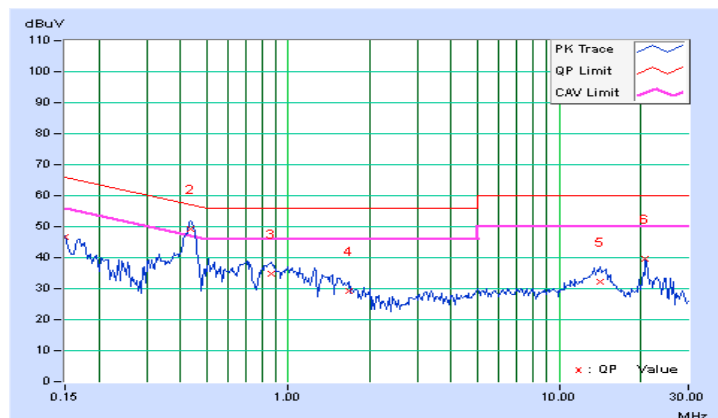

Phase	Neutral (N)	Detector Function	Quasi-Peak (QP) / Average (AV)
-------	-------------	-------------------	--------------------------------

No	Freq. [MHz]	Corr. Factor	Reading Value [dB (uV)]		Emission Level [dB (uV)]		Limit [dB (uV)]		Margin (dB)	
		(dB)	Q.P.	AV.	Q.P.	AV.	Q.P.	AV.	Q.P.	AV.
	1	0.15000	10.30	37.89	23.12	48.19	33.42	66.00	56.00	-17.81
<b>2</b>	<b>0.43906</b>	<b>10.28</b>	<b>39.93</b>	<b>33.52</b>	<b>50.21</b>	<b>43.80</b>	<b>57.08</b>	<b>47.08</b>	<b>-6.87</b>	<b>-3.28</b>
3	0.69297	10.25	24.55	19.63	34.80	29.88	56.00	46.00	-21.20	-16.12
4	0.84922	10.24	24.61	20.07	34.85	30.31	56.00	46.00	-21.15	-15.69
5	1.77344	10.25	22.06	17.56	32.31	27.81	56.00	46.00	-23.69	-18.19
6	20.80859	11.00	26.81	24.74	37.81	35.74	60.00	50.00	-22.19	-14.26

#### REMARKS:

1. Q.P. and AV. are abbreviations of quasi-peak and average individually.
2. The emission levels of other frequencies were very low against the limit.
3. Margin value = Emission level - Limit value
4. Correction factor = Insertion loss + Cable loss
5. Emission Level = Correction Factor + Reading Value.

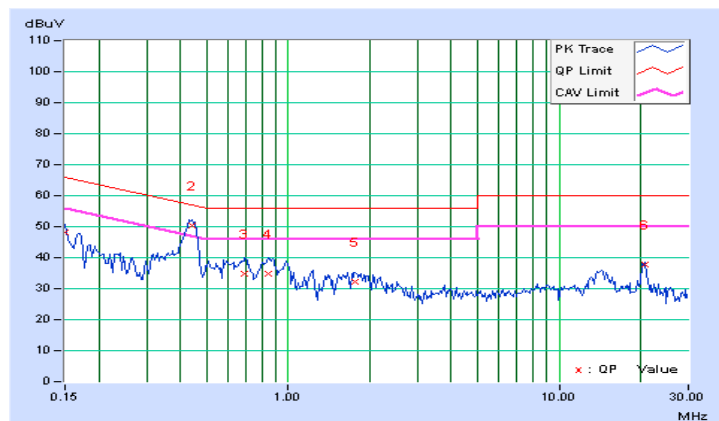

#### 4.2.8 Test Results (Mode 2)

Phase	Line (L)	Detector Function	Quasi-Peak (QP) / Average (AV)
-------	----------	-------------------	--------------------------------

No	Freq. [MHz]	Corr. Factor	Reading Value [dB (uV)]		Emission Level [dB (uV)]		Limit [dB (uV)]		Margin (dB)	
		(dB)	Q.P.	AV.	Q.P.	AV.	Q.P.	AV.	Q.P.	AV.
	1	0.43516	10.30	37.24	32.27	47.54	42.57	57.15	47.15	-9.61
2	0.47031	10.29	36.17	31.01	46.46	41.30	56.51	46.51	-10.05	-5.21
3	0.79844	10.25	24.99	19.66	35.24	29.91	56.00	46.00	-20.76	-16.09
4	0.97813	10.23	25.27	20.15	35.50	30.38	56.00	46.00	-20.50	-15.62
5	3.76172	10.41	25.34	12.03	35.75	22.44	56.00	46.00	-20.25	-23.56
6	15.26953	10.80	26.34	12.16	37.14	22.96	60.00	50.00	-22.86	-27.04

#### REMARKS:

1. Q.P. and AV. are abbreviations of quasi-peak and average individually.
2. The emission levels of other frequencies were very low against the limit.
3. Margin value = Emission level - Limit value
4. Correction factor = Insertion loss + Cable loss
5. Emission Level = Correction Factor + Reading Value.

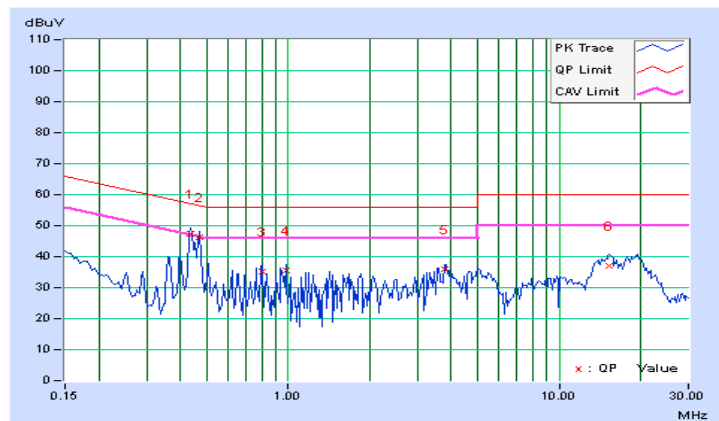

Phase	Neutral (N)	Detector Function	Quasi-Peak (QP) / Average (AV)
-------	-------------	-------------------	--------------------------------

No	Freq. [MHz]	Corr. Factor	Reading Value [dB (uV)]		Emission Level [dB (uV)]		Limit [dB (uV)]		Margin (dB)	
		(dB)	Q.P.	AV.	Q.P.	AV.	Q.P.	AV.	Q.P.	AV.
	1	0.43516	10.28	37.00	32.20	47.28	42.48	57.15	47.15	-9.87
2	0.47031	10.27	36.98	31.95	47.25	42.22	56.51	46.51	-9.26	-4.29
3	0.79844	10.24	28.11	22.22	38.35	32.46	56.00	46.00	-17.65	-13.54
4	0.97813	10.22	28.13	22.80	38.35	33.02	56.00	46.00	-17.65	-12.98
5	1.19531	10.23	27.33	22.02	37.56	32.25	56.00	46.00	-18.44	-13.75
6	1.62891	10.25	26.33	20.78	36.58	31.03	56.00	46.00	-19.42	-14.97

#### REMARKS:

1. Q.P. and AV. are abbreviations of quasi-peak and average individually.
2. The emission levels of other frequencies were very low against the limit.
3. Margin value = Emission level - Limit value
4. Correction factor = Insertion loss + Cable loss
5. Emission Level = Correction Factor + Reading Value.

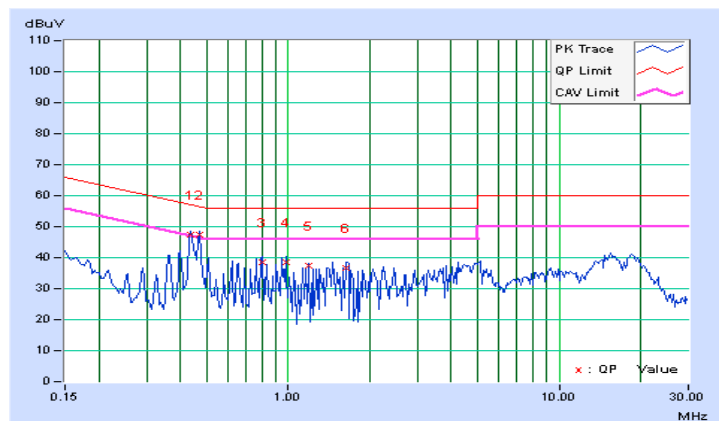

### 4.3 Transmit Power Measurement

#### 4.3.1 Limits of Transmit Power Measurement

Operation Band	EUT Category		Limit
U-NII-1		Outdoor Access Point	1 Watt (30 dBm) (Max. e.i.r.p $\leq$ 125mW(21 dBm) at any elevation angle above 30 degrees as measured from the horizon)
		Fixed point-to-point Access Point	1 Watt (30 dBm)
		Indoor Access Point	1 Watt (30 dBm)
	√	Mobile and Portable client device	250mW (24 dBm)
U-NII-2A		√	250mW (24 dBm) or 11 dBm+10 log B*
U-NII-2C		√	250mW (24 dBm) or 11 dBm+10 log B*
U-NII-3		√	1 Watt (30 dBm)

\*B is the 26 dB emission bandwidth in megahertz

#### 4.3.2 Test Setup

##### FOR POWER OUTPUT MEASUREMENT

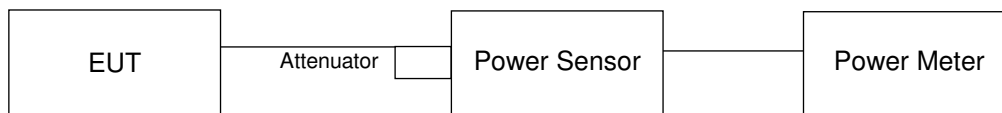

##### FOR 26dB OCCUPIED BANDWIDTH

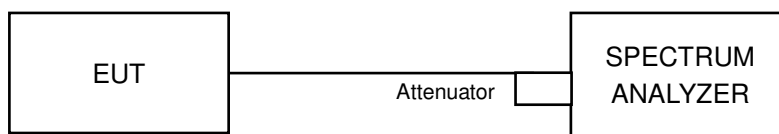

#### 4.3.3 Test Instruments

Refer to section 4.1.2 to get information of above instrument.

#### 4.3.4 Test Procedure

##### **FOR POWER OUTPUT MEASUREMENT**

Method PM is used to perform output power measurement, trigger and gating function of wide band power meter is enabled to measure max output power of TX on burst. Duty factor is not added to measured value.

##### **FOR 26dB OCCUPIED BANDWIDTH**

1. Set RBW = approximately 1% of the emission bandwidth.
2. Set the VBW > RBW.
3. Detector = Peak.
4. Trace mode = max hold.
5. Measure the maximum width of the emission that is 26 dB down from the peak of the emission. Compare this with the RBW setting of the analyzer. Readjust RBW and repeat measurement as needed until the RBW/EBW ratio is approximately 1%.

#### 4.3.5 Deviation from Test Standard

No deviation.

#### 4.3.6 EUT Operating Condition

The software provided by client to enable the EUT under transmission condition continuously at lowest, middle and highest channel frequencies individually.



#### 4.3.7 Test Result

#### Power Output:

#### 802.11a

Chan.	Chan. Freq. (MHz)	Average Power (mW)	Average Power (dBm)	Limit (dBm)	Pass / Fail
36	5180	10.864	10.36	24	Pass
40	5200	10.789	10.33	24	Pass
48	5240	10.209	10.09	24	Pass
52	5260	10.495	10.21	24	Pass
60	5300	9.795	9.91	24	Pass
64	5320	9.638	9.84	24	Pass
100	5500	7.295	8.63	24	Pass
120	5600	6.966	8.43	24	Pass
140	5700	7.096	8.51	24	Pass
149	5745	7.345	8.66	30	Pass
157	5785	7.194	8.57	30	Pass
165	5825	6.934	8.41	30	Pass

## 26dB OCCUPIED BANDWIDTH

Channel	Frequency (MHz)	26dB Bandwidth (MHz)
52	5260	21.24
60	5300	21.57
64	5320	22.31
100	5500	20.40
116	5580	20.23
140	5700	20.20

**Note: For U-NII-2A, U-NII-2C Band output power limitation is determined based on 26dBc bandwidth**

Power Limit = 11dBm + 10logB < U-NII-2A, U-NII-2C >			
Channel Number	Freq.(MHz)	Min. B(MHz)	Determined Conducted Limit (dBm)
52	5260	21.24	24.27 < 24
60	5300	21.57	24.33 < 24
64	5320	22.31	24.48 < 24
100	5500	20.40	24.09 < 24
116	5580	20.23	24.05 < 24
140	5700	20.20	24.05 < 24

**802.11n (HT20)**

Chan.	Chan. Freq. (MHz)	Average Power (mW)	Average Power (dBm)	Limit (dBm)	Pass / Fail
36	5180	10.666	10.28	24	Pass
40	5200	10.233	10.10	24	Pass
48	5240	10.28	10.12	24	Pass
52	5260	10.544	10.23	24	Pass
60	5300	10.023	10.01	24	Pass
64	5320	9.705	9.87	24	Pass
100	5500	7.586	8.80	24	Pass
120	5600	6.855	8.36	24	Pass
140	5700	6.918	8.40	24	Pass
149	5745	7.145	8.54	30	Pass
157	5785	7.194	8.57	30	Pass
165	5825	7.295	8.63	30	Pass

### 26dB OCCUPIED BANDWIDTH

Channel	Frequency (MHz)	26dB Bandwidth (MHz)
52	5260	23.29
60	5300	24.73
64	5320	23.80
100	5500	21.54
116	5580	21.28
140	5700	21.31

**Note: For U-NII-2A, U-NII-2C Band output power limitation is determined based on 26dBc bandwidth**

Power Limit = 11dBm + 10logB < U-NII-2A, U-NII-2C >			
Channel Number	Freq.(MHz)	Min. B(MHz)	Determined Conducted Limit (dBm)
52	5260	23.29	24.67 > 24
60	5300	24.73	24.93 > 24
64	5320	23.80	24.76 > 24
100	5500	21.54	24.33 > 24
116	5580	21.28	24.27 > 24
140	5700	21.31	24.28 > 24

**802.11n (HT40)**

Chan.	Chan. Freq. (MHz)	Average Power (mW)	Average Power (dBm)	Limit (dBm)	Pass / Fail
38	5190	11.298	10.53	24	Pass
46	5230	11.324	10.54	24	Pass
54	5270	11.429	10.58	24	Pass
62	5310	10.839	10.35	24	Pass
102	5510	7.362	8.67	24	Pass
110	5550	7.925	8.99	24	Pass
134	5670	7.499	8.75	24	Pass
151	5755	7.396	8.69	30	Pass
159	5795	7.709	8.87	30	Pass

### 26dB OCCUPIED BANDWIDTH

Channel	Frequency (MHz)	26dB Bandwidth (MHz)
54	5270	53.92
62	5310	49.97
102	5510	50.78
110	5550	51.24
134	5670	51.04

**Note: For U-NII-2A, U-NII-2C Band output power limitation is determined based on 26dBc bandwidth**

Power Limit = 11dBm + 10logB < U-NII-2A, U-NII-2C >			
Channel Number	Freq.(MHz)	Min. B(MHz)	Determined Conducted Limit (dBm)
54	5270	53.92	28.31 > 24
62	5310	49.97	27.98 > 24
102	5510	50.78	28.05 > 24
110	5550	51.24	28.09 > 24
134	5670	51.04	28.07 > 24

### Spectrum Plot of Worst Value

#### 802.11a\_CH140

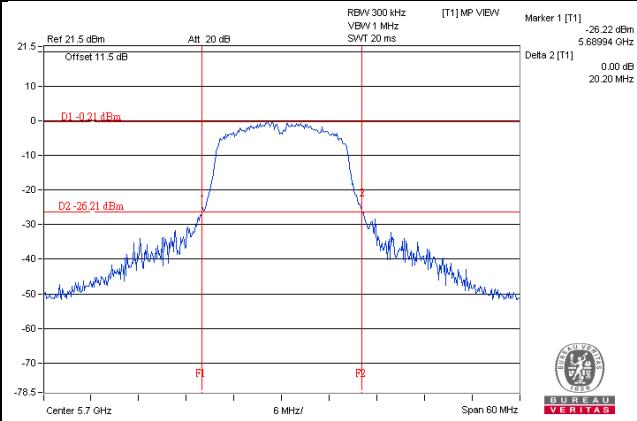

#### 802.11n (HT20)\_CH116

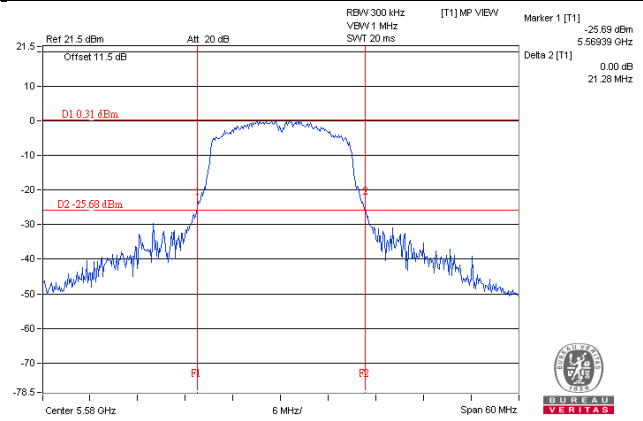

#### 802.11n (HT40)\_CH62

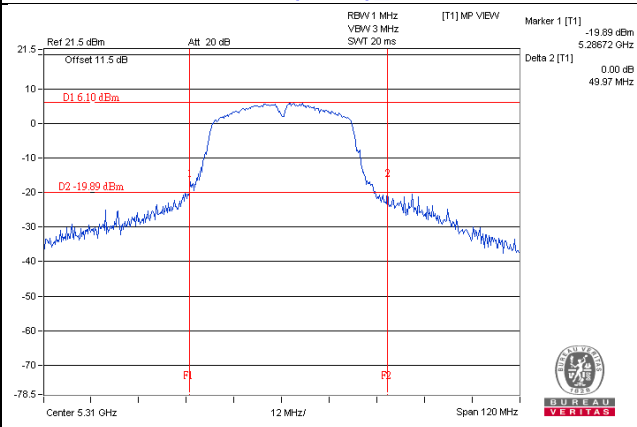

## 4.4 Peak Power Spectral Density Measurement

### 4.4.1 Limits of Peak Power Spectral Density Measurement

Operation Band	EUT Category		Limit
U-NII-1		Outdoor Access Point	17dBm/ MHz
		Fixed point-to-point Access Point	
		Indoor Access Point	
	√	Mobile and Portable client device	11dBm/ MHz
U-NII-2A		√	11dBm/ MHz
U-NII-2C		√	11dBm/ MHz
U-NII-3		√	30dBm/ 500kHz

### 4.4.2 Test Setup

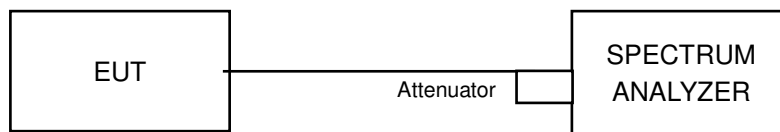

### 4.4.3 Test Instruments

Refer to section 4.1.2 to get information of above instrument.

### 4.4.4 Test Procedure

#### For U-NII-1, U-NII-2A & U-NII-2C:

Using method SA-2

1. Set span to encompass the entire emission bandwidth (EBW) of the signal.
2. Set RBW = 1 MHz, Set VBW ≥ 3 MHz, Detector = RMS
3. Sweep time = auto, trigger set to "free run".
4. Trace average at least 100 traces in power averaging mode.
5. Record the max value and add 10 log (1/duty cycle)

#### For U-NII-3:

1. Set span to encompass the entire emission bandwidth (EBW) of the signal.
2. Set RBW = 300 kHz, Set VBW ≥ 1 MHz, Detector = RMS
3. Use the peak marker function to determine the maximum power level in any 300 kHz band segment within the fundamental EBW.
4. Scale the observed power level to an equivalent value in 500 kHz by adjusting (reducing) the measured power by a bandwidth correction factor (BWCF) where  $BWCF = 10\log(500\text{ kHz}/300\text{kHz})$
5. Sweep time = auto, trigger set to "free run".
6. Trace average at least 100 traces in power averaging mode.
7. Record the max value and add 10 log (1/duty cycle)



#### 4.4.5 Deviation from Test Standard

No deviation.

#### 4.4.6 EUT Operating Condition

Same as Item 4.3.6.

#### 4.4.7 Test Results

##### For U-NII-1, U-NII-2A, U-NII-2C Band 802.11a

Chan.	Chan. Freq. (MHz)	Conducted PSD W/O Duty Factor (dBm/MHz)	Duty Factor (dB)	PSD With Duty Factor (dBm/MHz)	MAX. EIRP Limit (dBm/MHz)	Pass / Fail
36	5180	-3.47	0.5	-2.97	11	Pass
40	5200	-2.92	0.5	-2.42	11	Pass
48	5240	-2.61	0.5	-2.11	11	Pass
52	5260	-2.79	0.5	-2.29	11	Pass
60	5300	-2.50	0.5	-2.00	11	Pass
64	5320	-2.04	0.5	-1.54	11	Pass
100	5500	-4.61	0.5	-4.11	11	Pass
120	5600	-5.13	0.5	-4.63	11	Pass
140	5700	-5.80	0.5	-5.30	11	Pass

**Note:** 1. Refer to section 3.3 for duty cycle spectrum plot.

##### 802.11n (HT20)

Chan.	Chan. Freq. (MHz)	Conducted PSD W/O Duty Factor (dBm/MHz)	Duty Factor (dB)	PSD With Duty Factor (dBm/MHz)	MAX. EIRP Limit (dBm/MHz)	Pass / Fail
36	5180	-3.25	0.54	-2.71	11	Pass
40	5200	-2.72	0.54	-2.18	11	Pass
48	5240	-2.86	0.54	-2.32	11	Pass
52	5260	-2.58	0.54	-2.04	11	Pass
60	5300	-3.14	0.54	-2.60	11	Pass
64	5320	-3.25	0.54	-2.71	11	Pass
100	5500	-5.17	0.54	-4.63	11	Pass
120	5600	-5.02	0.54	-4.48	11	Pass
140	5700	-5.93	0.54	-5.39	11	Pass

**Note:** 1. Refer to section 3.3 for duty cycle spectrum plot.

**802.11n (HT40)**

Chan.	Chan. Freq. (MHz)	Conducted PSD W/O Duty Factor (dBm/MHz)	Duty Factor (dB)	PSD With Duty Factor (dBm/MHz)	MAX. EIRP Limit (dBm/MHz)	Pass / Fail
38	5190	-9.50	1.02	-8.48	11	Pass
46	5230	-6.48	1.02	-5.46	11	Pass
54	5270	-8.17	1.02	-7.15	11	Pass
62	5310	-7.19	1.02	-6.17	11	Pass
102	5510	-9.49	1.02	-8.46	11	Pass
110	5550	-9.30	1.02	-8.27	11	Pass
134	5670	-9.74	1.02	-8.71	11	Pass

**Note:** 1. Refer to section 3.3 for duty cycle spectrum plot.

### Spectrum Plot of Worst Value

**802.11a\_CH64**

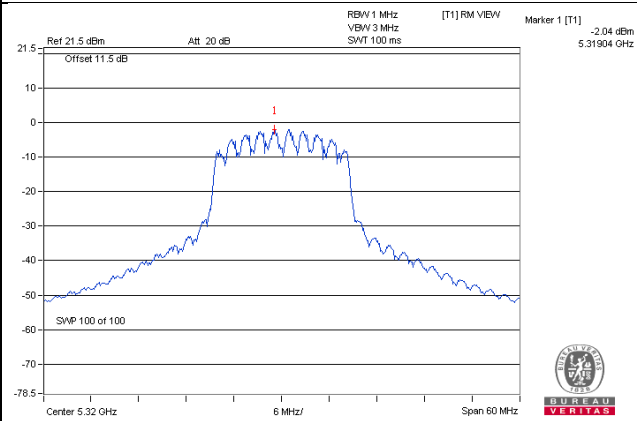

**802.11n (HT20)\_CH52**

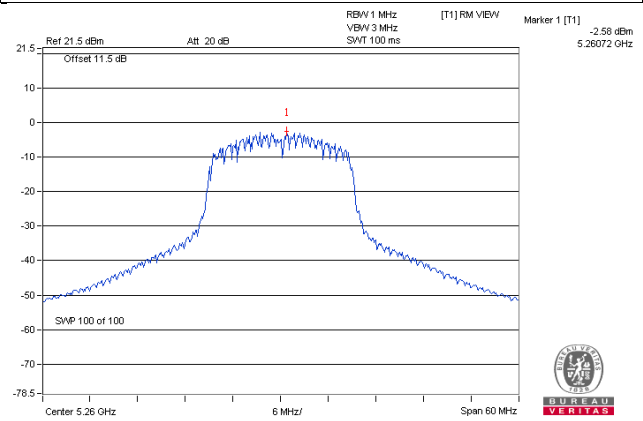

**802.11n (HT40)\_CH46**

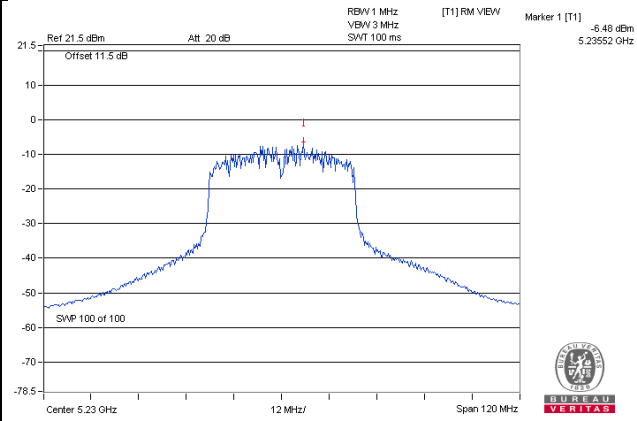

### For U-NII-3 Band

#### 802.11a

Chan.	Chan. Freq. (MHz)	PSD W/O Duty Factor		Duty Factor (dB)	Total PSD With Duty Factor (dBm/500kHz)	Limit (dBm/500kHz)	Pass /Fail
		(dBm/300kHz)	(dBm/500kHz)				
149	5745	-14.32	-12.10	0.5	-11.60	30	Pass
157	5785	-13.98	-11.76	0.5	-11.26	30	Pass
165	5825	-13.54	-11.32	0.5	-10.82	30	Pass

**Note:** 1. Refer to section 3.3 for duty cycle spectrum plot.

#### 802.11n (HT20)

Chan.	Chan. Freq. (MHz)	PSD W/O Duty Factor		Duty Factor (dB)	Total PSD With Duty Factor (dBm/500kHz)	Limit (dBm/500kHz)	Pass /Fail
		(dBm/300kHz)	(dBm/500kHz)				
149	5745	-14.54	-12.32	0.54	-11.78	30	Pass
157	5785	-13.62	-11.40	0.54	-10.86	30	Pass
165	5825	-13.59	-11.37	0.54	-10.83	30	Pass

**Note:** 1. Refer to section 3.3 for duty cycle spectrum plot.

#### 802.11n (HT40)

Chan.	Chan. Freq. (MHz)	PSD W/O Duty Factor		Duty Factor (dB)	Total PSD With Duty Factor (dBm/500kHz)	Limit (dBm/500kHz)	Pass /Fail
		(dBm/300kHz)	(dBm/500kHz)				
151	5755	-17.45	-15.23	1.02	-14.21	30	Pass
159	5795	-18.88	-16.66	1.02	-15.64	30	Pass

**Note:** 1. Refer to section 3.3 for duty cycle spectrum plot.

### Spectrum Plot of Worst Value

#### 802.11a\_CH165

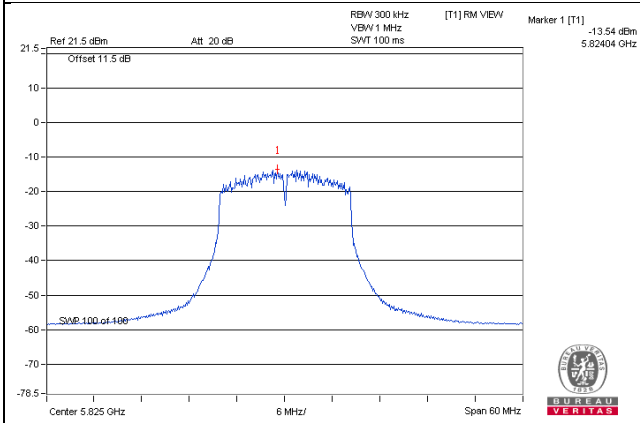

#### 802.11n (HT20)\_CH165

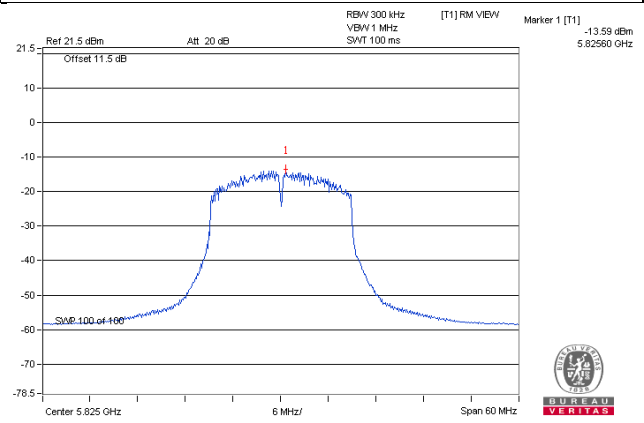

#### 802.11n (HT40)\_CH151

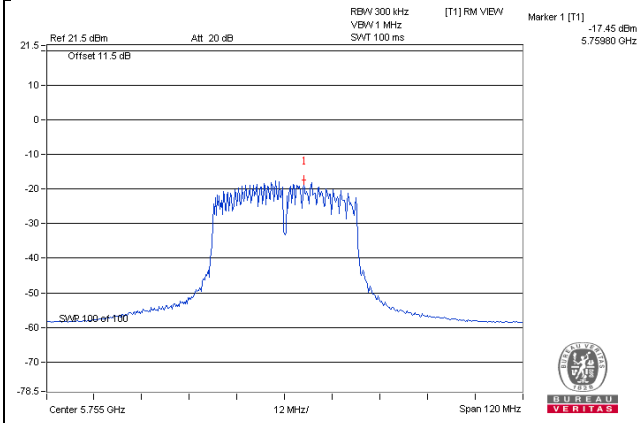

## 4.5 Frequency Stability Measurement

### 4.5.1 Limits of Frequency Stability Measurement

The frequency of the carrier signal shall be maintained within band of operation

### 4.5.2 Test Setup

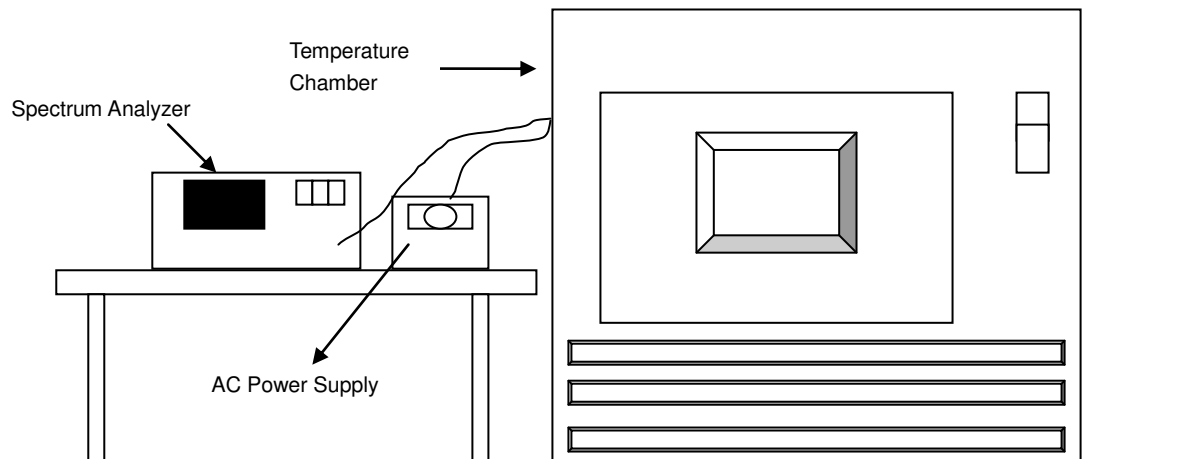

### 4.5.3 Test Instruments

Refer to section 4.1.2 to get information of above instrument.

### 4.5.4 Test Procedure

- The EUT was placed inside the environmental test chamber and powered by nominal AC voltage.
- Turn the EUT on and couple its output to a spectrum analyzer.
- Turn the EUT off and set the chamber to the highest temperature specified.
- Allow sufficient time (approximately 30 min) for the temperature of the chamber to stabilize, turn the EUT on and measure the operating frequency after 2, 5, and 10 Minutes.
- Repeat step 2 and 3 with the temperature chamber set to the lowest temperature.
- The test chamber was allowed to stabilize at +20 degree C for a minimum of 30 Minutes. The supply voltage was then adjusted on the EUT from 85% to 115% and the frequency record.

### 4.5.5 Deviation from Test Standard

No deviation.

### 4.5.6 EUT Operating Condition

Set the EUT transmit at un-modulation mode to test frequency stability.

#### 4.5.7 Test Results

<b>Frequency Stability Versus Temp.</b>									
<b>Operating Frequency: 5180 MHz</b>									
<b>TEMP.</b> <b>(°C)</b>	<b>Power</b> <b>Supply</b> <b>(Vac)</b>	<b>0 Minute</b>		<b>2 Minute</b>		<b>5 Minute</b>		<b>10 Minute</b>	
		<b>Measured</b> <b>Frequency</b> <b>(MHz)</b>	<b>Pass/Fail</b>	<b>Measured</b> <b>Frequency</b> <b>(MHz)</b>	<b>Pass/Fail</b>	<b>Measured</b> <b>Frequency</b> <b>(MHz)</b>	<b>Pass/Fail</b>	<b>Measured</b> <b>Frequency</b> <b>(MHz)</b>	<b>Pass/Fail</b>
50	120	5180.0036	PASS	5180.0045	PASS	5180.0016	PASS	5180.004	PASS
40	120	5180.0188	PASS	5180.0179	PASS	5180.0201	PASS	5180.0196	PASS
30	120	5180.001	PASS	5180.0011	PASS	5180.0029	PASS	5180.0026	PASS
20	120	5179.9849	PASS	5179.9832	PASS	5179.9835	PASS	5179.9836	PASS
10	120	5179.9925	PASS	5179.9914	PASS	5179.9921	PASS	5179.9958	PASS
0	120	5179.9944	PASS	5179.9918	PASS	5179.9959	PASS	5179.994	PASS
-10	120	5180.0185	PASS	5180.0187	PASS	5180.0172	PASS	5180.0205	PASS
-20	120	5179.9895	PASS	5179.9918	PASS	5179.9889	PASS	5179.9883	PASS
-30	120	5180.0029	PASS	5180.0047	PASS	5180.0071	PASS	5180.0062	PASS

<b>Frequency Stability Versus Voltage</b>									
<b>Operating Frequency: 5180 MHz</b>									
<b>TEMP.</b> <b>(°C)</b>	<b>Power</b> <b>Supply</b> <b>(Vac)</b>	<b>0 Minute</b>		<b>2 Minute</b>		<b>5 Minute</b>		<b>10 Minute</b>	
		<b>Measured</b> <b>Frequency</b> <b>(MHz)</b>	<b>Pass/Fail</b>	<b>Measured</b> <b>Frequency</b> <b>(MHz)</b>	<b>Pass/Fail</b>	<b>Measured</b> <b>Frequency</b> <b>(MHz)</b>	<b>Pass/Fail</b>	<b>Measured</b> <b>Frequency</b> <b>(MHz)</b>	<b>Pass/Fail</b>
20	138	5179.9851	PASS	5179.9822	PASS	5179.9833	PASS	5179.9833	PASS
	120	5179.9849	PASS	5179.9832	PASS	5179.9835	PASS	5179.9836	PASS
	102	5179.9845	PASS	5179.9822	PASS	5179.9833	PASS	5179.9832	PASS



## 4.6 6dB Bandwidth Measurement

### 4.6.1 Limits of 6dB Bandwidth Measurement

The minimum of 6dB Bandwidth Measurement is 0.5MHz.

### 4.6.2 Test Setup

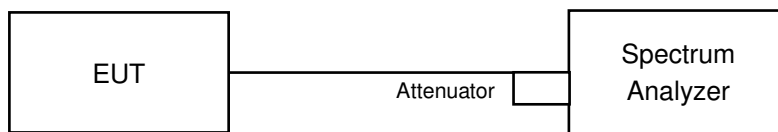

### 4.6.3 Test Instruments

Refer to section 4.1.2 to get information of above instrument.

### 4.6.4 Test Procedure

#### MEASUREMENT PROCEDURE REF

- Set resolution bandwidth (RBW) = 100kHz
- Set the video bandwidth (VBW)  $\geq 3 \times$  RBW, Detector = Peak.
- Trace mode = max hold.
- Sweep = auto couple.
- Measure the maximum width of the emission that is constrained by the frequencies associated with the two amplitude points (upper and lower) that are attenuated by 6 dB relative to the maximum level measured in the fundamental emission

### 4.6.5 Deviation from Test Standard

No deviation.

### 4.6.6 EUT Operating Condition

The software provided by client to enable the EUT under transmission condition continuously at lowest, middle and highest channel frequencies individually.

#### 4.6.7 Test Results

##### 802.11a

Channel	Frequency (MHz)	6dB Bandwidth (MHz)	Minimum Limit (MHz)	Pass / Fail
149	5745	15.16	0.5	Pass
157	5785	15.10	0.5	Pass
165	5825	15.16	0.5	Pass

##### 802.11n (HT20)

Channel	Frequency (MHz)	6dB Bandwidth (MHz)	Minimum Limit (MHz)	Pass / Fail
149	5745	15.15	0.5	Pass
157	5785	15.13	0.5	Pass
165	5825	15.14	0.5	Pass

##### 802.11n (HT40)

Channel	Frequency (MHz)	6dB Bandwidth (MHz)	Minimum Limit (MHz)	Pass / Fail
151	5755	35.14	0.5	Pass
159	5795	35.05	0.5	Pass

### Spectrum Plot of Worst Value

**802.11a\_CH157**

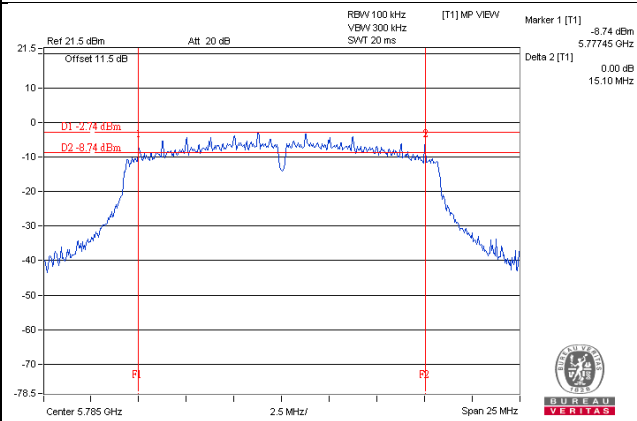

**802.11n (HT20)\_CH157**

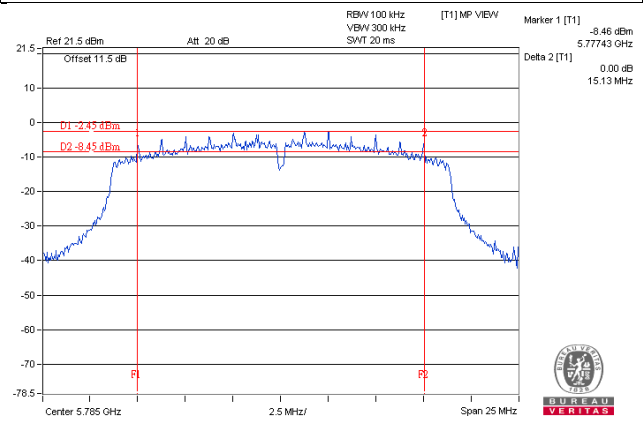

**802.11n (HT40)\_CH159**

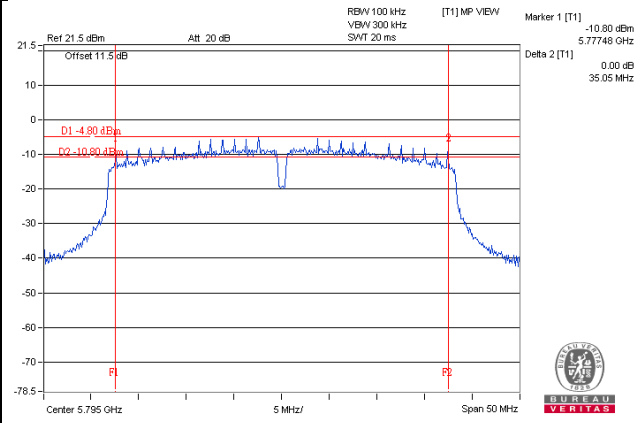

## 5 Pictures of Test Arrangements

Please refer to the attached file (Test Setup Photo).

# Annex A- Radiated Out of Band Emisison (OOBE) Measurement (For U-NII-3 band)

802.11a

**CH 149 5745 MHz**

**Horizontal**

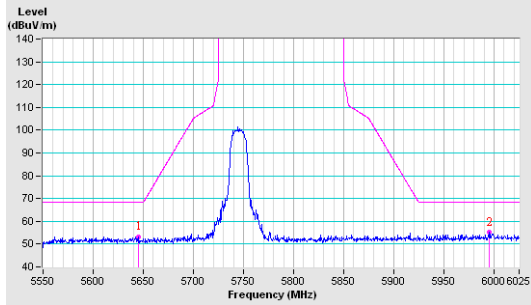

**Vertical**

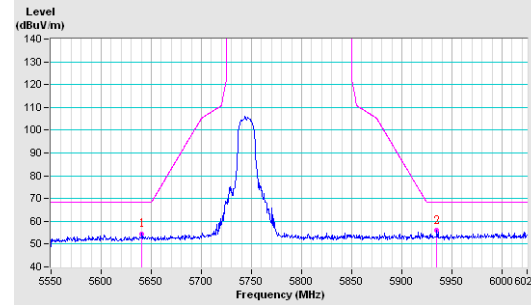

**CH 157 5785 MHz**

**Horizontal**

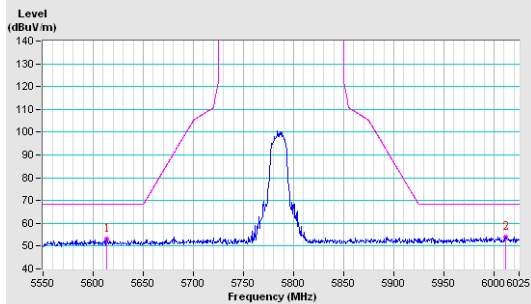

**Vertical**

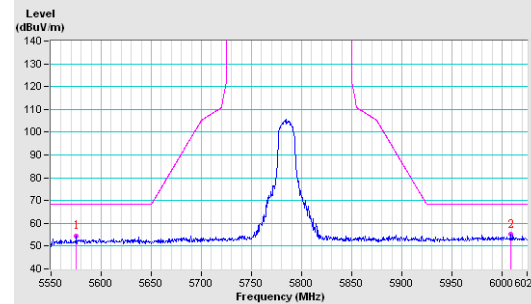

**CH 165 5825 MHz**

**Horizontal**

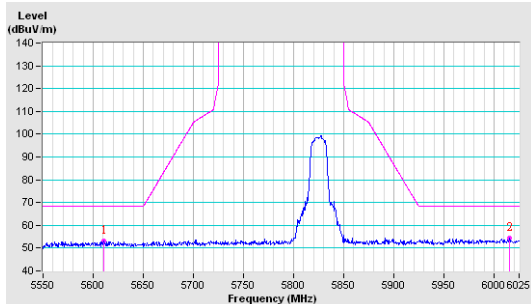

**Vertical**

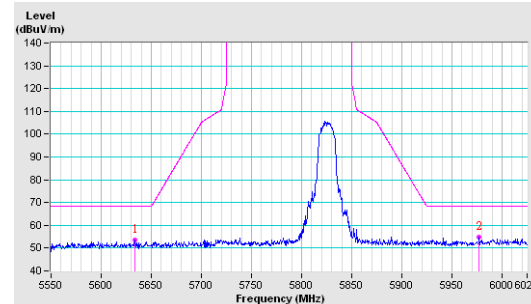

802.11n (HT20)

CH 149 5745 MHz

Horizontal

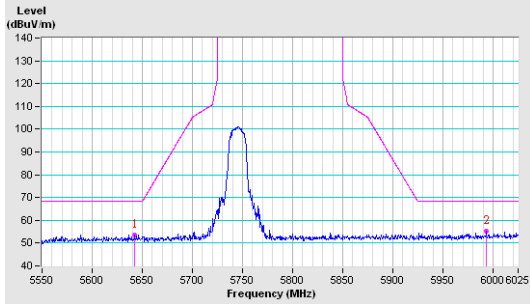

Vertical

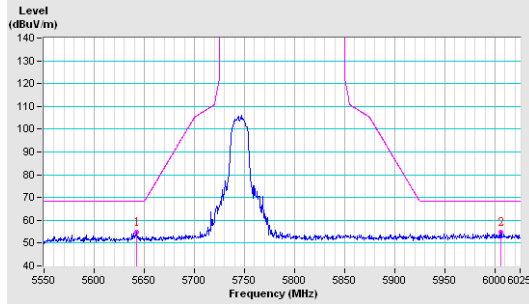

CH 157 5785 MHz

Horizontal

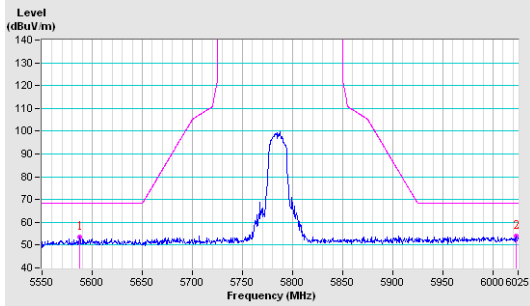

Vertical

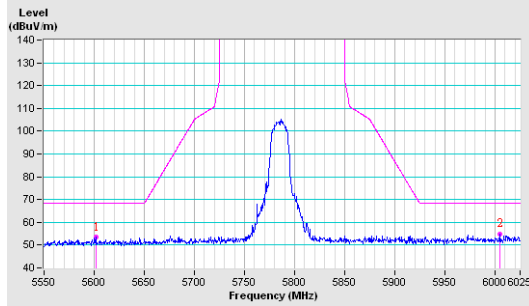

CH 165 5825 MHz

Horizontal

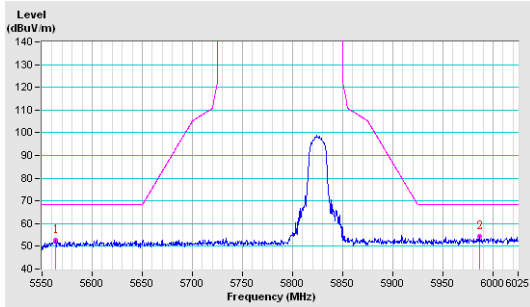

Vertical

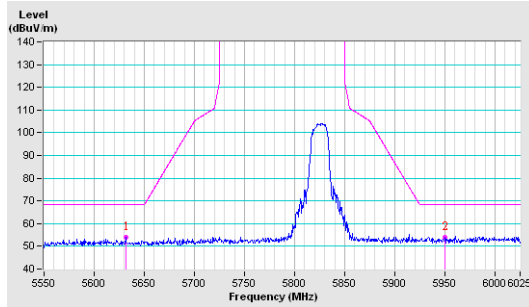

802.11n (HT40)

CH 151 5755 MHz

Horizontal

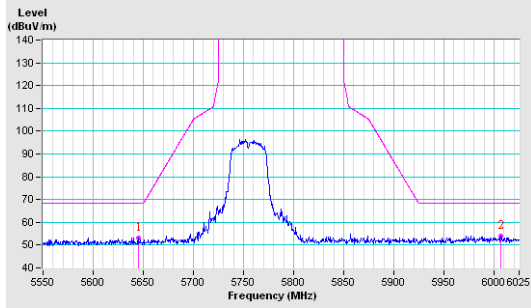

Vertical

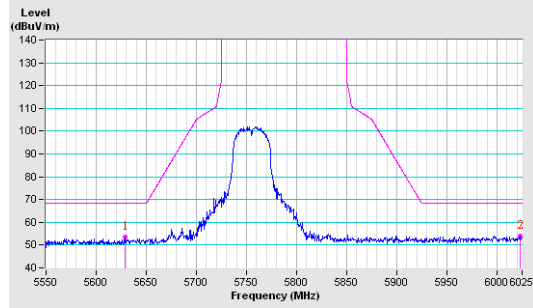

CH 159 5795 MHz

Horizontal

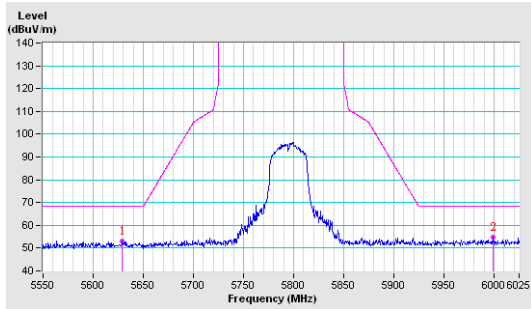

Vertical

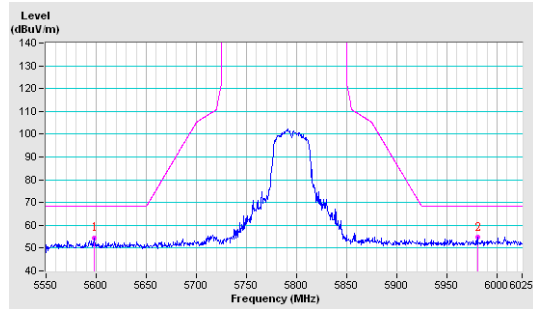

## Appendix – Information on the Testing Laboratories

We, Bureau Veritas Consumer Products Services (H.K.) Ltd., Taoyuan Branch, were founded in 1988 to provide our best service in EMC, Radio, Telecom and Safety consultation. Our laboratories are accredited and approved according to ISO/IEC 17025.

If you have any comments, please feel free to contact us at the following:

**Linko EMC/RF Lab**

Tel: 886-2-26052180

Fax: 886-2-26051924

**Hsin Chu EMC/RF/Telecom Lab**

Tel: 886-3-6668565

Fax: 886-3-6668323

**Hwa Ya EMC/RF/Safety Lab**

Tel: 886-3-3183232

Fax: 886-3-3270892

**Email:** [service.adt@tw.bureauveritas.com](mailto:service.adt@tw.bureauveritas.com)

**Web Site:** [www.bureauveritas-adt.com](http://www.bureauveritas-adt.com)

The address and road map of all our labs can be found in our web site also.

--- END ---