

# FCC TEST REPORT

**REPORT NO.:** RF970430H03

**MODEL NO.:** WR5502

**RECEIVED:** April 30, 2008

**TESTED:** May 15 to June 10, 2008

**ISSUED:** June 17, 2008

**APPLICANT:** AboCom Systems, Inc.

**ADDRESS:** 1F, No. 21, R&D Rd. II, SBIP, Hsin-Chu,  
Taiwan, R.O.C.

**ISSUED BY:** Advance Data Technology Corporation

**TEST LOCATION:** No. 81-1, Lu Liao Keng, 9 Ling, Wu Lung  
Tsuen, Chiung Lin Hsiang, Hsin Chu Hsien,  
Taiwan, R.O.C.

This test report consists of 89 pages in total. It may be duplicated completely for legal use with the approval of the applicant. It should not be reproduced except in full, without the written approval of our laboratory. The client should not use it to claim product endorsement by TAF, A2LA or any government agencies. The test results in the report only apply to the tested sample.



## Table of Contents

1.	CERTIFICATION .....	4
2.	SUMMARY OF TEST RESULTS .....	5
2.1	MEASUREMENT UNCERTAINTY .....	6
3.	GENERAL INFORMATION .....	7
3.1	GENERAL DESCRIPTION OF EUT .....	7
3.2	DESCRIPTION OF TEST MODES .....	9
3.2.1	TEST MODE APPLICABILITY AND TESTED CHANNEL DETAIL: .....	10
3.3	GENERAL DESCRIPTION OF APPLIED STANDARDS .....	12
3.4	DESCRIPTION OF SUPPORT UNITS .....	13
3.5	CONFIGURATION OF SYSTEM UNDER TEST .....	14
4.	TEST TYPES AND RESULTS .....	15
4.1	CONDUCTED EMISSION MEASUREMENT .....	15
4.1.1	LIMITS OF CONDUCTED EMISSION MEASUREMENT .....	15
4.1.2	TEST INSTRUMENTS .....	15
4.1.3	TEST PROCEDURES .....	16
4.1.4	DEVIATION FROM TEST STANDARD .....	16
4.1.5	TEST SETUP .....	17
4.1.6	EUT OPERATING CONDITIONS .....	17
4.1.7	TEST RESULTS .....	18
4.2	RADIATED EMISSION MEASUREMENT .....	20
4.2.1	LIMITS OF RADIATED EMISSION MEASUREMENT .....	20
4.2.2	TEST INSTRUMENTS .....	21
4.2.3	TEST PROCEDURES .....	22
4.2.4	DEVIATION FROM TEST STANDARD .....	22
4.2.5	TEST SETUP .....	23
4.2.6	EUT OPERATING CONDITIONS .....	23
4.2.7	TEST RESULTS .....	24
4.3	6dB BANDWIDTH MEASUREMENT .....	53
4.3.1	LIMITS OF 6dB BANDWIDTH MEASUREMENT .....	53
4.3.2	TEST INSTRUMENTS .....	53
4.3.3	TEST PROCEDURE .....	54
4.3.4	DEVIATION FROM TEST STANDARD .....	54
4.3.5	TEST SETUP .....	54
4.3.6	EUT OPERATING CONDITIONS .....	54
4.3.7	TEST RESULTS .....	55
4.4	MAXIMUM PEAK OUTPUT POWER .....	63



4.4.1	LIMITS OF MAXIMUM PEAK OUTPUT POWER MEASUREMENT .....	63
4.4.2	INSTRUMENTS .....	63
4.4.3	TEST PROCEDURES.....	64
4.4.4	DEVIATION FROM TEST STANDARD .....	64
4.4.5	TEST SETUP .....	64
4.4.6	EUT OPERATING CONDITIONS.....	64
4.4.7	TEST RESULTS.....	65
4.5	POWER SPECTRAL DENSITY MEASUREMENT.....	67
4.5.1	LIMITS OF POWER SPECTRAL DENSITY MEASUREMENT .....	67
4.5.2	TEST INSTRUMENTS .....	67
4.5.3	TEST PROCEDURE .....	68
4.5.4	DEVIATION FROM TEST STANDARD .....	68
4.5.5	TEST SETUP .....	68
4.5.6	EUT OPERATING CONDITION .....	68
4.5.7	TEST RESULTS.....	69
4.6	BAND EDGES MEASUREMENT .....	77
4.6.1	LIMITS OF BAND EDGES MEASUREMENT .....	77
4.6.2	TEST INSTRUMENTS .....	77
4.6.3	TEST PROCEDURE .....	77
4.6.4	DEVIATION FROM TEST STANDARD .....	78
4.6.5	EUT OPERATING CONDITION .....	78
4.6.6	TEST RESULTS.....	78
4.7	ANTENNA REQUIREMENT .....	87
4.7.1	STANDARD APPLICABLE .....	87
4.7.2	ANTENNA CONNECTED CONSTRUCTION .....	87
5.	INFORMATION ON THE TESTING LABORATORIES .....	88
6.	APPENDIX A - MODIFICATIONS RECORDERS FOR ENGINEERING CHANGES TO THE EUT BY THE LAB .....	89



## 1. CERTIFICATION

**PRODUCT:** 802.11b/g/n Router  
**BRAND NAME:** AboCom  
**MODEL NO.:** WR5502  
**TEST SAMPLE:** R&D SAMPLE  
**TESTED:** May 15 to June 10, 2008  
**APPLICANT:** AboCom Systems, Inc.  
**STANDARDS:** FCC Part 15, Subpart C (Section 15.247),  
ANSI C63.4-2003

The above equipment (Model: WR5502) has been tested by **Advance Data Technology Corporation**, and found compliance with the requirement of the above standards. The test record, data evaluation & Equipment Under Test (EUT) configurations represented herein are true and accurate accounts of the measurements of the sample's EMC characteristics under the conditions specified in this report.

**PREPARED BY** : Sunny Wen , **DATE:** June 17, 2008  
( Sunny Wen, Specialist )

**TECHNICAL ACCEPTANCE** : Hank Chung , **DATE:** June 17, 2008  
Responsible for RF ( Hank Chung, Deputy Manager )

**APPROVED BY** : May Chen , **DATE:** June 17, 2008  
( May Chen, Deputy Manager )

## 2. SUMMARY OF TEST RESULTS

The EUT has been tested according to the following specifications:

<b>APPLIED STANDARD: FCC Part 15, Subpart C (Section 15.247)</b>			
<b>Standard Section</b>	<b>Test Type and Limit</b>	<b>Result</b>	<b>Remark</b>
15.207	AC Power Conducted Emission	PASS	Meet the requirement of limit. Minimum passing margin is -3.96dB at 0.275MHz
15.247(a)(2)	Spectrum Bandwidth of a Direct Sequence Spread Spectrum System Limit: min. 500kHz	PASS	Meet the requirement of limit.
15.247(b)	Maximum Peak Output Power Limit: max. 30dBm	PASS	Meet the requirement of limit.
15.247(d)	Radiated Emissions Limit: Table 15.209	PASS	Meet the requirement of limit. Minimum passing margin is -0.99dB at 2483.50MHz
15.247(e)	Power Spectral Density Limit: max. 8dBm	PASS	Meet the requirement of limit.
15.247(d)	Band Edge Measurement Limit: 20dB less than the peak value of fundamental frequency	PASS	Meet the requirement of limit.

## 2.1 MEASUREMENT UNCERTAINTY

Where relevant, the following measurement uncertainty levels have been estimated for tests performed on the EUT as specified in CISPR 16-4:

This uncertainty represents an expanded uncertainty expressed at approximately the 95% confidence level using a coverage factor of  $k=2$ .

Measurement	Value
Conducted emissions	2.44 dB
Radiated emissions (30MHz-1GHz)	3.94 dB
Radiated emissions (1GHz -18GHz)	2.33 dB
Radiated emissions (18GHz -40GHz)	2.55 dB

### 3. GENERAL INFORMATION

#### 3.1 GENERAL DESCRIPTION OF EUT

<b>PRODUCT</b>	802.11b/g/n Router
<b>MODEL NO.</b>	WR5502
<b>FCC ID</b>	MQ4WR5502
<b>POWER SUPPLY</b>	DC 12V from power adapter
<b>MODULATION TYPE</b>	CCK, DQPSK, DBPSK for DSSS 64QAM, 16QAM, QPSK, BPSK for OFDM
<b>MODULATION TECHNOLOGY</b>	DSSS, OFDM
<b>TRANSFER RATE</b>	802.11b: 11/ 5.5/ 2/ 1Mbps 802.11g: 54/ 48/ 36/ 24/ 18/ 12/ 9/ 6Mbps Draft 802.11n (20MHz): 144.4/130.0/115.5/86.6/ 72.2/65.0/57.8/43.3/28.9/21.7/14.4/7.2Mbps Draft 802.11n (40MHz): 300/ 270/ 240/ 180/150/135/120/90/60/45/30/15Mbps
<b>FREQUENCY RANGE</b>	2412 ~ 2462MHz
<b>NUMBER OF CHANNEL</b>	11 for 802.11b, 802.11g, draft 802.11n (20MHz) 7 for draft 802.11n (40MHz)
<b>MAXIMUM OUTPUT POWER</b>	802.11b: 87.096mW 802.11g: 104.713mW draft 802.11n (20MHz): 109.144mW draft 802.11n (40MHz): 47.315mW
<b>ANTENNA TYPE</b>	Please see note 1 ( on next page)
<b>DATA CABLE</b>	NA
<b>I/O PORT</b>	WAN Port x 1, LAN Port x 4

**NOTE:**

1. There are two antennas provided to this EUT, please refer to the following table:

Transmitter Circuit	Antenna Type	Antenna Connector	Gain(dBi)
Chain(0)	Dipole	Reverse SMA	2
Chain(1)	Dipole	Reverse SMA	2

2. The EUT was operated with the following power adapter :

<b>Brand:</b>	LEI
<b>Model No.:</b>	MT12-Y120100-A1
<b>Input power :</b>	AC 100-120V, 60Hz, 0.3A
<b>Output power :</b>	DC 12V, 1A Cable:1.5m/unshielded/without core

3. The EUT incorporates a SIMO function with 802.11b, 802.11g, draft 802.11n. Physically, the EUT provides one completed transmit and two completed receivers.
4. The EUT is 1 \* 2 spatial SIMO without beam forming function. The antenna configurations are one transmitter antenna and two receiver antennas, as there are 2 Dipole antennas. Spatial multiplexing modes for simultaneous transmission using 1 antenna, and for simultaneous receiver using 2 antennas. The 11bg legacy modes are limited to single transmitter only.
5. When the EUT operating in draft 802.11n, the software operation, which is defined by manufacturer, MCS (Modulation and Coding Schemes) from 0 to 15.
6. The EUT complies with draft 802.11n standards and backwards compatible with 802.11b, 802.11g products.
7. The EUT, operates in the 2.4GHz frequency range, lets you connect IEEE 802.11g or IEEE 802.11b and draft 802.11n technique devices to the network.
8. The above EUT information was declared by manufacturer and for more detailed features description, please refer to the manufacturer's specifications or user's manual.



### 3.2 DESCRIPTION OF TEST MODES

Eleven channels are provided for 802.11b, 802.11g, draft 802.11n (20MHz):

CHANNEL	FREQUENCY	CHANNEL	FREQUENCY
1	2412MHz	7	2442MHz
2	2417MHz	8	2447MHz
3	2422MHz	9	2452MHz
4	2427MHz	10	2457MHz
5	2432MHz	11	2462MHz
6	2437MHz		

Seven channels are provided for draft 802.11n (40MHz):

CHANNEL	FREQUENCY	CHANNEL	FREQUENCY
1	2422MHz	5	2442MHz
2	2427MHz	6	2447MHz
3	2432MHz	7	2452MHz
4	2437MHz		

### 3.2.1 TEST MODE APPLICABILITY AND TESTED CHANNEL DETAIL:

EUT CONFIGURE MODE	APPLICABLE TO				DESCRIPTION
	PLC	RE < 1G	RE ≥ 1G	APCM	
-	√	√	√	√	-

Where **PLC**: Power Line Conducted Emission      **RE < 1G**: Radiated Emission below 1GHz  
**RE ≥ 1G**: Radiated Emission above 1GHz      **APCM**: Antenna Port Conducted Measurement

#### **POWER LINE CONDUCTED EMISSION TEST:**

- Pre-Scan has been conducted to determine the worst-case mode from all possible combinations between available modulations, data rates and antenna ports (if EUT with antenna diversity architecture).
- Following channel(s) was (were) selected for the final test as listed below.

MODE	AVAILABLE CHANNEL	TESTED CHANNEL	MODULATION TECHNOLOGY	MODULATION TYPE	DATA RATE (Mbps)
Draft 802.11n (20MHz)	1 to 11	6	OFDM	BPSK	7.2

#### **RADIATED EMISSION TEST (BELOW 1 GHZ):**

- Pre-Scan has been conducted to determine the worst-case mode from all possible combinations between available modulations, data rates and antenna ports (if EUT with antenna diversity architecture).
- Following channel(s) was (were) selected for the final test as listed below.

MODE	AVAILABLE CHANNEL	TESTED CHANNEL	MODULATION TECHNOLOGY	MODULATION TYPE	DATA RATE (Mbps)
Draft 802.11n (20MHz)	1 to 11	6	OFDM	BPSK	7.2

#### **RADIATED EMISSION TEST (ABOVE 1 GHZ):**

- Pre-Scan has been conducted to determine the worst-case mode from all possible combinations between available modulations, data rates and antenna ports (if EUT with antenna diversity architecture).
- Following channel(s) was (were) selected for the final test as listed below.

MODE	AVAILABLE CHANNEL	TESTED CHANNEL	MODULATION TECHNOLOGY	MODULATION TYPE	DATA RATE (Mbps)
802.11b	1 to 11	1, 6, 11	DSSS	DBPSK	1
802.11g	1 to 11	1, 6, 11	OFDM	BPSK	6
Draft 802.11n (20MHz)	1 to 11	1, 6, 11	OFDM	BPSK	7.2
Draft 802.11n (40MHz)	1 to 7	1, 4, 7	OFDM	BPSK	15

**BANDEDGE MEASUREMENT:**

- Pre-Scan has been conducted to determine the worst-case mode from all possible combinations between available modulations, data rates and antenna ports (if EUT with antenna diversity architecture).
- Following channel(s) was (were) selected for the final test as listed below.

MODE	AVAILABLE CHANNEL	TESTED CHANNEL	MODULATION TECHNOLOGY	MODULATION TYPE	DATA RATE (Mbps)
802.11b	1 to 11	1, 11	DSSS	DBPSK	1
802.11g	1 to 11	1, 11	OFDM	BPSK	6
Draft 802.11n (20MHz)	1 to 11	1, 11	OFDM	BPSK	7.2
Draft 802.11n (40MHz)	1 to 7	1, 7	OFDM	BPSK	15

**ANTENNA PORT CONDUCTED MEASUREMENT:**

- Pre-Scan has been conducted to determine the worst-case mode from all possible combinations between available modulations, data rates and antenna ports (if EUT with antenna diversity architecture).
- Following channel(s) was (were) selected for the final test as listed below.

MODE	AVAILABLE CHANNEL	TESTED CHANNEL	MODULATION TECHNOLOGY	MODULATION TYPE	DATA RATE (Mbps)
802.11b	1 to 11	1, 6, 11	DSSS	DBPSK	1
802.11g	1 to 11	1, 6, 11	OFDM	BPSK	6
Draft 802.11n (20MHz)	1 to 11	1, 6, 11	OFDM	BPSK	7.2
Draft 802.11n (40MHz)	1 to 7	1, 4, 7	OFDM	BPSK	15



### **3.3 GENERAL DESCRIPTION OF APPLIED STANDARDS**

The EUT is an 802.11b/g/n Router. According to the specifications of the manufacturer, it must comply with the requirements of the following standards:

**FCC Part 15, Subpart C. (15.247)**

**ANSI C63.4-2003**

All test items have been performed and recorded as per the above standards.

**NOTE:** The EUT is also considered as a kind of computer peripheral, because the connection to computer is necessary for typical use. It has been verified to comply with the requirements of FCC Part 15, Subpart B, Class B (DoC). The test report has been issued separately.



### 3.4 DESCRIPTION OF SUPPORT UNITS

The EUT has been tested as an independent unit together with other necessary accessories or support units. The following support units or accessories were used to form a representative test configuration during the tests.

NO.	PRODUCT	BRAND	MODEL NO.	SERIAL NO.	FCC ID
1	NOTEBOOK COMPUTER	DELL	PP18L	6976685584	DoC
2	NOTEBOOK COMPUTER	DELL	PP05L	CN-04Y212-48643-38E-0145	DoC
3	HUB	AVSYS	110H8	01-20E-000002	DoC

NO.	SIGNAL CABLE DESCRIPTION OF THE ABOVE SUPPORT UNITS
1	NA
2	NA
3	NA

**NOTE:** All power cords of the above support units are non shielded (1.8m).

### 3.5 CONFIGURATION OF SYSTEM UNDER TEST

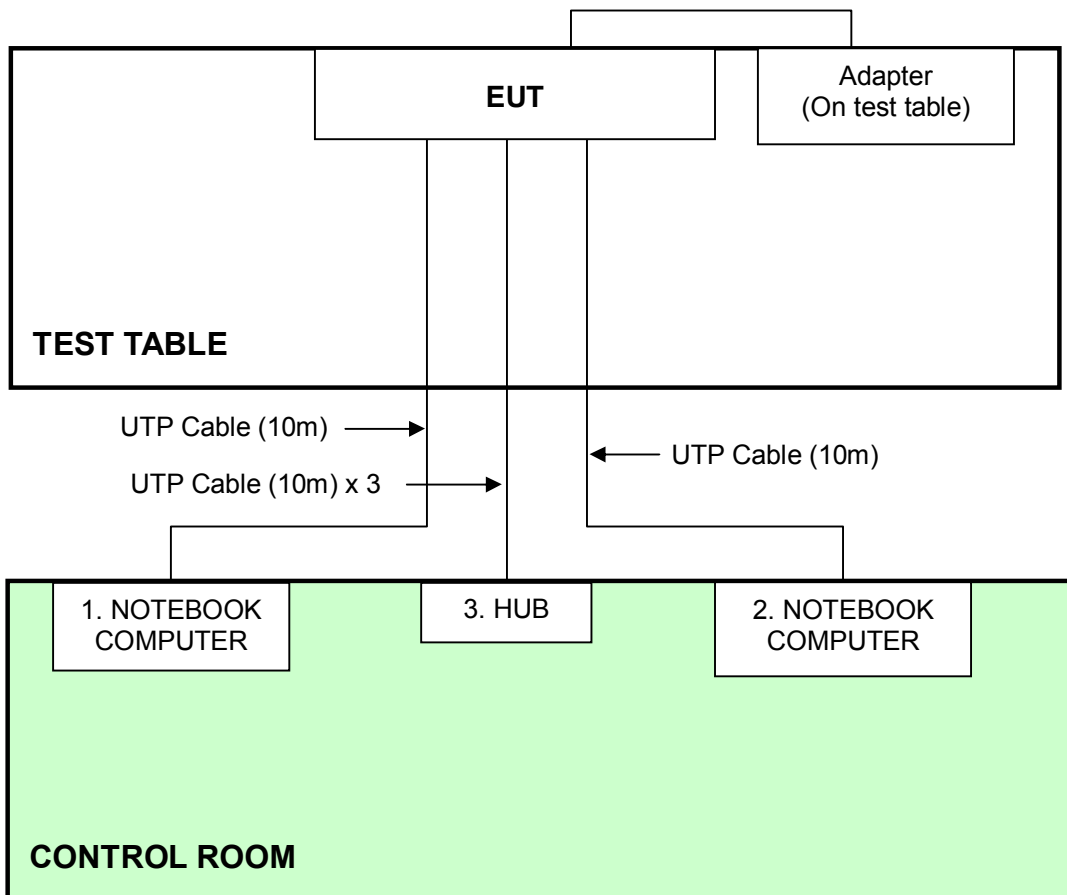

## 4. TEST TYPES AND RESULTS

### 4.1 CONDUCTED EMISSION MEASUREMENT

#### 4.1.1 LIMITS OF CONDUCTED EMISSION MEASUREMENT

FREQUENCY OF EMISSION (MHz)	CONDUCTED LIMIT (dB $\mu$ V)	
	Quasi-peak	Average
0.15-0.5	66 to 56	56 to 46
0.5-5	56	46
5-30	60	50

- NOTE:**
1. The lower limit shall apply at the transition frequencies.
  2. The limit decreases in line with the logarithm of the frequency in the range of 0.15 to 0.50 MHz.
  3. All emanations from a class A/B digital device or system, including any network of conductors and apparatus connected thereto, shall not exceed the level of field strengths specified above.

#### 4.1.2 TEST INSTRUMENTS

DESCRIPTION & MANUFACTURER	MODEL NO.	SERIAL NO.	CALIBRATED UNTIL
ROHDE & SCHWARZ Test Receiver	ESCS 30	100287	Mar. 06, 2009
Line-Impedance Stabilization Network(for EUT)	KNW-407	8-1395-12	Aug. 19, 2008
Line-Impedance Stabilization Network(for Peripheral)	ENV-216	100072	Nov. 08, 2008
RF Cable (JETBAO)	RG5B/U-6m	COACAB-9KHz-3 0MHz	Aug. 15, 2008
50 ohms Terminator	50	3	Nov. 15, 2008
Software	ADT_Cond_V7.3.2	NA	NA

- NOTE:**
1. The calibration interval of the above test instruments is 12 months and the calibrations are traceable to NML/ROC and NIST/USA.
  2. The test was performed in ADT Shielded Room No. A.
  3. The VCCI Con A Registration No. is C-817.

#### 4.1.3 TEST PROCEDURES

- a. The EUT was placed 0.4 meters from the conducting wall of the shielded room with EUT being connected to the power mains through a line impedance stabilization network (LISN). Other support units were connected to the power mains through another LISN. The two LISNs provide 50 ohm/ 50uH of coupling impedance for the measuring instrument.
- b. Both lines of the power mains connected to the EUT were checked for maximum conducted interference.
- c. The frequency range from 150kHz to 30MHz was searched. Emission levels under (Limit - 20dB) were not recorded.

#### 4.1.4 DEVIATION FROM TEST STANDARD

No deviation



#### 4.1.5 TEST SETUP

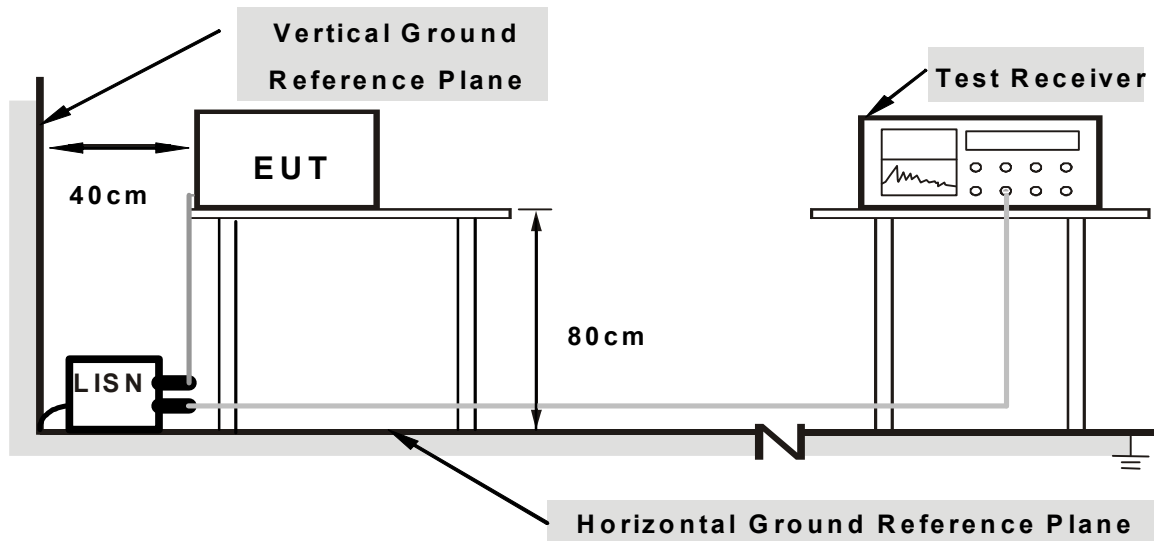

**Note: 1.Support units were connected to second LISN.**

**2.Both of LISNs (AMN) are 80 cm from EUT and at least 80 from other units and other metal planes**

For the actual test configuration, please refer to the related item – Photographs of the Test Configuration.

#### 4.1.6 EUT OPERATING CONDITIONS

1. Placed the EUT on testing table.
2. Prepared other computer systems (support unit 1 ~ 2) to act as communication partners and placed them outside of testing area.
3. The communication partners run test program “MP\_TEST” to enable EUT under transmission/receiving condition continuously at specific channel frequency.

#### 4.1.7 TEST RESULTS

##### DRAFT 802.11n (20MHz) OFDM MODULATION

EUT TEST CONDITION		MEASUREMENT DETAIL	
CHANNEL	Channel 6	PHASE	Line (L)
MODULATION TYPE	BPSK	6dB BANDWIDTH	9 kHz
TRANSFER RATE	7.2Mbps	INPUT POWER	120Vac, 60 Hz
ENVIRONMENTAL CONDITIONS	27deg. C, 70%RH, 972hPa	TESTED BY	Hart Chang

No	Freq. [MHz]	Corr. Factor (dB)	Reading Value [dB (uV)]		Emission Level [dB (uV)]		Limit [dB (uV)]		Margin (dB)	
			Q.P.	AV.	Q.P.	AV.	Q.P.	AV.	Q.P.	AV.
	1	0.166	0.35	59.83	46.14	60.18	46.49	65.18	55.18	-5.00
2	0.221	0.31	55.70	47.09	56.01	47.40	62.76	52.76	-6.75	-5.36
<b>3</b>	<b>0.275</b>	<b>0.25</b>	<b>56.76</b>	<b>43.25</b>	<b>57.01</b>	<b>43.50</b>	<b>60.97</b>	<b>50.97</b>	<b>-3.96</b>	<b>-7.47</b>
4	0.384	0.12	52.73	39.58	52.85	39.70	58.18	48.18	-5.34	-8.49
5	0.439	0.11	51.08	38.00	51.19	38.11	57.08	47.08	-5.89	-8.97
6	0.716	0.22	49.60	36.09	49.82	36.31	56.00	46.00	-6.18	-9.69
7	0.837	0.26	49.95	37.56	50.21	37.82	56.00	46.00	-5.79	-8.18
8	4.502	0.42	46.77	35.34	47.19	35.76	56.00	46.00	-8.81	-10.24

- REMARKS:**
1. Q.P. and AV. are abbreviations of quasi-peak and average individually.
  2. "-": The Quasi-peak reading value also meets average limit and measurement with the average detector is unnecessary.
  3. The emission levels of other frequencies were very low against the limit.
  4. Margin value = Emission level - Limit value
  5. Correction factor = Insertion loss + Cable loss
  6. Emission Level = Correction Factor + Reading Value.

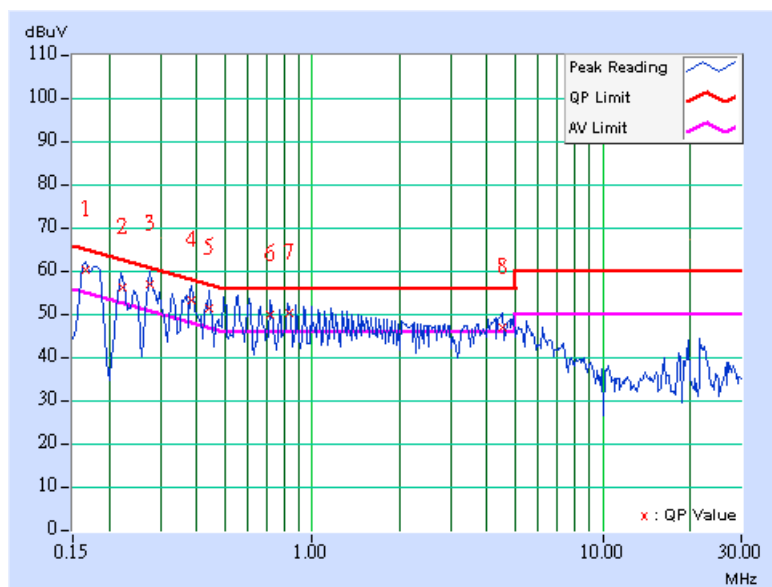

EUT TEST CONDITION		MEASUREMENT DETAIL	
CHANNEL	Channel 6	PHASE	Neutral (N)
MODULATION TYPE	BPSK	6dB BANDWIDTH	9 kHz
TRANSFER RATE	7.2Mbps	INPUT POWER	120Vac, 60 Hz
ENVIRONMENTAL CONDITIONS	27deg. C, 70%RH, 972hPa	TESTED BY	Hart Chang

No	Freq. [MHz]	Corr. Factor (dB)	Reading Value [dB (uV)]		Emission Level [dB (uV)]		Limit [dB (uV)]		Margin (dB)	
			Q.P.	AV.	Q.P.	AV.	Q.P.	AV.	Q.P.	AV.
	1	0.166	0.37	59.69	46.03	60.06	46.40	65.18	55.18	-5.12
2	0.219	0.33	55.56	46.19	55.89	46.52	62.84	52.84	-6.95	-6.32
3	0.275	0.26	56.20	42.94	56.46	43.20	60.97	50.97	-4.51	-7.77
4	0.380	0.12	50.23	34.82	50.35	34.94	58.27	48.27	-7.92	-13.33
5	0.502	0.13	50.81	39.65	50.94	39.78	56.00	46.00	-5.06	-6.22
6	0.724	0.21	50.41	38.30	50.62	38.51	56.00	46.00	-5.38	-7.49
7	4.218	0.41	46.15	35.40	46.56	35.81	56.00	46.00	-9.44	-10.19

- REMARKS:**
1. Q.P. and AV. are abbreviations of quasi-peak and average individually.
  2. "-": The Quasi-peak reading value also meets average limit and measurement with the average detector is unnecessary.
  3. The emission levels of other frequencies were very low against the limit.
  4. Margin value = Emission level - Limit value
  5. Correction factor = Insertion loss + Cable loss
  6. Emission Level = Correction Factor + Reading Value.

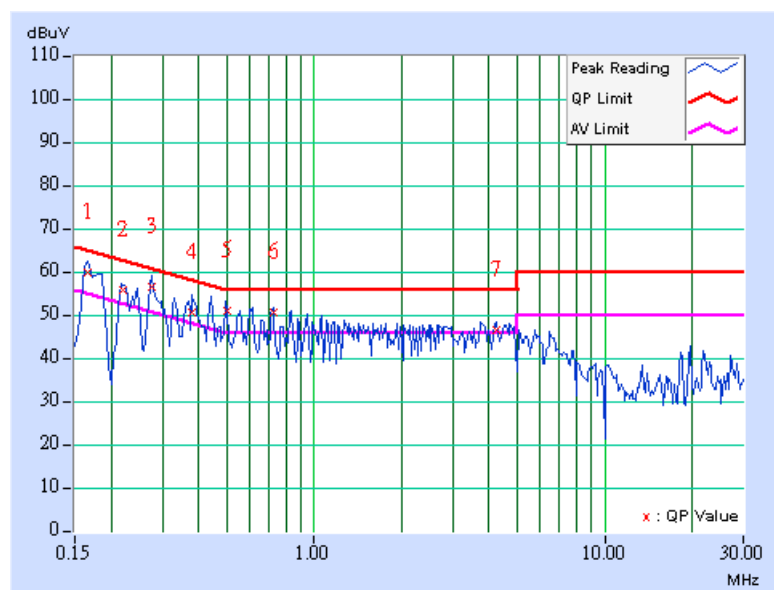

## 4.2 RADIATED EMISSION MEASUREMENT

### 4.2.1 LIMITS OF RADIATED EMISSION MEASUREMENT

Emissions radiated outside of the specified bands, shall be according to the general radiated limits in 15.209 as following:

Frequencies (MHz)	Field strength (microvolts/meter)	Measurement distance (meters)
0.009-0.490	2400/F(kHz)	300
0.490-1.705	24000/F(kHz)	30
1.705-30.0	30	30
30-88	100	3
88-216	150	3
216-960	200	3
Above 960	500	3

**NOTE:**

1. The lower limit shall apply at the transition frequencies.
2. Emission level (dBuV/m) = 20 log Emission level (uV/m).
3. As shown in 15.35(b), for frequencies above 1000MHz, the field strength limits are based on average detector, however, the peak field strength of any emission shall not exceed the maximum permitted average limits, specified above by more than 20dB under any condition of modulation.



#### 4.2.2 TEST INSTRUMENTS

DESCRIPTION & MANUFACTURER	MODEL NO.	SERIAL NO.	CALIBRATED UNTIL
ADVANTEST Spectrum Analyzer	R3271A	85060311	July 15, 2008
HP Pre_Amplifier	8449B	3008A01922	Oct. 04, 2008
ROHDE & SCHWARZ Test Receiver	ESCS30	100375	Mar. 26, 2009
SCHWARZBECK TRILOG Broadband Antenna	VULB 9168	138	July 26, 2008
Schwarzbeck Horn_Antenna	BBHA9120	D124	Dec. 16, 2008
Schwarzbeck Horn_Antenna	BBHA 9170	BBHA9170153	Jan. 27, 2009
RF Switches (ARNITSU)	CS-201	1565157	Aug. 13, 2008
RF CABLE (Chaintek)	SF102	22054-2	Dec. 06. 2008
RF Cable(RICHTEC)	9913-30M N-N Cable	STCCAB-30M-1 GHz	Aug. 13, 2008
Software	ADT_Radiated_V 7.6.15.8	NA	NA
CHANCE MOST Antenna Tower	AT-100	0203	NA
CHANCE MOST Turn Table	TT-100	0203	NA

- Note: 1. The calibration interval of the above test instruments is 12 months and the calibrations are traceable to NML/ROC and NIST/USA.  
 2. The horn antenna, HP preamplifier (model: 8449B) and Spectrum Analyzer (model: R3271A) are used only for the measurement of emission frequency above 1GHz if tested.  
 3. The test was performed in ADT Open Site No. C.  
 4. The FCC Site Registration No. is 656396.  
 5. The VCCI Site Registration No. is R-1626.  
 6. The CANADA Site Registration No. is IC 3789C-3.

### 4.2.3 TEST PROCEDURES

- a. The EUT was placed on the top of a rotating table 0.8 meters above the ground at a 10-meter open field site. The table was rotated 360 degrees to determine the position of the highest radiation.
- b. The EUT was set 3 meters away from the interference-receiving antenna, which was mounted on the top of a variable-height antenna tower.
- c. The antenna is a broadband antenna, and its height is varied from one meter to four meters above the ground to determine the maximum value of the field strength. Both horizontal and vertical polarizations of the antenna are set to make the measurement.
- d. For each suspected emission, the EUT was arranged to its worst case and then the antenna was tuned to heights from 1 meter to 4 meters and the rotatable table was turned from 0 degrees to 360 degrees to find the maximum reading.
- e. The test-receiver system was set to Peak Detect Function and Specified Bandwidth with Maximum Hold Mode.
- f. If the emission level of the EUT in peak mode was 10 dB lower than the limit specified, then testing could be stopped and the peak values of the EUT would be reported. Otherwise the emissions that did not have 10 dB margin would be re-tested one by one using the quasi-peak method or average method as specified and then reported in Data sheet peak mode and QP mode.

**NOTE:**

1. The resolution bandwidth and video bandwidth of test receiver/spectrum analyzer is 120kHz for Peak detection (PK) and Quasi-peak detection (QP) at frequency below 1GHz.
2. The resolution bandwidth of test receiver/spectrum analyzer is 1 MHz and the video bandwidth is 3 MHz for Peak detection (PK) at frequency above 1GHz.
3. The resolution bandwidth of test receiver/spectrum analyzer is 1 MHz and the video bandwidth is 10 Hz for Average detection (AV) at frequency above 1GHz.

### 4.2.4 DEVIATION FROM TEST STANDARD

No deviation

#### 4.2.5 TEST SETUP

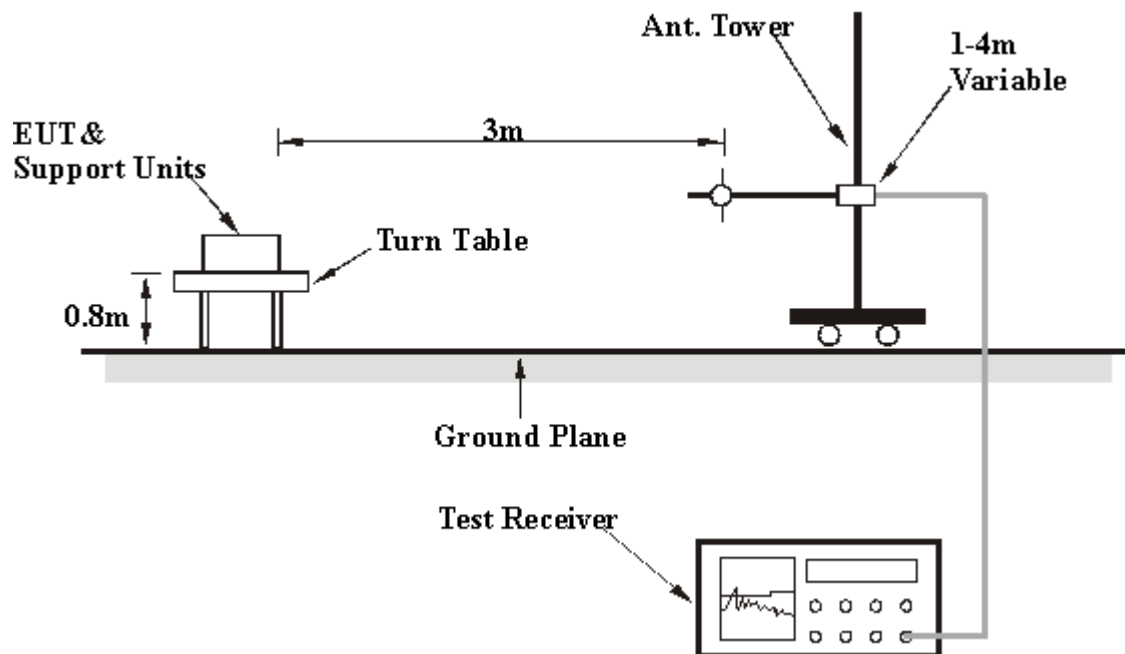

For the actual test configuration, please refer to the related item – Photographs of the Test Configuration.

#### 4.2.6 EUT OPERATING CONDITIONS

Same as 4.1.6

## 4.2.7 TEST RESULTS

### BELOW 1GHz WORST-CASE DATA : DRAFT 802.11n (20MHz) OFDM MODULATION

EUT TEST CONDITION		MEASUREMENT DETAIL	
CHANNEL	Channel 6	FREQUENCY RANGE	Below 1000MHz
INPUT POWER	120Vac, 60 Hz	DETECTOR FUNCTION	Quasi-Peak
ENVIRONMENTAL CONDITIONS	27deg. C, 60%RH 972hPa	TESTED BY	Cody Chang

ANTENNA POLARITY & TEST DISTANCE: HORIZONTAL AT 3 M								
NO.	FREQ. (MHz)	EMISSION LEVEL (dBuV/m)	LIMIT (dBuV/m)	MARGIN (dB)	ANTENNA HEIGHT (m)	TABLE ANGLE (Degree)	RAW VALUE (dBuV)	CORRECTION FACTOR (dB/m)
1	200.03	37.64 QP	43.50	-5.86	1.66 H	49	25.61	12.03
2	250.03	37.65 QP	46.00	-8.35	1.09 H	121	24.82	12.83
3	300.03	31.12 QP	46.00	-14.88	1.21 H	32	14.53	16.59
4	400.06	28.98 QP	46.00	-17.02	1.00 H	130	10.93	18.05
5	500.06	42.50 QP	46.00	-3.50	1.49 H	196	21.45	21.05
6	625.03	32.11 QP	46.00	-13.89	1.14 H	196	8.11	24.00
7	800.10	34.14 QP	46.00	-11.86	1.24 H	273	6.09	28.05
8	875.12	39.44 QP	46.00	-6.56	1.00 H	153	10.37	29.07
9	1000.14	33.49 QP	54.00	-20.51	1.45 H	4	2.96	30.53

ANTENNA POLARITY & TEST DISTANCE: VERTICAL AT 3 M								
NO.	FREQ. (MHz)	EMISSION LEVEL (dBuV/m)	LIMIT (dBuV/m)	MARGIN (dB)	ANTENNA HEIGHT (m)	TABLE ANGLE (Degree)	RAW VALUE (dBuV)	CORRECTION FACTOR (dB/m)
1	200.00	35.10 QP	43.50	-8.40	1.04 V	1	23.07	12.03
2	250.01	34.28 QP	46.00	-11.72	1.02 V	21	21.45	12.83
3	500.06	36.78 QP	46.00	-9.22	1.09 V	241	15.73	21.05
4	625.03	29.20 QP	46.00	-16.80	1.00 V	85	5.20	24.00
5	750.11	32.95 QP	46.00	-13.05	1.04 V	289	5.69	27.26
6	800.11	36.01 QP	46.00	-9.99	1.00 V	104	7.96	28.05
7	875.12	36.57 QP	46.00	-9.43	1.00 V	265	7.50	29.07
8	1000.14	34.35 QP	54.00	-19.65	1.10 V	228	3.82	30.53

- REMARKS:**
1. Emission level (dBuV/m) = Raw Value (dBuV) + Correction Factor (dB/m).
  2. Correction Factor (dB/m) = Antenna Factor (dB/m) + Cable Factor (dB).
  3. The other emission levels were very low against the limit.
  4. Margin value = Emission level – Limit value.



### 802.11b DSSS MODULATION

EUT TEST CONDITION		MEASUREMENT DETAIL	
CHANNEL	Channel 1	FREQUENCY RANGE	1 ~ 25GHz
INPUT POWER (SYSTEM)	120Vac, 60 Hz	DETECTOR FUNCTION	Peak (PK) Average (AV)
ENVIRONMENTAL CONDITIONS	25deg. C, 64%RH 972hPa	TESTED BY	Frank Liu

ANTENNA POLARITY & TEST DISTANCE: HORIZONTAL AT 3 M								
NO.	FREQ. (MHz)	EMISSION LEVEL (dBuV/m)	LIMIT (dBuV/m)	MARGIN (dB)	ANTENNA HEIGHT (m)	TABLE ANGLE (Degree)	RAW VALUE (dBuV)	CORRECTION FACTOR (dB/m)
1	2386.40	54.97 PK	74.00	-19.03	1.48 H	24	24.59	30.38
2	2386.40	44.85 AV	54.00	-9.15	1.48 H	24	14.47	30.38
3	*2412.00	100.60 PK			1.46 H	23	70.11	30.49
4	*2412.00	97.90 AV			1.46 H	23	67.41	30.49
5	4824.00	50.60 PK	74.00	-23.40	2.10 H	6	14.91	35.69
6	4824.00	43.80 AV	54.00	-10.20	2.10 H	6	8.11	35.69
ANTENNA POLARITY & TEST DISTANCE: VERTICAL AT 3 M								
NO.	FREQ. (MHz)	EMISSION LEVEL (dBuV/m)	LIMIT (dBuV/m)	MARGIN (dB)	ANTENNA HEIGHT (m)	TABLE ANGLE (Degree)	RAW VALUE (dBuV)	CORRECTION FACTOR (dB/m)
1	2386.00	60.21 PK	74.00	-13.79	1.00 V	26	29.83	30.38
2	2386.00	52.74 AV	54.00	-1.26	1.00 V	26	22.36	30.38
3	*2412.00	112.30 PK			1.00 V	25	81.81	30.49
4	*2412.00	107.60 AV			1.00 V	25	77.11	30.49
5	4824.00	54.20 PK	74.00	-19.80	1.28 V	201	18.51	35.69
6	4824.00	49.90 AV	54.00	-4.10	1.28 V	201	14.21	35.69

- REMARKS:**
1. Emission level (dBuV/m) = Raw Value (dBuV) + Correction Factor (dB/m).
  2. Correction Factor (dB/m) = Antenna Factor (dB/m) + Cable Factor (dB).
  3. The other emission levels were very low against the limit.
  4. Margin value = Emission level – Limit value.
  5. “ \* “: Fundamental frequency.

EUT TEST CONDITION		MEASUREMENT DETAIL	
CHANNEL	Channel 6	FREQUENCY RANGE	1 ~ 25GHz
INPUT POWER (SYSTEM)	120Vac, 60 Hz	DETECTOR FUNCTION	Peak (PK) Average (AV)
ENVIRONMENTAL CONDITIONS	25deg. C, 64%RH 972hPa	TESTED BY	Frank Liu

ANTENNA POLARITY & TEST DISTANCE: HORIZONTAL AT 3 M								
NO.	FREQ. (MHz)	EMISSION LEVEL (dBuV/m)	LIMIT (dBuV/m)	MARGIN (dB)	ANTENNA HEIGHT (m)	TABLE ANGLE (Degree)	RAW VALUE (dBuV)	CORRECTION FACTOR (dB/m)
1	*2437.00	100.90 PK			1.48 H	27	70.29	30.61
2	*2437.00	97.10 AV			1.48 H	27	66.49	30.61
3	4874.00	48.00 PK	74.00	-26.00	1.50 H	352	12.20	35.80
4	4874.00	36.80 AV	54.00	-17.20	1.50 H	352	1.00	35.80
5	7311.00	59.50 PK	74.00	-14.50	1.37 H	18	16.98	42.52
6	7311.00	51.60 AV	54.00	-2.40	1.37 H	18	9.08	42.52
ANTENNA POLARITY & TEST DISTANCE: VERTICAL AT 3 M								
NO.	FREQ. (MHz)	EMISSION LEVEL (dBuV/m)	LIMIT (dBuV/m)	MARGIN (dB)	ANTENNA HEIGHT (m)	TABLE ANGLE (Degree)	RAW VALUE (dBuV)	CORRECTION FACTOR (dB/m)
1	*2437.00	110.40 PK			1.21 V	26	79.79	30.61
2	*2437.00	105.50 AV			1.21 V	26	74.89	30.61
3	4874.00	51.40 PK	74.00	-22.60	1.31 V	197	15.60	35.80
4	4874.00	46.20 AV	54.00	-7.80	1.31 V	197	10.40	35.80
5	#7236.00	60.30 PK	90.40	-30.10	1.17 V	347	18.06	42.24
6	#7236.00	53.00 AV	85.50	-32.50	1.17 V	347	10.76	42.24

- REMARKS:**
1. Emission level (dBuV/m) = Raw Value (dBuV) + Correction Factor (dB/m).
  2. Correction Factor (dB/m) = Antenna Factor (dB/m) + Cable Factor (dB).
  3. The other emission levels were very low against the limit.
  4. Margin value = Emission level – Limit value.
  5. “ \* “: Fundamental frequency.
  6. “#”:The radiated frequency is out the restricted band.

EUT TEST CONDITION		MEASUREMENT DETAIL	
CHANNEL	Channel 11	FREQUENCY RANGE	1 ~ 25GHz
INPUT POWER (SYSTEM)	120Vac, 60 Hz	DETECTOR FUNCTION	Peak (PK) Average (AV)
ENVIRONMENTAL CONDITIONS	25deg. C, 64%RH 972hPa	TESTED BY	Frank Liu

ANTENNA POLARITY & TEST DISTANCE: HORIZONTAL AT 3 M								
NO.	FREQ. (MHz)	EMISSION LEVEL (dBuV/m)	LIMIT (dBuV/m)	MARGIN (dB)	ANTENNA HEIGHT (m)	TABLE ANGLE (Degree)	RAW VALUE (dBuV)	CORRECTION FACTOR (dB/m)
1	*2462.00	102.20 PK			1.47 H	25	71.48	30.72
2	*2462.00	97.00 AV			1.47 H	25	66.28	30.72
3	2487.20	56.03 PK	74.00	-17.97	1.47 H	25	25.20	30.83
4	2487.20	44.21 AV	54.00	-9.79	1.47 H	25	13.38	30.83
5	4924.00	47.10 PK	74.00	-26.90	1.51 H	354	11.20	35.90
6	4924.00	35.60 AV	54.00	-18.40	1.51 H	354	-0.30	35.90
7	7386.00	58.40 PK	74.00	-15.60	2.02 H	4	15.60	42.80
8	7386.00	50.40 AV	54.00	-3.60	2.02 H	4	7.60	42.80
ANTENNA POLARITY & TEST DISTANCE: VERTICAL AT 3 M								
NO.	FREQ. (MHz)	EMISSION LEVEL (dBuV/m)	LIMIT (dBuV/m)	MARGIN (dB)	ANTENNA HEIGHT (m)	TABLE ANGLE (Degree)	RAW VALUE (dBuV)	CORRECTION FACTOR (dB/m)
1	*2462.00	111.60 PK			1.00 V	25	80.88	30.72
2	*2462.00	106.80 AV			1.00 V	25	76.08	30.72
3	2487.00	59.42 PK	74.00	-14.58	1.00 V	354	28.59	30.83
4	2487.00	50.35 AV	54.00	-3.65	1.00 V	354	19.52	30.83
5	4924.00	52.00 PK	74.00	-22.00	1.28 V	205	16.10	35.90
6	4924.00	45.60 AV	54.00	-8.40	1.28 V	205	9.70	35.90
7	7386.00	60.10 PK	74.00	-13.90	1.06 V	3	17.30	42.80
8	7386.00	52.45 AV	54.00	-1.55	1.06 V	3	9.65	42.80

- REMARKS:**
1. Emission level (dBuV/m) = Raw Value (dBuV) + Correction Factor (dB/m).
  2. Correction Factor (dB/m) = Antenna Factor (dB/m) + Cable Factor (dB).
  3. The other emission levels were very low against the limit.
  4. Margin value = Emission level – Limit value.
  5. “ \* “: Fundamental frequency.

RESTRICTED BANDEDGE (802.11b MODE, CH1, HORIZONTAL )

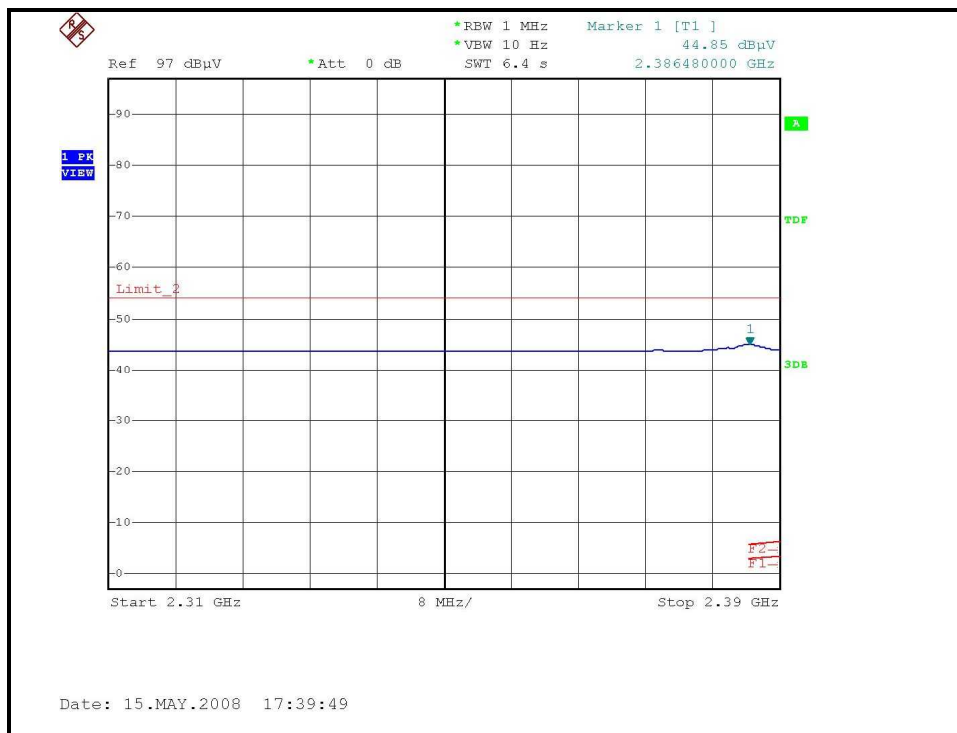
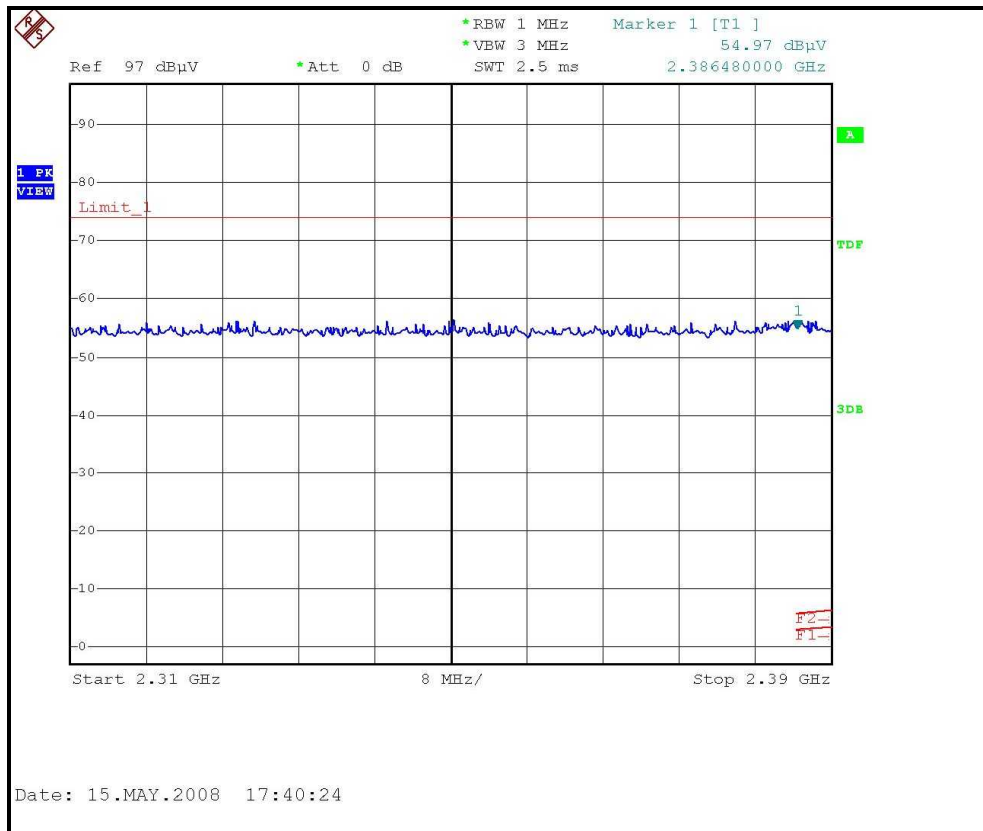







### 802.11g OFDM MODULATION

EUT TEST CONDITION		MEASUREMENT DETAIL	
CHANNEL	Channel 1	FREQUENCY RANGE	1 ~ 25GHz
INPUT POWER (SYSTEM)	120Vac, 60 Hz	DETECTOR FUNCTION	Peak (PK) Average (AV)
ENVIRONMENTAL CONDITIONS	25deg. C, 64%RH 972hPa	TESTED BY	Frank Liu

ANTENNA POLARITY & TEST DISTANCE: HORIZONTAL AT 3 M								
NO.	FREQ. (MHz)	EMISSION LEVEL (dBuV/m)	LIMIT (dBuV/m)	MARGIN (dB)	ANTENNA HEIGHT (m)	TABLE ANGLE (Degree)	RAW VALUE (dBuV)	CORRECTION FACTOR (dB/m)
1	2390.00	58.10 PK	74.00	-15.90	1.48 H	24	27.70	30.40
2	2390.00	45.30 AV	54.00	-8.70	1.48 H	24	14.90	30.40
3	*2412.00	99.10 PK			1.48 H	24	68.61	30.49
4	*2412.00	88.65 AV			1.48 H	24	58.16	30.49
5	4824.00	47.60 PK	74.00	-26.40	2.02 H	15	11.91	35.69
6	4824.00	33.10 AV	54.00	-20.90	2.02 H	15	-2.59	35.69
7	#7236.00	63.10 PK	79.10	-16.00	1.31 H	9	20.86	42.24
8	#7236.00	47.60 AV	68.65	-21.05	1.31 H	9	5.36	42.24
ANTENNA POLARITY & TEST DISTANCE: VERTICAL AT 3 M								
NO.	FREQ. (MHz)	EMISSION LEVEL (dBuV/m)	LIMIT (dBuV/m)	MARGIN (dB)	ANTENNA HEIGHT (m)	TABLE ANGLE (Degree)	RAW VALUE (dBuV)	CORRECTION FACTOR (dB/m)
1	2390.00	67.42 PK	74.00	-6.58	1.00 V	24	37.02	30.40
2	2390.00	52.57 AV	54.00	-1.43	1.00 V	24	22.17	30.40
3	*2412.00	110.80 PK			1.00 V	27	80.31	30.49
4	*2412.00	100.20 AV			1.00 V	27	69.71	30.49
5	4824.00	49.30 PK	74.00	-24.70	1.36 V	205	13.61	35.69
6	4824.00	36.50 AV	54.00	-17.50	1.36 V	205	0.81	35.69
7	#7235.00	65.00 PK	90.80	-25.80	1.29 V	69	22.77	42.23
8	#7235.00	49.30 AV	80.20	-30.90	1.29 V	69	7.07	42.23

- REMARKS:**
1. Emission level (dBuV/m) = Raw Value (dBuV) + Correction Factor (dB/m).
  2. Correction Factor (dB/m) = Antenna Factor (dB/m) + Cable Factor (dB).
  3. The other emission levels were very low against the limit.
  4. Margin value = Emission level – Limit value.
  5. “ \* “: Fundamental frequency.
  6. “#”:The radiated frequency is out the restricted band.



EUT TEST CONDITION		MEASUREMENT DETAIL	
CHANNEL	Channel 6	FREQUENCY RANGE	1 ~ 25GHz
INPUT POWER (SYSTEM)	120Vac, 60 Hz	DETECTOR FUNCTION	Peak (PK) Average (AV)
ENVIRONMENTAL CONDITIONS	25deg. C, 64%RH 972hPa	TESTED BY	Frank Liu

ANTENNA POLARITY & TEST DISTANCE: HORIZONTAL AT 3 M								
NO.	FREQ. (MHz)	EMISSION LEVEL (dBuV/m)	LIMIT (dBuV/m)	MARGIN (dB)	ANTENNA HEIGHT (m)	TABLE ANGLE (Degree)	RAW VALUE (dBuV)	CORRECTION FACTOR (dB/m)
1	*2437.00	101.40 PK			1.48 H	26	70.79	30.61
2	*2437.00	89.72 AV			1.48 H	26	59.11	30.61
3	4874.00	48.90 PK	74.00	-25.10	1.49 H	344	13.10	35.80
4	4874.00	35.60 AV	54.00	-18.40	1.49 H	344	-0.20	35.80
5	7311.00	64.40 PK	74.00	-9.60	1.36 H	15	21.88	42.52
6	7311.00	48.10 AV	54.00	-5.90	1.36 H	15	5.58	42.52
ANTENNA POLARITY & TEST DISTANCE: VERTICAL AT 3 M								
NO.	FREQ. (MHz)	EMISSION LEVEL (dBuV/m)	LIMIT (dBuV/m)	MARGIN (dB)	ANTENNA HEIGHT (m)	TABLE ANGLE (Degree)	RAW VALUE (dBuV)	CORRECTION FACTOR (dB/m)
1	*2437.00	112.00 PK			1.00 V	78	81.39	30.61
2	*2437.00	101.50 AV			1.00 V	78	70.89	30.61
3	4874.00	48.70 PK	74.00	-25.30	1.50 V	119	12.90	35.80
4	4874.00	35.30 AV	54.00	-18.70	1.50 V	119	-0.50	35.80
5	7311.00	65.20 PK	74.00	-8.80	1.48 V	83	22.68	42.52
6	7311.00	49.70 AV	54.00	-4.30	1.48 V	83	7.18	42.52

- REMARKS:**
1. Emission level (dBuV/m) = Raw Value (dBuV) + Correction Factor (dB/m).
  2. Correction Factor (dB/m) = Antenna Factor (dB/m) + Cable Factor (dB).
  3. The other emission levels were very low against the limit.
  4. Margin value = Emission level – Limit value.
  5. “ \* “: Fundamental frequency.

EUT TEST CONDITION		MEASUREMENT DETAIL	
CHANNEL	Channel 11	FREQUENCY RANGE	1 ~ 25GHz
INPUT POWER (SYSTEM)	120Vac, 60 Hz	DETECTOR FUNCTION	Peak (PK) Average (AV)
ENVIRONMENTAL CONDITIONS	25deg. C, 64%RH 972hPa	TESTED BY	Frank Liu

ANTENNA POLARITY & TEST DISTANCE: HORIZONTAL AT 3 M								
NO.	FREQ. (MHz)	EMISSION LEVEL (dBuV/m)	LIMIT (dBuV/m)	MARGIN (dB)	ANTENNA HEIGHT (m)	TABLE ANGLE (Degree)	RAW VALUE (dBuV)	CORRECTION FACTOR (dB/m)
1	*2462.00	100.80 PK			1.47 H	25	70.08	30.72
2	*2462.00	89.80 AV			1.47 H	25	59.08	30.72
3	2483.50	57.12 PK	74.00	-16.88	1.47 H	26	26.30	30.82
4	2483.50	45.42 AV	54.00	-8.58	1.47 H	26	14.60	30.82
5	4924.00	46.30 PK	74.00	-27.70	1.53 H	114	10.40	35.90
6	4924.00	32.40 AV	54.00	-21.60	1.53 H	114	-3.50	35.90
7	7386.00	59.30 PK	74.00	-14.70	2.10 H	9	16.50	42.80
8	7386.00	43.20 AV	54.00	-10.80	2.10 H	9	0.40	42.80
ANTENNA POLARITY & TEST DISTANCE: VERTICAL AT 3 M								
NO.	FREQ. (MHz)	EMISSION LEVEL (dBuV/m)	LIMIT (dBuV/m)	MARGIN (dB)	ANTENNA HEIGHT (m)	TABLE ANGLE (Degree)	RAW VALUE (dBuV)	CORRECTION FACTOR (dB/m)
1	*2462.00	111.30 PK			1.00 V	26	80.58	30.72
2	*2462.00	100.78 AV			1.00 V	26	70.06	30.72
3	2483.50	68.49 PK	74.00	-5.51	1.00 V	78	37.67	30.82
4	2483.50	53.01 AV	54.00	-0.99	1.00 V	78	22.19	30.82
5	4924.00	48.90 PK	74.00	-25.10	1.46 V	188	13.00	35.90
6	4924.00	34.80 AV	54.00	-19.20	1.46 V	188	-1.10	35.90
7	7386.00	61.70 PK	74.00	-12.30	1.36 V	74	18.90	42.80
8	7386.00	45.60 AV	54.00	-8.40	1.36 V	74	2.80	42.80

- REMARKS:**
1. Emission level (dBuV/m) = Raw Value (dBuV) + Correction Factor (dB/m).
  2. Correction Factor (dB/m) = Antenna Factor (dB/m) + Cable Factor (dB).
  3. The other emission levels were very low against the limit.
  4. Margin value = Emission level – Limit value.
  5. “ \* ”: Fundamental frequency.

RESTRICTED BANDEDGE (802.11g MODE,CH1, HORIZONTAL )

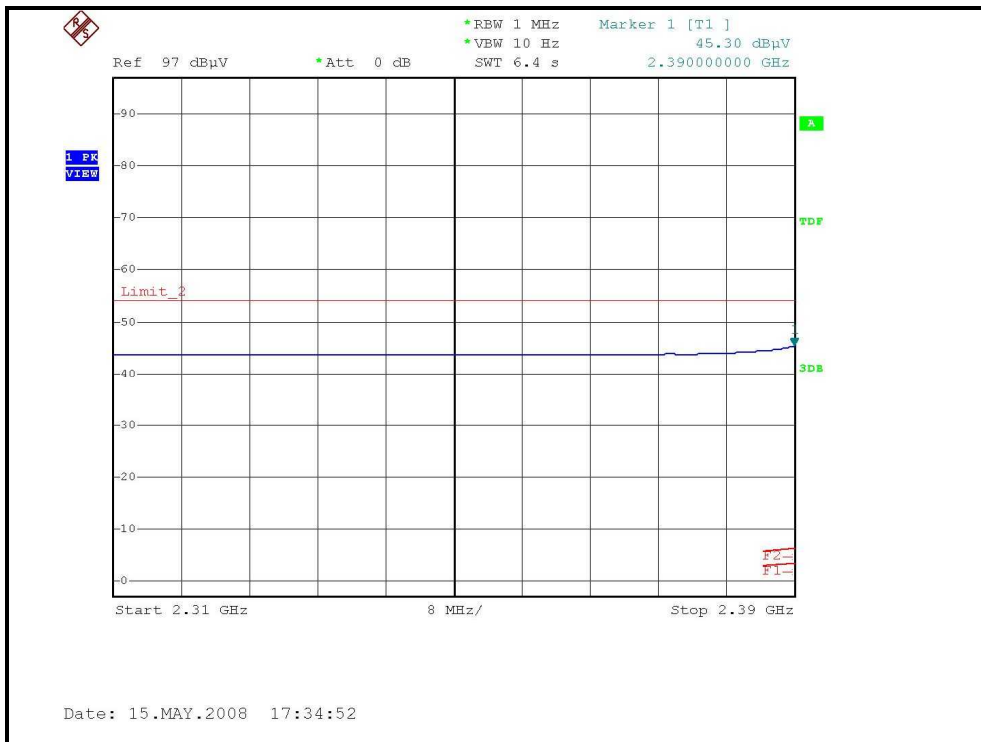
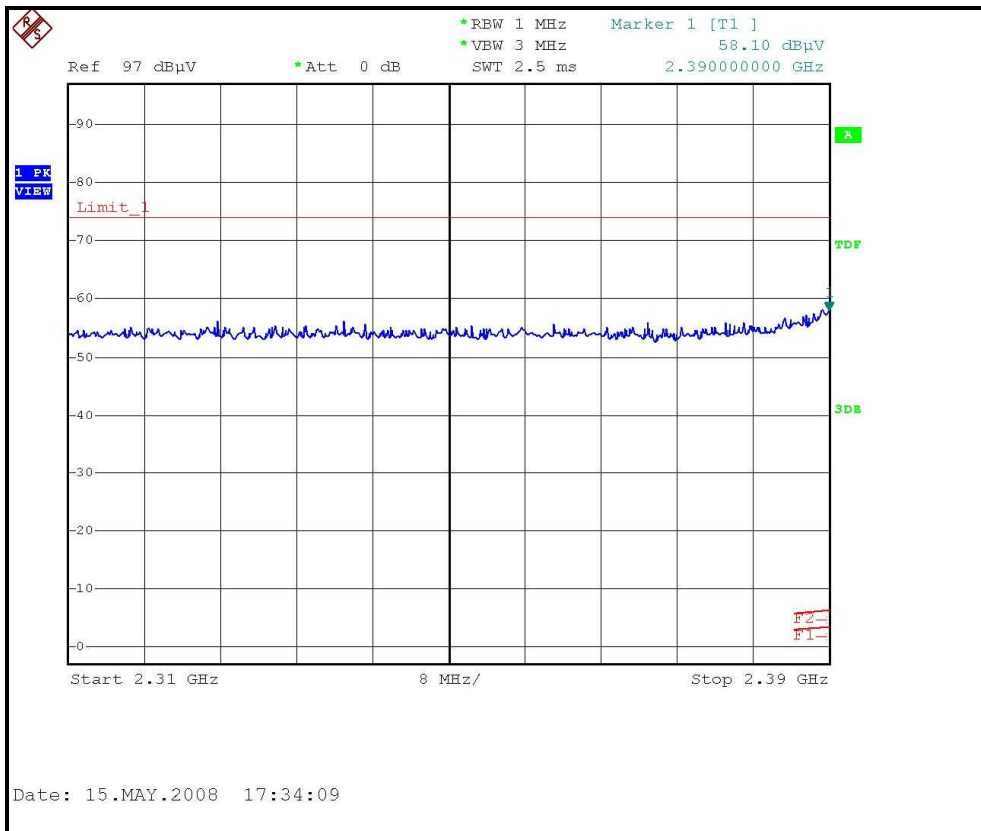

RESTRICTED BANDEDGE (802.11g MODE, CH1, VERTICAL )

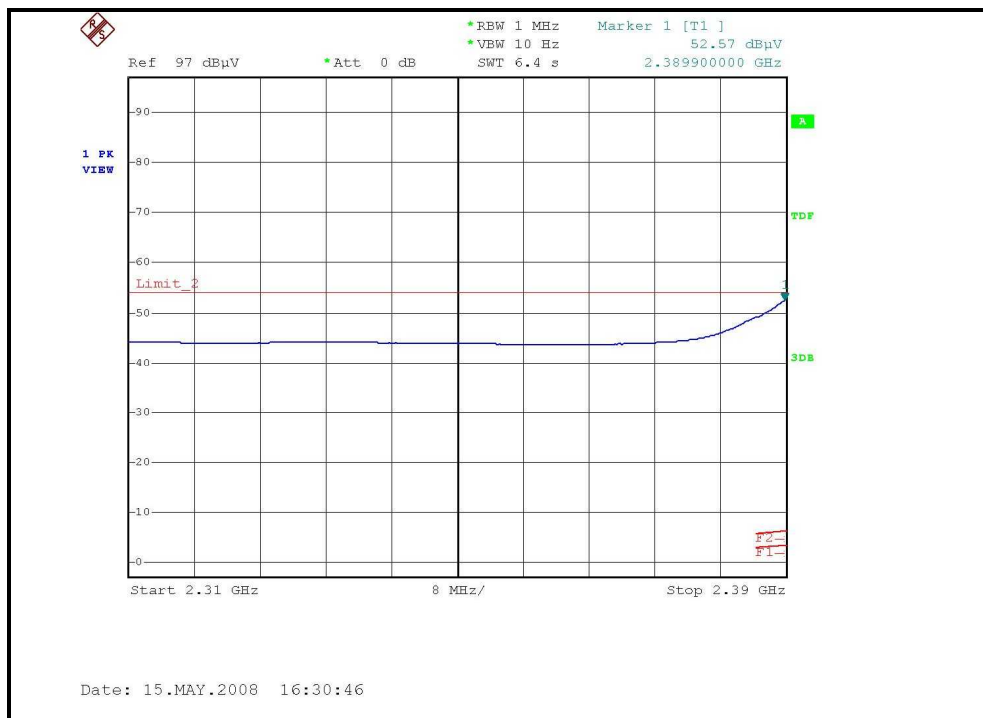
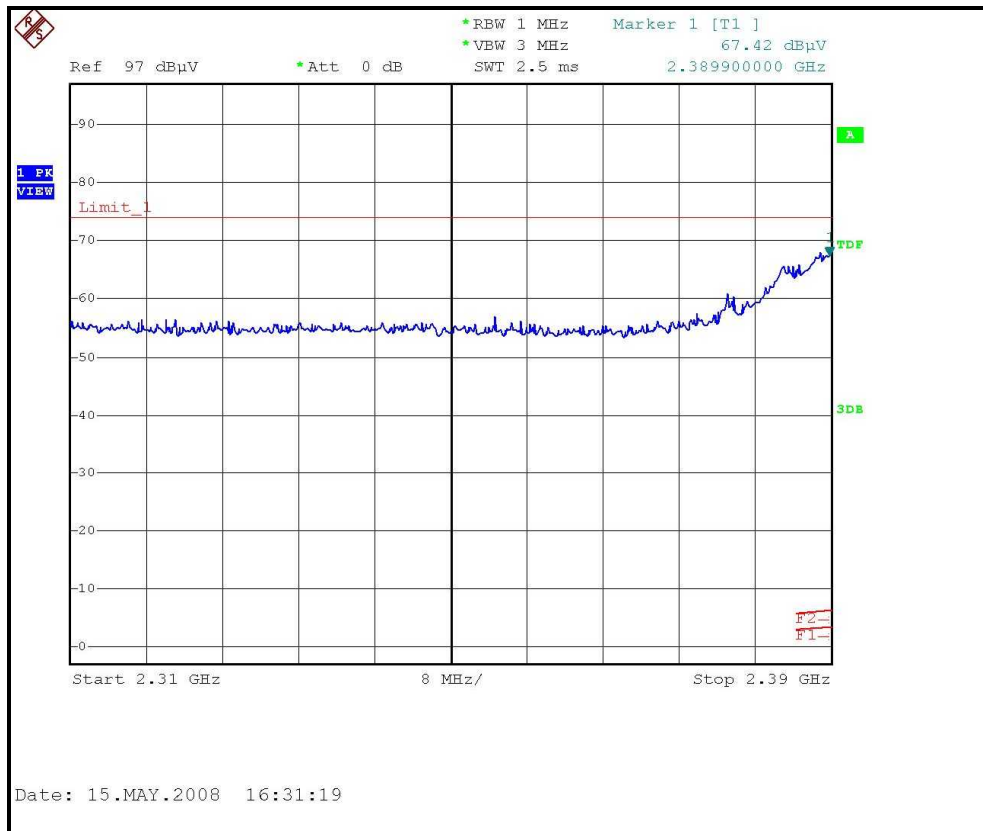

**RESTRICTED BANDEDGE (802.11g MODE, CH11, HORIZONTAL )**

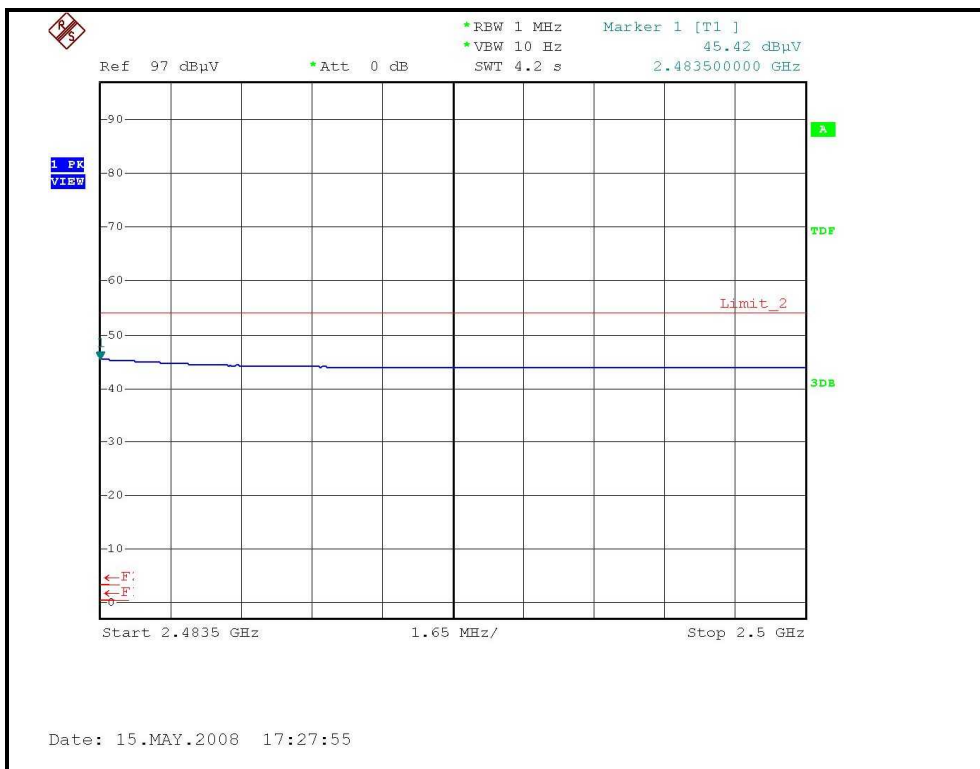
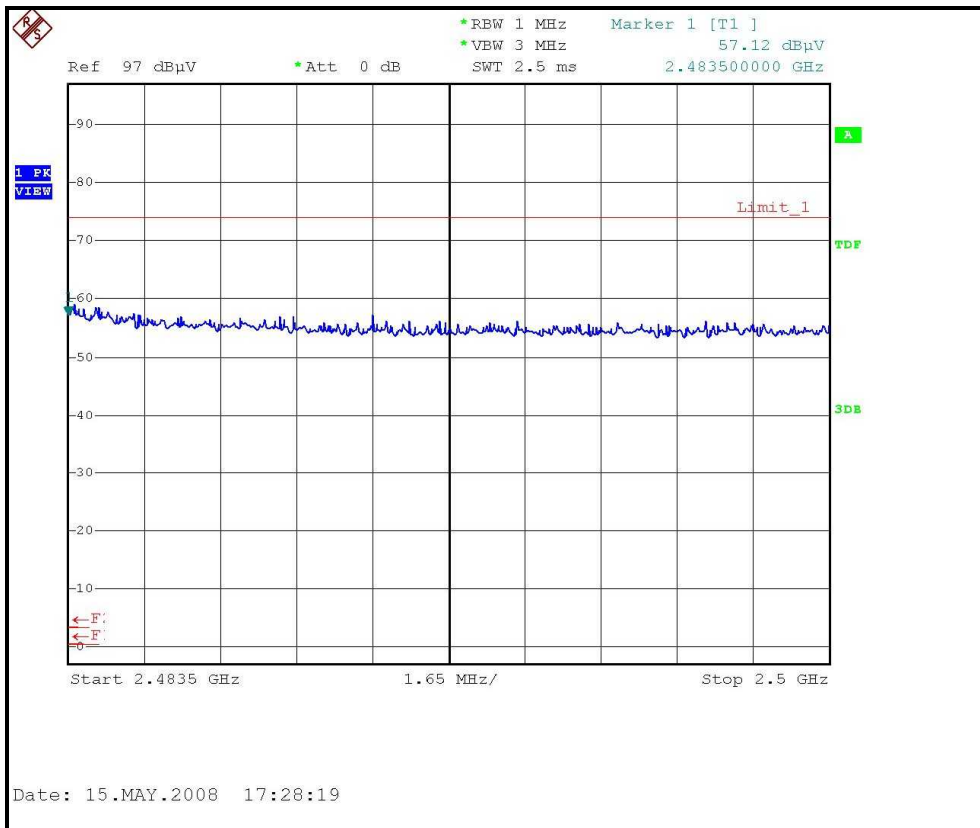

RESTRICTED BANDEDGE (802.11g MODE, CH11, VERTICAL )

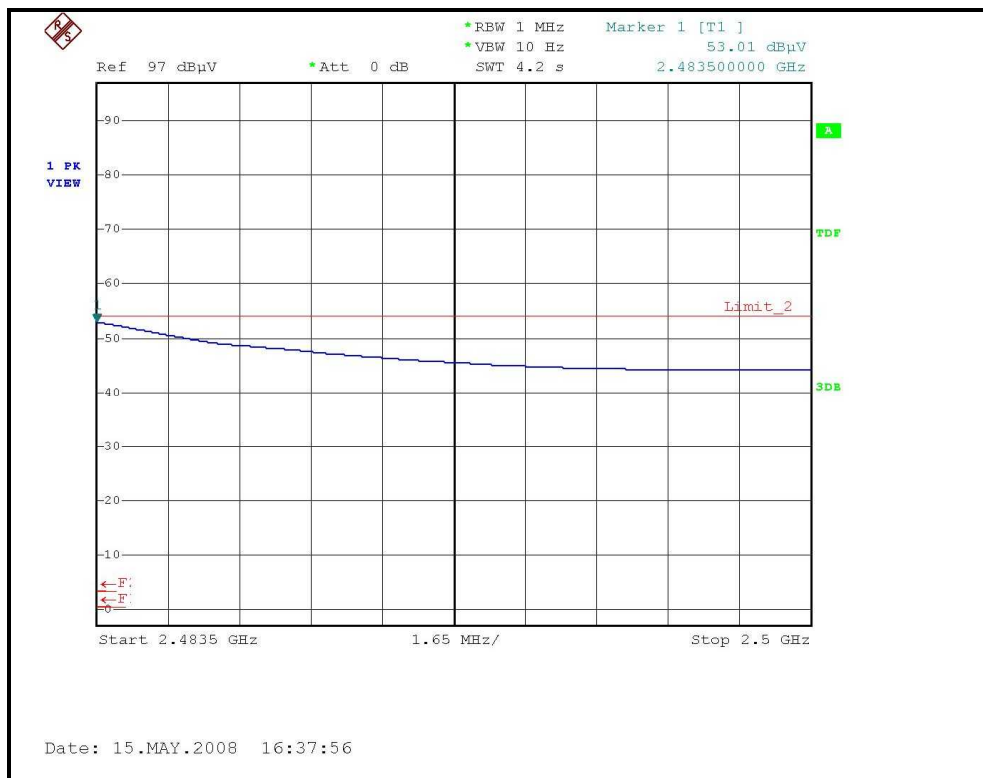
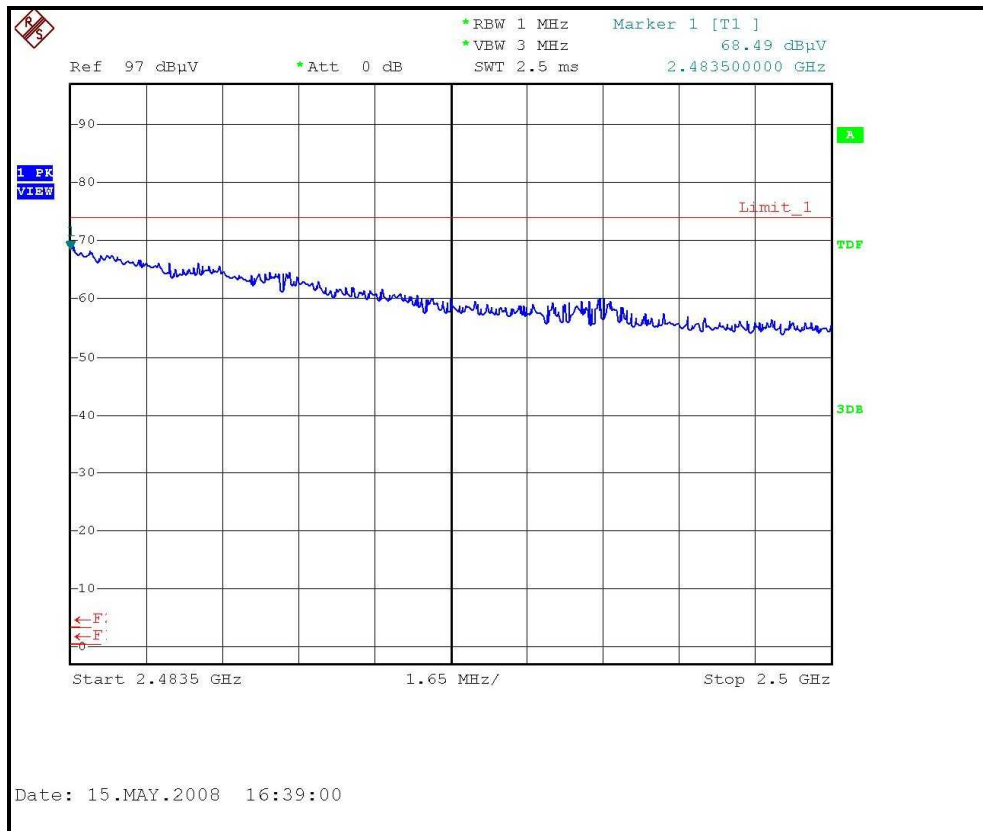

**DRAFT 802.11n (20MHz) OFDM MODULATION**

EUT TEST CONDITION		MEASUREMENT DETAIL	
CHANNEL	Channel 1	FREQUENCY RANGE	1 ~ 25GHz
INPUT POWER (SYSTEM)	120Vac, 60 Hz	DETECTOR FUNCTION	Peak (PK) Average (AV)
ENVIRONMENTAL CONDITIONS	25deg. C, 64%RH 972hPa	TESTED BY	Frank Liu

ANTENNA POLARITY & TEST DISTANCE: HORIZONTAL AT 3 M								
NO.	FREQ. (MHz)	EMISSION LEVEL (dBuV/m)	LIMIT (dBuV/m)	MARGIN (dB)	ANTENNA HEIGHT (m)	TABLE ANGLE (Degree)	RAW VALUE (dBuV)	CORRECTION FACTOR (dB/m)
1	2390.00	59.06 PK	74.00	-14.94	1.48 H	24	28.66	30.40
2	2390.00	45.10 AV	54.00	-8.90	1.48 H	24	14.70	30.40
3	*2412.00	99.10 PK			1.48 H	24	68.61	30.49
4	*2412.00	88.90 AV			1.48 H	24	58.41	30.49
5	4824.00	46.30 PK	74.00	-27.70	2.14 H	3	10.61	35.69
6	4824.00	34.00 AV	54.00	-20.00	2.14 H	3	-1.69	35.69
7	#7236.00	60.10 PK	79.10	-19.00	1.24 H	44	17.86	42.24
8	#7236.00	43.90 AV	68.90	-25.00	1.24 H	44	1.66	42.24
ANTENNA POLARITY & TEST DISTANCE: VERTICAL AT 3 M								
NO.	FREQ. (MHz)	EMISSION LEVEL (dBuV/m)	LIMIT (dBuV/m)	MARGIN (dB)	ANTENNA HEIGHT (m)	TABLE ANGLE (Degree)	RAW VALUE (dBuV)	CORRECTION FACTOR (dB/m)
1	2390.00	69.08 PK	74.00	-4.92	1.00 V	25	38.68	30.40
2	2390.00	52.96 AV	54.00	-1.04	1.00 V	25	22.56	30.40
3	*2412.00	110.40 PK			1.00 V	79	79.91	30.49
4	*2412.00	99.40 AV			1.00 V	79	68.91	30.49
5	4824.00	48.60 PK	74.00	-25.40	1.39 V	79	12.91	35.69
6	4824.00	36.20 AV	54.00	-17.80	1.39 V	79	0.51	35.69
7	7236.00	62.50 PK	74.00	-11.50	1.29 V	69	20.26	42.24
8	7236.00	46.76 AV	54.00	-7.24	1.29 V	69	4.52	42.24

- REMARKS:**
1. Emission level (dBuV/m) = Raw Value (dBuV) + Correction Factor (dB/m).
  2. Correction Factor (dB/m) = Antenna Factor (dB/m) + Cable Factor (dB).
  3. The other emission levels were very low against the limit.
  4. Margin value = Emission level – Limit value.
  5. “ \* “: Fundamental frequency.



EUT TEST CONDITION		MEASUREMENT DETAIL	
CHANNEL	Channel 6	FREQUENCY RANGE	1 ~ 25GHz
INPUT POWER (SYSTEM)	120Vac, 60 Hz	DETECTOR FUNCTION	Peak (PK) Average (AV)
ENVIRONMENTAL CONDITIONS	25deg. C, 64%RH 972hPa	TESTED BY	Frank Liu

ANTENNA POLARITY & TEST DISTANCE: HORIZONTAL AT 3 M								
NO.	FREQ. (MHz)	EMISSION LEVEL (dBuV/m)	LIMIT (dBuV/m)	MARGIN (dB)	ANTENNA HEIGHT (m)	TABLE ANGLE (Degree)	RAW VALUE (dBuV)	CORRECTION FACTOR (dB/m)
1	*2437.00	101.00 PK			1.49 H	29	70.39	30.61
2	*2437.00	90.00 AV			1.49 H	29	59.39	30.61
3	4874.00	46.90 PK	74.00	-27.10	1.78 H	334	11.10	35.80
4	4874.00	33.60 AV	54.00	-20.40	1.78 H	334	-2.20	35.80
5	7311.00	63.40 PK	74.00	-10.60	1.24 H	37	20.88	42.52
6	7311.00	46.80 AV	54.00	-7.20	1.24 H	37	4.28	42.52
ANTENNA POLARITY & TEST DISTANCE: VERTICAL AT 3 M								
NO.	FREQ. (MHz)	EMISSION LEVEL (dBuV/m)	LIMIT (dBuV/m)	MARGIN (dB)	ANTENNA HEIGHT (m)	TABLE ANGLE (Degree)	RAW VALUE (dBuV)	CORRECTION FACTOR (dB/m)
1	*2437.00	112.00 PK			1.00 V	79	81.39	30.61
2	*2437.00	101.00 AV			1.00 V	79	70.39	30.61
3	4874.00	48.40 PK	74.00	-25.60	1.37 V	120	12.60	35.80
4	4874.00	34.80 AV	54.00	-19.20	1.37 V	120	-1.00	35.80
5	7311.00	65.30 PK	74.00	-8.70	1.26 V	69	22.78	42.52
6	7311.00	49.40 AV	54.00	-4.60	1.26 V	69	6.88	42.52

- REMARKS:**
1. Emission level (dBuV/m) = Raw Value (dBuV) + Correction Factor (dB/m).
  2. Correction Factor (dB/m) = Antenna Factor (dB/m) + Cable Factor (dB).
  3. The other emission levels were very low against the limit.
  4. Margin value = Emission level – Limit value.
  5. “ \* “: Fundamental frequency.



EUT TEST CONDITION		MEASUREMENT DETAIL	
CHANNEL	Channel 11	FREQUENCY RANGE	1 ~ 25GHz
INPUT POWER (SYSTEM)	120Vac, 60 Hz	DETECTOR FUNCTION	Peak (PK) Average (AV)
ENVIRONMENTAL CONDITIONS	25deg. C, 64%RH 972hPa	TESTED BY	Frank Liu

ANTENNA POLARITY & TEST DISTANCE: HORIZONTAL AT 3 M								
NO.	FREQ. (MHz)	EMISSION LEVEL (dBuV/m)	LIMIT (dBuV/m)	MARGIN (dB)	ANTENNA HEIGHT (m)	TABLE ANGLE (Degree)	RAW VALUE (dBuV)	CORRECTION FACTOR (dB/m)
1	*2462.00	100.00 PK			1.47 H	26	69.28	30.72
2	*2462.00	88.40 AV			1.47 H	26	57.68	30.72
3	2483.50	57.08 PK	74.00	-16.92	1.47 H	26	26.26	30.82
4	2483.50	45.42 AV	54.00	-8.58	1.47 H	26	14.60	30.82
5	4924.00	46.10 PK	74.00	-27.90	1.54 H	33	10.20	35.90
6	4924.00	33.10 AV	54.00	-20.90	1.54 H	33	-2.80	35.90
7	7386.00	58.70 PK	74.00	-15.30	1.29 H	51	15.90	42.80
8	7386.00	42.60 AV	54.00	-11.40	1.29 H	51	-0.20	42.80
ANTENNA POLARITY & TEST DISTANCE: VERTICAL AT 3 M								
NO.	FREQ. (MHz)	EMISSION LEVEL (dBuV/m)	LIMIT (dBuV/m)	MARGIN (dB)	ANTENNA HEIGHT (m)	TABLE ANGLE (Degree)	RAW VALUE (dBuV)	CORRECTION FACTOR (dB/m)
1	*2462.00	109.50 PK			1.00 V	79	78.78	30.72
2	*2462.00	98.60 AV			1.00 V	79	67.88	30.72
3	2483.50	69.28 PK	74.00	-4.72	1.00 V	78	38.46	30.82
4	2483.50	52.34 AV	54.00	-1.66	1.00 V	78	21.52	30.82
5	4924.00	47.10 PK	74.00	-26.90	1.60 V	199	11.20	35.90
6	4924.00	34.00 AV	54.00	-20.00	1.60 V	199	-1.90	35.90
7	7386.00	60.80 PK	74.00	-13.20	1.46 V	89	18.00	42.80
8	7386.00	43.80 AV	54.00	-10.20	1.46 V	89	1.00	42.80

- REMARKS:**
1. Emission level (dBuV/m) = Raw Value (dBuV) + Correction Factor (dB/m).
  2. Correction Factor (dB/m) = Antenna Factor (dB/m) + Cable Factor (dB).
  3. The other emission levels were very low against the limit.
  4. Margin value = Emission level – Limit value.
  5. “ \* “: Fundamental frequency.



RESTRICTED BANDEDGE (DRAFT 802.11n (20MHz) MODE,CH1, VERTICAL )

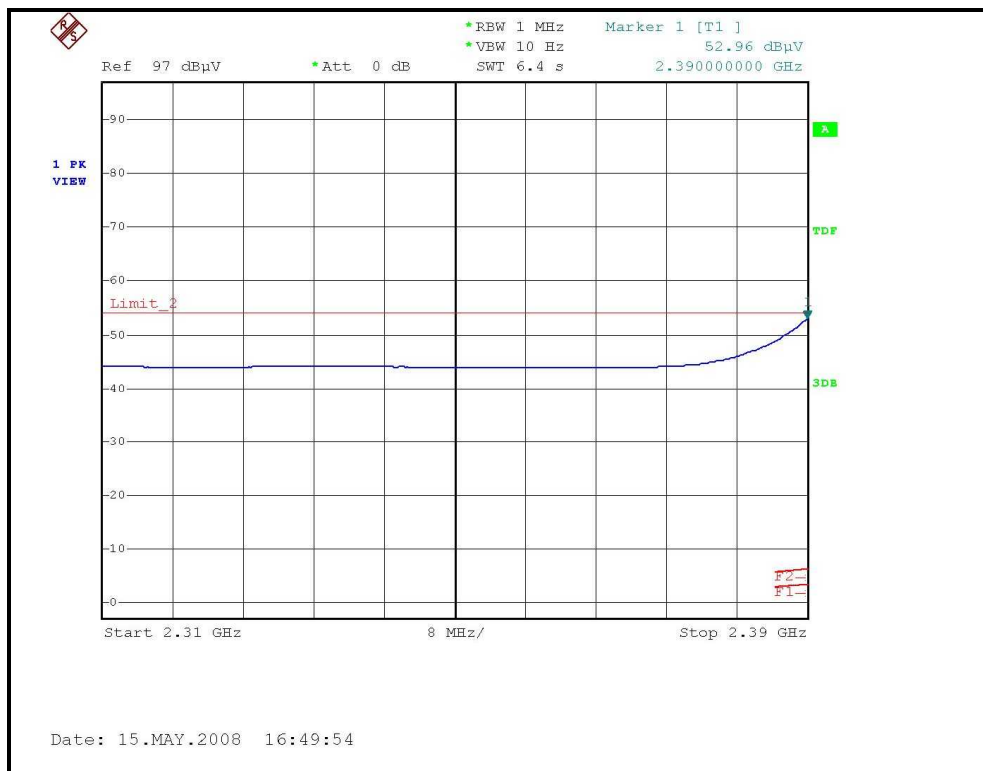
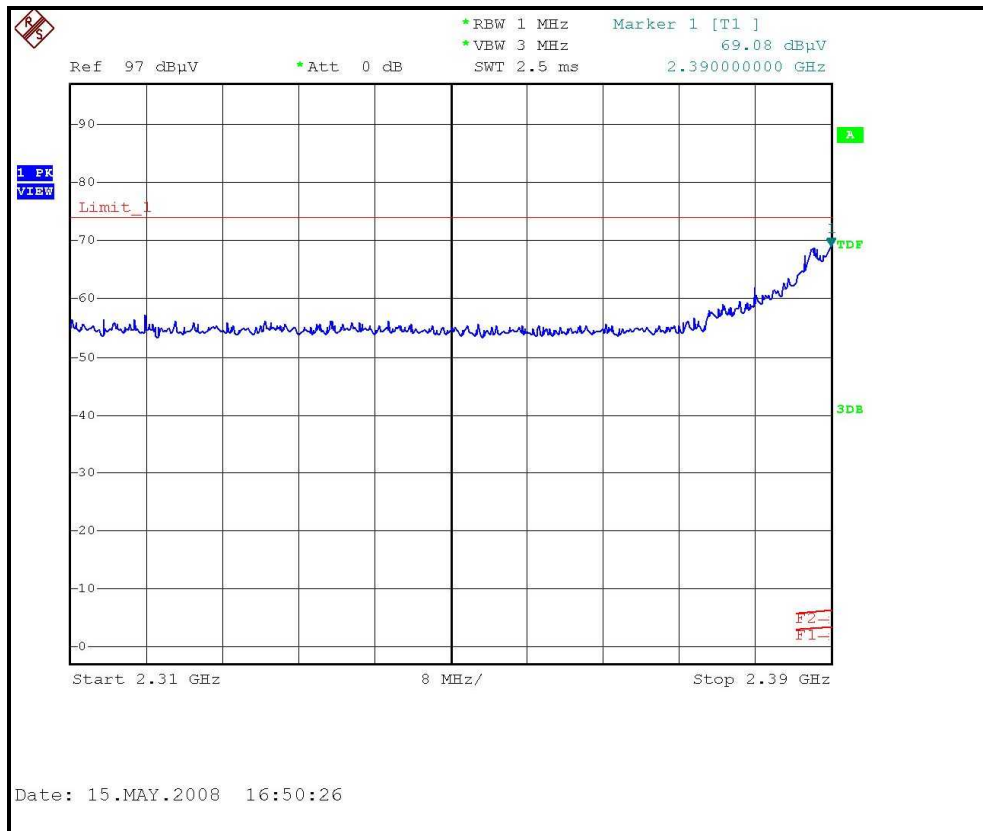

RESTRICTED BANDEDGE (DRAFT 802.11n (20MHz) MODE, CH11, HORIZONTAL )

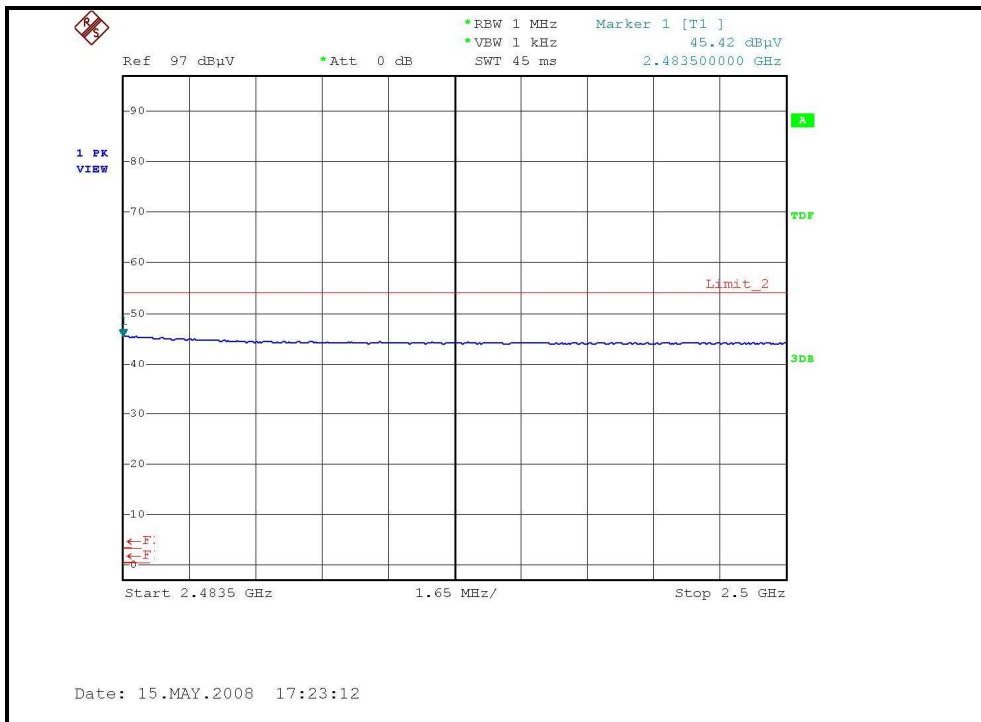
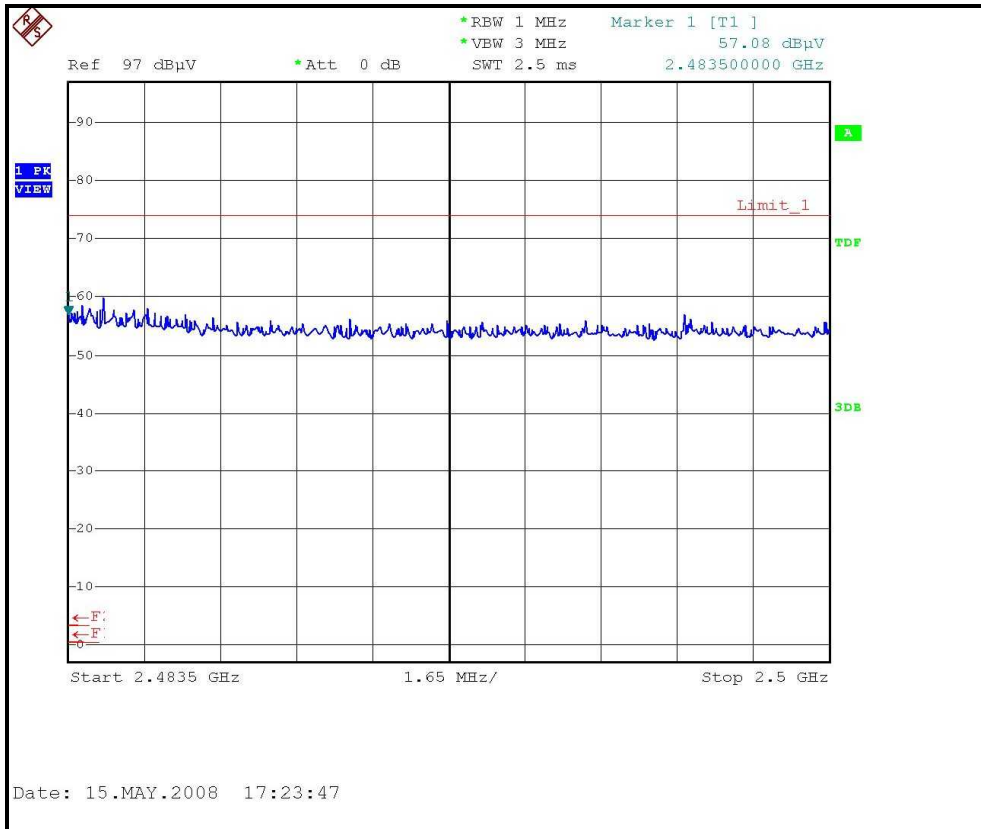



### DRAFT 802.11n (40MHz) OFDM MODULATION

EUT TEST CONDITION		MEASUREMENT DETAIL	
CHANNEL	Channel 1	FREQUENCY RANGE	1 ~ 25GHz
INPUT POWER (SYSTEM)	120Vac, 60 Hz	DETECTOR FUNCTION	Peak (PK) Average (AV)
ENVIRONMENTAL CONDITIONS	25deg. C, 64%RH 972hPa	TESTED BY	Frank Liu

ANTENNA POLARITY & TEST DISTANCE: HORIZONTAL AT 3 M								
NO.	FREQ. (MHz)	EMISSION LEVEL (dBuV/m)	LIMIT (dBuV/m)	MARGIN (dB)	ANTENNA HEIGHT (m)	TABLE ANGLE (Degree)	RAW VALUE (dBuV)	CORRECTION FACTOR (dB/m)
1	2390.00	57.06 PK	74.00	-16.94	1.48 H	25	26.66	30.40
2	2390.00	45.01 AV	54.00	-8.99	1.48 H	25	14.61	30.40
3	*2422.00	95.80 PK			1.48 H	24	65.26	30.54
4	*2422.00	83.90 AV			1.48 H	24	53.36	30.54
5	4844.00	46.60 PK	74.00	-27.40	2.01 H	12	10.86	35.74
6	4844.00	32.10 AV	54.00	-21.90	2.01 H	12	-3.64	35.74
7	7236.00	52.30 PK	74.00	-21.70	1.24 H	19	10.06	42.24
8	7236.00	38.60 AV	54.00	-15.40	1.24 H	19	-3.64	42.24
ANTENNA POLARITY & TEST DISTANCE: VERTICAL AT 3 M								
NO.	FREQ. (MHz)	EMISSION LEVEL (dBuV/m)	LIMIT (dBuV/m)	MARGIN (dB)	ANTENNA HEIGHT (m)	TABLE ANGLE (Degree)	RAW VALUE (dBuV)	CORRECTION FACTOR (dB/m)
1	2390.00	66.19 PK	74.00	-7.81	1.00 V	25	35.79	30.40
2	2390.00	52.94 AV	54.00	-1.06	1.00 V	25	22.54	30.40
3	*2422.00	104.60 PK			1.00 V	79	74.06	30.54
4	*2422.00	93.70 AV			1.00 V	79	63.16	30.54
5	4844.00	47.90 PK	74.00	-26.10	1.43 V	68	12.16	35.74
6	4844.00	32.40 AV	54.00	-21.60	1.43 V	68	-3.34	35.74
7	7266.00	54.30 PK	74.00	-19.70	1.28 V	68	11.95	42.35
8	7266.00	39.50 AV	54.00	-14.50	1.28 V	68	-2.85	42.35

- REMARKS:**
1. Emission level (dBuV/m) = Raw Value (dBuV) + Correction Factor (dB/m).
  2. Correction Factor (dB/m) = Antenna Factor (dB/m) + Cable Factor (dB).
  3. The other emission levels were very low against the limit.
  4. Margin value = Emission level – Limit value.
  5. “ \* “: Fundamental frequency.

EUT TEST CONDITION		MEASUREMENT DETAIL	
CHANNEL	Channel 4	FREQUENCY RANGE	1 ~ 25GHz
INPUT POWER (SYSTEM)	120Vac, 60 Hz	DETECTOR FUNCTION	Peak (PK) Average (AV)
ENVIRONMENTAL CONDITIONS	25deg. C, 64%RH 972hPa	TESTED BY	Frank Liu

ANTENNA POLARITY & TEST DISTANCE: HORIZONTAL AT 3 M								
NO.	FREQ. (MHz)	EMISSION LEVEL (dBuV/m)	LIMIT (dBuV/m)	MARGIN (dB)	ANTENNA HEIGHT (m)	TABLE ANGLE (Degree)	RAW VALUE (dBuV)	CORRECTION FACTOR (dB/m)
1	*2437.00	97.60 PK			1.44 H	29	66.99	30.61
2	*2437.00	85.80 AV			1.44 H	29	55.19	30.61
3	2483.50	61.40 PK	74.00	-12.60	1.44 H	27	30.58	30.82
4	2483.50	46.30 AV	54.00	-7.70	1.44 H	27	15.48	30.82
5	4874.00	48.20 PK	74.00	-25.80	2.00 H	16	12.40	35.80
6	4874.00	34.30 AV	54.00	-19.70	2.00 H	16	-1.50	35.80
7	7311.00	54.60 PK	74.00	-19.40	1.44 H	23	12.08	42.52
8	7311.00	40.10 AV	54.00	-13.90	1.44 H	23	-2.42	42.52
ANTENNA POLARITY & TEST DISTANCE: VERTICAL AT 3 M								
NO.	FREQ. (MHz)	EMISSION LEVEL (dBuV/m)	LIMIT (dBuV/m)	MARGIN (dB)	ANTENNA HEIGHT (m)	TABLE ANGLE (Degree)	RAW VALUE (dBuV)	CORRECTION FACTOR (dB/m)
1	*2437.00	106.90 PK			1.00 V	78	76.29	30.61
2	*2437.00	95.70 AV			1.00 V	78	65.09	30.61
3	2483.50	70.60 PK	74.00	-3.40	1.00 V	78	39.78	30.82
4	2483.50	52.60 AV	54.00	-1.40	1.00 V	78	21.78	30.82
5	4874.00	49.70 PK	74.00	-24.30	1.44 V	69	13.90	35.80
6	4874.00	34.60 AV	54.00	-19.40	1.44 V	69	-1.20	35.80
7	7311.00	56.90 PK	74.00	-17.10	1.27 V	75	14.38	42.52
8	7311.00	41.40 AV	54.00	-12.60	1.27 V	75	-1.12	42.52

- REMARKS:**
1. Emission level (dBuV/m) = Raw Value (dBuV) + Correction Factor (dB/m).
  2. Correction Factor (dB/m) = Antenna Factor (dB/m) + Cable Factor (dB).
  3. The other emission levels were very low against the limit.
  4. Margin value = Emission level – Limit value.
  5. “ \* “: Fundamental frequency.

EUT TEST CONDITION		MEASUREMENT DETAIL	
CHANNEL	Channel 7	FREQUENCY RANGE	1 ~ 25GHz
INPUT POWER (SYSTEM)	120Vac, 60 Hz	DETECTOR FUNCTION	Peak (PK) Average (AV)
ENVIRONMENTAL CONDITIONS	25deg. C, 64%RH 972hPa	TESTED BY	Frank Liu

ANTENNA POLARITY & TEST DISTANCE: HORIZONTAL AT 3 M								
NO.	FREQ. (MHz)	EMISSION LEVEL (dBuV/m)	LIMIT (dBuV/m)	MARGIN (dB)	ANTENNA HEIGHT (m)	TABLE ANGLE (Degree)	RAW VALUE (dBuV)	CORRECTION FACTOR (dB/m)
1	*2452.00	95.40 PK			1.47 H	26	64.73	30.67
2	*2452.00	83.50 AV			1.47 H	26	52.83	30.67
3	2483.50	56.06 PK	74.00	-17.94	1.46 H	25	25.24	30.82
4	2483.50	44.66 AV	54.00	-9.34	1.46 H	25	13.84	30.82
5	4904.00	46.10 PK	74.00	-27.90	1.89 H	19	10.24	35.86
6	4904.00	31.80 AV	54.00	-22.20	1.89 H	19	-4.06	35.86
7	7356.00	52.10 PK	74.00	-21.90	1.21 H	14	9.42	42.68
8	7356.00	37.50 AV	54.00	-16.50	1.21 H	14	-5.18	42.68
ANTENNA POLARITY & TEST DISTANCE: VERTICAL AT 3 M								
NO.	FREQ. (MHz)	EMISSION LEVEL (dBuV/m)	LIMIT (dBuV/m)	MARGIN (dB)	ANTENNA HEIGHT (m)	TABLE ANGLE (Degree)	RAW VALUE (dBuV)	CORRECTION FACTOR (dB/m)
1	*2452.00	104.40 PK			1.00 V	78	73.73	30.67
2	*2452.00	93.23 AV			1.00 V	78	62.56	30.67
3	2483.50	66.16 PK	74.00	-7.84	1.00 V	78	35.34	30.82
4	2483.50	52.42 AV	54.00	-1.58	1.00 V	78	21.60	30.82
5	4904.00	47.30 PK	74.00	-26.70	1.39 V	76	11.44	35.86
6	4904.00	32.10 AV	54.00	-21.90	1.39 V	76	-3.76	35.86
7	7356.00	53.70 PK	74.00	-20.30	1.29 V	73	11.02	42.68
8	7356.00	38.40 AV	54.00	-15.60	1.29 V	73	-4.28	42.68

- REMARKS:**
1. Emission level (dBuV/m) = Raw Value (dBuV) + Correction Factor (dB/m).
  2. Correction Factor (dB/m) = Antenna Factor (dB/m) + Cable Factor (dB).
  3. The other emission levels were very low against the limit.
  4. Margin value = Emission level – Limit value.
  5. “ \* “: Fundamental frequency.





## RESTRICTED BANDEDGE (DRAFT 802.11n (40MHz) MODE, CH1, HORIZONTAL )

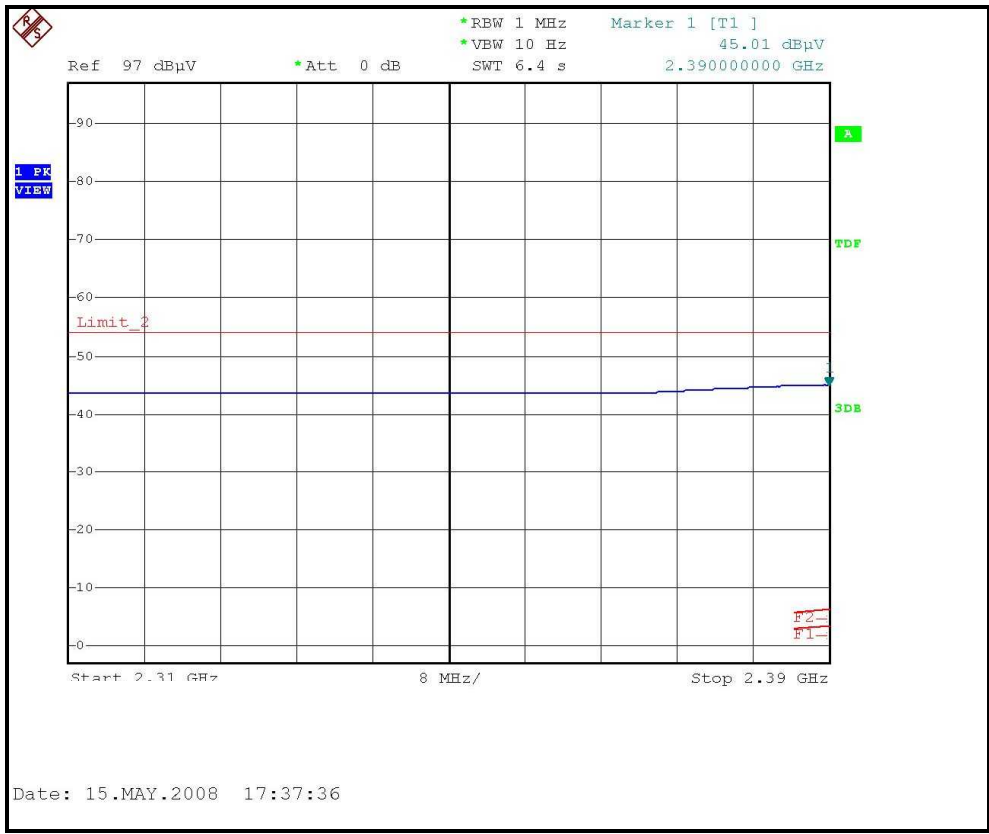
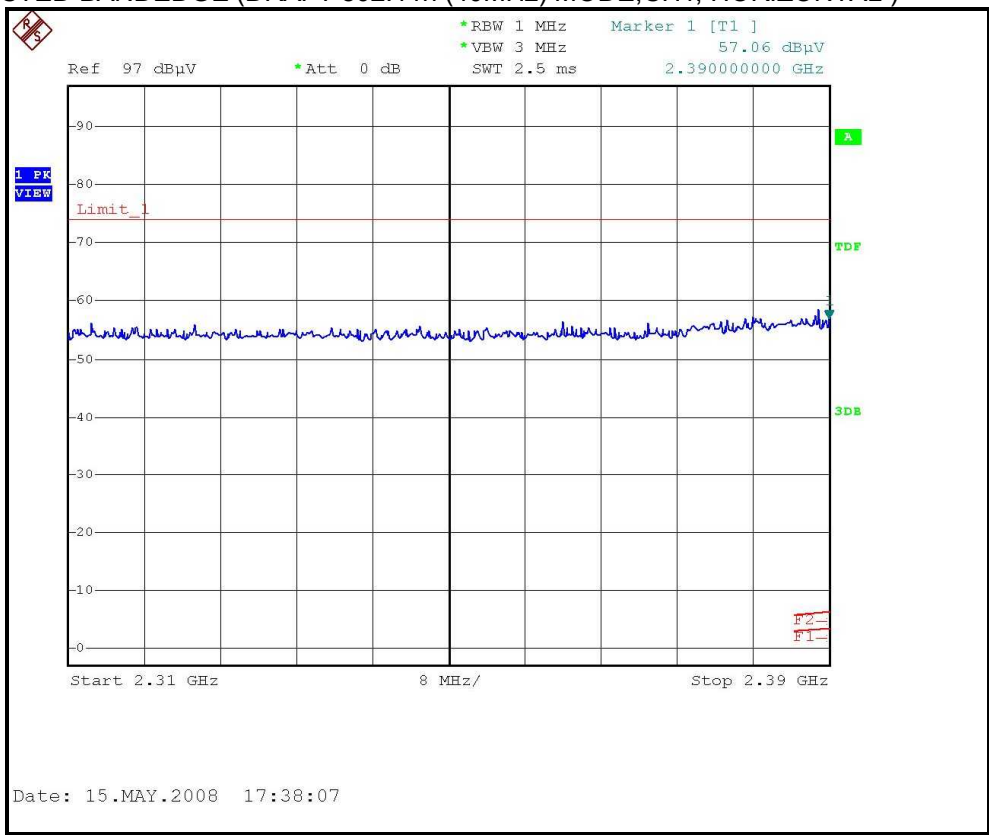

RESTRICTED BANDEDGE (DRAFT 802.11n (40MHz) MODE, CH1, VERTICAL )

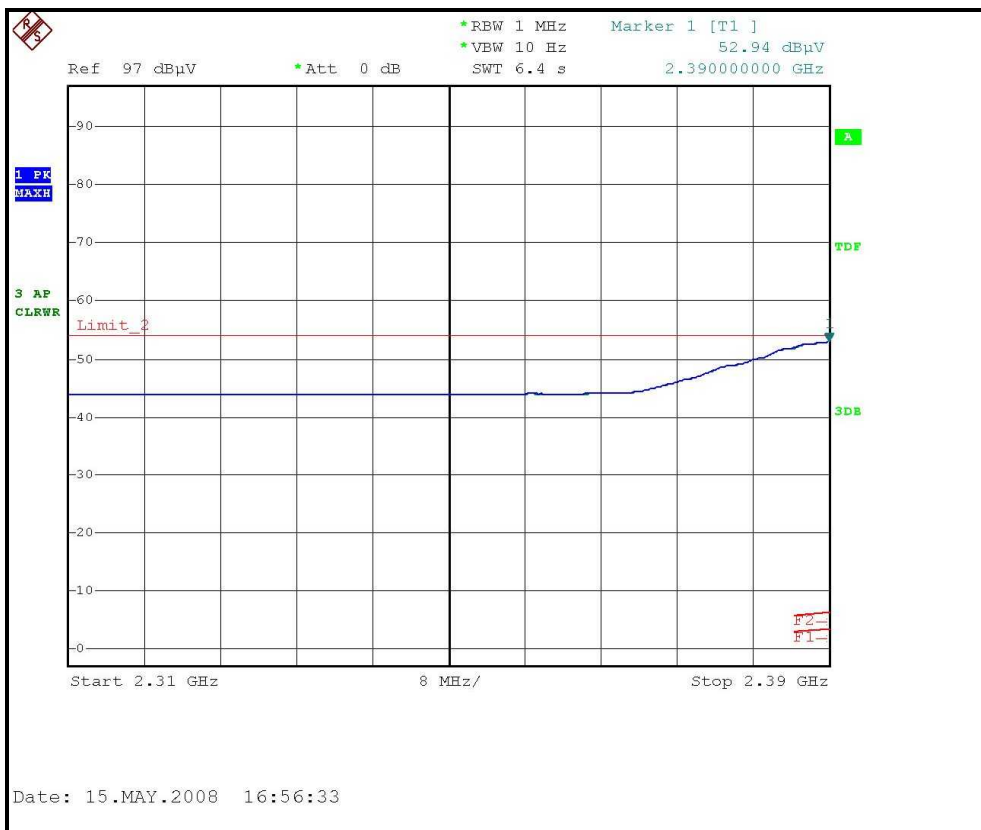
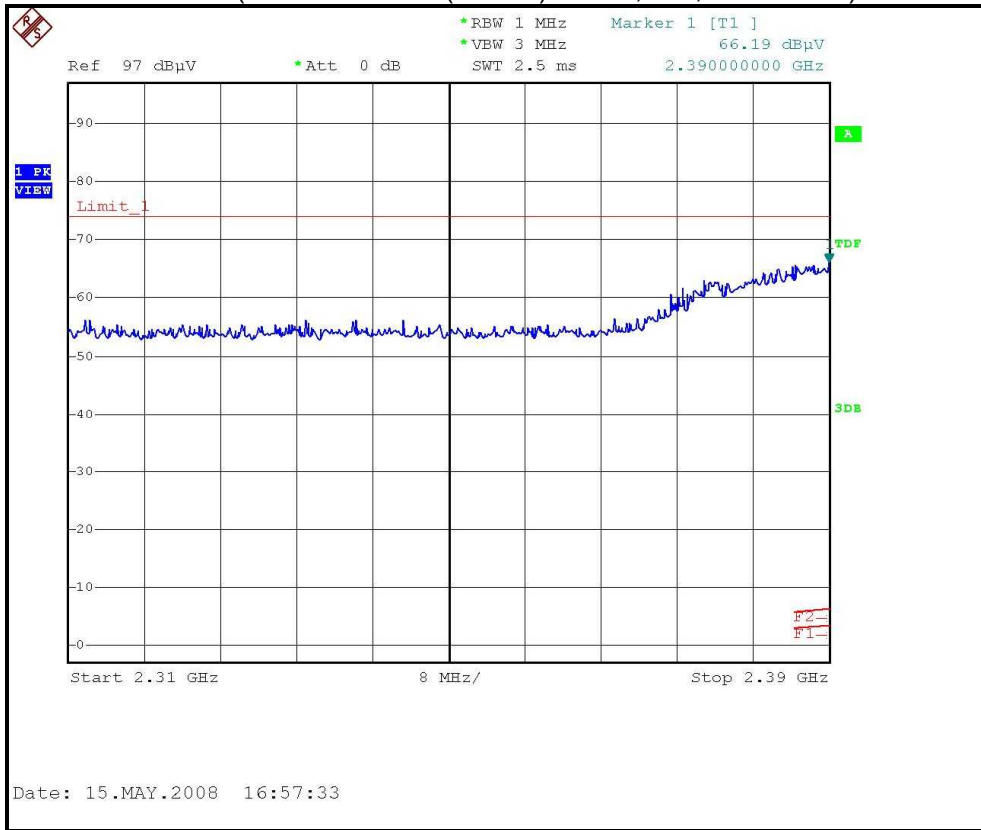

RESTRICTED BANDEDGE (DRAFT 802.11n (40MHz) MODE, CH7, HORIZONTAL )

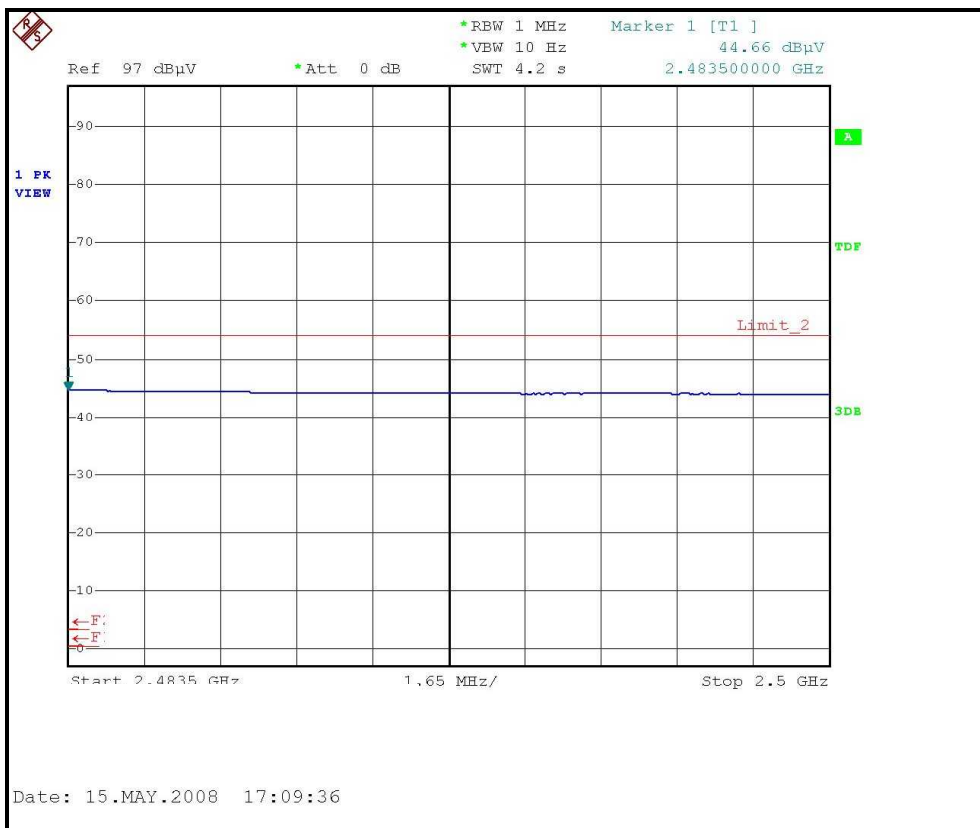
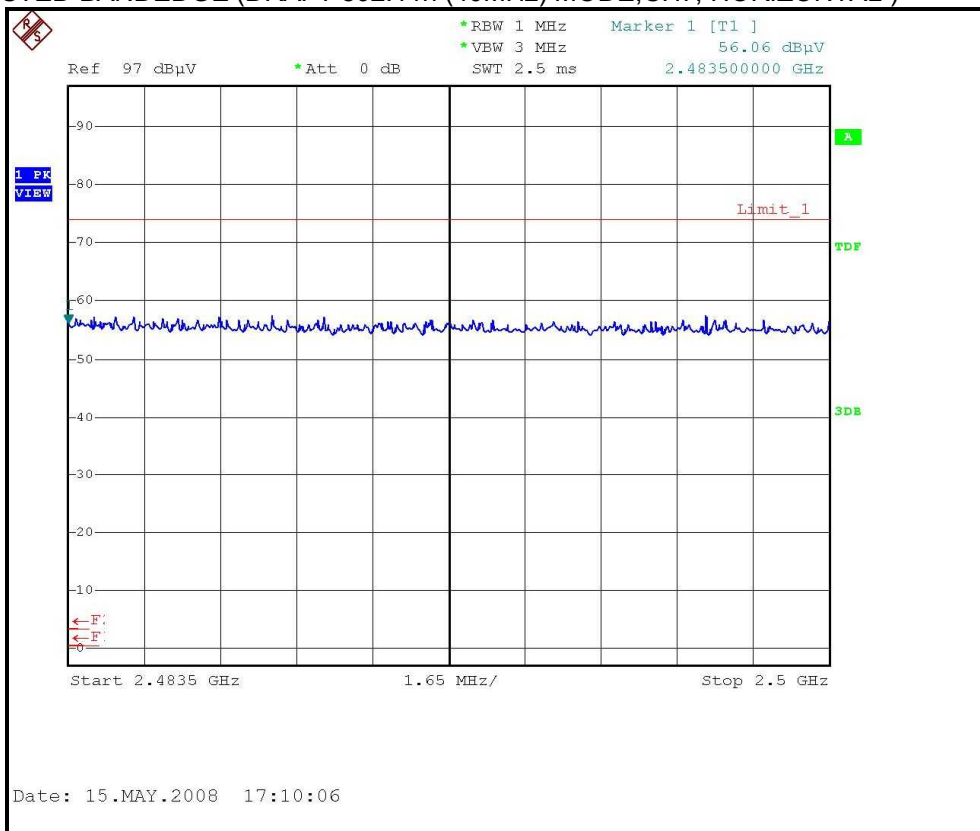

RESTRICTED BANDEDGE (DRAFT 802.11n (40MHz) MODE, CH7, VERTICAL)

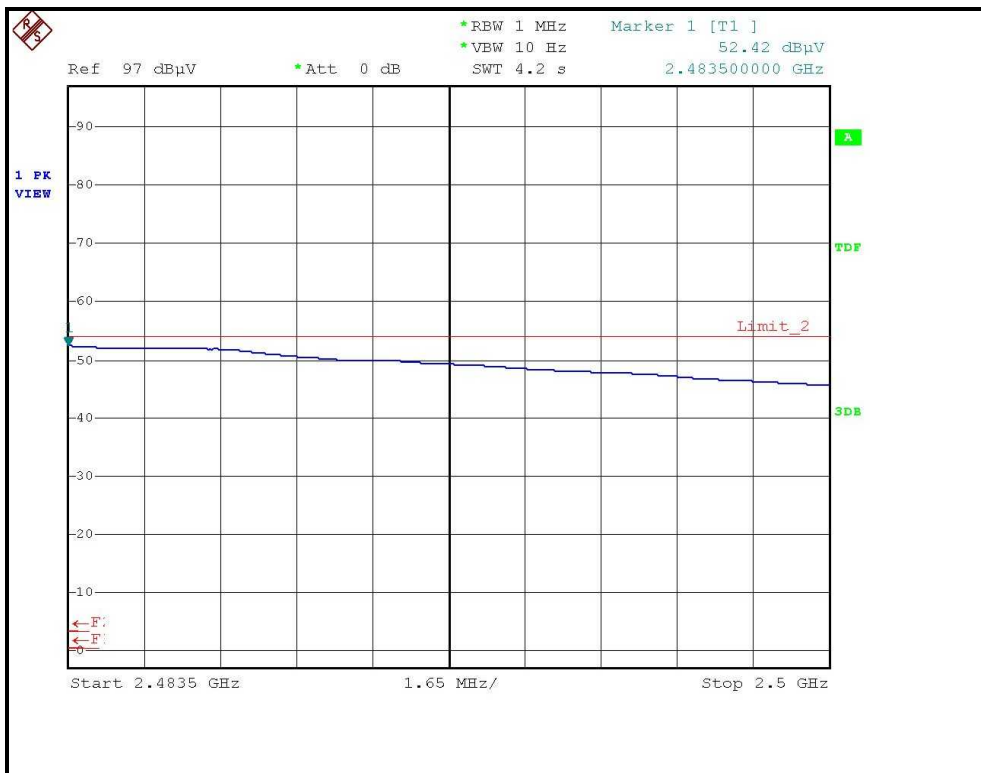
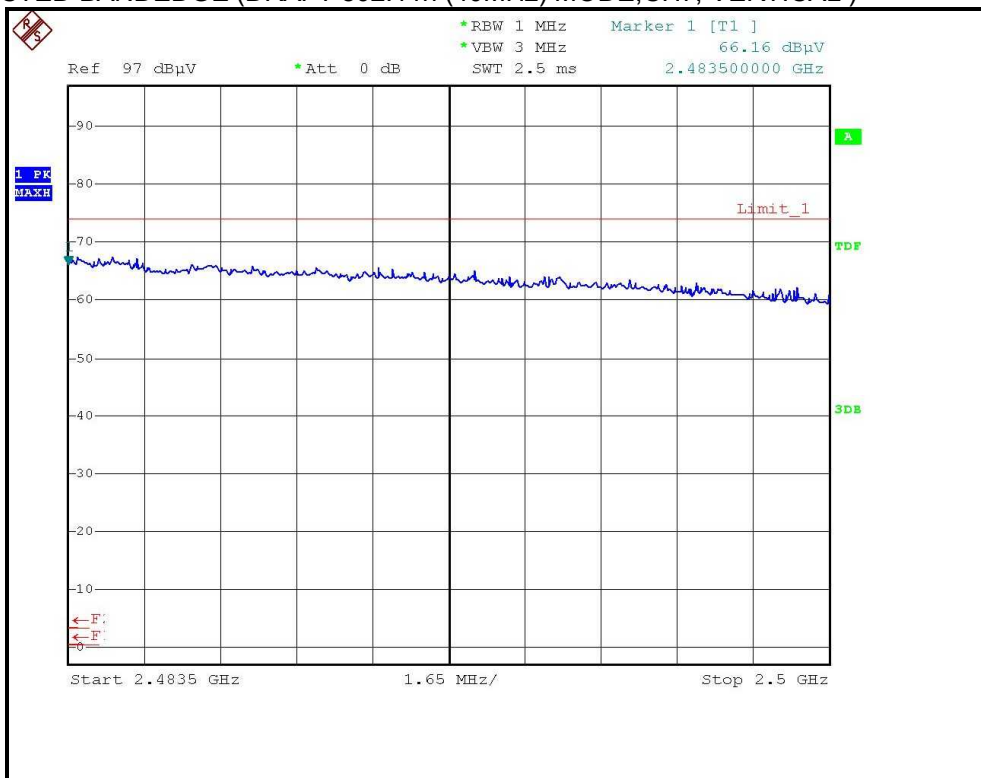



### 4.3 6dB BANDWIDTH MEASUREMENT

#### 4.3.1 LIMITS OF 6dB BANDWIDTH MEASUREMENT

The minimum of 6dB Bandwidth Measurement is 0.5 MHz.

#### 4.3.2 TEST INSTRUMENTS

Description & Manufacturer	Model No.	Serial No.	Calibrated Until
R&S SPECTRUM ANALYZER	FSP40	100037	Aug. 12, 2008

**NOTE:**

- 1.The measurement uncertainty is less than +/- 2.6dB, which is calculated as per the NAMAS document NIS81. This uncertainty represents an expanded uncertainty expressed at approximately the 95% confidence level using a coverage factor of k=2.
- 2.The calibration interval of the above test instruments is 12 months and the calibrations are traceable to NML/ROC and NIST/USA.

### 4.3.3 TEST PROCEDURE

The transmitter output was connected to the spectrum analyzer through an attenuator. The bandwidth of the fundamental frequency was measured by spectrum analyzer with 100kHz RBW and 100kHz VBW. The 6dB bandwidth is defined as the total spectrum the power of which is higher than peak power minus 6dB.

### 4.3.4 DEVIATION FROM TEST STANDARD

No deviation

### 4.3.5 TEST SETUP



### 4.3.6 EUT OPERATING CONDITIONS

The software provided by client to enable the EUT under transmission condition continuously at lowest, middle and highest channel frequencies individually.

### 4.3.7 TEST RESULTS

#### 802.11b DSSS MODULATION:

<b>MODULATION TYPE</b>	DBPSK	<b>TRANSFER RATE</b>	1Mbps
<b>INPUT POWER</b>	120Vac, 60 Hz	<b>ENVIRONMENTAL CONDITIONS</b>	25deg.C, 64%RH, 972hPa
<b>TESTED BY</b>	Phoenix Huang		

CHANNEL	CHANNEL FREQUENCY (MHz)	6dB BANDWIDTH (MHz)	MINIMUM LIMIT (MHz)	PASS / FAIL
1	2412	9.2346	0.5	PASS
6	2437	9.3585	0.5	PASS
11	2462	8.2961	0.5	PASS

CH1

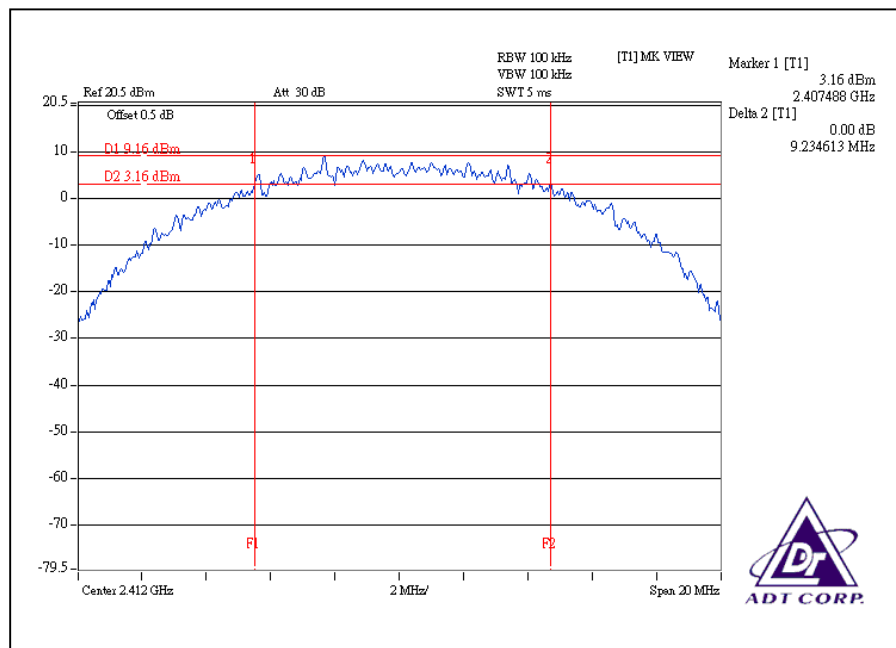

### CH6

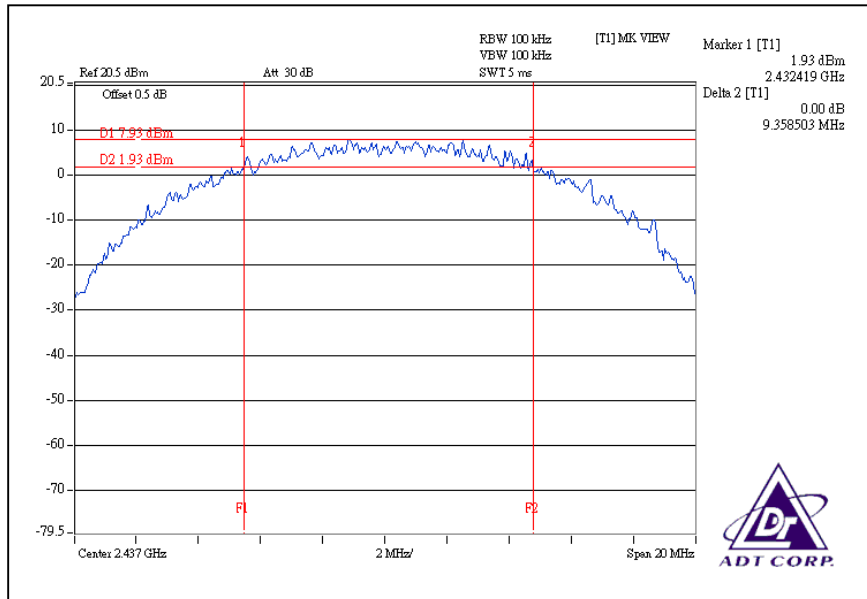

### CH11

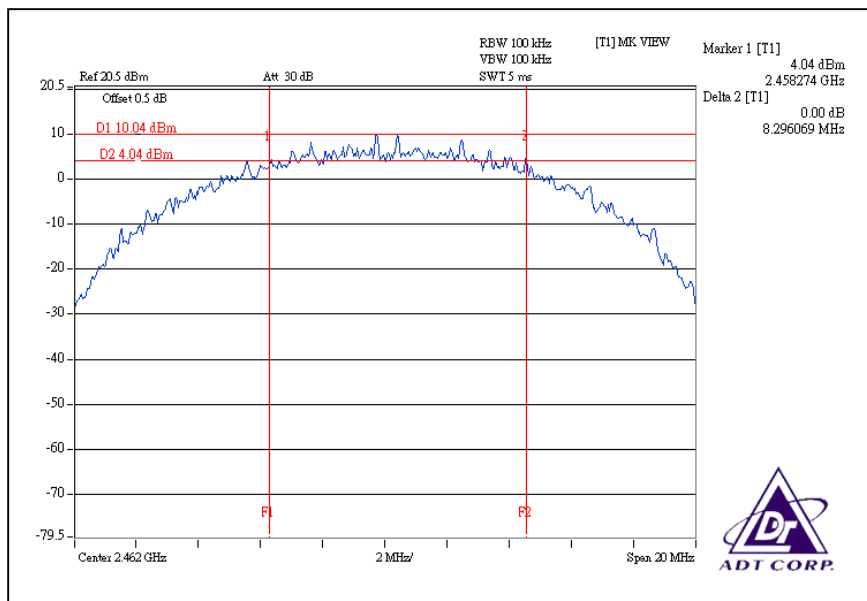



### 802.11g OFDM MODULATION:

<b>MODULATION TYPE</b>	BPSK	<b>TRANSFER RATE</b>	6Mbps
<b>INPUT POWER</b>	120Vac, 60 Hz	<b>ENVIRONMENTAL CONDITIONS</b>	25deg.C, 64%RH, 972hPa
<b>TESTED BY</b>	Phoenix Huang		

CHANNEL	CHANNEL FREQUENCY (MHz)	6dB BANDWIDTH (MHz)	MINIMUM LIMIT (MHz)	PASS / FAIL
1	2412	16.5030	0.5	PASS
6	2437	16.4817	0.5	PASS
11	2462	16.4866	0.5	PASS

CH1

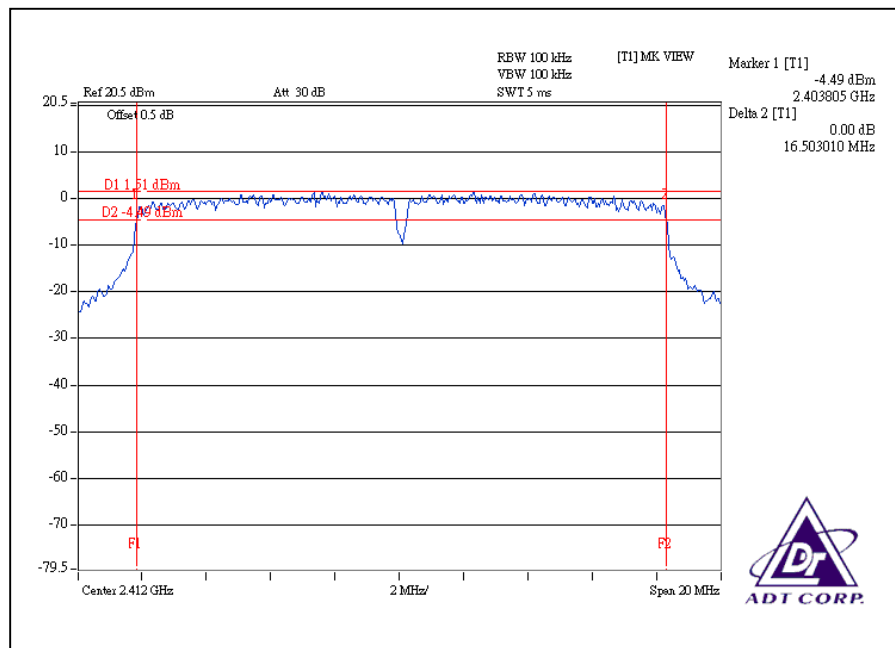

### CH6

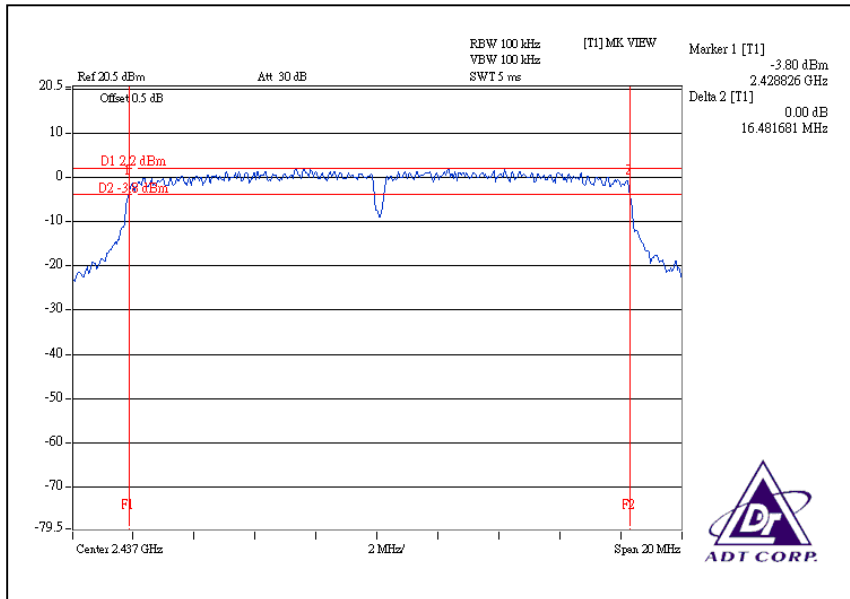

### CH11

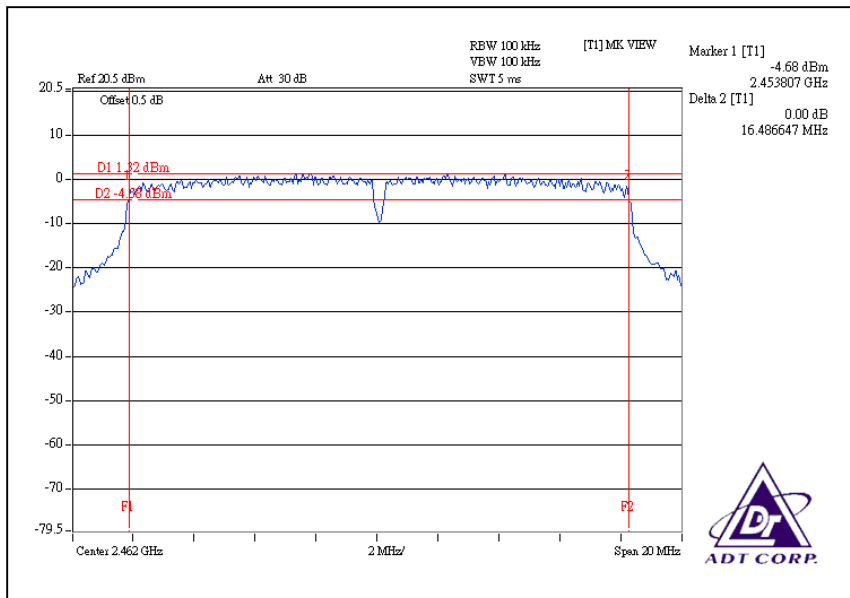

**DRAFT 802.11n (20MHz) OFDM MODULATION:**

<b>MODULATION TYPE</b>	BPSK	<b>TRANSFER RATE</b>	7.2Mbps
<b>INPUT POWER</b>	120Vac, 60 Hz	<b>ENVIRONMENTAL CONDITIONS</b>	25deg.C, 64%RH, 972hPa
<b>TESTED BY</b>	Phoenix Huang		

CHANNEL	CHANNEL FREQUENCY (MHz)	6dB BANDWIDTH (MHz)	MINIMUM LIMIT (MHz)	PASS / FAIL
1	2412	17.7049	0.5	PASS
6	2437	17.6756	0.5	PASS
11	2462	17.6643	0.5	PASS

CH1

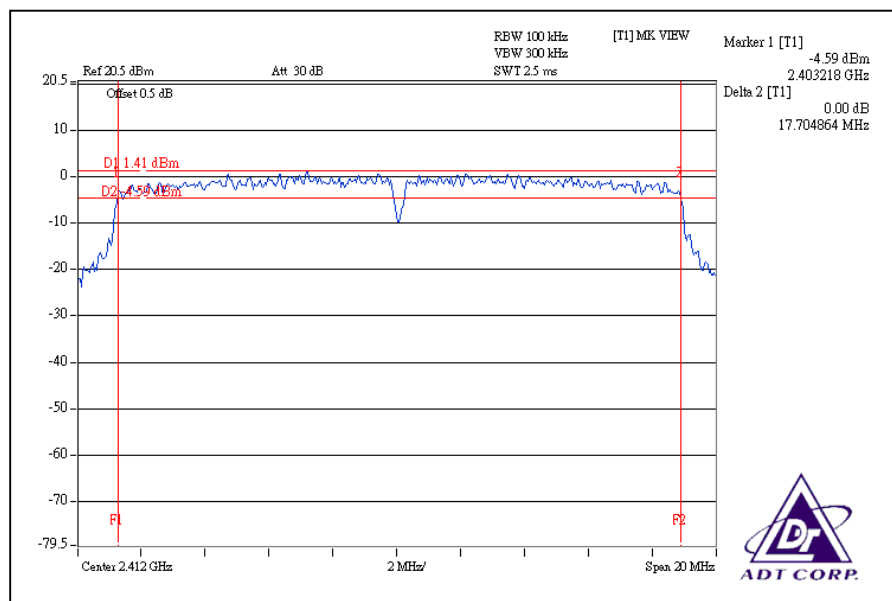

### CH6

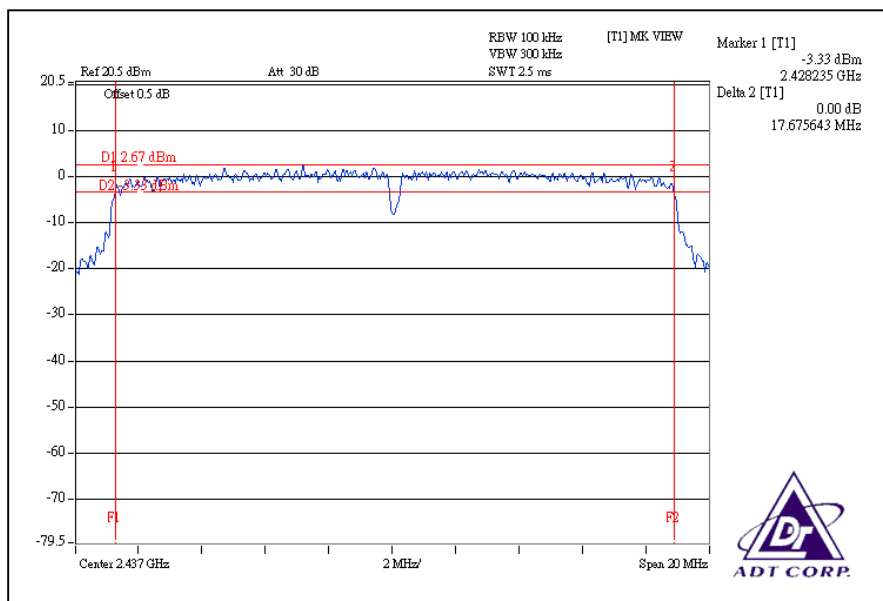

### CH11

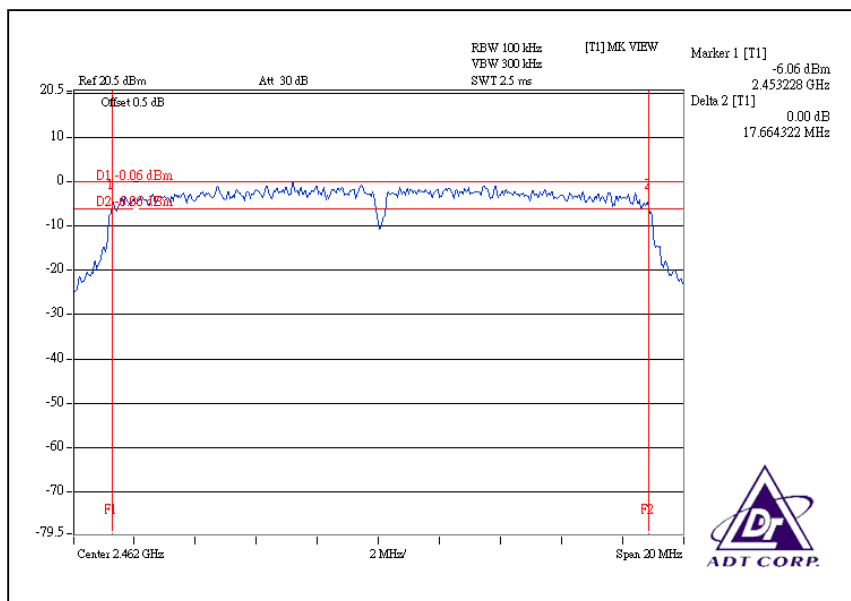

**DRAFT 802.11n (40MHz) OFDM MODULATION:**

<b>MODULATION TYPE</b>	BPSK	<b>TRANSFER RATE</b>	15Mbps
<b>INPUT POWER</b>	120Vac, 60 Hz	<b>ENVIRONMENTAL CONDITIONS</b>	25deg.C, 64%RH, 972hPa
<b>TESTED BY</b>	Phoenix Huang		

CHANNEL	CHANNEL FREQUENCY (MHz)	6dB BANDWIDTH (MHz)	MINIMUM LIMIT (MHz)	PASS / FAIL
1	2422	36.4917	0.5	PASS
4	2437	36.5072	0.5	PASS
7	2452	36.4854	0.5	PASS

CH1

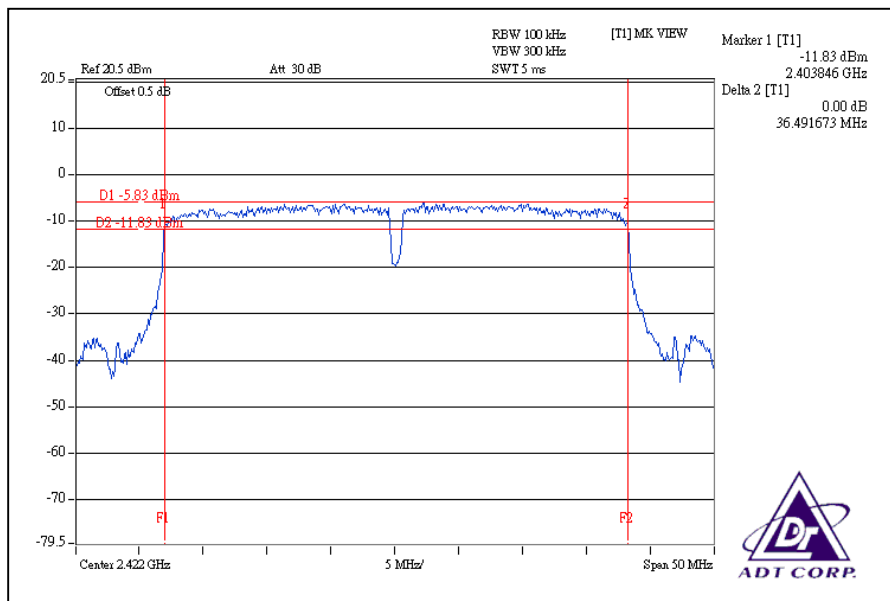

CH4

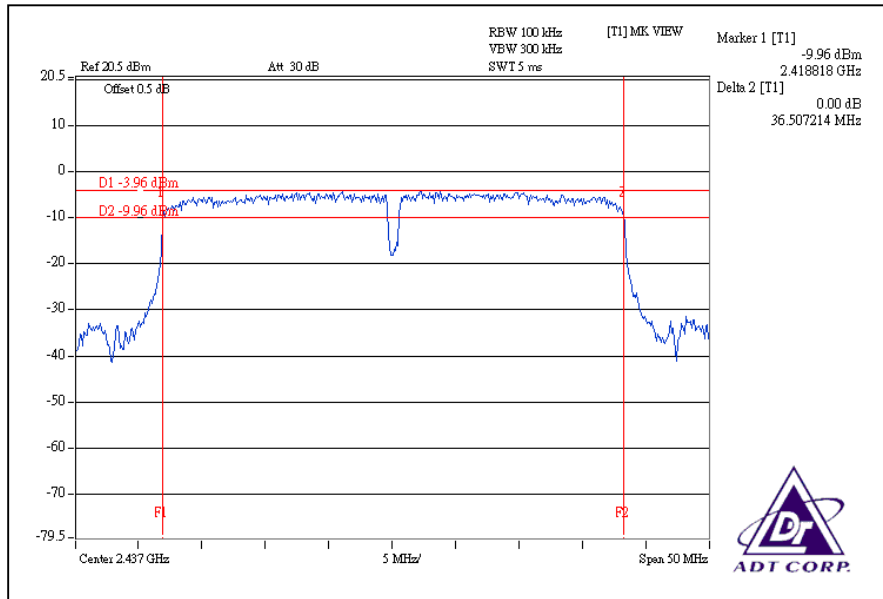

CH7

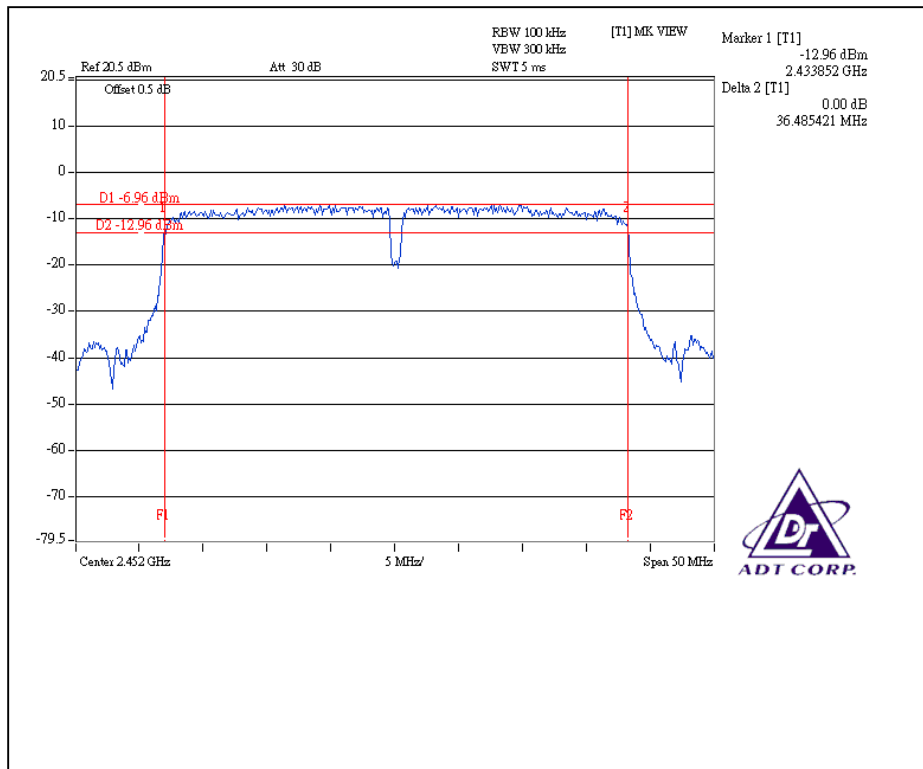

#### 4.4 MAXIMUM PEAK OUTPUT POWER

##### 4.4.1 LIMITS OF MAXIMUM PEAK OUTPUT POWER MEASUREMENT

The Maximum Peak Output Power Measurement is 30dBm.

##### 4.4.2 INSTRUMENTS

Description & Manufacturer	Model No.	Serial No.	Calibrated Until
R&S SPECTRUM ANALYZER	FSP40	100037	Aug. 12, 2008
Agilent SIGNAL GENERATOR	E8257C	MY43320668	Dec. 25, 2008
TEKTRONIX OSCILLOSCOPE	TDS380	B016335	Aug. 15, 2008
NARDA DETECTOR	4503A	FSCM99899	NA

**NOTE:**

The calibration interval of the above test instruments is 12 months and the calibrations are traceable to NML/ROC and NIST/USA.

#### 4.4.3 TEST PROCEDURES

1. A detector was used on the output port of the EUT. An oscilloscope was used to read the response of the detector.
2. Replaced the EUT by the signal generator. The center frequency of the S.G was adjusted to the center frequency of the measured channel.
3. Adjusted the power to have the same reading on oscilloscope. Record the power level.

#### 4.4.4 DEVIATION FROM TEST STANDARD

No deviation

#### 4.4.5 TEST SETUP



#### 4.4.6 EUT OPERATING CONDITIONS

Same as Item 4.3.6



#### 4.4.7 TEST RESULTS

##### 802.11b DSSS MODULATION:

<b>MODULATION TYPE</b>	DBPSK	<b>TRANSFER RATE</b>	1Mbps
<b>INPUT POWER</b>	120Vac, 60 Hz	<b>ENVIRONMENTAL CONDITIONS</b>	25deg.C, 64%RH, 972hPa
<b>TESTED BY</b>	Phoenix Huang		

CHANNEL	CHANNEL FREQUENCY (MHz)	PEAK POWER OUTPUT (mW)	PEAK POWER OUTPUT (dBm)	PEAK POWER LIMIT (dBm)	PASS / FAIL
1	2412	87.096	19.40	30	PASS
6	2437	85.114	19.30	30	PASS
11	2462	83.176	19.20	30	PASS

##### 802.11g OFDM MODULATION:

<b>MODULATION TYPE</b>	BPSK	<b>TRANSFER RATE</b>	6Mbps
<b>INPUT POWER</b>	120Vac, 60 Hz	<b>ENVIRONMENTAL CONDITIONS</b>	25deg.C, 64%RH, 972hPa
<b>TESTED BY</b>	Phoenix Huang		

CHANNEL	CHANNEL FREQUENCY (MHz)	PEAK POWER OUTPUT (mW)	PEAK POWER OUTPUT (dBm)	PEAK POWER LIMIT (dBm)	PASS / FAIL
1	2412	100.000	20.00	30	PASS
6	2437	104.713	20.20	30	PASS
11	2462	95.499	19.80	30	PASS



**DRAFT 802.11n (20MHz) OFDM MODULATION:**

<b>MODULATION TYPE</b>	BPSK	<b>TRANSFER RATE</b>	7.2Mbps
<b>INPUT POWER</b>	120Vac, 60 Hz	<b>ENVIRONMENTAL CONDITIONS</b>	25deg.C, 64%RH, 972hPa
<b>TESTED BY</b>	Phoenix Huang		

CHANNEL	CHANNEL FREQUENCY (MHz)	PEAK POWER OUTPUT (mW)	PEAK POWER OUTPUT (dBm)	PEAK POWER LIMIT (dBm)	PASS / FAIL
1	2412	87.700	19.43	30	PASS
6	2437	109.144	20.38	30	PASS
11	2462	66.527	18.23	30	PASS

**DRAFT 802.11n (40MHz) OFDM MODULATION:**

<b>MODULATION TYPE</b>	BPSK	<b>TRANSFER RATE</b>	15Mbps
<b>INPUT POWER</b>	120Vac, 60 Hz	<b>ENVIRONMENTAL CONDITIONS</b>	25deg.C, 64%RH, 972hPa
<b>TESTED BY</b>	Phoenix Huang		

CHANNEL	CHANNEL FREQUENCY (MHz)	PEAK POWER OUTPUT (mW)	PEAK POWER OUTPUT (dBm)	PEAK POWER LIMIT (dBm)	PASS / FAIL
1	2422	35.156	15.46	30	PASS
4	2437	47.315	16.75	30	PASS
7	2452	27.990	14.47	30	PASS



## 4.5 POWER SPECTRAL DENSITY MEASUREMENT

### 4.5.1 LIMITS OF POWER SPECTRAL DENSITY MEASUREMENT

The Maximum of Power Spectral Density Measurement is 8dBm.

### 4.5.2 TEST INSTRUMENTS

Description & Manufacturer	Model No.	Serial No.	Calibrated Until
R&S SPECTRUM ANALYZER	FSP40	100037	Aug. 12, 2008

**NOTE:**

- 1.The measurement uncertainty is less than +/- 2.6dB, which is calculated as per the NAMAS document NIS81. This uncertainty represents an expanded uncertainty expressed at approximately the 95% confidence level using a coverage factor of k=2.
- 2.The calibration interval of the above test instruments is 12 months and the calibrations are traceable to NML/ROC and NIST/USA.

#### 4.5.3 TEST PROCEDURE

The transmitter output was connected to the spectrum analyzer through an attenuator, the bandwidth of the fundamental frequency was measured with the spectrum analyzer using 3kHz RBW and 30kHz VBW, set sweep time = span/3kHz. The power spectral density was measured and recorded. The sweep time is allowed to be longer than span/3kHz for a full response of the mixer in the spectrum analyzer.

#### 4.5.4 DEVIATION FROM TEST STANDARD

No deviation

#### 4.5.5 TEST SETUP

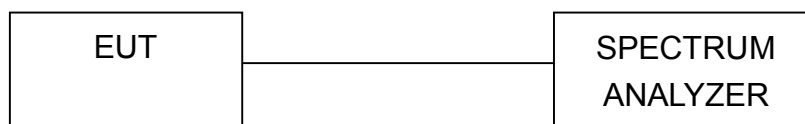

#### 4.5.6 EUT OPERATING CONDITION

Same as Item 4.3.6

## 4.5.7 TEST RESULTS

### 802.11b DSSS MODULATION:

<b>MODULATION TYPE</b>	DBPSK	<b>TRANSFER RATE</b>	1Mbps
<b>INPUT POWER</b>	120Vac, 60 Hz	<b>ENVIRONMENTAL CONDITIONS</b>	25deg.C, 64%RH, 972hPa
<b>TESTED BY</b>	Phoenix Huang		

CHANNEL	CHANNEL FREQUENCY (MHz )	RF POWER LEVEL IN 3kHz BW (dBm)	MAXIMUM LIMIT (dBm)	PASS / FAIL
1	2412	-6.19	8	PASS
6	2437	-6.59	8	PASS
11	2462	-4.59	8	PASS

CH1

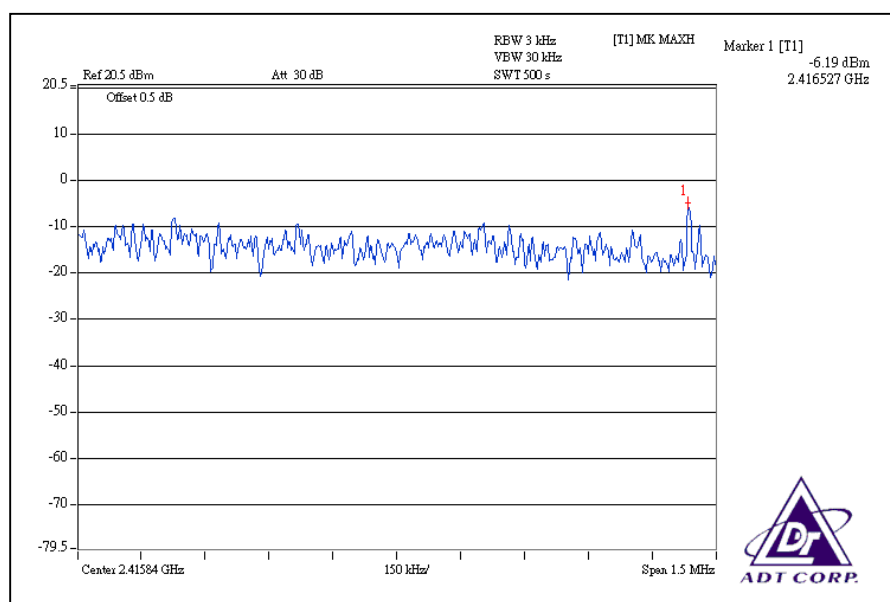

### CH6

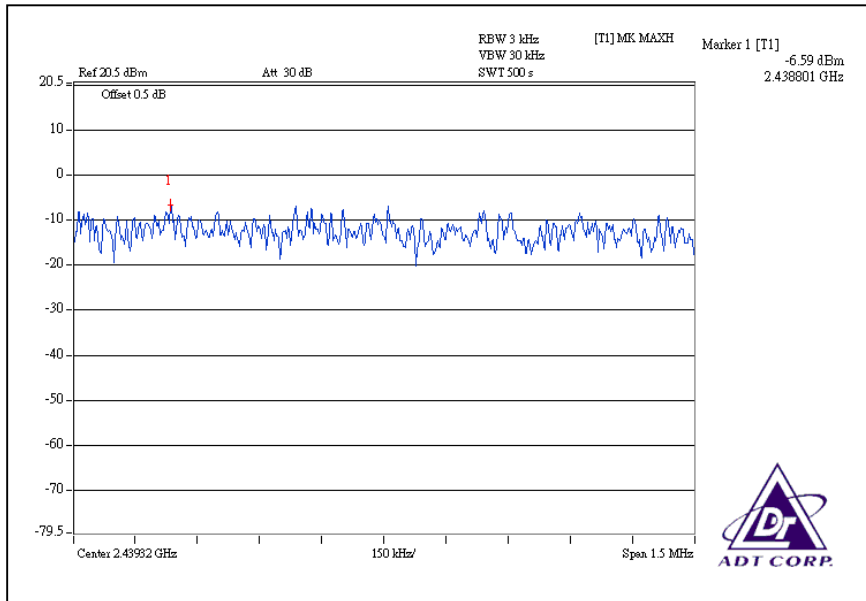

### CH11

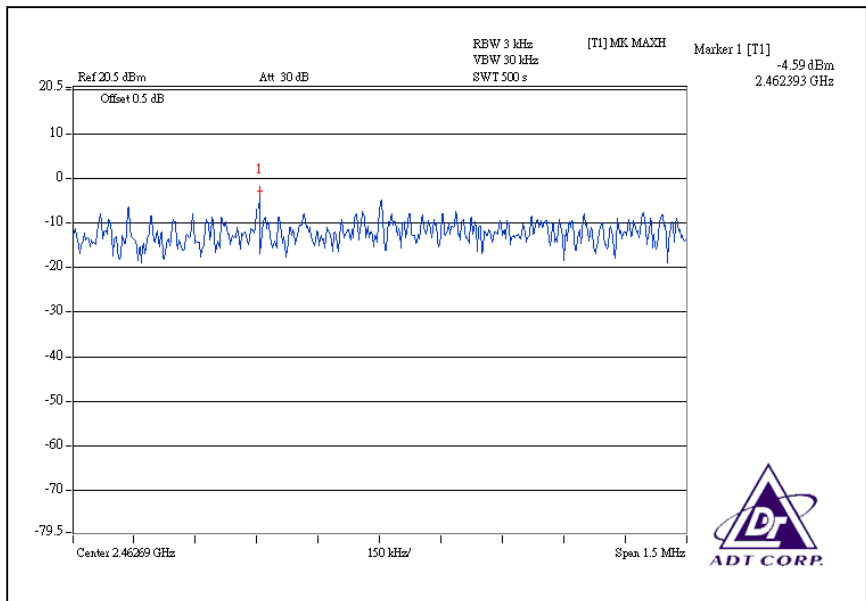

### 802.11g OFDM MODULATION:

<b>MODULATION TYPE</b>	BPSK	<b>TRANSFER RATE</b>	6Mbps
<b>INPUT POWER</b>	120Vac, 60 Hz	<b>ENVIRONMENTAL CONDITIONS</b>	25deg.C, 64%RH, 972hPa
<b>TESTED BY</b>	Phoenix Huang		

CHANNEL	CHANNEL FREQUENCY (MHz )	RF POWER LEVEL IN 3kHz BW (dBm)	MAXIMUM LIMIT (dBm)	PASS / FAIL
1	2412	-12.57	8	PASS
6	2437	-12.14	8	PASS
11	2462	-12.73	8	PASS

CH1

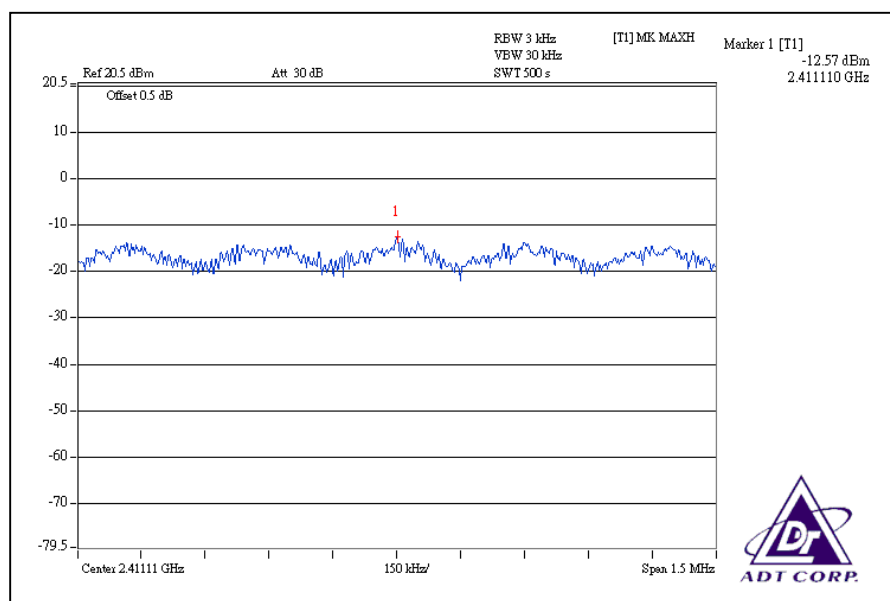

CH6

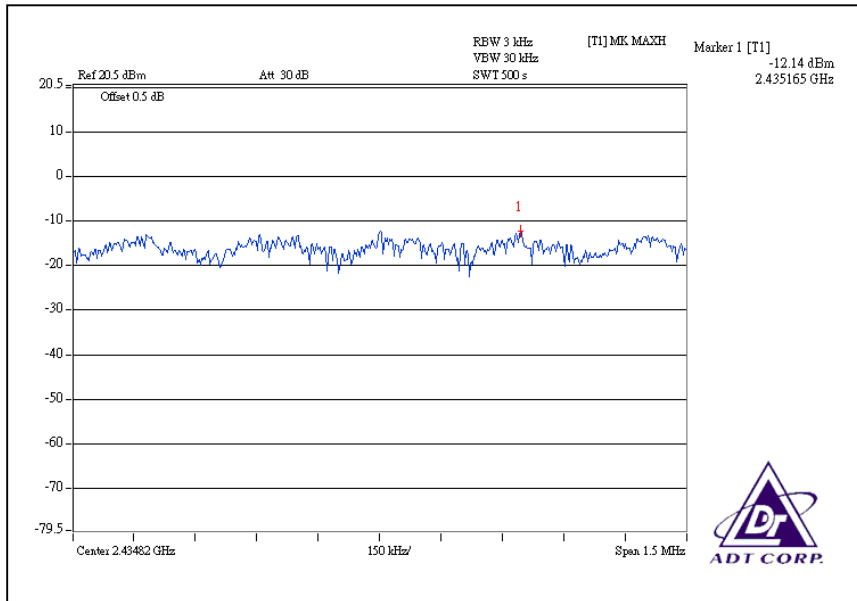

CH11

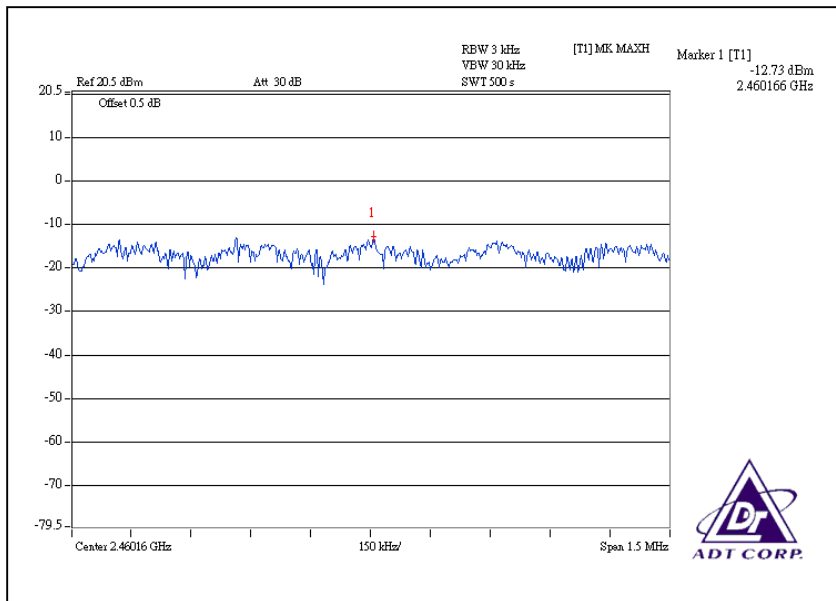



**DRAFT 802.11n (20MHz) OFDM MODULATION:**

<b>MODULATION TYPE</b>	BPSK	<b>TRANSFER RATE</b>	7.2Mbps
<b>INPUT POWER</b>	120Vac, 60 Hz	<b>ENVIRONMENTAL CONDITIONS</b>	25 deg.C, 64%RH, 972hPa
<b>TESTED BY</b>	Phoenix Huang		

CHANNEL	CHANNEL FREQUENCY (MHz)	RF POWER LEVEL IN 3kHz BW (dBm)	MAXIMUM LIMIT (dBm)	PASS / FAIL
1	2412	-13.06	8	PASS
6	2437	-12.11	8	PASS
11	2462	-14.52	8	PASS

CH1

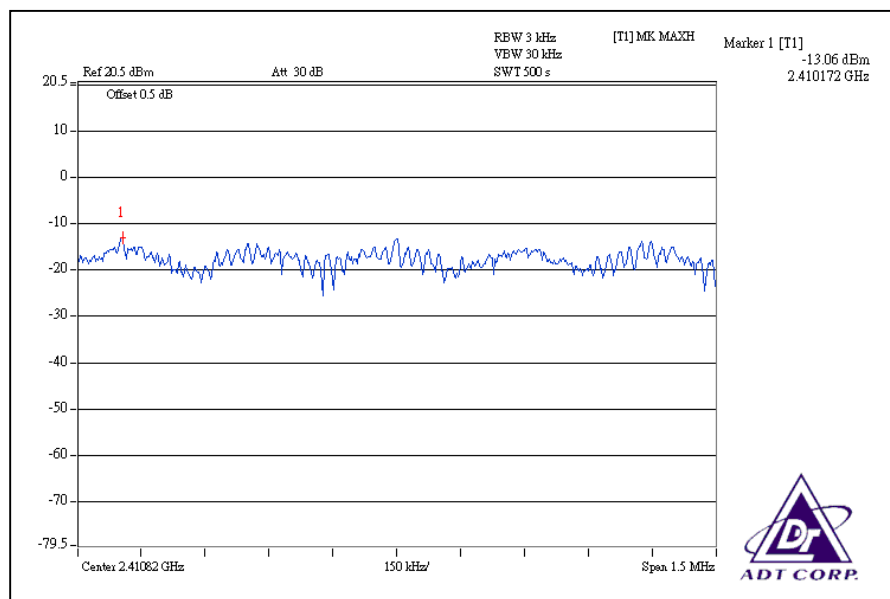

### CH6

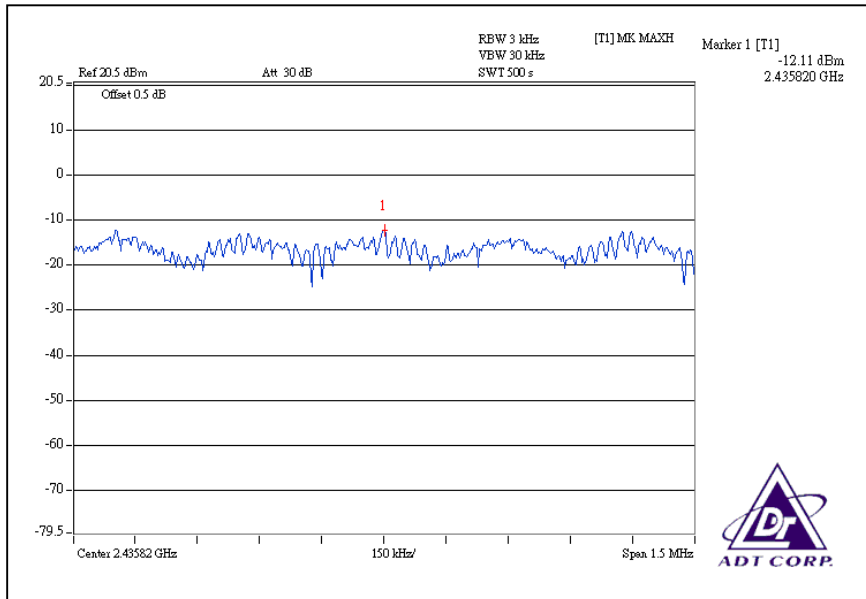

### CH11

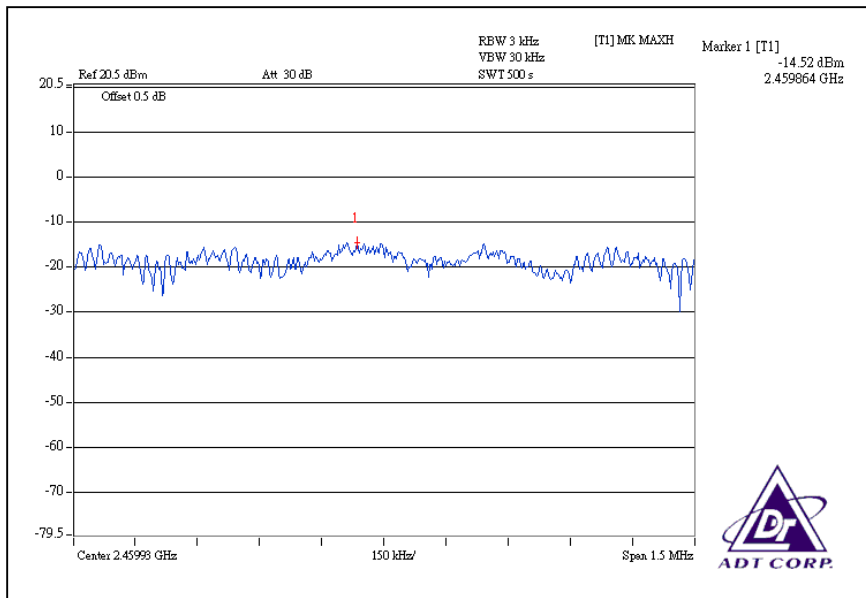

**DRAFT 802.11n (40MHz) OFDM MODULATION:**

<b>MODULATION TYPE</b>	BPSK	<b>TRANSFER RATE</b>	15Mbps
<b>INPUT POWER</b>	120Vac, 60 Hz	<b>ENVIRONMENTAL CONDITIONS</b>	25deg.C, 64%RH, 972hPa
<b>TESTED BY</b>	Phoenix Huang		

CHANNEL	CHANNEL FREQUENCY (MHz )	RF POWER LEVEL IN 3kHz BW (dBm)	MAXIMUM LIMIT (dBm)	PASS / FAIL
1	2422	-17.07	8	PASS
4	2437	-15.67	8	PASS
7	2452	-17.19	8	PASS

CH1

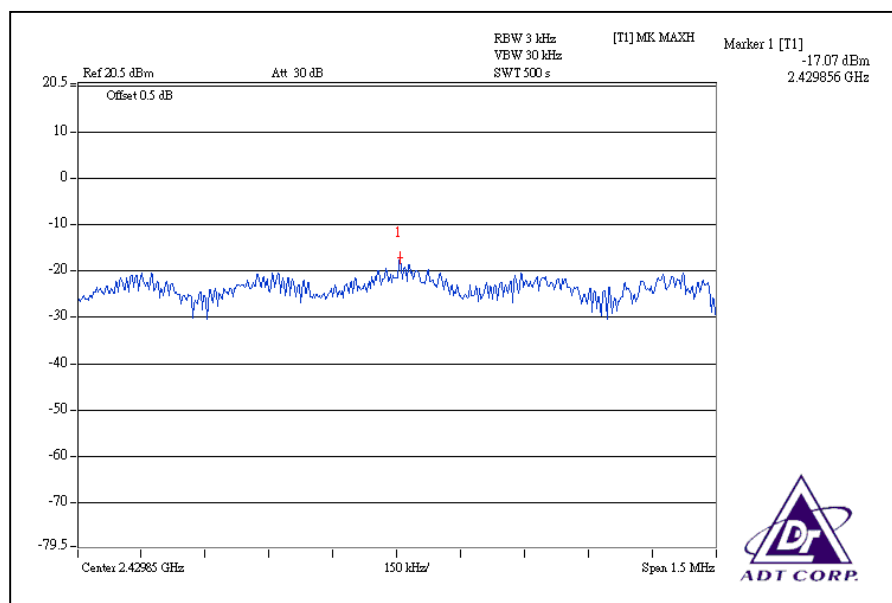

### CH4

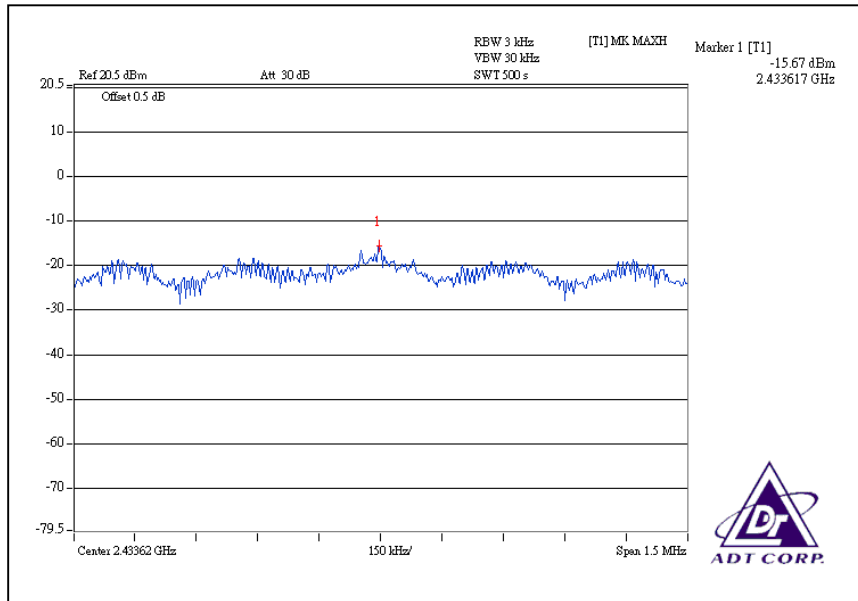

### CH7

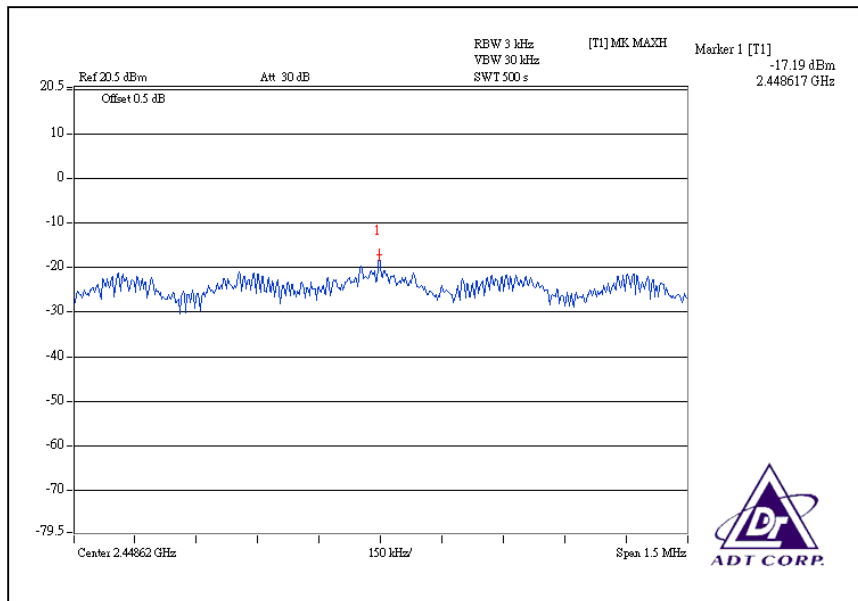

## 4.6 BAND EDGES MEASUREMENT

### 4.6.1 LIMITS OF BAND EDGES MEASUREMENT

Below -20dB of the highest emission level of operating band (in 100KHz Resolution Bandwidth).

### 4.6.2 TEST INSTRUMENTS

Description & Manufacturer	Model No.	Serial No.	Calibrated Until
R&S SPECTRUM ANALYZER	FSP40	100037	Aug. 12, 2008

**NOTE:**

- 1.The measurement uncertainty is less than +/- 2.6dB, which is calculated as per the NAMAS document NIS81. This uncertainty represents an expanded uncertainty expressed at approximately the 95% confidence level using a coverage factor of k=2.
- 2.The calibration interval of the above test instruments is 12 months and the calibrations are traceable to NML/ROC and NIST/USA.

### 4.6.3 TEST PROCEDURE

The transmitter output was connected to the spectrum analyzer via a low loss cable. Set both RBW of spectrum analyzer to 100kHz and VBW of spectrum analyzer to 300kHz with suitable frequency span including 100 MHz bandwidth from band edge. The band edges was measured and recorded.

The spectrum plots (RBW = 100kHz, VBW = 300kHz) are attached on the following pages.

#### 4.6.4 DEVIATION FROM TEST STANDARD

No deviation

#### 4.6.5 EUT OPERATING CONDITION

Same as Item 4.3.6

#### 4.6.6 TEST RESULTS

The spectrum plots are attached on the following below images. D1 line indicates the highest level, and D2 line indicates the 20dB offset below D1. It shows compliance with the requirement in part 15.247(d).

## 802.11b DSSS MODULATION: CH1

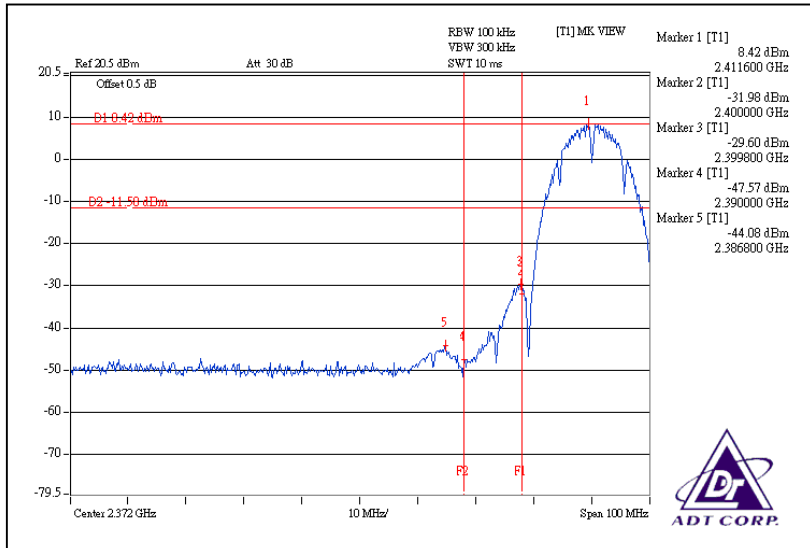

## CH11

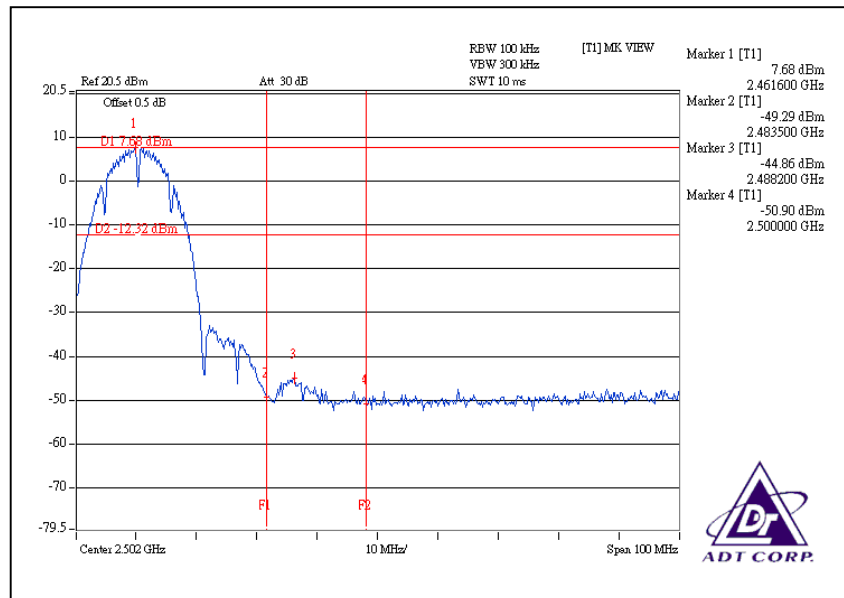

### CH1

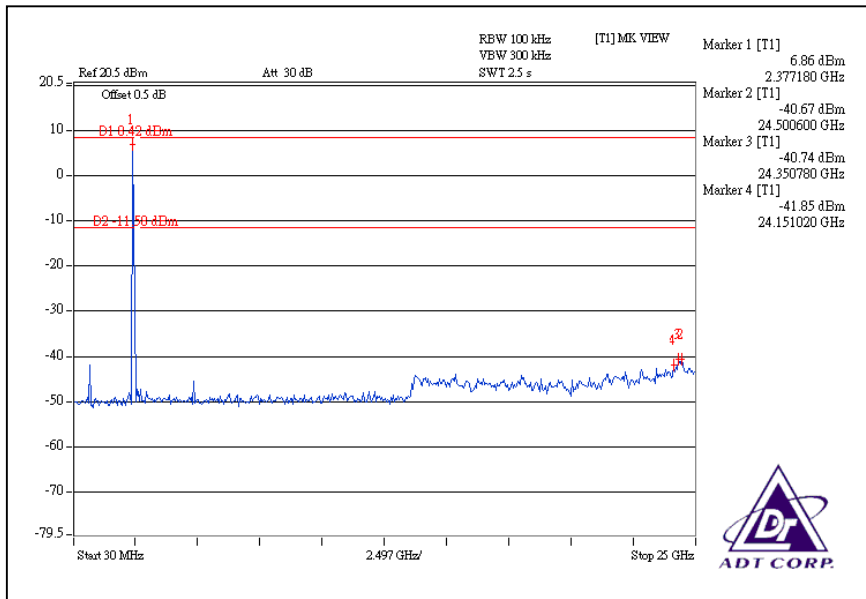

### CH11

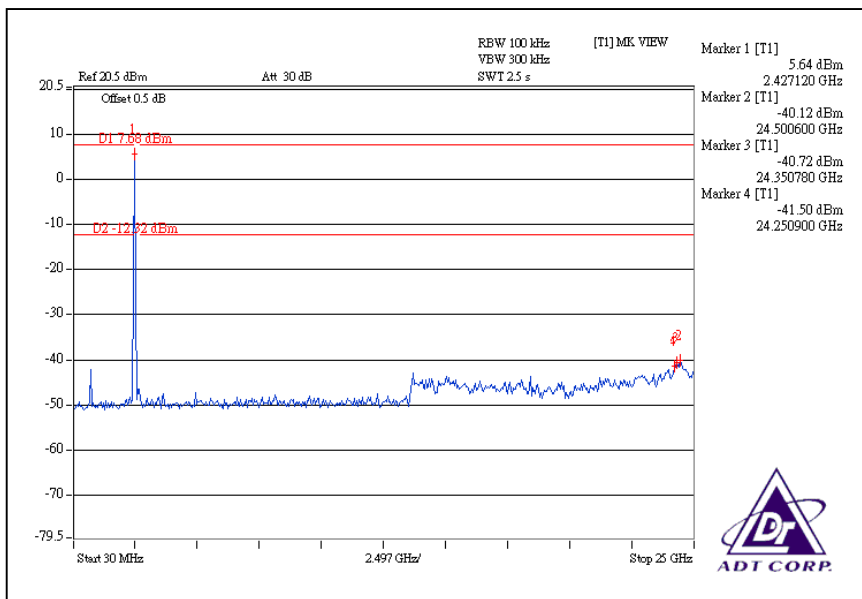



## 802.11g OFDM MODULATION:

### CH 1

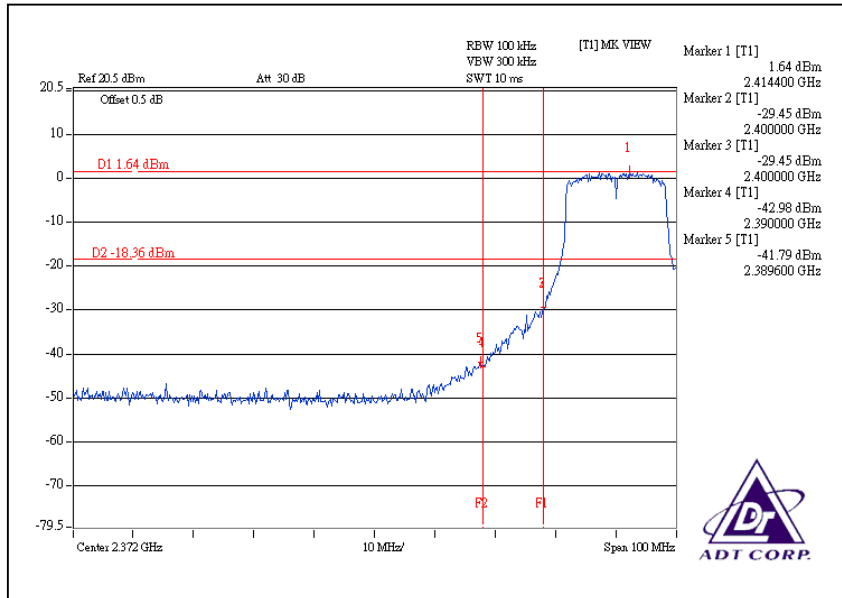

### CH11

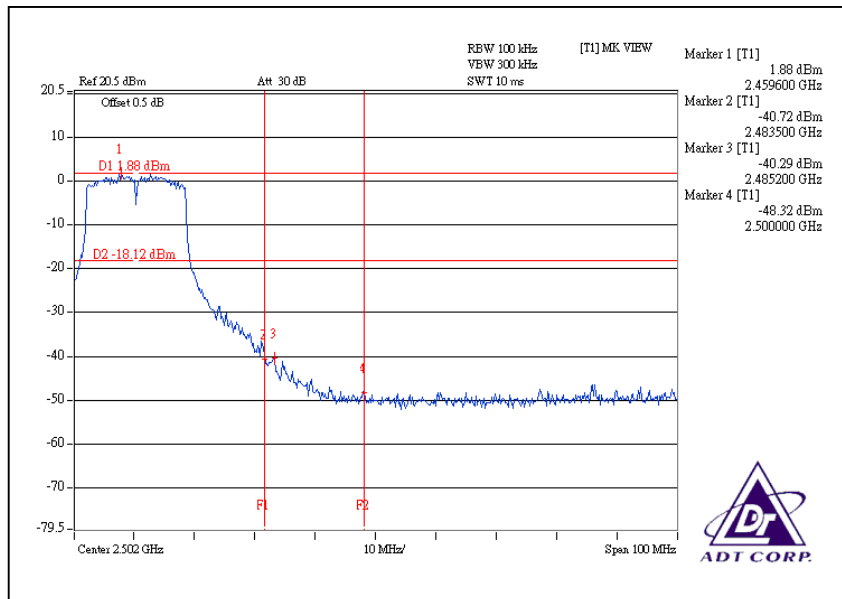

### CH1

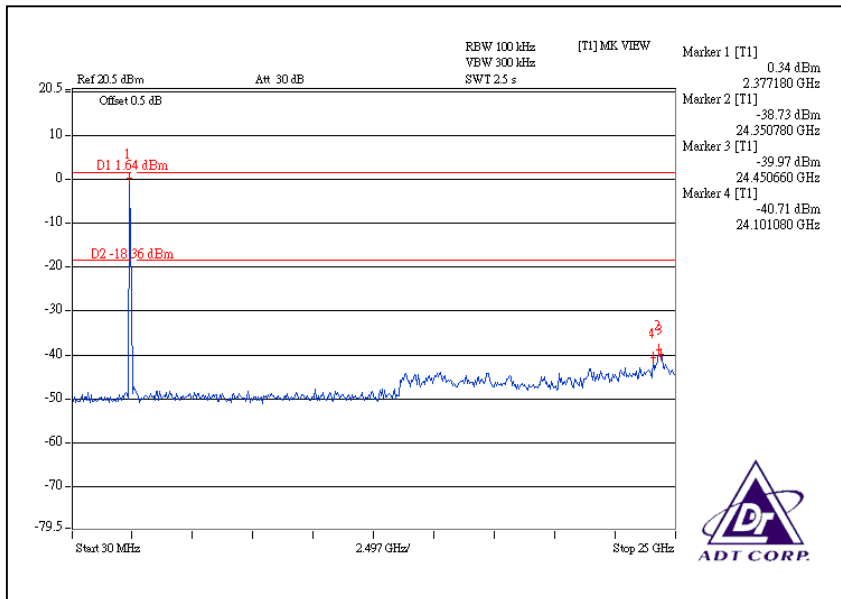

### CH11

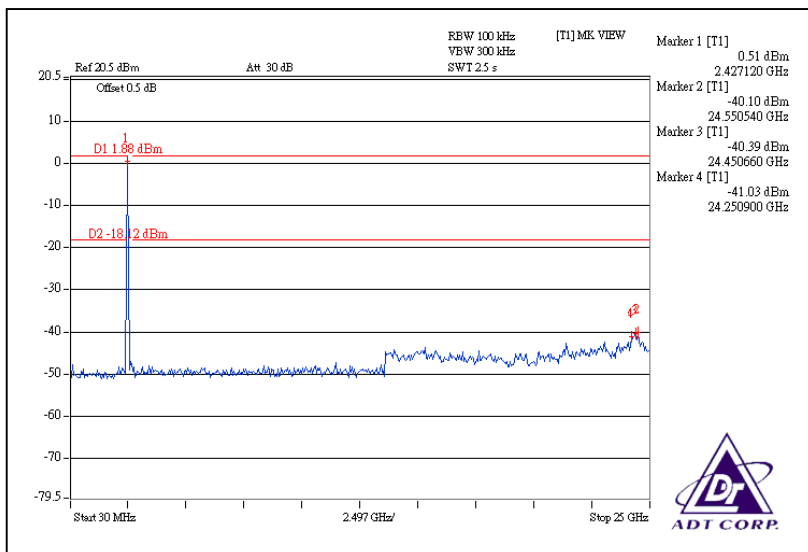

## DRAFT 802.11n (20MHz) OFDM MODULATION:

CH1

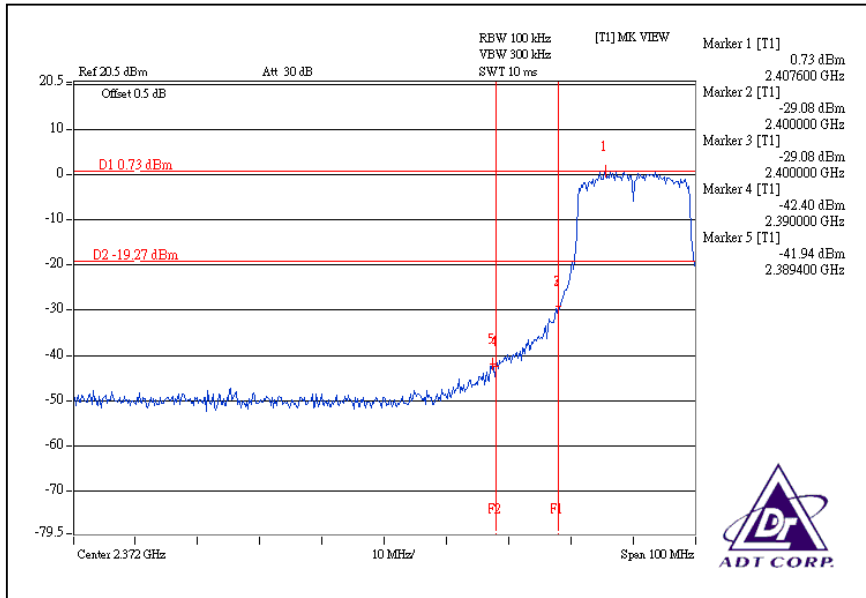

CH11

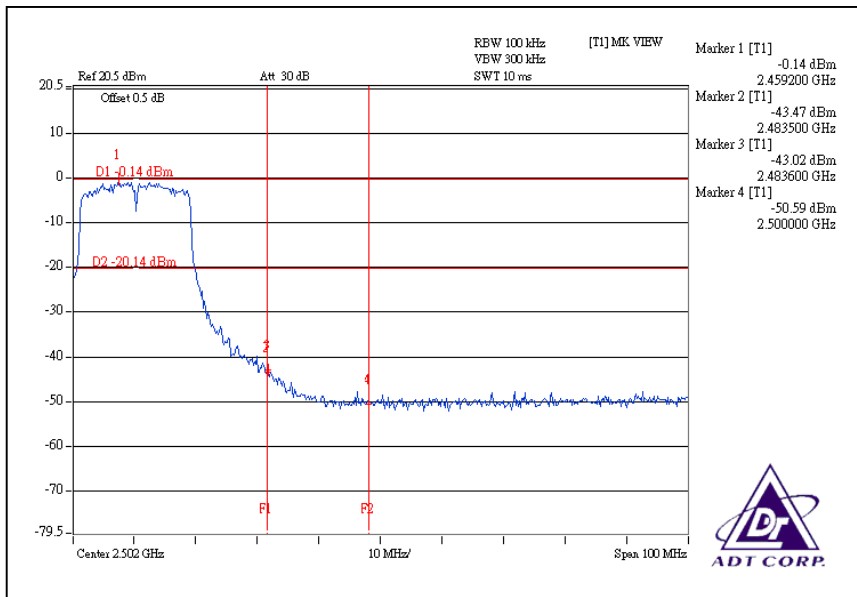

### CH1

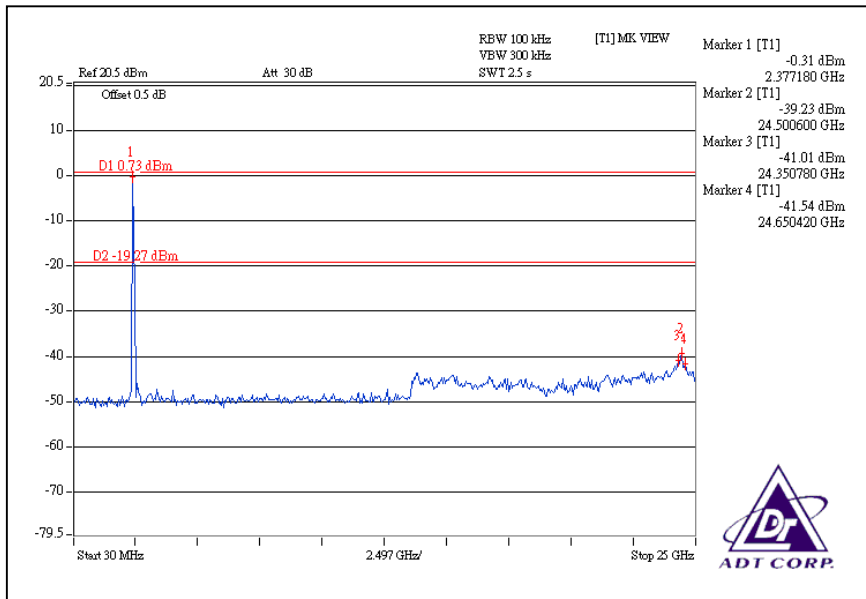

### CH11

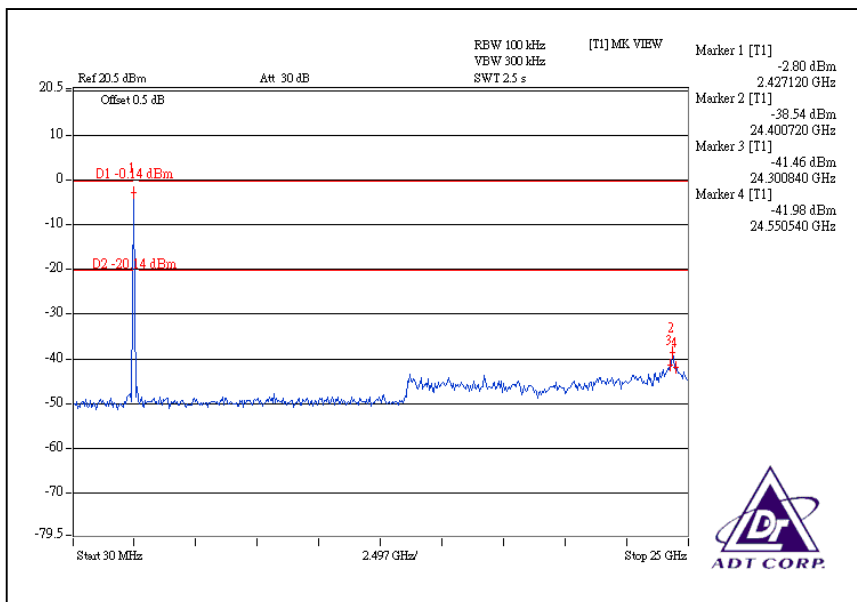

## DRAFT 802.11n (40MHz) OFDM MODULATION:

### CH1

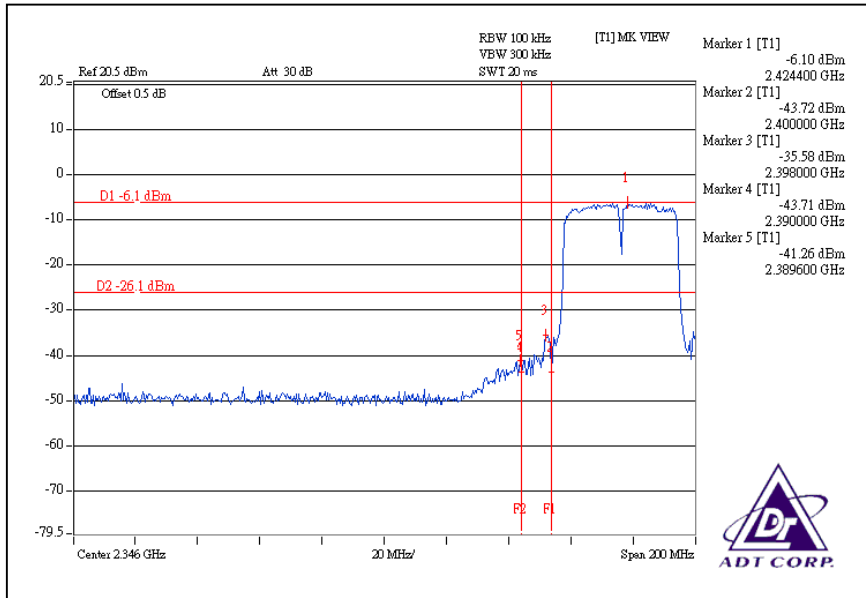

### CH7

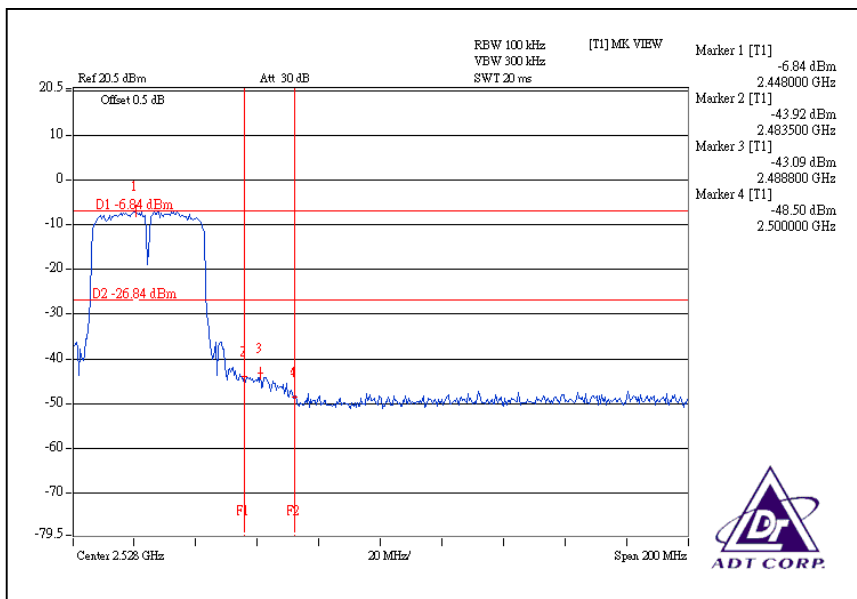

### CH1

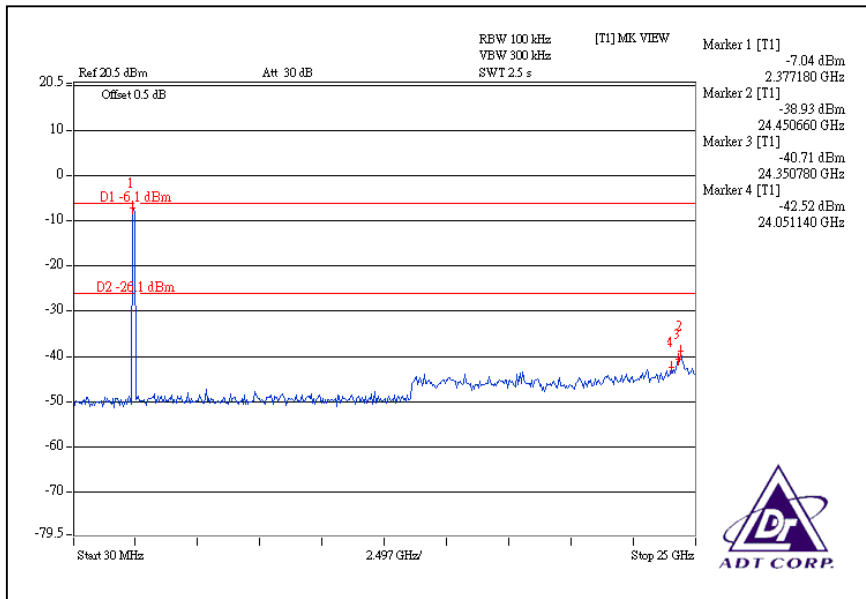

### CH7

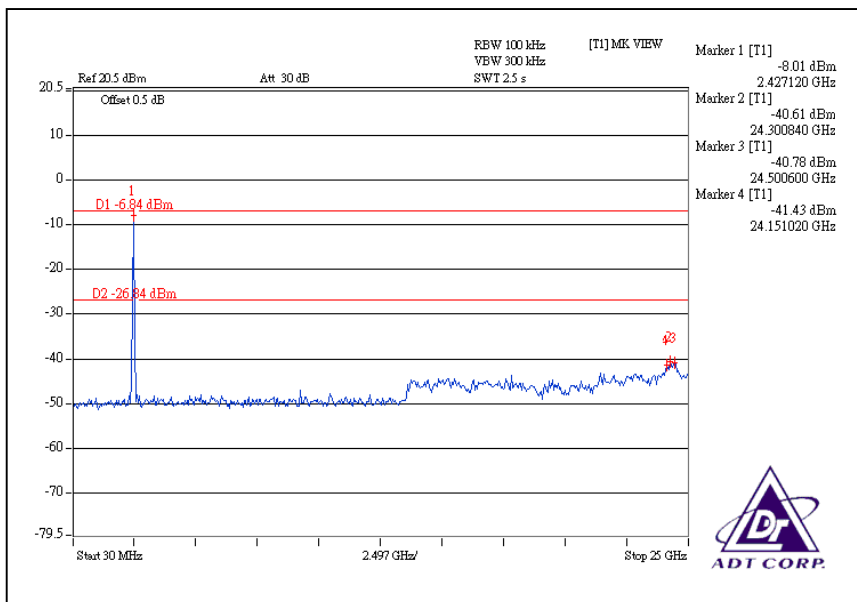

## 4.7 ANTENNA REQUIREMENT

### 4.7.1 STANDARD APPLICABLE

For intentional device, according to FCC 47 CFR Section 15.203, an intentional radiator shall be designed to ensure that no antenna other than that furnished by the responsible party shall be used with the device. And according to FCC 47 CFR Section 15.247 (b), if transmitting antennas of directional gain greater than 6dBi are used, the power shall be reduced by the amount in dB that the directional gain of the antenna exceeds 6dBi.

### 4.7.2 ANTENNA CONNECTED CONSTRUCTION

There are two antennas provided to this EUT, please refer to the following table:

Transmitter Circuit	Antenna Type	Antenna Connector	Gain(dBi)
Chain(0)	Dipole	Reverse SMA	2
Chain(1)	Dipole	Reverse SMA	2



## 5. INFORMATION ON THE TESTING LABORATORIES

We, ADT Corp., were founded in 1988 to provide our best service in EMC, Radio, Telecom and Safety consultation. Our laboratories are accredited and approved by the following approval agencies according to ISO/IEC 17025.

<b>USA</b>	FCC, UL, A2LA
<b>Germany</b>	TUV Rheinland
<b>Japan</b>	VCCI
<b>Norway</b>	NEMKO
<b>Canada</b>	INDUSTRY CANADA , CSA
<b>R.O.C.</b>	TAF, BSMI, NCC
<b>Netherlands</b>	Telefication
<b>Singapore</b>	GOST-ASIA(MOU)
<b>Russia</b>	CERTIS(MOU)

Copies of accreditation certificates of our laboratories obtained from approval agencies can be downloaded from our web site:

[www.adt.com.tw/index.5/phtml](http://www.adt.com.tw/index.5/phtml). If you have any comments, please feel free to contact us at the following:

**Linko EMC/RF Lab:**

Tel: 886-2-26052180

Fax: 886-2-26052943

**Hsin Chu EMC/RF Lab:**

Tel: 886-3-5935343

Fax: 886-3-5935342

**Hwa Ya EMC/RF/Safety Telecom Lab:**

Tel: 886-3-3183232

Fax: 886-3-3185050

**Web Site:** [www.adt.com.tw](http://www.adt.com.tw)

The address and road map of all our labs can be found in our web site also



## **6. APPENDIX A - MODIFICATIONS RECORDERS FOR ENGINEERING CHANGES TO THE EUT BY THE LAB**

No any modifications are made to the EUT by the lab during the test.