

# FCC TEST REPORT

according to

## FCC Rules and Regulations Part 15 Subpart B & C

Applicant	AboCom Systems, Inc.
Address	1F, No. 21, Yanfa 2 <sup>nd</sup> Rd., SBIP, Hsinchu City 300, Taiwan(R.O.C)
Equipment	802.11b/g Wireless LAN MiniPCI Card
Model No.	WMG2400
FCC ID	MQ4WMG2400
Trade Name	AboCom

- The test result refers exclusively to the test presented test model / sample.
- Without written approval of *Exclusive Certification Corp.* the test report shall not be reproduced except in full.

## Contents

1.	Report of Measurements and Examinations .....	4
1.1.	List of Measurements and Examinations .....	4
1.2.	Antenna Requirements .....	5
1.3.	Test of Conducted Emission.....	6
1.4.	Test of Radiated Emission .....	8
1.5.	6dB Bandwidth .....	9
1.6.	Maximum Peak Output Power.....	9
1.7.	Band Edges Measurement .....	10
1.8.	Power Spectral Density .....	10
1.9.	Restricted Bands of Operation .....	11
1.10.	Labeling Requirement .....	11
1.11.	RF Exposure .....	12
2.	Test Configuration of Equipment under Test.....	14
2.1.	Test Mode .....	14
2.2.	Description of Test System .....	14
2.3.	Connection Diagram of Test System.....	15
2.4.	Feature of Equipment under Test .....	15
2.5.	History of this test report.....	15
3.	General Information of Test.....	16
4.	Test Result and Data.....	17
4.1.	Antenna Requirement .....	17
4.2.	Test Result of Conducted Emission .....	18
4.3.	RF Portion.....	31
4.4.	6dB Bandwidth Measurement Data .....	61
4.5.	Peak Output Power Measurement Data.....	65
4.6.	Band Edges Measurement Data .....	69
4.7.	Power Spectral Density Measurement Data .....	95
4.8.	Test Result of RF Exposure Evaluation .....	99
5.	List of Measuring Equipment Used.....	101
	Appendix A. Photographs of EUT.....	A1 ~ A5

# CERTIFICATE OF COMPLIANCE

according to

## FCC Rules and Regulations Part 15 Subpart B & C

Applicant	AboCom Systems, Inc.
Address	1F, No. 21, Yanfa 2 <sup>nd</sup> Rd., SBIP, Hsinchu City 300, Taiwan(R.O.C)
Equipment	802.11b/g Wireless LAN MiniPCI Card
Model No.	WMG2400
FCC ID	MQ4WMG2400

### I HEREBY CERTIFY THAT :

The measurements shown in this test report were made in accordance with the procedures given in **ANSI C63.4**. The equipment was **passed** the test performed according to **FCC Rules and Regulations Part 15 Subpart B & C (2002)**. The test was carried out on Apr. 24, 2004 at *Exclusive Certification Corp.*

Signature

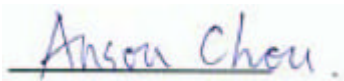

Anson Chou / Manager

## 1. Report of Measurements and Examinations

### 1.1. List of Measurements and Examinations

FCC Rule	Description of Test	Result
15.203	. Antenna Requirement	Pass
15.207	. Conducted Emission	Pass
15.209	. Radiated Emission	Pass
15.247(a)(2)	. 6dB Bandwidth	Pass
15.247(b)	. Maximum Peak Output Power	Pass
15.247(c)	. 100kHz Bandwidth of Frequency Band Edges	Pass
15.247(d)	. Power Spectral Density	Pass
1.1307 1.1310 2.1091 2.1093	. RF Exposure Compliance	Pass

## 1.2. Antenna Requirements

### 1.2.1. Standard Applicable

For intentional device, according to FCC 47 CFR Section 15.203, an intentional radiator shall be designed to ensure that no antenna other than that furnished by the responsible party shall be used with the device.

And according to FCC 47 CFR Section 15.247 (b), if transmitting antennas of directional gain greater than 6dBi are used, the power shall be reduced by the amount in dB that the directional gain of the antenna exceeds 6dBi.

### 1.3. Test of Conducted Emission

Conducted Emissions were measured from 150 kHz to 30 MHz with a bandwidth of 9 KHz on the 115 VAC power and return leads of the EUT according to the methods defined in ANSI C63.4-1992 Section 3.1. The EUT was placed on a nonmetallic stand in a shielded room 0.8 meters above the ground plane as shown in section 2.2. The interface cables and equipment positioning were varied within limits of reasonable applications to determine the position produced maximum conducted emissions.

#### 1.3.1. Test Procedures

- a. The EUT was placed 0.4 meter from the conducting wall of the shielding room was kept at least 80 centimeters from any other grounded conducting surface.
- b. Connect EUT to the power mains through a line impedance stabilization network (LISN).
- c. All the support units are connecting to the other LISN.
- d. The LISN provides 50 ohm coupling impedance for the measuring instrument.
- e. The FCC states that a 50 ohm, 50 microhenry LISN should be used.
- f. Both sides of AC line were checked for maximum conducted interference.
- g. The frequency range from 150 kHz to 30 MHz was searched.
- h. Set the test-receiver system to Peak Detect Function and Specified Bandwidth with Maximum Hold Mode.

1.3.2. Typical Test Setup Layout of Conducted Emission

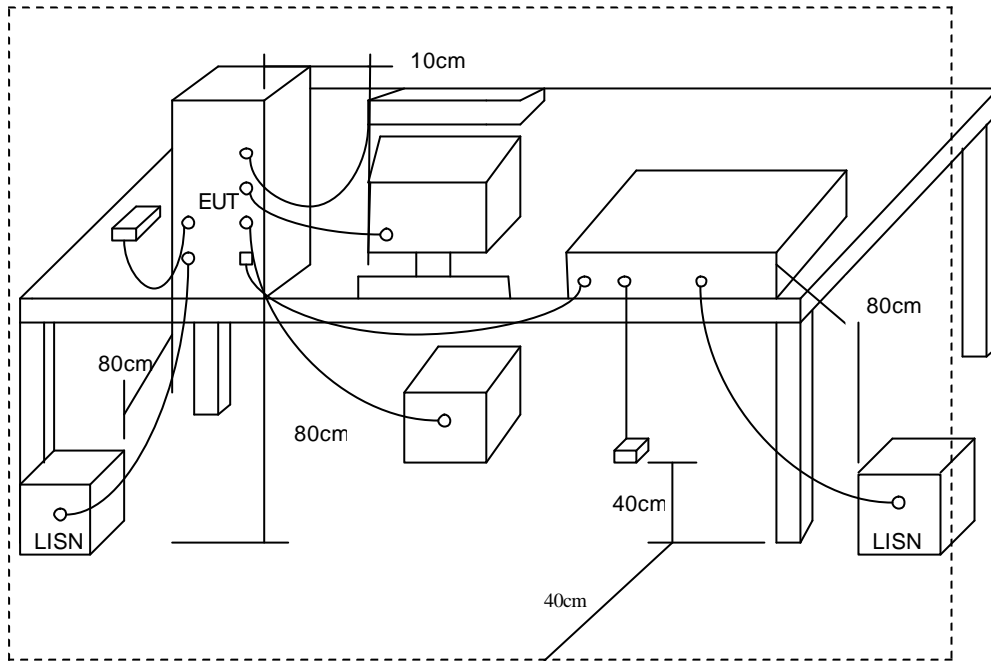

1.3.3. Conducted Emission Requirement

Except for A digital devices, for equipment that is designed to be connected to the public utility (AC) power line on any frequency voltage that is conducted back onto the AC power line on ant frequency or frequencies within the band 150KHz to 30MHz shall not exceed the limits in the following table, as measured using a 50μH/50 ohms line impeddnce stabilization network (LISN). Compliance with the provisions of this paragraph shall be based on the measurement of the Radio frequency voltage between each power line and ground at the power terminal. The lower limit applies at the band edges.

Frequency (MHz)	Quasi Peak (dB μ V)	Average (dB μ V)
0.15 – 0.5	66-56*	56-46*
0.5 – 5.0	56	46
5.0 – 30.0	60	50

## 1.4. Test of Radiated Emission

Radiated emissions from 30 MHz to 25 GHz were measured according to the methods defines in ANSI C63.4-2001. The EUT was placed, 0.8 meter above the ground plane, as shown in section 5.6.3. The interface cables and equipment positions were varied within limits of reasonable applications to determine the positions producing maximum radiated emissions

### 1.4.1. Test Procedures

1. The EUT was placed on a rotatable table top 0.8 meter above ground.
2. The EUT was set 3 meters from the interference receiving antenna which was mounted on the top of a variable height antenna tower.
3. The table was rotated 360 degrees to determine the position of the highest radiation.
4. The antenna is a broadband antenna and its height is varied between one meter and four meters above ground to find the maximum value of the field strength both horizontal polarization and vertical polarization of the antenna are set to make the measurement.
5. For each suspected emission the EUT was arranged to its worst case and then tune the antenna tower (from 1 M to 4 M) and turn table (from 0 degree to 360 degrees) to find the maximum reading.
6. Set the test-receiver system to Peak or CISPR quasi-peak Detect Function and specified bandwidth with Maximum Hold Mode.
7. If the emission level of the EUT in peak mode was 3 dB lower than the limit specified, then testing will be stopped and peak values of EUT will be reported, otherwise, the emissions which do not have 3 dB margin will be repeated one by one using the quasi-peak method and reported.
8. For testing above 1GHz, the emission level of the EUT in peak mode was 20dB lower than average limit (that means the emission level in peak mode also complies with the limit in average mode), then testing will be stopped and peak values of EUT will be reported, otherwise, the emissions will be measured in average mode again and reported.

### 1.4.2. Typical Test Setup Layout of Radiated Emission

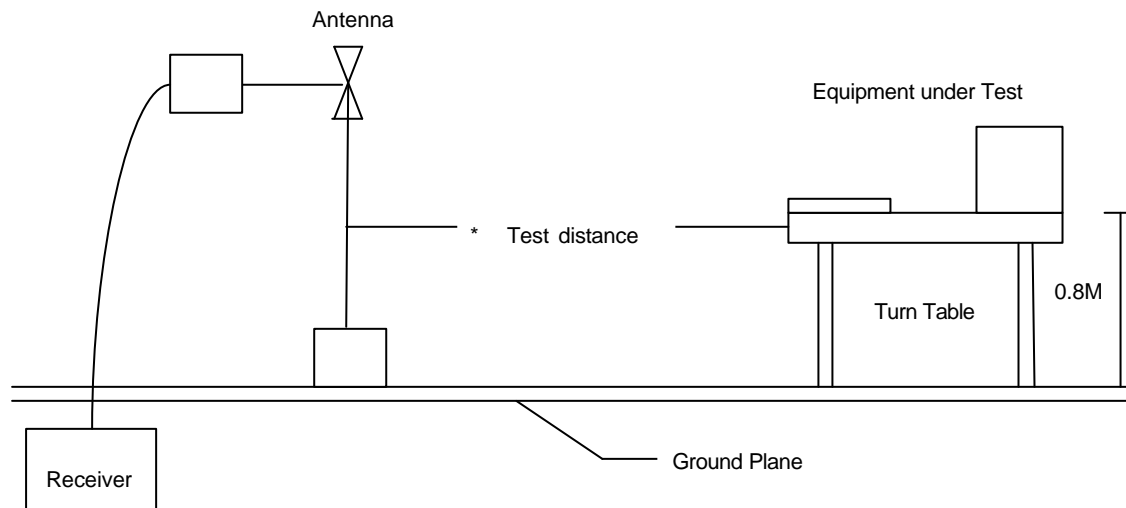



## 1.5. 6dB Bandwidth

### 1.5.1. Test Procedure :

1. The transmitter output was connected to the spectrum analyzer.
2. Set RBW of spectrum analyzer to 100 KHz and VBW to 100 KHz.
3. The 6 dB bandwidth is defined as the total spectrum the power of which is higher than peak power minus 6 dB.

### 1.5.2. Test Setup Layout :

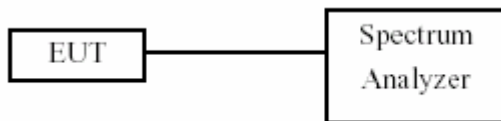

## 1.6. Maximum Peak Output Power

### 1.6.1. Test Procedure :

The antenna port ( RF output ) of the EUT was connected to the input ( RF input ) of a spectrum analyzer. Power was read directly from the meter and cable loss connection was added to the reading to obtain power at the EUT antenna terminal. The EUT Output Power was set to maximum to produce the worse case test result.

### 1.6.2. Test Setup Layout :

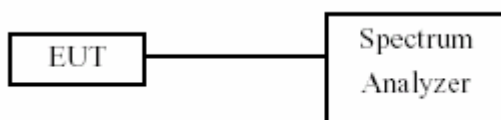

## 1.7. Band Edges Measurement

### 1.7.1. Test Procedure :

1. The transmitter output was connected to the spectrum analyzer via a low lose cable.
2. Set both RBW and VBW of spectrum analyzer to 100 KHz with convenient frequency span including 100 KHz bandwidth from band edge.
3. The band edges was measured and recorded.

## 1.8. Power Spectral Density

### 1.8.1. Test Procedure :

1. The transmitter output was connected to spectrum analyzer.
2. The spectrum analyzer' s resolution bandwidth were set at 3KHz RBW and 30KHz VBW as that of the fundamental frequency. Set the sweep time=span/3KHz.
3. The power spectral density was measured and recorded.
4. The Sweep time is allowed to be longer than span/3KHz for a full response of the mixer in the spectrum analyzer.

### 1.8.2. Test Setup Layout :

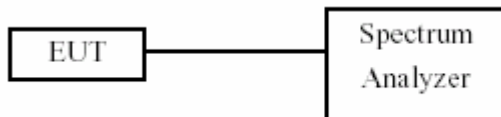

### 1.9. Restricted Bands of Operation

Only spurious emissions are permitted in any of the frequency bands listed below:

MHz	MHz	MHz	GHz
0.09000 – 0.11000	16.42000 – 16.42300	399.9 – 410.0	4.500 – 5.250
0.49500 – 0.505**	16.69475 – 16.69525	608.0 – 614.0	5.350 – 5.460
2.17350 – 2.19050	16.80425 – 16.80475	960.0 – 1240.0	7.250 – 7.750
4.12500 – 4.12800	25.50000 – 25.67000	1300.0 – 1427.0	8.025 – 8.500
4.17725 – 4.17775	37.50000 – 38.25000	1435.0 – 1626.5	9.000 – 9.200
4.20725 – 4.20775	73.00000 – 74.60000	1645.5 – 1646.5	9.300 – 9.500
6.21500 – 6.21800	74.80000 – 75.20000	1660.0 – 1710.0	10.600 – 12.700
6.26775 – 6.26825	108.00000 – 121.94000	1718.8 – 1722.2	13.250 – 13.400
6.31175 – 6.31225	123.00000 – 138.00000	2200.0 – 2300.0	14.470 – 14.500
8.29100 – 8.29400	149.90000 – 150.05000	2310.0 – 2390.0	15.350 – 16.200
8.36200 – 8.36600	156.52475 – 156.52525	2483.5 – 2500.0	17.700 – 21.400
8.37625 – 8.38675	156.70000 – 156.90000	2655.0 – 2900.0	22.010 – 23.120
8.41425 – 8.41475	162.01250 – 167.17000	3260.0 – 3267.0	23.600 – 24.000
12.29000 – 12.29300	167.72000 – 173.20000	3332.0 – 3339.0	31.200 – 31.800
12.51975 – 12.52025	240.00000 – 285.00000	3345.8 – 3358.0	36.430 – 36.500
12.57675 – 12.57725	322.00000 – 335.40000	3600.0 – 4400.0	Above 38.6
13.36000 – 13.41000			

\*\* : Until February 1, 1999, this restricted band shall be 0.490-0.510 MHz

### 1.10. Labeling Requirement

The device shall bear the following statement in a conspicuous location on the device:

This device complies with part 15 of the FCC Rules. Operation is subject to the following two conditions: (1) This device may not cause harmful interference, and (2) this device must accept any interference received, including interference that may cause undesired operation.

**1.11. RF Exposure**

FCC Rules and Regulations Part 1.1307, 1.1310, 2.1091, 2.1093:

RF Exposure Compliance

1.11.1. Limit For Maximum Permissible Exposure (MPE)

(A) Limits for Occupational / Controlled Exposure

Frequency Range (MHz)	Electric Field Strength (E) (V/m)	Magnetic Field Strength (H) (A/m)	Power Density (S) (mW/ cm <sup>2</sup> )	Averaging Time  E  <sup>2</sup> , H  <sup>2</sup> or S (minutes)
0.3-3.0	614	1.63	(100)*	6
3.0-30	1842/f	4.89/f	(900/f)*	6
30-300	61.4	0.163	1.0	6
300-1500			F/300	6
1500-100,000			5	6

(B) Limits for General Population / Uncontrolled Exposure

Frequency Range (MHz)	Electric Field Strength (E) (V/m)	Magnetic Field Strength (H) (A/m)	Power Density (S) (mW/cm <sup>2</sup> )	Averaging Time  E  <sup>2</sup> , H  <sup>2</sup> or S ( minutes )
0.3-1.34	614	1.63	(100)*	30
1.34-30	824/f	2.19/f	(180/f)*	30
30-300	27.5	0.073	0.2	30
300-1500			F/1500	30
1500-100,000			1.0	30

F=frequency in MHz

\*Plane-wave equivalent power density

## 1.11.2. MPE Calculations

$$E \text{ (V/m)} = \frac{\sqrt{30 \cdot P \cdot G}}{d} \quad \text{Power Density: } Pd \text{ (mW/cm}^2\text{)} = \frac{E^2}{3770}$$

E = Electric field (V/m)

P = Peak output power (W)

G = Antenna numeric gain (numeric)

d = Separation distance (m)

Because the EUT is belong to General Population/ Uncontrolled Exposure. So the Limit of Power Density is 10 W/m<sup>2</sup>. We can change the formula to:

$$d = \sqrt{\frac{30 \cdot P \cdot G}{3770}}$$

## 1.11.3. FCC Radiation Exposure Statement

This equipment complies with FCC radiation exposure limits set forth for an uncontrolled environment. In order to avoid the possibility of exceeding the FCC radio frequency exposure limits, human proximity to the antenna shall not be less than 20cm (8 inches) during normal operation. Proposed RF exposure safety information to include in User's Manual.

## 2. Test Configuration of Equipment under Test

### 2.1. Test Mode

The following test mode was performed for conduction test:

- 802.11b (CH LO) • 802.11b (CH MID) • 802.11b (CH HI)
- 802.11g (CH LO) • 802.11g (CH MID) • 802.11g (CH HI)

The following test mode was performed for radiation test:

- Receiving / Transmitting

### 2.2. Description of Test System

Device	Manufacturer	Model No.	Description
Notebook	IBM	R40(2723-BV1)	Power Cord, Unshielding, 1.8m
AP Router	Abocom	ARM804	Power Cord, Unshielding, 1.8m

### 2.3. Connection Diagram of Test System

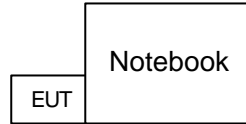

### 2.4. Feature of Equipment under Test

- Complies with IEEE 802.11b/802.11g standard for 2.4GHz Wireless LAN.
- Type III-b MiniPCI form factor for standard compatibility in a variety of mobile devices
- Works with all existing network infrastructure.
- Complies with specific wireless products and services.
- Up to 256-Bit WEP Encryption for data security.
- Freedom to roam while staying connected.
- 22-Mbps Packet Binary Convolution Coding (PBCC)(according to the IEEE Std 802.11b high-rate specification)
- High-speed transfer rate of up to 54 Mbps in 802.11g mode of operation
- Supports Windows98SE/2000/ME/XP
- Lower power consumption.
- Easy to install and configure.

### 2.5. History of this test report

ORIGINAL.

### 3. General Information of Test

Test Site:	Exclusive Certification Corp. 4F-2, No. 28, Lane 78, Xing-Ai Rd. Nei-hu, Taipei City 114 Taiwan R.O.C.
Test Site Location (OATS1-SD):	No.68-1, Shihbachongsi, shihding Township, Taipei County 223, Taiwan, R.O.C.
Test Voltage:	AC 110V/ 60Hz
Test in Compliance with:	ANSI C63.4-1992 FCC Part 15 Subpart C
Frequency Range Investigated:	Conducted: from 150 kHz to 30 MHz Radiation: from 30 MHz to 24620 MHz
Test Distance:	The test distance of radiated emission from antenna to EUT is 3 M.



## 4. Test Result and Data

### 4.1. Antenna Requirement

#### 4.1.1. Antenna Construction and Directional Gain

Antenna type 1: SMA Straight Plug/Reverse; the maximum antenna gain: 1.8 dBi.

Antenna type 2: Reverse SMA Connector; the maximum antenna gain: 5 dBi.

Antenna type 3: Reverse SMA Plug straight; the maximum antenna gain: 0 dBi.

4.2. Test Result of Conducted Emission

EUT : WMG2400 A20  
 Power : 110V 60Hz  
 Test Mode : 802.11b CH LO  
 Memo :

Pol/Phase : NEUTRAL  
 Temperature : 23 °C  
 Humidity : 61 %

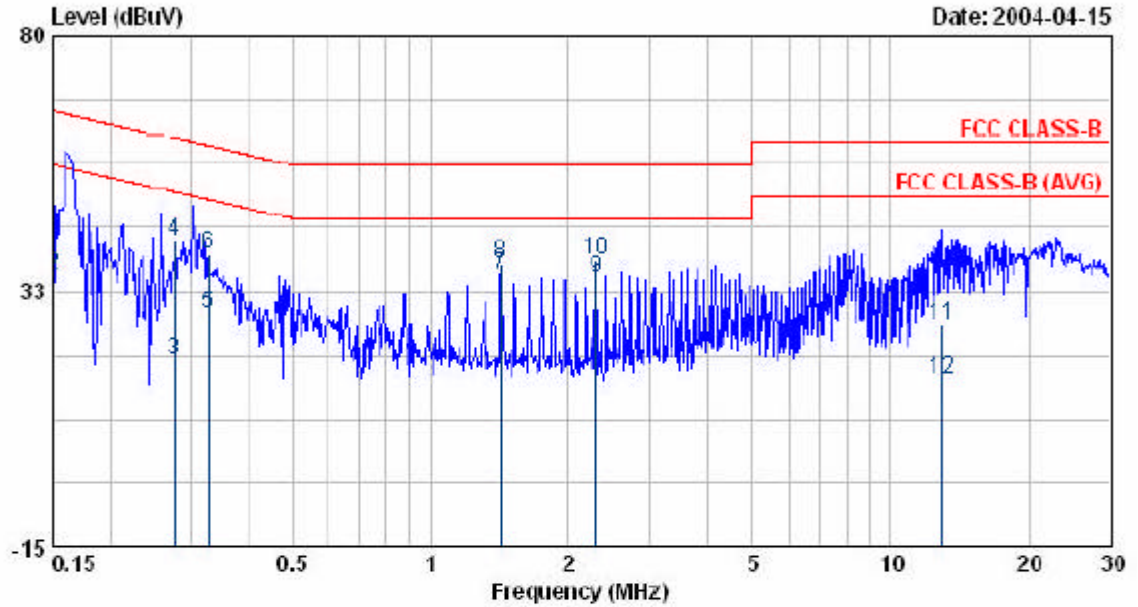

Freq	Read Level	Factor	Level	Limit	Over Limit	Remark
MHz	dBuV	dB	dBuV	dBuV	dBuV	
0.150	55.06	0.30	55.36	65.99	-10.63	QP
0.150	34.99	0.30	35.29	55.99	-20.70	AVERAGE
0.278	19.55	0.34	19.89	50.89	-31.00	AVERAGE
0.278	41.55	0.34	41.89	60.89	-19.00	QP
0.328	27.80	0.35	28.15	49.50	-21.36	AVERAGE
0.320	39.09	0.35	39.44	59.50	-20.07	QP
1.424	35.06	0.43	35.49	46.00	-10.51	AVERAGE
1.424	37.19	0.43	37.62	56.00	-18.38	QP
2.300	34.37	0.45	34.82	46.00	-11.18	AVERAGE
2.300	37.73	0.45	38.18	56.00	-17.82	QP
12.989	25.44	0.54	25.98	60.00	-34.02	QP
12.989	15.82	0.54	16.36	50.00	-33.64	AVERAGE

EUT : WMG2400 A20  
 Power : 110V 60Hz  
 Test Mode : 802.11b CH L0  
 Memo :

Pol/Phase : LINE  
 Temperature : 24 °C  
 Humidity : 59 %

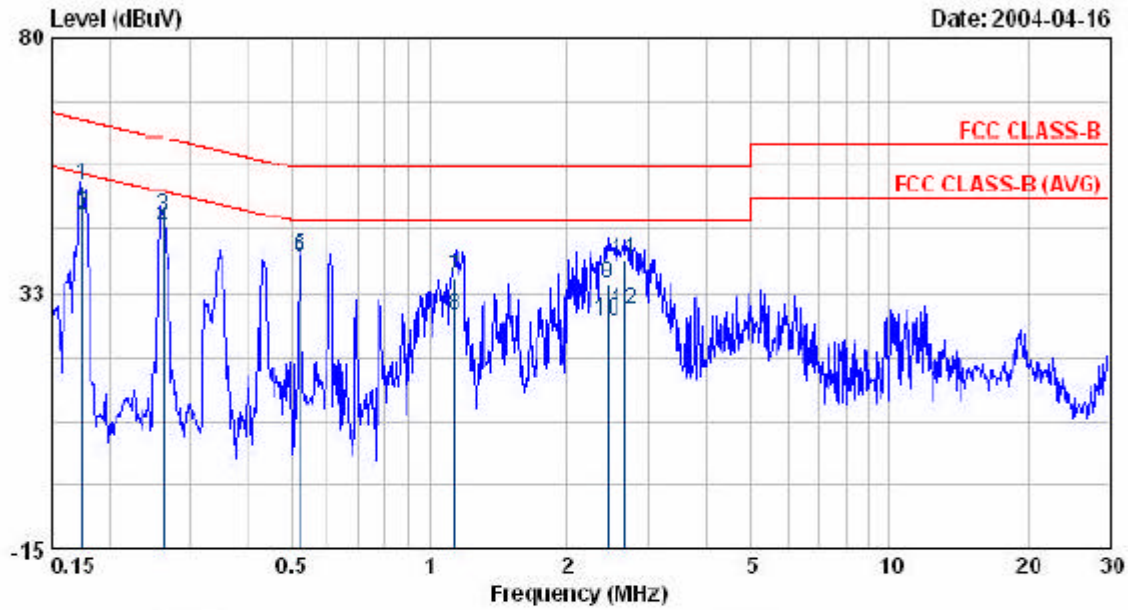

Freq	Read Level	Factor	Level	Limit	Over Limit	Remark
MHz	dBuV	dB	dBuV	dBuV	dBuV	
0.175	52.36	0.31	52.67	64.74	-12.07	QP
0.175	46.73	0.31	47.04	54.74	-7.70	AVERAGE
0.263	46.30	0.33	46.63	61.35	-14.72	QP
0.263	43.95	0.33	44.28	51.35	-7.07	AVERAGE
0.524	38.77	0.37	39.14	56.00	-16.86	QP
0.524	38.46	0.37	38.83	46.00	-7.17	AVERAGE
1.130	34.69	0.42	35.11	56.00	-20.89	QP
1.130	27.62	0.42	28.04	46.00	-17.96	AVERAGE
2.451	33.67	0.45	34.12	56.00	-21.88	QP
2.451	26.69	0.45	27.14	46.00	-18.86	AVERAGE
2.677	38.26	0.46	38.72	56.00	-17.28	QP
2.677	28.68	0.46	29.14	46.00	-16.86	AVERAGE

EUT : WMG2400 A20  
 Power : 110V 60Hz  
 Test Mode : 802.11b CH MID  
 Memo :

Pol/Phase : NEUTRAL  
 Temperature : 23 °C  
 Humidity : 61 %

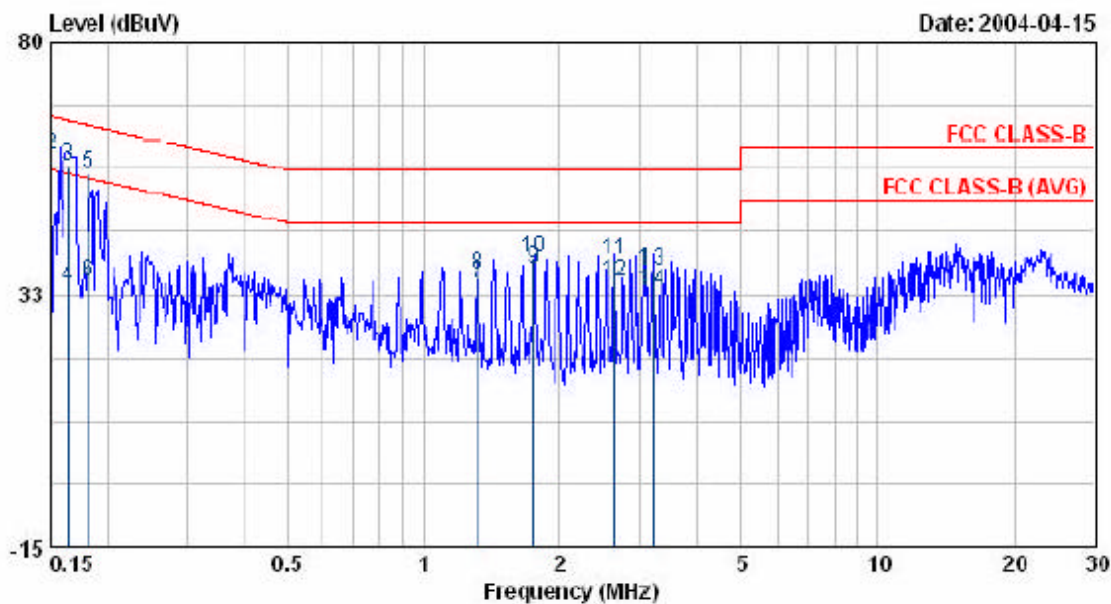

Freq	Read Level	Factor	Level	Limit	Over Limit	Remark
MHz	dBuV	dB	dBuV	dBuV	dBuV	
0.150	35.03	0.30	35.33	55.99	-20.66	AVERAGE
0.150	58.48	0.30	58.78	65.99	-7.21	QP
0.164	56.48	0.31	56.79	65.25	-8.47	QP
0.164	33.37	0.31	33.68	55.25	-21.58	AVERAGE
0.181	54.82	0.31	55.13	64.44	-9.31	QP
0.181	34.33	0.31	34.64	54.44	-19.80	AVERAGE
1.315	34.02	0.42	34.44	46.00	-11.56	AVERAGE
1.315	35.90	0.42	36.32	56.00	-19.68	QP
1.753	36.87	0.44	37.31	46.00	-8.69	AVERAGE
1.753	38.92	0.44	39.36	56.00	-16.64	QP
2.630	38.50	0.45	38.95	56.00	-17.05	QP
2.630	34.22	0.45	34.67	46.00	-11.33	AVERAGE
3.177	36.55	0.46	37.01	56.00	-18.99	QP
3.177	32.55	0.46	33.01	46.00	-12.99	AVERAGE

EUT : WMG2400 A20  
 Power : 110V 60Hz  
 Test Mode : 802.11b CH MID  
 Memo :

Pol/Phase : LINE  
 Temperature : 24 °C  
 Humidity : 59 %

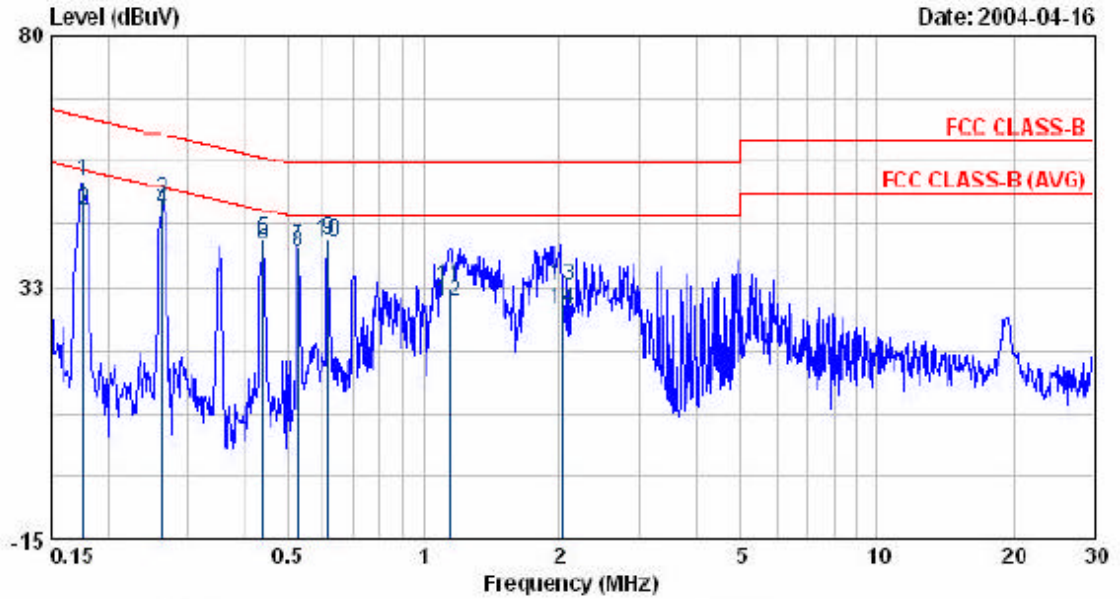

Freq	Read Level	Factor	Level	Limit	Over Limit	Remark
MHz	dBuV	dB	dBuV	dBuV	dBuV	
0.176	52.26	0.31	52.57	64.66	-12.09	QP
0.176	46.65	0.31	46.96	54.66	-7.70	AVERAGE
0.263	48.57	0.33	48.90	61.32	-12.42	QP
0.263	46.69	0.33	47.02	51.32	-4.30	AVERAGE
0.441	40.87	0.36	41.23	57.05	-15.81	QP
0.441	39.92	0.36	40.28	47.05	-6.76	AVERAGE
0.529	39.64	0.38	40.02	56.00	-15.98	QP
0.529	38.69	0.38	39.07	46.00	-6.93	AVERAGE
0.617	40.96	0.38	41.34	56.00	-14.66	QP
0.617	40.81	0.38	41.19	46.00	-4.81	AVERAGE
1.144	31.92	0.42	32.34	56.00	-23.66	QP
1.144	29.08	0.42	29.50	46.00	-16.50	AVERAGE
2.027	32.24	0.44	32.68	56.00	-23.32	QP
2.027	27.55	0.44	27.99	46.00	-18.01	AVERAGE



EUT : WMG2400 A20  
 Power : 110V 60Hz  
 Test Mode : 802.11b CH HI  
 Memo :

Pol/Phase : NEUTRAL  
 Temperature : 23 °C  
 Humidity : 61 %

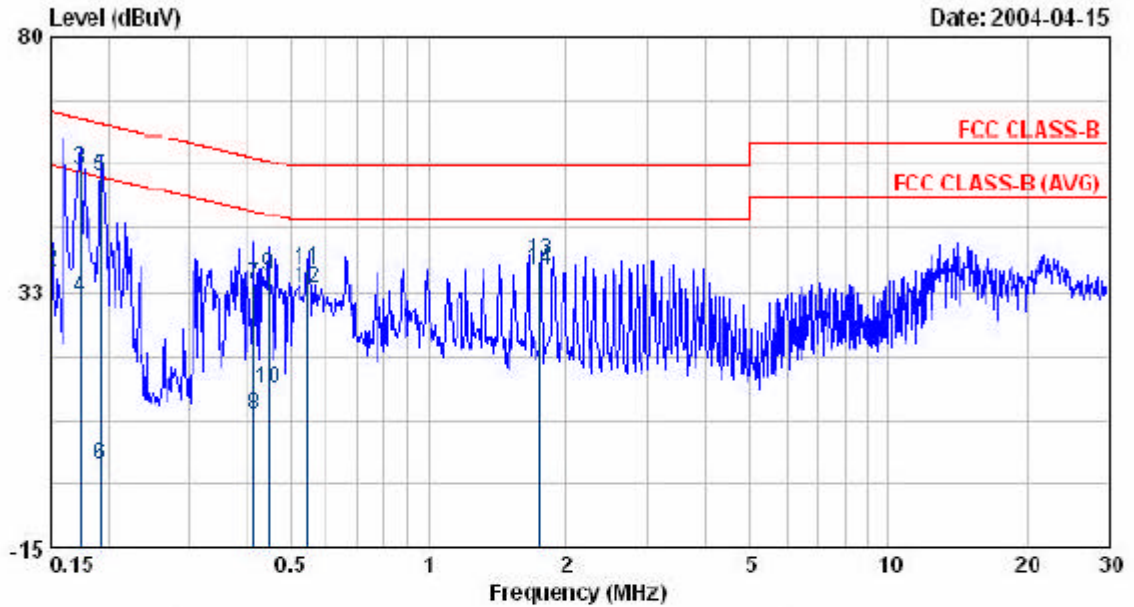

Freq	Read Level	Factor	Level	Limit	Over Limit	Remark
MHz	dBuV	dB	dBuV	dBuV	dBuV	
0.150	58.47	0.30	58.77	65.99	-7.22	QP
0.150	35.80	0.30	36.10	55.99	-19.89	AVERAGE
0.174	55.00	0.31	55.31	64.77	-9.46	QP
0.174	31.14	0.31	31.45	54.77	-23.32	AVERAGE
0.192	53.45	0.31	53.76	63.93	-10.17	QP
0.192	---	0.31	0.31	53.93	-53.62	AVERAGE
0.416	33.25	0.36	33.61	57.53	-23.92	QP
0.416	9.19	0.36	9.55	47.53	-37.98	AVERAGE
0.446	35.20	0.37	35.57	56.95	-21.38	QP
0.446	14.31	0.37	14.68	46.95	-32.27	AVERAGE
0.547	35.99	0.38	36.37	56.00	-19.63	QP
0.547	32.59	0.38	32.97	46.00	-13.03	AVERAGE
1.752	37.86	0.44	38.30	56.00	-17.70	QP
1.752	35.99	0.44	36.43	46.00	-9.57	AVERAGE

EUT : WMG2400 A20  
 Power : 110V 60Hz  
 Test Mode : 802.11b CH HI  
 Memo :

Pol/Phase : LINE  
 Temperature : 24 °C  
 Humidity : 59 %

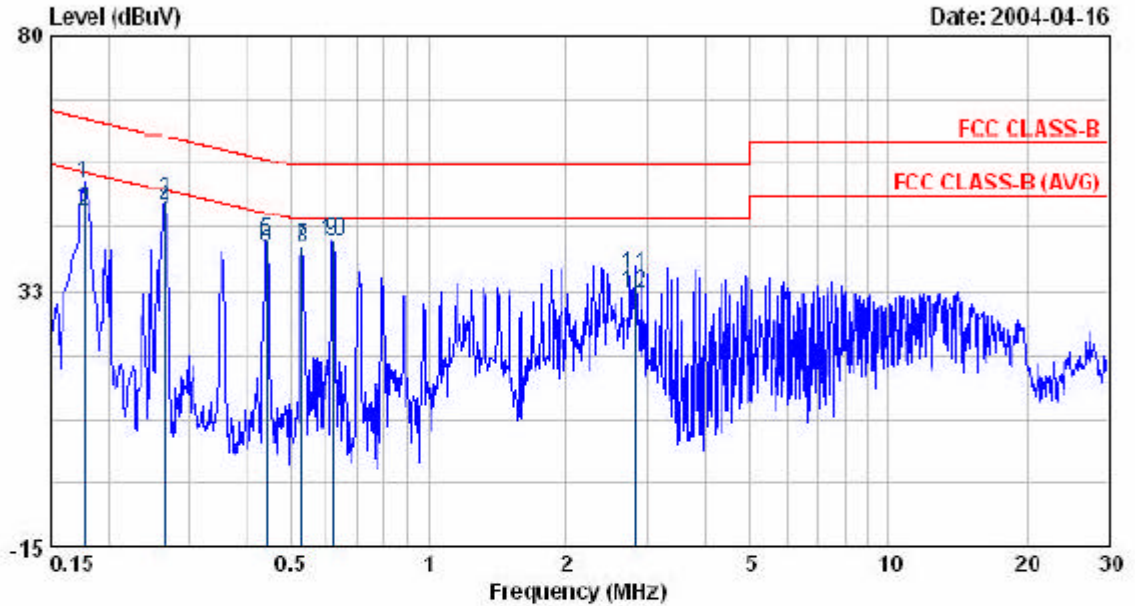

Freq	Read Level	Factor	Level	Limit	Over Limit	Remark
MHz	dBuV	dB	dBuV	dBuV	dBuV	
0.177	52.25	0.31	52.56	64.63	-12.07	QP
0.177	47.00	0.31	47.31	54.63	-7.32	AVERAGE
0.265	48.90	0.33	49.23	61.26	-12.03	QP
0.265	47.16	0.33	47.49	51.26	-3.77	AVERAGE
0.443	41.20	0.36	41.56	57.01	-15.45	QP
0.443	40.37	0.36	40.73	47.01	-6.28	AVERAGE
0.531	40.22	0.38	40.60	56.00	-15.40	QP
0.531	39.87	0.38	40.25	46.00	-5.75	AVERAGE
0.619	41.19	0.38	41.57	46.00	-4.43	AVERAGE
0.619	41.32	0.38	41.70	56.00	-14.30	QP
2.831	34.93	0.46	35.39	56.00	-20.61	QP
2.831	31.64	0.46	32.10	46.00	-13.90	AVERAGE

EUT : WMG2400 A20  
 Power : 110V 60Hz  
 Test Mode : 802.11g CH L0  
 Memo :

Pol/Phase : NEUTRAL  
 Temperature : 24 °C  
 Humidity : 59 %

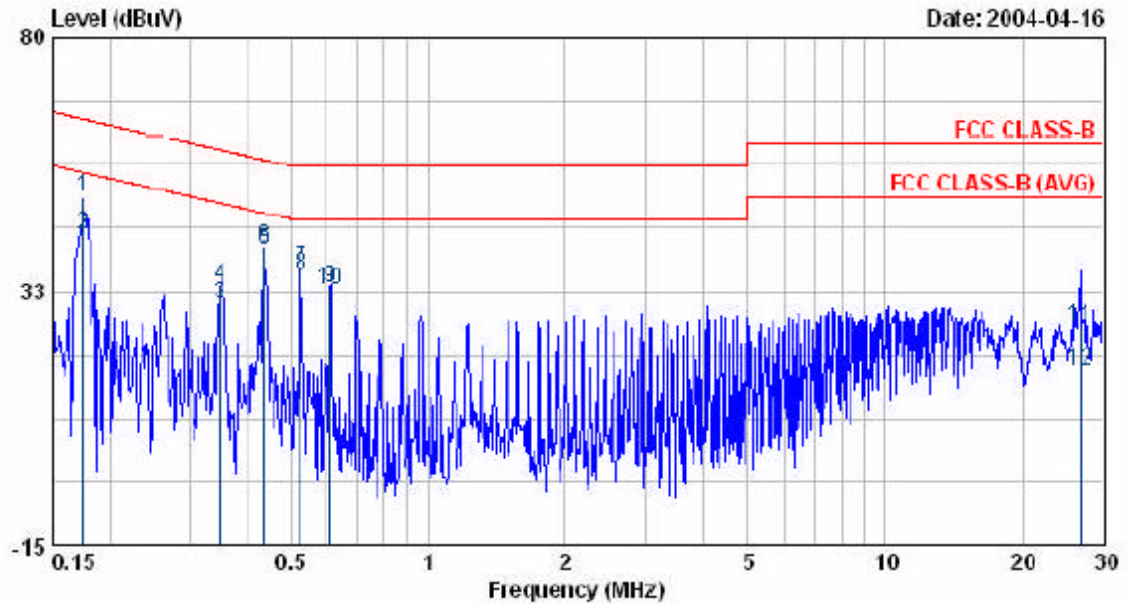

Freq	Read Level	Factor	Level	Limit	Over Limit	Remark
MHz	dBuV	dB	dBuV	dBuV	dBuV	
0.175	49.83	0.31	50.14	64.72	-14.58	QP
0.175	42.75	0.31	43.06	54.72	-11.66	AVERAGE
0.349	29.48	0.35	29.83	48.98	-19.15	AVERAGE
0.349	33.01	0.35	33.36	58.98	-25.62	QP
0.437	39.53	0.36	39.89	47.12	-7.22	AVERAGE
0.437	40.22	0.36	40.50	57.12	-16.53	QP
0.525	36.26	0.37	36.63	56.00	-19.37	QP
0.525	35.11	0.37	35.48	46.00	-10.52	AVERAGE
0.612	32.75	0.38	33.13	56.00	-22.87	QP
0.612	32.13	0.38	32.51	46.00	-13.49	AVERAGE
26.718	24.95	0.59	25.54	60.00	-34.46	QP
26.718	17.21	0.59	17.80	50.00	-32.20	AVERAGE



EUT : WMG2400 A20  
 Power : 110V 60Hz  
 Test Mode : 802.11g CH LO  
 Memo :

Pol/Phase : LINE  
 Temperature : 24 °C  
 Humidity : 59 %

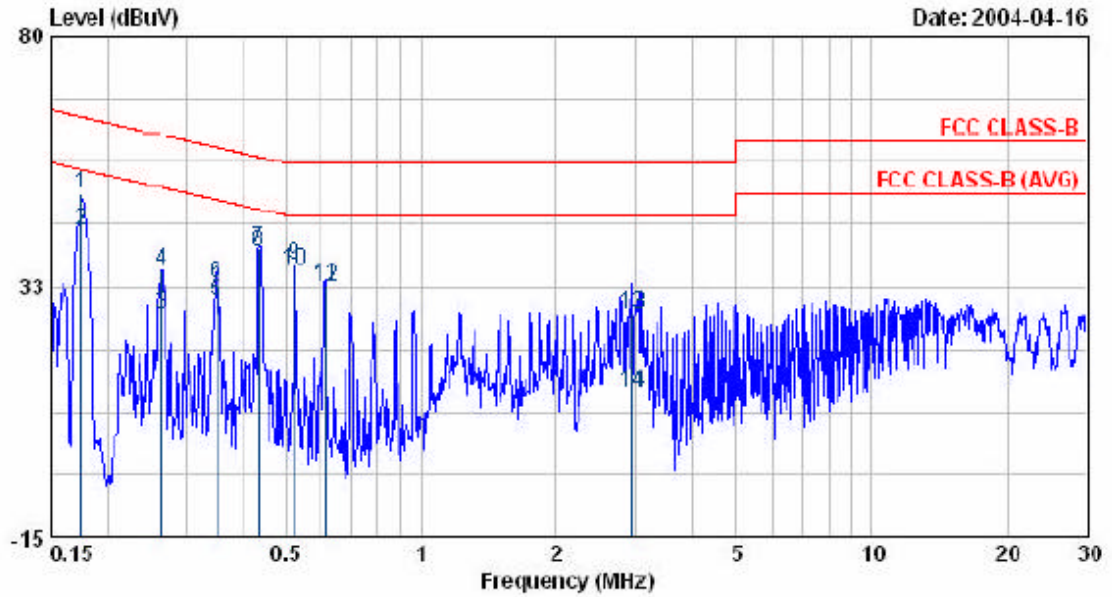

Freq	Read Level	Factor	Level	Limit	Over Limit	Remark
MHz	dBuV	dB	dBuV	dBuV	dBuV	
0.175	49.88	0.31	50.19	64.74	-14.55	QP
0.175	42.82	0.31	43.13	54.74	-11.61	AVERAGE
0.263	26.87	0.33	27.20	51.33	-24.13	AVERAGE
0.263	35.24	0.33	35.57	61.33	-25.76	QP
0.350	29.14	0.35	29.49	48.96	-19.47	AVERAGE
0.350	32.69	0.35	33.04	50.96	-25.92	QP
0.435	39.40	0.36	39.76	57.15	-17.39	QP
0.435	38.62	0.36	38.98	47.15	-8.17	AVERAGE
0.524	36.13	0.37	36.50	56.00	-19.50	QP
0.524	34.95	0.37	35.32	46.00	-10.68	AVERAGE
0.613	32.44	0.38	32.82	56.00	-23.18	QP
0.613	31.87	0.38	32.25	46.00	-13.75	AVERAGE
2.963	26.61	0.46	27.07	56.00	-28.93	QP
2.963	11.95	0.46	12.41	46.00	-33.59	AVERAGE

EUT : WMG2400 A20  
 Power : 110V 60Hz  
 Test Mode : 802.11g CH MID  
 Memo :

Pol/Phase : NEUTRAL  
 Temperature : 24 °C  
 Humidity : 59 %

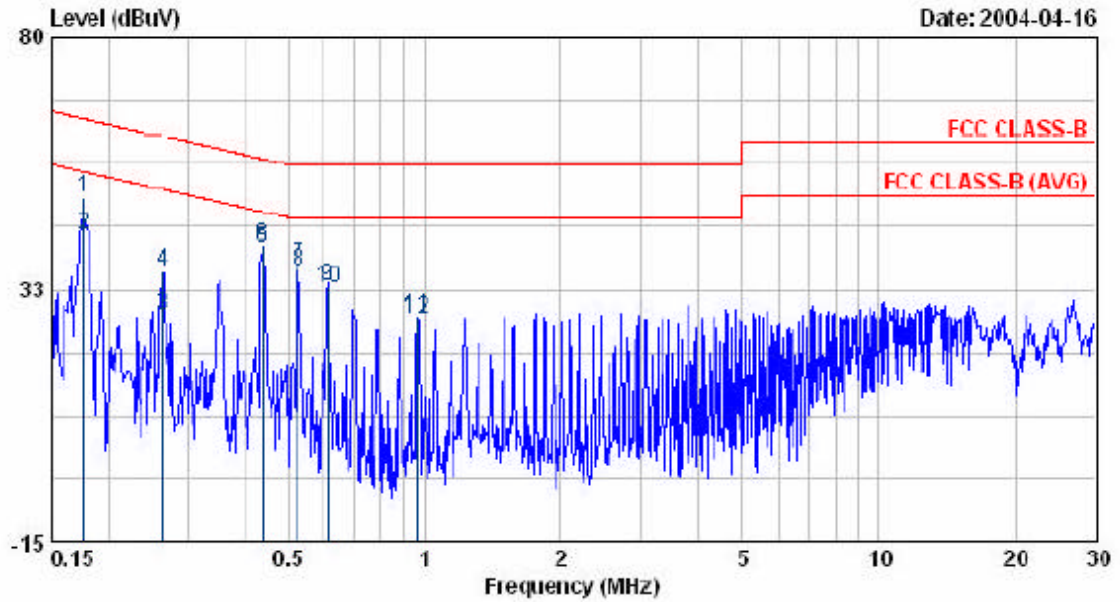

Freq	Read Level	Factor	Level	Limit	Over Limit	Remark
MHz	dBuV	dB	dBuV	dBuV	dBuV	
0.176	49.51	0.31	49.82	64.66	-14.84	QP
0.176	42.48	0.31	42.79	54.66	-11.87	AVERAGE
0.263	27.27	0.33	27.60	51.34	-23.73	AVERAGE
0.263	35.39	0.33	35.72	61.34	-25.61	QP
0.438	39.51	0.36	39.87	47.09	-7.22	AVERAGE
0.438	40.22	0.36	40.58	57.09	-16.51	QP
0.525	36.50	0.37	36.87	56.00	-19.13	QP
0.525	35.36	0.37	35.73	46.00	-10.27	AVERAGE
0.613	32.78	0.38	33.16	56.00	-22.84	QP
0.613	32.23	0.38	32.61	46.00	-13.39	AVERAGE
0.963	26.82	0.41	27.23	56.00	-28.77	QP
0.963	26.26	0.41	26.67	46.00	-19.33	AVERAGE

EUT : WMG2400 A20  
 Power : 110V 60Hz  
 Test Mode : 802.11g CH MID  
 Memo :

Pol/Phase : LINE  
 Temperature : 24 °C  
 Humidity : 59 %

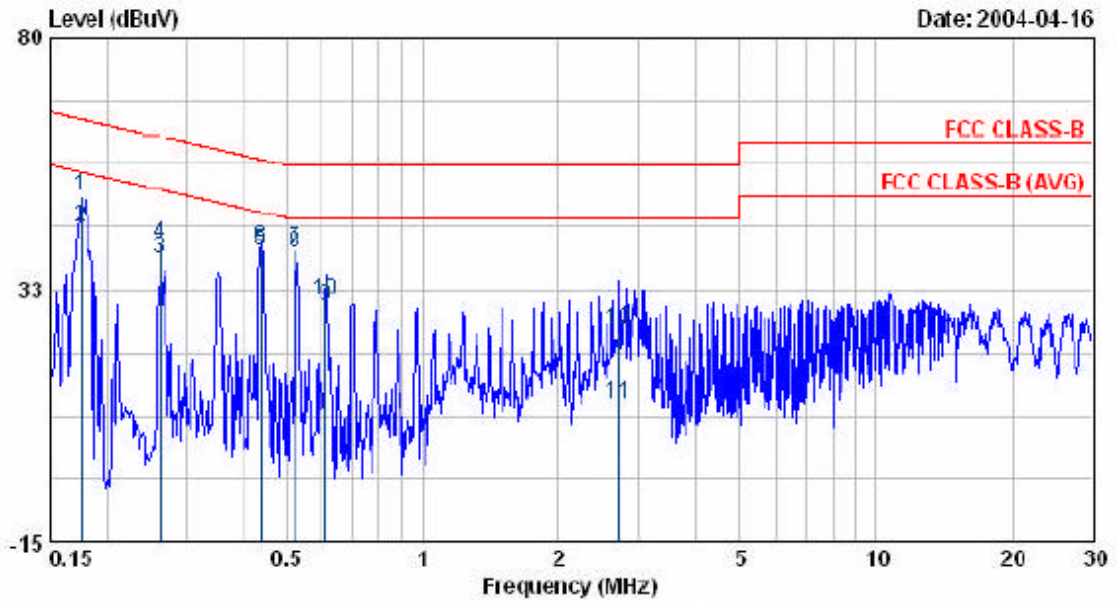

Freq	Read Level	Factor	Level	Limit	Over Limit	Remark
MHz	dBuV	dB	dBuV	dBuV	dBuV	
0.175	49.91	0.31	50.22	64.71	-14.49	QP
0.175	43.72	0.31	44.03	54.71	-10.68	AVERAGE
0.262	37.80	0.33	38.13	51.37	-13.23	AVERAGE
0.262	40.55	0.33	40.88	61.37	-20.48	QP
0.438	39.44	0.36	39.80	57.10	-17.30	QP
0.438	39.67	0.36	40.23	47.10	-6.87	AVERAGE
0.523	39.74	0.37	40.11	56.00	-15.89	QP
0.523	39.05	0.37	39.42	46.00	-6.58	AVERAGE
0.609	28.75	0.38	29.13	46.00	-16.87	AVERAGE
0.609	29.71	0.38	30.09	56.00	-25.91	QP
2.719	10.62	0.46	11.08	46.00	-34.92	AVERAGE
2.719	24.15	0.46	24.61	56.00	-31.39	QP

EUT : WMG2400 A20  
 Power : 110V 60Hz  
 Test Mode : 802.11g CH HI  
 Memo :

Pol/Phase : NEUTRAL  
 Temperature : 24 °C  
 Humidity : 59 %

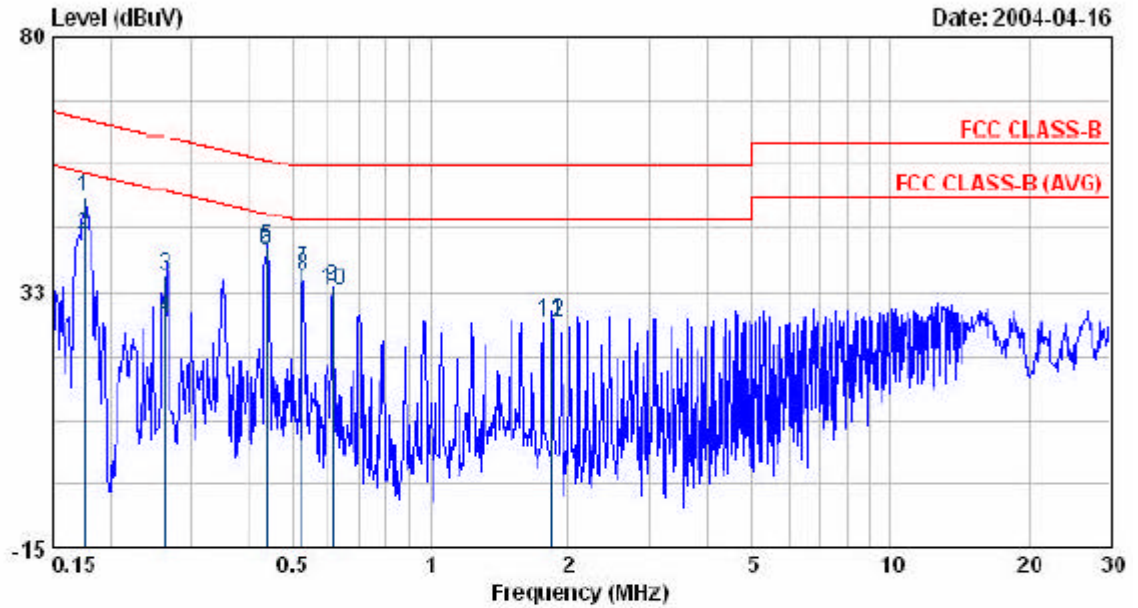

Freq	Read	Factor	Level	Limit	Over	Remark
MHz	dBuV	dB	dBuV	dBuV	dBuV	
0.175	49.78	0.31	50.09	64.71	-14.62	QP
0.175	42.81	0.31	43.12	54.71	-11.59	AVERAGE
0.263	35.28	0.33	35.61	61.32	-25.71	QP
0.263	27.13	0.33	27.46	51.32	-23.86	AVERAGE
0.438	40.28	0.36	40.64	57.10	-16.46	QP
0.438	39.56	0.36	39.92	47.10	-7.10	AVERAGE
0.527	36.30	0.38	36.68	56.00	-19.32	QP
0.527	35.13	0.38	35.51	46.00	-10.49	AVERAGE
0.614	32.83	0.38	33.21	56.00	-22.79	QP
0.614	32.26	0.38	32.64	46.00	-13.36	AVERAGE
1.840	26.25	0.44	26.69	46.00	-19.31	AVERAGE
1.840	26.48	0.44	26.92	56.00	-29.08	QP



EUT : WMG2400 A20  
 Power : 110V 60Hz  
 Test Mode : 802.11g CH HI  
 Memo :

Pol/Phase : LINE  
 Temperature : 24 °C  
 Humidity : 59 %

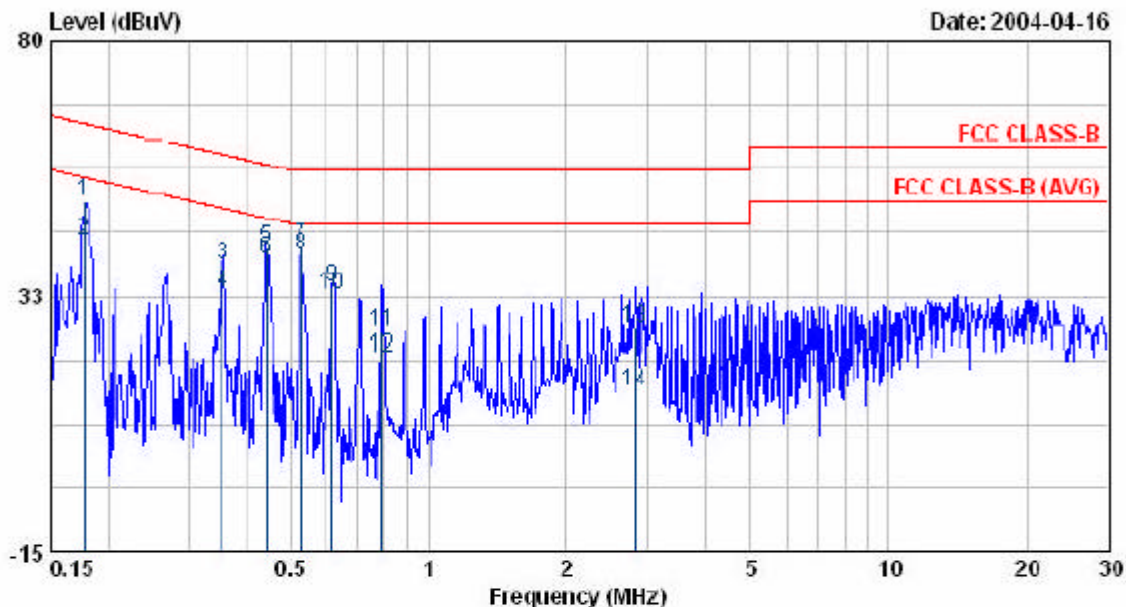

Freq	Read Level	Factor	Level	Limit	Over Limit	Remark
MHz	dBuV	dB	dBuV	dBuV	dBuV	
0.177	49.75	0.31	50.06	64.61	-14.55	QP
0.177	42.49	0.31	42.80	54.61	-11.81	AVERAGE
0.355	38.05	0.35	38.40	58.84	-20.44	QP
0.355	32.83	0.35	33.18	48.84	-15.66	AVERAGE
0.442	41.09	0.36	41.45	57.03	-15.58	QP
0.442	38.99	0.36	39.35	47.03	-7.60	AVERAGE
0.529	41.52	0.38	41.90	56.00	-14.10	QP
0.529	39.66	0.38	40.04	46.00	-5.96	AVERAGE
0.616	33.61	0.38	33.99	56.00	-22.01	QP
0.616	32.14	0.38	32.52	46.00	-13.48	AVERAGE
0.791	25.44	0.40	25.84	56.00	-30.16	QP
0.791	20.86	0.40	21.26	46.00	-24.74	AVERAGE
2.822	25.92	0.46	26.38	56.00	-29.62	QP
2.822	14.50	0.46	14.96	46.00	-31.04	AVERAGE

4.2.1. Photographs of Conducted Emission Test

FRONT VIEW



REAR VIEW

