



SPORTON International Inc.

No. 52, Hwa Ya 1st Rd., Hwa Ya Technology Park, Kwei-Shan Hsiang, Tao Yuan Hsien, Taiwan, R.O.C.
Ph: 886-3-327-3456 / FAX: 886-3-327-0973 / www.sporton.com.tw

FCC RADIO TEST REPORT

Applicant's company	Abocom Systems, Inc.
Applicant Address	No.77, Yu-Yih Rd., Chu-Nan, Miao-Lih County 35059, Taiwan R.O.C.
FCC ID	MQ4WM5208
Manufacturer's company	Abocom Systems, Inc.
Manufacturer Address	No.77, Yu-Yih Rd., Chu-Nan, Miao-Lih County 35059, Taiwan R.O.C.

Product Name	802.11b/g/n Module
Brand Name	AboCom
Model No.	WM5208
Test Rule	47 CFR FCC Part 15 Subpart C § 15.247
Test Freq. Range	2400 ~ 2483.5MHz
Received Date	Sep. 10, 2015
Final Test Date	Oct. 06, 2015
Submission Type	Original Equipment

Statement

Test result included in this report is for the IEEE 802.11n and IEEE 802.11b/g of the product.

The test result in this report refers exclusively to the presented test model / sample.

Without written approval of SPORTON International Inc., the test report shall not be reproduced except in full.

The measurements and test results shown in this test report were made in accordance with the procedures and found in compliance with the limit given in ANSI C63.10-2013, 47 CFR FCC Part 15 Subpart C, KDB558074 D01 v03r03.

The test equipment used to perform the test is calibrated and traceable to NML/ROC.



Table of Contents

1. VERIFICATION OF COMPLIANCE	1
2. SUMMARY OF THE TEST RESULT	2
3. GENERAL INFORMATION	3
3.1. Product Details.....	3
3.2. Accessories.....	4
3.3. Table for Filed Antenna.....	4
3.4. Table for Carrier Frequencies	4
3.5. Table for Test Modes	5
3.6. Table for Testing Locations.....	6
3.7. Table for Multiple List.....	6
3.8. Table for Supporting Units	6
3.9. Table for Parameters of Test Software Setting	7
3.10. EUT Operation during Test	7
3.11. Duty Cycle.....	7
3.12. Test Configurations	8
4. TEST RESULT	10
4.1. AC Power Line Conducted Emissions Measurement.....	10
4.2. Maximum Conducted Output Power Measurement.....	14
4.3. Power Spectral Density Measurement	16
4.4. 6dB Spectrum Bandwidth Measurement	21
4.5. Radiated Emissions Measurement	28
4.6. Emissions Measurement	47
4.7. Antenna Requirements	65
5. LIST OF MEASURING EQUIPMENTS	66
6. MEASUREMENT UNCERTAINTY	67
APPENDIX A. TEST PHOTOS	A1 ~ A8

History of This Test Report

REPORT NO.	VERSION	DESCRIPTION	ISSUED DATE
FR591711	Rev. 01	Initial issue of report	Oct. 26, 2015



1. VERIFICATION OF COMPLIANCE

Product Name : 802.11b/g/n Module
Brand Name : AboCom
Model No. : WM5208
Applicant : Abocom Systems, Inc.
Test Rule Part(s) : 47 CFR FCC Part 15 Subpart C § 15.247

Sporton International as requested by the applicant to evaluate the EMC performance of the product sample received on Sep. 10, 2015 would like to declare that the tested sample has been evaluated and found to be in compliance with the tested rule parts. The data recorded as well as the test configuration specified is true and accurate for showing the sample's EMC nature.

A handwritten signature in blue ink, appearing to read "Sam Chen", is written over a horizontal line.

Sam Chen

SPORTON INTERNATIONAL INC.

2. SUMMARY OF THE TEST RESULT

Applied Standard: 47 CFR FCC Part 15 Subpart C				
Part	Rule Section	Description of Test	Result	Under Limit
4.1	15.207	AC Power Line Conducted Emissions	Complies	16.07 dB
4.2	15.247(b)(3)	Maximum Conducted Output Power	Complies	4.92 dB
4.3	15.247(e)	Power Spectral Density	Complies	10.32 dB
4.4	15.247(a)(2)	6dB Spectrum Bandwidth	Complies	-
4.5	15.247(d)	Radiated Emissions	Complies	0.22 dB
4.6	15.247(d)	Band Edge Emissions	Complies	0.06 dB
4.7	15.203	Antenna Requirements	Complies	-

3. GENERAL INFORMATION

3.1. Product Details

Items	Description
Product Type	WLAN (1TX, 1RX)
Radio Type	Intentional Transceiver
Power Type	From host system
Modulation	IEEE 802.11b: DSSS IEEE 802.11g: OFDM IEEE 802.11n: see the below table
Data Modulation	IEEE 802.11b: DSSS (BPSK / QPSK / CCK) IEEE 802.11g/n: OFDM (BPSK / QPSK / 16QAM / 64QAM)
Data Rate (Mbps)	IEEE 802.11b: DSSS (1/ 2/ 5.5/11) IEEE 802.11g: OFDM (6/9/12/18/24/36/48/54) IEEE 802.11n: see the below table
Frequency Range	2400 ~ 2483.5MHz
Channel Number	11 for 20MHz bandwidth ; 7 for 40MHz bandwidth
Channel Band Width (99%)	IEEE 802.11b: 13.92 MHz IEEE 802.11g: 18.00 MHz IEEE 802.11n MCS0 (HT20): 18.24 MHz IEEE 802.11n MCS0 (HT40): 36.80 MHz
Maximum Conducted Output Power	IEEE 802.11b: 25.08 dBm IEEE 802.11g: 22.07 dBm IEEE 802.11n MCS0 (HT20): 20.76 dBm IEEE 802.11n MCS0 (HT40): 14.87 dBm
Carrier Frequencies	Please refer to section 3.4
Antenna	Please refer to section 3.3

Items	Description	
Beamforming Function	<input type="checkbox"/> With beamforming	<input checked="" type="checkbox"/> Without beamforming

Antenna and Band width

Antenna	Single (TX)	
	20 MHz	40 MHz
IEEE 802.11b	V	X
IEEE 802.11g	V	X
IEEE 802.11n	V	V

IEEE 11n Spec.

Protocol	Number of Transmit Chains (NTX)	Data Rate / MCS
802.11n (HT20)	1	MCS 0-7
802.11n (HT40)	1	MCS 0-7

Note 1: IEEE Std. 802.11n modulation consists of HT20 and HT40 (HT: High Throughput).
Then EUT supports HT20 and HT40.

Note 2: Modulation modes consist of below configuration: HT20/HT40: IEEE 802.11n

3.2. Accessories

N/A

3.3. Table for Filed Antenna

Ant.	Brand	Model Name	Antenna Type	Connector	Gain (dBi)	Remark
1	Abocom	M30-05+++ -000	PIFA Antenna	N/A	2.92	TX/RX
2	Abocom	M30-05+++ -000	PIFA Antenna	N/A	3.14	RX

Note: The EUT has two antennas (1TX, 1RX).

Only Ant. 1 can be use as transmitting antenna.

The EUT supports the Ant. 1 and Ant. 2 with RX diversity function.

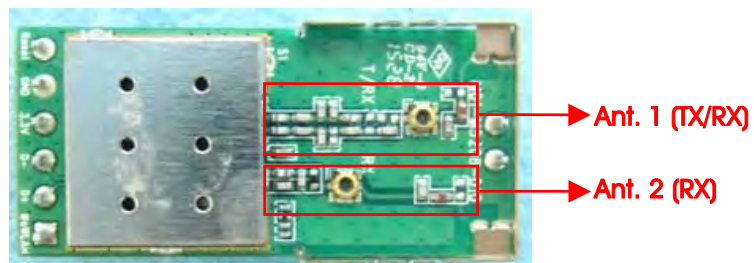

3.4. Table for Carrier Frequencies

There are two bandwidth systems.

For 20MHz bandwidth systems, use Channel 1~Channel 11.

For 40MHz bandwidth systems, use Channel 3~Channel 9.

Frequency Band	Channel No.	Frequency	Channel No.	Frequency
2400~2483.5MHz	1	2412 MHz	7	2442 MHz
	2	2417 MHz	8	2447 MHz
	3	2422 MHz	9	2452 MHz
	4	2427 MHz	10	2457 MHz
	5	2432 MHz	11	2462 MHz
	6	2437 MHz	-	-

3.5. Table for Test Modes

Preliminary tests were performed in different data rate to find the worst radiated emission. The data rate shown in the table below is the worst-case rate with respect to the specific test item. Investigation has been done on all the possible configurations for searching the worst cases. The following table is a list of the test modes shown in this test report.

Test Items	Mode	Data Rate	Channel	Ant.
AC Power Line Conducted Emissions	CTX	-	-	-
Maximum Conducted Output Power	11b/CCK	1 Mbps	1/6/11	1
	11g/BPSK	6 Mbps	1/6/11	1
	11n HT20	MCS0	1/6/11	1
	11n HT40	MCS0	3/6/9	1
Power Spectral Density	11b/CCK	1 Mbps	1/6/11	1
	11g/BPSK	6 Mbps	1/6/11	1
	11n HT20	MCS0	1/6/11	1
	11n HT40	MCS0	3/6/9	1
6dB Spectrum Bandwidth	11b/CCK	1 Mbps	1/6/11	1
	11g/BPSK	6 Mbps	1/6/11	1
	11n HT20	MCS0	1/6/11	1
	11n HT40	MCS0	3/6/9	1
Radiated Emissions 9kHz~1GHz	CTX	-	-	-
Radiated Emissions 1GHz~10 th Harmonic	11b/CCK	1 Mbps	1/6/11	1
	11g/BPSK	6 Mbps	1/6/11	1
	11n HT20	MCS0	1/6/11	1
	11n HT40	MCS0	3/6/9	1
Band Edge Emissions	11b/CCK	1 Mbps	1/6/11	1
	11g/BPSK	6 Mbps	1/6/11	1
	11n HT20	MCS0	1/6/11	1
	11n HT40	MCS0	3/6/9	1

The following test modes were performed for all tests:

For Radiated Emission above 1GHz test:

The EUT was performed at X axis, Y axis and Z axis position for radiated emission test, and the worst case was found at X axis. So the measurement will follow this same test configuration.

Mode 1. Place EUT in X axis.

For Radiated Emission below 1GHz test:

Place EUT in X axis generated the worst test result for radiated emission above 1GHz test, thus the measurement for radiated emission below test will follow this same test configuration.

Mode 1. Place EUT in X axis.

3.6. Table for Testing Locations

Test Site Location				
Address:	No.8, Lane 724, Bo-ai St., Jhubei City, Hsinchu County 302, Taiwan, R.O.C.			
TEL:	886-3-656-9065			
FAX:	886-3-656-9085			
Test Site No.	Site Category	Location	FCC Reg. No.	IC File No.
03CH01-CB	SAC	Hsin Chu	262045	IC 4086D
CO01-CB	Conduction	Hsin Chu	262045	IC 4086D
TH01-CB	OVEN Room	Hsin Chu	-	-

Open Area Test Site (OATS); Semi Anechoic Chamber (SAC).

3.7. Table for Multiple List

The EUT has three types which are identical to each other in all aspects except for the following table:

Type	Description	Remark
1	There are three types of EUT, all EUT are identical except for the pins.	EUT 1
2		EUT 2
3		EUT 3

From the above models, EUT 1 was selected as representative model for the test and its data was recorded in this report.

3.8. Table for Supporting Units

For Test Site No: 03CH01-CB and TH01-CB

Support Unit	Brand	Model	FCC ID
Notebook	DELL	E4300	DoC
Test Fixture	AboCom	M01-M5208T-X10	N/A

For Test Site No: CO01-CB

Support Unit	Brand	Model	FCC ID
Notebook	DELL	E6430	DoC
Test Fixture	AboCom	M01-M5208T-X10	N/A

3.9. Table for Parameters of Test Software Setting

During testing, Channel and Power Controlling Software provided by the customer was used to control the operating channel as well as the output power level. The RF output power selection is for the setting of RF output power expected by the customer and is going to be fixed on the firmware of the final end product.

Test Software Version	MT7601 USB V1.0.9.11					
Mode	Test Frequency (MHz)					
	NCB: 20MHz			NCB: 40MHz		
	2412 MHz	2437 MHz	2462 MHz	2422 MHz	2437 MHz	2452 MHz
802.11b	23	33	20	-	-	-
802.11g	1C	2B	1B	-	-	-
802.11n MCS0 HT20	1D	2B	1D	-	-	-
802.11n MCS0 HT40	-	-	-	18	1D	1C

3.10. EUT Operation during Test

The EUT was programmed to be in continuously transmitting mode.

3.11. Duty Cycle

Mode	On Time (ms)	On+Off Time (ms)	Duty Cycle (%)	Duty Factor (dB)	1/T Minimum VBW (kHz)
802.11b	8.689	8.917	97.44	0.11	0.12
802.11g	1.434	1.693	84.70	0.72	0.70
802.11n MCS0 HT20	1.341	1.542	86.96	1.15	0.75
802.11n MCS0 HT40	0.662	0.868	76.19	1.18	1.51

3.12. Test Configurations

3.12.1. AC Power Line Conduction Emissions Test Configuration

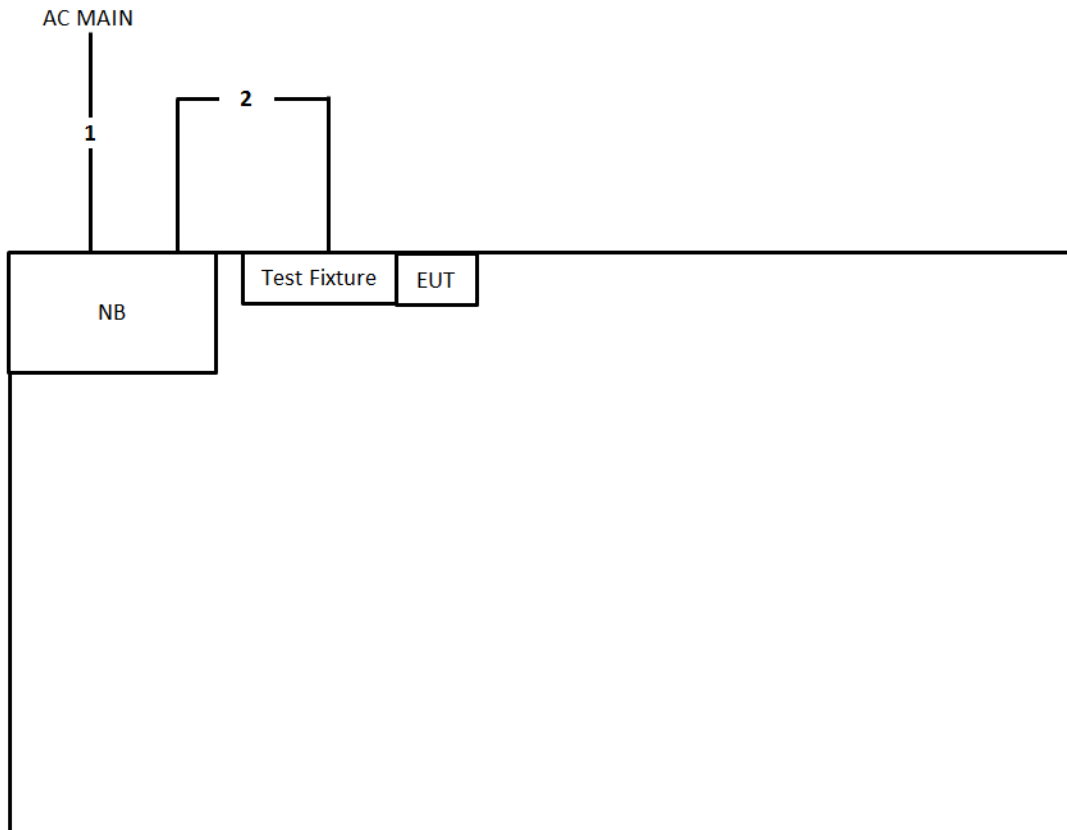

Item	Connection	Shielded	Length
1	Power cable	No	2.6m
2	USB cable	Yes	1.5m

3.12.2. Radiation Emissions Test Configuration

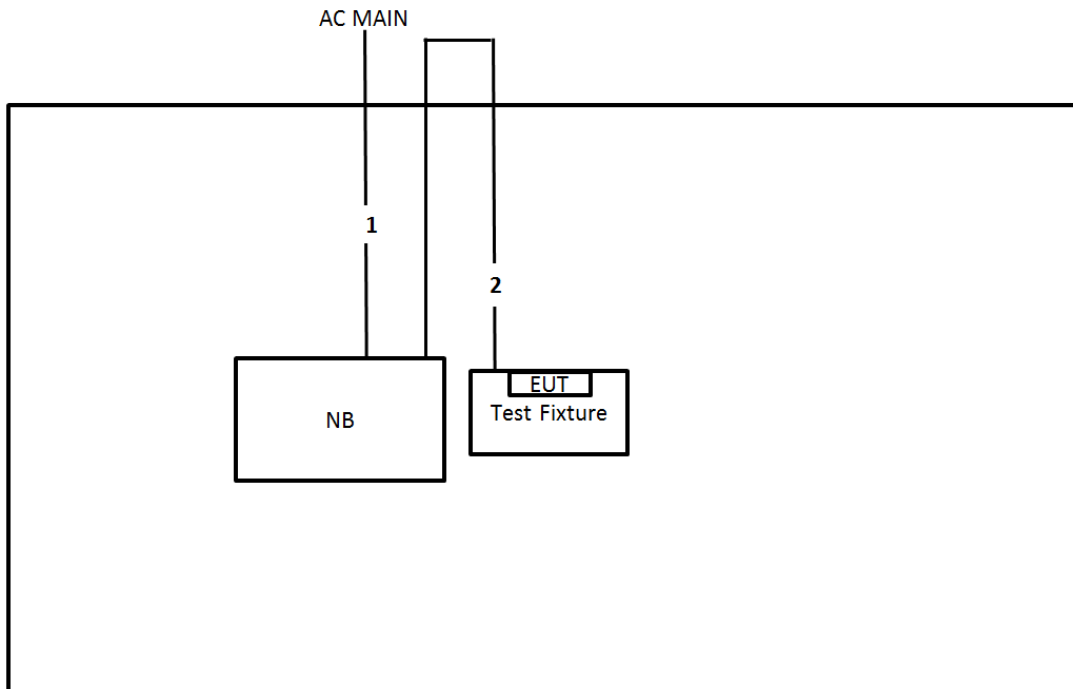

Item	Connection	Shielded	Length
1	Power cable	No	2.6m
2	USB cable	Yes	1.5m

4. TEST RESULT

4.1. AC Power Line Conducted Emissions Measurement

4.1.1. Limit

For this product which is designed to be connected to the AC power line, the radio frequency voltage that is conducted back onto the AC power line on any frequency or frequencies within the band 150 kHz to 30 MHz shall not exceed below limits table.

Frequency (MHz)	QP Limit (dBuV)	AV Limit (dBuV)
0.15~0.5	66~56	56~46
0.5~5	56	46
5~30	60	50

4.1.2. Measuring Instruments and Setting

Please refer to section 5 of equipments list in this report. The following table is the setting of the receiver.

Receiver Parameters	Setting
Attenuation	10 dB
Start Frequency	0.15 MHz
Stop Frequency	30 MHz
IF Bandwidth	9 kHz

4.1.3. Test Procedures

1. Configure the EUT according to ANSI C63.10. The EUT or host of EUT has to be placed 0.4 meter far from the conducting wall of the shielding room and at least 80 centimeters from any other grounded conducting surface.
2. Connect EUT or host of EUT to the power mains through a line impedance stabilization network (LISN).
3. All the support units are connected to the other LISNs. The LISN should provide 50uH/50ohms coupling impedance.
4. The frequency range from 150 kHz to 30 MHz was searched.
5. Set the test-receiver system to Peak Detect Function and Specified Bandwidth with Maximum Hold Mode.
6. The measurement has to be done between each power line and ground at the power terminal.

4.1.4. Test Setup Layout

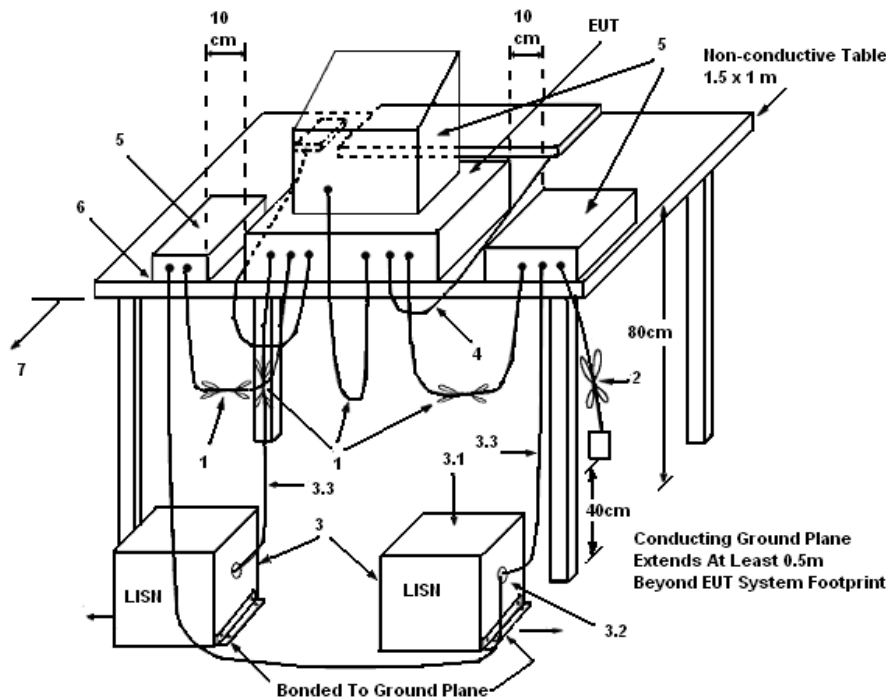

LEGEND:

- (1) Interconnecting cables that hang closer than 40 cm to the ground plane shall be folded back and forth in the center forming a bundle 30 to 40 cm long.
- (2) I/O cables that are not connected to a peripheral shall be bundled in the center. The end of the cable may be terminated, if required, using the correct terminating impedance. The overall length shall not exceed 1 m.
- (3) EUT connected to one LISN. Unused LISN measuring port connectors shall be terminated in 50 Ω . LISN can be placed on top of, or immediately beneath, reference ground plane.
 - (3.1) All other equipment powered from additional LISN(s).
 - (3.2) Multiple outlet strip can be used for multiple power cords of non-EUT equipment.
 - (3.3) LISN at least 80 cm from nearest part of EUT chassis.
- (4) Cables of hand-operated devices, such as keyboards, mice, etc., shall be placed as for normal use.
- (5) Non-EUT components of EUT system being tested.
- (6) Rear of EUT, including peripherals, shall all be aligned and flush with rear of tabletop.
- (7) Rear of tabletop shall be 40 cm removed from a vertical conducting plane that is bonded to the ground plane.

4.1.5. Test Deviation

There is no deviation with the original standard.

4.1.6. EUT Operation during Test

The EUT was placed on the test table and programmed in normal function.

4.1.7. Results of AC Power Line Conducted Emissions Measurement

Temperature	24°C	Humidity	56%
Test Engineer	Kane Liu	Phase	Line
Configuration	CTX		

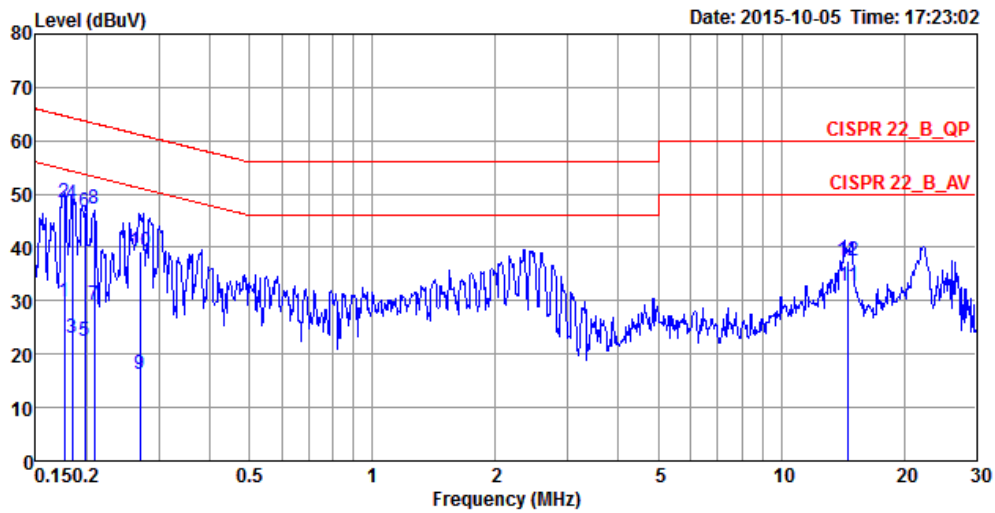

	Freq	Level	Over Limit	Limit Line	Read Level	LISN Factor	Cable Loss	Pol/Phase	Remark
	MHz	dBuV	dB	dBuV	dBuV	dB	dB		
1	0.1758	29.90	-24.78	54.68	19.95	9.93	0.02	LINE	Average
2	0.1758	48.51	-16.17	64.68	38.56	9.93	0.02	LINE	QP
3	0.1844	22.99	-31.29	54.28	13.04	9.93	0.02	LINE	Average
4	0.1844	48.08	-16.20	64.28	38.13	9.93	0.02	LINE	QP
5	0.1976	22.57	-31.14	53.71	12.62	9.93	0.02	LINE	Average
6	0.1976	46.68	-17.03	63.71	36.73	9.93	0.02	LINE	QP
7	0.2083	29.33	-23.94	53.27	19.38	9.93	0.02	LINE	Average
8	0.2083	47.16	-16.11	63.27	37.21	9.93	0.02	LINE	QP
9	0.2701	16.29	-34.83	51.12	6.33	9.93	0.03	LINE	Average
10	0.2701	39.23	-21.89	61.12	29.27	9.93	0.03	LINE	QP
11	14.5942	32.69	-17.31	50.00	22.11	10.32	0.26	LINE	Average
12	14.5942	37.60	-22.40	60.00	27.02	10.32	0.26	LINE	QP

Temperature	24°C	Humidity	56%
Test Engineer	Kane Liu	Phase	Neutral
Configuration	CTX		

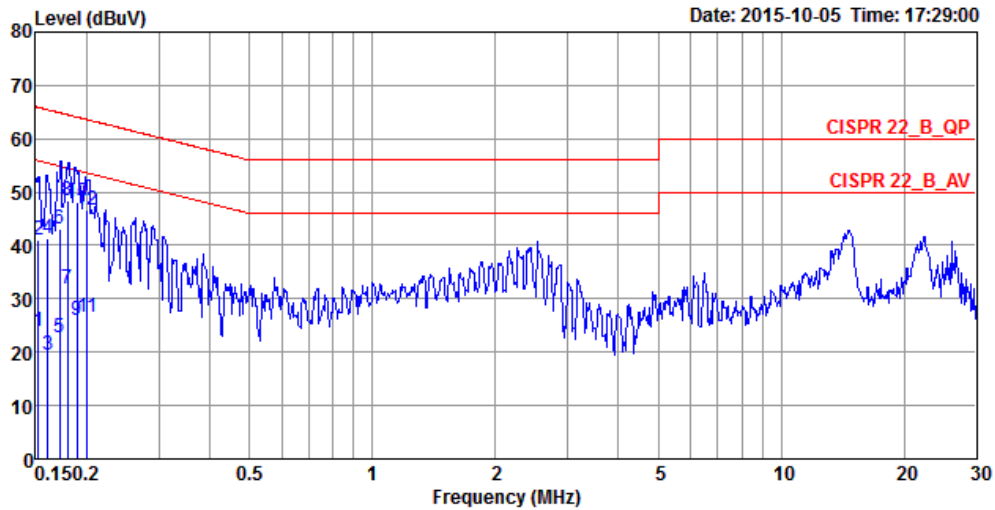

	Freq	Level	Over Limit	Limit Line	Read Level	LISN Factor	Cable Loss	Pol/Phase	Remark
	MHz	dBuV	dB	dBuV	dBuV	dB	dB		
1	0.1524	23.79	-32.08	55.87	13.99	9.78	0.02	NEUTRAL	Average
2	0.1524	40.92	-24.95	65.87	31.12	9.78	0.02	NEUTRAL	QP
3	0.1607	19.41	-36.02	55.43	9.61	9.78	0.02	NEUTRAL	Average
4	0.1607	41.25	-24.18	65.43	31.45	9.78	0.02	NEUTRAL	QP
5	0.1712	22.58	-32.32	54.90	12.78	9.78	0.02	NEUTRAL	Average
6	0.1712	43.03	-21.87	64.90	33.23	9.78	0.02	NEUTRAL	QP
7	0.1796	31.79	-22.71	54.50	21.98	9.79	0.02	NEUTRAL	Average
8	0.1796	48.39	-16.11	64.50	38.58	9.79	0.02	NEUTRAL	QP
9	0.1894	25.85	-28.21	54.06	16.04	9.79	0.02	NEUTRAL	Average
10	0.1894	47.99	-16.07	64.06	38.18	9.79	0.02	NEUTRAL	QP
11	0.2007	26.45	-27.13	53.58	16.64	9.79	0.02	NEUTRAL	Average
12	0.2007	46.52	-17.06	63.58	36.71	9.79	0.02	NEUTRAL	QP

Note:

Level = Read Level + LISN Factor + Cable Loss.

4.2. Maximum Conducted Output Power Measurement

4.2.1. Limit

The limit for output power is 30dBm.

4.2.2. Measuring Instruments and Setting

Please refer to section 5 of equipments list in this report. The following table is the setting of the power meter.

Power Meter Parameter	Setting
Bandwidth	50MHz bandwidth is greater than the EUT emission bandwidth
Detector	Average

4.2.3. Test Procedures

1. Test procedures refer KDB558074 D01 v03r03 section 9.2.3.2 Measurement using a power meter (PM).
2. This procedure provides an alternative for determining the RMS output power using a broadband RF average power meter with a thermocouple detector.

4.2.4. Test Setup Layout

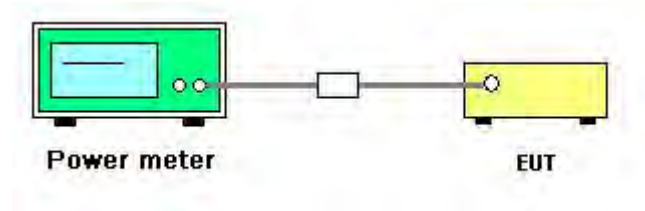

4.2.5. Test Deviation

There is no deviation with the original standard.

4.2.6. EUT Operation during Test

The EUT was programmed to be in continuously transmitting mode.

4.2.7. Test Result of Maximum Conducted Output Power

Temperature	24°C	Humidity	45%
Test Engineer	Eddie Weng	Test Date	Sep. 14, 2015

Mode	Frequency	Conducted Power (dBm)	Max. Limit (dBm)	Result
		Ant. 1		
802.11b	2412 MHz	19.67	30.00	Complies
	2437 MHz	25.08	30.00	Complies
	2462 MHz	18.41	30.00	Complies
802.11g	2412 MHz	16.35	30.00	Complies
	2437 MHz	22.07	30.00	Complies
	2462 MHz	15.92	30.00	Complies
802.11n MCS0 HT20	2412 MHz	15.26	30.00	Complies
	2437 MHz	20.76	30.00	Complies
	2462 MHz	15.25	30.00	Complies
802.11n MCS0 HT40	2422 MHz	12.38	30.00	Complies
	2437 MHz	14.87	30.00	Complies
	2452 MHz	14.44	30.00	Complies

4.3. Power Spectral Density Measurement

4.3.1. Limit

For digitally modulated systems, the power spectral density conducted from the intentional radiator to the antenna shall not be greater than 8 dBm in any 3 kHz band during any time interval of continuous transmission.

4.3.2. Measuring Instruments and Setting

Please refer to section 5 of equipments list in this report. The following table is the setting of the spectrum analyzer.

Spectrum Parameter	Setting
Attenuation	Auto
Span Frequency	Set the span to 1.5 times the DTS channel bandwidth.
RBW	$3 \text{ kHz} \leq \text{RBW} \leq 100\text{kHz}$
VBW	$\geq 3 \times \text{RBW}$
Detector	Peak
Trace	Max Hold
Sweep Time	Auto couple

4.3.3. Test Procedures

1. Test was performed in accordance with KDB558074 D01 v03r03 for Performing Compliance Measurements on Digital Transmission Systems (DTS) - section 10.2 Method PKPSD (peak PSD).
2. Use this procedure when the maximum conducted output power in the fundamental emission is used to demonstrate compliance. The EUT must be configured to transmit continuously at full power over the measurement duration.
3. Ensure that the number of measurement points in the sweep $\geq 2 \times \text{span}/\text{RBW}$ (use of a greater number of measurement points than this minimum requirement is recommended).
4. Use the peak marker function to determine the maximum level in any 3 kHz band segment within the fundamental EBW.
5. The resulting PSD level must be $\leq 8 \text{ dBm}$.

4.3.4. Test Setup Layout

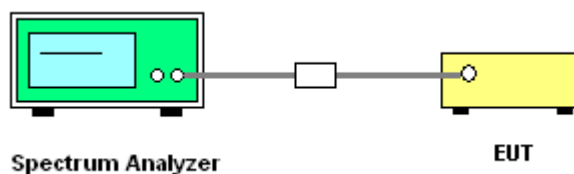

4.3.5. Test Deviation

There is no deviation with the original standard.

4.3.6. EUT Operation during Test

The EUT was programmed to be in continuously transmitting mode.

4.3.7. Test Result of Power Spectral Density

Temperature	24°C	Humidity	45%
Test Engineer	Eddie Weng		

Mode	Frequency	Power Density (dBm/3kHz)	Power Density Limit (dBm/3kHz)	Result
		Ant. 1		
802.11b	2412 MHz	-8.47	8.00	Complies
	2437 MHz	-2.32	8.00	Complies
	2462 MHz	-8.25	8.00	Complies
802.11g	2412 MHz	-12.46	8.00	Complies
	2437 MHz	-6.45	8.00	Complies
	2462 MHz	-13.42	8.00	Complies
802.11n MCS0 HT20	2412 MHz	-12.50	8.00	Complies
	2437 MHz	-7.81	8.00	Complies
	2462 MHz	-12.34	8.00	Complies
802.11n MCS0 HT40	2422 MHz	-18.48	8.00	Complies
	2437 MHz	-14.41	8.00	Complies
	2452 MHz	-14.16	8.00	Complies

Note: All the test values were listed in the report.

For plots, only the channel with worse result was shown.

Power Density Plot on Configuration IEEE 802.11b / 2437 MHz / Ant. 1

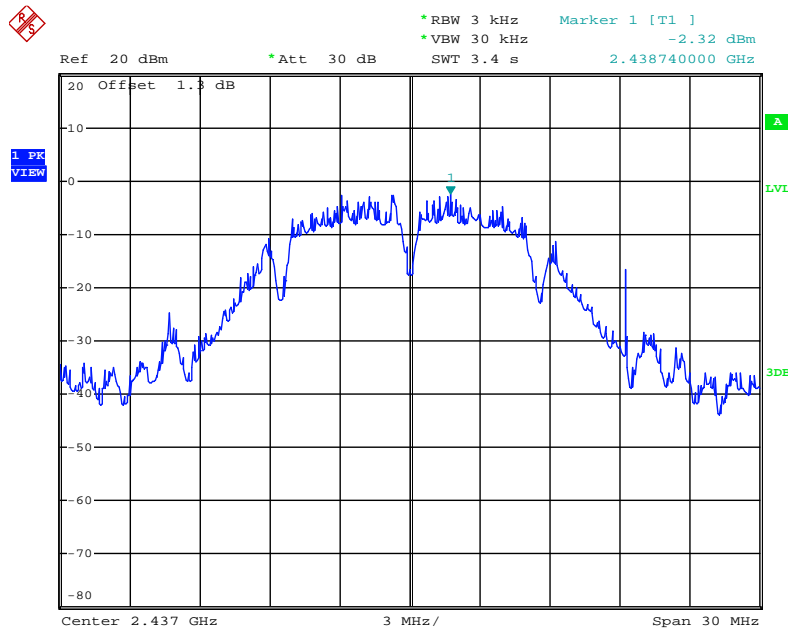

Date: 14.SEP.2015 10:50:28

Power Density Plot on Configuration IEEE 802.11g / 2437 MHz / Ant. 1

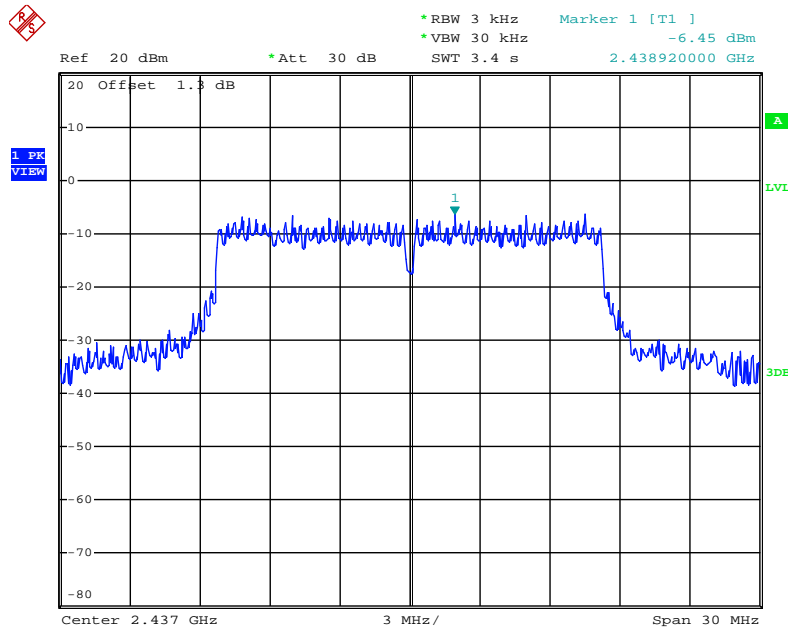

Date: 14.SEP.2015 10:51:58

Power Density Plot on Configuration IEEE 802.11n MCS0 HT20 / 2437 MHz / Ant. 1

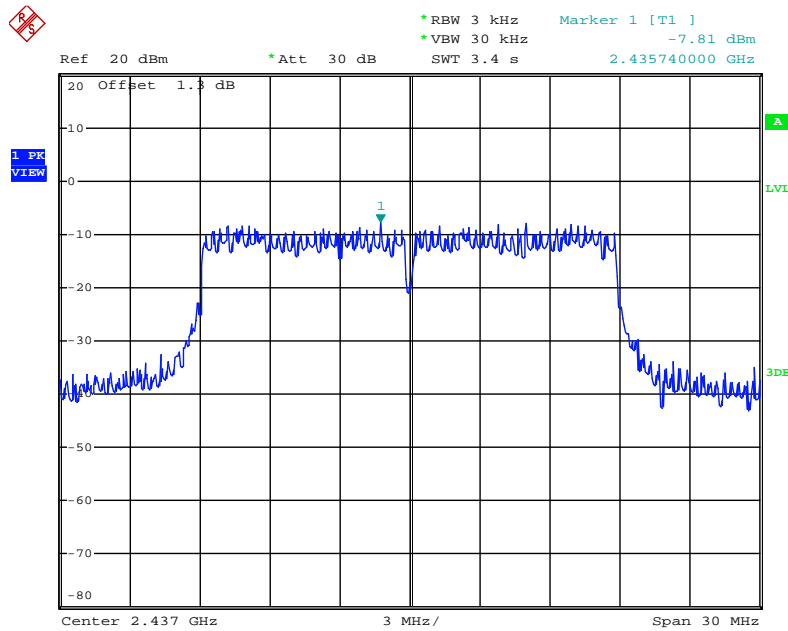

Date: 14.SEP.2015 10:53:19

Power Density Plot on Configuration IEEE 802.11n MCS0 HT40 / 2452 MHz / Ant. 1

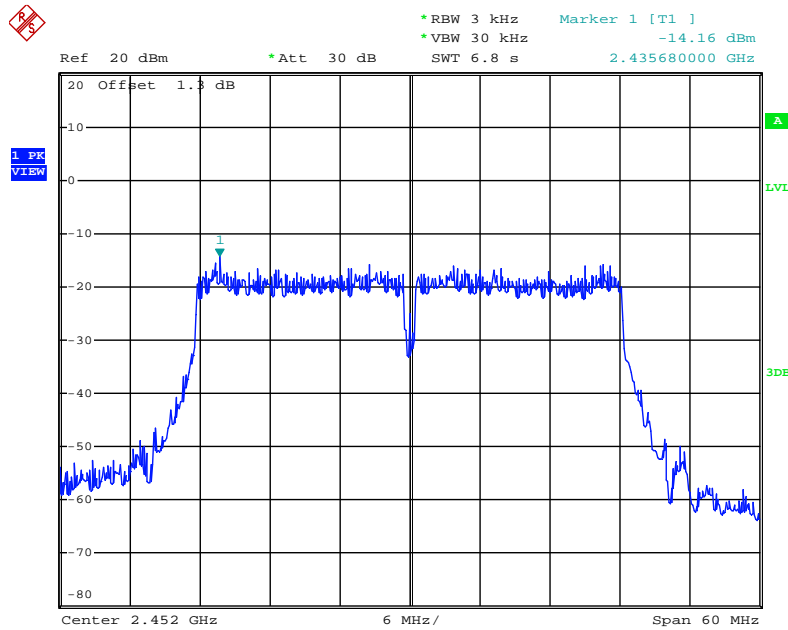

Date: 14.SEP.2015 10:55:27

4.4. 6dB Spectrum Bandwidth Measurement

4.4.1. Limit

For digital modulation systems, the minimum 6 dB bandwidth shall be at least 500 kHz.

4.4.2. Measuring Instruments and Setting

Please refer to section 5 of equipments list in this report. The following table is the setting of the Spectrum Analyzer.

6dB Spectrum Bandwidth	
Spectrum Parameters	Setting
Attenuation	Auto
Span Frequency	> 6dB Bandwidth
RBW	100kHz
VBW	$\geq 3 \times \text{RBW}$
Detector	Peak
Trace	Max Hold
Sweep Time	Auto
99% Occupied Bandwidth	
Spectrum Parameters	Setting
Span	1.5 times to 5.0 times the OBW
RBW	1 % to 5 % of the OBW
VBW	$\geq 3 \times \text{RBW}$
Detector	Peak
Trace	Max Hold

4.4.3. Test Procedures

For Radiated 6dB Bandwidth Measurement:

1. The transmitter was radiated to the spectrum analyzer in peak hold mode.
2. Test was performed in accordance with KDB558074 D01 v03r03 for Performing Compliance Measurements on Digital Transmission Systems (DTS) - section 8.0 DTS bandwidth => 8.1 Option 1.
3. Measured the spectrum width with power higher than 6dB below carrier.

4.4.4. Test Setup Layout

For Radiated 6dB Bandwidth Measurement:

This test setup layout is the same as that shown in section 4.5.4.

4.4.5. Test Deviation

There is no deviation with the original standard.

4.4.6. EUT Operation during Test

The EUT was programmed to be in continuously transmitting mode.

4.4.7. Test Result of 6dB Spectrum Bandwidth

Temperature	24°C	Humidity	45%
Test Engineer	Eddie Weng		

Mode	Frequency	6dB Bandwidth (MHz)	99% Occupied Bandwidth (MHz)	Min. Limit (kHz)	Test Result
802.11b	2412 MHz	10.08	12.24	500	Complies
	2437 MHz	10.08	13.92	500	Complies
	2462 MHz	10.08	12.24	500	Complies
802.11g	2412 MHz	16.48	17.04	500	Complies
	2437 MHz	16.32	18.00	500	Complies
	2462 MHz	16.32	17.04	500	Complies
802.11n MCS0 HT20	2412 MHz	17.60	17.88	500	Complies
	2437 MHz	17.60	18.24	500	Complies
	2462 MHz	17.60	17.76	500	Complies
802.11n MCS0 HT40	2422 MHz	36.00	36.80	500	Complies
	2437 MHz	36.48	36.80	500	Complies
	2452 MHz	36.00	36.80	500	Complies

Note: All the test values were listed in the report.

For plots, only the channel with worse result was shown.

6 dB Bandwidth Plot on Configuration IEEE 802.11b / 2412 MHz / Ant. 1

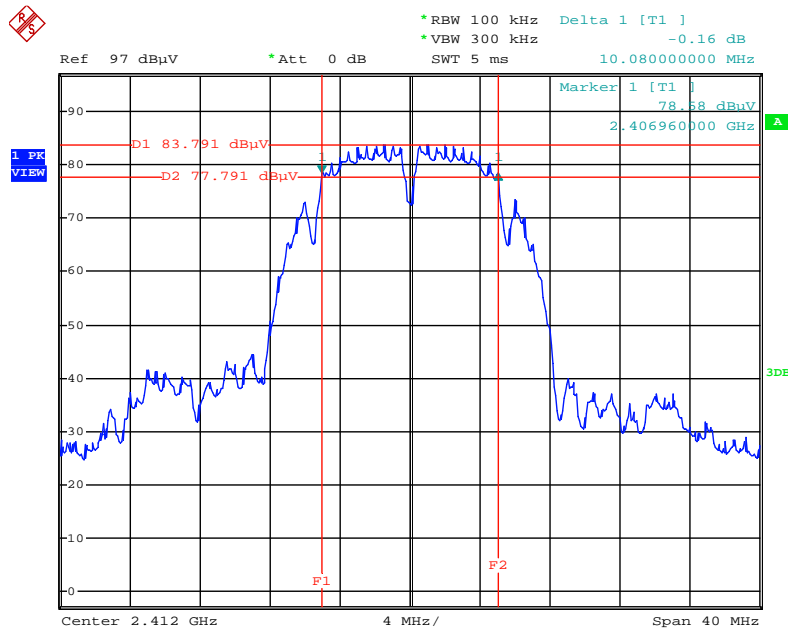

Date: 14.SEP.2015 10:36:00

99% Occupied Bandwidth Plot on Configuration IEEE 802.11b / 2437 MHz / Ant. 1

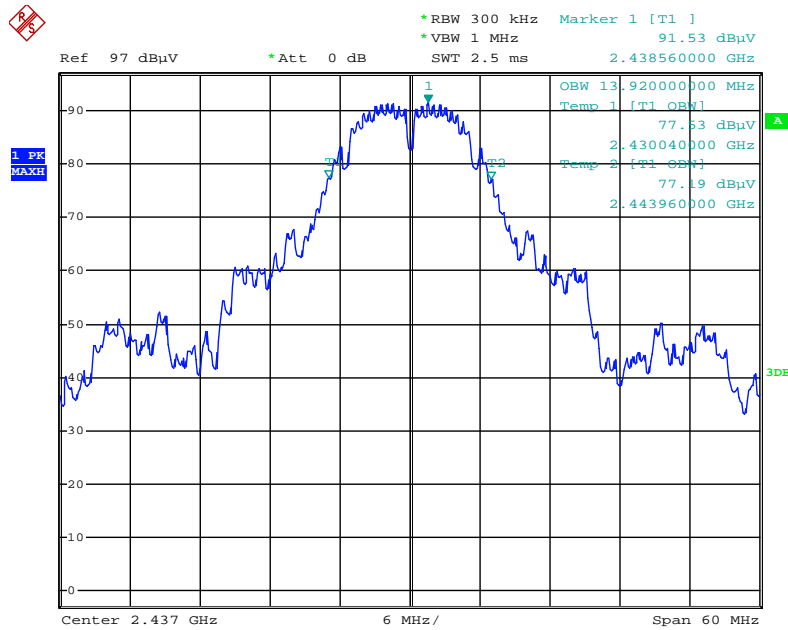

Date: 14.SEP.2015 10:44:22

6 dB Bandwidth Plot on Configuration IEEE 802.11g / 2437 MHz / Ant. 1

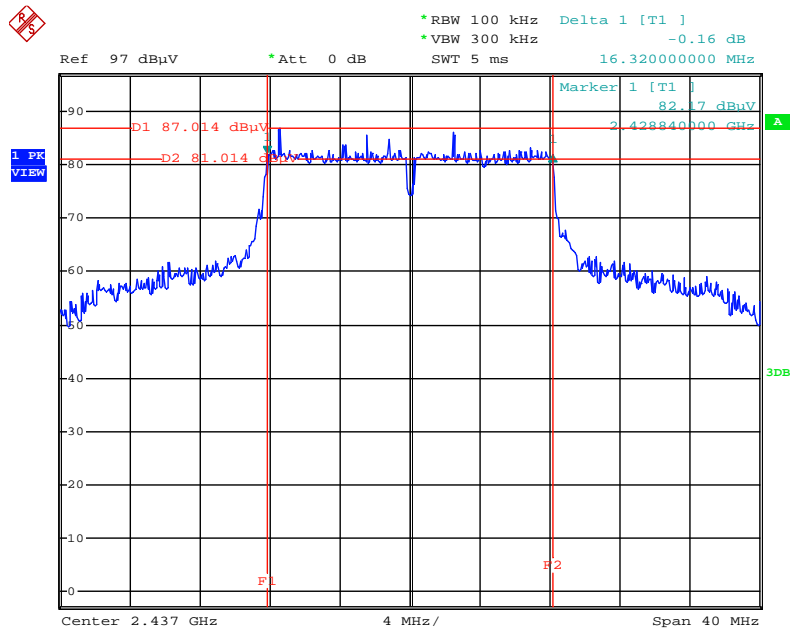

Date: 14.SEP.2015 10:39:25

99% Occupied Bandwidth Plot on Configuration IEEE 802.11g / 2437 MHz / Ant. 1

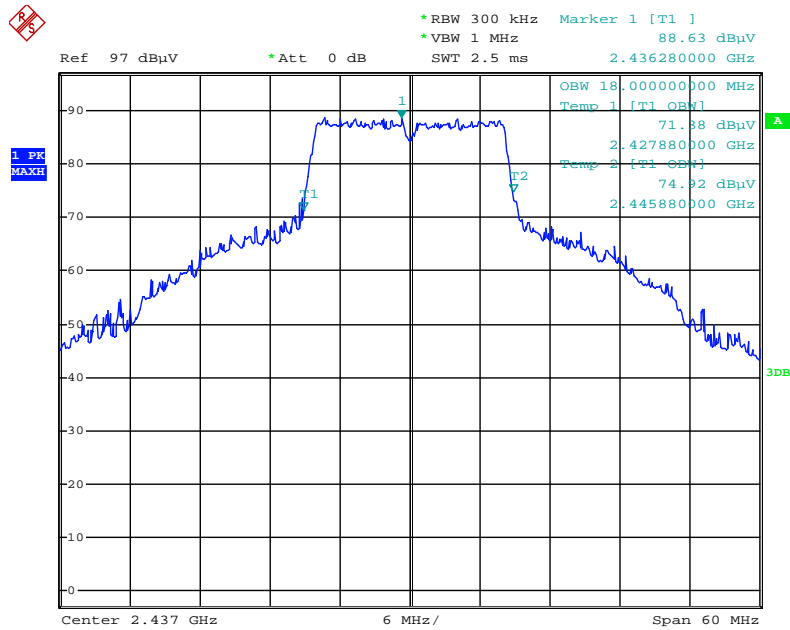

Date: 14.SEP.2015 10:45:29

6 dB Bandwidth Plot on Configuration IEEE 802.11n MCS0 HT20 / 2412 MHz / Ant. 1

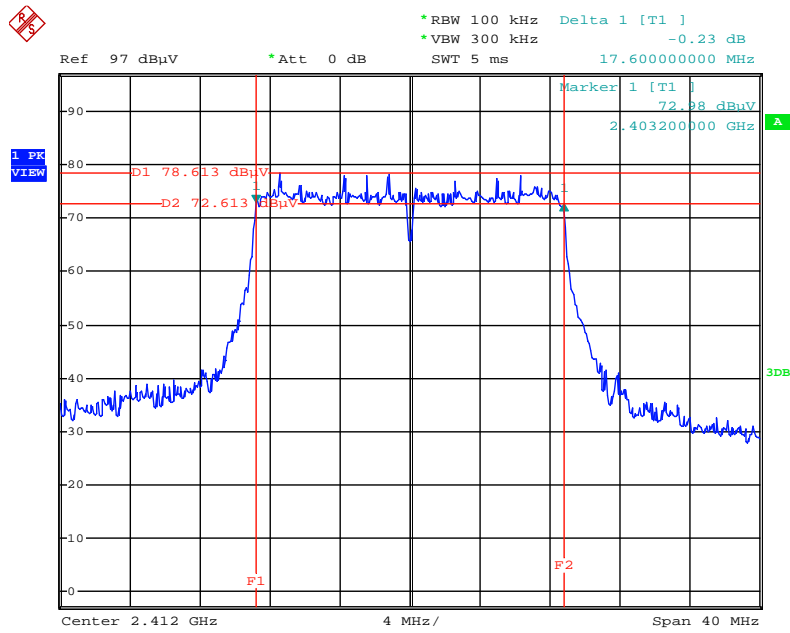

Date: 14.SEP.2015 10:40:25

99% Occupied Bandwidth Plot on Configuration IEEE 802.11n MCS0 HT20 / 2437 MHz / Ant. 1

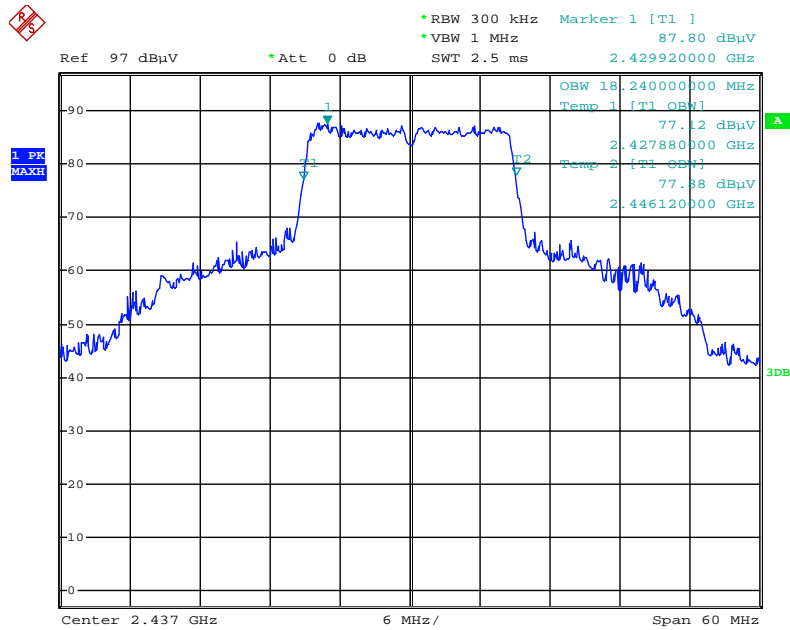

Date: 14.SEP.2015 10:46:49

6 dB Bandwidth Plot on Configuration IEEE 802.11n MCS0 HT40 / 2422 MHz / Ant. 1

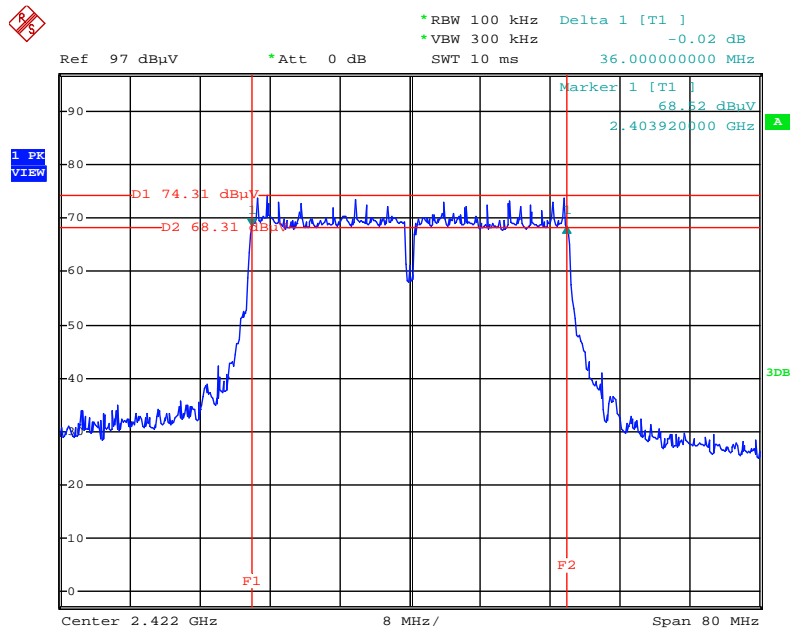

Date: 14.SEP.2015 10:41:54

99% Occupied Bandwidth Plot on Configuration IEEE 802.11n MCS0 HT40 / 2422 MHz / Ant. 1

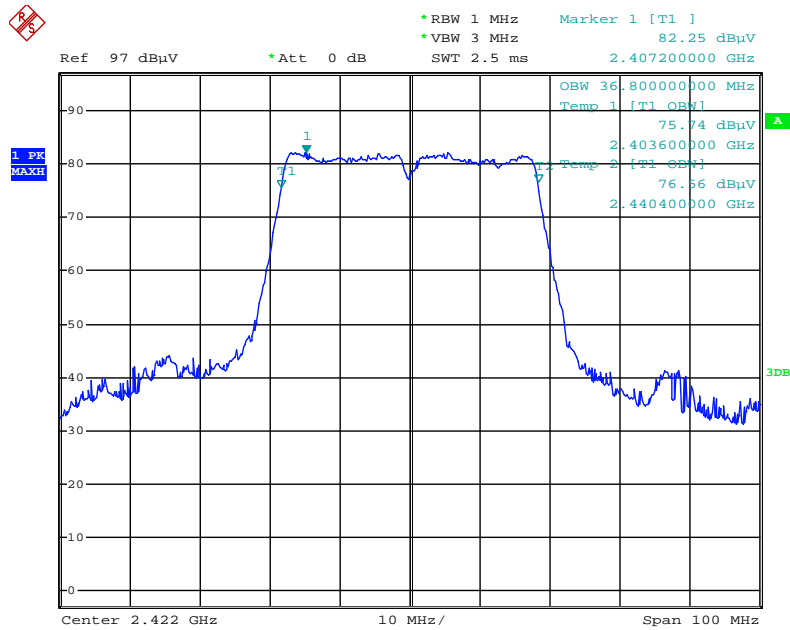

Date: 14.SEP.2015 10:47:31

4.5. Radiated Emissions Measurement

4.5.1. Limit

30dBc in any 100 kHz bandwidth outside the operating frequency band. In case the emission fall within the restricted band specified on 15.205(a), then the 15.209(a) limit in the table below has to be followed.

Frequencies (MHz)	Field Strength (micorvolts/meter)	Measurement Distance (meters)
0.009~0.490	2400/F(kHz)	300
0.490~1.705	24000/F(kHz)	30
1.705~30.0	30	30
30~88	100	3
88~216	150	3
216~960	200	3
Above 960	500	3

4.5.2. Measuring Instruments and Setting

Please refer to section 5 of equipments list in this report. The following table is the setting of spectrum analyzer and receiver.

Spectrum Parameter	Setting
Attenuation	Auto
Start Frequency	1000 MHz
Stop Frequency	10th carrier harmonic
RBW / VBW (Emission in restricted band)	1MHz / 3MHz for Peak, 1MHz / 1/T for Average
RBW / VBW (Emission in non-restricted band)	100kHz / 300kHz for peak

Receiver Parameter	Setting
Attenuation	Auto
Start ~ Stop Frequency	9kHz~150kHz / RBW 200Hz for QP
Start ~ Stop Frequency	150kHz~30MHz / RBW 9kHz for QP
Start ~ Stop Frequency	30MHz~1000MHz / RBW 120kHz for QP

4.5.3. Test Procedures

1. Configure the EUT according to ANSI C63.10. The EUT was placed on the top of the turntable 1.5 meter above ground. The phase center of the receiving antenna mounted on the top of a height-variable antenna tower was placed 1m & 3m far away from the turntable.
2. Power on the EUT and all the supporting units. The turntable was rotated by 360 degrees to determine the position of the highest radiation.
3. The height of the broadband receiving antenna was varied between one meter and four meters above ground to find the maximum emissions field strength of both horizontal and vertical polarization.
4. For each suspected emissions, the antenna tower was scan (from 1 m to 4 m) and then the turntable was rotated (from 0 degree to 360 degrees) to find the maximum reading.
5. Set the test-receiver system to Peak or CISPR quasi-peak Detect Function with specified bandwidth under Maximum Hold Mode.
6. For emissions above 1GHz, use 1MHz VBW and 3MHz RBW for peak reading. Then 1MHz RBW and 1/T VBW for average reading in spectrum analyzer.
7. If the emissions level of the EUT in peak mode was 3 dB lower than the average limit specified, then testing will be stopped and peak values of EUT will be reported, otherwise, the emissions which do not have 3 dB margin will be repeated one by one using the quasi-peak method for below 1GHz.
8. For testing above 1GHz, the emissions level of the EUT in peak mode was lower than average limit (that means the emissions level in peak mode also complies with the limit in average mode), then testing will be stopped and peak values of EUT will be reported, otherwise, the emissions will be measured in average mode again and reported.
9. In case the emission is lower than 30MHz, loop antenna has to be used for measurement and the recorded data should be QP measured by receiver. High – Low scan is not required in this case.

4.5.4. Test Setup Layout

For Radiated Emissions: 9kHz ~30MHz

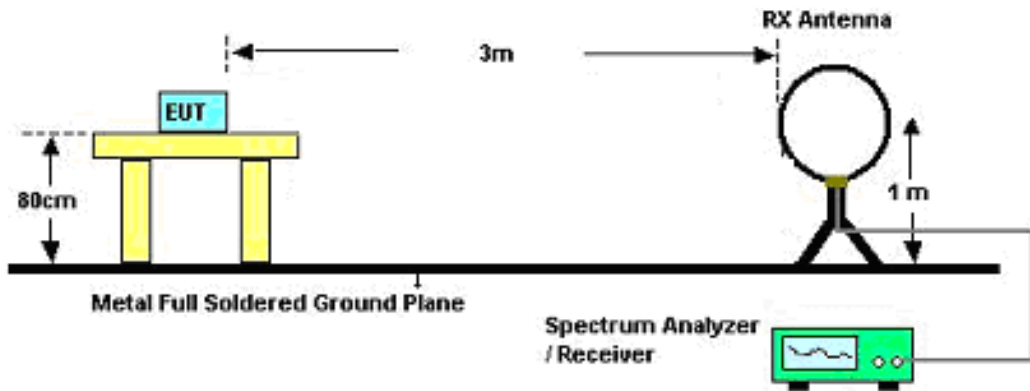

For Radiated Emissions: 30MHz~1GHz

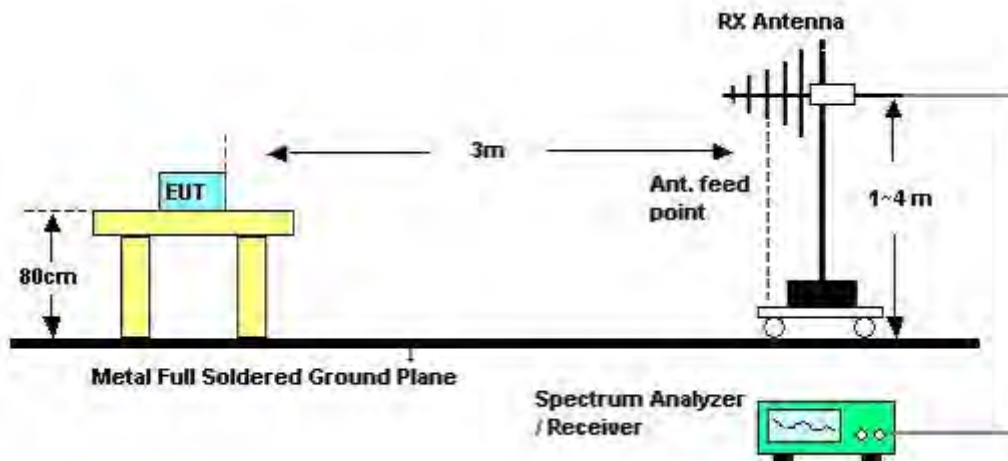

For Radiated Emissions: Above 1GHz

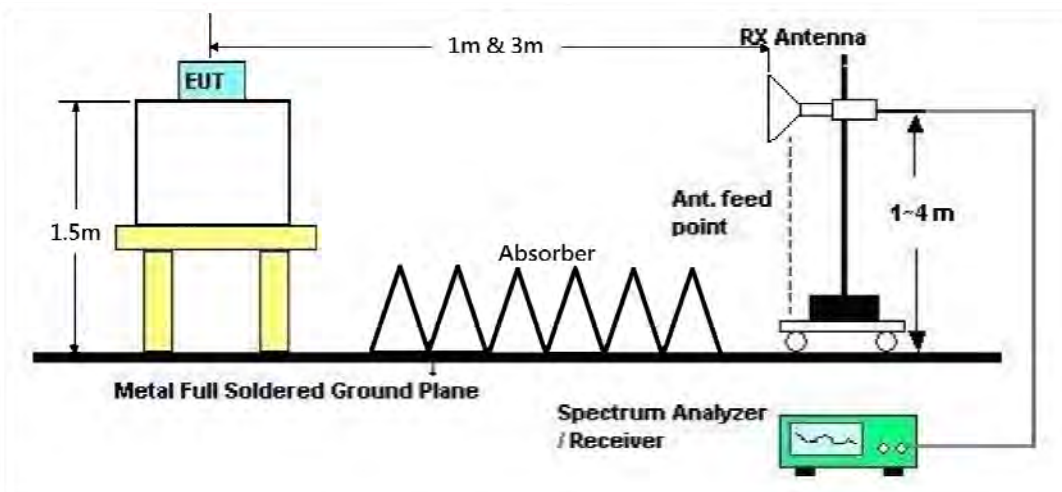

4.5.5. Test Deviation

There is no deviation with the original standard.

4.5.6. EUT Operation during Test

The EUT was programmed to be in continuously transmitting mode.

4.5.7. Results of Radiated Emissions (9kHz~30MHz)

Temperature	26°C	Humidity	51%
Test Engineer	Owen Hsu	Configurations	CTX
Test Date	Oct. 06, 2015		

Freq. (MHz)	Level (dBuV)	Over Limit (dB)	Limit Line (dBuV)	Remark
-	-	-	-	See Note

Note:

The amplitude of spurious emissions which are attenuated by more than 20 dB below the permissible value has no need to be reported.

Distance extrapolation factor = $40 \log(\text{specific distance} / \text{test distance})$ (dB);

Limit line = specific limits (dBuV) + distance extrapolation factor.

4.5.8. Results of Radiated Emissions (30MHz~1GHz)

Temperature	26°C	Humidity	51%
Test Engineer	Owen Hsu	Configurations	CTX

Horizontal

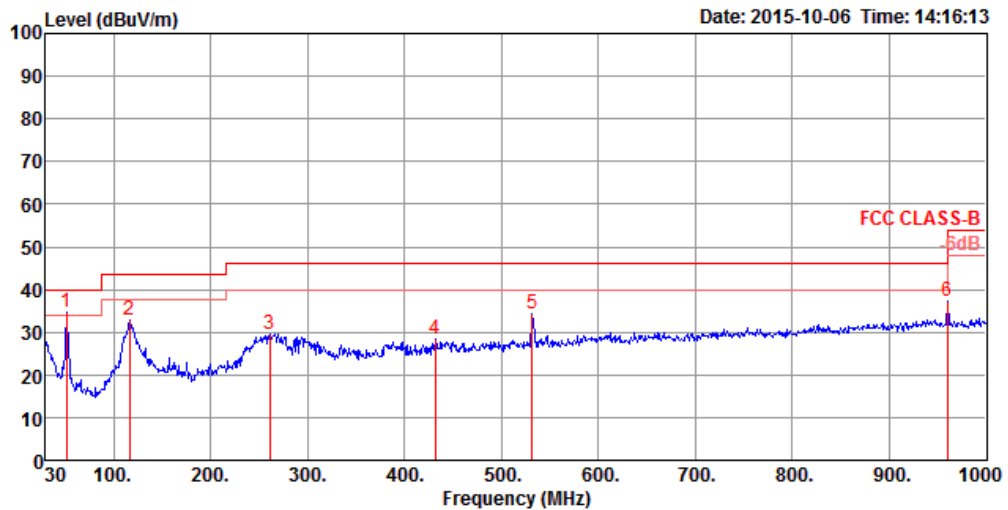

	Freq	Level	Limit Line	Over Limit	Read Level	CableAntenna Loss	Preamp Factor	A/Pos	T/Pos	Remark	Pol/Phase
	MHz	dBuV/m	dBuV/m	dB	dBuV	dB	dB/m	dB	cm	deg	
1	51.34	34.68	40.00	-5.32	57.64	0.73	8.72	32.41	200	177	Peak HORIZONTAL
2	116.33	32.73	43.50	-10.77	51.49	1.01	12.61	32.38	150	281	Peak HORIZONTAL
3	260.86	29.69	46.00	-16.31	46.71	1.41	13.87	32.30	100	242	Peak HORIZONTAL
4	431.58	28.24	46.00	-17.76	41.91	1.79	16.88	32.34	100	335	Peak HORIZONTAL
5	531.49	34.37	46.00	-11.63	46.41	1.95	18.38	32.37	200	302	Peak HORIZONTAL
6	960.23	37.20	54.00	-16.80	43.83	2.50	22.06	31.19	100	118	Peak HORIZONTAL

Vertical

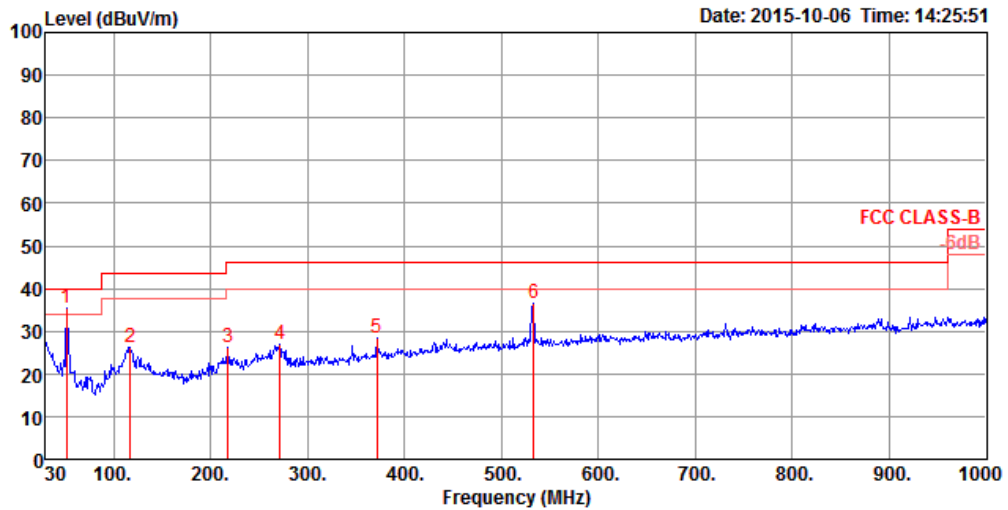

	Freq	Level	Limit Line	Over Limit	Read Level	CableAntenna Loss	Preamp Factor	A/Pos	T/Pos	Remark	Pol/Phase	
	MHz	dBuV/m	dBuV/m	dB	dBuV	dB	dB/m	dB	cm	deg		
1	51.34	35.37	40.00	-4.63	58.33	0.73	8.72	32.41	175	272	Peak	VERTICAL
2	117.30	26.16	43.50	-17.34	44.84	1.02	12.68	32.38	200	0	Peak	VERTICAL
3	218.18	26.13	46.00	-19.87	46.42	1.31	10.72	32.32	100	359	Peak	VERTICAL
4	271.53	27.01	46.00	-18.99	44.28	1.43	13.59	32.29	150	280	Peak	VERTICAL
5	371.44	28.24	46.00	-17.76	43.05	1.67	15.84	32.32	150	280	Peak	VERTICAL
6	533.43	36.35	46.00	-9.65	48.35	1.96	18.41	32.37	125	238	Peak	VERTICAL

Note:

The amplitude of spurious emissions which are attenuated by more than 20 dB below the permissible value has no need to be reported.

Emission level (dBuV/m) = 20 log Emission level (uV/m).

Corrected Reading: Antenna Factor + Cable Loss + Read Level - Preamp Factor = Level.

4.5.9. Results for Radiated Emissions (1GHz~10th Harmonic)

Temperature	26°C	Humidity	51%
Test Engineer	Owen Hsu	Configurations	IEEE 802.11b CH 1 / Ant. 1
Test Date	Sep. 10, 2015		

Horizontal

	Freq	Level	Limit Line	Over Limit	Read Level	Cable Loss	Antenna Factor	Preamp Factor	A/Pos	T/Pos	Remark	Pol/Phase
	MHz	dBuV/m	dBuV/m	dB	dBuV	dB	dB/m	dB	cm	deg		
1	4824.04	47.14	54.00	-6.86	40.99	6.11	33.12	33.08	116	173	Average	HORIZONTAL
2	4824.05	52.92	74.00	-21.08	46.77	6.11	33.12	33.08	116	173	Peak	HORIZONTAL

Vertical

	Freq	Level	Limit Line	Over Limit	Read Level	Cable Loss	Antenna Factor	Preamp Factor	A/Pos	T/Pos	Remark	Pol/Phase
	MHz	dBuV/m	dBuV/m	dB	dBuV	dB	dB/m	dB	cm	deg		
1	4823.86	49.55	74.00	-24.45	43.40	6.11	33.12	33.08	190	187	Peak	VERTICAL
2	4824.08	41.52	54.00	-12.48	35.37	6.11	33.12	33.08	190	187	Average	VERTICAL

Temperature	26°C	Humidity	51%
Test Engineer	Owen Hsu	Configurations	IEEE 802.11b CH 6 / Ant. 1
Test Date	Sep. 10, 2015		

Horizontal

	Freq	Level	Limit Line	Over Limit	Read Level	Cable Loss	Antenna Factor	Preamp Factor	A/Pos	T/Pos	Remark	Pol/Phase
	MHz	dBuV/m	dBuV/m	dB	dBuV	dB	dB/m	dB	cm	deg		
1	4874.02	53.85	74.00	-20.15	47.62	6.08	33.23	33.08	136	82	Peak	HORIZONTAL
2	4874.06	48.67	54.00	-5.33	42.44	6.08	33.23	33.08	136	82	Average	HORIZONTAL
3	7309.32	53.78	54.00	-0.22	42.89	8.28	36.08	33.47	100	1	Average	HORIZONTAL
4	7312.68	59.78	74.00	-14.22	48.87	8.30	36.08	33.47	100	1	Peak	HORIZONTAL

Vertical

	Freq	Level	Limit Line	Over Limit	Read Level	Cable Loss	Antenna Factor	Preamp Factor	A/Pos	T/Pos	Remark	Pol/Phase
	MHz	dBuV/m	dBuV/m	dB	dBuV	dB	dB/m	dB	cm	deg		
1	4874.01	42.02	54.00	-11.98	35.79	6.08	33.23	33.08	138	186	Average	VERTICAL
2	4874.14	49.41	74.00	-24.59	43.18	6.08	33.23	33.08	138	186	Peak	VERTICAL
3	7309.33	50.46	54.00	-3.54	39.57	8.28	36.08	33.47	288	125	Average	VERTICAL
4	7309.62	58.01	74.00	-15.99	47.12	8.28	36.08	33.47	288	125	Peak	VERTICAL

Temperature	26°C	Humidity	51%
Test Engineer	Owen Hsu	Configurations	IEEE 802.11b CH 11 / Ant. 1
Test Date	Sep. 10, 2015		

Horizontal

	Freq	Level	Limit Line	Over Limit	Read Level	Cable Loss	Antenna Factor	Preamp Factor	A/Pos	T/Pos	Remark	Pol/Phase
	MHz	dBuV/m	dBuV/m	dB	dBuV	dB	dB/m	dB	cm	deg		
1	4924.04	50.69	54.00	-3.31	44.35	6.05	33.35	33.06	118	82	Average	HORIZONTAL
2	4924.08	55.05	74.00	-18.95	48.71	6.05	33.35	33.06	118	82	Peak	HORIZONTAL
3	7387.59	58.74	74.00	-15.26	47.62	8.34	36.27	33.49	101	93	Peak	HORIZONTAL
4	7387.86	50.55	54.00	-3.45	39.40	8.37	36.27	33.49	101	93	Average	HORIZONTAL

Vertical

	Freq	Level	Limit Line	Over Limit	Read Level	Cable Loss	Antenna Factor	Preamp Factor	A/Pos	T/Pos	Remark	Pol/Phase
	MHz	dBuV/m	dBuV/m	dB	dBuV	dB	dB/m	dB	cm	deg		
1	4924.01	50.31	74.00	-23.69	43.97	6.05	33.35	33.06	285	216	Peak	VERTICAL
2	4924.10	44.31	54.00	-9.69	37.97	6.05	33.35	33.06	285	216	Average	VERTICAL
3	7387.01	57.88	74.00	-16.12	46.76	8.34	36.27	33.49	102	130	Peak	VERTICAL
4	7387.84	49.80	54.00	-4.20	38.65	8.37	36.27	33.49	102	130	Average	VERTICAL

Temperature	26°C	Humidity	51%
Test Engineer	Owen Hsu	Configurations	IEEE 802.11g CH 1 / Ant. 1
Test Date	Sep. 10, 2015		

Horizontal

	Freq	Level	Limit Line	Over Limit	Read Level	Cable Loss	Antenna Factor	Preamp Factor	A/Pos	T/Pos	Remark	Pol/Phase
	MHz	dBuV/m	dBuV/m	dB	dBuV	dB	dB/m	dB	cm	deg		
1	4823.80	35.38	54.00	-18.62	29.23	6.11	33.12	33.08	151	169	Average	HORIZONTAL
2	4823.86	48.60	74.00	-25.40	42.45	6.11	33.12	33.08	151	169	Peak	HORIZONTAL

Vertical

	Freq	Level	Limit Line	Over Limit	Read Level	Cable Loss	Antenna Factor	Preamp Factor	A/Pos	T/Pos	Remark	Pol/Phase
	MHz	dBuV/m	dBuV/m	dB	dBuV	dB	dB/m	dB	cm	deg		
1	4823.71	34.07	54.00	-19.93	27.92	6.11	33.12	33.08	166	64	Average	VERTICAL
2	4823.78	48.06	74.00	-25.94	41.91	6.11	33.12	33.08	166	64	Peak	VERTICAL

Temperature	26°C	Humidity	51%
Test Engineer	Owen Hsu	Configurations	IEEE 802.11g CH 6 / Ant. 1
Test Date	Sep. 10, 2015		

Horizontal

	Freq	Level	Limit Line	Over Limit	Read Level	Cable Loss	Antenna Factor	Preamp Factor	A/Pos	T/Pos	Remark	Pol/Phase
	MHz	dBuV/m	dBuV/m	dB	dBuV	dB	dB/m	dB	cm	deg		
1	7308.51	60.40	74.00	-13.60	49.51	8.28	36.08	33.47	103	94	Peak	HORIZONTAL
2	7310.62	46.36	54.00	-7.64	35.47	8.28	36.08	33.47	103	94	Average	HORIZONTAL

Vertical

	Freq	Level	Limit Line	Over Limit	Read Level	Cable Loss	Antenna Factor	Preamp Factor	A/Pos	T/Pos	Remark	Pol/Phase
	MHz	dBuV/m	dBuV/m	dB	dBuV	dB	dB/m	dB	cm	deg		
1	7308.73	60.06	74.00	-13.94	49.17	8.28	36.08	33.47	101	123	Peak	VERTICAL
2	7310.63	45.64	54.00	-8.36	34.75	8.28	36.08	33.47	101	123	Average	VERTICAL

Temperature	26°C	Humidity	51%
Test Engineer	Owen Hsu	Configurations	IEEE 802.11g CH 11 / Ant. 1
Test Date	Sep. 10, 2015		

Horizontal

	Freq	Level	Limit Line	Over Limit	Read Level	Cable Loss	Antenna Factor	Preamp Factor	A/Pos	T/Pos	Remark	Pol/Phase
	MHz	dBuV/m	dBuV/m	dB	dBuV	dB	dB/m	dB	cm	deg		
1	7385.94	39.95	54.00	-14.05	28.83	8.34	36.27	33.49	150	71	Average	HORIZONTAL
2	7388.34	53.06	74.00	-20.94	41.91	8.37	36.27	33.49	150	71	Peak	HORIZONTAL

Vertical

	Freq	Level	Limit Line	Over Limit	Read Level	Cable Loss	Antenna Factor	Preamp Factor	A/Pos	T/Pos	Remark	Pol/Phase
	MHz	dBuV/m	dBuV/m	dB	dBuV	dB	dB/m	dB	cm	deg		
1	7384.08	53.27	74.00	-20.73	42.15	8.34	36.27	33.49	138	300	Peak	VERTICAL
2	7384.89	40.06	54.00	-13.94	28.94	8.34	36.27	33.49	138	300	Average	VERTICAL

Temperature	26°C	Humidity	51%
Test Engineer	Owen Hsu	Configurations	IEEE 802.11n MCS0 HT20 CH 1 / Ant. 1
Test Date	Sep. 10, 2015		

Horizontal

	Freq	Level	Limit Line	Over Limit	Read Level	Cable Loss	Antenna Factor	Preamp Factor	A/Pos	T/Pos	Remark	Pol/Phase
	MHz	dBuV/m	dBuV/m	dB	dBuV	dB	dB/m	dB	cm	deg		
1	4820.06	47.73	74.00	-26.27	41.58	6.11	33.12	33.08	144	74	Peak	HORIZONTAL
2	4823.62	35.04	54.00	-18.96	28.89	6.11	33.12	33.08	144	74	Average	HORIZONTAL

Vertical

	Freq	Level	Limit Line	Over Limit	Read Level	Cable Loss	Antenna Factor	Preamp Factor	A/Pos	T/Pos	Remark	Pol/Phase
	MHz	dBuV/m	dBuV/m	dB	dBuV	dB	dB/m	dB	cm	deg		
1	4821.85	48.95	74.00	-25.05	42.80	6.11	33.12	33.08	142	-1	Peak	VERTICAL
2	4822.05	36.29	54.00	-17.71	30.14	6.11	33.12	33.08	142	-1	Average	VERTICAL

Temperature	26°C	Humidity	51%
Test Engineer	Owen Hsu	Configurations	IEEE 802.11n MCS0 HT20 CH 6 / Ant. 1
Test Date	Sep. 10, 2015		

Horizontal

	Freq	Level	Limit Line	Over Limit	Read Level	Cable Loss	Antenna Factor	Preamp Factor	A/Pos	T/Pos	Remark	Pol/Phase
	MHz	dBuV/m	dBuV/m	dB	dBuV	dB	dB/m	dB	cm	deg		
1	7311.67	58.08	74.00	-15.92	47.17	8.30	36.08	33.47	134	95	Peak	HORIZONTAL
2	7312.47	45.28	54.00	-8.72	34.37	8.30	36.08	33.47	134	95	Average	HORIZONTAL

Vertical

	Freq	Level	Limit Line	Over Limit	Read Level	Cable Loss	Antenna Factor	Preamp Factor	A/Pos	T/Pos	Remark	Pol/Phase
	MHz	dBuV/m	dBuV/m	dB	dBuV	dB	dB/m	dB	cm	deg		
1	7310.67	44.34	54.00	-9.66	33.45	8.28	36.08	33.47	129	223	Average	VERTICAL
2	7313.08	58.17	74.00	-15.83	47.26	8.30	36.08	33.47	129	223	Peak	VERTICAL

Temperature	26°C	Humidity	51%
Test Engineer	Owen Hsu	Configurations	IEEE 802.11n MCS0 HT20 CH 11 / Ant. 1
Test Date	Sep. 10, 2015		

Horizontal

	Freq	Level	Limit	Over	Read	Cable	Antenna	Preamp	A/Pos	T/Pos	Remark	Pol/Phase
	MHz	dBuV/m	dBuV/m	dB	dBuV	Loss	Factor	Factor	cm	deg		
1	7379.33	53.85	74.00	-20.15	42.77	8.34	36.23	33.49	152	294	Peak	HORIZONTAL
2	7390.01	42.20	54.00	-11.80	31.05	8.37	36.27	33.49	152	294	Average	HORIZONTAL

Vertical

	Freq	Level	Limit	Over	Read	Cable	Antenna	Preamp	A/Pos	T/Pos	Remark	Pol/Phase
	MHz	dBuV/m	dBuV/m	dB	dBuV	Loss	Factor	Factor	cm	deg		
1	7382.35	53.57	74.00	-20.43	42.49	8.34	36.23	33.49	139	96	Peak	VERTICAL
2	7394.78	41.68	54.00	-12.32	30.53	8.37	36.27	33.49	139	96	Average	VERTICAL

Temperature	26°C	Humidity	51%
Test Engineer	Owen Hsu	Configurations	IEEE 802.11n MCS0 HT40 CH 3 / Ant. 1
Test Date	Sep. 10, 2015		

Horizontal

	Freq	Level	Limit Line	Over Limit	Read Level	Cable Loss	Antenna Factor	Preamp Factor	A/Pos	T/Pos	Remark	Pol/Phase
	MHz	dBuV/m	dBuV/m	dB	dBuV	dB	dB/m	dB	cm	deg		
1	4837.59	48.66	74.00	-25.34	42.47	6.11	33.16	33.08	145	65	Peak	HORIZONTAL
2	4838.71	36.18	54.00	-17.82	30.00	6.10	33.16	33.08	145	65	Average	HORIZONTAL

Vertical

	Freq	Level	Limit Line	Over Limit	Read Level	Cable Loss	Antenna Factor	Preamp Factor	A/Pos	T/Pos	Remark	Pol/Phase
	MHz	dBuV/m	dBuV/m	dB	dBuV	dB	dB/m	dB	cm	deg		
1	4834.64	47.60	74.00	-26.40	41.41	6.11	33.16	33.08	150	141	Peak	VERTICAL
2	4836.98	36.04	54.00	-17.96	29.85	6.11	33.16	33.08	150	141	Average	VERTICAL

Temperature	26°C	Humidity	51%
Test Engineer	Owen Hsu	Configurations	IEEE 802.11n MCS0 HT40 CH 6 / Ant. 1
Test Date	Sep. 10, 2015		

Horizontal

	Freq	Level	Limit	Over	Read	Cable	Antenna	Preamp	A/Pos	T/Pos	Remark	Pol/Phase
	MHz	dBuV/m	dBuV/m	dB	dBuV	Loss	Factor	Factor	cm	deg		
1	7313.18	41.41	54.00	-12.59	30.50	8.30	36.08	33.47	159	244	Average	HORIZONTAL
2	7317.96	53.00	74.00	-21.00	42.05	8.30	36.12	33.47	159	244	Peak	HORIZONTAL

Vertical

	Freq	Level	Limit	Over	Read	Cable	Antenna	Preamp	A/Pos	T/Pos	Remark	Pol/Phase
	MHz	dBuV/m	dBuV/m	dB	dBuV	Loss	Factor	Factor	cm	deg		
1	7303.34	41.26	54.00	-12.74	30.37	8.28	36.08	33.47	166	295	Average	VERTICAL
2	7317.44	53.13	74.00	-20.87	42.18	8.30	36.12	33.47	166	295	Peak	VERTICAL

Temperature	26°C	Humidity	51%
Test Engineer	Owen Hsu	Configurations	IEEE 802.11n MCS0 HT40 CH 9 / Ant. 1
Test Date	Sep. 10, 2015		

Horizontal

	Freq	Level	Limit Line	Over Limit	Read Level	Cable Loss	Antenna Factor	Preamp Factor	A/Pos	T/Pos	Remark	Pol/Phase
	MHz	dBuV/m	dBuV/m	dB	dBuV	dB	dB/m	dB	cm	deg		
1	7347.35	54.04	74.00	-19.96	43.04	8.32	36.16	33.48	153	181	Peak	HORIZONTAL
2	7353.21	40.52	54.00	-13.48	29.48	8.32	36.20	33.48	153	181	Average	HORIZONTAL

Vertical

	Freq	Level	Limit Line	Over Limit	Read Level	Cable Loss	Antenna Factor	Preamp Factor	A/Pos	T/Pos	Remark	Pol/Phase
	MHz	dBuV/m	dBuV/m	dB	dBuV	dB	dB/m	dB	cm	deg		
1	7349.40	40.58	54.00	-13.42	29.58	8.32	36.16	33.48	173	308	Average	VERTICAL
2	7353.92	53.81	74.00	-20.19	42.77	8.32	36.20	33.48	173	359	Peak	VERTICAL

Note:

The amplitude of spurious emissions that are attenuated by more than 20dB below the permissible value has no need to be reported.

Emission level (dBuV/m) = 20 log Emission level (uV/m).

Corrected Reading: Antenna Factor + Cable Loss + Read Level - Preamp Factor = Level.

4.6. Emissions Measurement

4.6.1. Limit

30dBc in any 100 kHz bandwidth outside the operating frequency band. In case the emission fall within the restricted band specified on 15.205(a), then the 15.209(a) limit in the table below has to be followed.

Frequencies (MHz)	Field Strength (micorvolts/meter)	Measurement Distance (meters)
0.009~0.490	2400/F(kHz)	300
0.490~1.705	24000/F(kHz)	30
1.705~30.0	30	30
30~88	100	3
88~216	150	3
216~960	200	3
Above 960	500	3

4.6.2. Measuring Instruments and Setting

Please refer to section 5 of equipments list in this report. The following table is the setting of the spectrum analyzer.

Spectrum Parameter	Setting
Attenuation	Auto
Span Frequency	100 MHz
RBW / VBW (Emission in restricted band)	1 MHz / 3MHz for Peak, 1 MHz / 1/T for Average
RBW / VBW (30dBc in any 100 kHz bandwidth emission)	100 kHz / 300 kHz for Peak

4.6.3. Test Procedures

For Radiated band edges Measurement:

1. The test procedure is the same as section 4.5.3.

For Radiated Out of Band Emission Measurement:

1. Test was performed in accordance with KDB558074 D01 v03r03 for Performing Compliance Measurements on Digital Transmission Systems (DTS) Operating Under §15.247 section 10.1 Unwanted Emissions into Non-Restricted Frequency Bands Measurement Procedure.

4.6.4. Test Setup Layout

For Radiated band edges Measurement:

This test setup layout is the same as that shown in section 4.5.4.

For Radiated Out of Band Emission Measurement:

This test setup layout is the same as that shown in section 4.5.4.

4.6.5. Test Deviation

There is no deviation with the original standard.

4.6.6. EUT Operation during Test

The EUT was programmed to be in continuously transmitting mode.

4.6.7. Test Result of Band Edge and Fundamental Emissions

Temperature	26°C	Humidity	51%
Test Engineer	Owen Hsu	Configurations	IEEE 802.11b CH 1, 6, 11 / Ant. 1
Test Date	Sep. 10, 2015		

Channel 1

	Freq	Level	Limit Line	Over Limit	Read Level	CableAntenna Loss	Antenna Factor	Preamp Factor	A/Pos	T/Pos	Remark	Pol/Phase
	MHz	dBuV/m	dBuV/m	dB	dBuV	dB	dB/m	dB	cm	deg		
1	2389.24	53.86	54.00	-0.14	21.18	4.37	28.31	0.00	112	108	Average	HORIZONTAL
2	2389.72	62.24	74.00	-11.76	29.56	4.37	28.31	0.00	112	108	Peak	HORIZONTAL
3	2412.96	106.19			73.44	4.41	28.34	0.00	112	108	Peak	HORIZONTAL
4	2413.76	102.68			69.93	4.41	28.34	0.00	112	108	Average	HORIZONTAL

Item 3, 4 are the fundamental frequency at 2412 MHz.

Channel 6

	Freq	Level	Limit Line	Over Limit	Read Level	CableAntenna Loss	Antenna Factor	Preamp Factor	A/Pos	T/Pos	Remark	Pol/Phase
	MHz	dBuV/m	dBuV/m	dB	dBuV	dB	dB/m	dB	cm	deg		
1	2390.00	49.04	54.00	-4.96	16.32	4.41	28.31	0.00	242	115	Average	HORIZONTAL
2	2390.00	59.81	74.00	-14.19	27.09	4.41	28.31	0.00	242	115	Peak	HORIZONTAL
3	2438.60	108.66			75.81	4.44	28.41	0.00	242	115	Peak	HORIZONTAL
4	2438.92	105.24			72.39	4.44	28.41	0.00	242	115	Average	HORIZONTAL
5	2483.50	49.02	54.00	-4.98	16.04	4.51	28.47	0.00	242	115	Average	HORIZONTAL
6	2485.10	59.08	74.00	-14.92	26.10	4.51	28.47	0.00	242	115	Peak	HORIZONTAL

Item 3, 4 are the fundamental frequency at 2437 MHz.

Channel 11

	Freq	Level	Limit Line	Over Limit	Read Level	CableAntenna Loss	Antenna Factor	Preamp Factor	A/Pos	T/Pos	Remark	Pol/Phase
	MHz	dBuV/m	dBuV/m	dB	dBuV	dB	dB/m	dB	cm	deg		
1	2463.60	106.26			73.34	4.48	28.44	0.00	128	152	Peak	HORIZONTAL
2	2463.76	102.53			69.61	4.48	28.44	0.00	128	152	Average	HORIZONTAL
3	2483.50	53.66	54.00	-0.34	20.68	4.51	28.47	0.00	128	152	Average	HORIZONTAL
4	2483.50	62.11	74.00	-11.89	29.13	4.51	28.47	0.00	128	152	Peak	HORIZONTAL

Item 1, 2 are the fundamental frequency at 2462 MHz.

Temperature	26°C	Humidity	51%
Test Engineer	Owen Hsu	Configurations	IEEE 802.11g CH 1, 6, 11 / Ant. 1
Test Date	Sep. 10, 2015		

Channel 1

	Freq	Level	Limit Line	Over Limit	Read Level	Cable Loss	Antenna Factor	Preamp Factor	A/Pos	T/Pos	Remark	Pol/Phase
	MHz	dBuV/m	dBuV/m	dB	dBuV	dB	dB/m	dB	cm	deg		
1	2388.28	67.26	74.00	-6.74	34.58	4.37	28.31	0.00	250	116	Peak	HORIZONTAL
2	2390.00	53.94	54.00	-0.06	21.22	4.41	28.31	0.00	250	116	Average	HORIZONTAL
3	2405.11	95.87			63.12	4.41	28.34	0.00	250	116	Average	HORIZONTAL
4	2407.19	106.52			73.77	4.41	28.34	0.00	250	116	Peak	HORIZONTAL

Item 3, 4 are the fundamental frequency at 2412 MHz.

Channel 6

	Freq	Level	Limit Line	Over Limit	Read Level	Cable Loss	Antenna Factor	Preamp Factor	A/Pos	T/Pos	Remark	Pol/Phase
	MHz	dBuV/m	dBuV/m	dB	dBuV	dB	dB/m	dB	cm	deg		
1	2386.36	68.54	74.00	-5.46	35.86	4.37	28.31	0.00	112	146	Peak	HORIZONTAL
2	2390.00	53.77	54.00	-0.23	21.05	4.41	28.31	0.00	112	146	Average	HORIZONTAL
3	2429.63	100.89			68.07	4.44	28.38	0.00	112	146	Average	HORIZONTAL
4	2429.63	110.87			78.05	4.44	28.38	0.00	112	146	Peak	HORIZONTAL
5	2483.50	65.71	74.00	-8.29	32.73	4.51	28.47	0.00	112	146	Peak	HORIZONTAL
6	2483.56	52.20	54.00	-1.80	19.22	4.51	28.47	0.00	112	146	Average	HORIZONTAL

Item 3, 4 are the fundamental frequency at 2437 MHz.

Channel 11

	Freq	Level	Limit Line	Over Limit	Read Level	Cable Loss	Antenna Factor	Preamp Factor	A/Pos	T/Pos	Remark	Pol/Phase
	MHz	dBuV/m	dBuV/m	dB	dBuV	dB	dB/m	dB	cm	deg		
1	2454.79	95.24			62.32	4.48	28.44	0.00	105	149	Average	HORIZONTAL
2	2457.03	105.62			72.70	4.48	28.44	0.00	105	149	Peak	HORIZONTAL
3	2483.50	53.78	54.00	-0.22	20.80	4.51	28.47	0.00	105	149	Average	HORIZONTAL
4	2483.96	69.62	74.00	-4.38	36.64	4.51	28.47	0.00	105	149	Peak	HORIZONTAL

Item 1, 2 are the fundamental frequency at 2462 MHz.

Temperature	26°C	Humidity	51%
Test Engineer	Owen Hsu	Configurations	IEEE 802.11n MCS0 HT20 CH 1, 6, 11 / Ant. 1
Test Date	Sep. 10, 2015		

Channel 1

	Freq	Level	Limit Line	Over Limit	Read Level	CableAntenna Loss	Antenna Factor	Preamp Factor	A/Pos	T/Pos	Remark	Pol/Phase
	MHz	dBuV/m	dBuV/m	dB	dBuV	dB	dB/m	dB	cm	deg		
1	2389.56	53.56	54.00	-0.44	20.88	4.37	28.31	0.00	252	120	Average	HORIZONTAL
2	2389.56	68.14	74.00	-5.86	35.46	4.37	28.31	0.00	252	120	Peak	HORIZONTAL
3	2404.95	104.00			71.25	4.41	28.34	0.00	252	120	Peak	HORIZONTAL
4	2405.27	94.40			61.65	4.41	28.34	0.00	252	120	Peak	HORIZONTAL

Item 3, 4 are the fundamental frequency at 2412 MHz.

Channel 6

	Freq	Level	Limit Line	Over Limit	Read Level	CableAntenna Loss	Antenna Factor	Preamp Factor	A/Pos	T/Pos	Remark	Pol/Phase
	MHz	dBuV/m	dBuV/m	dB	dBuV	dB	dB/m	dB	cm	deg		
1	2389.56	53.58	54.00	-0.42	20.90	4.37	28.31	0.00	104	118	Average	HORIZONTAL
2	2390.00	66.75	74.00	-7.25	34.03	4.41	28.31	0.00	104	118	Peak	HORIZONTAL
3	2428.99	100.90			68.08	4.44	28.38	0.00	104	118	Average	HORIZONTAL
4	2438.28	110.39			77.54	4.44	28.41	0.00	104	118	Peak	HORIZONTAL
5	2483.80	66.16	74.00	-7.84	33.18	4.51	28.47	0.00	104	118	Peak	HORIZONTAL
6	2484.12	53.12	54.00	-0.88	20.14	4.51	28.47	0.00	104	118	Average	HORIZONTAL

Item 3, 4 are the fundamental frequency at 2437 MHz.

Channel 11

	Freq	Level	Limit Line	Over Limit	Read Level	CableAntenna Loss	Antenna Factor	Preamp Factor	A/Pos	T/Pos	Remark	Pol/Phase
	MHz	dBuV/m	dBuV/m	dB	dBuV	dB	dB/m	dB	cm	deg		
1	2454.63	103.75			70.83	4.48	28.44	0.00	241	117	Peak	HORIZONTAL
2	2454.95	94.69			61.77	4.48	28.44	0.00	241	117	Average	HORIZONTAL
3	2483.50	53.52	54.00	-0.48	20.54	4.51	28.47	0.00	241	117	Average	HORIZONTAL
4	2483.50	70.19	74.00	-3.81	37.21	4.51	28.47	0.00	241	117	Peak	HORIZONTAL

Item 1, 2 are the fundamental frequency at 2462 MHz.

Temperature	26°C	Humidity	51%
Test Engineer	Owen Hsu	Configurations	IEEE 802.11n MCS0 HT40 CH 3, 6, 9 / Ant. 1
Test Date	Sep. 10, 2015		

Channel 3

	Freq	Level	Limit Line	Over Limit	Read Level	Cable Loss	Antenna Factor	Preamp Factor	A/Pos	T/Pos	Remark	Pol/Phase
	MHz	dBuV/m	dBuV/m	dB	dBuV	dB	dB/m	dB	cm	deg		
1	2390.00	53.76	54.00	-0.24	21.04	4.41	28.31	0.00	248	118	Average	HORIZONTAL
2	2390.00	66.08	74.00	-7.92	33.36	4.41	28.31	0.00	248	118	Peak	HORIZONTAL
3	2405.17	99.05			66.30	4.41	28.34	0.00	248	118	Peak	HORIZONTAL
4	2405.97	90.94			58.19	4.41	28.34	0.00	248	118	Average	HORIZONTAL

Item 3, 4 are the fundamental frequency at 2422 MHz.

Channel 6

	Freq	Level	Limit Line	Over Limit	Read Level	Cable Loss	Antenna Factor	Preamp Factor	A/Pos	T/Pos	Remark	Pol/Phase
	MHz	dBuV/m	dBuV/m	dB	dBuV	dB	dB/m	dB	cm	deg		
1	2387.64	65.94	74.00	-8.06	33.26	4.37	28.31	0.00	100	117	Peak	HORIZONTAL
2	2389.56	53.91	54.00	-0.09	21.23	4.37	28.31	0.00	100	117	Average	HORIZONTAL
3	2419.69	92.93			60.11	4.44	28.38	0.00	100	117	Average	HORIZONTAL
4	2420.65	102.39			69.57	4.44	28.38	0.00	100	117	Peak	HORIZONTAL
5	2483.80	65.08	74.00	-8.92	32.10	4.51	28.47	0.00	100	117	Peak	HORIZONTAL
6	2485.40	52.07	54.00	-1.93	19.09	4.51	28.47	0.00	100	117	Average	HORIZONTAL

Item 3, 4 are the fundamental frequency at 2437 MHz.

Channel 9

	Freq	Level	Limit Line	Over Limit	Read Level	Cable Loss	Antenna Factor	Preamp Factor	A/Pos	T/Pos	Remark	Pol/Phase
	MHz	dBuV/m	dBuV/m	dB	dBuV	dB	dB/m	dB	cm	deg		
1	2440.14	101.15			68.30	4.44	28.41	0.00	128	159	Peak	HORIZONTAL
2	2450.72	92.50			59.61	4.48	28.41	0.00	128	159	Average	HORIZONTAL
3	2483.50	53.53	54.00	-0.47	20.55	4.51	28.47	0.00	128	159	Average	HORIZONTAL
4	2485.65	68.28	74.00	-5.72	35.30	4.51	28.47	0.00	128	159	Peak	HORIZONTAL

Item 1, 2 are the fundamental frequency at 2452 MHz.

Note:

Emission level (dBuV/m) = 20 log Emission level (uV/m).

Corrected Reading: Antenna Factor + Cable Loss + Read Level - Preamp Factor = Level.

For Emission not in Restricted Band

Plot on Configuration IEEE 802.11b / Reference Level

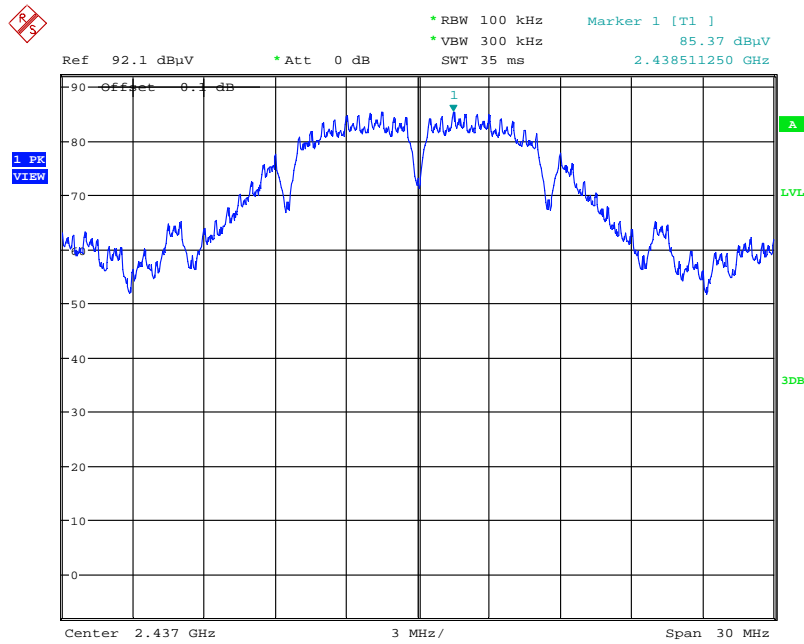

Date: 10.SEP.2015 23:52:11

Plot on Configuration IEEE 802.11b / CH 1 / 30MHz~2400MHz (down 30dBc)

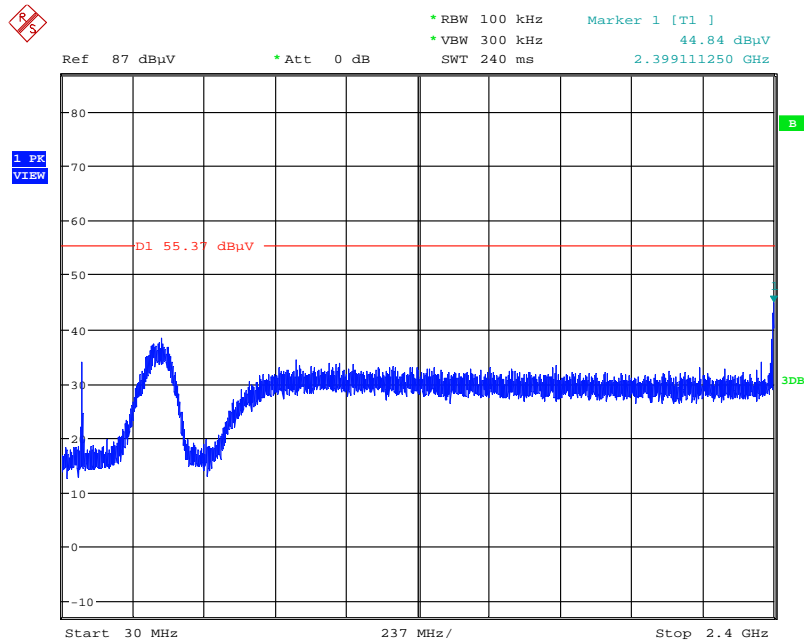

Date: 10.SEP.2015 23:54:05

Plot on Configuration IEEE 802.11b / CH 1 / 2500MHz~26500MHz (down 30dBc)

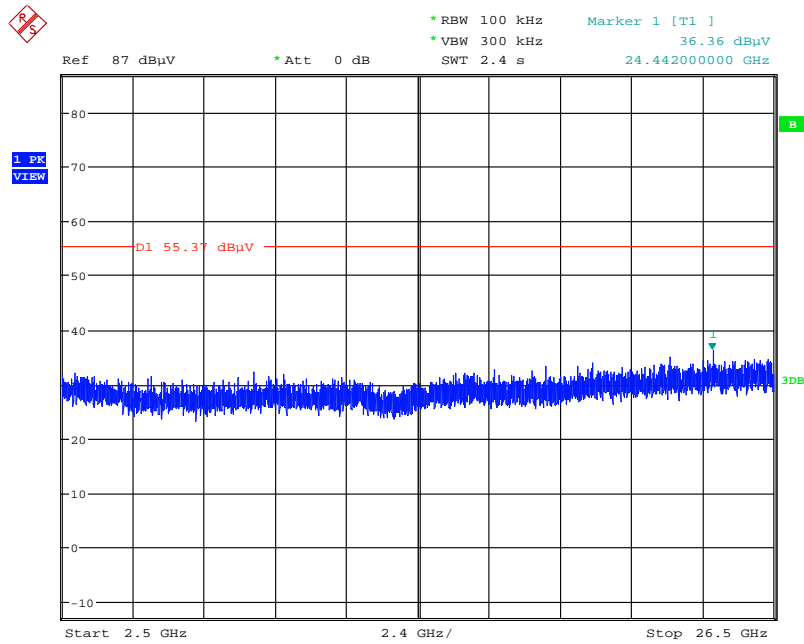

Date: 11.SEP.2015 00:09:32

Plot on Configuration IEEE 802.11b / CH 11 / 30MHz~2400MHz (down 30dBc)

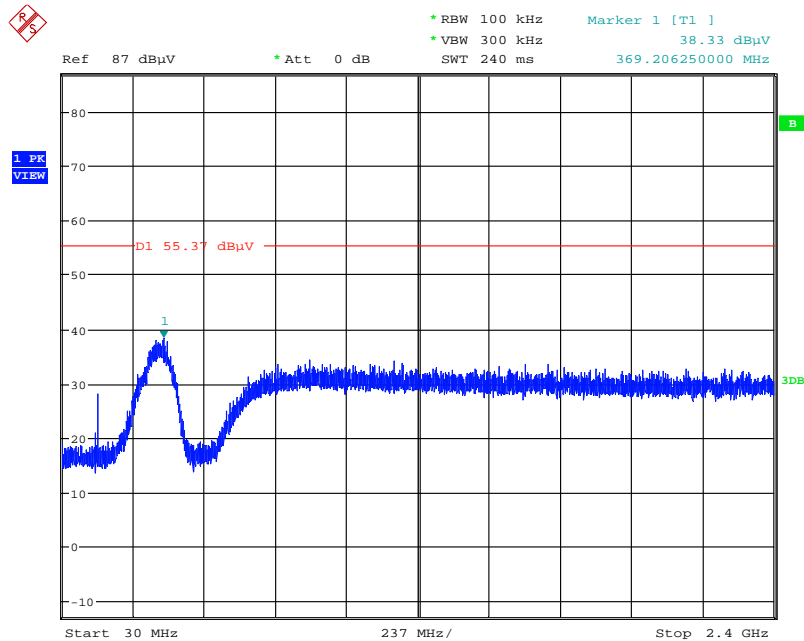

Date: 10.SEP.2015 23:55:06

Plot on Configuration IEEE 802.11b / CH 11 / 2500MHz~26500MHz (down 30dBc)

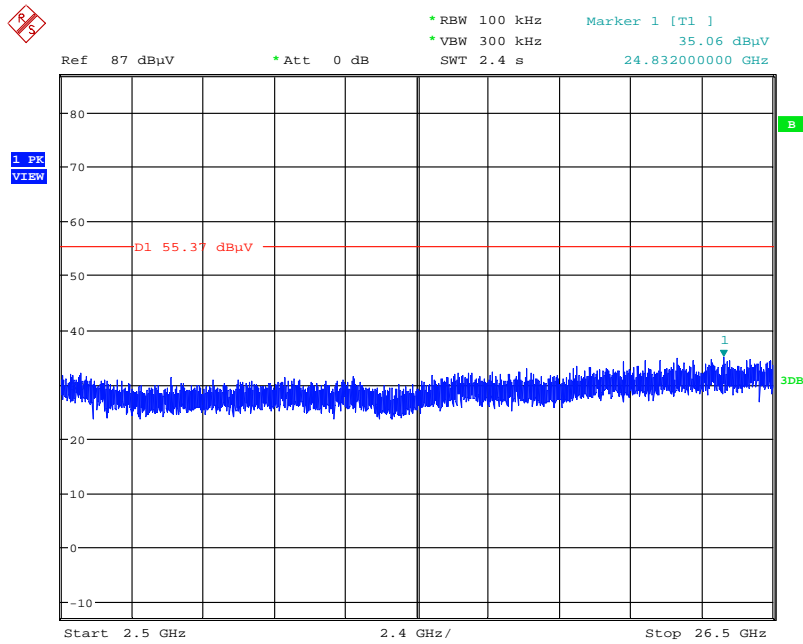

Date: 10.SEP.2015 23:55:28

Plot on Configuration IEEE 802.11g / Reference Level

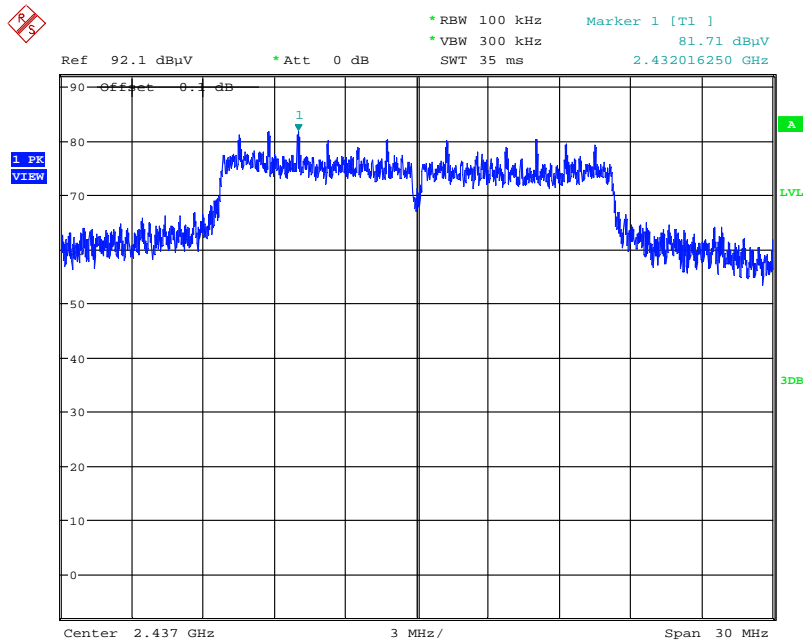

Date: 10.SEP.2015 23:41:54

Plot on Configuration IEEE 802.11g / CH 1 / 30MHz~2400MHz (down 30dBc)

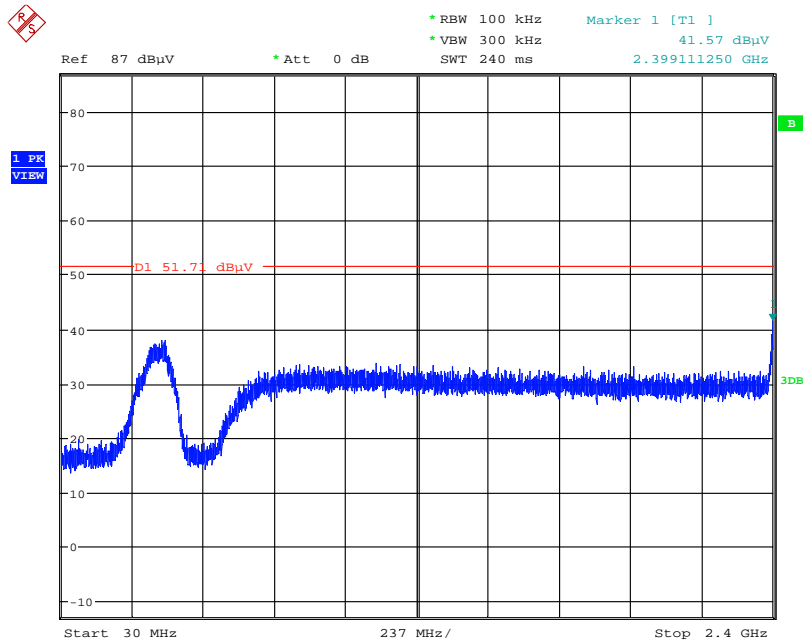

Date: 10.SEP.2015 23:46:03

Plot on Configuration IEEE 802.11g / CH 1 / 2500MHz~26500MHz (down 30dBc)

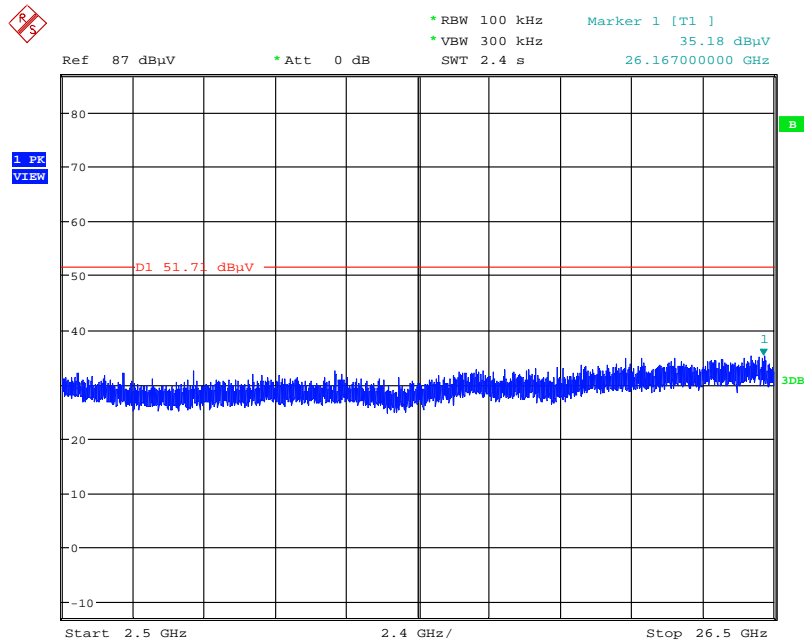

Date: 10.SEP.2015 23:48:36

Plot on Configuration IEEE 802.11g / CH 11 / 30MHz~2400MHz (down 30dBc)

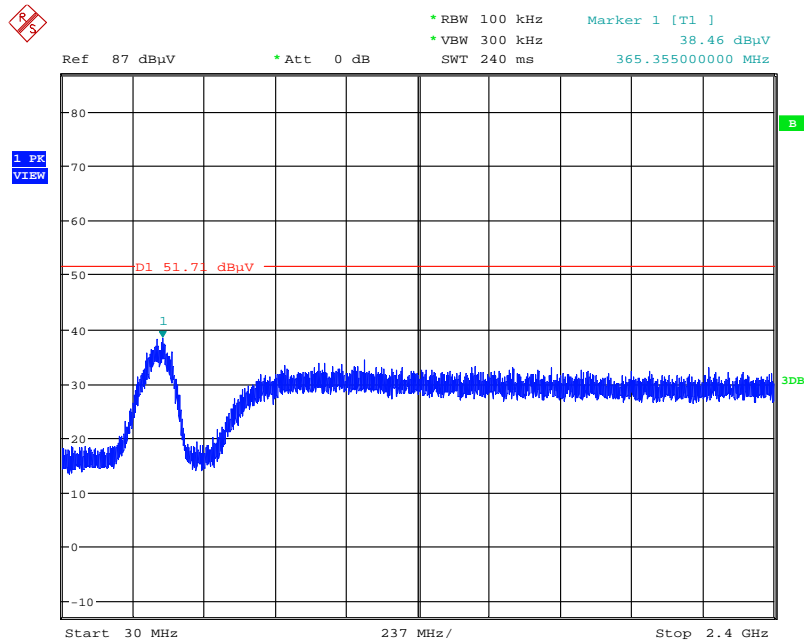

Date: 10.SEP.2015 23:47:12

Plot on Configuration IEEE 802.11g / CH 11 / 2500MHz~26500MHz (down 30dBc)

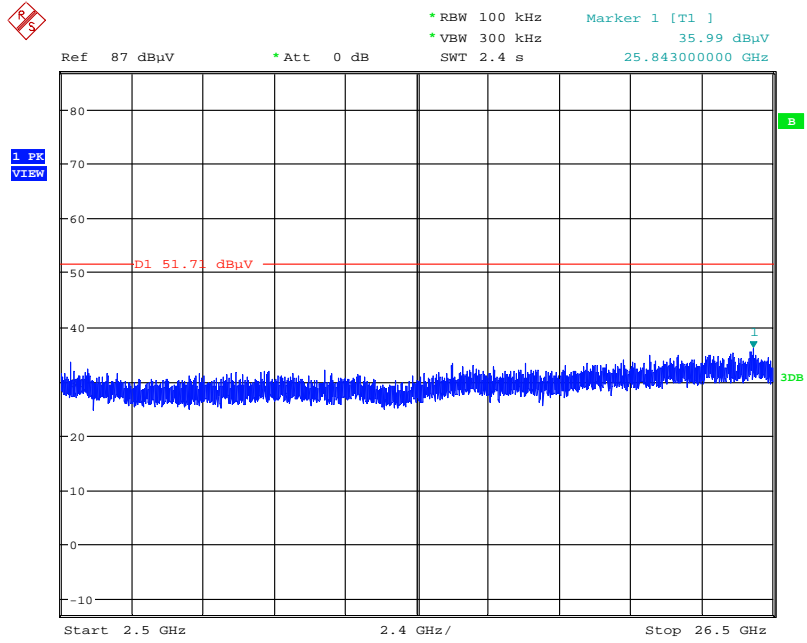

Date: 10.SEP.2015 23:47:54

Plot on Configuration IEEE 802.11n MCS0 HT20 / Reference Level

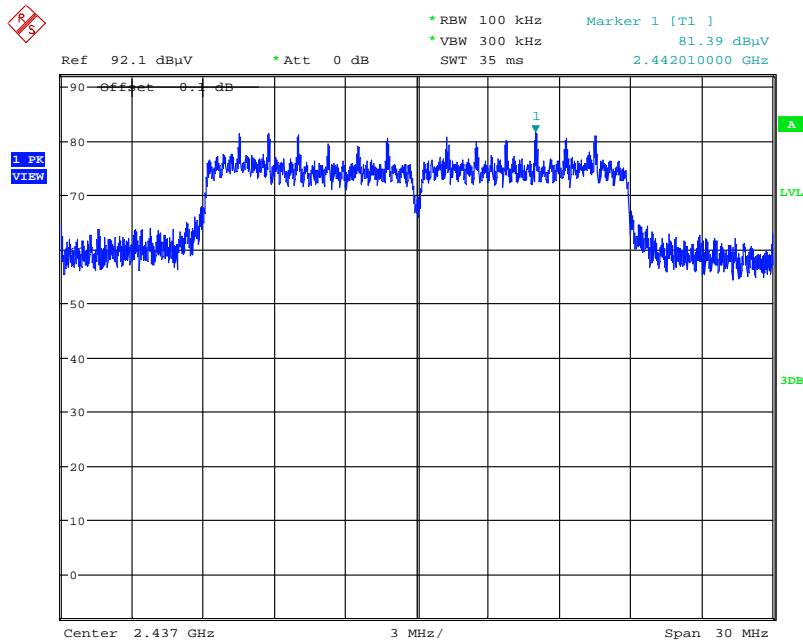

Date: 10.SEP.2015 23:58:14

Plot on Configuration IEEE 802.11n MCS0 HT20 / CH 1 / 30MHz~2400MHz (down 30dBc)

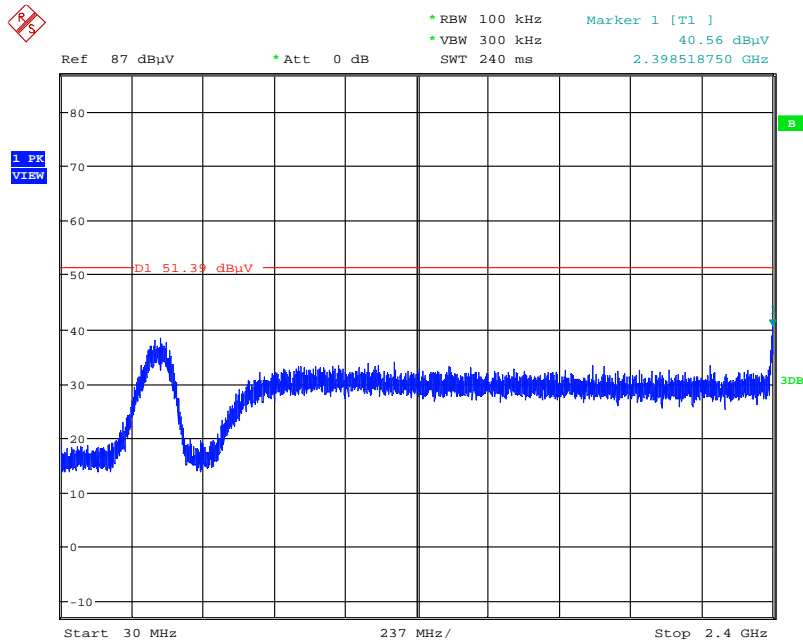

Date: 10.SEP.2015 23:59:28

Plot on Configuration IEEE 802.11n MCS0 HT20 / CH 1 / 2500MHz~26500MHz (down 30dBc)

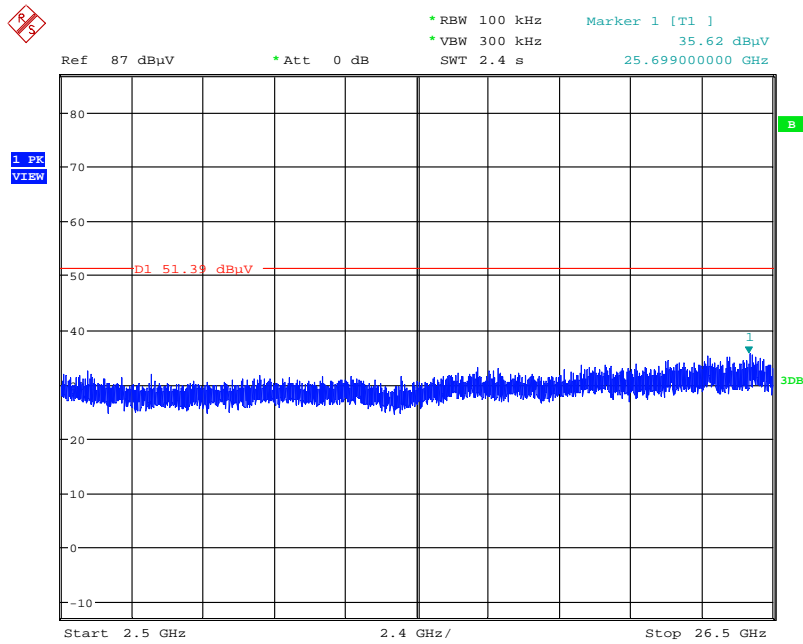

Date: 11.SEP.2015 00:01:16

Plot on Configuration IEEE 802.11n MCS0 HT20 / CH 11 / 30MHz~2400MHz (down 30dBc)

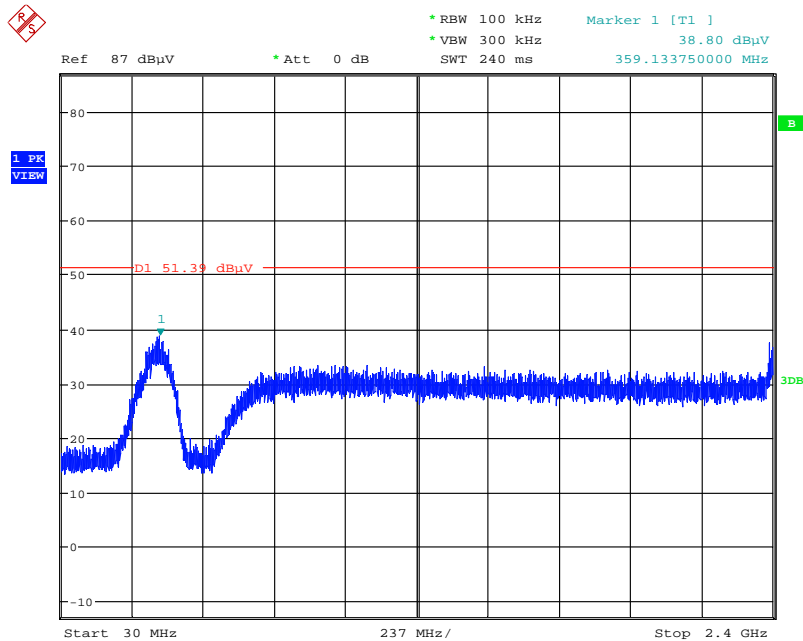

Date: 11.SEP.2015 00:10:37

Plot on Configuration IEEE 802.11n MCS0 HT20 / CH 11 / 2500MHz~26500MHz (down 30dBc)

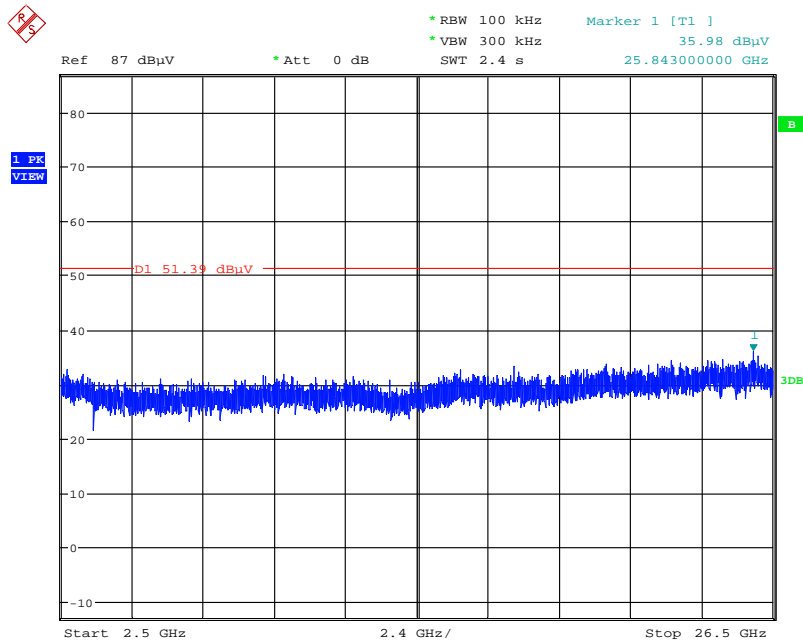

Date: 11.SEP.2015 00:00:49

Plot on Configuration IEEE 802.11n MCS0 HT40 / Reference Level

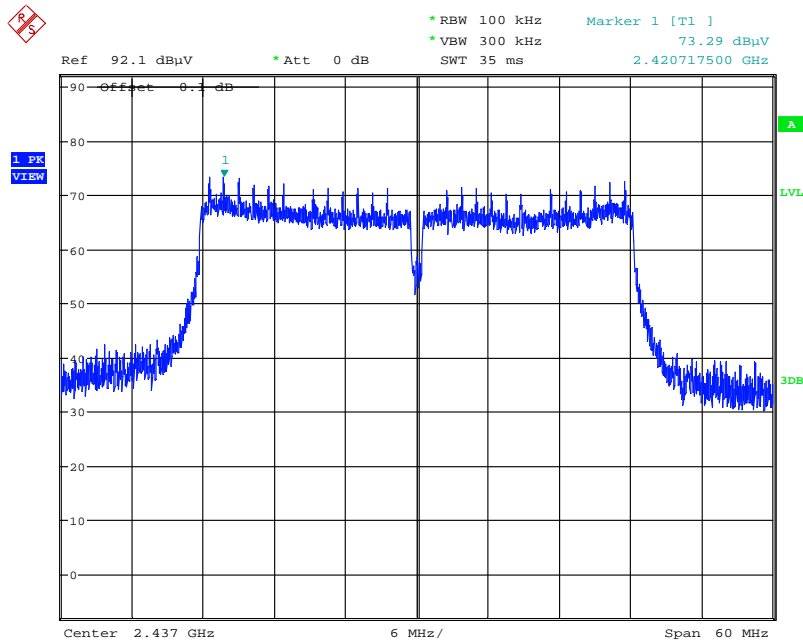

Date: 11.SEP.2015 00:03:00

Plot on Configuration IEEE 802.11n MCS0 HT40 / CH 3 / 30MHz~2400MHz (down 30dBc)

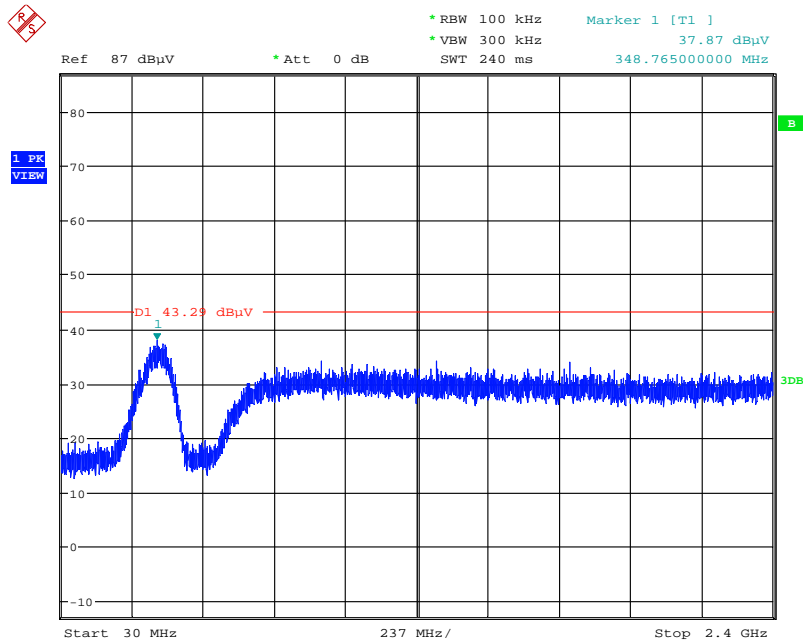

Date: 11.SEP.2015 00:05:01

Plot on Configuration IEEE 802.11n MCS0 HT40 / CH 3 / 2500MHz~26500MHz (down 30dBc)

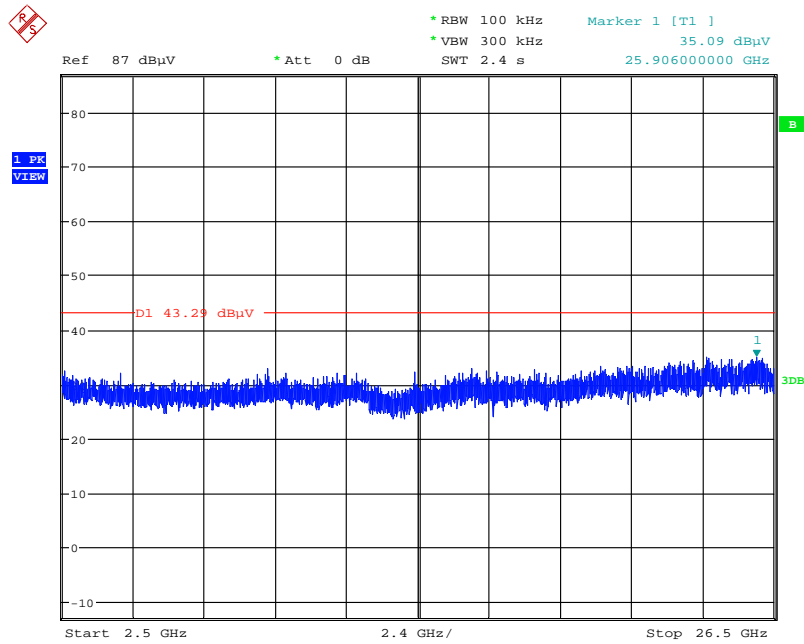

Date: 11.SEP.2015 00:06:17

Plot on Configuration IEEE 802.11n MCS0 HT40 / CH 9 / 30MHz~2400MHz (down 30dBc)

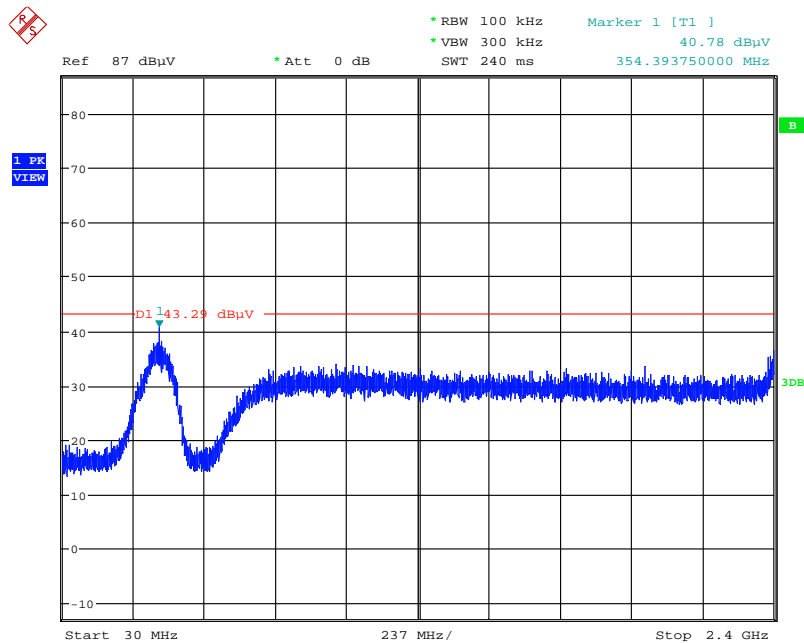

Date: 11.SEP.2015 00:04:16

Plot on Configuration IEEE 802.11n MCS0 HT40 / CH 9 / 2500MHz~26500MHz (down 30dBc)

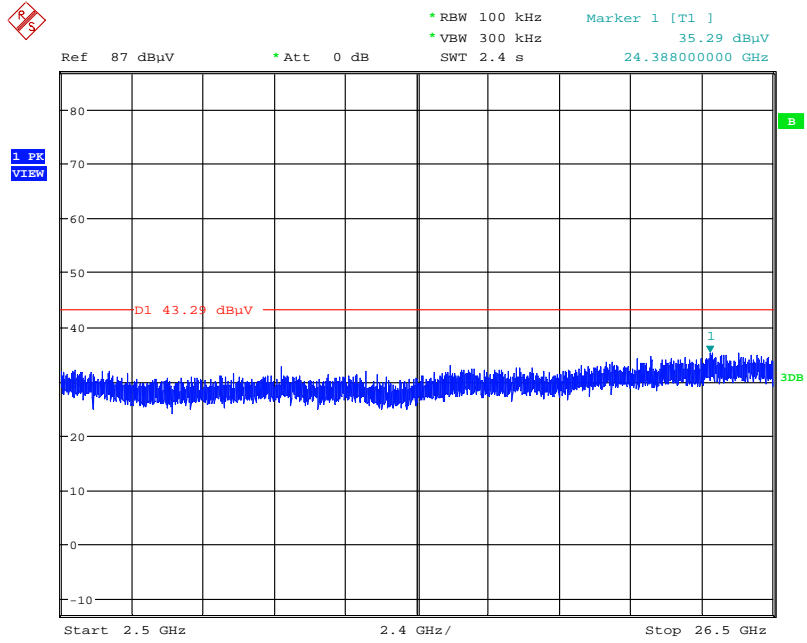

Date: 11.SEP.2015 00:05:36

4.7. Antenna Requirements

4.7.1. Limit

Except for special regulations, the Low-power Radio-frequency Devices must not be equipped with any jacket for installing an antenna with extension cable. An intentional radiator shall be designed to ensure that no antenna other than that furnished by the responsible party shall be used with the device. The use of a permanently attached antenna or of an antenna that uses a unique coupling to the intentional radiator shall be considered sufficient to comply with the provisions of this Section. The manufacturer may design the unit so that the user can replace a broken antenna, but the use of a standard antenna jack or electrical connector is prohibited. Further, this requirement does not apply to intentional radiators that must be professionally installed.

4.7.2. Antenna Connector Construction

Please refer to section 3.3 in this test report; antenna connector complied with the requirements.

5. LIST OF MEASURING EQUIPMENTS

Instrument	Manufacturer	Model No.	Serial No.	Characteristics	Calibration Date	Remark
EMI Test Receiver	R&S	ESCS 30	100355	9kHz ~ 2.75GHz	Apr. 22, 2015	Conduction (CO01-CB)
LISN	F.C.C.	FCC-LISN-50-16-2	04083	150kHz ~ 100MHz	Dec. 02, 2014	Conduction (CO01-CB)
LISN	Schwarzbeck	NSLK 8127	8127647	9kHz ~ 30MHz	Dec. 02, 2014	Conduction (CO01-CB)
COND Cable	Woken	Cable	01	150kHz ~ 30MHz	Dec. 03, 2014	Conduction (CO01-CB)
Software	Audix	E3	5.410e	-	N.C.R.	Conduction (CO01-CB)
BILOG ANTENNA	Schaffner	CBL6112D	22021	20MHz ~ 2GHz	May 06, 2015	Radiation (O3CH01-CB)
Horn Antenna	EMCO	3115	00075790	750MHz ~ 18GHz	Oct. 28, 2014	Radiation (O3CH01-CB)
Horn Antenna	Schwarzbeck	BBHA 9170	BBHA9170252	15GHz ~ 40GHz	Jul. 21, 2015	Radiation (O3CH01-CB)
Pre-Amplifier	Agilent	8447D	2944A10991	0.1MHz ~ 1.3GHz	Feb. 24, 2015	Radiation (O3CH01-CB)
Pre-Amplifier	Agilent	8449B	3008A02310	1GHz ~ 26.5GHz	Jan. 12, 2015	Radiation (O3CH01-CB)
Pre-Amplifier	WM	TF-130N-R1	923365	26GHz ~ 40GHz	Nov. 25, 2014	Radiation (O3CH01-CB)
Spectrum Analyzer	R&S	FSP40	100056	9kHz ~ 40GHz	Nov. 06, 2014	Radiation (O3CH01-CB)
EMI Receiver	Agilent	N9038A	MY52260123	9kHz ~ 8.4GHz	Jan. 21, 2015	Radiation (O3CH01-CB)
RF Cable-low	Woken	Low Cable-1	N/A	30 MHz ~ 1 GHz	Nov. 15, 2014	Radiation (O3CH01-CB)
RF Cable-high	Woken	High Cable-40G-1	N/A	1 GHz ~ 40 GHz	Nov. 15, 2014	Radiation (O3CH01-CB)
RF Cable-high	Woken	High Cable-40G-2	N/A	1 GHz ~ 40 GHz	Nov. 15, 2014	Radiation (O3CH01-CB)
Loop Antenna	Teseq	HLA 6120	24155	9kHz - 30 MHz	Mar. 12, 2015*	Radiation (O3CH01-CB)
Spectrum analyzer	R&S	FSP40	100979	9kHz~40GHz	Dec. 12, 2014	Conducted (TH01-CB)
RF Cable-high	Woken	RG402	High Cable-7	1 GHz – 26.5 GHz	Nov. 15, 2014	Conducted (TH01-CB)
RF Cable-high	Woken	RG402	High Cable-8	1 GHz – 26.5 GHz	Nov. 15, 2014	Conducted (TH01-CB)
RF Cable-high	Woken	RG402	High Cable-9	1 GHz – 26.5 GHz	Nov. 15, 2014	Conducted (TH01-CB)
RF Cable-high	Woken	RG402	High Cable-10	1 GHz – 26.5 GHz	Nov. 15, 2014	Conducted (TH01-CB)
RF Cable-high	Woken	RG402	High Cable-6	1 GHz – 26.5 GHz	Nov. 15, 2014	Conducted (TH01-CB)
Power Sensor	Agilent	U2021XA	MY53410001	50MHz~18GHz	Nov. 03, 2014	Conducted (TH01-CB)

Note: Calibration Interval of instruments listed above is one year.

“*” Calibration Interval of instruments listed above is two years.

N.C.R. means Non-Calibration required.

6. MEASUREMENT UNCERTAINTY

Test Items	Uncertainty	Remark
Conducted Emission (150kHz ~ 30MHz)	3.2 dB	Confidence levels of 95%
Radiated Emission (30MHz ~ 1,000MHz)	3.6 dB	Confidence levels of 95%
Radiated Emission (1GHz ~ 18GHz)	3.7 dB	Confidence levels of 95%
Radiated Emission (18GHz ~ 40GHz)	3.5 dB	Confidence levels of 95%
Conducted Emission	1.7 dB	Confidence levels of 95%