



# SPORTON International Inc.

No. 52, Hwa Ya 1st Rd., Kwei-Shan Hsiang, TaoYuan Hsien, Taiwan, R.O.C.  
Ph: 886-3-327-3456 / FAX: 886-3-327-0973 / www.sporton.com.tw

## FCC RADIO TEST REPORT

Applicant's company	AboCom Systems, Inc
Applicant Address	No.77, Youyi Rd., Jhunan Township, Miaoli Country 350, Taiwan
FCC ID	MQ4WM5200
Manufacturer's company	AboCom Systems, Inc
Manufacturer Address	No.77, Youyi Rd., Chu Nan Chen, Miao Lih Hsien 350, Taiwan R.O.C.

Product Name	802.11n compliant 2.4GHz Mini-PCI Module
Brand Name	AboCom
Model Name	WM5200
Test Rule	47 CFR FCC Part 15 Subpart C § 15.247
Test Freq. Range	2400 ~ 2483.5MHz
Received Date	Oct. 15, 2007
Final Test Date	Mar. 27, 2008
Submission Type	Original Equipment
Class II Change	Please refer to section 3.7



### Statement

**Test result included is only for the Draft n part of the product.**

The test result in this report refers exclusively to the presented test model / sample.

Without written approval of SPORTON International Inc., the test report shall not be reproduced except in full.

The measurements and test results shown in this test report were made in accordance with the procedures and found in compliance with the limit given in **ANSI C63.4-2003** and **47 CFR FCC Part 15 Subpart C**.

The test equipment used to perform the test is calibrated and traceable to NML/ROC.



## Table of Contents

<b>1. CERTIFICATE OF COMPLIANCE .....</b>	<b>1</b>
<b>2. SUMMARY OF THE TEST RESULT .....</b>	<b>2</b>
<b>3. GENERAL INFORMATION .....</b>	<b>3</b>
3.1. Product Details.....	3
3.2. Accessories.....	4
3.3. Table for Filed Antenna.....	5
3.4. Table for Carrier Frequencies .....	5
3.5. Table for Test Modes.....	6
3.6. Table for Testing Locations.....	6
3.7. Table for Class II Change .....	7
3.8. Table for Supporting Units .....	7
3.9. Table for Parameters of Test Software Setting .....	8
3.10. Test Configurations .....	9
<b>4. TEST RESULT .....</b>	<b>11</b>
4.1. Maximum Conducted Output Power Measurement.....	11
4.2. Power Spectral Density Measurement .....	14
4.3. 6dB Spectrum Bandwidth Measurement .....	19
4.4. Radiated Emissions Measurement .....	24
4.5. Band Edge Emissions Measurement .....	42
4.6. Antenna Requirements .....	47
<b>5. LIST OF MEASURING EQUIPMENTS .....</b>	<b>48</b>
<b>6. TEST LOCATION.....</b>	<b>50</b>
<b>7. TAF CERTIFICATE OF ACCREDITATION .....</b>	<b>51</b>
<b>APPENDIX A. PHOTOGRAPHS OF EUT.....</b>	<b>A1 ~ A8</b>
<b>APPENDIX B. TEST PHOTOS.....</b>	<b>B1 ~ B6</b>
<b>APPENDIX C. MAXIMUM PERMISSIBLE EXPOSURE.....</b>	<b>C1 ~C3</b>



### History of This Test Report

Original Issue Date: Mar. 28, 2008

Report No.: FR7O0201-01AA

- No additional attachment.
- Additional attachment were issued as following record:

Attachment No.	Issue Date	Description



## 1. CERTIFICATE OF COMPLIANCE

Product Name : 802.11n compliant 2.4GHz Mini-PCI Module  
Brand Name : AboCom  
Model Name : WM5200  
Applicant : AboCom Systems, Inc  
Test Rule Part(s) : 47 CFR FCC Part 15 Subpart C § 15.247

Sporton International as requested by the applicant to evaluate the EMC performance of the product sample received on Oct. 15, 2007 would like to declare that the tested sample has been evaluated and found to be in compliance with the tested rule parts. The data recorded as well as the test configuration specified is true and accurate for showing the sample's EMC nature.

A handwritten signature in blue ink that reads 'Wayne Hsu 31.3.08'.

Wayne Hsu

SPORTON INTERNATIONAL INC.

## 2. SUMMARY OF THE TEST RESULT

Applied Standard: 47 CFR FCC Part 15 Subpart C				
Part	Rule Section	Description of Test	Result	Under Limit
-	15.207	AC Power Line Conducted Emissions	-	-
4.1	15.247(b)(3)	Maximum Peak Conducted Output Power	Complies	6.62 dB
4.2	15.247(e)	Power Spectral Density	Complies	16.42 dB
4.3	15.247(a)(2)	6dB Spectrum Bandwidth	Complies	-
4.4	15.247(d)	Radiated Emissions	Complies	3.07 dB
4.5	15.247(d)	Band Edge Emissions	Complies	0.85 dB
4.6	15.203	Antenna Requirements	Complies	-

Test Items	Uncertainty	Remark
AC Power Line Conducted Emissions	±2.3dB	Confidence levels of 95%
Maximum Peak Conducted Output Power	±0.8dB	Confidence levels of 95%
Power Spectral Density	±0.5dB	Confidence levels of 95%
6dB Spectrum Bandwidth	±8.5×10 <sup>-8</sup>	Confidence levels of 95%
Radiated Emissions (9kHz~30MHz)	±0.8dB	Confidence levels of 95%
Radiated Emissions (30MHz~1000MHz)	±1.9dB	Confidence levels of 95%
Radiated / Band Edge Emissions (1GHz~18GHz)	±1.9dB	Confidence levels of 95%
Radiated Emissions (18GHz~40GHz)	±1.9dB	Confidence levels of 95%
Temperature	±0.7°C	Confidence levels of 95%
Humidity	±3.2%	Confidence levels of 95%
DC / AC Power Source	±1.4%	Confidence levels of 95%

### 3. GENERAL INFORMATION

#### 3.1. Product Details

Items	Description
Product Type	WLAN (2TX, 3RX)
Radio Type	Intentional Transceiver
Power Type	From Host System
Modulation	see the below table for draft n
Data Modulation	OFDM (BPSK / QPSK / 16QAM / 64QAM)
Data Rate (Mbps)	see the below table for Draft n
Frequency Range	2400 ~ 2483.5MHz
Channel Number	11 for 20MHz bandwidth ; 7 for 40MHz bandwidth
Channel Band Width (99%)	MCS8 (20MHz) : 17.56 MHz MCS8 (40MHz) : 36.15 MHz
Conducted Output Power	MCS8 (20MHz) : 23.78 dBm MCS8 (40MHz) : 20.59 dBm
Carrier Frequencies	Please refer to section 3.4
Antenna	Please refer to section 3.3

#### Antenna & Band width

Antenna	Single (TX)		Two (TX)	
	20 MHz	40 MHz	20 MHz	40 MHz
802.11b	V	X	X	X
802.11g	V	X	X	X
Draft n	X	X	V	V

## Draft n spec

MCS Index	Nss	Modulation	R	NBPS	NCBPS		NDBPS		Data rate(Mbps)			
					800nsGI		20MHz	40MHz	20MHz	40MHz	20MHz	40MHz
					20MHz	40MHz						
0	1	BPSK	$\frac{1}{2}$	1	52	108	26	54	6.5	13.5		
1	1	QPSK	$\frac{1}{2}$	2	104	216	52	108	13.0	27.0		
2	1	QPSK	$\frac{3}{4}$	2	104	216	78	162	19.5	40.5		
3	1	16-QAM	$\frac{1}{2}$	4	208	432	104	216	26.0	54.0		
4	1	16-QAM	$\frac{3}{4}$	4	208	432	156	324	39.0	81.0		
5	1	64-QAM	$\frac{2}{3}$	6	312	648	208	432	52.0	108.0		
6	1	64-QAM	$\frac{3}{4}$	6	312	648	234	486	58.5	121.5		
7	1	64-QAM	$\frac{5}{6}$	6	312	648	260	540	65.0	135.0		
8	2	BPSK	$\frac{1}{2}$	1	104	216	52	108	13.0	27.0		
9	2	QPSK	$\frac{1}{2}$	2	208	432	104	216	26.0	54.0		
10	2	QPSK	$\frac{3}{4}$	2	208	432	156	324	39.0	81.0		
11	2	16-QAM	$\frac{1}{2}$	4	416	864	208	432	52.0	108.0		
12	2	16-QAM	$\frac{3}{4}$	4	416	864	312	648	78.0	162.0		
13	2	64-QAM	$\frac{2}{3}$	6	624	1296	416	864	104.0	216.0		
14	2	64-QAM	$\frac{3}{4}$	6	624	1296	468	972	117.0	243.0		
15	2	64-QAM	$\frac{5}{6}$	6	624	1296	520	1080	130.0	270.0		

Symbol	Explanation
NSS	Number of spatial streams
R	Code rate
NBPS	Number of coded bits per single carrier
NCBPS	Number of coded bits per symbol
NDBPS	Number of data bits per symbol
GI	guard interval

### 3.2. Accessories

N/A

### 3.3. Table for Filed Antenna

Ant.	Brand	Model Name	Antenna Type	Connector	Gain (dBi)	Remark
A	Cortec	AN2400-0310RS	Dipole Antenna	Reversed-SMA	3	TX / RX Ant.
B	Cortec	AN2400-0310RS	Dipole Antenna	Reversed-SMA	3	TX / RX Ant.
C	Cortec	AN2400-0310RS	Dipole Antenna	Reversed-SMA	3	RX Ant.

Note: The EUT has three antennas.

Both antenna A and B can be used as transmitting antenna.

Antenna A, B, C is used as the receiving antenna.

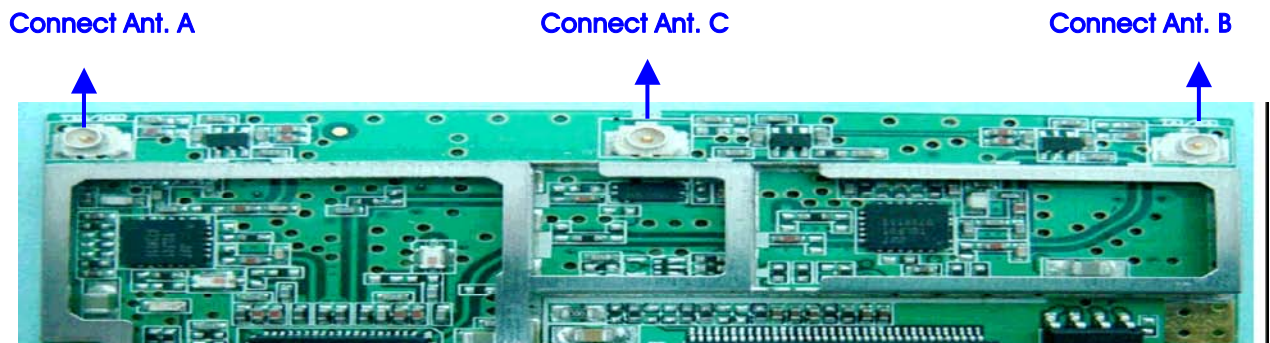

### 3.4. Table for Carrier Frequencies

There are two bandwidth systems for draft n.

For both 20MHz bandwidth systems, use Channel 1~Channel 11.

For both 40MHz bandwidth systems, use Channel 3~Channel 9.

Frequency Band	Channel No.	Frequency	Channel No.	Frequency
2400~2483.5MHz	1	2412 MHz	7	2442 MHz
	2	2417 MHz	8	2447 MHz
	3	2422 MHz	9	2452 MHz
	4	2427 MHz	10	2457 MHz
	5	2432 MHz	11	2462 MHz
	6	2437 MHz		



### 3.5. Table for Test Modes

Preliminary tests were performed in different data rate to find the worst radiated emission. The data rate shown in the table below is the worst-case rate with respect to the specific test item. Investigation has been done on all the possible configurations for searching the worst cases. The following table is a list of the test modes shown in this test report.

Test Items	Mode	Data Rate	Channel	Antenna
AC Power Line Conducted Emissions	Normal Link	Auto	6	A+B
Maximum Peak Conducted Output Power	MCS8/20MHz	13 Mbps	1/6/11	A / B / A+B
	MCS8/40MHz	27 Mbps	3/6/9	A / B / A+B
Power Spectral Density 6dB Spectrum Bandwidth	MCS8/20MHz	13 Mbps	1/6/11	A+B
	MCS8/40MHz	27 Mbps	3/6/9	A+B
Radiated Emissions 9kHz~1GHz	Normal Link	Auto	6	A+B
Radiated Emissions 1GHz~10 <sup>th</sup> Harmonic	MCS8/20MHz	13 Mbps	1/6/11	A+B
	MCS8/40MHz	27 Mbps	3/6/9	A+B
Band Edge Emissions	MCS8/20MHz	13 Mbps	1/11	A+B
	MCS8/40MHz	27 Mbps	3/9	A+B

### 3.6. Table for Testing Locations

Test Site No.	Site Category	Location	FCC Reg. No.	IC File No.	VCCI Reg. No
03CH03-HY	SAC	Hwa Ya	101377	IC 4088	-
CO04-HY	Conduction	Hwa Ya	101377	IC 4088	-
TH01-HY	OVEN Room	Hwa Ya	-	-	-

Open Area Test Site (OATS); Semi Anechoic Chamber (SAC); Fully Anechoic Chamber (FAC).

Please refer section 6 for Test Site Address.

### 3.7. Table for Class II Change

This product is an extension of original one reported under Sporton project number: FR7O0201

Below is the table for the change of the product with respect to the original one.

Modifications	Description	Performance Checking
Change antenna	Old antenna (For old report) Brand: WHA YU Antenna gain: 1.8dBi Model Name: C068-510286-A Antenna Color: Black New antenna (For new report) Brand: Cortec Antenna gain: 3dBi Model Name: AN2400-0310RS Antenna Color: White	Additional test: Maximum Peak Output Power Measurement Power Spectral Density Measurement 6dB Spectrum Bandwidth Measurement Radiated Emissions Measurement Band Edge Emissions Measurement

### 3.8. Table for Supporting Units

Support Unit	Brand	Model	FCC ID
Notebook	DELL	D400	E2K24GBRL
Mouse	QSKY	Lx-619B	DoC
Modem	ACEEX	DM1414	IFAXDM1414
Printer	EPSON	LQ-300+	N/A
AP	PLANEX	GW-AP54SGX	DOC

### 3.9. Table for Parameters of Test Software Setting

During testing, Channel & Power Controlling Software provided by the customer was used to control the operating channel as well as the output power level. The RF output power selection is for the setting of RF output power expected by the customer and is going to be fixed on the firmware of the final end product.

#### Power Parameters of Draft n MCS8 20MHz

Test Software Version	ART		
Frequency	2412 MHz	2437 MHz	2462 MHz
Draft n Ant. A + Ant. B	03/18	07/10	02/0A

#### Power Parameters of Draft n MCS8 40MHz

Test Software Version	ART		
Frequency	2422 MHz	2437 MHz	2452 MHz
Draft n Ant. A + Ant. B	09/16	0D/14	0D/12

An executive program, EMCTEST.EXE under WIN XP, which generates a complete line of continuously repeating " H " pattern was used as the test software.

The program was executed as follows:

- a. Turn on the power of all equipment.
- b. The PC sends " H " messages to the monitor, and the monitor displays " H " patterns on the screen.
- c. The PC sends " H " messages to the printer, then the printer prints them on the paper.
- d. The PC sends " H " messages to the modem.
- e. Repeat the steps from b to d.

At the same time, the following programs were executed:

Executed "ART" to control the EUT continuously transmit RF signal.

Executed "ping.exe" to link with the remote workstation to receive and transmit signal by WLAN.

### 3.10. Test Configurations

#### 3.10.1. Radiation Emissions Test Configuration

Test Configuration: 9kHz~1GHz

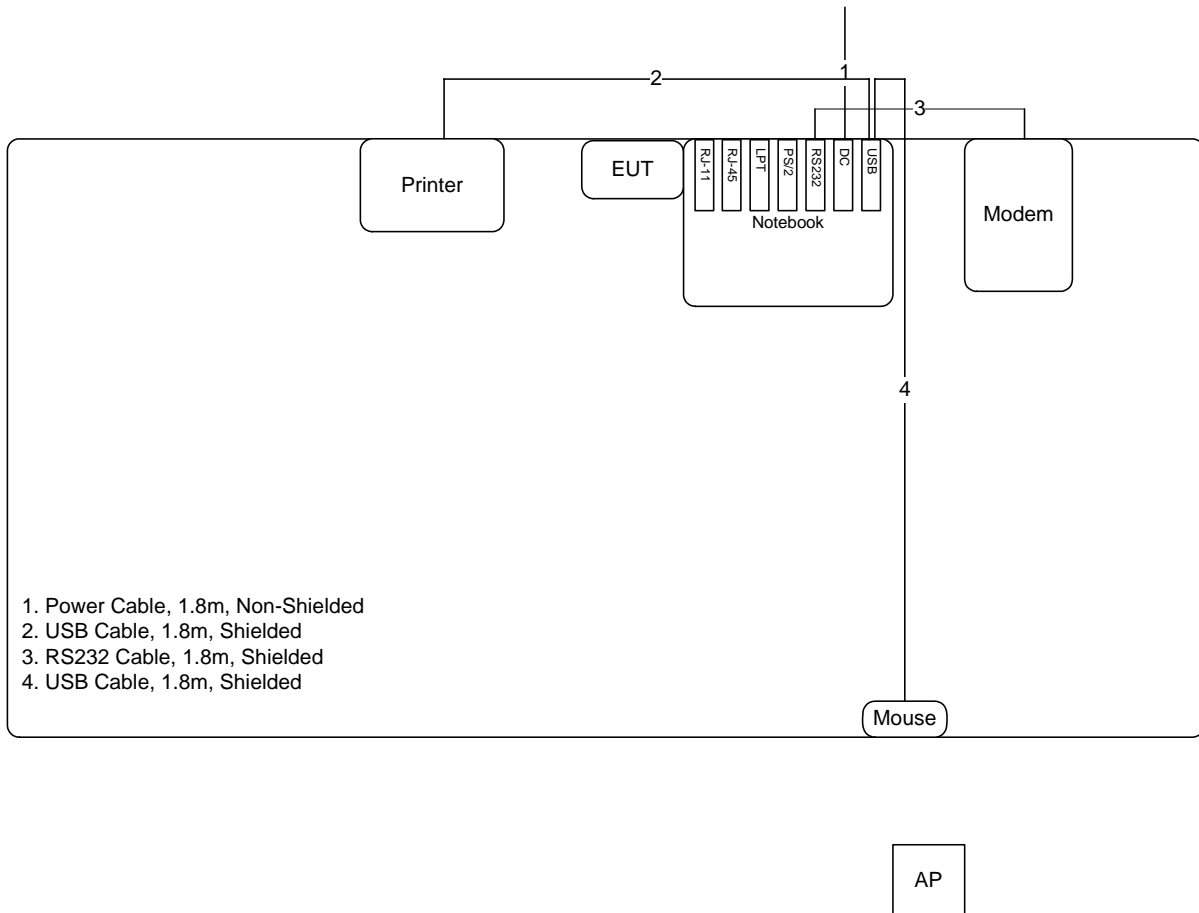

Test Configuration: above 1GHz

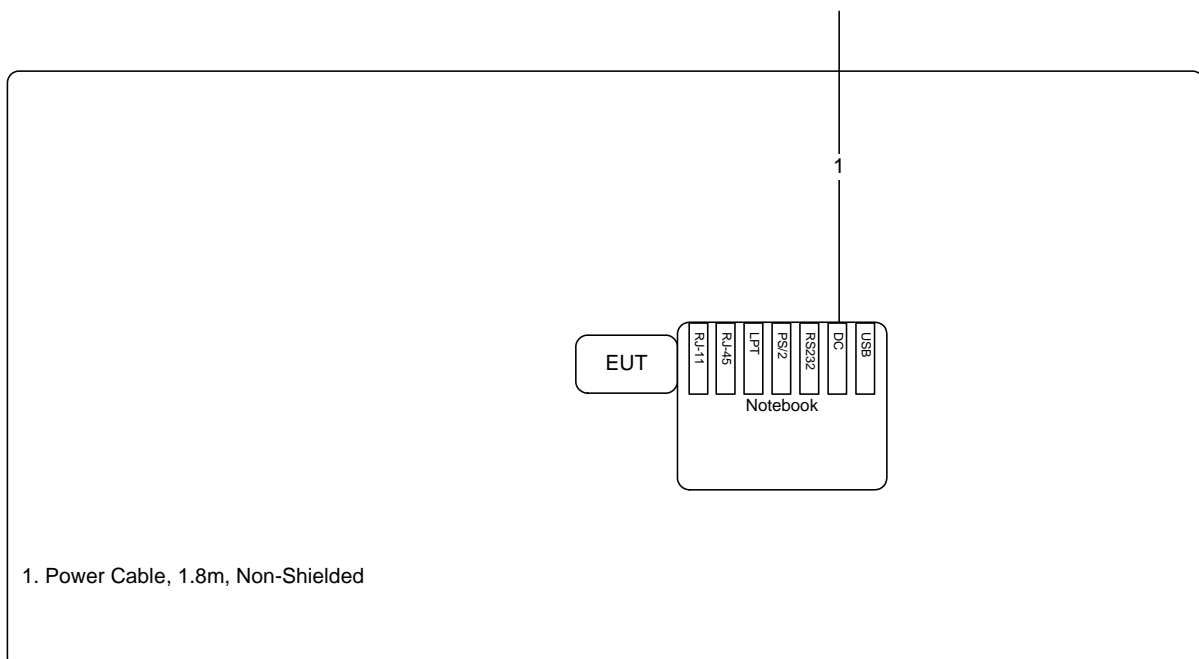

### 3.10.2. AC Power Line Conduction Emissions Test Configuration

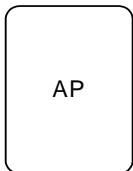
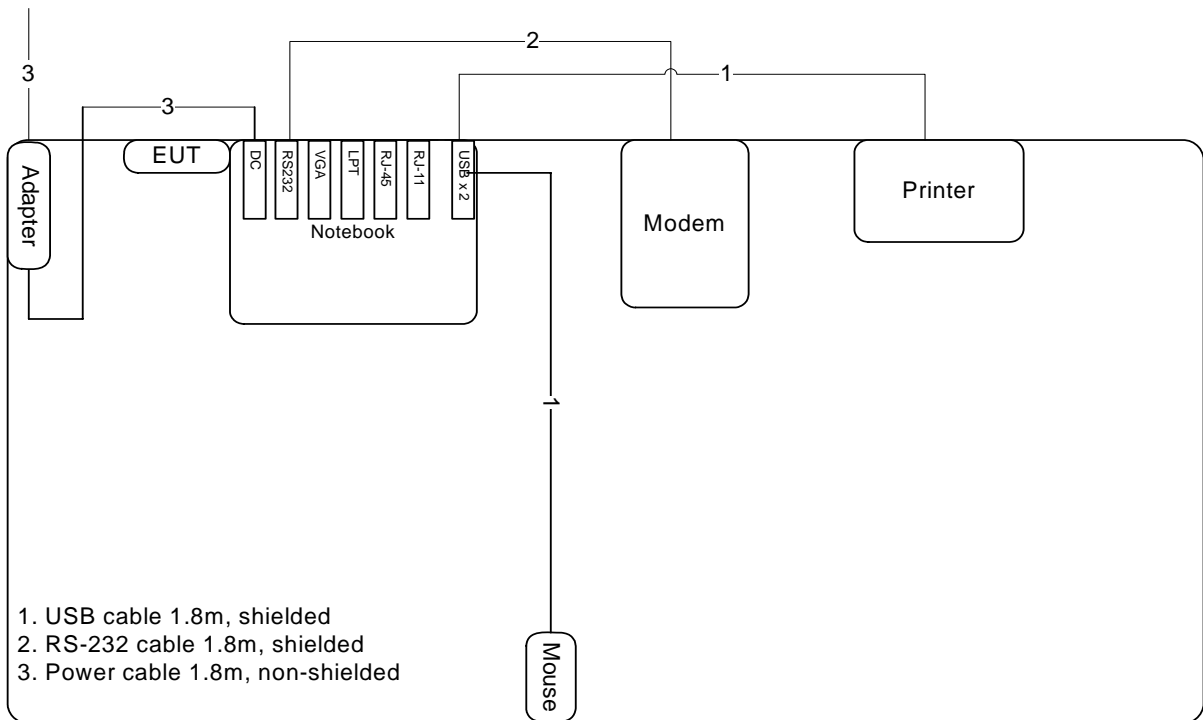

## 4. TEST RESULT

### 4.1. Maximum Conducted Output Power Measurement

#### 4.1.1. Limit

For systems using digital modulation in the 2400-2483.5MHz, the limit for peak output power is 30dBm. The limited has to be reduced by the amount in dB that the gain of the antenna exceed 6dBi. In case of point-to-point operation, the limit has to be reduced by 1dB for every 3dB that the directional gain of the antenna exceeds 6dBi.

#### 4.1.2. Measuring Instruments and Setting

Please refer to section 5 of equipments list in this report. The following table is the setting of the power meter.

Power Meter Parameter	Setting
Filter No.	Auto
Measurement time	0.135 s ~ 26 s
Used Peak Sensor	NRV-Z32 (model 04)

#### 4.1.3. Test Procedures

1. The transmitter output (antenna port) was connected to the power meter.
2. Turn on the EUT and power meter and then record the peak power value.
3. Repeat above procedures on all channels needed to be tested.

#### 4.1.4. Test Setup Layout

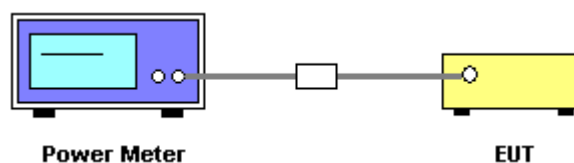

#### 4.1.5. Test Deviation

There is no deviation with the original standard.

#### 4.1.6. EUT Operation during Test

The EUT was programmed to be in continuously transmitting mode.

#### 4.1.7. Test Result of Maximum Peak Output Power

<b>Temperature</b>	22°C	<b>Humidity</b>	61%
<b>Test Engineer</b>	Sam Chen	<b>Configurations</b>	Draft n

##### Configuration Draft n MCS0 20MHz Ant. A

Channel	Frequency	Conducted Power (dBm)	Max. Limit (dBm)	Result
1	2412 MHz	19.73	30.00	Complies
6	2437 MHz	19.68	30.00	Complies
11	2462 MHz	15.79	30.00	Complies

##### Configuration Draft n MCS0 20MHz Ant. B

Channel	Frequency	Conducted Power (dBm)	Max. Limit (dBm)	Result
1	2412 MHz	21.61	30.00	Complies
6	2437 MHz	20.72	30.00	Complies
11	2462 MHz	18.26	30.00	Complies

##### Configuration Draft n MCS8 20MHz Ant. A + Ant. B

Channel	Frequency	Conducted Power (dBm)	Max. Limit (dBm)	Result
1	2412 MHz	23.78	30.00	Complies
6	2437 MHz	23.24	30.00	Complies
11	2462 MHz	20.21	30.00	Complies

**Configuration Draft n MCS0 40MHz Ant. A**

Channel	Frequency	Conducted Power (dBm)	Max. Limit (dBm)	Result
3	2422 MHz	16.31	30.00	Complies
6	2437 MHz	17.43	30.00	Complies
9	2452 MHz	16.39	30.00	Complies

**Configuration Draft n MCS0 40MHz Ant. B**

Channel	Frequency	Conducted Power (dBm)	Max. Limit (dBm)	Result
3	2422 MHz	17.62	30.00	Complies
6	2437 MHz	17.73	30.00	Complies
9	2452 MHz	17.38	30.00	Complies

**Configuration Draft n MCS8 40MHz Ant. A + Ant. B**

Channel	Frequency	Conducted Power (dBm)	Max. Limit (dBm)	Result
3	2422 MHz	20.02	30.00	Complies
6	2437 MHz	20.59	30.00	Complies
9	2452 MHz	19.92	30.00	Complies



## 4.2. Power Spectral Density Measurement

### 4.2.1. Limit

For digitally modulated systems, the power spectral density conducted from the intentional radiator to the antenna shall not be greater than 8 dBm in any 3 kHz band during any time interval of continuous transmission.

### 4.2.2. Measuring Instruments and Setting

Please refer to section 5 of equipments list in this report. The following table is the setting of Spectrum Analyzer.

Spectrum Parameter	Setting
Attenuation	Auto
Span Frequency	1.5MHz
RB	3 kHz
VB	30 kHz
Detector	Peak
Trace	Max Hold
Sweep Time	500s

### 4.2.3. Test Procedures

1. The transmitter output (antenna port) was connected to the spectrum analyser.
2. Set RBW of spectrum analyzer to 3kHz and VBW to 30kHz. Set Detector to Peak, Trace to Max Hold.
3. Mark the frequency with maximum peak power as the center of the display of the spectrum.
4. Set the span to 1.5MHz and the sweep time to 500s and record the maximum peak value.

### 4.2.4. Test Setup Layout

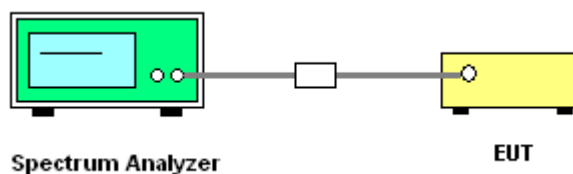

### 4.2.5. Test Deviation

There is no deviation with the original standard.

#### 4.2.6. EUT Operation during Test

The EUT was programmed to be in continuously transmitting mode.

#### 4.2.7. Test Result of Power Spectral Density

<b>Temperature</b>	22°C	<b>Humidity</b>	61%
<b>Test Engineer</b>	Sam Chen	<b>Configurations</b>	Draft n

##### Configuration Draft n MCS8 20MHz Ant. A + Ant. B

Channel	Frequency	Power Density (dBm)	Max. Limit (dBm)	Result
1	2412 MHz	-9.88	8.00	Complies
6	2437 MHz	-11.67	8.00	Complies
11	2462 MHz	-14.50	8.00	Complies

##### Configuration Draft n MCS8 40MHz Ant. A + Ant. B

Channel	Frequency	Power Density (dBm)	Max. Limit (dBm)	Result
3	2422 MHz	-15.12	8.00	Complies
6	2437 MHz	-8.42	8.00	Complies
9	2452 MHz	-14.89	8.00	Complies

### Power Density Plot on Configuration Drafft n MCS8 20MHz Ant. A + Ant. B / 2412 MHz

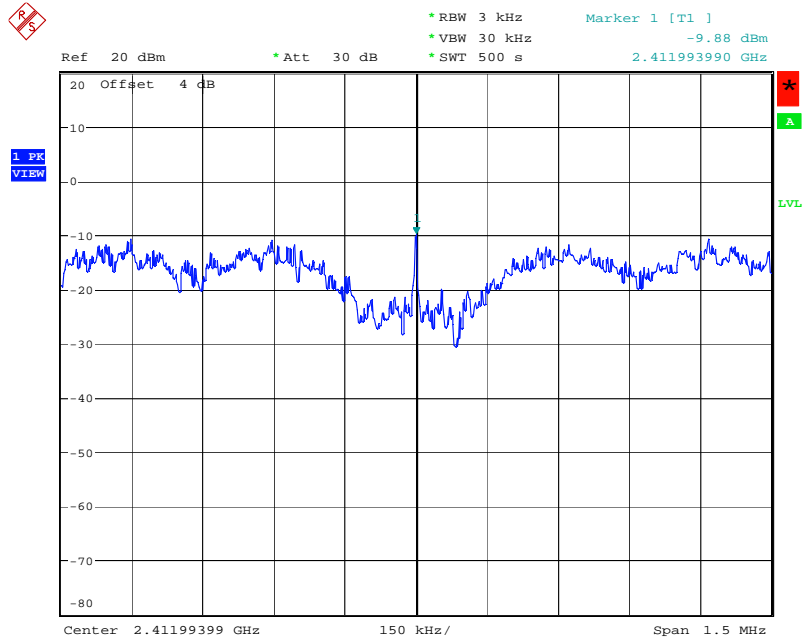

Date: 27.MAR.2008 09:37:17

### Power Density Plot on Configuration Drafft n MCS8 20MHz Ant. A + Ant. B / 2437 MHz

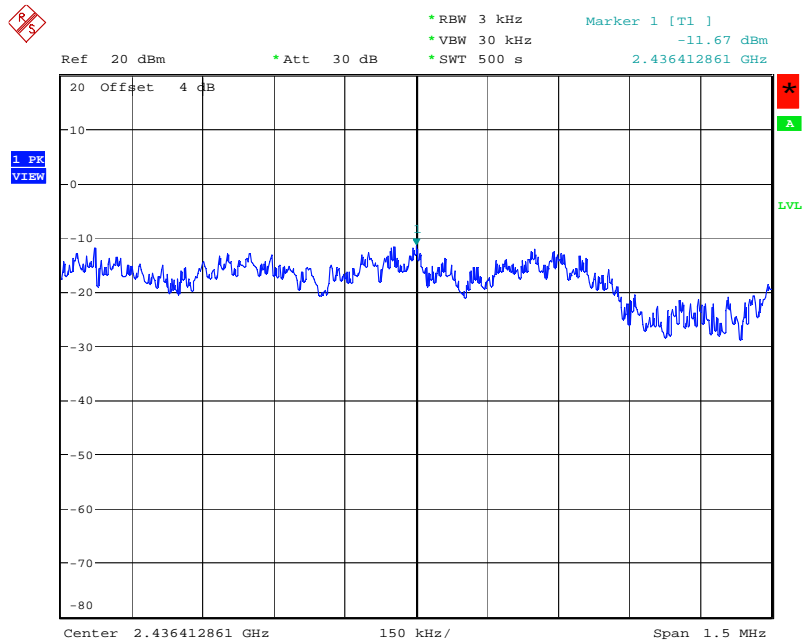

Date: 27.MAR.2008 09:38:21

**Power Density Plot on Configuration Drafft n MCS8 20MHz Ant. A + Ant. B / 2462 MHz**

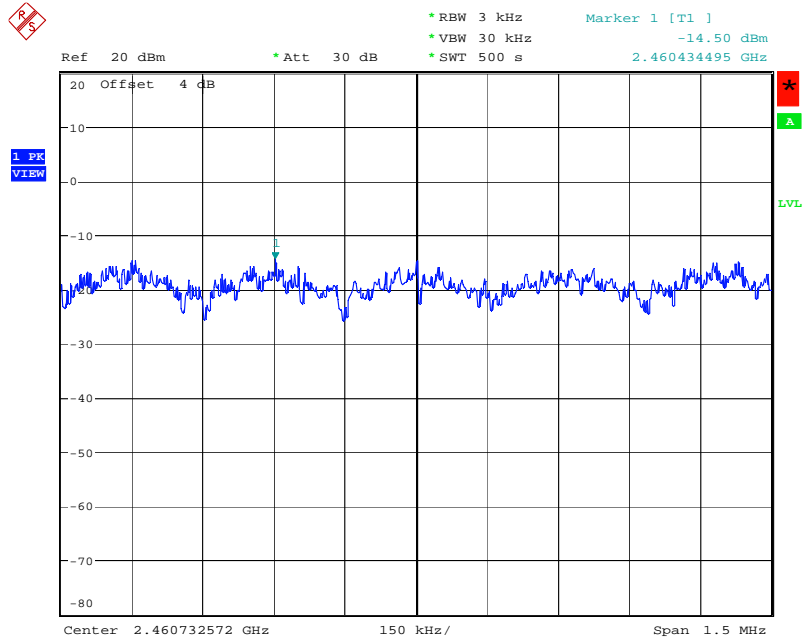

Date: 27.MAR.2008 09:39:20

**Power Density Plot on Configuration Drafft n MCS8 40MHz Ant. A + Ant. B / 2422 MHz**

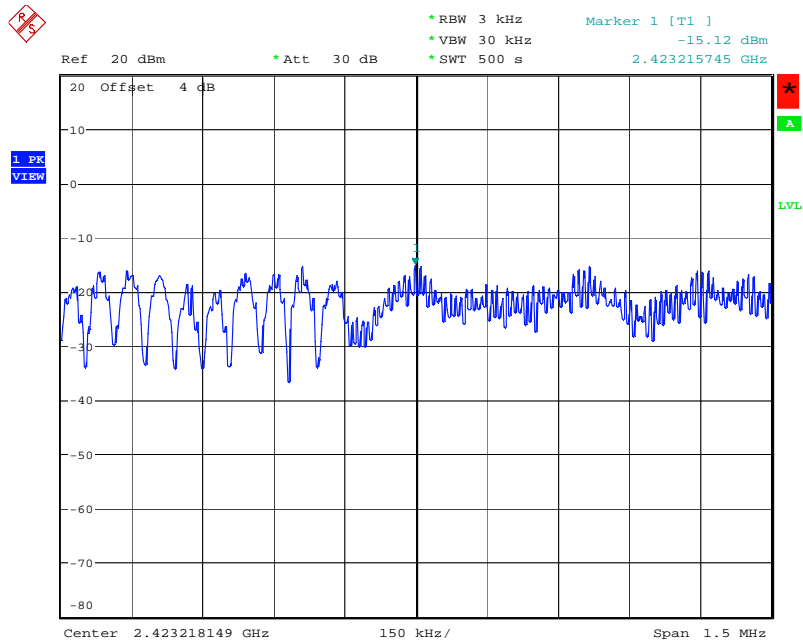

Date: 27.MAR.2008 09:41:14

**Power Density Plot on Configuration Drafft n MCS8 40MHz Ant. A + Ant. B / 2437 MHz**

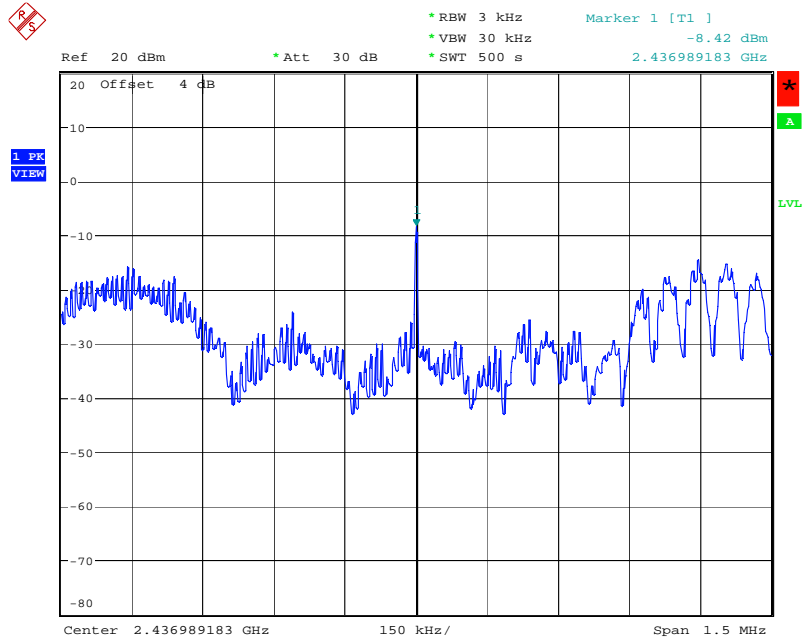

Date: 27.MAR.2008 09:42:33

**Power Density Plot on Configuration Drafft n MCS8 40MHz Ant. A + Ant. B / 2452 MHz**

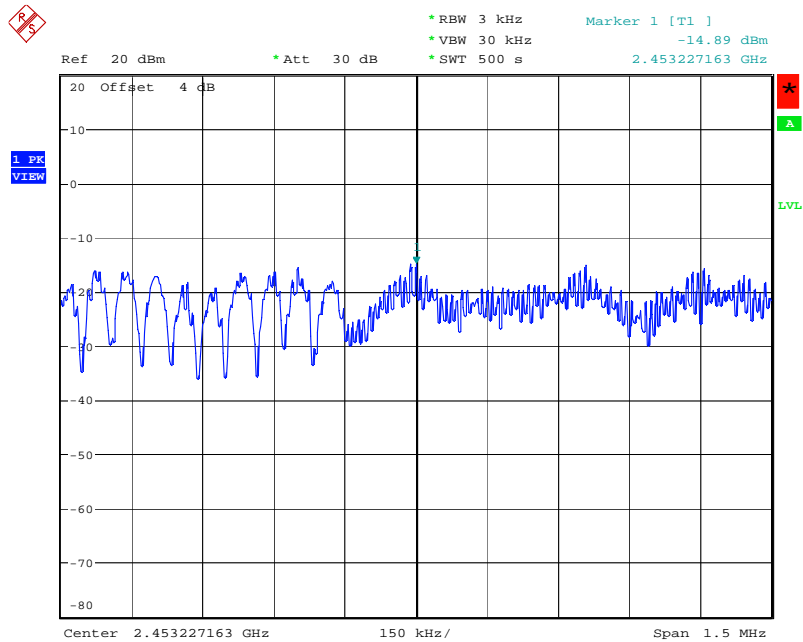

Date: 27.MAR.2008 09:43:34

### 4.3. 6dB Spectrum Bandwidth Measurement

#### 4.3.1. Limit

For digital modulation systems, the minimum 6 dB bandwidth shall be at least 500 kHz.

#### 4.3.2. Measuring Instruments and Setting

Please refer to section 5 of equipments list in this report. The following table is the setting of the Spectrum Analyzer.

Spectrum Parameters	Setting
Attenuation	Auto
Span Frequency	> 6dB Bandwidth
RB	100 kHz
VB	100 kHz
Detector	Peak
Trace	Max Hold
Sweep Time	Auto

#### 4.3.3. Test Procedures

4. The transmitter output (antenna port) was connected to the spectrum analyser in peak hold mode.
5. The resolution bandwidth of 100 kHz and the video bandwidth of 100 kHz were used.
6. Measured the spectrum width with power higher than 6dB below carrier.

#### 4.3.4. Test Setup Layout

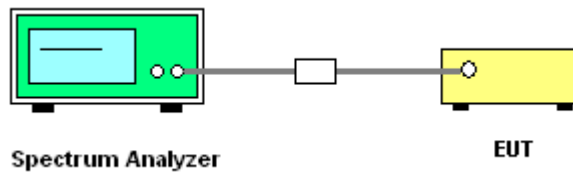

#### 4.3.5. Test Deviation

There is no deviation with the original standard.

#### 4.3.6. EUT Operation during Test

The EUT was programmed to be in continuously transmitting mode.

## 4.3.7. Test Result of 6dB Spectrum Bandwidth

<b>Temperature</b>	22°C	<b>Humidity</b>	61%
<b>Test Engineer</b>	Sam Chen	<b>Configurations</b>	Draft n

## Configuration Draft n MCS8 20MHz Ant. A + Ant. B

Channel	Frequency	6dB Bandwidth (MHz)	99% Occupied Bandwidth (MHz)	Min. Limit (kHz)	Test Result
1	2412 MHz	17.62	17.56	500	Complies
6	2437 MHz	17.62	17.56	500	Complies
11	2462 MHz	17.59	17.56	500	Complies

## Configuration Draft n MCS8 40MHz Ant. A + Ant. B

Channel	Frequency	6dB Bandwidth (MHz)	99% Occupied Bandwidth (MHz)	Min. Limit (kHz)	Test Result
3	2422 MHz	36.41	36.15	500	Complies
6	2437 MHz	36.41	36.08	500	Complies
9	2452 MHz	36.41	36.15	500	Complies

6 dB Bandwidth Plot on Configuration Draft n MCS8 20MHz Ant. A + Ant. B / 2412 MHz

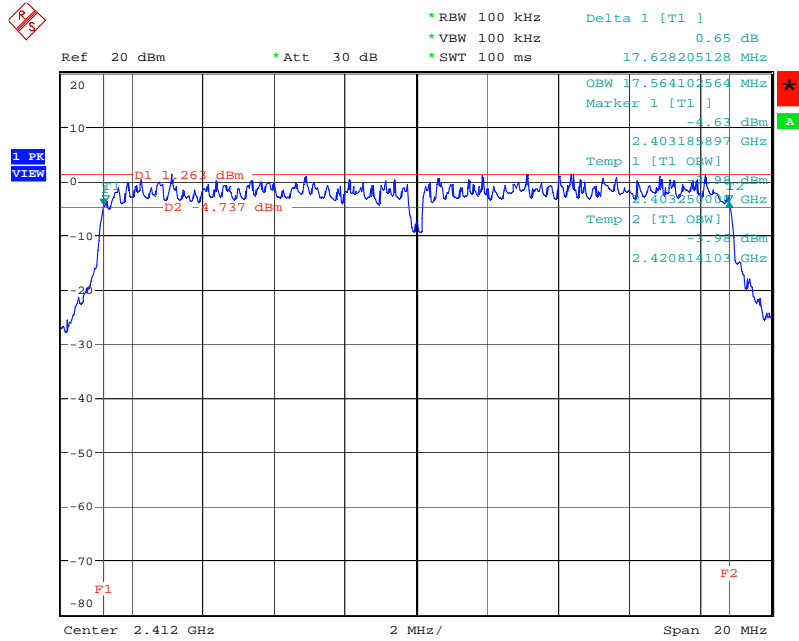

Date: 27.MAR.2008 09:36:51

6 dB Bandwidth Plot on Configuration Draft n MCS8 20MHz Ant. A + Ant. B / 2437 MHz

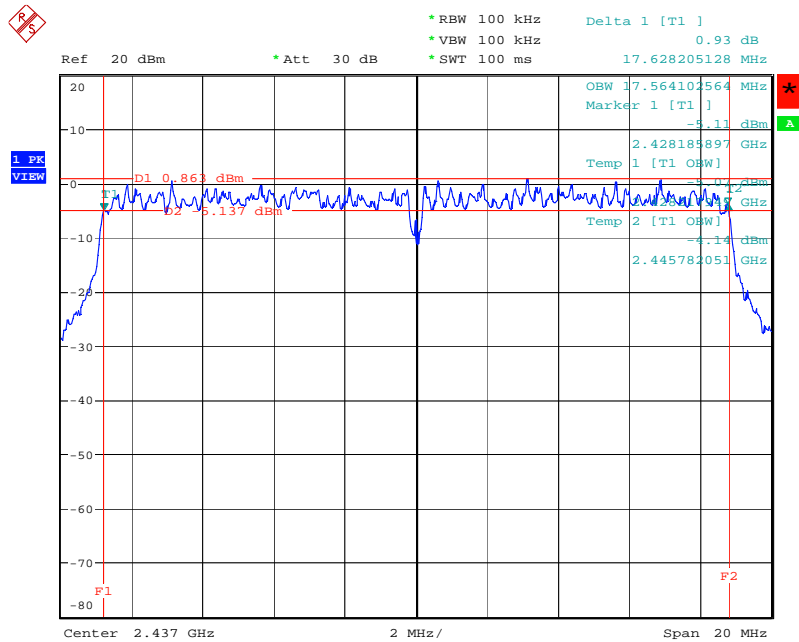

Date: 27.MAR.2008 09:38:04



6 dB Bandwidth Plot on Configuration Draft n MCS8 20MHz Ant. A + Ant. B / 2462 MHz

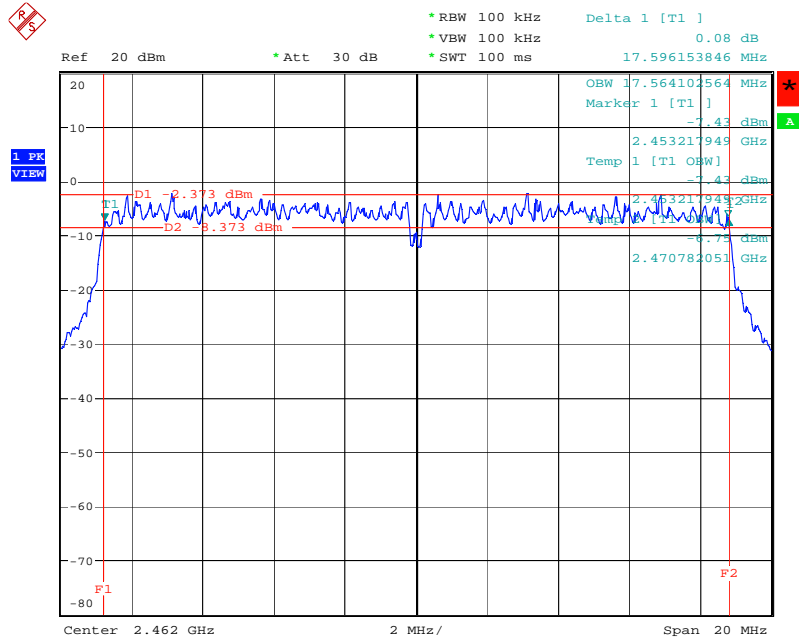

Date: 27.MAR.2008 09:39:04

6 dB Bandwidth Plot on Configuration Draft n MCS8 40MHz Ant. A + Ant. B / 2422 MHz

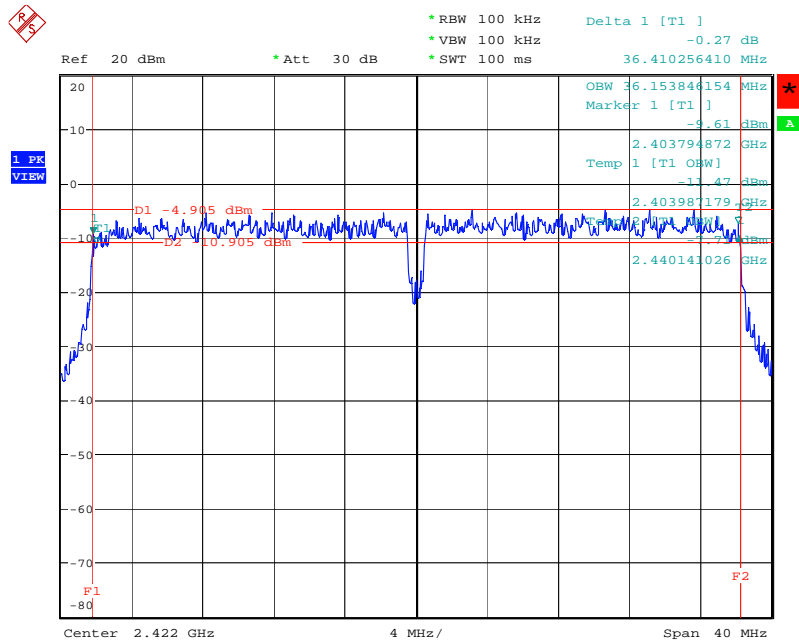

Date: 27.MAR.2008 09:40:48

6 dB Bandwidth Plot on Configuration Draft n MCS8 40MHz Ant. A + Ant. B / 2437 MHz

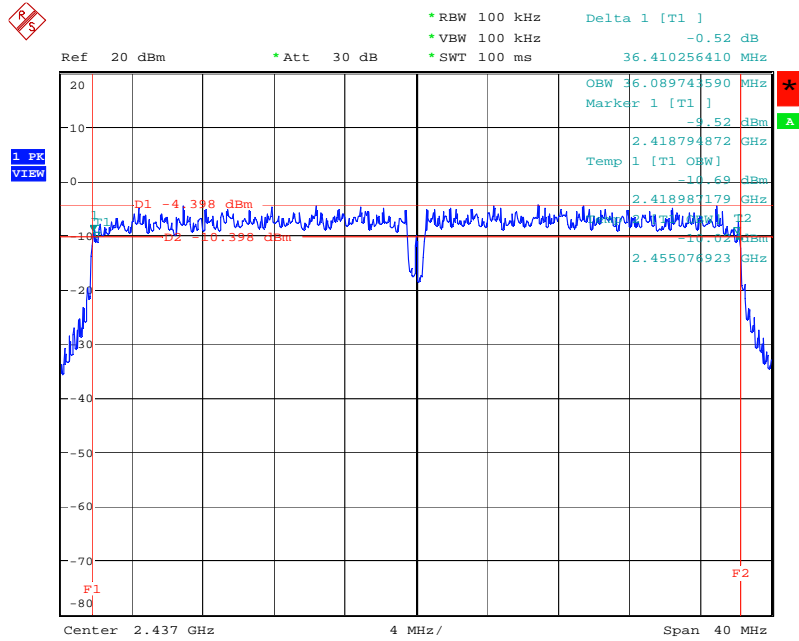

Date: 27.MAR.2008 09:42:06

6 dB Bandwidth Plot on Configuration Draft n MCS8 40MHz Ant. A + Ant. B / 2452 MHz

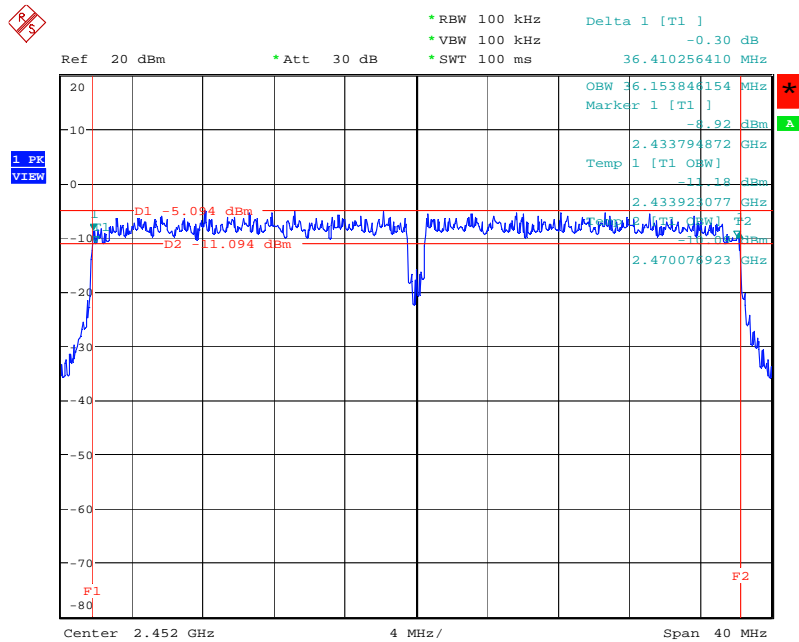

Date: 27.MAR.2008 09:43:09

## 4.4. Radiated Emissions Measurement

### 4.4.1. Limit

20dBc in any 100 kHz bandwidth outside the operating frequency band. In case the emission fall within the restricted band specified on 15.205(a), then the 15.209(a) limit in the table below has to be followed.

Frequencies (MHz)	Field Strength (micorvolts/meter)	Measurement Distance (meters)
0.009~0.490	2400/F(KHz)	300
0.490~1.705	24000/F(KHz)	30
1.705~30.0	30	30
30~88	100	3
88~216	150	3
216~960	200	3
Above 960	500	3

### 4.4.2. Measuring Instruments and Setting

Please refer to section 5 of equipments list in this report. The following table is the setting of spectrum analyzer and receiver.

Spectrum Parameter	Setting
Attenuation	Auto
Start Frequency	1000 MHz
Stop Frequency	10th carrier harmonic
RB / VB (Emission in restricted band)	1MHz / 1MHz for Peak, 1 MHz / 10Hz for Average
RB / VB (Emission in non-restricted band)	1000KHz / 1000KHz for peak

Receiver Parameter	Setting
Attenuation	Auto
Start ~ Stop Frequency	9kHz~150kHz / RB 200Hz for QP
Start ~ Stop Frequency	150kHz~30MHz / RB 9kHz for QP
Start ~ Stop Frequency	30MHz~1000MHz / RB 120kHz for QP

#### 4.4.3. Test Procedures

1. Configure the EUT according to ANSI C63.4. The EUT was placed on the top of the turntable 0.8 meter above ground. The phase center of the receiving antenna mounted on the top of a height-variable antenna tower was placed 3 meters far away from the turntable.
2. Power on the EUT and all the supporting units. The turntable was rotated by 360 degrees to determine the position of the highest radiation.
3. The height of the broadband receiving antenna was varied between one meter and four meters above ground to find the maximum emissions field strength of both horizontal and vertical polarization.
4. For each suspected emissions, the antenna tower was scan (from 1 m to 4 m) and then the turntable was rotated (from 0 degree to 360 degrees) to find the maximum reading.
5. Set the test-receiver system to Peak or CISPR quasi-peak Detect Function with specified bandwidth under Maximum Hold Mode.
6. For emissions above 1GHz, use 1MHz VBW and RBW for peak reading. Then 1MHz RBW and 10Hz VBW for average reading in spectrum analyzer.
7. When the radiated emissions limits are expressed in terms of the average value of the emissions, and pulsed operation is employed, the measurement field strength shall be determined by averaging over one complete pulse train, including blanking intervals, as long as the pulse train does not exceed 0.1 seconds. As an alternative (provided the transmitter operates for longer than 0.1 seconds) or in cases where the pulse train exceeds 0.1 seconds, the measured field strength shall be determined from the average absolute voltage during a 0.1 second interval during which the field strength is at its maximum value.
8. If the emissions level of the EUT in peak mode was 3 dB lower than the average limit specified, then testing will be stopped and peak values of EUT will be reported, otherwise, the emissions which do not have 3 dB margin will be repeated one by one using the quasi-peak method for below 1GHz.
9. For testing above 1GHz, the emissions level of the EUT in peak mode was lower than average limit (that means the emissions level in peak mode also complies with the limit in average mode), then testing will be stopped and peak values of EUT will be reported, otherwise, the emissions will be measured in average mode again and reported.
10. In case the emission is lower than 30MHz, loop antenna has to be used for measurement and the recorded data should be QP measured by receiver. High – Low scan is not required in this case.

#### 4.4.4. Test Setup Layout

For radiated emissions below 30MHz

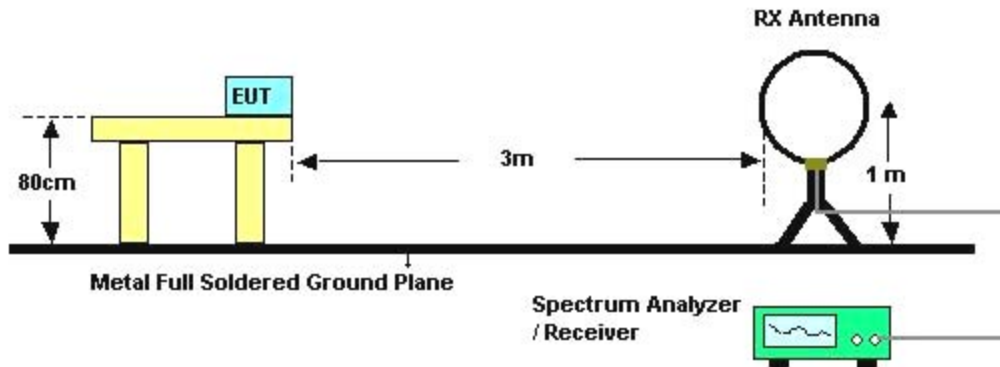

For radiated emissions above 30MHz

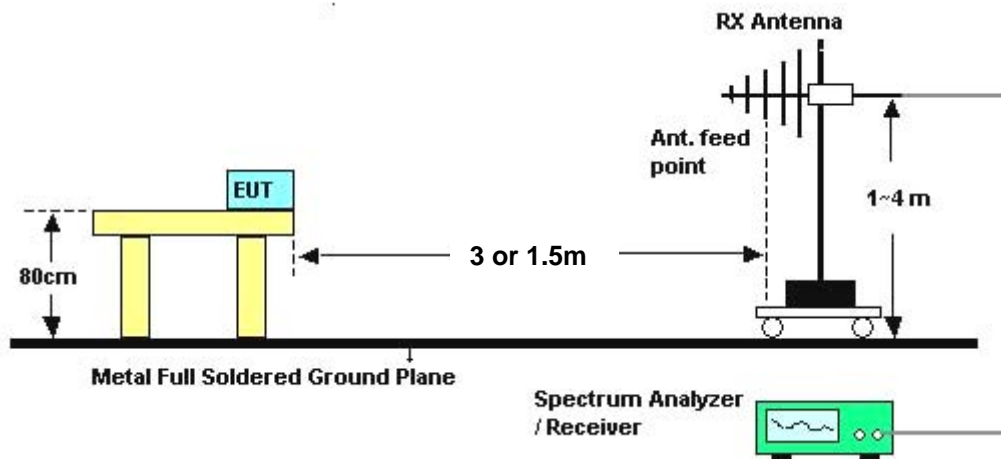

Above 10 GHz shall be extrapolated to the specified distance using an extrapolation factor of 20 dB/decade from 3m to 1.5m.

Distance extrapolation factor =  $20 \log (\text{specific distance [3m]} / \text{test distance [1.5m]})$  (dB);

Limit line = specific limits (dBuV) + distance extrapolation factor [6 dB].

#### 4.4.5. Test Deviation

There is no deviation with the original standard.

#### 4.4.6. EUT Operation during Test

The EUT was programmed to be in continuously transmitting mode.

#### 4.4.7. Results of Radiated Emissions (9kHz~30MHz)

<b>Temperature</b>	24.3°C	<b>Humidity</b>	56%
<b>Test Engineer</b>	Roy Huang	<b>Configurations</b>	Normal Link

Freq. (MHz)	Level (dBuV)	Over Limit (dB)	Limit Line (dBuV)	Remark
-	-	-	-	See Note

Note:

The amplitude of spurious emissions which are attenuated by more than 20 dB below the permissible value has no need to be reported.

Distance extrapolation factor =  $40 \log(\text{specific distance} / \text{test distance})$  (dB);

Limit line = specific limits (dBuV) + distance extrapolation factor.

4.4.8. Results of Radiated Emissions (30MHz~1GHz)

Temperature	24.3°C	Humidity	56%
Test Engineer	Roy Huang	Configurations	Normal Link

Horizontal

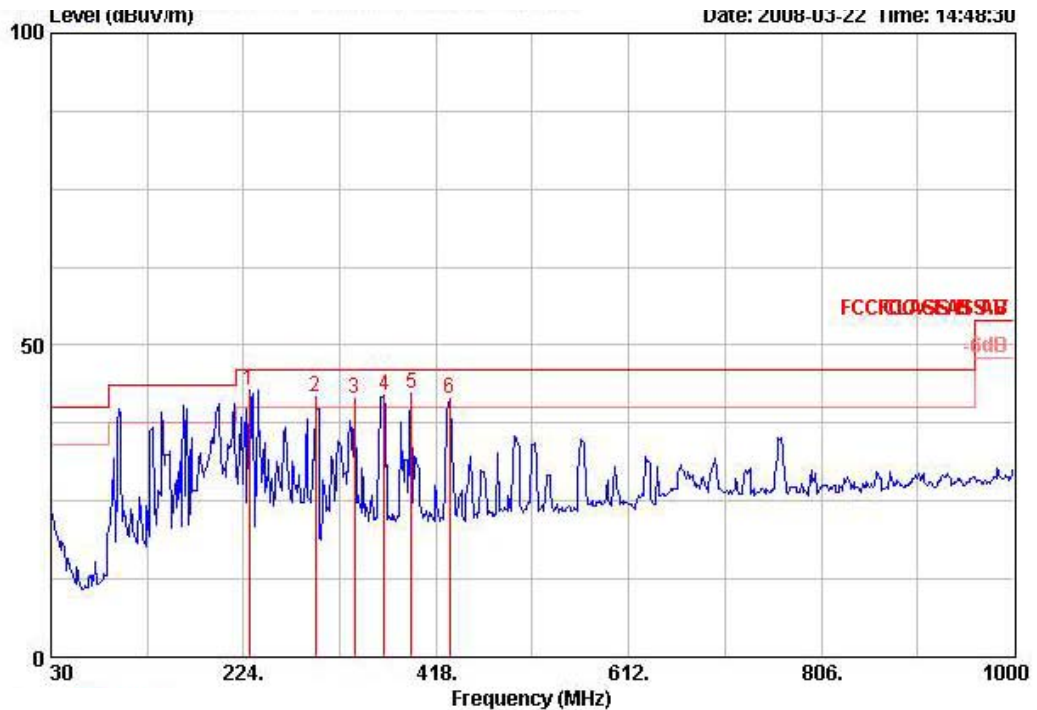

	Freq	Level	Over Limit	Limit Line	Read Level	Antenna Factor	Cable Loss	Preamp	Remark	Ant Pos	Table Pos	Pol/Phase
	MHz	dBuV/m	dB	dBuV/m	dBuV	dB/m	dB	dB		cm	deg	
1 @	229.820	42.91	-3.09	46.00	56.00	11.27	1.07	25.44	Peak	100	0	HORIZONTAL
2 @	296.750	41.65	-4.35	46.00	52.15	13.33	1.14	24.97	Peak	100	0	HORIZONTAL
3 @	335.550	41.41	-4.59	46.00	50.91	14.33	1.15	24.98	Peak	100	0	HORIZONTAL
4 @	365.620	41.90	-4.10	46.00	50.62	15.14	1.30	25.16	Peak	100	0	HORIZONTAL
5 @	392.780	42.26	-3.74	46.00	50.30	15.88	1.55	25.46	Peak	100	0	HORIZONTAL
6 @	431.580	41.51	-4.49	46.00	49.25	16.56	1.49	25.79	Peak	100	0	HORIZONTAL

**Vertical**

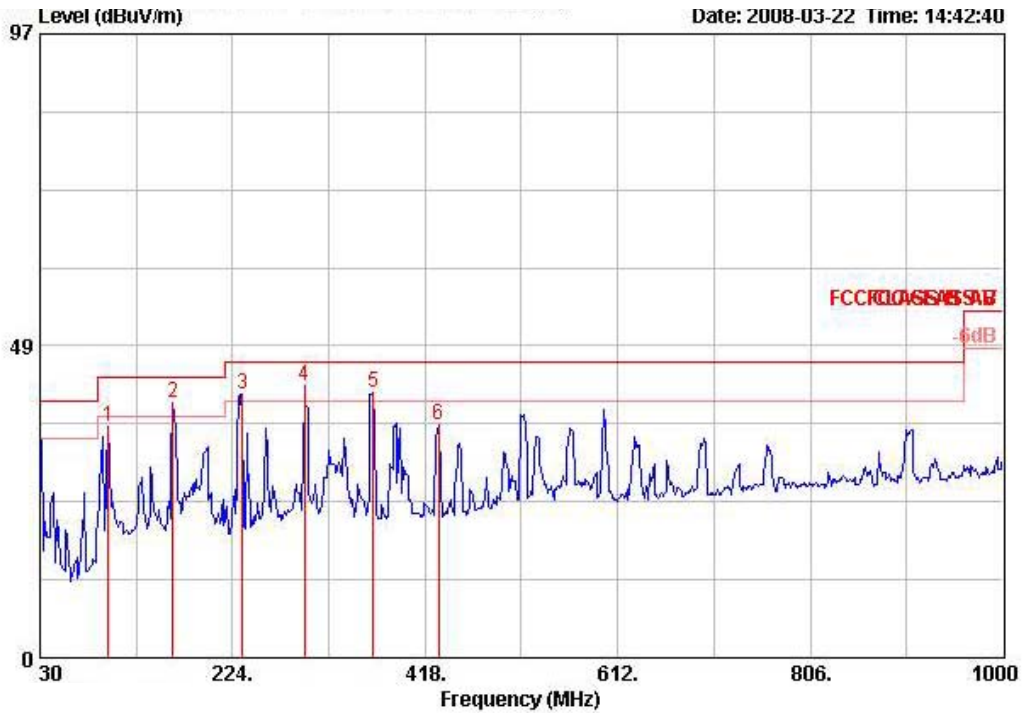

	Freq	Level	Over Limit	Limit Line	Read Level	Antenna Factor	Cable Loss	Preamp Factor	Remark	Ant Pos	Table Pos	Pol/Phase
	MHz	dBuV/m	dB	dBuV/m	dBuV	dB/m	dB	dB		cm	deg	
1 @	98.870	36.07	-7.43	43.50	50.88	10.79	0.36	25.96	Peak	100	325	VERTICAL
2 @	163.860	39.58	-3.92	43.50	52.22	12.32	0.72	25.68	Peak	400	0	VERTICAL
3 @	233.700	41.04	-4.96	46.00	53.83	11.55	1.09	25.43	Peak	400	0	VERTICAL
4 @	296.750	42.37	-3.63	46.00	52.87	13.33	1.14	24.97	Peak	400	0	VERTICAL
5 @	365.620	41.27	-4.73	46.00	49.99	15.14	1.30	25.16	Peak	400	0	VERTICAL
6	431.580	36.24	-9.76	46.00	43.99	16.56	1.49	25.79	Peak	400	0	VERTICAL

**Note:**

The amplitude of spurious emissions which are attenuated by more than 20 dB below the permissible value has no need to be reported.

Emission level (dBuV/m) = 20 log Emission level (uV/m).

Corrected Reading: Antenna Factor + Cable Loss + Read Level - Preamp Factor = Level.



4.4.9. Results for Radiated Emissions (1GHz~10<sup>th</sup> Harmonic)

Temperature	24.3°C	Humidity	56%
Test Engineer	Roy Huang	Configurations	Draft n MCS8 20MHz Ch 1 Ant. A + Ant. B

Horizontal

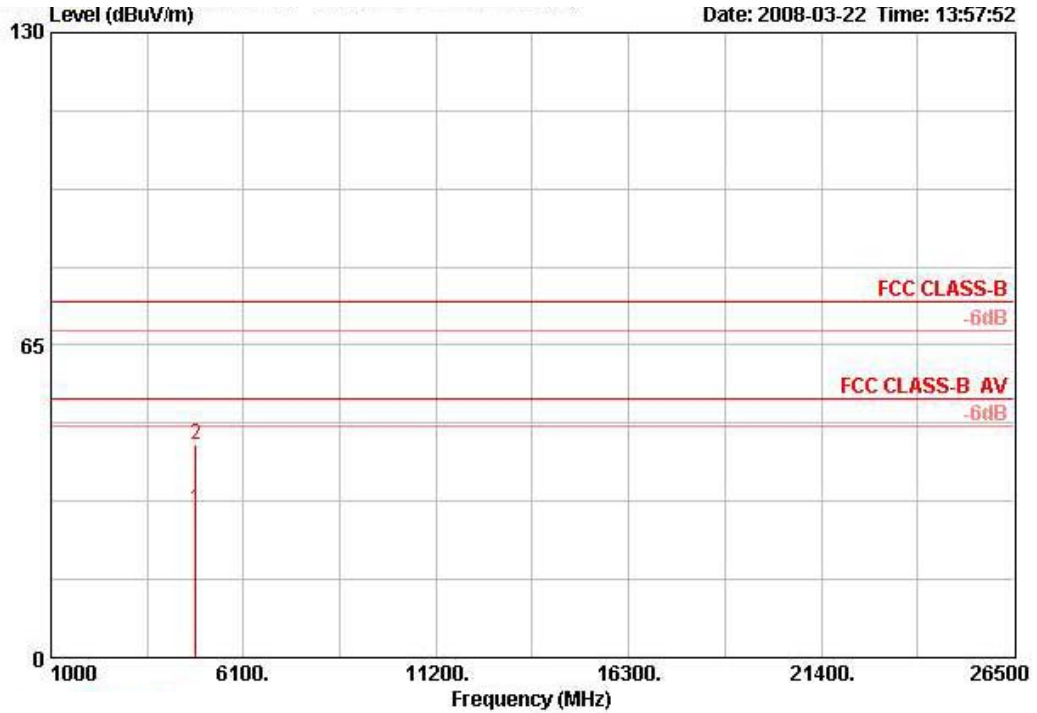

	Freq	Level	Over Limit	Limit Line	ReadAntenna Level	Antenna Factor	Cable Loss	Preamp Factor	Remark	Ant Pos	Table Pos	Pol/Phase
	MHz	dBuV/m	dB	dBuV/m	dBuV	dB/m	dB	dB		cm	deg	
1	4824.004	30.94	-23.06	54.00	29.43	33.39	3.37	35.25	AVERAGE	100	156	HORIZONTAL
2	4824.932	44.14	-29.86	74.00	42.63	33.39	3.37	35.25	PEAK	100	156	HORIZONTAL

**Vertical**

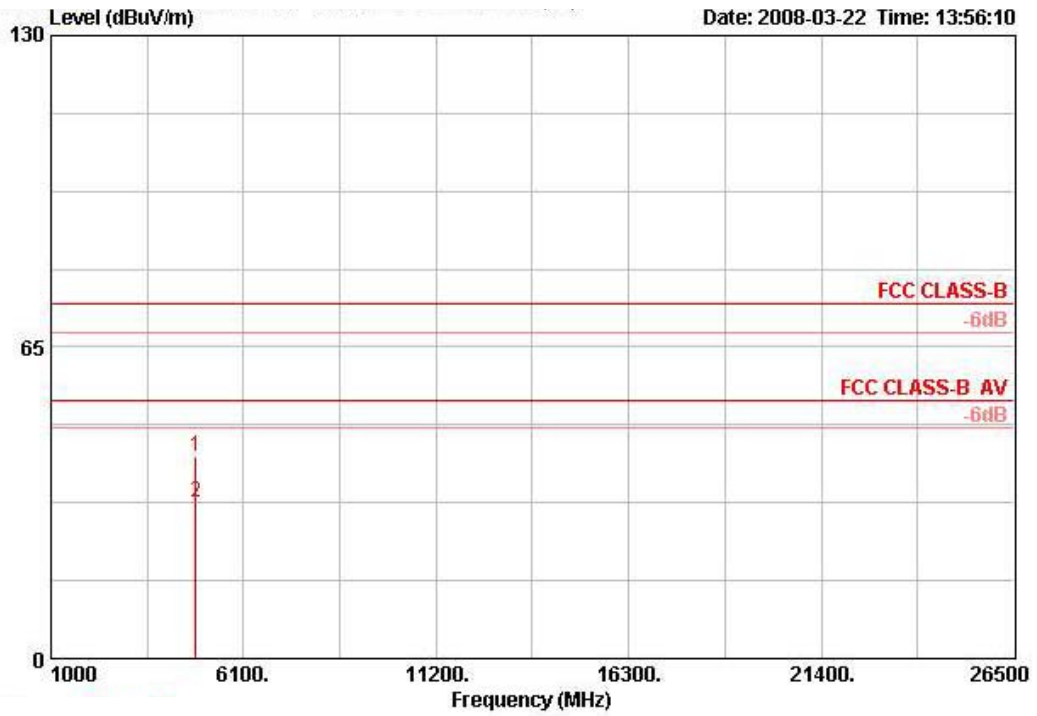

	Freq	Level	Over Limit	Limit Line	ReadAntenna Level	Antenna Factor	Cable Loss	Preamp Factor	Remark	Ant Pos	Table Pos	Pol/Phase
	MHz	dBuV/m	dB	dBuV/m	dBuV	dB/m	dB	dB		cm	deg	
1	4823.792	42.32	-31.68	74.00	40.81	33.39	3.37	35.25	PEAK	115	97	VERTICAL
2	4824.936	32.58	-21.42	54.00	31.07	33.39	3.37	35.25	AVERAGE	115	97	VERTICAL

Temperature	24.3°C	Humidity	56%
Test Engineer	Roy Huang	Configurations	Draft n MCS8 20MHz Ch 6 Ant. A + Ant. B

**Horizontal**

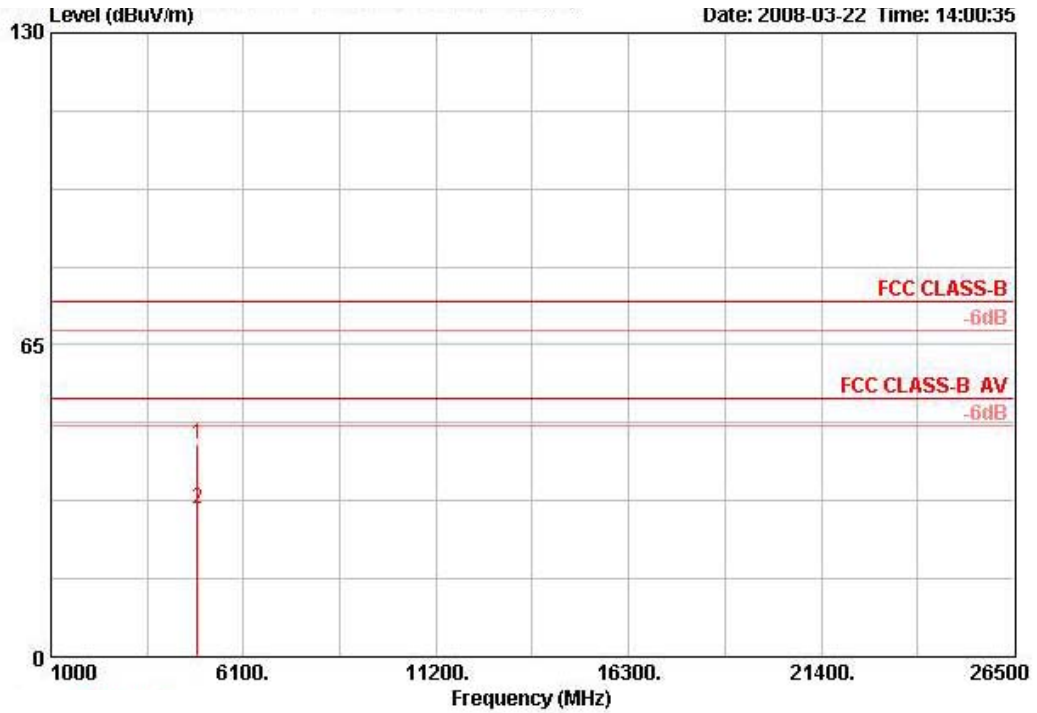

	Freq	Level	Over Limit	Limit Line	ReadAntenna Level	Antenna Factor	Cable Loss	Preamp	Remark	Ant Pos	Table Pos	Pol/Phase
	MHz	dBUV/m	dB	dBUV/m	dBuV	dB/m	dB	dB		cm	deg	
1	4873.988	44.12	-29.88	74.00	42.50	33.48	3.38	35.25	PEAK	100	173	HORIZONTAL
2	4874.004	30.95	-23.05	54.00	29.33	33.48	3.38	35.25	AVERAGE	100	173	HORIZONTAL

**Vertical**

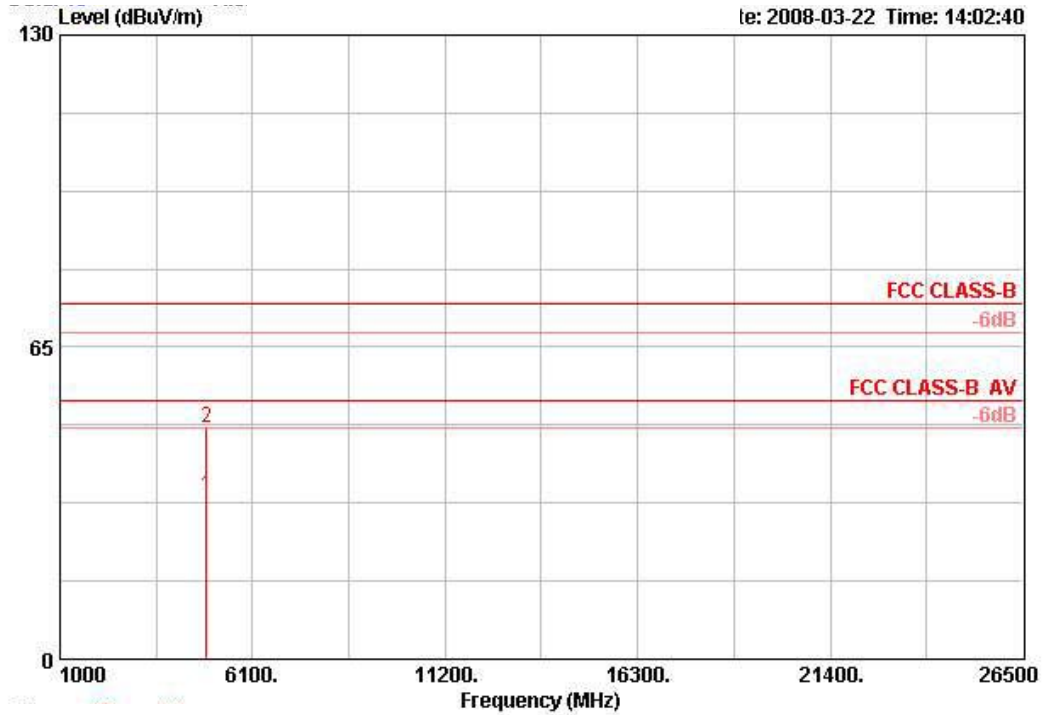

	Freq	Level	Over Limit	Limit Line	Read Level	Antenna Factor	Cable Loss	Preamp	Remark	Ant Pos	Table Pos	Pol/Phase
	MHz	dBuV/m	dB	dBuV/m	dBuV	dB/m	dB	dB		cm	deg	
1	4873.988	34.09	-39.91	74.00	32.47	33.48	3.38	35.25	PEAK	111	249	VERTICAL
2 @	4874.312	48.28	-5.72	54.00	46.66	33.48	3.38	35.25	AVERAGE	111	249	VERTICAL

Temperature	24.3°C	Humidity	56%
Test Engineer	Roy Huang	Configurations	Draft n MCS8 20MHz Ch11 Ant. A + Ant. B

**Horizontal**

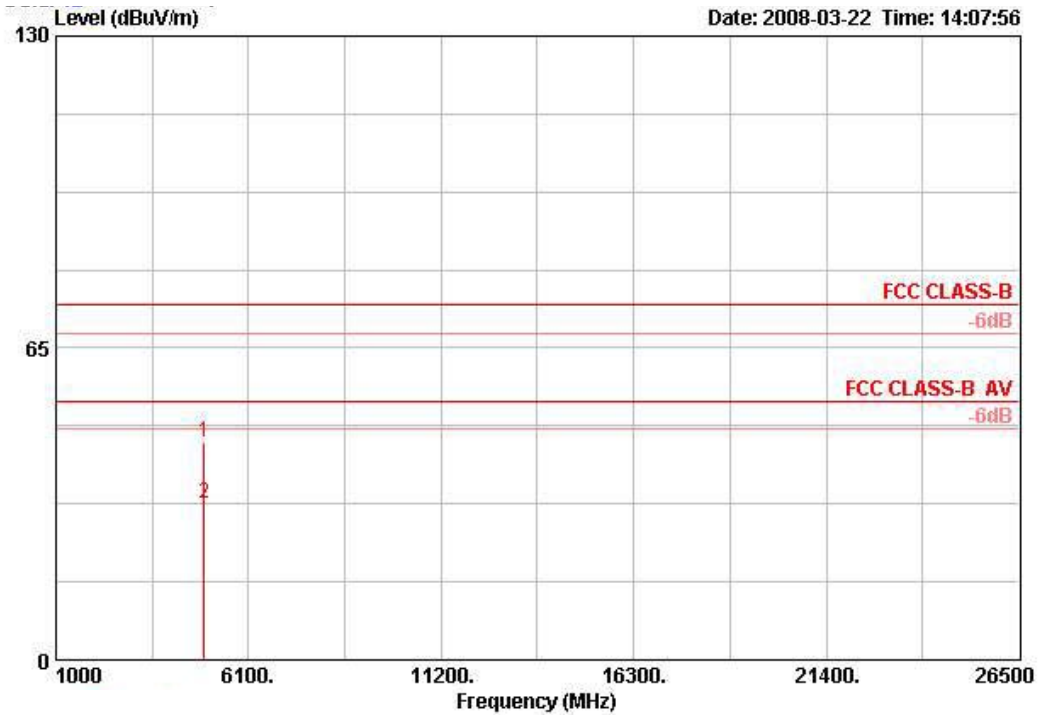

	Freq	Level	Over Limit	Limit Line	Read Level	Antenna Factor	Cable Loss	Preamp	Remark	Ant Pos	Table Pos	Pol/Phase
	MHz	dBuV/m	dB	dBuV/m	dBuV	dB/m	dB	dB		cm	deg	
1	4924.278	45.50	-28.50	74.00	43.77	33.58	3.40	35.24	PEAK	121	154	HORIZONTAL
2	4924.332	32.61	-21.39	54.00	30.88	33.58	3.40	35.24	AVERAGE	121	154	HORIZONTAL

**Vertical**

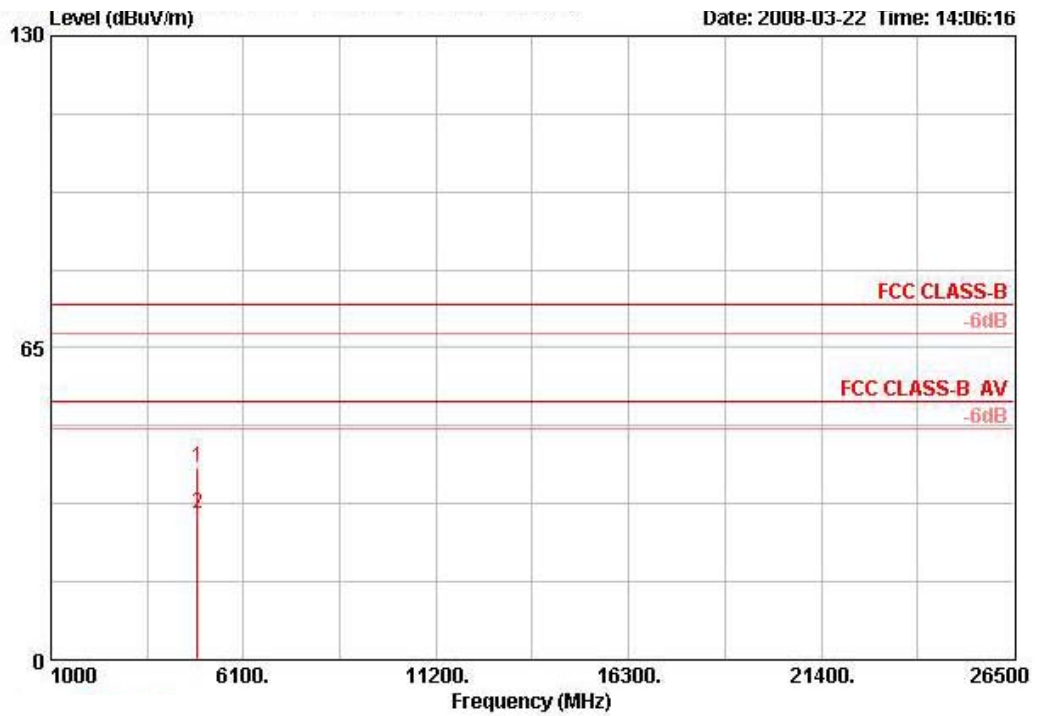

	Freq	Level	Over Limit	Limit Line	ReadAntenna Level	Antenna Factor	Cable Loss	Preamp Factor	Remark	Ant Pos	Table Pos	Pol/Phase
	MHz	dBUV/m	dB	dBUV/m	dBuV	dB/m	dB	dB		cm	deg	
1	4873.060	40.05	-33.95	74.00	38.43	33.48	3.38	35.25	PEAK	100	80	VERTICAL
2	4874.004	30.48	-23.52	54.00	28.86	33.48	3.38	35.25	AVERAGE	100	80	VERTICAL

Temperature	24.3°C	Humidity	56%
Test Engineer	Roy Huang	Configurations	Draft n MCS8 40MHz Ch 3 Ant. A + Ant. B

**Horizontal**

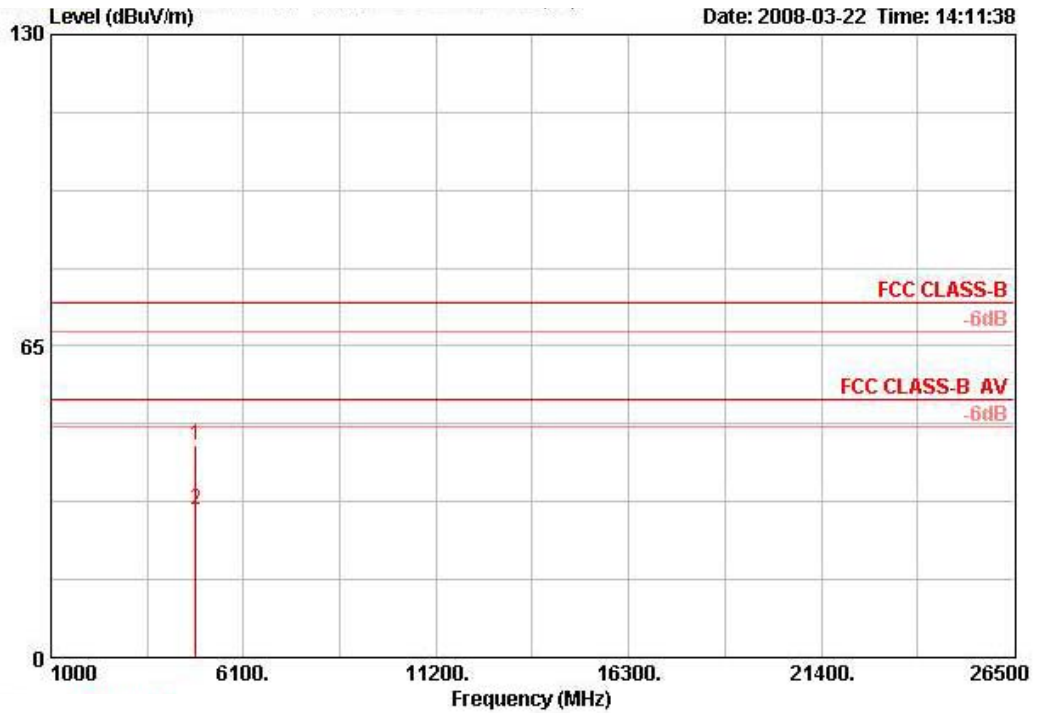

	Freq	Level	Over Limit	Limit Line	Read Level	Antenna Factor	Cable Loss	Preamp	Remark	Ant Pos	Table Pos	Pol/Phase
	MHz	dBUV/m	dB	dBUV/m	dBuV	dB/m	dB	dB		cm	deg	
1	4843.714	44.20	-29.80	74.00	42.65	33.42	3.38	35.25	PEAK	123	154	HORIZONTAL
2	4844.002	30.69	-23.31	54.00	29.14	33.42	3.38	35.25	AVERAGE	123	154	HORIZONTAL

**Vertical**

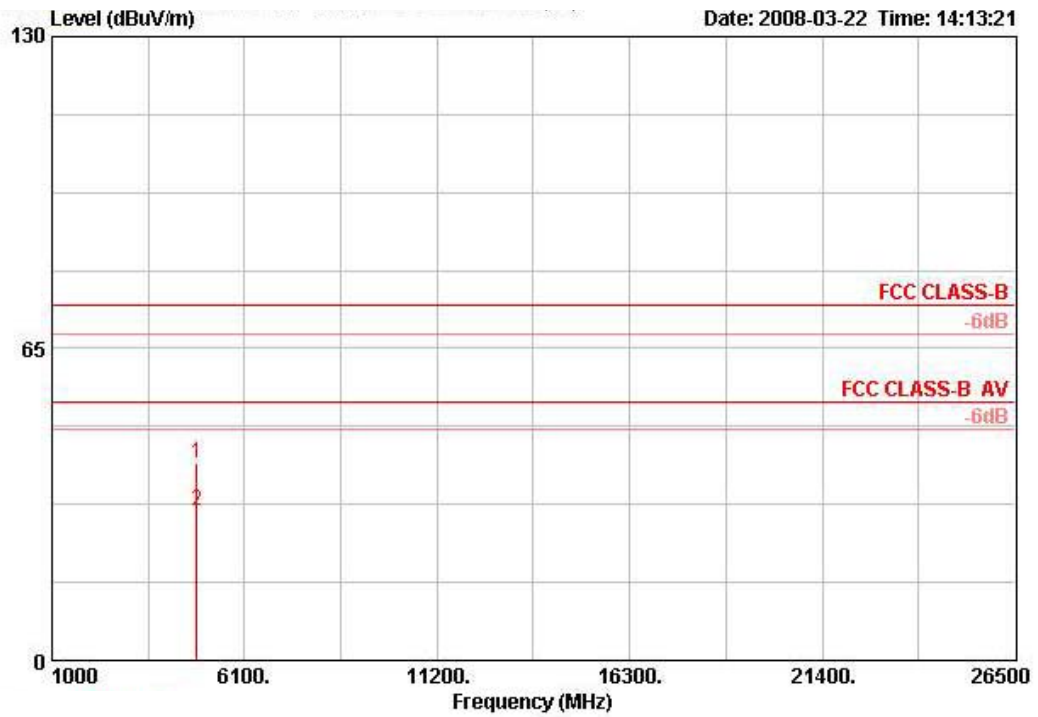

	Freq	Level	Over Limit	Limit Line	ReadAntenna Level	Antenna Factor	Cable Loss	Preamp Factor	Remark	Ant Pos	Table Pos	Pol/Phase
	MHz	dBUV/m	dB	dBUV/m	dBuV	dB/m	dB	dB		cm	deg	
1	4843.536	41.10	-32.90	74.00	39.55	33.42	3.38	35.25	PEAK	122	80	VERTICAL
2	4844.500	31.08	-22.92	54.00	29.53	33.42	3.38	35.25	AVERAGE	122	80	VERTICAL



Temperature	24.3°C	Humidity	56%
Test Engineer	Roy Huang	Configurations	Draft n MCS8 40MHz Ch 6 Ant. A + Ant. B

**Horizontal**

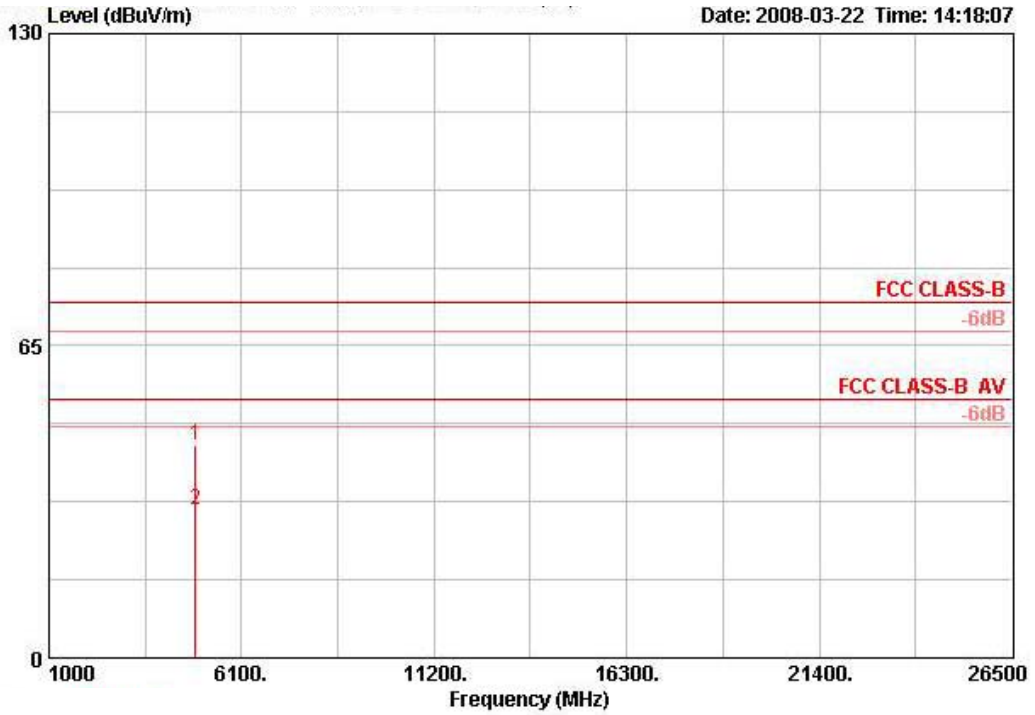

	Freq	Level	Over Limit	Limit Line	Read Antenna Level	Antenna Factor	Cable Loss	Preamp Factor	Remark	Ant Pos	Table Pos	Pol/Phase
	MHz	dBuV/m	dB	dBuV/m	dBuV	dB/m	dB	dB		cm	deg	
1	4873.934	44.40	-29.60	74.00	42.78	33.48	3.38	35.25	PEAK	155	175	HORIZONTAL
2	4874.000	30.77	-23.23	54.00	29.15	33.48	3.38	35.25	AVERAGE	155	174	HORIZONTAL

**Vertical**

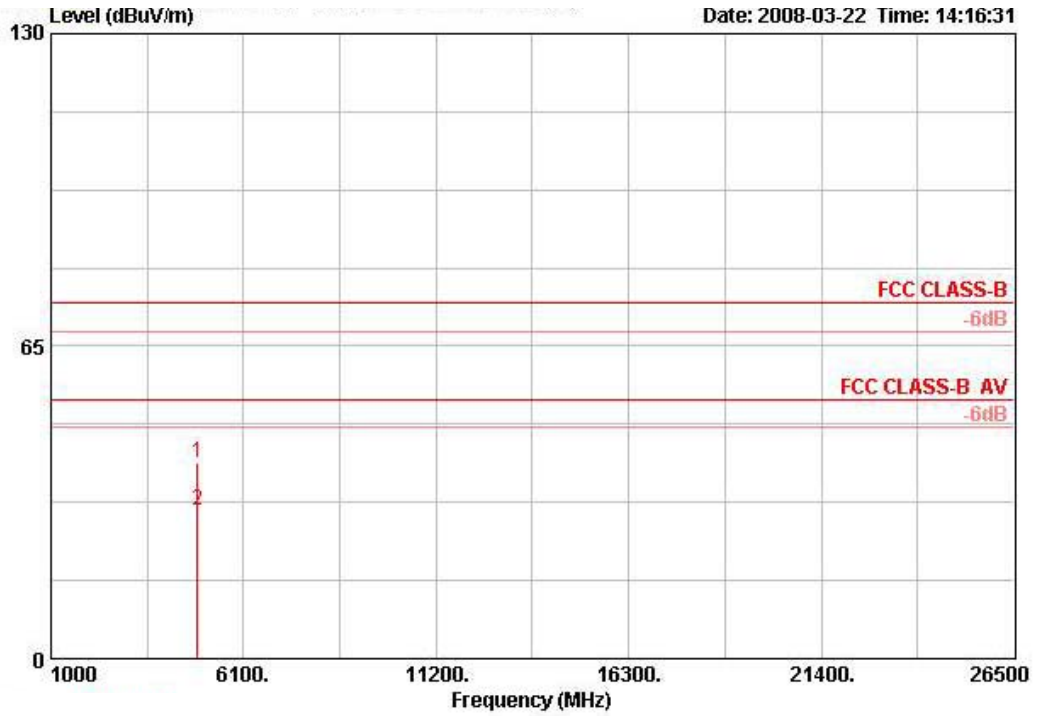

	Freq	Level	Over Limit	Limit Line	ReadAntenna Level	Antenna Factor	Cable Loss	Preamp Factor	Remark	Ant Pos	Table Pos	Pol/Phase
	MHz	dBuV/m	dB	dBuV/m	dBuV	dB/m	dB	dB		cm	deg	
1	4873.510	40.71	-33.29	74.00	39.09	33.48	3.38	35.25	PEAK	111	98	VERTICAL
2	4874.000	30.97	-23.03	54.00	29.35	33.48	3.38	35.25	AVERAGE	111	98	VERTICAL

Temperature	24.3°C	Humidity	56%
Test Engineer	Roy Huang	Configurations	Draft n MCS8 40MHz Ch 9 Ant. A + Ant. B

**Horizontal**

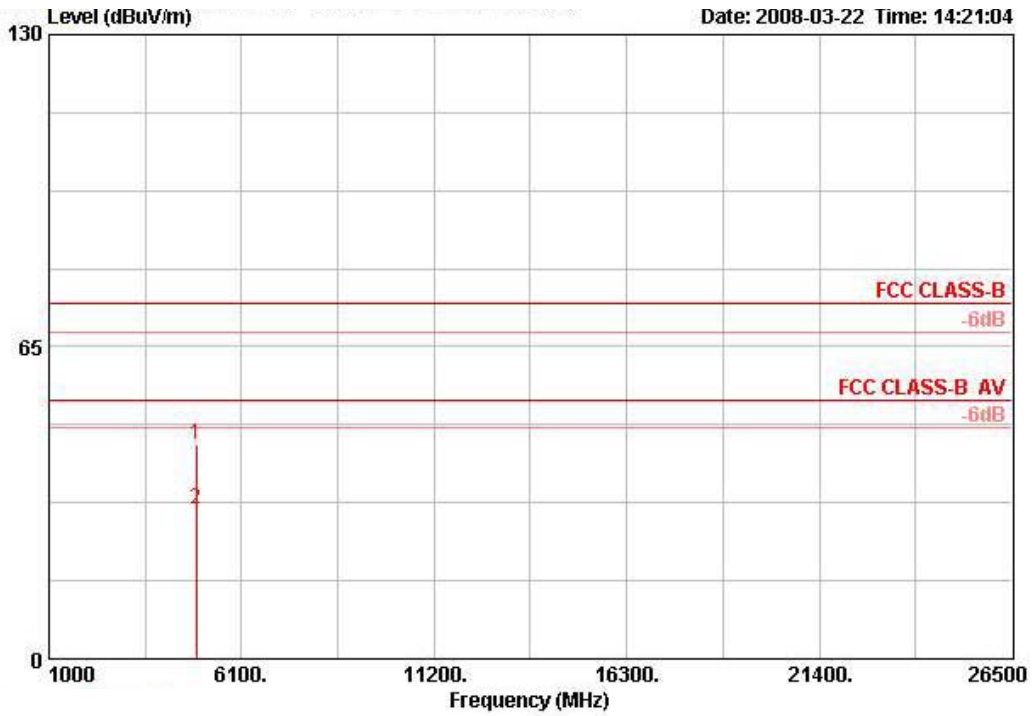

	Freq	Level	Over Limit	Limit Line	ReadAntenna Level	Antenna Factor	Cable Loss	Preamp Factor	Remark	Ant Pos	Table Pos	Pol/Phase
	MHz	dBuV/m	dB	dBuV/m	dBuV	dB/m	dB	dB		cm	deg	
1	4903.940	44.79	-29.21	74.00	43.10	33.54	3.39	35.24	PEAK	121	157	HORIZONTAL
2	4904.000	31.28	-22.72	54.00	29.59	33.54	3.39	35.24	AVERAGE	121	157	HORIZONTAL

**Vertical**

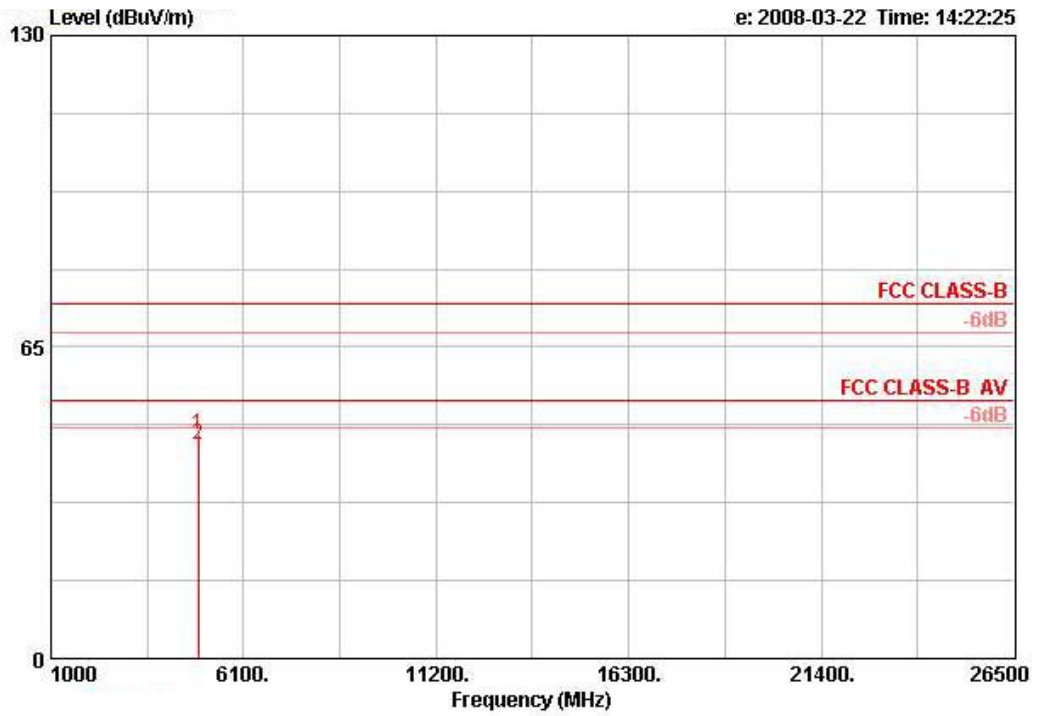

	Freq	Level	Over Limit	Limit Line	ReadAntenna Level	Antenna Factor	Cable Loss	Preamp Factor	Remark	Ant Pos	Table Pos	Pol/Phase
	MHz	dBUV/m	dB	dBUV/m	dBuV	dB/m	dB	dB		cm	deg	
1	4903.710	46.62	-27.38	74.00	44.93	33.54	3.39	35.24	PEAK	134	95	VERTICAL
2 @	4904.332	44.55	-9.45	54.00	42.86	33.54	3.39	35.24	AVERAGE	134	95	VERTICAL

**Note:**

The amplitude of spurious emissions which are attenuated by more than 20 dB below the permissible value has no need to be reported.

Emission level (dBUV/m) = 20 log Emission level (uV/m).

Corrected Reading: Antenna Factor + Cable Loss + Read Level - Preamp Factor = Level.

## 4.5. Band Edge Emissions Measurement

### 4.5.1. Limit

20dBc in any 100 kHz bandwidth outside the operating frequency band. In case the emission fall within the restricted band specified on 15.205(a), then the 15.209(a) limit in the table below has to be followed.

Frequencies (MHz)	Field Strength (micorvolts/meter)	Measurement Distance (meters)
0.009~0.490	2400/F(KHz)	300
0.490~1.705	24000/F(KHz)	30
1.705~30.0	30	30
30~88	100	3
88~216	150	3
216~960	200	3
Above 960	500	3

### 4.5.2. Measuring Instruments and Setting

Please refer to section 5 of equipments list in this report. The following table is the setting of the spectrum analyzer.

Spectrum Parameter	Setting
Attenuation	Auto
Span Frequency	100 MHz
RB / VB (Emission in restricted band)	1 MHz / 1MHz for Peak, 1 MHz / 10Hz for Average
RB / VB (Emission in non-restricted band)	100 KHz /100 KHz for Peak

### 4.5.3. Test Procedures

1. The test procedure is the same as section 4.5.3, only the frequency range investigated is limited to 100MHz around bandedges.
2. In case the emission is fail due to the used RB/VB is too wide, marker-delta method of FCC Public Notice DA00-705 will be followed.

### 4.5.4. Test Setup Layout

This test setup layout is the same as that shown in section 4.5.4.

### 4.5.5. Test Deviation

There is no deviation with the original standard.

### 4.5.6. EUT Operation during Test

The EUT was programmed to be in continuously transmitting mode.

#### 4.5.7. Test Result of Band Edge and Fundamental Emissions

Temperature	24.3°C	Humidity	56%
Test Engineer	Roy Huang	Configurations	Draft n MCS8 20MHz Ch 1, 6, 11 Ant. A + Ant. B

##### Channel 1

	Freq	Level	Over Limit	Limit Line	ReadAntenna Level	Antenna Factor	Cable Loss	Preamp Factor	Remark	Ant Pos	Table Pos	Pol/Phase
	MHz	dBuV/m	dB	dBuV/m	dBuV	dB/m	dB	dB		cm	deg	
1 @	2389.000	51.12	-2.88	54.00	20.72	28.05	2.35	0.00	AVERAGE	100	201	VERTICAL
2	2390.000	64.06	-9.94	74.00	33.64	28.05	2.36	0.00	PEAK	100	201	VERTICAL
3 ~	2417.000	109.41			78.94	28.09	2.38	0.00	PEAK	100	201	VERTICAL
4 @	2419.400	100.34			69.87	28.09	2.38	0.00	AVERAGE	100	201	VERTICAL

Item 3, 4 are the fundamental frequency at 2412 MHz

##### Channel 6

	Freq	Level	Over Limit	Limit Line	ReadAntenna Level	Antenna Factor	Cable Loss	Preamp Factor	Remark	Ant Pos	Table Pos	Pol/Phase
	MHz	dBuV/m	dB	dBuV/m	dBuV	dB/m	dB	dB		cm	deg	
1 @	2433.200	112.09			81.58	28.13	2.38	0.00	PEAK	100	93	VERTICAL
2 @	2433.600	103.09			72.57	28.13	2.38	0.00	AVERAGE	100	93	VERTICAL

Item 1, 2 are the fundamental frequency at 2437MHz.

##### Channel 11

	Freq	Level	Over Limit	Limit Line	ReadAntenna Level	Antenna Factor	Cable Loss	Preamp Factor	Remark	Ant Pos	Table Pos	Pol/Phase
	MHz	dBuV/m	dB	dBuV/m	dBuV	dB/m	dB	dB		cm	deg	
1 @	2454.800	99.12			68.51	28.22	2.40	0.00	AVERAGE	100	93	VERTICAL
2 @	2455.000	107.64			77.03	28.22	2.40	0.00	PEAK	100	93	VERTICAL
3 @	2483.900	48.90	-5.10	54.00	18.23	28.26	2.41	0.00	AVERAGE	100	93	VERTICAL
4	2484.500	61.53	-12.47	74.00	30.86	28.26	2.41	0.00	PEAK	100	93	VERTICAL

Item 1, 2 are the fundamental frequency at 2462 MHz.

<b>Temperature</b>	24.3°C	<b>Humidity</b>	56%
<b>Test Engineer</b>	Roy Huang	<b>Configurations</b>	Draft n MCS8 40MHz Ch 3, 6, 9 Ant. A + Ant. B

**Channel 3**

	Freq	Level	Over	Limit	ReadAntenna		Cable	Preamp	Remark	Ant	Table	
			Limit	Line	Level	Factor	Loss	Factor		Pos	Pos	Pol/Phase
	MHz	dBuV/m	dB	dBuV/m	dBuV	dB/m	dB	dB		cm	deg	
1 @	2386.000	50.42	-3.58	54.00	20.02	28.05	2.35	0.00	AVERAGE	100	222	VERTICAL
2	2387.200	62.65	-11.35	74.00	32.25	28.05	2.35	0.00	PEAK	100	222	VERTICAL
3 @	2411.200	102.07			71.61	28.09	2.36	0.00	PEAK	100	222	VERTICAL
4 @	2436.800	92.21			61.66	28.18	2.38	0.00	AVERAGE	100	222	VERTICAL

Item 3, 4 are the fundamental frequency at 2422 MHz.

**Channel 6**

	Freq	Level	Over	Limit	ReadAntenna		Cable	Preamp	Remark	Ant	Table	
			Limit	Line	Level	Factor	Loss	Factor		Pos	Pos	Pol/Phase
	MHz	dBuV/m	dB	dBuV/m	dBuV	dB/m	dB	dB		cm	deg	
1 @	2448.200	97.41			66.84	28.18	2.40	0.00	AVERAGE	100	91	VERTICAL
2 @	2450.600	107.13			76.55	28.18	2.40	0.00	PEAK	100	91	VERTICAL

Item 3, 4 are the fundamental frequency at 2437MHz.

**Channel 9**

	Freq	Level	Over	Limit	ReadAntenna		Cable	Preamp	Remark	Ant	Table	
			Limit	Line	Level	Factor	Loss	Factor		Pos	Pos	Pol/Phase
	MHz	dBuV/m	dB	dBuV/m	dBuV	dB/m	dB	dB		cm	deg	
1 @	2449.200	96.49			65.92	28.18	2.40	0.00	AVERAGE	100	92	VERTICAL
2 @	2460.400	106.29			75.68	28.22	2.40	0.00	PEAK	100	92	VERTICAL
3 @	2483.500	53.15	-0.85	54.00	22.47	28.26	2.41	0.00	AVERAGE	100	92	VERTICAL
4 @	2483.900	65.36	-8.64	74.00	34.69	28.26	2.41	0.00	PEAK	100	92	VERTICAL

Item 1, 2 are the fundamental frequency at 2452 MHz.

Note:

Emission level (dBuV/m) = 20 log Emission level (uV/m).

Corrected Reading: Antenna Factor + Cable Loss + Read Level - Preamp Factor = Level.

**For Emission not in Restricted Band**

**Low Band Edge Plot on Configuration Draft n MCS8 20MHz Ant. A + Ant. B / 2412 MHz**

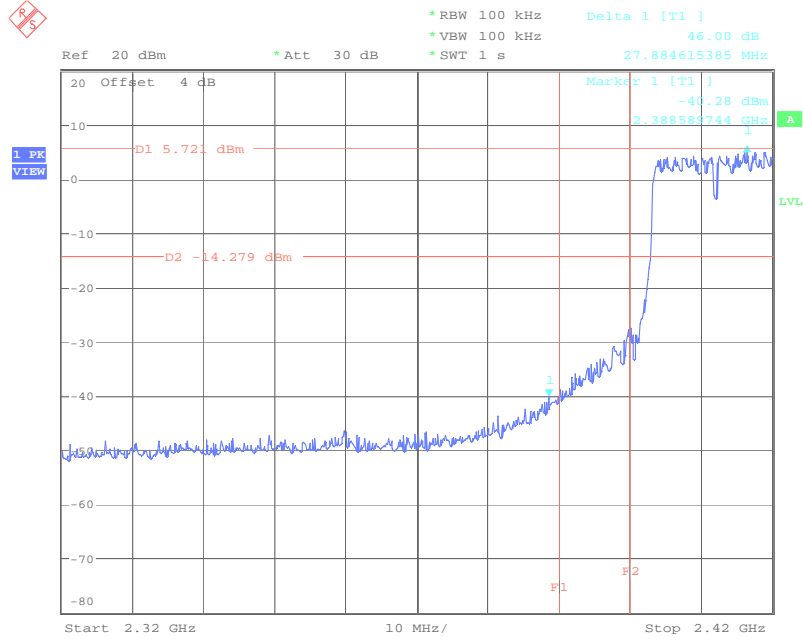

Date: 27.MAR.2008 09:37:26

**High Band Edge Plot on Configuration Draft n MCS8 20MHz Ant. A + Ant. B / 2462 MHz**

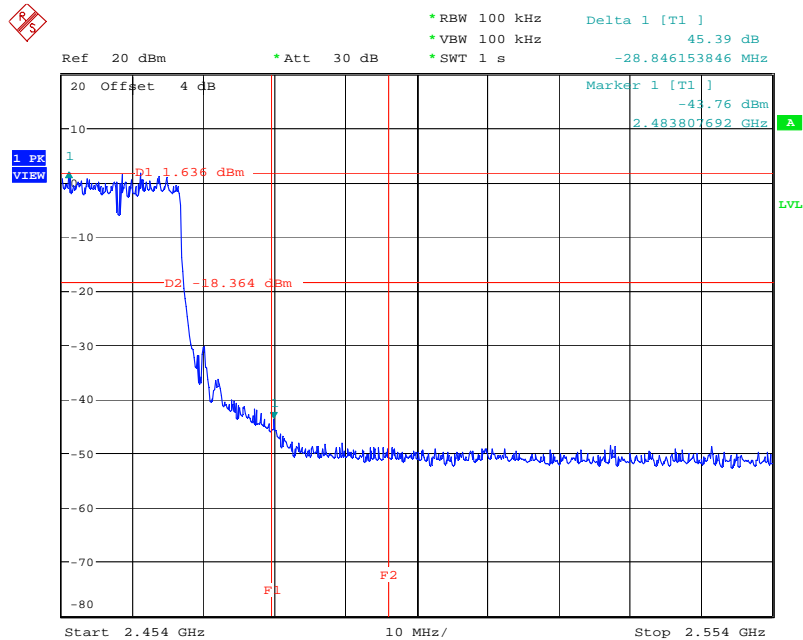

Date: 27.MAR.2008 09:39:30



Low Band Edge Plot on Configuration Drafft n MCS8 40MHz Ant. A + Ant. B / 2422 MHz

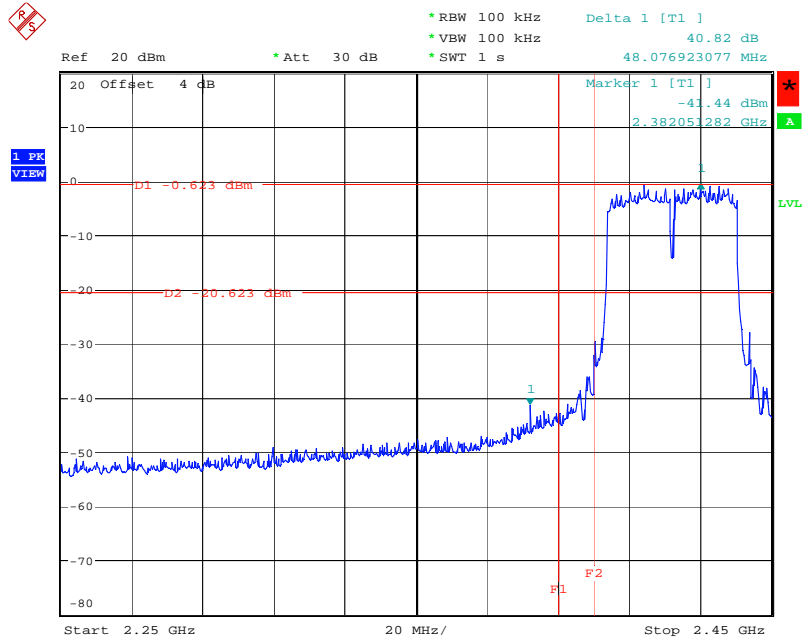

Date: 27.MAR.2008 09:41:25

High Band Edge Plot on Configuration Drafft n MCS8 40MHz Ant. A + Ant. B / 2452 MHz

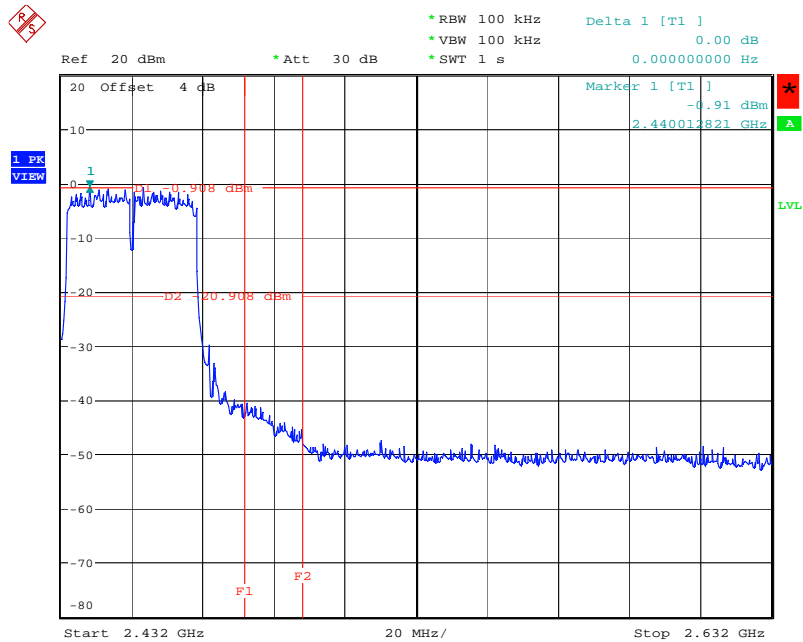

Date: 27.MAR.2008 09:43:44

## 4.6. Antenna Requirements

### 4.6.1. Limit

Except for special regulations, the Low-power Radio-frequency Devices must not be equipped with any jacket for installing an antenna with extension cable. An intentional radiator shall be designed to ensure that no antenna other than that furnished by the responsible party shall be used with the device. The use of a permanently attached antenna or of an antenna that uses a unique coupling to the intentional radiator shall be considered sufficient to comply with the provisions of this Section. The manufacturer may design the unit so that the user can replace a broken antenna, but the use of a standard antenna jack or electrical connector is prohibited. Further,

### 4.6.2. Antenna Connector Construction

Please refer to section 3.3 in this test report; antenna connector complied with the requirements.

## 5. LIST OF MEASURING EQUIPMENTS

Instrument	Manufacturer	Model No.	Serial No.	Characteristics	Calibration Date	Remark
EMC Receiver	R&S	ESCS 30	100174	9kHz – 2.75GHz	Mar. 03, 2008	Conduction (CO04-HY)
LISN	MessTec	NNB-2/16Z	99079	9kHz – 30MHz	Mar. 31, 2007	Conduction (CO04-HY)
LISN (Support Unit)	EMCO	3810/2NM	9703-1839	9kHz – 30MHz	Mar. 22, 2008	Conduction (CO04-HY)
RF Cable-CON	UTIFLEX	3102-26886-4	CB049	9kHz – 30MHz	Apr. 20, 2007	Conduction (CO04-HY)
ISN	SCHAFFNER	ISN T400	21653	9kHz – 30MHz	Mar. 27, 2008	Conduction (CO04-HY)
EMI Filter	LINDGREN	LRE-2030	2651	< 450 Hz	N/A	Conduction (CO04-HY)
3m Semi Anechoic Chamber	SIDT FRANKONIA	SAC-3M	03CH03-HY	30 MHz - 1 GHz 3m	Jun. 14, 2007	Radiation (03CH03-HY)
Amplifier	SCHAFFNER	COA9231A	18667	9 kHz - 2 GHz	Jan. 14, 2008	Radiation (03CH03-HY)
Amplifier	Agilent	8449B	3008A02120	1 GHz - 26.5 GHz	Jun. 07, 2007	Radiation (03CH03-HY)
Amplifier	MITEQ	AMF-6F-260400	9121372	26.5 GHz - 40 GHz	Jan. 22, 2007*	Radiation (03CH03-HY)
Spectrum Analyzer	R&S	FSP40	100305	9 kHz - 40 GHz	Sep. 27, 2007	Radiation (03CH03-HY)
Loop Antenna	R&S	HFH2-Z2	860004/001	9 kHz - 30 MHz	May 23, 2006*	Radiation (03CH03-HY)
Bilog Antenna	SCHAFFNER	CBL 6112D	22237	30 MHz – 1 GHz	Jul. 21, 2007	Radiation (03CH03-HY)
Horn Antenna	EMCO	3115	6741	1GHz ~ 18GHz	May 04, 2007	Radiation (03CH03-HY)
Horn Antenna	SCHWARZBECK	BBHA9170	BBHA9170154	15 GHz - 40 GHz	Jan.18, 2008	Radiation (03CH03-HY)
RF Cable-R03m	Jye Bao	RG142	CB021	30 MHz - 1 GHz	Dec. 03, 2007	Radiation (03CH03-HY)
RF Cable-HIGH	SUHNER	SUCOFLEX 106	03CH03-HY	1 GHz - 40 GHz	Dec. 03, 2007	Radiation (03CH03-HY)
Turn Table	HD	DS 420	420/650/00	0 – 360 degree	N/A	Radiation (03CH03-HY)
Antenna Mast	HD	MA 240	240/560/00	1 m - 4 m	N/A	Radiation (03CH03-HY)
Spectrum Analyzer	R&S	FSP30	100023	9kHz ~ 30GHz	Jan. 10, 2008	Conducted (TH01-HY)
Power Meter	R&S	NRVS	100444	DC ~ 40GHz	Jun. 27, 2007	Conducted (TH01-HY)
Power Sensor	R&S	NRV-Z51	100458	DC ~ 30GHz	Jun. 27, 2007	Conducted (TH01-HY)
Power Sensor	R&S	NRV-Z32	100057	30MHz ~ 6GHz	Jun. 27, 2007	Conducted (TH01-HY)
AC Power Source	HPC	HPA-500W	HPA-9100024	AC 0 ~ 300V	May 04, 2007*	Conducted (TH01-HY)
DC Power Source	G.W.	GPC-6030D	C671845	DC 1V ~ 60V	Mar. 03, 2008	Conducted (TH01-HY)
Temp. and Humidity Chamber	KSON	THS-C3L	612	N/A	Jan. 14, 2008	Conducted (TH01-HY)
RF CABLE-1m	Jye Bao	RG142	CB034-1m	20MHz ~ 7GHz	Jan. 04, 2008	Conducted (TH01-HY)

Instrument	Manufacturer	Model No.	Serial No.	Characteristics	Calibration Date	Remark
RF CABLE-2m	Jye Bao	RG142	CB035-2m	20MHz ~ 1GHz	Jan. 04, 2008	Conducted (TH01-HY)
Vector Signal Generator	R&S	SMU200A	102098	100kHz ~ 6GHz	Nov. 14, 2007	Conducted (TH01-HY)
Signal Generator	R&S	SMR40	100116	10MHz ~ 40GHz	Mar. 07, 2008	Conducted (TH01-HY)
Signal Generator	R&S	SMR40	100116	10MHz ~ 40GHz	Mar. 07, 2008	Conducted (TH01-HY)

Note: Calibration Interval of instruments listed above is one year.

\* Calibration Interval of instruments listed above is two year.

## 6. TEST LOCATION

SHIJR	ADD : 6Fl., No. 106, Sec. 1, Shintai 5th Rd., Shijr City, Taipei, Taiwan 221, R.O.C. TEL : 886-2-2696-2468 FAX : 886-2-2696-2255
HWA YA	ADD : No. 52, Hwa Ya 1st Rd., Kwei-Shan Hsiang, Tao Yuan Hsien, Taiwan, R.O.C. TEL : 886-3-327-3456 FAX : 886-3-318-0055
LINKOU	ADD : No. 30-2, Dingfu Tsuen, Linkou Shiang, Taipei, Taiwan 244, R.O.C TEL : 886-2-2601-1640 FAX : 886-2-2601-1695
DUNGHU	ADD : No. 3, Lane 238, Kangle St., Neihu Chiu, Taipei, Taiwan 114, R.O.C. TEL : 886-2-2631-4739 FAX : 886-2-2631-9740
JUNGHE	ADD : 7Fl., No. 758, Jungjeng Rd., Junghe City, Taipei, Taiwan 235, R.O.C. TEL : 886-2-8227-2020 FAX : 886-2-8227-2626
NEIHU	ADD : 4Fl., No. 339, Hsin Hu 2 <sup>nd</sup> Rd., Taipei 114, Taiwan, R.O.C. TEL : 886-2-2794-8886 FAX : 886-2-2794-9777
JHUBEI	ADD : No.8, Lane 724, Bo-ai St., Jhubei City, HsinChu County 302, Taiwan, R.O.C. TEL : 886-3-656-9065 FAX : 886-3-656-9085

## 7. TAF CERTIFICATE OF ACCREDITATION



Certificate No. : L1190-070110

財團法人全國認證基金會  
Taiwan Accreditation Foundation

### Certificate of Accreditation

This is to certify that

**Sporton International Inc.**

**EMC & Wireless Communications Laboratory**

No.52, Hwa Ya 1st Rd., Hwa Ya Technology Park, Kwei-Shan Hsiang, Tao Yuan Hsien,  
Taiwan, R.O.C.

is accredited in respect of laboratory

Accreditation Criteria	: ISO/IEC 17025:2005
Accreditation Number	: 1190
Originally Accredited	: December 15, 2003
Effective Period	: January 10, 2007 to January 09, 2010
Accredited Scope	: Testing Field, see described in the Appendix
Specific Accreditation Program	: Accreditation Program for Designated Testing Laboratory for Commodities Inspection Accreditation Program for Telecommunication Equipment Testing Laboratory



Jay-San Chen  
President, Taiwan Accreditation Foundation  
Date : January 10, 2007

P1, total 9 pages

The Appendix forms an integral part of this Certificate, which shall be invalid when used without the Appendix.