



SPORTON International Inc.

No. 52, Hwa Ya 1st Rd., Kwei-Shan Hsiang, TaoYuan Hsien, Taiwan, R.O.C.
Ph: 886-3-327-3456 / FAX: 886-3-327-0973 / www.sporton.com.tw

FCC RADIO TEST REPORT

Applicant's company	AboCom Systems, Inc.
Applicant Address	No.77, Youyi Rd., Jhunan Township, Miaoi Country 350, Taiwan
FCC ID	MQ4WM2100
Manufacturer's company	AboCom Systems, Inc.
Manufacturer Address	No.77, Youyi Rd., Jhunan Township, Miaoi Country 350, Taiwan

Product Name	802.11b/g Wireless LAN Mini PCI Card
Brand Name	AboCom
Model Name	WM2100
Test Rule	47 CFR FCC Part 15 Subpart C § 15.247
Test Freq. Range	2400 ~ 2483.5MHz
Received Date	Jul. 3, 2007
Final Test Date	Jul. 13, 2007
Submission Type	Original Equipment

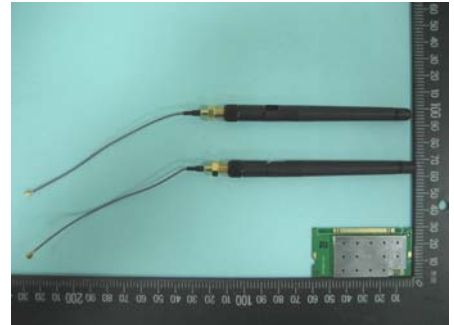

Statement

Test result included is only for the 802.11b/g part of the product.

The test result in this report refers exclusively to the presented test model / sample.

Without written approval of SPORTON International Inc., the test report shall not be reproduced except in full.

The measurements and test results shown in this test report were made in accordance with the procedures

and found in compliance with the limit given in **ANSI C63.4-2003** and **47 CFR FCC Part 15 Subpart C**.

The test equipment used to perform the test is calibrated and traceable to NML/ROC.



Table of Contents

1. CERTIFICATE OF COMPLIANCE	1
2. SUMMARY OF THE TEST RESULT	2
3. GENERAL INFORMATION	3
3.1. Product Details.....	3
3.2. Accessories.....	3
3.3. Table for Filed Antenna.....	3
3.4. Table for Carrier Frequencies	3
3.5. Table for Test Modes	4
3.6. Table for Testing Locations.....	4
3.7. Table for Supporting Units	4
3.8. Table for Parameters of Test Software Setting	5
3.9. Test Configurations	6
4. TEST RESULT	8
4.1. AC Power Line Conducted Emissions Measurement.....	8
4.2. Maximum Peak Output Power Measurement	12
4.3. Power Spectral Density Measurement	14
4.4. 6dB Spectrum Bandwidth Measurement	19
4.5. Radiated Emissions Measurement	24
4.6. Band Edge Emissions Measurement	42
4.7. Antenna Requirements	49
5. LIST OF MEASURING EQUIPMENTS	50
6. TEST LOCATION.....	52
7. TAF CERTIFICATE OF ACCREDITATION	53
APPENDIX A. PHOTOGRAPHS OF EUT.....	A1 ~ A5
APPENDIX B. TEST PHOTOS.....	B1 ~ B8
APPENDIX C. MAXIMUM PERMISSIBLE EXPOSURE.....	C1 ~C5

History of This Test Report

Original Issue Date: Jul. 17, 2007

Report No.: FR770510

No additional attachment.

Additional attachment were issued as following record:

Attachment No.	Issue Date	Description



1. CERTIFICATE OF COMPLIANCE

Product Name : 802.11b/g Wireless LAN Mini PCI Card
Brand Name : AboCom
Model Name : WM2100
Applicant : AboCom Systems, Inc.
Test Rule Part(s) : 47 CFR FCC Part 15 Subpart C § 15.247

Sporton International as requested by the applicant to evaluate the EMC performance of the product sample received on Jul. 3, 2007 would like to declare that the tested sample has been evaluated and found to be in compliance with the tested rule parts. The data recorded as well as the test configuration specified is true and accurate for showing the sample's EMC nature.

A handwritten signature in blue ink that reads 'Wayne Hsu 8.2007'. The signature is written over a horizontal line.

Wayne Hsu

SPORTON INTERNATIONAL INC.

2. SUMMARY OF THE TEST RESULT

Applied Standard: 47 CFR FCC Part 15 Subpart C				
Part	Rule Section	Description of Test	Result	Under Limit
4.1	15.207	AC Power Line Conducted Emissions	Complies	11.80 dB
4.2	15.247(b)(3)	Maximum Peak Conducted Output Power	Complies	13.08 dB
4.3	15.247(e)	Power Spectral Density	Complies	15.45 dB
4.4	15.247(a)(2)	6dB Spectrum Bandwidth	Complies	-
4.5	15.247(d)	Radiated Emissions	Complies	5.27 dB
4.6	15.247(d)	Band Edge Emissions	Complies	1.52 dB
4.7	15.203	Antenna Requirements	Complies	-

Test Items	Uncertainty	Remark
AC Power Line Conducted Emissions	±2.3dB	Confidence levels of 95%
Maximum Peak Conducted Output Power	±0.8dB	Confidence levels of 95%
Power Spectral Density	±0.5dB	Confidence levels of 95%
6dB Spectrum Bandwidth	±8.5×10 ⁻⁸	Confidence levels of 95%
Radiated Emissions (9kHz~30MHz)	±0.8dB	Confidence levels of 95%
Radiated Emissions (30MHz~1000MHz)	±1.9dB	Confidence levels of 95%
Radiated / Band Edge Emissions (1GHz~18GHz)	±1.9dB	Confidence levels of 95%
Radiated Emissions (18GHz~40GHz)	±1.9dB	Confidence levels of 95%
Temperature	±0.7°C	Confidence levels of 95%
Humidity	±3.2%	Confidence levels of 95%
DC / AC Power Source	±1.4%	Confidence levels of 95%

3. GENERAL INFORMATION

3.1. Product Details

Items	Description
Power Type	From Host System
Modulation	DSSS for IEEE 802.11b ; OFDM for IEEE 802.11g
Data Modulation	DSSS (BPSK / QPSK / CCK) ; OFDM (BPSK / QPSK / 16QAM / 64QAM)
Data Rate (Mbps)	DSSS (1/ 2/ 5.5/11) ; OFDM (6/9/12/18/24/36/48/54)
Frequency Range	2400 ~ 2483.5MHz
Channel Number	11
Channel Band Width (99%)	11b: 15.44 MHz ; 11g: 16.53 MHz
Conducted Output Power	11b: 16.92 dBm ; 11g: 15.36 dBm
Carrier Frequencies	Please refer to section 3.4
Antenna	Please refer to section 3.3

3.2. Accessories

N/A

3.3. Table for Filed Antenna

Ant.	Brand	Model Name	Antenna Type	Connector	Gain (dBi)
1	Cortec	AN2400-0101RS	Dipole Antenna	Reversed-SMA	2.00

3.4. Table for Carrier Frequencies

Frequency Band	Channel No.	Frequency	Channel No.	Frequency
2400~2483.5MHz	1	2412 MHz	7	2442 MHz
	2	2417 MHz	8	2447 MHz
	3	2422 MHz	9	2452 MHz
	4	2427 MHz	10	2457 MHz
	5	2432 MHz	11	2462 MHz
	6	2437 MHz		

3.5. Table for Test Modes

Preliminary tests were performed in different data rate to find the worst radiated emission. The data rate shown in the table below is the worst-case rate with respect to the specific test item. Investigation has been done on all the possible configurations for searching the worst cases. The following table is a list of the test modes shown in this test report.

Test Items	Mode	Data Rate	Channel	Antenna
AC Power Line Conducted Emissions	Normal Link	11 Mbps	6	1
Maximum Peak Conducted Output Power Power Spectral Density 6dB Spectrum Bandwidth	11b/BPSK	1 Mbps	1/6/11	NA
	11g/BPSK	6 Mbps	1/6/11	NA
Radiated Emissions 9kHz~1GHz	11g/BPSK	6 Mbps	6	1
Radiated Emissions 1GHz~10 th Harmonic	11b/BPSK	1 Mbps	1/6/11	1
	11g/BPSK	6 Mbps	1/6/11	1
Band Edge Emissions	11b/BPSK	1 Mbps	1/11	1
	11g/BPSK	6 Mbps	1/11	1

3.6. Table for Testing Locations

Test Site No.	Site Category	Location	FCC Reg. No.	IC File No.	VCCI Reg. No
03CH03-HY	SAC	Hwa Ya	101377	IC 4088	-
CO04-HY	Conduction	Hwa Ya	101377	IC 4088	-
TH01-HY	OVEN Room	Hwa Ya	-	-	-

Open Area Test Site (OATS); Semi Anechoic Chamber (SAC); Fully Anechoic Chamber (FAC).

Please refer section 6 for Test Site Address.

3.7. Table for Supporting Units

Support Unit	Brand	Model	FCC ID
Notebook	DELL	D400	E2K24GBRL
Printer	EPSON	LQ-300	DoC
Modem	ACEEX	DM1414	IFAXDM1414
Wireless AP	Planex	GW-AP54SGX	N/A

3.8. Table for Parameters of Test Software Setting

During testing, Channel & Power Controlling Software provided by the customer was used to control the operating channel as well as the output power level. The RF output power selection is for the setting of RF output power expected by the customer and is going to be fixed on the firmware of the final end product.

Power Parameters of IEEE 802.11b/g

Test Software Version	ART		
Frequency	2412 MHz	2437 MHz	2462 MHz
IEEE 802.11b	17	17	17
IEEE 802.11g	14	14	14

An executive program, EMCTEST.EXE under WIN XP, which generates a complete line of continuously repeating " H " pattern was used as the test software.

The program was executed as follows:

- a. Turn on the power of all equipment.
- b. The NB sends " H " messages to the panel, and the panel displays " H " patterns on the screen.
- c. The NB sends " H " messages to the printer, then the printer prints them on the paper.
- d. The NB sends " H " messages to the modem.
- e. Repeat the steps from b to d.

At the same time, the following programs were executed:

Executed "ping.exe" to link with the remote workstation to receive and transmit data by LAN and WLAN.

Executed "ART" to control the EUT continuously transmit RF signal.

3.9. Test Configurations

3.9.1. Radiation Emissions Test Configuration

Test Configuration: 9kHz~1GHz

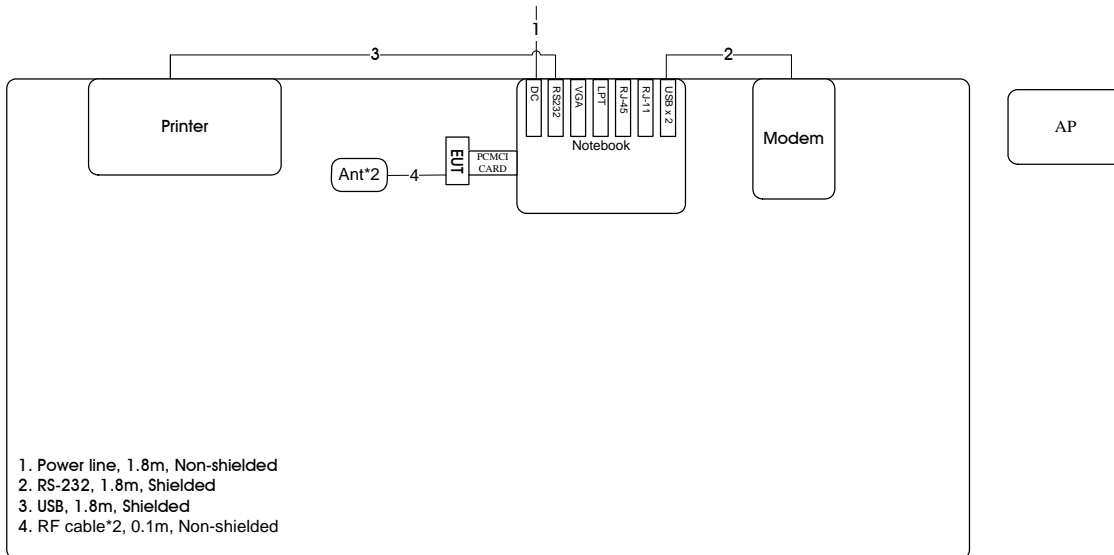

Test Configuration: Above 1GHz

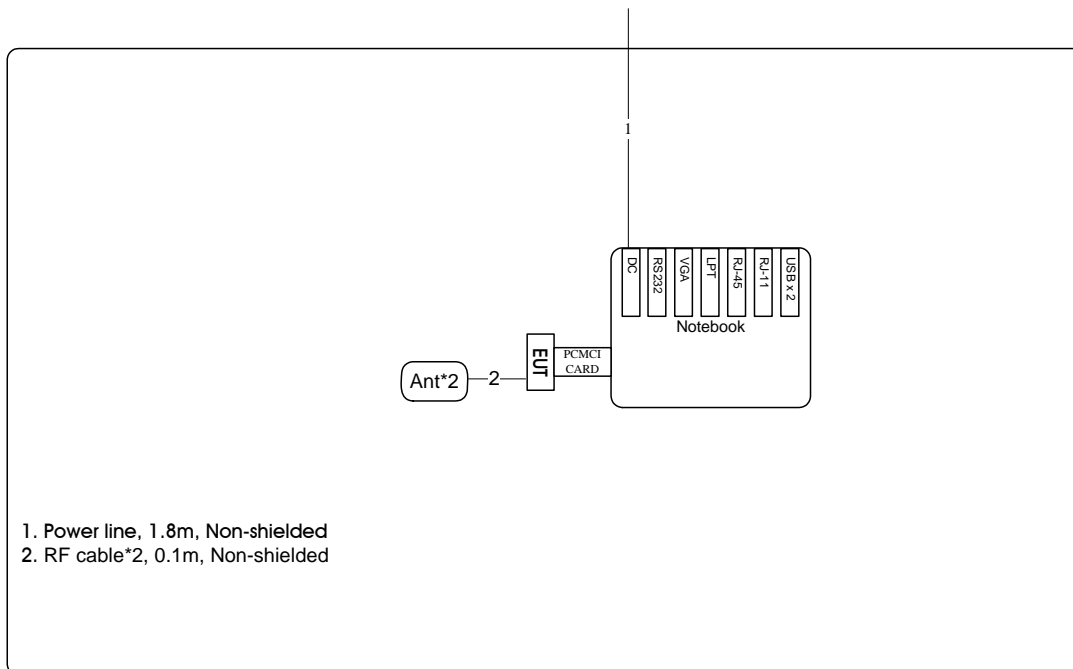

3.9.2. AC Power Line Conduction Emissions Test Configuration

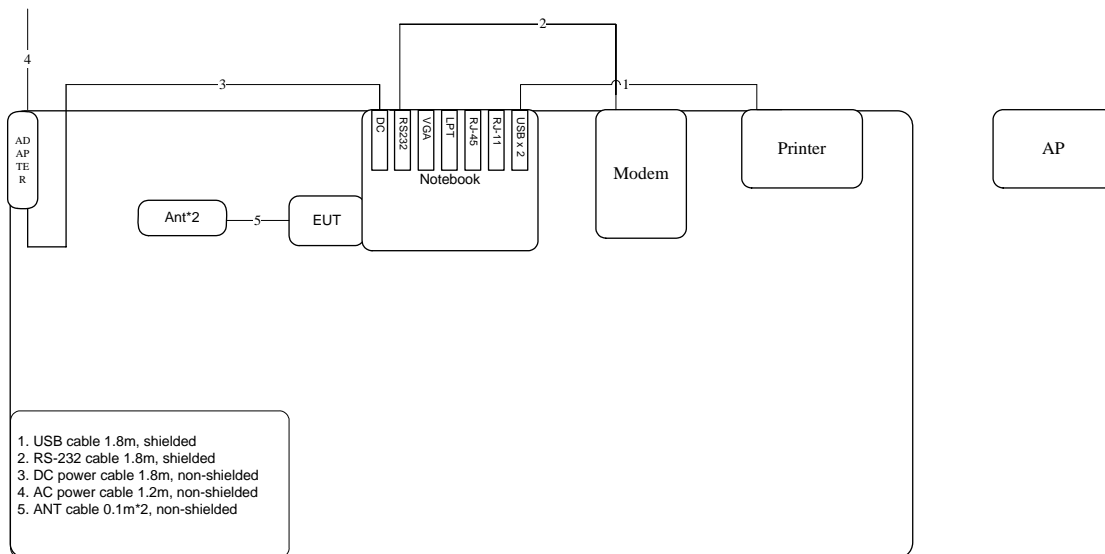

4. TEST RESULT

4.1. AC Power Line Conducted Emissions Measurement

4.1.1. Limit

For this product which is designed to be connected to the AC power line, the radio frequency voltage that is conducted back onto the AC power line on any frequency or frequencies within the band 150 kHz to 30 MHz shall not exceed below limits table.

Frequency (MHz)	QP Limit (dBuV)	AV Limit (dBuV)
0.15~0.5	66~56	56~46
0.5~5	56	46
5~30	60	50

4.1.2. Measuring Instruments and Setting

Please refer to section 5 of equipments list in this report. The following table is the setting of the receiver.

Receiver Parameters	Setting
Attenuation	10 dB
Start Frequency	0.15 MHz
Stop Frequency	30 MHz
IF Bandwidth	9 KHz

4.1.3. Test Procedures

1. Configure the EUT according to ANSI C63.4. The EUT or host of EUT has to be placed 0.4 meter far from the conducting wall of the shielding room and at least 80 centimeters from any other grounded conducting surface.
2. Connect EUT or host of EUT to the power mains through a line impedance stabilization network (LISN).
3. All the support units are connected to the other LISNs. The LISN should provide 50uH/50ohms coupling impedance.
4. The frequency range from 150 KHz to 30 MHz was searched.
5. Set the test-receiver system to Peak Detect Function and Specified Bandwidth with Maximum Hold Mode.
6. The measurement has to be done between each power line and ground at the power terminal.

4.1.4. Test Setup Layout

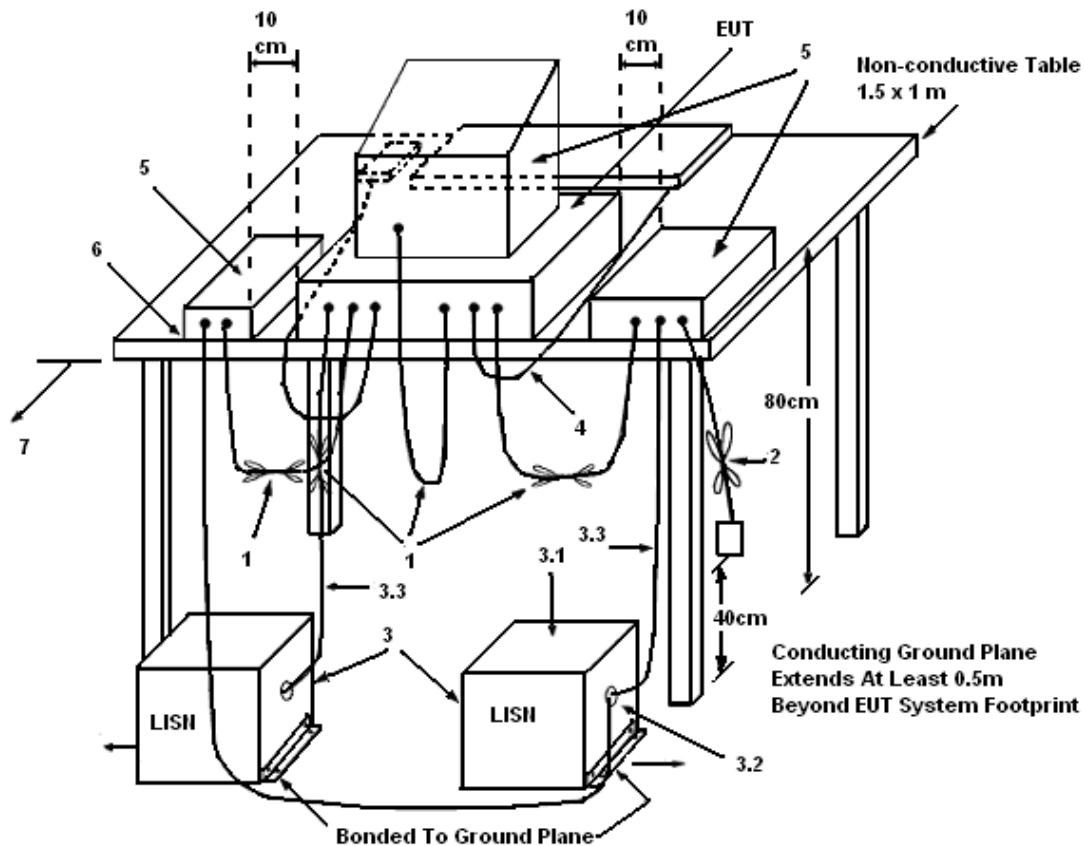

LEGEND:

- (1) Interconnecting cables that hang closer than 40 cm to the ground plane shall be folded back and forth in the center forming a bundle 30 to 40 cm long.
- (2) I/O cables that are not connected to a peripheral shall be bundled in the center. The end of the cable may be terminated, if required, using the correct terminating impedance. The overall length shall not exceed 1 m.
- (3) EUT connected to one LISN. Unused LISN measuring port connectors shall be terminated in 50Ω . LISN can be placed on top of, or immediately beneath, reference ground plane.
 - (3.1) All other equipment powered from additional LISN(s).
 - (3.2) Multiple outlet strip can be used for multiple power cords of non-EUT equipment.
 - (3.3) LISN at least 80 cm from nearest part of EUT chassis.
- (4) Cables of hand-operated devices, such as keyboards, mice, etc., shall be placed as for normal use.
- (5) Non-EUT components of EUT system being tested.
- (6) Rear of EUT, including peripherals, shall all be aligned and flush with rear of tabletop.
- (7) Rear of tabletop shall be 40 cm removed from a vertical conducting plane that is bonded to the ground plane.

4.1.5. Test Deviation

There is no deviation with the original standard.

4.1.6. EUT Operation during Test

The EUT was placed on the test table and programmed in normal function.

4.1.7. Results of AC Power Line Conducted Emissions Measurement

Temperature	26°C	Humidity	54%
Test Engineer	Cloud Deng	Phase	Line
Configuration	Normal Link		

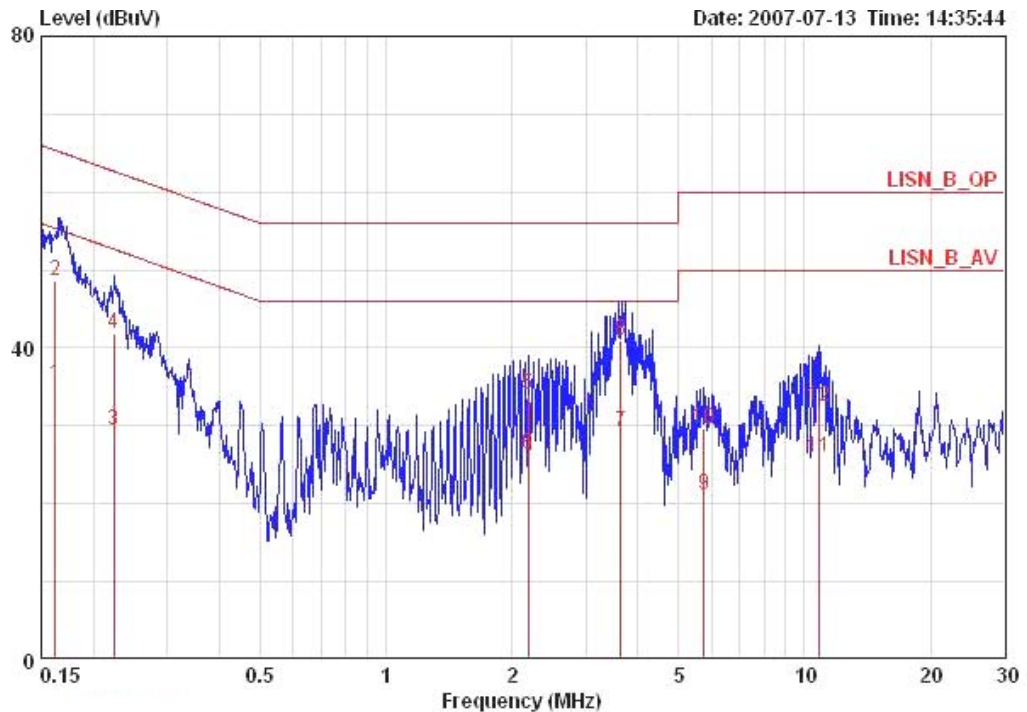

	Freq	Level	Over Limit	Limit Line	Read Level	LISN Factor	Cable Loss	Remark	Pol/Phase
	MHz	dBuV	dB	dBuV	dBuV	dB	dB		
1	0.16229	35.40	-19.94	55.35	35.03	0.17	0.20	AVERAGE	LINE
2	0.16229	48.69	-16.65	65.35	48.32	0.17	0.20	QP	LINE
3	0.22319	29.36	-23.34	52.70	29.08	0.08	0.20	AVERAGE	LINE
4	0.22319	41.90	-20.80	62.70	41.62	0.08	0.20	QP	LINE
5	2.184	33.94	-22.06	56.00	33.74	0.00	0.20	QP	LINE
6	2.184	26.30	-19.70	46.00	26.10	0.00	0.20	AVERAGE	LINE
7	3.644	29.12	-16.88	46.00	28.82	0.00	0.30	AVERAGE	LINE
8	3.644	41.08	-14.92	56.00	40.78	0.00	0.30	QP	LINE
9	5.764	21.14	-28.86	50.00	20.80	0.04	0.30	AVERAGE	LINE
10	5.764	29.56	-30.44	60.00	29.22	0.04	0.30	QP	LINE
11	10.790	25.84	-24.16	50.00	25.34	0.10	0.40	AVERAGE	LINE
12	10.790	32.43	-27.57	60.00	31.93	0.10	0.40	QP	LINE

Temperature	26°C	Humidity	54%
Test Engineer	Cloud Deng	Phase	Neutral
Configuration	Normal Link		

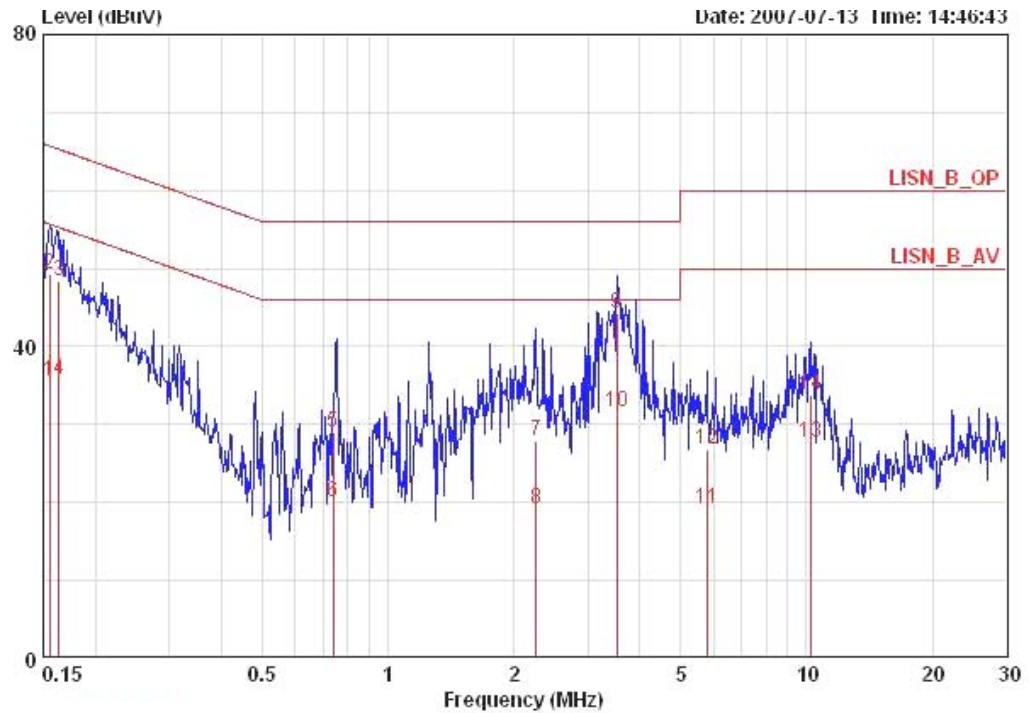

	Freq	Level	Over	Limit	Read	LISN	Cable	Remark	Pol/Phase
	MHz	dBuV	Limit	Line	Level	Factor	Loss		
			dB	dBuV	dBuV	dB	dB		
1	0.15567	35.54	-20.15	55.69	35.15	0.19	0.20	AVERAGE	NEUTRAL
2	0.15567	49.29	-16.40	65.69	48.90	0.19	0.20	QP	NEUTRAL
3	0.16327	48.47	-16.83	65.30	48.10	0.17	0.20	QP	NEUTRAL
4	0.16327	35.84	-19.46	55.30	35.47	0.17	0.20	AVERAGE	NEUTRAL
5	0.73853	28.99	-27.01	56.00	28.79	0.00	0.20	QP	NEUTRAL
6	0.73853	20.12	-25.88	46.00	19.92	0.00	0.20	AVERAGE	NEUTRAL
7	2.261	27.82	-28.18	56.00	27.62	0.00	0.20	QP	NEUTRAL
8	2.261	19.09	-26.91	46.00	18.89	0.00	0.20	AVERAGE	NEUTRAL
9	3.526	44.20	-11.80	56.00	43.90	0.00	0.30	QP	NEUTRAL
10	3.526	31.58	-14.42	46.00	31.28	0.00	0.30	AVERAGE	NEUTRAL
11	5.774	19.24	-30.76	50.00	18.90	0.04	0.30	AVERAGE	NEUTRAL
12	5.774	26.86	-33.14	60.00	26.52	0.04	0.30	QP	NEUTRAL
13	10.233	27.70	-22.30	50.00	27.26	0.10	0.34	AVERAGE	NEUTRAL
14	10.233	33.73	-26.27	60.00	33.29	0.10	0.34	QP	NEUTRAL

Note:

Level = Read Level + LISN Factor + Cable Loss.

4.2. Maximum Peak Output Power Measurement

4.2.1. Limit

For systems using digital modulation in the 2400-2483.5MHz, the limit for peak output power is 30dBm. The limited has to be reduced by the amount in dB that the gain of the antenna exceed 6dBi. In case of point-to-point operation, the limit has to be reduced by 1dB for every 3dB that the directional gain of the antenna exceeds 6dBi.

4.2.2. Measuring Instruments and Setting

Please refer to section 5 of equipments list in this report. The following table is the setting of the power meter.

Power Meter Parameter	Setting
Filter No.	Auto
Measurement time	0.135 s ~ 26 s
Used Peak Sensor	NRV-Z32 (model 04)

4.2.3. Test Procedures

1. The transmitter output (antenna port) was connected to the power meter.
2. Turn on the EUT and power meter and then record the peak power value.
3. Repeat above procedures on all channels needed to be tested.

4.2.4. Test Setup Layout

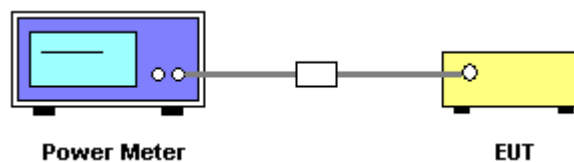

4.2.5. Test Deviation

There is no deviation with the original standard.

4.2.6. EUT Operation during Test

The EUT was programmed to be in continuously transmitting mode.

4.2.7. Test Result of Maximum Peak Output Power

Temperature	23°C	Humidity	62%
Test Engineer	Beck Wu	Configurations	802.11b/g

Configuration IEEE 802.11b

Channel	Frequency	Conducted Power (dBm)	Max. Limit (dBm)	Result
1	2412 MHz	16.92	30.00	Complies
6	2437 MHz	16.85	30.00	Complies
11	2462 MHz	16.55	30.00	Complies

Configuration IEEE 802.11g

Channel	Frequency	Conducted Power (dBm)	Max. Limit (dBm)	Result
1	2412 MHz	15.36	30.00	Complies
6	2437 MHz	15.33	30.00	Complies
11	2462 MHz	15.21	30.00	Complies

4.3. Power Spectral Density Measurement

4.3.1. Limit

For digitally modulated systems, the power spectral density conducted from the intentional radiator to the antenna shall not be greater than 8 dBm in any 3 kHz band during any time interval of continuous transmission.

4.3.2. Measuring Instruments and Setting

Please refer to section 5 of equipments list in this report. The following table is the setting of the spectrum analyzer.

Spectrum Parameter	Setting
Attenuation	Auto
Span Frequency	1.5MHz
RB	3 kHz
VB	30 kHz
Detector	Peak
Trace	Max Hold
Sweep Time	500s

4.3.3. Test Procedures

1. The transmitter output (antenna port) was connected to the spectrum analyser.
2. Set RBW of spectrum analyzer to 3kHz and VBW to 30kHz. Set Detector to Peak, Trace to Max Hold.
3. Mark the frequency with maximum peak power as the center of the display of the spectrum.
4. Set the span to 1.5MHz and the sweep time to 500s and record the maximum peak value.

4.3.4. Test Setup Layout

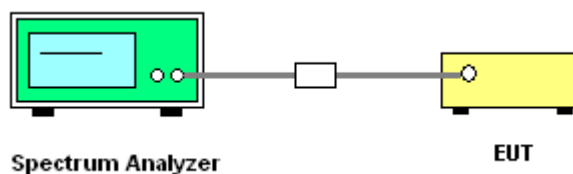

4.3.5. Test Deviation

There is no deviation with the original standard.

4.3.6. EUT Operation during Test

The EUT was programmed to be in continuously transmitting mode.

4.3.7. Test Result of Power Spectral Density

Temperature	23°C	Humidity	62%
Test Engineer	Beck Wu	Configurations	802.11b/g

Configuration IEEE 802.11b

Channel	Frequency	Power Density (dBm)	Max. Limit (dBm)	Result
1	2412 MHz	-7.71	8.00	Complies
6	2437 MHz	-7.45	8.00	Complies
11	2462 MHz	-8.34	8.00	Complies

Configuration IEEE 802.11g

Channel	Frequency	Power Density (dBm)	Max. Limit (dBm)	Result
1	2412 MHz	-11.86	8.00	Complies
6	2437 MHz	-12.66	8.00	Complies
11	2462 MHz	-12.98	8.00	Complies

Power Density Plot on Configuration IEEE 802.11b / 2412 MHz

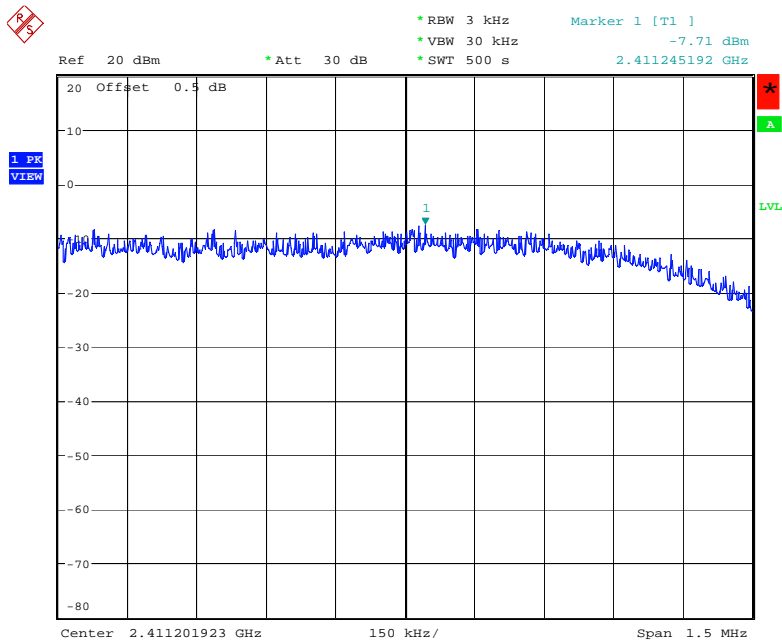

Date: 12.JUL.2007 19:30:45

Power Density Plot on Configuration IEEE 802.11b / 2437 MHz

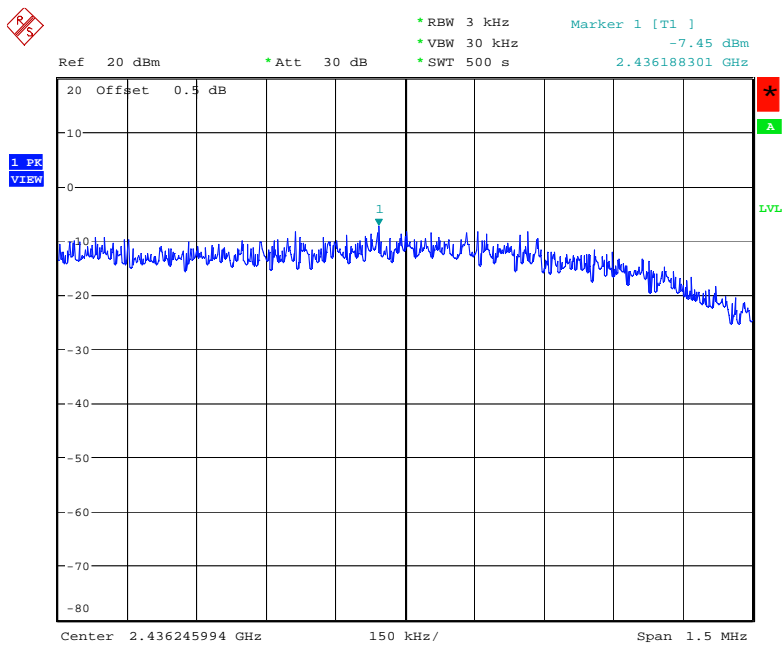

Date: 12.JUL.2007 19:29:52

Power Density Plot on Configuration IEEE 802.11b / 2462 MHz

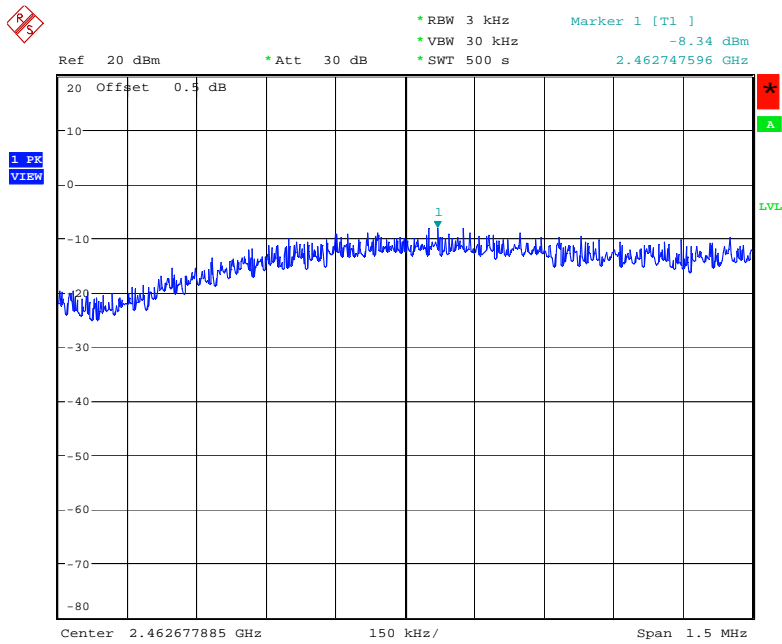

Date: 12.JUL.2007 19:28:22

Power Density Plot on Configuration IEEE 802.11g / 2412 MHz

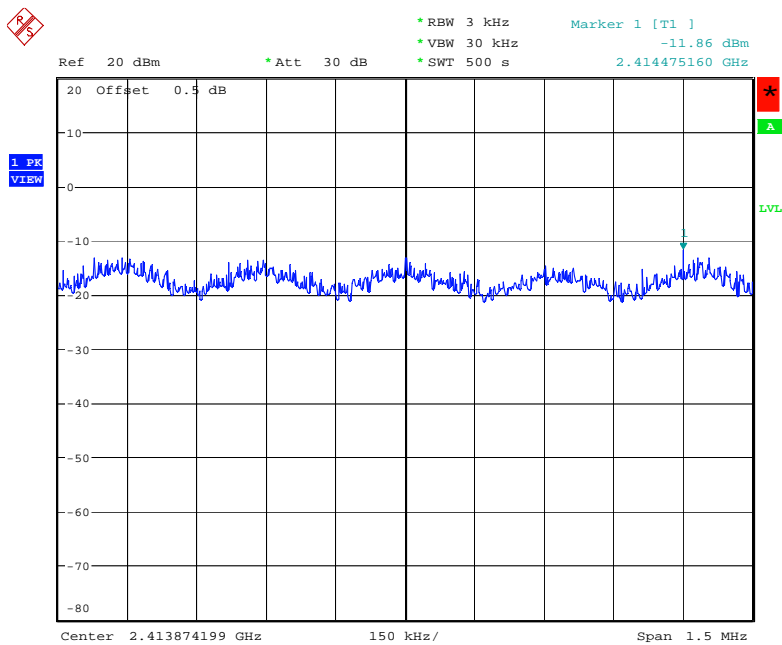

Date: 12.JUL.2007 19:25:27

Power Density Plot on Configuration IEEE 802.11g / 2437 MHz

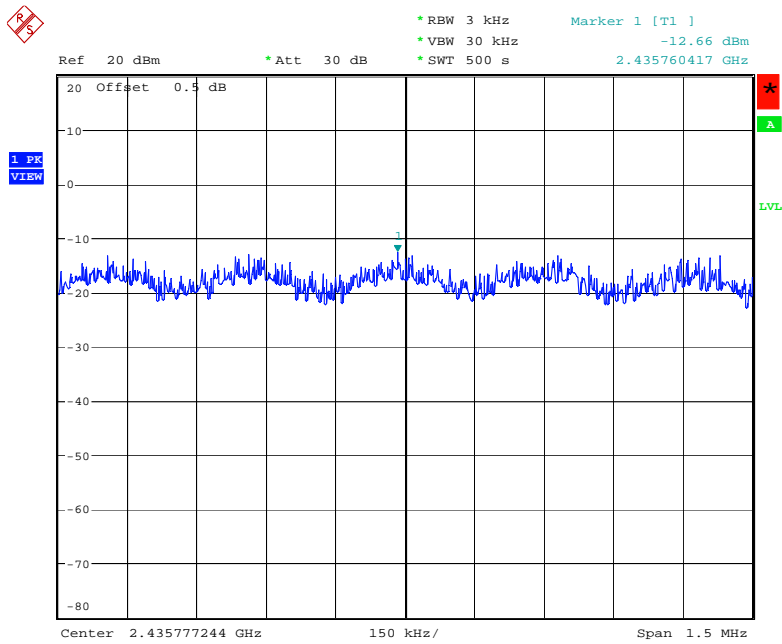

Date: 12.JUL.2007 19:26:26

Power Density Plot on Configuration IEEE 802.11g / 2462 MHz

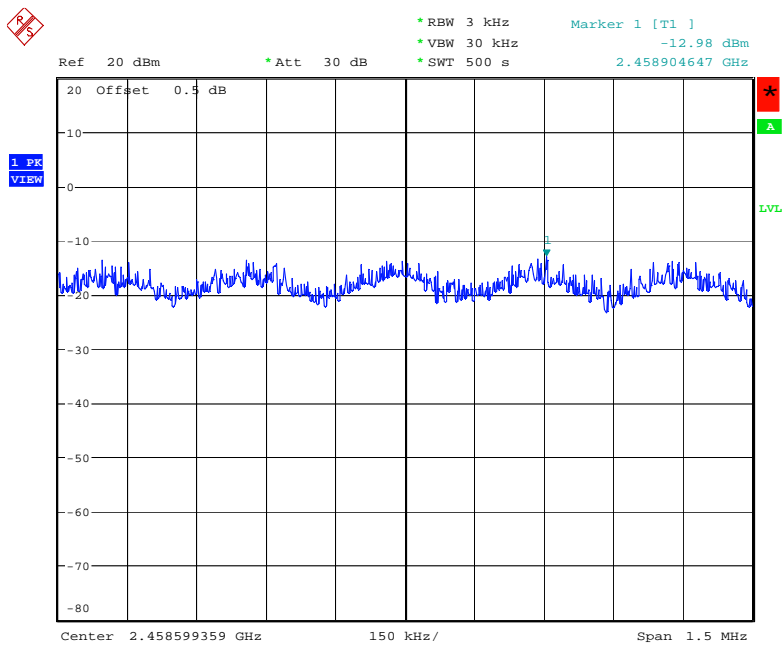

Date: 12.JUL.2007 19:27:09

4.4. 6dB Spectrum Bandwidth Measurement

4.4.1. Limit

For digital modulation systems, the minimum 6dB bandwidth shall be at least 500 kHz.

4.4.2. Measuring Instruments and Setting

Please refer to section 5 of equipments list in this report. The following table is the setting of the spectrum analyzer.

Spectrum Parameters	Setting
Attenuation	Auto
Span Frequency	> 6dB Bandwidth
RB	100 kHz
VB	100 kHz
Detector	Peak
Trace	Max Hold
Sweep Time	Auto

4.4.3. Test Procedures

1. The transmitter output (antenna port) was connected to the spectrum analyser in peak hold mode.
2. The resolution bandwidth of 100 kHz and the video bandwidth of 100 kHz were used.
3. Measured the spectrum width with power higher than 6dB below carrier.

4.4.4. Test Setup Layout

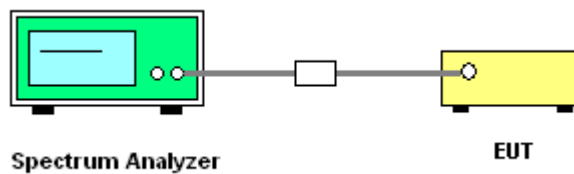

4.4.5. Test Deviation

There is no deviation with the original standard.

4.4.6. EUT Operation during Test

The EUT was programmed to be in continuously transmitting mode.

4.4.7. Test Result of 6dB Spectrum Bandwidth

Temperature	23°C	Humidity	62%
Test Engineer	Beck Wu	Configurations	802.11b/g

Configuration IEEE 802.11b

Channel	Frequency	6dB Bandwidth (MHz)	99% Occupied Bandwidth (MHz)	Min. Limit (kHz)	Test Result
1	2412 MHz	12.01	15.44	500	Complies
6	2437 MHz	12.01	15.41	500	Complies
11	2462 MHz	12.05	15.41	500	Complies

Configuration IEEE 802.11g

Channel	Frequency	6dB Bandwidth (MHz)	99% Occupied Bandwidth (MHz)	Min. Limit (kHz)	Test Result
1	2412 MHz	16.02	16.53	500	Complies
6	2437 MHz	16.31	16.50	500	Complies
11	2462 MHz	16.05	16.50	500	Complies

6 dB Bandwidth Plot on Configuration IEEE 802.11b / 2412 MHz

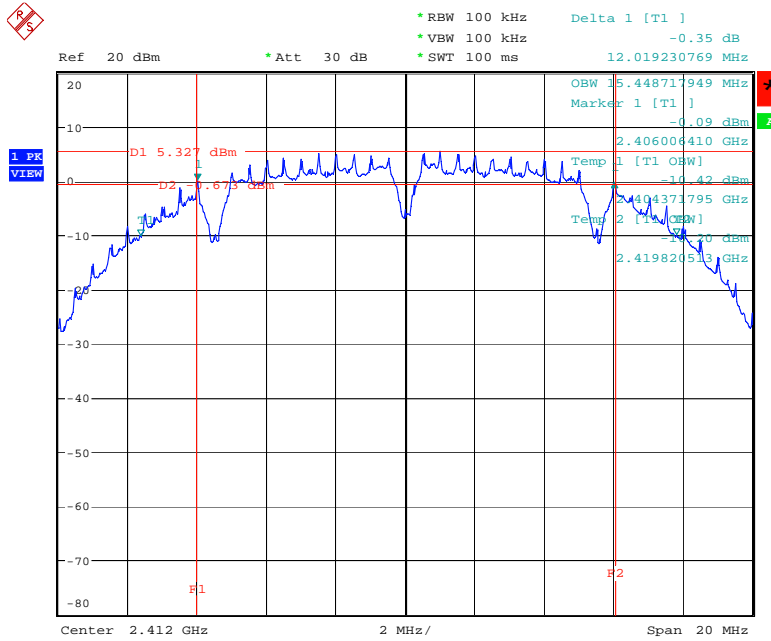

Date: 12.JUL.2007 19:30:20

6 dB Bandwidth Plot on Configuration IEEE 802.11b / 2437 MHz

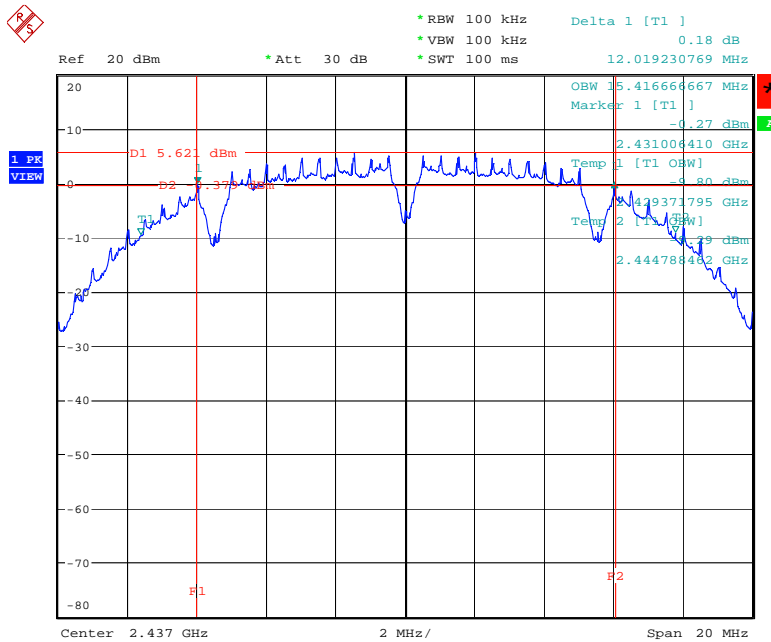

Date: 12.JUL.2007 19:29:35

6 dB Bandwidth Plot on Configuration IEEE 802.11b / 2462 MHz

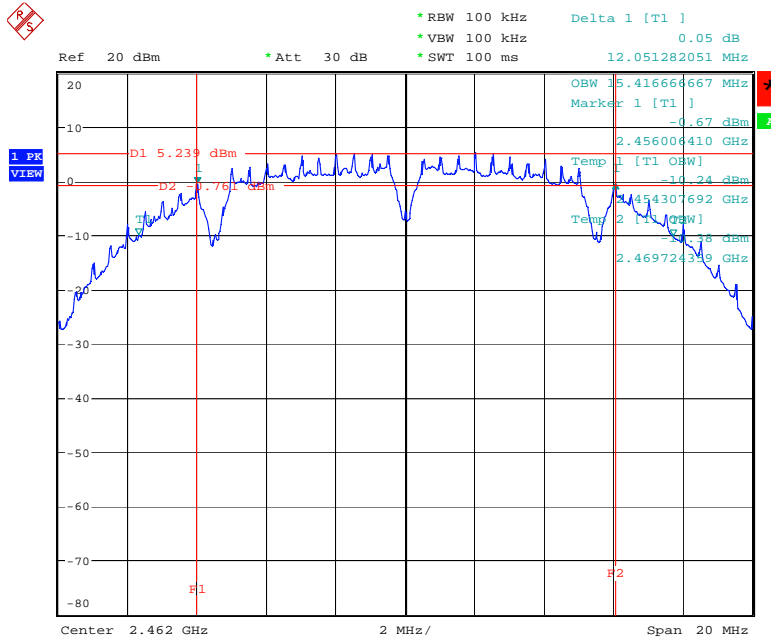

Date: 12.JUL.2007 19:28:07

6 dB Bandwidth Plot on Configuration IEEE 802.11g / 2412 MHz

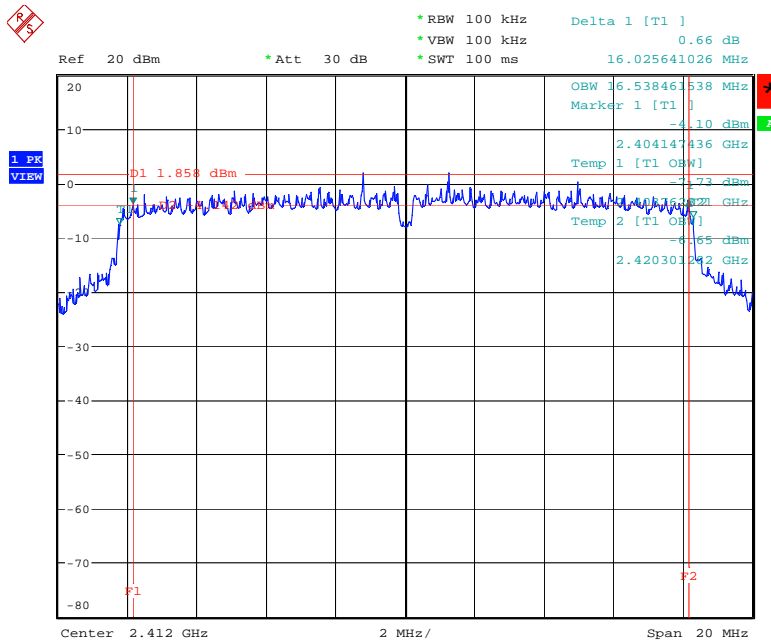

Date: 12.JUL.2007 19:25:01

6 dB Bandwidth Plot on Configuration IEEE 802.11g / 2437 MHz

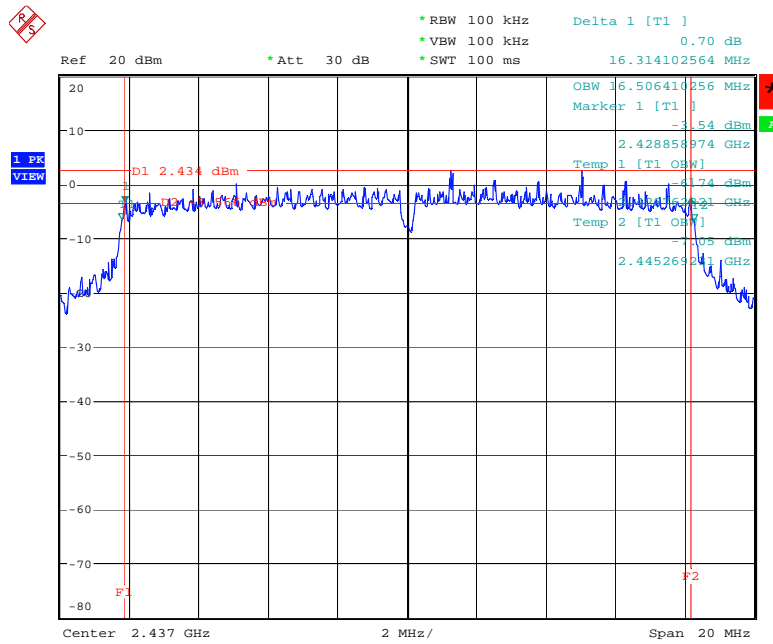

Date: 12.JUL.2007 19:26:09

6 dB Bandwidth Plot on Configuration IEEE 802.11g / 2462 MHz

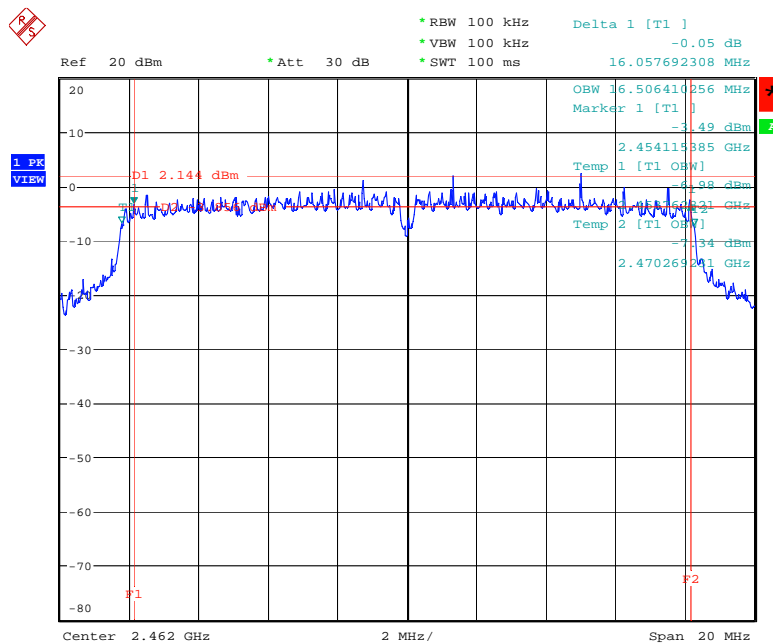

Date: 12.JUL.2007 19:26:54

4.5. Radiated Emissions Measurement

4.5.1. Limit

20dBc in any 100 kHz bandwidth outside the operating frequency band. In case the emission fall within the restricted band specified on 15.205(a), then the 15.209(a) limit in the table below has to be followed.

Frequencies (MHz)	Field Strength (micorvolts/meter)	Measurement Distance (meters)
0.009~0.490	2400/F(KHz)	300
0.490~1.705	24000/F(KHz)	30
1.705~30.0	30	30
30~88	100	3
88~216	150	3
216~960	200	3
Above 960	500	3

4.5.2. Measuring Instruments and Setting

Please refer to section 5 of equipments list in this report. The following table is the setting of spectrum analyzer and receiver.

Spectrum Parameter	Setting
Attenuation	Auto
Start Frequency	1000 MHz
Stop Frequency	10th carrier harmonic
RB / VB (Emission in restricted band)	1MHz / 1MHz for Peak, 1 MHz / 10Hz for Average
RB / VB (Emission in non-restricted band)	100KHz / 100KHz for peak

Receiver Parameter	Setting
Attenuation	Auto
Start ~ Stop Frequency	9kHz~150kHz / RB 200Hz for QP
Start ~ Stop Frequency	150kHz~30MHz / RB 9kHz for QP
Start ~ Stop Frequency	30MHz~1000MHz / RB 120kHz for QP

4.5.3. Test Procedures

1. Configure the EUT according to ANSI C63.4. The EUT was placed on the top of the turntable 0.8 meter above ground. The phase center of the receiving antenna mounted on the top of a height-variable antenna tower was placed 3 meters far away from the turntable.
2. Power on the EUT and all the supporting units. The turntable was rotated by 360 degrees to determine the position of the highest radiation.
3. The height of the broadband receiving antenna was varied between one meter and four meters above ground to find the maximum emissions field strength of both horizontal and vertical polarization.
4. For each suspected emissions, the antenna tower was scan (from 1 M to 4 M) and then the turntable was rotated (from 0 degree to 360 degrees) to find the maximum reading.
5. Set the test-receiver system to Peak or CISPR quasi-peak Detect Function with specified bandwidth under Maximum Hold Mode.
6. For emissions above 1GHz, use 1MHz VBW and RBW for peak reading. Then 1MHz RBW and 10Hz VBW for average reading in spectrum analyzer.
7. When the radiated emissions limits are expressed in terms of the average value of the emissions, and pulsed operation is employed, the measurement field strength shall be determined by averaging over one complete pulse train, including blanking intervals, as long as the pulse train does not exceed 0.1 seconds. As an alternative (provided the transmitter operates for longer than 0.1 seconds) or in cases where the pulse train exceeds 0.1 seconds, the measured field strength shall be determined from the average absolute voltage during a 0.1 second interval during which the field strength is at its maximum value.
8. If the emissions level of the EUT in peak mode was 3 dB lower than the average limit specified, then testing will be stopped and peak values of EUT will be reported, otherwise, the emissions which do not have 3 dB margin will be repeated one by one using the quasi-peak method for below 1GHz.
9. For testing above 1GHz, the emissions level of the EUT in peak mode was lower than average limit (that means the emissions level in peak mode also complies with the limit in average mode), then testing will be stopped and peak values of EUT will be reported, otherwise, the emissions will be measured in average mode again and reported.
10. In case the emission is lower than 30MHz, loop antenna has to be used for measurement and the recorded data should be QP measured by receiver. High – Low scan is not required in this case.

4.5.4. Test Setup Layout

For radiated emissions below 30MHz

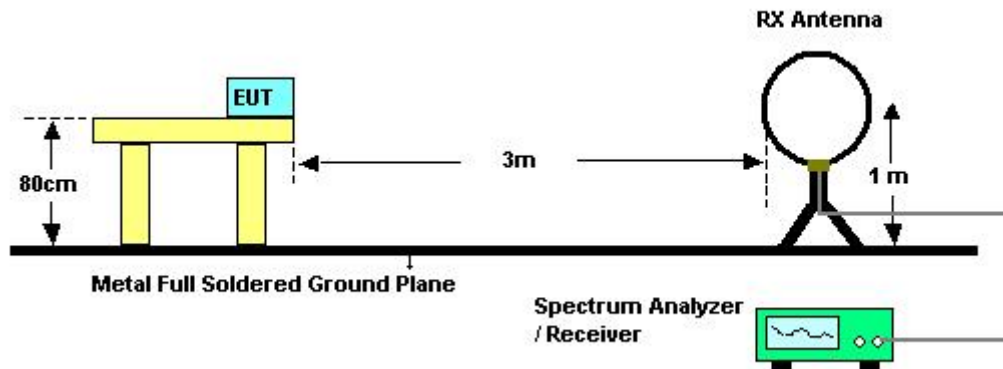

For radiated emissions above 30MHz

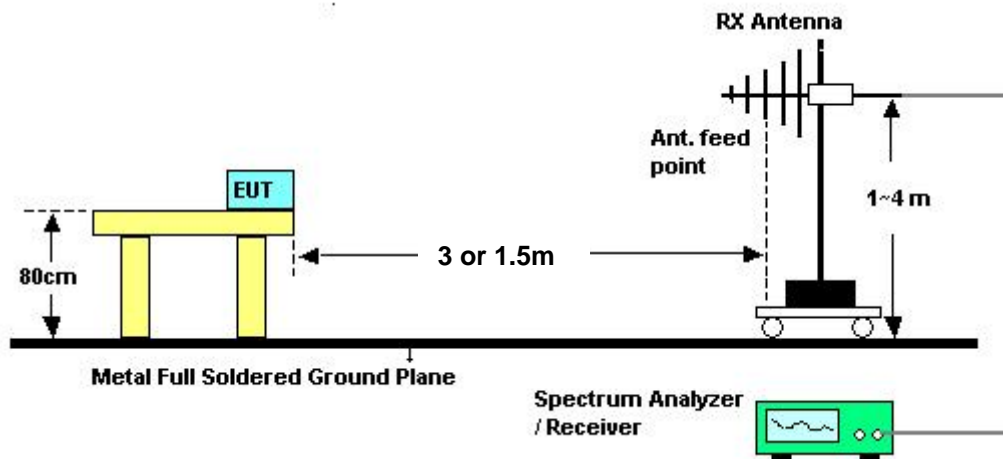

Above 10 GHz shall be extrapolated to the specified distance using an extrapolation factor of 20 dB/decade from 3m to 1.5m.

Distance extrapolation factor = $20 \log (\text{specific distance [3m]} / \text{test distance [1.5m]})$ (dB);

Limit line = specific limits (dBuV) + distance extrapolation factor [6 dB].

4.5.5. Test Deviation

There is no deviation with the original standard.

4.5.6. EUT Operation during Test

The EUT was programmed to be in continuously transmitting mode.

4.5.7. Results of Radiated Emissions (9kHz~30MHz)

Temperature	23°C	Humidity	62%
Test Engineer	Jacky Ho		

Freq. (MHz)	Level (dBuV)	Over Limit (dB)	Limit Line (dBuV)	Remark
-	-	-	-	See Note

Note:

The amplitude of spurious emissions that are attenuated by more than 20 dB below the permissible value has no need to be reported.

Distance extrapolation factor = $40 \log(\text{specific distance} / \text{test distance})$ (dB);

Limit line = specific limits (dBuV) + distance extrapolation factor.

4.5.8. Results of Radiated Emissions (30MHz~1GHz)

Temperature	23°C	Humidity	62%
Test Engineer	Jacky Ho	Configurations	802.11g CH 6

Horizontal

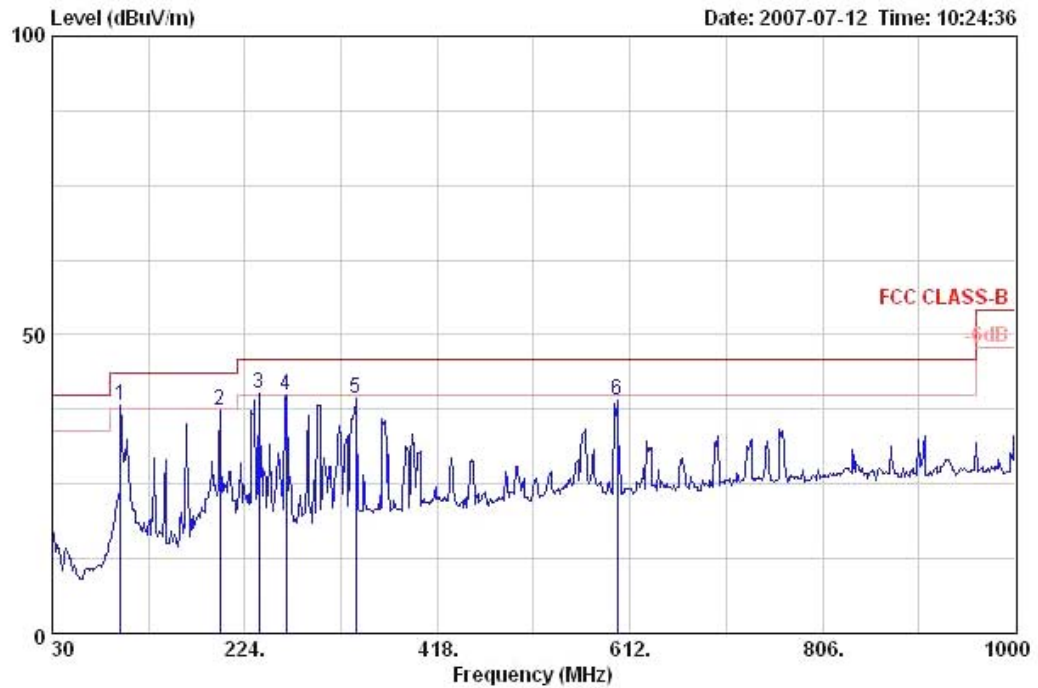

	Freq	Level	Over	Read	Antenna	Preamp	Cable	Table	Ant	Remark
	MHz	dBuV/m	Limit	Level	Factor	Factor	Loss	Pos	Pos	
			dB	dBuV	dB/m	dB	dB	deg	cm	
1 !	98.870	38.04	-5.46	54.29	10.10	27.44	1.08	0	100	Peak
2	198.780	37.23	-6.27	53.60	8.90	26.71	1.44	0	100	Peak
3 !	238.550	40.23	-5.77	54.49	10.63	26.51	1.62	0	100	Peak
4	265.710	39.77	-6.23	51.98	12.45	26.48	1.81	0	100	Peak
5	335.550	39.29	-6.71	50.06	13.98	26.63	1.88	0	100	Peak
6	599.390	38.96	-7.04	45.88	18.33	27.11	1.86	0	100	Peak

Vertical

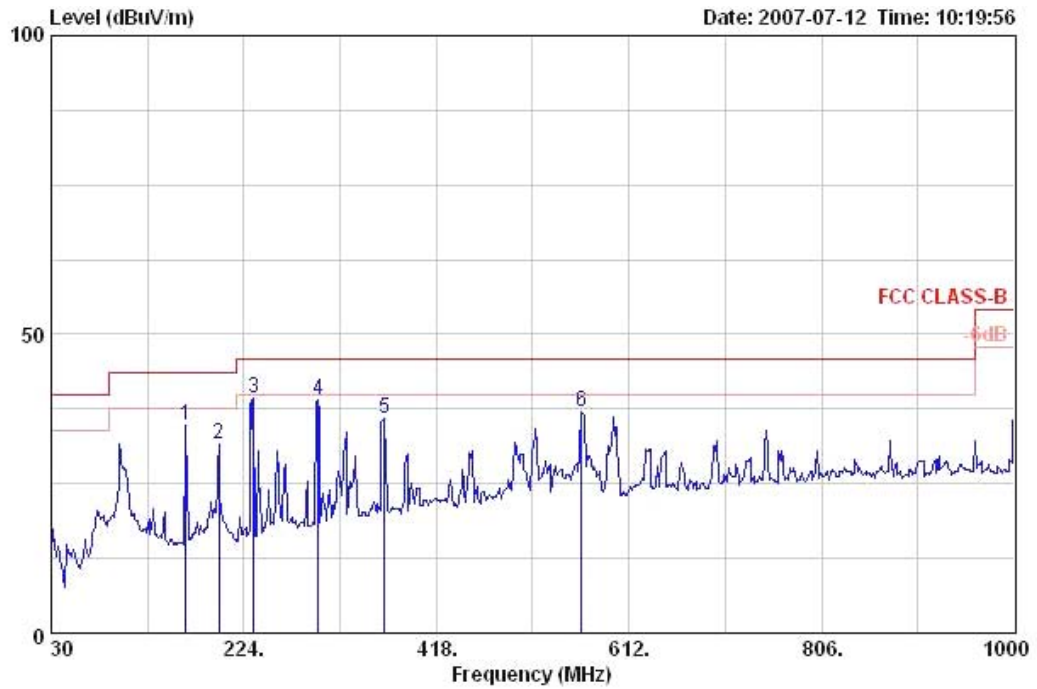

	Freq	Level	Over Limit	Read Level	Antenna Factor	Preamp Factor	Cable Loss	Table Pos	Ant Pos	Remark
	MHz	dBuV/m	dB	dBuV	dB/m	dB	dB	deg	cm	
1	165.800	34.68	-8.82	51.48	8.82	27.02	1.40	0	400	Peak
2	198.780	31.69	-11.81	48.06	8.90	26.71	1.44	0	400	Peak
3	233.700	39.43	-6.57	54.32	10.04	26.52	1.58	0	400	Peak
4	298.690	39.01	-6.99	50.78	12.88	26.07	1.42	0	400	Peak
5	365.620	35.96	-10.04	46.41	14.58	26.78	1.75	0	400	Peak
6	564.470	37.11	-8.89	43.73	18.60	27.42	2.21	0	400	Peak

Note:

The amplitude of spurious emissions that are attenuated by more than 20dB below the permissible value has no need to be reported.

Emission level (dBUV/m) = 20 log Emission level (uV/m).

Corrected Reading: Antenna Factor + Cable Loss + Read Level - Preamp Factor = Level.

4.5.9. Results for Radiated Emissions (1GHz~10th Harmonic)

Temperature	23°C	Humidity	62%
Test Engineer	Jacky Ho	Configurations	802.11b CH 1

Horizontal

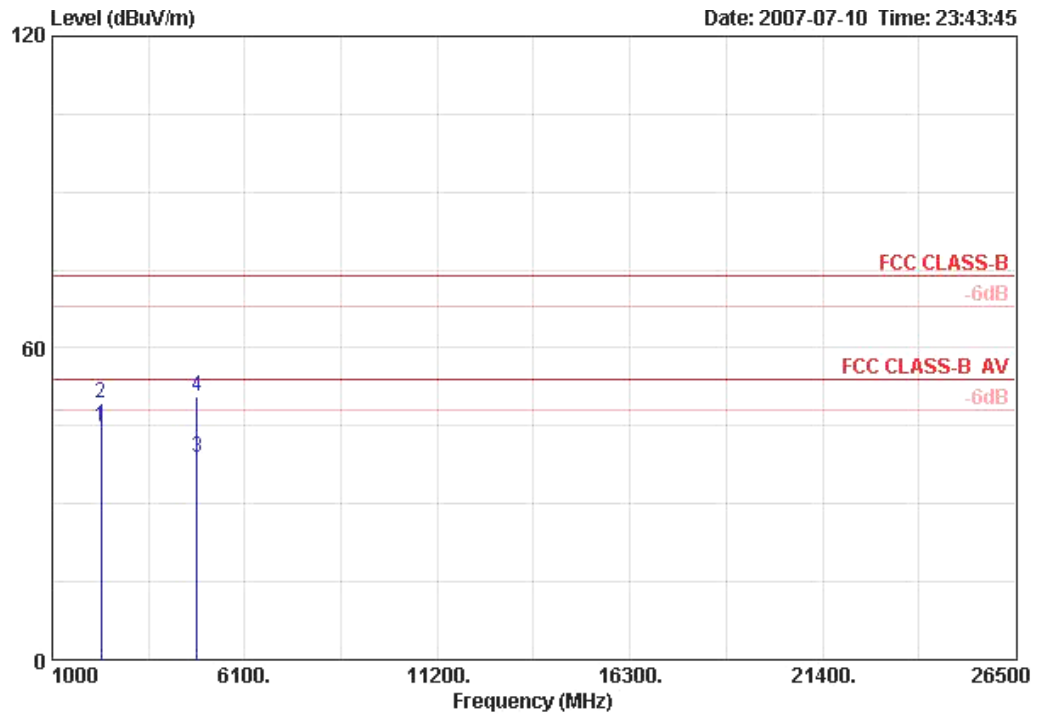

	Freq	Level	Over Limit	Limit Line	Read Level	Antenna Factor	Cable Loss	Preamp Factor	Remark	Ant Pos	Table Pos
	MHz	dBuV/m	dB	dBuV/m	dBuV	dB/m	dB	dB		cm	deg
1	2288.000	44.74	-9.26	54.00	45.79	27.94	6.06	35.05	AVERAGE	104	37
2	2288.000	49.49	-24.51	74.00	50.54	27.94	6.06	35.05	PEAK	104	37
3	4823.990	39.01	-14.99	54.00	32.17	33.06	8.95	35.16	AVERAGE	100	330
4	4823.990	50.76	-23.24	74.00	43.92	33.06	8.95	35.16	PEAK	100	330

Vertical

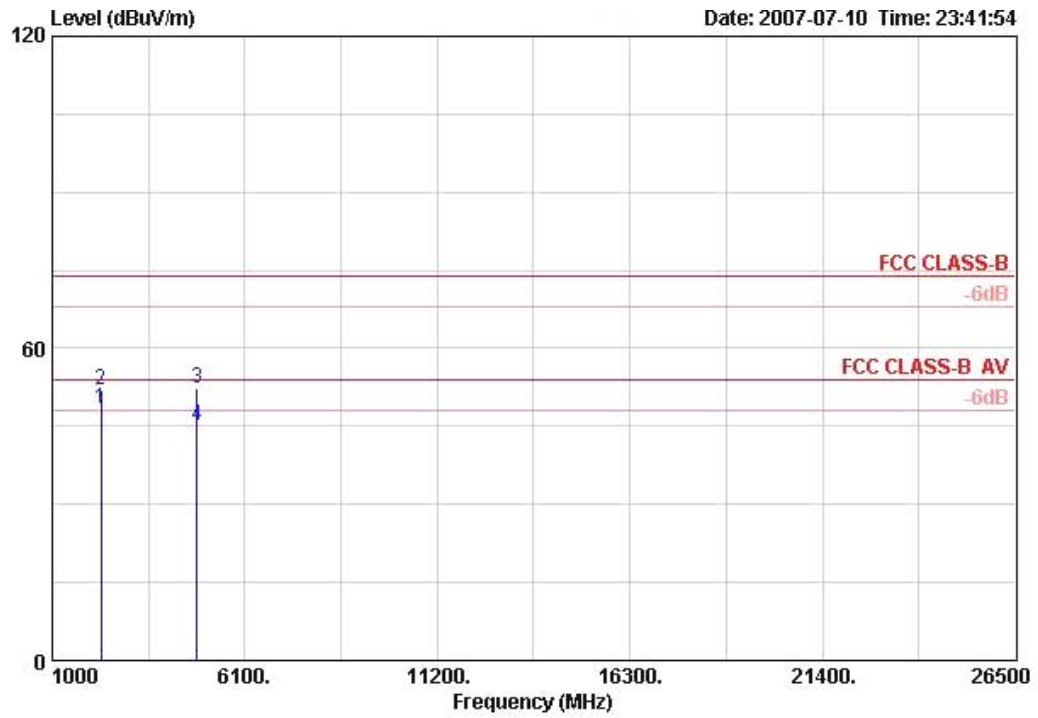

	Freq	Level	Over Limit	Limit Line	Read Level	Antenna Factor	Cable Loss	Preamp Factor	Remark	Ant Pos	Table Pos
	MHz	dBUV/m	dB	dBUV/m	dBuV	dB/m	dB	dB		cm	deg
1 @	2288.020	48.38	-5.62	54.00	49.43	27.94	6.06	35.05	AVERAGE	100	207
2	2288.160	51.99	-22.01	74.00	53.04	27.94	6.06	35.05	PEAK	100	207
3	4823.970	52.38	-21.62	74.00	45.55	33.06	8.95	35.16	PEAK	100	330
4	4824.010	45.08	-8.92	54.00	38.25	33.06	8.95	35.16	AVERAGE	100	330

Temperature	23°C	Humidity	62%
Test Engineer	Jacky Ho	Configurations	802.11b CH 6

Horizontal

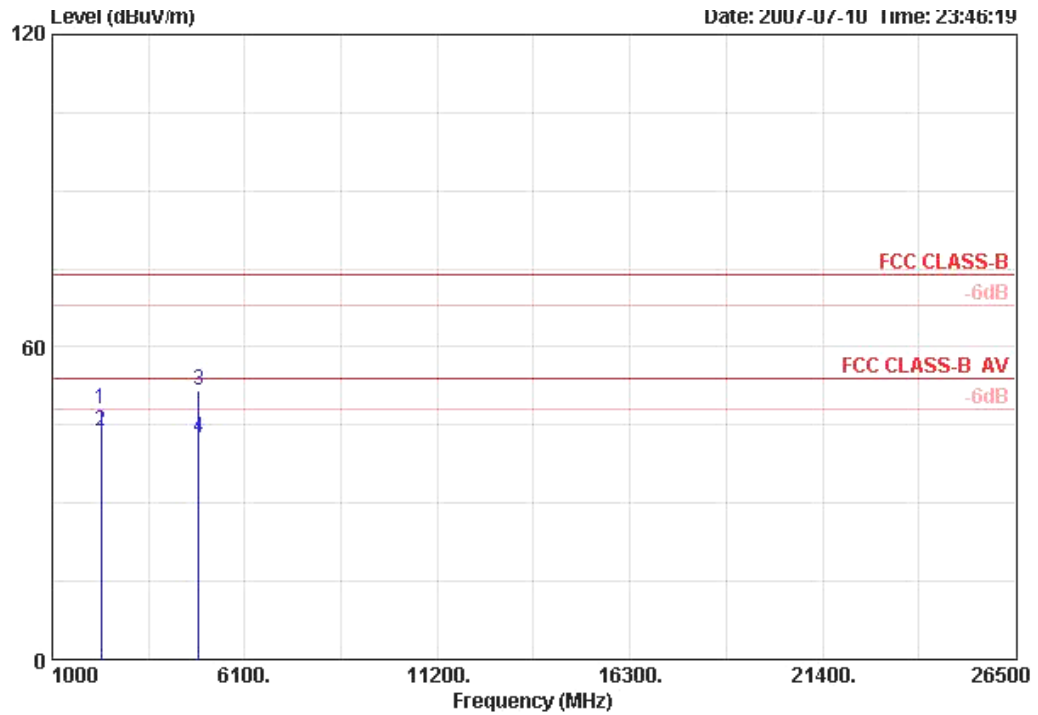

	Freq	Level	Over Limit	Limit Line	ReadAntenna Level	Antenna Factor	Cable Loss	Preamp Factor	Remark	Ant Pos	Table Pos
	MHz	dBUV/m	dB	dBUV/m	dBuV	dB/m	dB	dB		cm	deg
1	2287.640	48.01	-25.99	74.00	49.07	27.94	6.03	35.04	PEAK	107	224
2	2288.000	43.94	-10.06	54.00	44.99	27.94	6.06	35.05	AVERAGE	107	224
3	4873.870	51.61	-22.39	74.00	44.60	33.16	9.01	35.15	PEAK	100	328
4	4873.970	42.57	-11.43	54.00	35.55	33.16	9.01	35.15	AVERAGE	100	328

Vertical

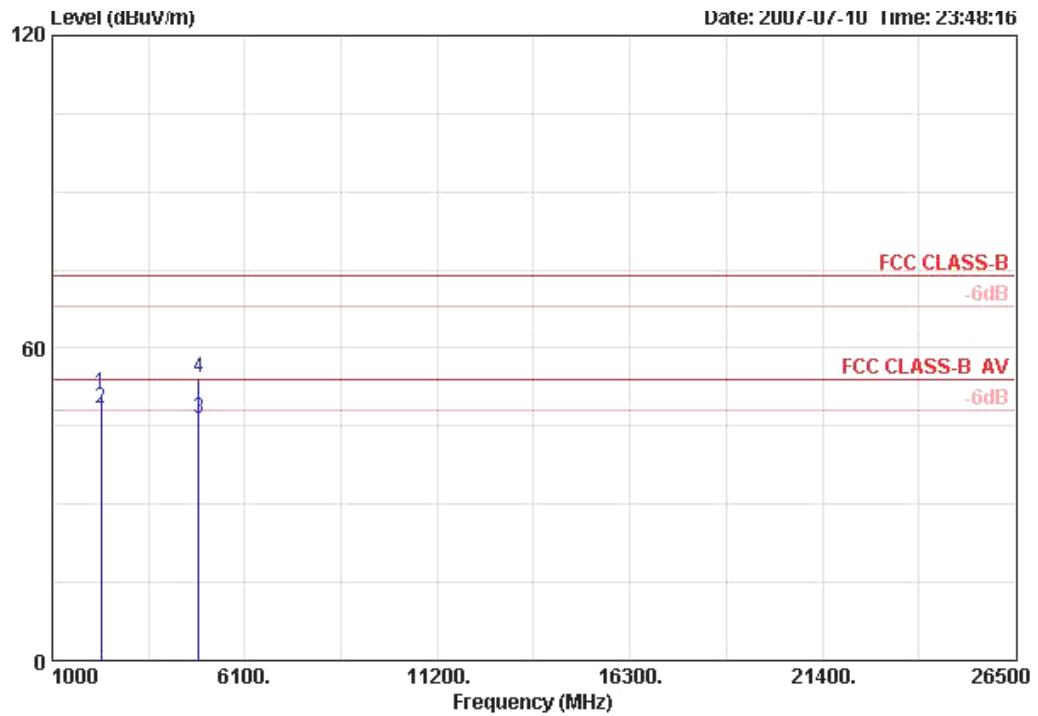

	Freq	Level	Over Limit	Limit Line	Read Level	Antenna Factor	Cable Loss	Preamp Factor	Remark	Ant Pos	Table Pos
	MHz	dBuV/m	dB	dBuV/m	dBuV	dB/m	dB	dB		cm	deg
1	2288.000	51.26	-22.74	74.00	52.31	27.94	6.06	35.05	PEAK	100	276
2 @	2288.040	48.48	-5.52	54.00	49.53	27.94	6.06	35.05	AVERAGE	100	276
3	4874.050	46.34	-7.66	54.00	39.32	33.16	9.01	35.15	AVERAGE	100	330
4	4874.170	54.13	-19.87	74.00	47.12	33.16	9.01	35.15	PEAK	100	330

Temperature	23°C	Humidity	62%
Test Engineer	Jacky Ho	Configurations	802.11b CH 11

Horizontal

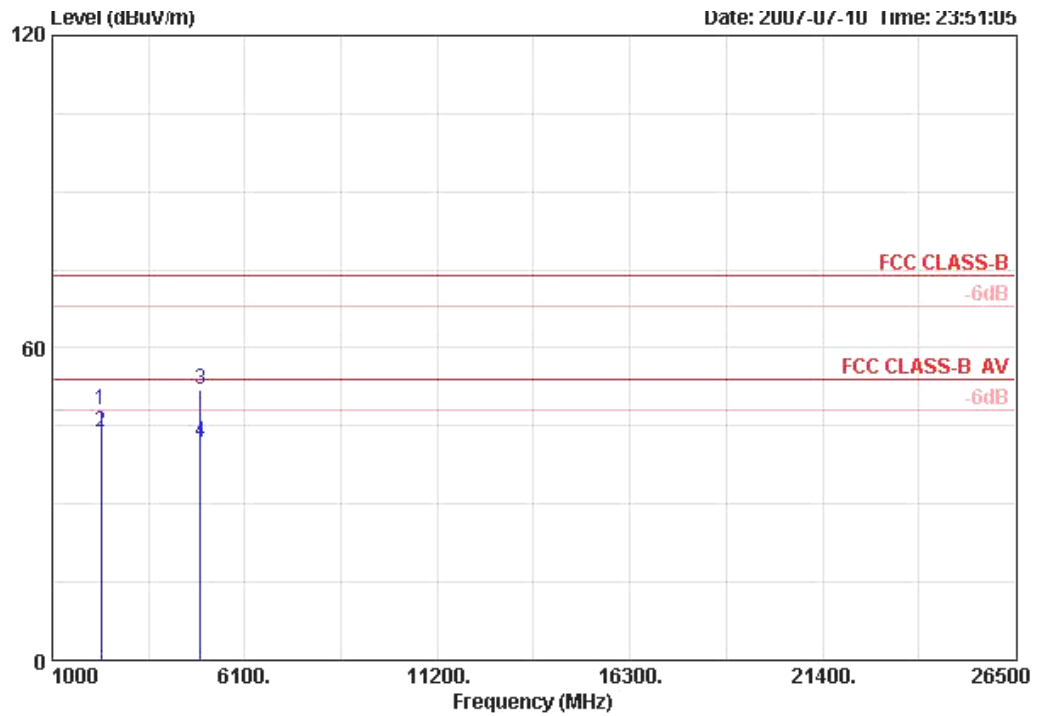

	Freq	Level	Over Limit	Limit Line	ReadAntenna Level	Antenna Factor	Cable Loss	Preamp Factor	Remark	Ant Pos	Table Pos
	MHz	dBuV/m	dB	dBuV/m	dBuV	dB/m	dB	dB		cm	deg
1	2287.760	48.15	-25.85	74.00	49.20	27.94	6.06	35.05	PEAK	106	44
2	2287.980	43.69	-10.31	54.00	44.74	27.94	6.06	35.05	AVERAGE	106	44
3	4923.880	51.89	-22.11	74.00	44.70	33.26	9.07	35.14	PEAK	100	338
4	4924.030	41.94	-12.06	54.00	34.75	33.26	9.07	35.14	AVERAGE	100	338

Vertical

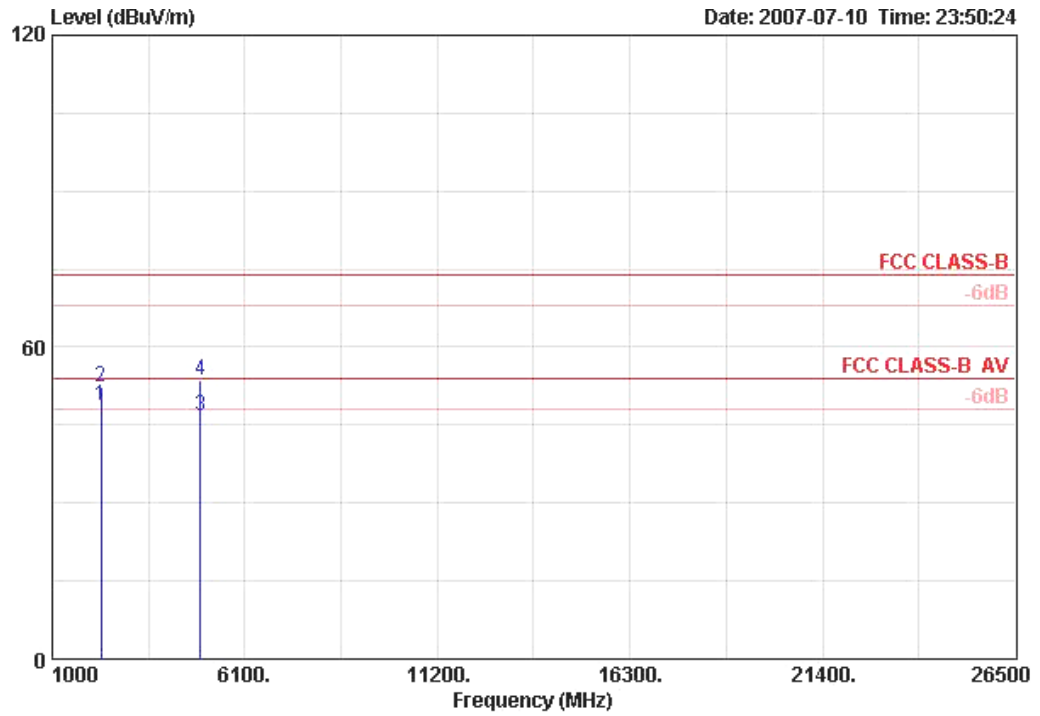

	Freq	Level	Over Limit	Limit Line	Read Level	Antenna Factor	Cable Loss	Preamp Factor	Remark	Ant Pos	Table Pos
	MHz	dBuV/m	dB	dBuV/m	dBuV	dB/m	dB	dB		cm	deg
1 @	2287.980	48.73	-5.27	54.00	49.78	27.94	6.06	35.05	AVERAGE	100	192
2	2288.180	52.25	-21.75	74.00	53.30	27.94	6.06	35.05	PEAK	100	192
3	4924.050	46.72	-7.28	54.00	39.53	33.26	9.07	35.14	AVERAGE	100	328
4	4924.140	53.55	-20.45	74.00	46.36	33.26	9.07	35.14	PEAK	100	328

Temperature	23°C	Humidity	62%
Test Engineer	Jacky Ho	Configurations	802.11g CH 1

Horizontal

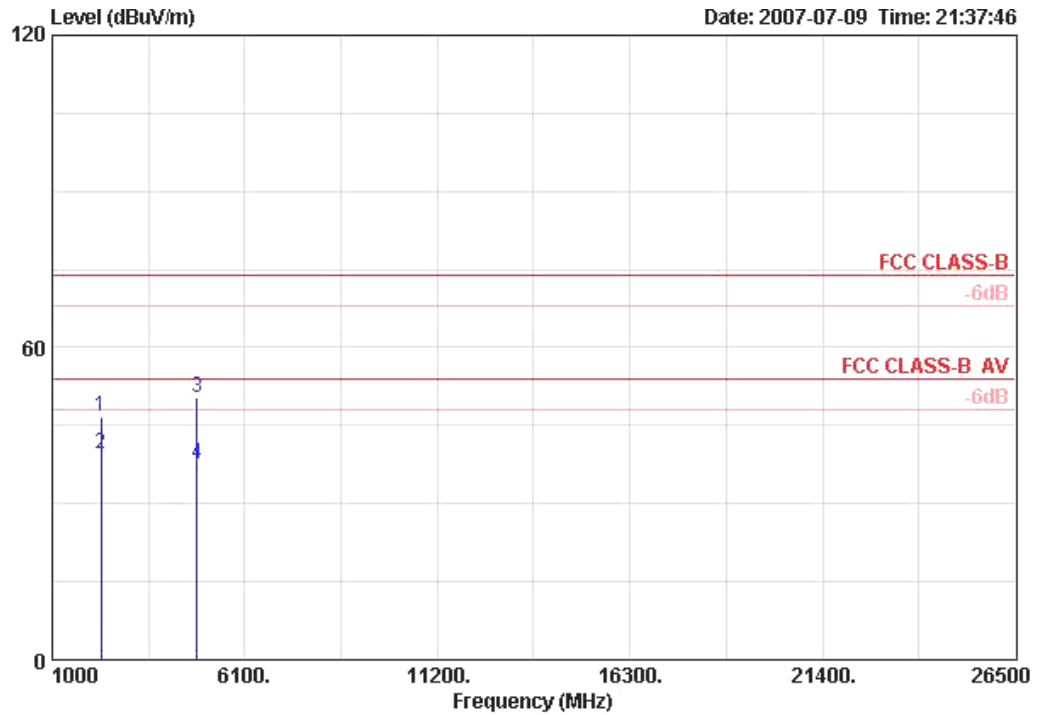

	Freq	Level	Over Limit	Limit Line	Read Level	Antenna Factor	Cable Loss	Preamplifier	Remark	Ant Pos	Table Pos
	MHz	dBuV/m	dB	dBuV/m	dBuV	dB/m	dB	dB		cm	deg
1	2287.980	46.80	-27.20	74.00	47.85	27.94	6.06	35.05	PEAK	103	221
2	2288.040	39.56	-14.44	54.00	40.61	27.94	6.06	35.05	AVERAGE	103	221
3	4825.780	50.45	-23.55	74.00	43.61	33.06	8.95	35.16	PEAK	100	0
4	4827.700	37.74	-16.26	54.00	30.91	33.06	8.95	35.16	AVERAGE	100	0

Vertical

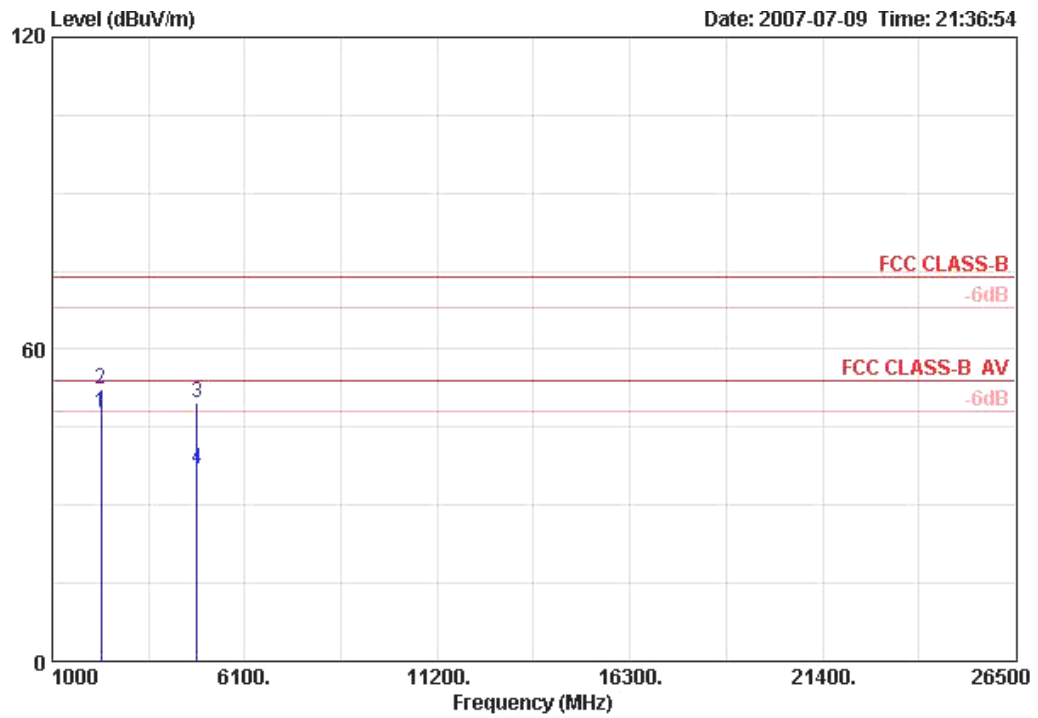

	Freq	Level	Over Limit	Limit Line	Read Level	Antenna Factor	Cable Loss	Preamp Factor	Remark	Ant Pos	Table Pos
	MHz	dBuV/m	dB	dBuV/m	dBuV	dB/m	dB	dB		cm	deg
1 @	2288.040	47.84	-6.16	54.00	48.89	27.94	6.06	35.05	AVERAGE	105	294
2	2288.160	52.25	-21.75	74.00	53.29	27.94	6.06	35.05	PEAK	105	294
3	4822.840	49.74	-24.26	74.00	42.91	33.06	8.95	35.16	PEAK	105	360
4	4823.080	37.06	-16.94	54.00	30.22	33.06	8.95	35.16	AVERAGE	105	360

Temperature	23°C	Humidity	62%
Test Engineer	Jacky Ho	Configurations	802.11g CH 6

Horizontal

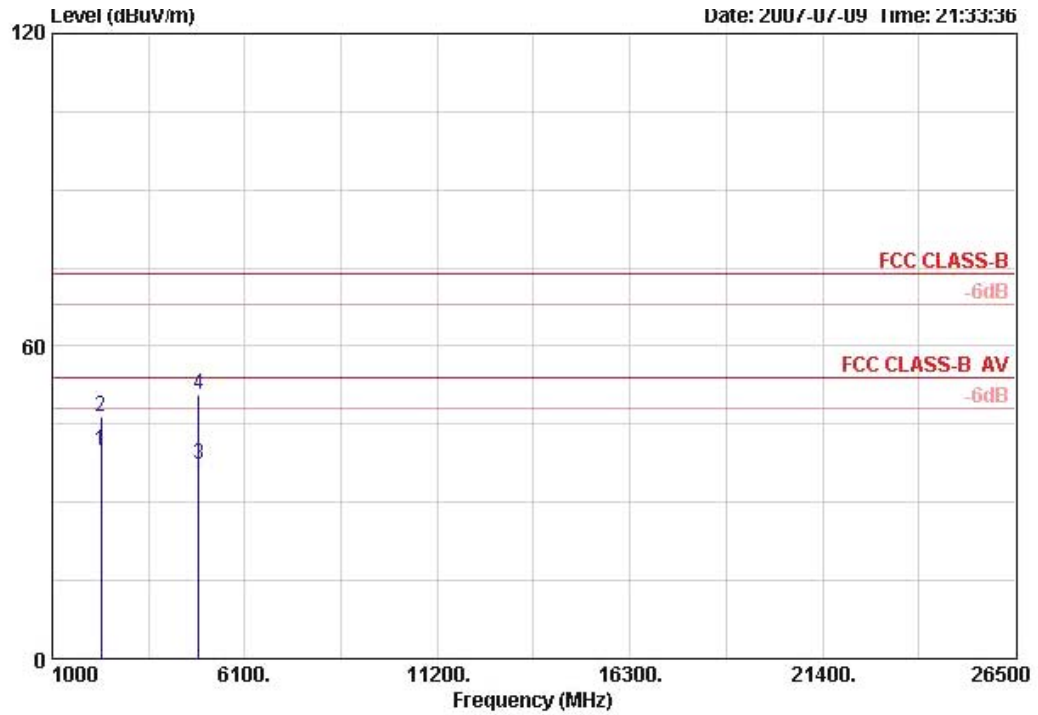

	Freq	Level	Over Limit	Limit Line	Read Level	Antenna Factor	Cable Loss	Preamplifier	Remark	Ant Pos	Table Pos
	MHz	dBuV/m	dB	dBuV/m	dBuV	dB/m	dB	dB		cm	deg
1	2288.020	39.85	-14.15	54.00	40.90	27.94	6.06	35.05	AVERAGE	107	221
2	2288.460	46.37	-27.63	74.00	47.42	27.94	6.06	35.05	PEAK	107	221
3	4877.060	37.37	-16.63	54.00	30.36	33.16	9.01	35.15	AVERAGE	117	185
4	4878.320	50.65	-23.35	74.00	43.64	33.16	9.01	35.15	PEAK	117	185

Vertical

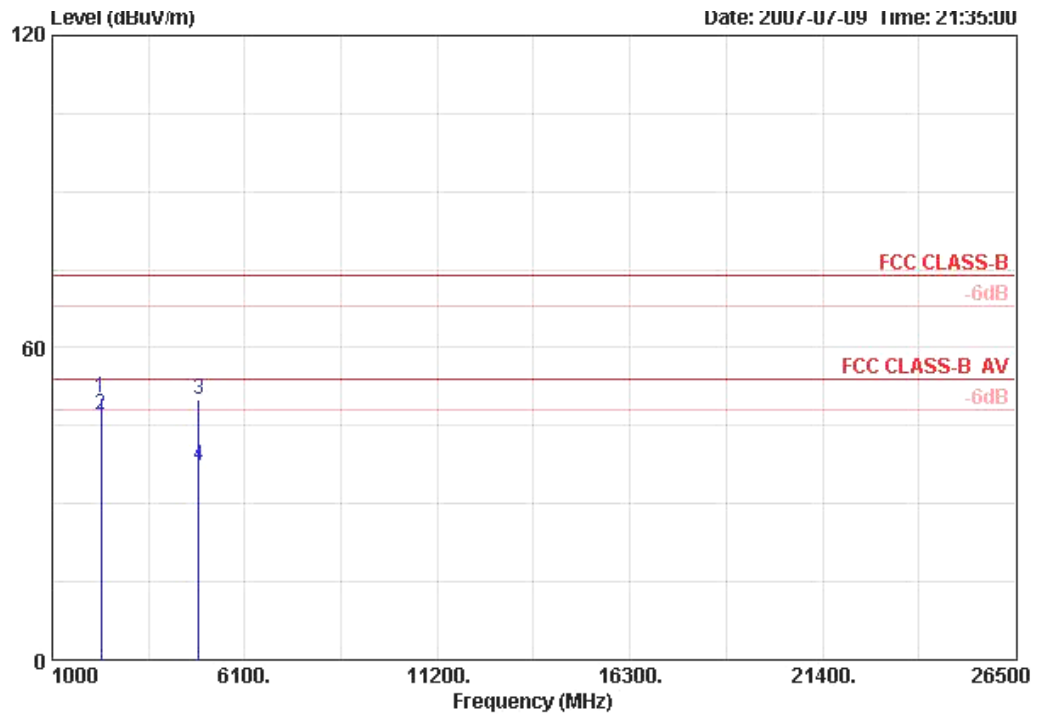

	Freq	Level	Over Limit	Limit Line	Read Level	Antenna Factor	Cable Loss	Preamp Factor	Remark	Ant Pos	Table Pos
	MHz	dBuV/m	dB	dBuV/m	dBuV	dB/m	dB	dB		cm	deg
1	2287.980	50.35	-23.65	74.00	51.40	27.94	6.06	35.05	PEAK	103	292
2	2288.060	47.18	-6.82	54.00	48.23	27.94	6.06	35.05	AVERAGE	103	292
3	4874.520	50.14	-23.86	74.00	43.13	33.16	9.01	35.15	PEAK	100	257
4	4876.980	37.21	-16.79	54.00	30.20	33.16	9.01	35.15	AVERAGE	100	257

Temperature	23°C	Humidity	62%
Test Engineer	Jacky Ho	Configurations	802.11g CH 11

Horizontal

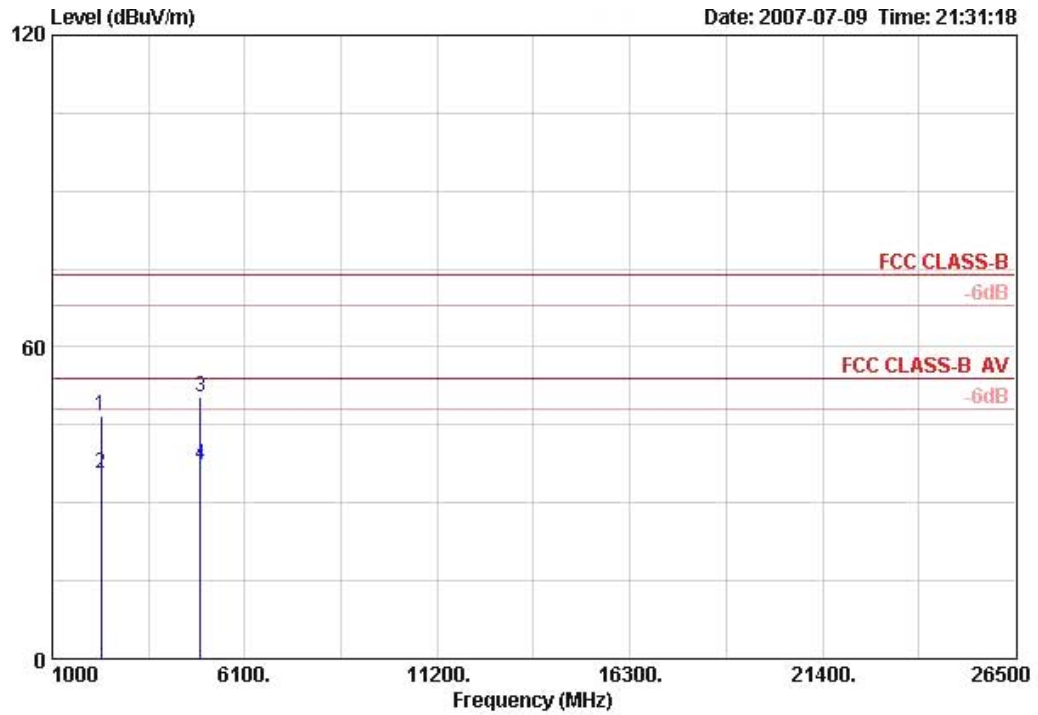

	Freq	Level	Over Limit	Limit Line	Read Level	Antenna Factor	Cable Loss	Preamplifier	Remark	Ant Pos	Table Pos
	MHz	dBUV/m	dB	dBUV/m	dBuV	dB/m	dB	dB		cm	deg
1	2287.900	46.73	-27.27	74.00	47.78	27.94	6.06	35.05	PEAK	100	212
2	2288.040	35.52	-18.48	54.00	36.57	27.94	6.06	35.05	AVERAGE	100	212
3	4923.320	50.39	-23.61	74.00	43.20	33.26	9.07	35.14	PEAK	100	80
4	4928.500	37.28	-16.72	54.00	30.09	33.26	9.07	35.14	AVERAGE	100	80

Vertical

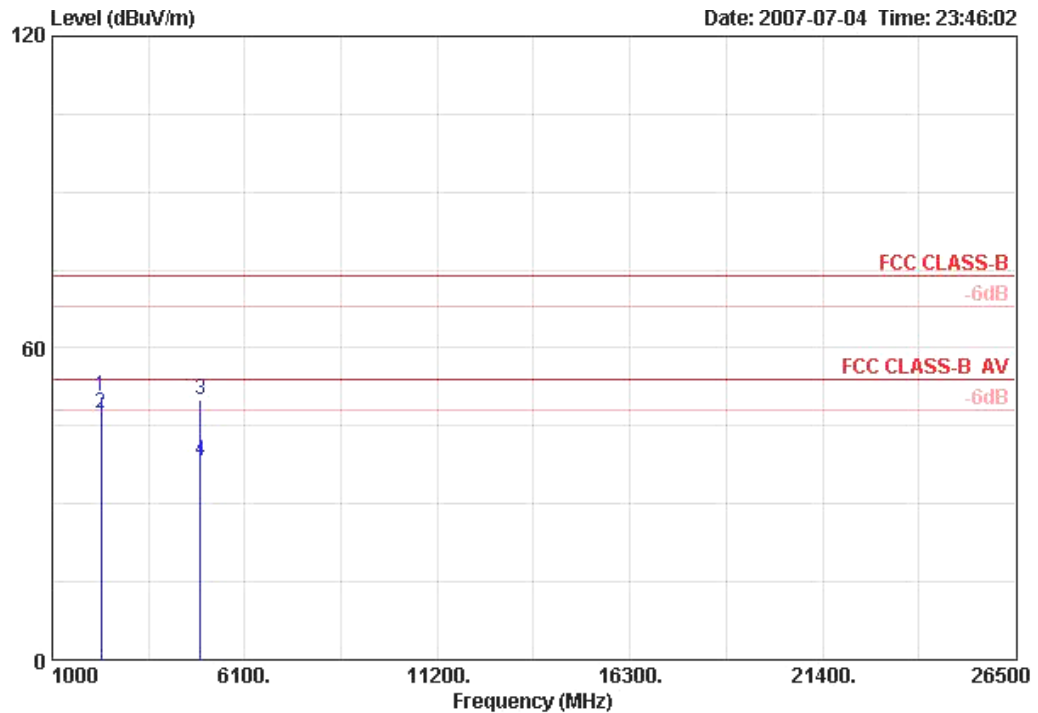

	Freq	Level	Over Limit	Limit Line	Read Level	Antenna Factor	Cable Loss	Preamp Factor	Remark	Ant Pos	Table Pos
	MHz	dBuV/m	dB	dBuV/m	dBuV	dB/m	dB	dB		cm	deg
1	2287.920	50.80	-23.20	74.00	51.85	27.94	6.06	35.05	PEAK	100	305
2 @	2288.020	47.37	-6.63	54.00	48.42	27.94	6.06	35.05	AVERAGE	100	305
3	4921.420	50.08	-23.92	74.00	42.89	33.26	9.07	35.14	PEAK	100	360
4	4927.860	38.13	-15.87	54.00	30.95	33.26	9.07	35.14	AVERAGE	100	360

Note:

The amplitude of spurious emissions that are attenuated by more than 20dB below the permissible value has no need to be reported.

Emission level (dBuV/m) = 20 log Emission level (uV/m).

Corrected Reading: Antenna Factor + Cable Loss + Read Level - Preamp Factor = Level.

4.6. Band Edge Emissions Measurement

4.6.1. Limit

20dBc in any 100 kHz bandwidth outside the operating frequency band. In case the emission fall within the restricted band specified on 15.205(a), then the 15.209(a) limit in the table below has to be followed.

Frequencies (MHz)	Field Strength (micorvolts/meter)	Measurement Distance (meters)
0.009~0.490	2400/F(KHz)	300
0.490~1.705	24000/F(KHz)	30
1.705~30.0	30	30
30~88	100	3
88~216	150	3
216~960	200	3
Above 960	500	3

4.6.2. Measuring Instruments and Setting

Please refer to section 5 of equipments list in this report. The following table is the setting of the spectrum analyzer.

Spectrum Parameter	Setting
Attenuation	Auto
Span Frequency	100 MHz
RB / VB (Emission in restricted band)	1 MHz / 1MHz for Peak, 1 MHz / 10Hz for Average
RB / VB (Emission in non-restricted band)	100 KHz /100 KHz for Peak

4.6.3. Test Procedures

1. The test procedure is the same as section 4.5.3, only the frequency range investigated is limited to 100MHz around bandedges.
2. In case the emission is fail due to the used RB/VB is too wide, marker-delta method of FCC Public Notice DA00-705 will be followed.

4.6.4. Test Setup Layout

This test setup layout is the same as that shown in section 4.5.4.

4.6.5. Test Deviation

There is no deviation with the original standard.

4.6.6. EUT Operation during Test

The EUT was programmed to be in continuously transmitting mode.

4.6.7. Test Result of Band Edge and Fundamental Emissions

Temperature	23°C	Humidity	62%
Test Engineer	Jacky Ho	Configurations	802.11b CH 1, 11

Channel 1

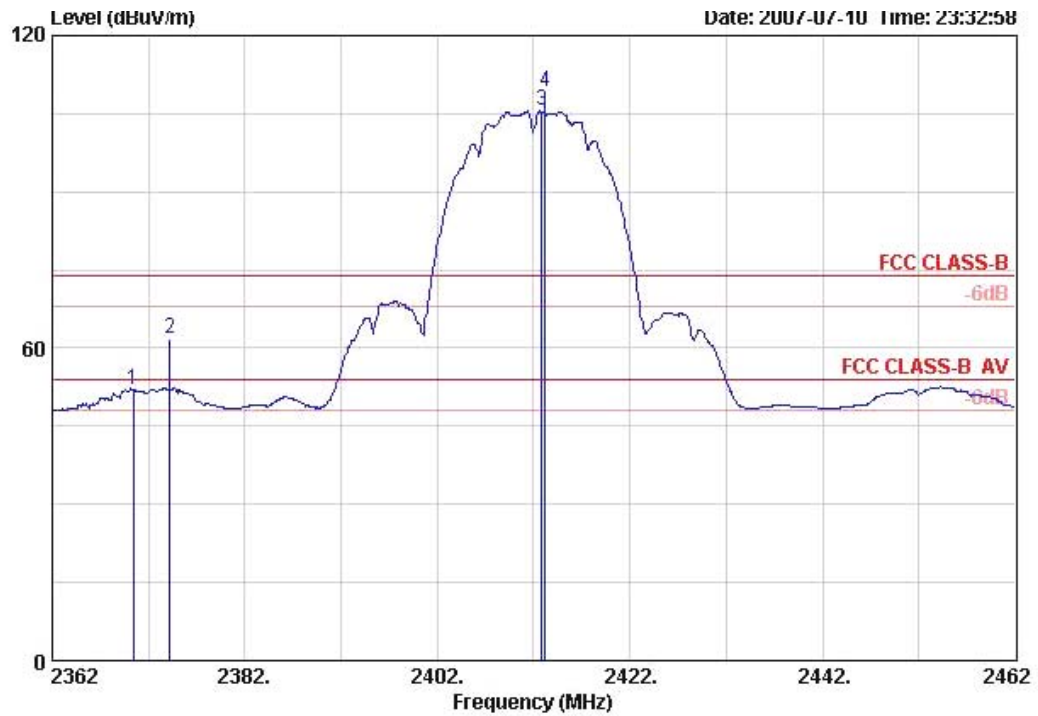

	Freq	Level	Over Limit	Limit Line	Read Level	Antenna Factor	Cable Loss	Preamp	Remark	Ant Pos	Table Pos
	MHz	dBUV/m	dB	dBUV/m	dBuV	dB/m	dB	dB		cm	deg
1 @	2370.400	51.94	-2.06	54.00	17.64	28.13	6.17	0.00	AVERAGE	100	272
2	2374.200	61.86	-12.14	74.00	27.56	28.13	6.17	0.00	PEAK	100	272
3 @	2412.800	105.46			71.05	28.21	6.20	0.00	AVERAGE	100	272
4 @	2413.200	109.20			74.79	28.21	6.20	0.00	PEAK	100	272

Item 3, 4 are the fundamental frequency at 2412 MHz.

Channel 11

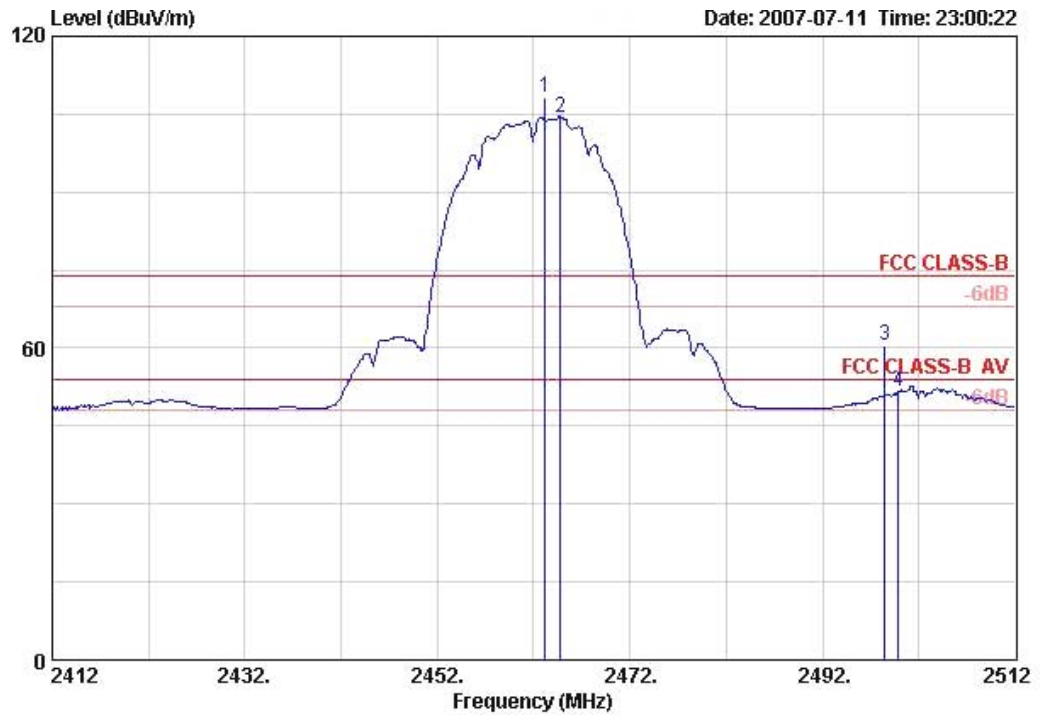

	Freq	Level	Over Limit	Limit Line	Read Level	Antenna Factor	Cable Loss	Preamp Factor	Remark	Ant Pos	Table Pos
	MHz	dBuV/m	dB	dBuV/m	dBuV	dB/m	dB	dB		cm	deg
1 @	2463.200	108.10			73.50	28.32	6.27	0.00	PEAK	100	53
2 @	2464.800	104.47			69.87	28.32	6.27	0.00	AVERAGE	100	53
3	2498.500	60.65	-13.35	74.00	25.91	28.40	6.34	0.00	PEAK	100	53
4 @	2499.900	51.51	-2.49	54.00	16.77	28.40	6.34	0.00	AVERAGE	100	53

Item 1, 2 are the fundamental frequency at 2462 MHz.

Temperature	23°C	Humidity	62%
Test Engineer	Jacky Ho	Configurations	802.11g CH 1, 11

Channel 1

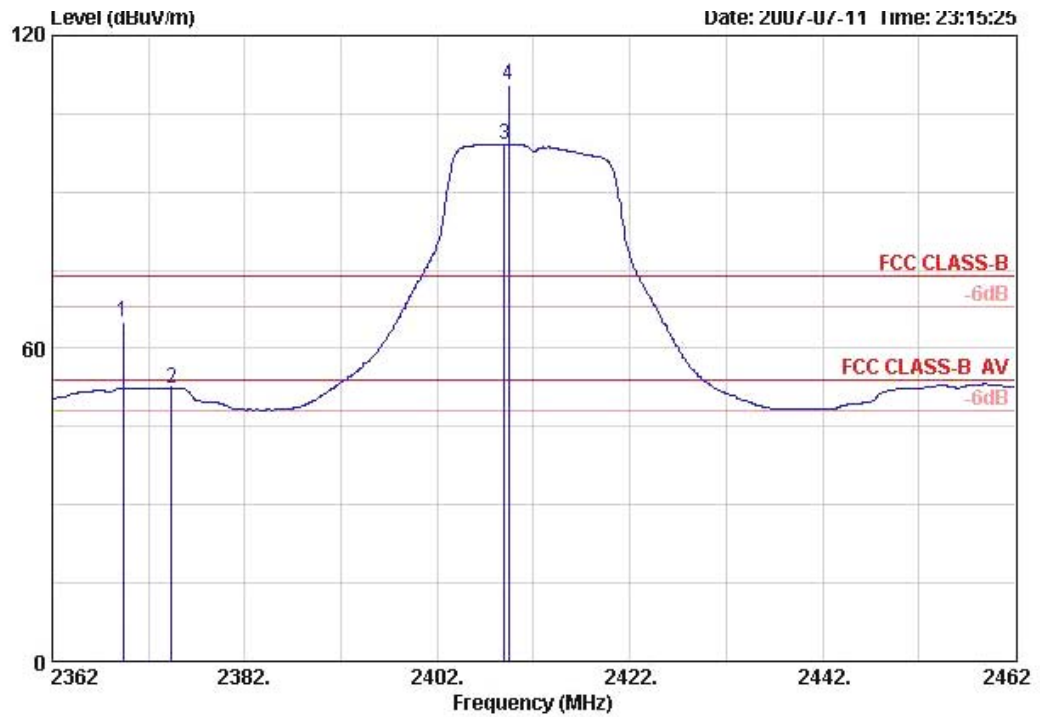

	Freq	Level	Over Limit	Limit Line	Read Level	Antenna Factor	Cable Loss	Preamp Factor	Remark	Ant Pos	Table Pos
	MHz	dBUV/m	dB	dBUV/m	dBuV	dB/m	dB	dB		cm	deg
1	2369.400	65.07	-8.93	74.00	30.77	28.13	6.17	0.00	PEAK	100	276
2 @	2374.400	52.48	-1.52	54.00	18.18	28.13	6.17	0.00	AVERAGE	100	276
3 @	2409.000	99.19			64.78	28.21	6.20	0.00	AVERAGE	100	276
4 @	2409.400	110.64			76.23	28.21	6.20	0.00	PEAK	100	276

Item 3, 4 are the fundamental frequency at 2412 MHz.

Channel 11

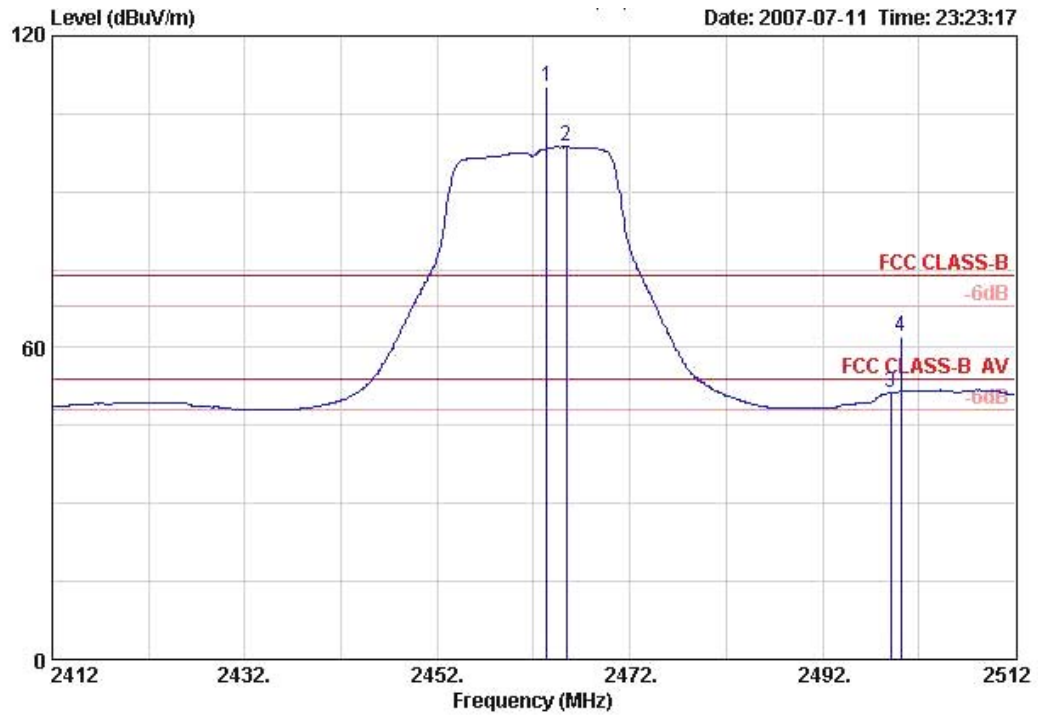

	Freq	Level	Over Limit	Limit Line	Read Level	Antenna Factor	Cable Loss	Preamp Factor	Remark	Ant Pos	Table Pos
	MHz	dBuV/m	dB	dBuV/m	dBuV	dB/m	dB	dB		cm	deg
1 @	2463.400	110.31			75.72	28.32	6.27	0.00	PEAK	100	52
2 @	2465.400	98.62			64.02	28.32	6.27	0.00	AVERAGE	100	52
3 @	2499.100	51.37	-2.63	54.00	16.63	28.40	6.34	0.00	AVERAGE	100	52
4	2500.100	62.23	-11.77	74.00	27.49	28.40	6.34	0.00	PEAK	100	52

Item 1, 2 are the fundamental frequency at 2462 MHz.

Note:

Emission level (dBUV/m) = 20 log Emission level (uV/m).

Corrected Reading: Antenna Factor + Cable Loss + Read Level - Preamp Factor = Level.

For Emission not in Restricted Band

Low Band Edge Plot on Configuration IEEE 802.11b / 2412 MHz

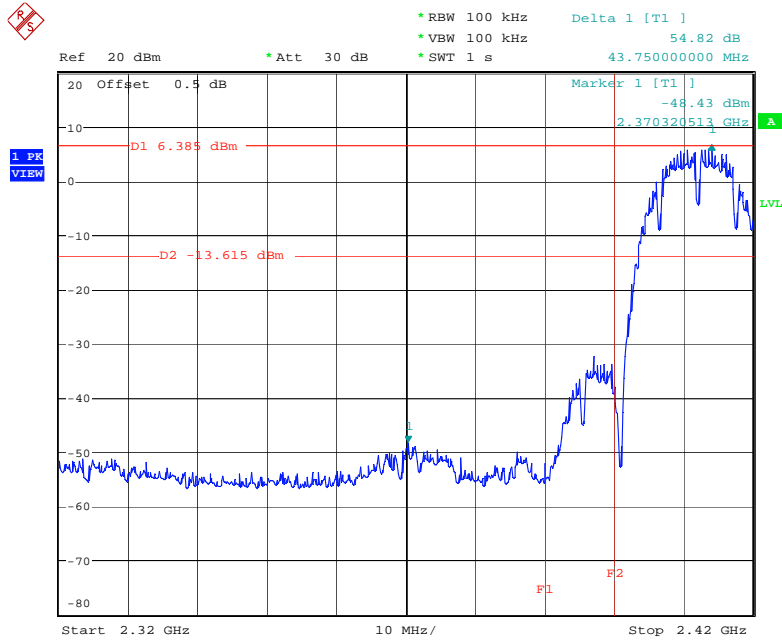

Date: 12.JUL.2007 19:30:54

High Band Edge Plot on Configuration IEEE 802.11b / 2462 MHz

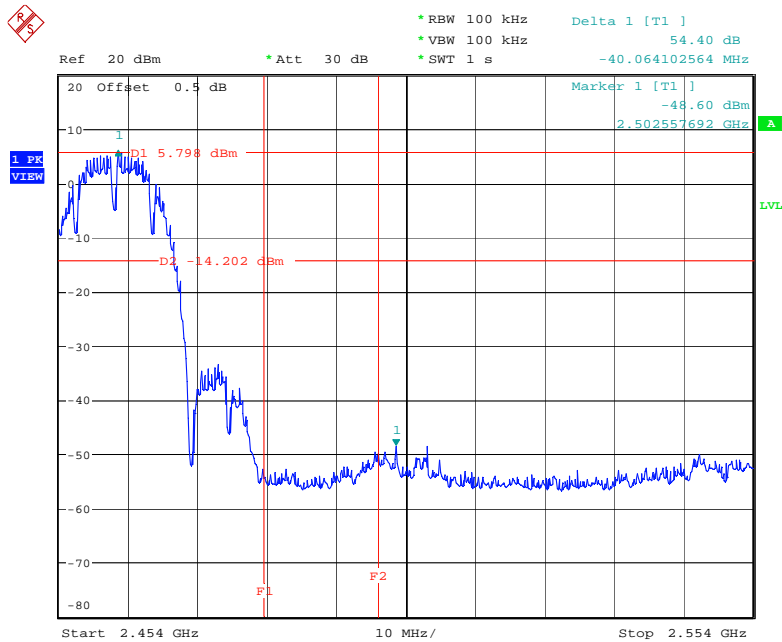

Date: 12.JUL.2007 19:28:31

Low Band Edge Plot on Configuration IEEE 802.11g / 2412 MHz

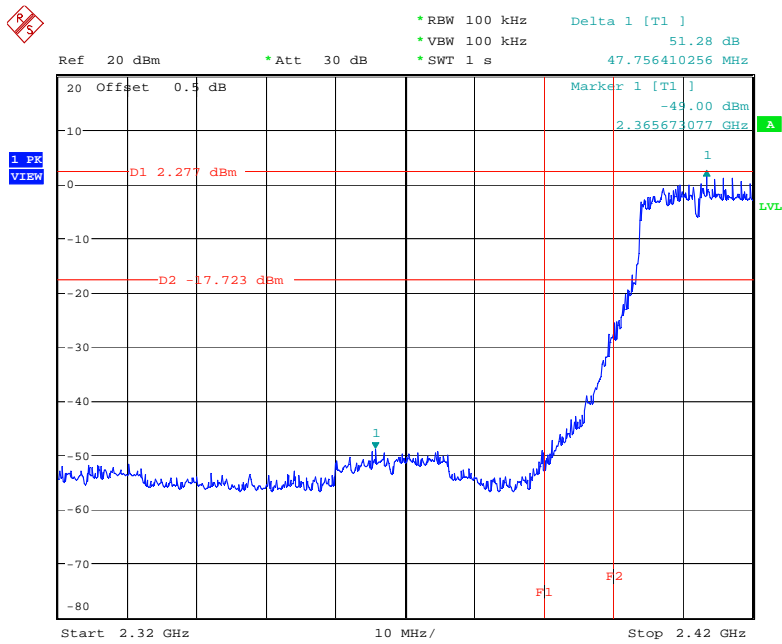

Date: 12.JUL.2007 19:25:35

High Band Edge Plot on Configuration IEEE 802.11g / 2462 MHz

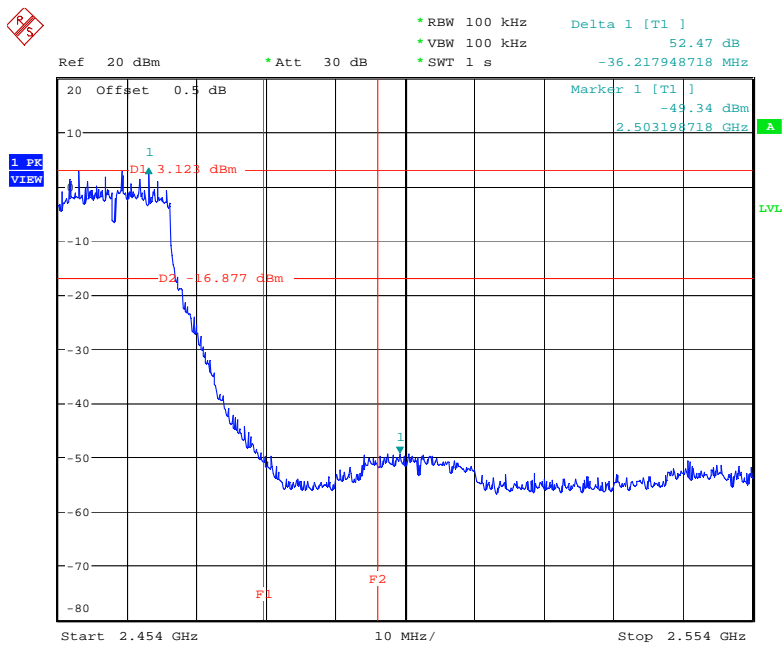

Date: 12.JUL.2007 19:27:18

4.7. Antenna Requirements

4.7.1. Limit

Except for special regulations, the Low-power Radio-frequency Devices must not be equipped with any jacket for installing an antenna with extension cable. An intentional radiator shall be designed to ensure that no antenna other than that furnished by the responsible party shall be used with the device. The use of a permanently attached antenna or of an antenna that uses a unique coupling to the intentional radiator shall be considered sufficient to comply with the provisions of this Section. The manufacturer may design the unit so that the user can replace a broken antenna, but the use of a standard antenna jack or electrical connector is prohibited. Further, this requirement does not apply to intentional radiators that must be professionally installed.

4.7.2. Antenna Connector Construction

Please refer to section 3.3 in this test report; antenna connector complied with the requirements.

5. LIST OF MEASURING EQUIPMENTS

Instrument	Manufacturer	Model No.	Serial No.	Characteristics	Calibration Date	Remark
EMC Receiver	R&S	ESCS 30	100359	9kHz – 2.75GHz	Mar. 01, 2007	Conduction (CO04-HY)
LISN	MessTec	NNB-2/16Z	99079	9kHz – 30MHz	Mar. 31, 2007	Conduction (CO04-HY)
LISN (Support Unit)	EMCO	3810/2NM	9703-1839	9kHz – 30MHz	Mar. 22, 2007	Conduction (CO04-HY)
RF Cable-CON	UTIFLEX	3102-26886-4	CB049	9kHz – 30MHz	Apr. 20, 2007	Conduction (CO04-HY)
EMI Filter	LINDGREN	LRE-2030	2651	< 450 Hz	N/A	Conduction (CO04-HY)
Isolation Transformer	Erika Fiedler OHG	D-65396 Walluf	58	45MHz-2.15GHz	N/A	Conduction (CO04-HY)
3m Semi Anechoic Chamber	SIDT FRANKONIA	SAC-3M	03CH03-HY	30 MHz - 1 GHz 3m	Jun. 14, 2007	Radiation (03CH03-HY)
Amplifier	SCHAFFNER	CPA9231A	1886	9 kHz - 2 GHz	Jan. 22, 2007	Radiation (03CH03-HY)
Amplifier	Agilent	8449B	3008A02120	1 GHz - 26.5 GHz	Jun.07, 2007	Radiation (03CH03-HY)
Amplifier	MITEQ	AMF-6F-260400	923364	26.5 GHz - 40 GHz	Jan. 22, 2007*	Radiation (03CH03-HY)
Spectrum Analyzer	R&S	FSP40	100004/040	9 kHz - 40 GHz	Sep. 21, 2006	Radiation (03CH03-HY)
Loop Antenna	R&S	HFH2-Z2	860004/001	9 kHz - 30 MHz	May 23, 2006*	Radiation (03CH03-HY)
Bilog Antenna	SCHAFFNER	CBL 6112D	22237	30 MHz – 1 GHz	Jul. 24, 2006	Radiation (03CH03-HY)
Horn Antenna	EMCO	3115	6741	1GHz ~ 18GHz	May 04, 2007	Radiation (03CH03-HY)
Horn Antenna	SCHWARZBECK	BBHA9170	BBHA9170154	15 GHz - 40 GHz	NCR	Radiation (03CH03-HY)
RF Cable-R03m	Jye Bao	RG142	CB021	30 MHz - 1 GHz	Dec. 02, 2006	Radiation (03CH03-HY)
RF Cable-HIGH	SUHNER	SUCOFLEX 106	03CH03-HY	1 GHz - 40 GHz	Dec. 02, 2006	Radiation (03CH03-HY)
Turn Table	HD	DS 420	420/650/00	0 – 360 degree	N/A	Radiation (03CH03-HY)
Antenna Mast	HD	MA 240	240/560/00	1 m - 4 m	N/A	Radiation (03CH03-HY)
Spectrum Analyzer	R&S	FSP30	100023	9kHz ~ 30GHz	Dec. 17, 2006	Conducted (TH01-HY)
Power Meter	R&S	NRVD	100764	DC ~ 40GHz	Jul. 20, 2006	Conducted (TH01-HY)
Power Sensor	R&S	NRV-Z51	100666	DC ~ 40GHz	Jul. 20, 2006	Conducted (TH01-HY)
Power Sensor	R&S	NRV-Z32	100057	30MHz ~ 6GHz	Jun. 27, 2007	Conducted (TH01-HY)
AC Power Source	HPC	HPA-500W	HPA-9100024	AC 0 ~ 300V	May 04, 2007*	Conducted (TH01-HY)
DC Power Source	G.W.	GPC-6030D	C671845	DC 1V ~ 60V	Mar. 03, 2007	Conducted (TH01-HY)
Temp. and Humidity Chamber	KSON	THS-C3L	612	N/A	Oct. 02, 2006	Conducted (TH01-HY)

Instrument	Manufacturer	Model No.	Serial No.	Characteristics	Calibration Date	Remark
RF CABLE-1m	Jye Bao	RG142	CB034-1m	20MHz ~ 7GHz	Dec. 01, 2006	Conducted (TH01-HY)
RF CABLE-2m	Jye Bao	RG142	CB035-2m	20MHz ~ 1GHz	Dec. 01, 2006	Conducted (TH01-HY)
Vector Signal Generator	R&S	SMU200A	102098	100kHz ~ 6GHz	Nov. 14, 2006	Conducted (TH01-HY)
Signal Generator	R&S	SMR40	100116	10MHz ~ 40GHz	Mar. 07, 2007	Conducted (TH01-HY)

Note: Calibration Interval of instruments listed above is one year.

Note: * Calibration Interval of instruments listed above is Two year.

Note: NCR means Non-Calibration required.

6. TEST LOCATION

SHIJR	ADD : 6Fl., No. 106, Sec. 1, Shintai 5th Rd., Shijr City, Taipei, Taiwan 221, R.O.C. TEL : 886-2-2696-2468 FAX : 886-2-2696-2255
HWA YA	ADD : No. 52, Hwa Ya 1st Rd., Kwei-Shan Hsiang, Tao Yuan Hsien, Taiwan, R.O.C. TEL : 886-3-327-3456 FAX : 886-3-318-0055
LINKOU	ADD : No. 30-2, Dingfu Tsuen, Linkou Shiang, Taipei, Taiwan 244, R.O.C TEL : 886-2-2601-1640 FAX : 886-2-2601-1695
DUNGHU	ADD : No. 3, Lane 238, Kangle St., Neihu Chiu, Taipei, Taiwan 114, R.O.C. TEL : 886-2-2631-4739 FAX : 886-2-2631-9740
JUNGHE	ADD : 7Fl., No. 758, Jungjeng Rd., Junghe City, Taipei, Taiwan 235, R.O.C. TEL : 886-2-8227-2020 FAX : 886-2-8227-2626
NEIHU	ADD : 4Fl., No. 339, Hsin Hu 2 nd Rd., Taipei 114, Taiwan, R.O.C. TEL : 886-2-2794-8886 FAX : 886-2-2794-9777
JHUBEI	ADD : No.8, Lane 724, Bo-ai St., Jhubei City, HsinChu County 302, Taiwan, R.O.C. TEL : 886-3-656-9065 FAX : 886-3-656-9085

7. TAF CERTIFICATE OF ACCREDITATION



Certificate No. : L1190-070110

財團法人全國認證基金會
Taiwan Accreditation Foundation

Certificate of Accreditation

This is to certify that

Sporton International Inc.
EMC & Wireless Communications Laboratory
No.52, Hwa Ya 1st Rd., Hwa Ya Technology Park, Kwei-Shan Hsiang, Tao Yuan Hsien,
Taiwan, R.O.C.

is accredited in respect of laboratory

Accreditation Criteria	: ISO/IEC 17025:2005
Accreditation Number	: 1190
Originally Accredited	: December 15, 2003
Effective Period	: January 10, 2007 to January 09, 2010
Accredited Scope	: Testing Field, see described in the Appendix
Specific Accreditation Program	: Accreditation Program for Designated Testing Laboratory for Commodities Inspection : Accreditation Program for Telecommunication Equipment Testing Laboratory

Jay-San Chen
President, Taiwan Accreditation Foundation
Date : January 10, 2007

PI, total 9 pages

The Appendix forms an integral part of this Certificate, which shall be invalid when used without the Appendix.