

# EMC TEST REPORT

**Report No. : EME-060268****Model No. : WCP5102****Issued Date : Mar. 15, 2006**

**Applicant : AboCom Systems, Inc.**  
**1F, No. 21, Yanfa 2<sup>nd</sup> Road, SBIP, Hsinchu City 300,**  
**Taiwan**

**Test By : Intertek Testing Services Taiwan Ltd.**  
**No. 11, Lane 275, Ko-Nan 1 Street, Chia-Tung Li,**  
**Shiang-Shan District, Hsinchu City, Taiwan**

This test report consists of 44 pages in total. It may be duplicated completely for legal use with the allowance of the applicant. It shall not be reproduced except in full, without the written approval of Intertek Laboratory. The test result(s) in this report only applies to the tested sample(s).

Project Engineer



---

Kevin Chen

Reviewed By

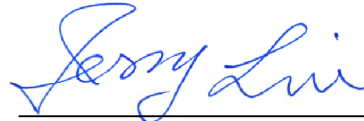

---

Jerry Liu

**Table of Contents**

Summary of Tests .....4

1. General information .....5

    1.1 Identification of the EUT .....5

    1.2 Additional information about the EUT.....5

    1.3 Antenna description.....6

    1.4 Peripherals equipment .....6

2. Test specifications .....7

    2.1 Test standard.....7

    2.2 Operation mode .....7

    2.3 Test equipment .....8

3. Minimum 6dB Bandwidth test .....9

    3.1 Operating environment.....9

    3.2 Test setup & procedure.....9

    3.3 Measured data of Minimum 6dB Bandwidth test results .....9

4. Maximum Output Power test .....16

    4.1 Operating environment.....16

    4.2 Test setup & procedure.....16

    4.3 Measured data of Maximum Output Power test results .....16

5. Radiated Emission test .....17

    5.1 Operating environment.....17

    5.2 Test setup & procedure.....17

    5.3 Emission limits.....18

    5.4 Radiated spurious emission test data.....19

        5.4.1 Measurement results: frequencies equal to or less than 1 GHz.....19

        5.4.2 Measurement results: frequency above 1GHz .....20

6. Power Spectrum Density test .....23

    6.1 Operating environment.....23

    6.2 Test setup & procedure.....23

    6.3 Measured data of Power Spectrum Density test results .....23

7. Emission on the band edge.....30

    7.1 Operating environment.....30

    7.2 Test setup & procedure.....30

    7.3 Test Result .....31

7.3.1 Conducted Method .....31

7.3.2 Radiated Method .....39

8. Power Line Conducted Emission test §FCC 15.207 .....41

8.1 Operating environment.....41

8.2 Test setup & procedure.....41

8.3 Emission limit .....42

8.4 Uncertainty of Conducted Emission .....42

8.5 Power Line Conducted Emission test data.....43

**Summary of Tests****802.11b/g Wireless LAN PCI Card -Model: WCP5102  
FCC ID: MQ4-WCP5102**

Test	Reference	Results
Minimum 6dB Bandwidth test	15.247(a)(2)	Complies
Maximum Output Power test	15.247(b)	Complies
Radiated Spurious Emission test	15.205, 15.209	Complies
Power Spectrum Density test	15.247(e)	Complies
Emission on the Band Edge test	15.247(d)	Complies
AC Power Line Conducted Emission test	15.207	Complies

## 1. General information

### 1.1 Identification of the EUT

Applicant	: AboCom Systems, Inc.
Product	: 802.11b/g Wireless LAN PCI Card
Model No.	: WCP5102
FCC ID.	: MQ4WCP5102
Frequency Range	: 2412MHz ~ 2462MHz
Channel Number	: 11 channels
Frequency of Each Channel	: 2412MHz, 2417MHz, 2422MHz, 2427MHz, 2432MHz, 2437MHz, 2442MHz, 2447MHz, 2452MHz, 2457MHz, 2462MHz
Type of Modulation	: DSSS, OFDM
Rated Power	: 3.3Vdc from Notebook PC
Power Cord	: N/A
Sample Received	: Mar. 2, 2006
Test Date(s)	: Mar. 8, 2006 ~ Mar. 14, 2006

A FCC DoC report has been generated for the client.

### 1.2 Additional information about the EUT

The EUT is a 802.11b/g Wireless LAN PCI Card and was defined as information technology equipment.

For more detail features, please refer to user's Manual.

### 1.3 Antenna description

The antenna is affixed to the EUT using a unique connector, which allows for replacement of a broken antenna, but DOES NOT use a standard antenna jack or electrical connector.

#### Main of Antenna

Antenna Gain: 0.5dBi max (with 1m length cable)

Antenna Type: Dipole antenna

Connector Type: SMA Reverse

#### Secondary of Antenna

Antenna Gain: 0.5dBi max

Antenna Type: Dipole antenna

Connector Type: SMA Reverse

### 1.4 Peripherals equipment

Peripherals	Manufacturer	Product No.	Serial No.
PC	HP	dx2000 MT	SGH5290NLF
Keyborad	HP	SK-2501K	MR80700043
Mouse	LOGITECH	M-S43	LZE94853501
Moniter	Benq	FP557	99L63726A132600064TAA6A1
Printer	HP	DeskJet 400	SG5CQ170C0
Modem	LEMEL	MD-56KVT-100	00V230A00078422
Access Point	Z-COM	XI-1450	AF16001-00242

## **2. Test specifications**

### **2.1 Test standard**

The EUT was performed according to the procedures in FCC Part 15 Subpart C Section § 15.205, §15.207, §15.209, §15.247 and ANSI C63.4/2003.

The test of radiated measurements according to FCC Part15 Section 15.33(a) had been conducted and the field strength of this frequency band were all meet limit requirement, thus we evaluate the EUT pass the specified test.

### **2.2 Operation mode**

The EUT was transmitted continuously during the test.

With individual verifying, the maximum output power was found at 1Mbps data rate for 802.11b mode and 6Mbps data rate for 802.11g mode. The final tests were executed under these conditions and recorded in this report individually.

### 2.3 Test equipment

Equipment	Brand	Frequency range	Model No.	Intertek ID No.	Next Cal. Date
EMI Test Receiver	Rohde & Schwarz	9kHz~2.75GHz	ESCS 30	EC303	04/17/2006
EMI Test Receiver	Rohde & Schwarz	20Hz~26.5GHz	ESMI	EC317	08/07/2006
Spectrum Analyzer	Rohde & Schwarz	9kHz~30GHz	FSP 30	EC353	07/24/2006
Spectrum Analyzer	Rohde & Schwarz	20Hz~40GHz	FSEK 30	EC365	11/01/2006
Horn Antenna	SCHWARZBECK	1GHz~18GHz	BBHA 9120 D	EC371	12/22/2006
Horn Antenna	SCHWARZBECK	14GHz~40GHz	BBHA 9170	EC351	07/08/2006
Bilog Antenna	SCHWARZBECK	25MHz~2GHz	VULB 9168	EC347	12/24/2006
Pre-Amplifier	MITEQ	100MHz~26.5GHz	919981	EC373	12/29/2006
Wideband Peak Power Meter/ Sensor	Anritsu	100MHz~18GHz	ML2497A/ MA2491A	EC396	11/10/2006
Controller	HDGmbH	N/A	CM 100	EP346	N/A
Antenna Tower	HDGmbH	N/A	MA 240	EP347	N/A
LISN	Rohde & Schwarz	9KHz~30MHz	ESH3-Z5	EC344	01/12/2007

Note: The above equipments are within the valid calibration period.



### 3. Minimum 6dB Bandwidth test

#### 3.1 Operating environment

Temperature: 25  
Relative Humidity: 55 %  
Atmospheric Pressure: 1023 hPa

#### 3.2 Test setup & procedure

The minimum 6dB bandwidth per FCC §15.247(a)(2) was measured using a 50 ohm spectrum analyzer with the resolutions bandwidth set at 100kHz, the video bandwidth set at 100kHz, and the SPAN>>RBW. The test was performed at 3 channels (lowest, middle and highest channel). The minimum 6-dB modulation bandwidth is in the following Table.

#### 3.3 Measured data of Minimum 6dB Bandwidth test results

Test Mode: 802.11b (DSSS Modulation) operating mode

Channel	Frequency (MHz)	Bandwidth (MHz)	Limit
1 (lowest)	2412.00	11.84	> 500kHz
6 (middle)	2437.00	12.00	> 500kHz
11 (highest)	2462.00	12.20	> 500kHz

Test Mode: 802.11g (OFDM Modulation) operating mode

Channel	Frequency (MHz)	Bandwidth (MHz)	Limit
1 (lowest)	2412.00	16.60	> 500kHz
6 (middle)	2437.00	16.56	> 500kHz
11 (highest)	2462.00	16.60	> 500kHz

Please see the plot below.

### Test Mode: 802.11b(DSSS Modulation) operating mode

	Max/Ref Lvl	Delta 2 [T1]	RBW	100 kHz	RF Att	10 dB
	20 dBm	0.56 dB	VBW	100 kHz		
	1.5 dBm	11.84000000 MHz	SWT	5 ms	Unit	dBm

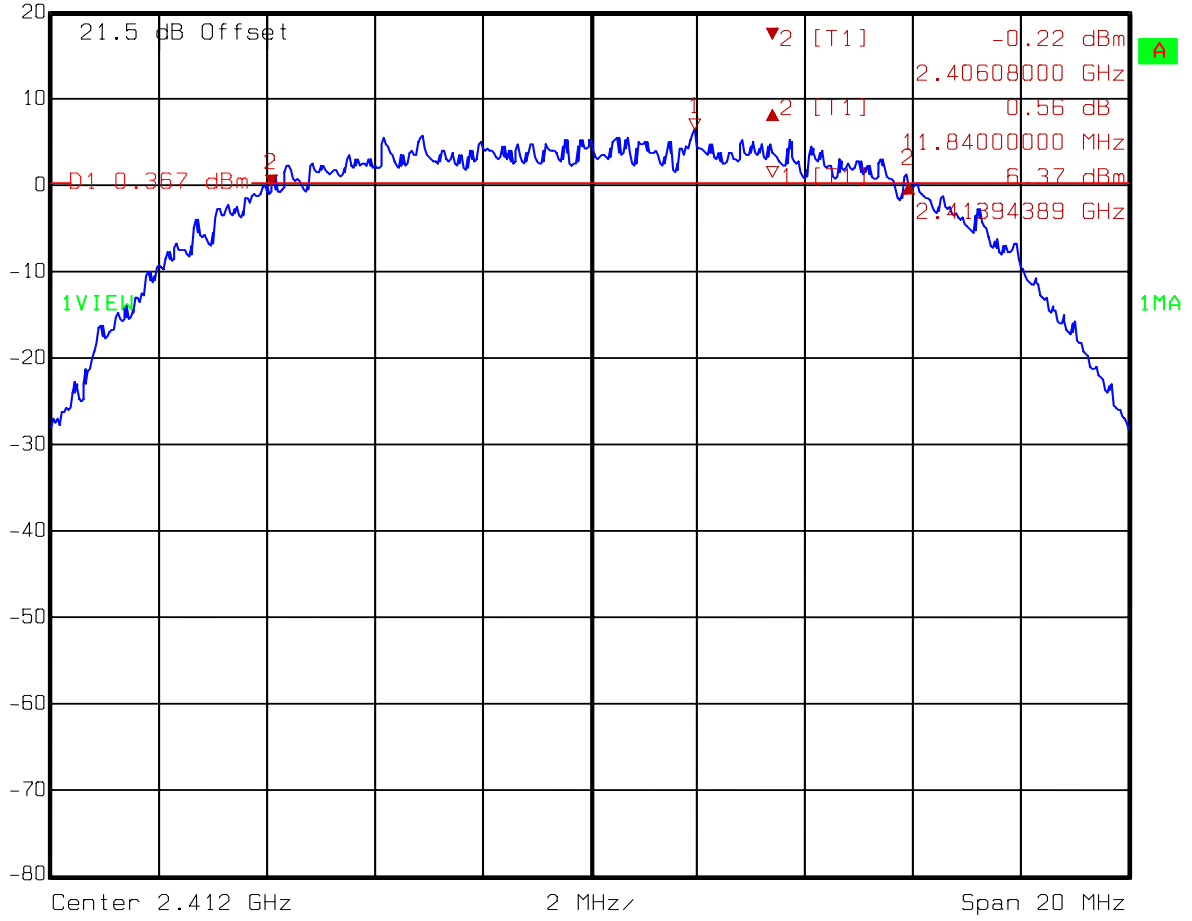

Title:            6dB Bandwidth  
 Comment A: Channel 1 at 802.11b mode  
 Date:            09.MAR.2006 14:44:04

	Max/Ref Lvl	Delta 2 [T1]	RBW	100 kHz	RF Att	10 dB
	20 dBm	0.25 dB	VBW	100 kHz		
	1.5 dBm	12.00000000 MHz	SWT	5 ms	Unit	dBm

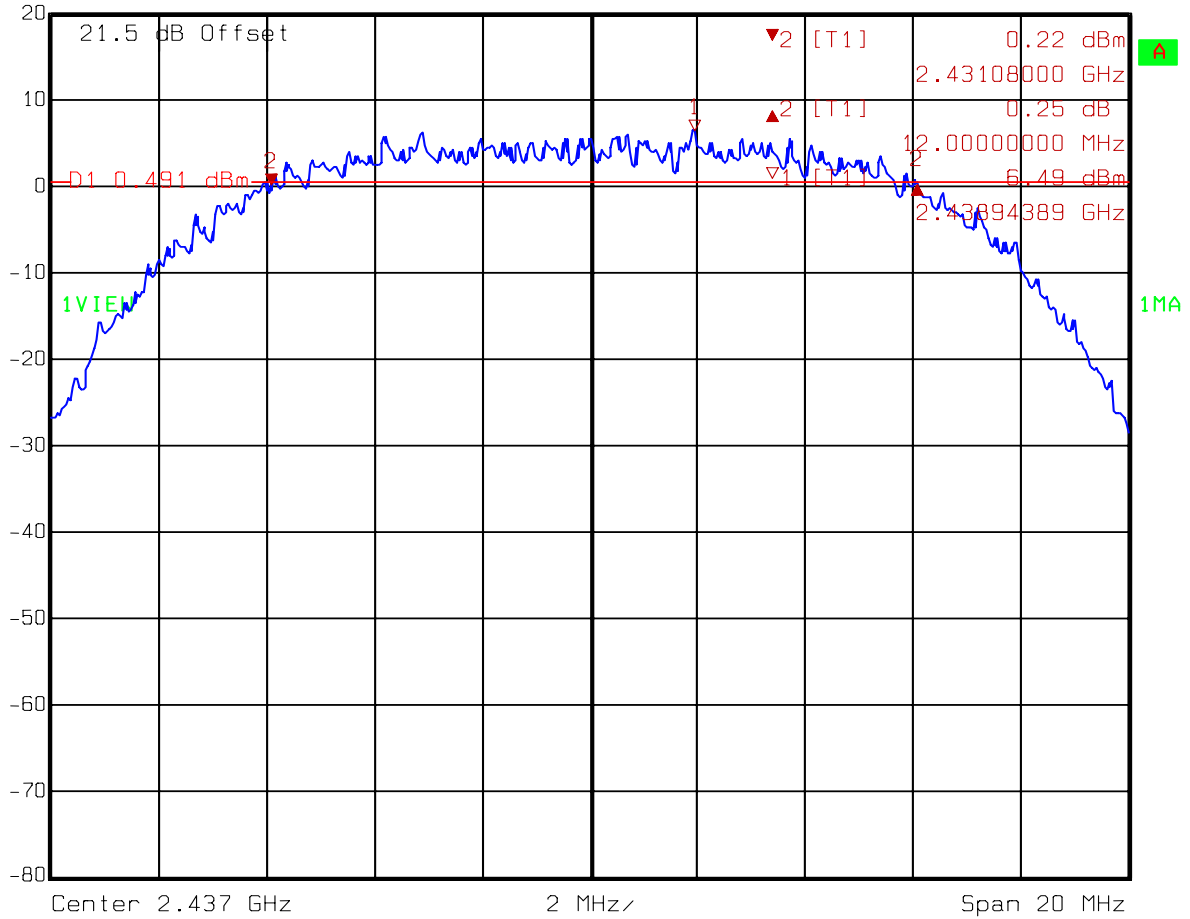

Title:        6dB Bandwidth  
 Comment A: Channel 6 at 802.11b mode  
 Date:        09.MAR.2006 14:58:08

# Intertek ETL SEMKO

FCC ID. : MQ4WCP5102

Report No.: EME-060268  
Page 12 of 44

	Max/Ref Lvl	Delta 2 [T1]	RBW	100 kHz	RF Att	10 dB
	20 dBm	0.91 dB	VBW	100 kHz		
	1.5 dBm	12.20000000 MHz	SWT	5 ms	Unit	dBm

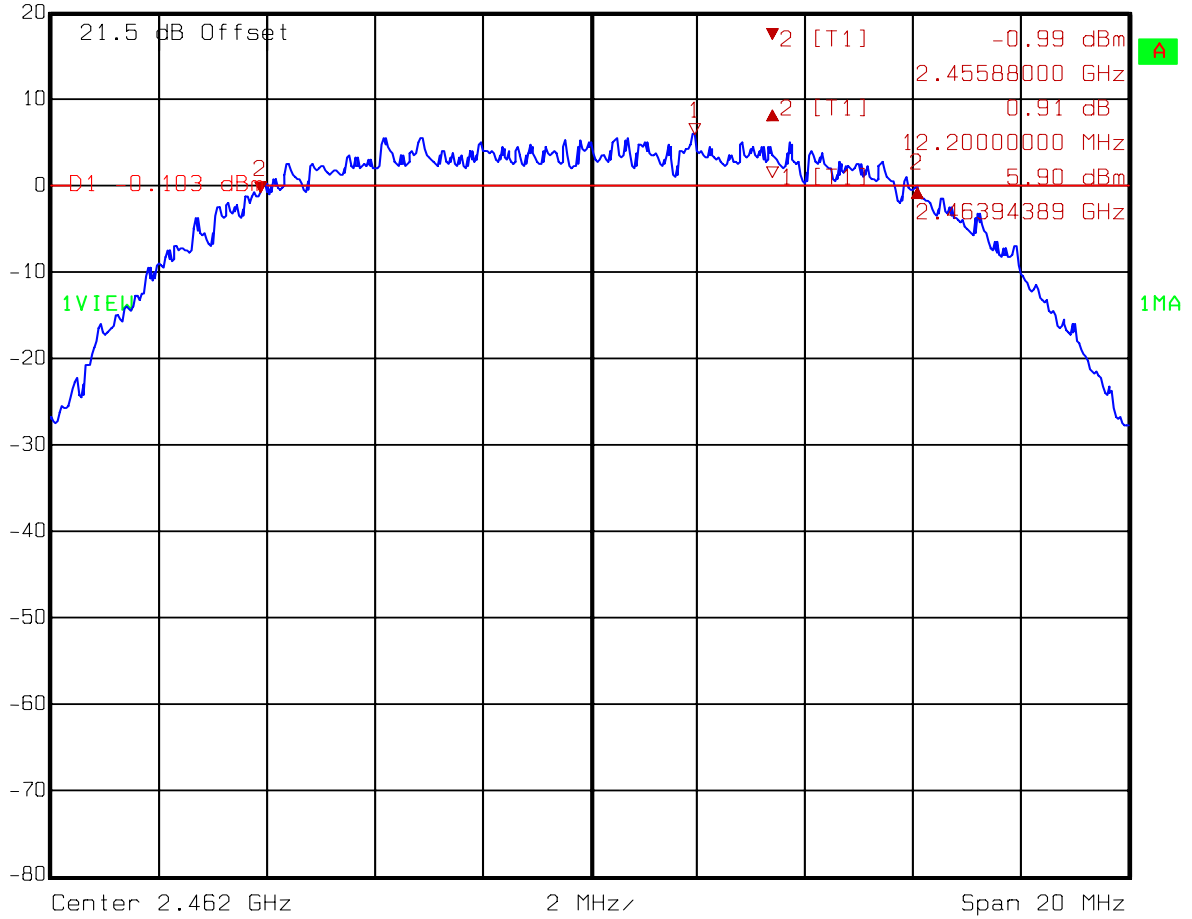

Title: 6dB Bandwidth  
 Comment A: Channel 11 at 802.11b mode  
 Date: 09.MAR.2006 14:53:22

## Test Mode: 802.11g(OFDM Modulation) operating mode

	Max/Ref Lvl	Delta 2 [T1]	RBW	100 kHz	RF Att	10 dB
	20 dBm	-0.60 dB	VBW	100 kHz		
	1.5 dBm	16.60000000 MHz	SWT	5 ms	Unit	dBm

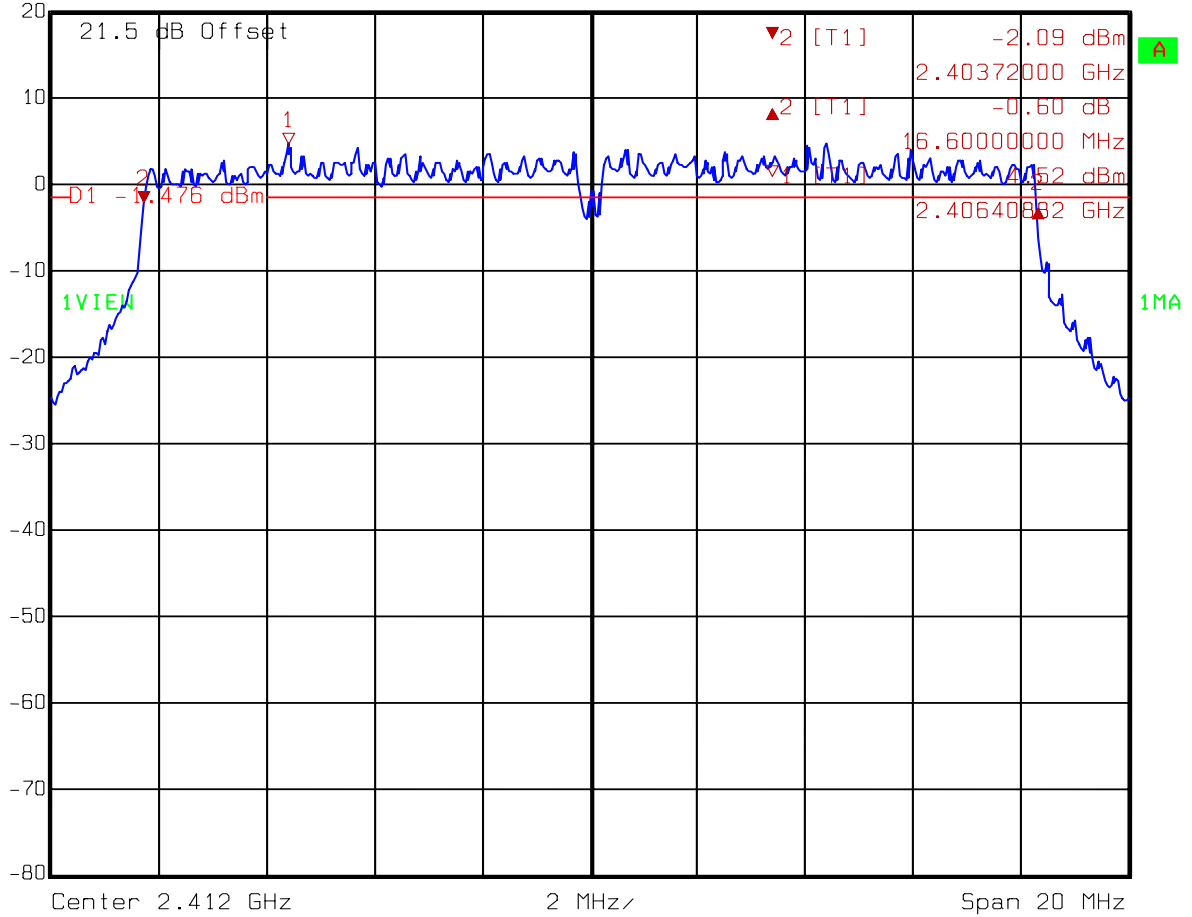

Title: 6dB Bandwidth  
 Comment A: Channel 1 at 802.11g mode  
 Date: 09.MAR.2006 15:00:17

	Max/Ref Lvl     Delta 2 [T1]	RBW     100 kHz	RF Att     10 dB
	20 dBm                     0.58 dB	VBW     100 kHz	
	1.5 dBm                    16.56000000 MHz	SWT     5 ms	Unit                     dBm

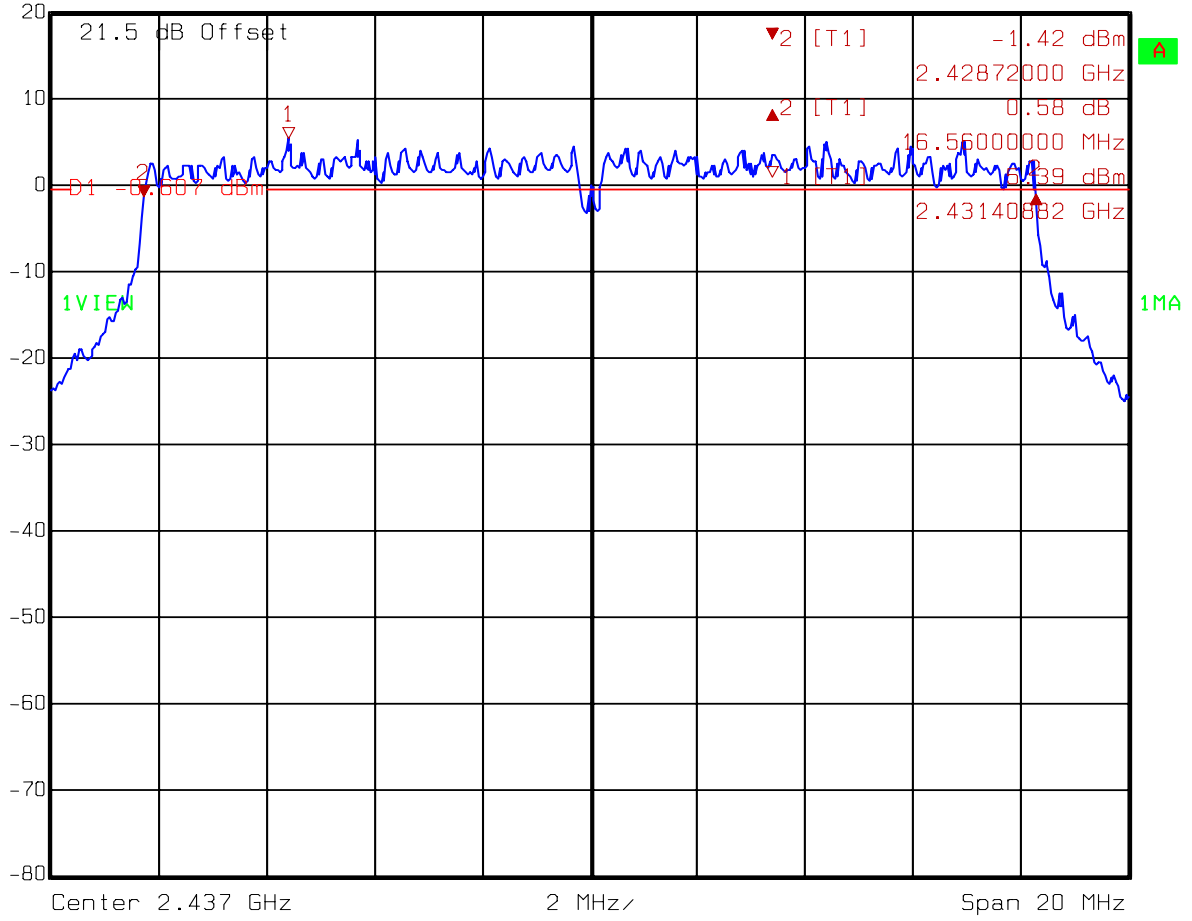

Title:            6dB Bandwidth  
 Comment A: Channel 6 at 802.11g mode  
 Date:            09.MAR.2006 15:11:35

	Max/Ref Lvl     Delta 2 [T1]	RBW    100 kHz	RF Att    10 dB
	20 dBm                     -1.49 dB	VBW    100 kHz	
	1.5 dBm                    16.60000000 MHz	SWT    5 ms	Unit                     dBm

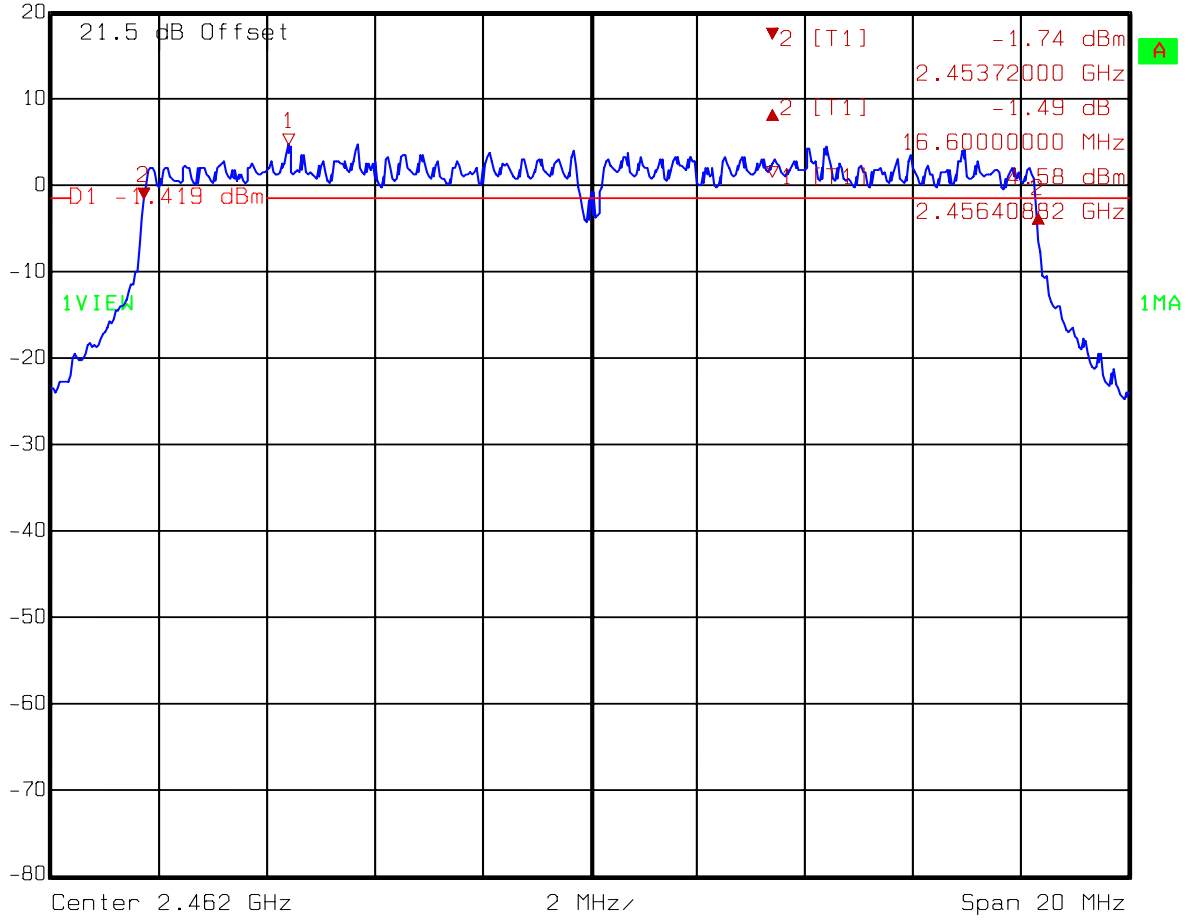

Title:            6dB Bandwidth  
 Comment A: Channel 11 at 802.11g mode  
 Date:            09.MAR.2006 15:07:51

#### 4. Maximum Output Power test

##### 4.1 Operating environment

Temperature: 25  
 Relative Humidity: 55 %  
 Atmospheric Pressure: 1023 hPa

##### 4.2 Test setup & procedure

The power output per FCC §15.247(b) was measured on the EUT using a 50 ohm SMA cable connected to peak power meter via power sensor. Power was read directly and cable loss correction (1.5 dB) was added to the reading to obtain power at the EUT antenna terminals. The test was performed at 3 channels (lowest, middle and highest channel).

##### 4.3 Measured data of Maximum Output Power test results

Test Mode: 802.11b (DSSS Modulation) operating mode

Channel	Freq. (MHz)	C.L. (dB)	Reading (dBm)	Conducted Peak Output Power		Limit (W)
				(dBm)	(mW)	
1 (lowest)	2412	1.5	17.58	19.08	80.91	1
6 (middle)	2437	1.5	18.04	19.54	89.95	1
11 (highest)	2462	1.5	17.55	19.05	80.35	1

Remark:

Conducted Peak Output Power = Reading + C.L.

Test Mode: 802.11g (OFDM Modulation) operating mode

Channel	Freq. (MHz)	C.L. (dB)	Reading (dBm)	Conducted Peak Output Power		Limit (W)
				(dBm)	(mW)	
1 (lowest)	2412	1.5	23.86	25.36	343.56	1
6 (middle)	2437	1.5	24.37	25.87	386.37	1
11 (highest)	2462	1.5	24.07	25.57	360.58	1

Remark:

Conducted Peak Output Power = Reading + C.L.



## 5. Radiated Emission test

### 5.1 Operating environment

Temperature:	25	
Relative Humidity:	55	%
Atmospheric Pressure:	1023	hPa

### 5.2 Test setup & procedure

The Diagram below shows the test setup, which is utilized to make these measurements.

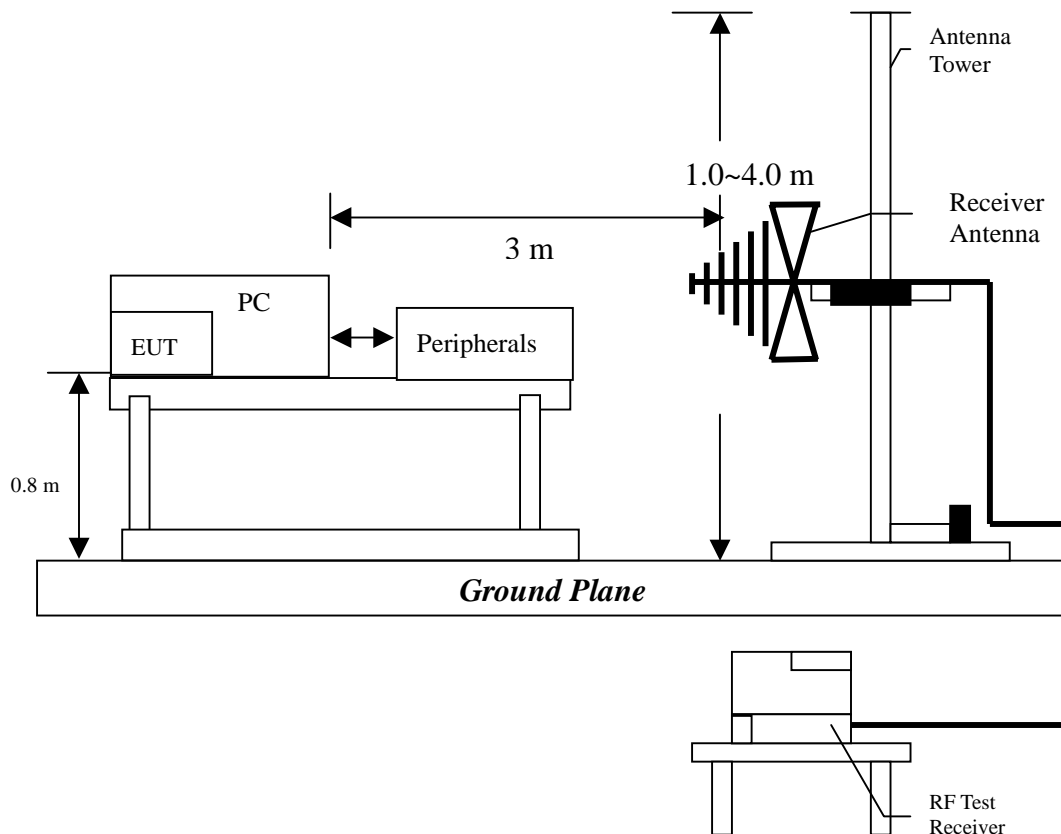

The signal is maximized through rotation and placement in the three orthogonal axes. (The red line is for portable device (please check with reviewer or testing engineer before delete it)) Radiated emissions were investigated cover the frequency range from 30MHz to 1000MHz using a receiver RBW of 120kHz record QP reading, and the frequency over 1GHz using a spectrum analyzer RBW of 1MHz and 10Hz VBW record Average reading. (15.209 paragraph), the Peak reading (1MHz RBW/VBW) recorded also on the report.

The EUT for testing is arranged on a wooden turntable. If some peripherals apply to the EUT, the peripherals will be connected to EUT and the whole system. During the test, all cables were arranged to produce worst-case emissions. The signal is maximized through rotation. The height of antenna and polarization is changing constantly for exploring for maximum signal level. The height of antenna can be up to 4 meters and down to 1 meter.

The measurement for radiated emission will be done at the distance of three meters unless the signal level is too low to measure at that distance. In the case of the reading under noise floor, a pre-amplifier is used and/or the test is conducted at a closer distance. And then all readings are extrapolated back to the equivalent 3 meter reading using inverse scaling with distance.

The EUT configuration please refer to the “Spurious set-up photo.pdf”.

**5.3 Emission limits**

The spurious Emission shall test through the 10th harmonic. In addition, radiated emissions which fall in the restricted bands, as defined in §15.205(a), must also comply with the radiated emission limits specified in §15.209(a).

Frequency (MHz)	Limits (dB $\mu$ V/m@3m)
30-88	40
88-216	43.5
216-960	46
Above 960	54

Remark:

1. In the above table, the tighter limit applies at the band edges.
2. Distance refers to the distance in meters between the measuring instrument antenna and the closed point of any part of the device or system

Uncertainty was calculated in accordance with NAMAS NIS 81.  
Expanded uncertainty (k=2) of radiated emission measurement is 4.98 dB.

### 5.4 Radiated spurious emission test data

#### 5.4.1 Measurement results: frequencies equal to or less than 1 GHz

The test was performed on EUT under 802.11b and 802.11g continuously transmitting mode. Channel 1, 6, 11 were verified. The worst case occurred at 802.11b Tx channel 1.

EUT : WCP5102  
 Worst Case : 802.11b Tx at channel 1

Antenna Polariz. (V/H)	Freq. (MHz)	Receiver Detector	Corr. Factor (dB/m)	Reading (dBuV)	Corrected Level (dBuV/m)	Limit @ 3 m (dBuV/m)	Margin (dB)
V	62.980	QP	11.69	12.74	24.44	40.00	-15.56
V	80.440	QP	8.45	23.24	37.70	40.00	-8.30
V	148.340	QP	15.57	20.09	35.66	43.50	-7.84
V	431.580	QP	17.23	15.97	33.20	46.00	-12.80
V	623.640	QP	21.10	10.63	31.73	46.00	-14.27
V	718.700	QP	22.48	9.31	31.79	46.00	-14.21
H	84.320	QP	8374	24.03	32.77	40.00	-7.23
H	150.280	QP	13.61	14.44	28.05	43.50	-15.45
H	233.700	QP	11.97	18.58	30.55	46.00	-15.45
H	299.660	QP	14.31	17.43	31.74	46.00	-14.26
H	431.580	QP	17.66	16.14	33.80	46.00	-12.20
H	565.440	QP	20.08	11.58	31.66	46.00	-14.34

Remark:

1. Corr. Factor = Antenna Factor + Cable Loss
2. Corrected Level = Reading + Corr. Factor

**5.4.2 Measurement results: frequency above 1GHz**

EUT : WCP5102  
Test Condition : 802.11b Tx at channel 1, 6, 11

No spurious emission was found above the spectrum analyzer’s noise floor.

Noise floor level is :

For PK:  
1GHz-3GHz: 20dBuV  
3GHz-14GHz: 27dBuV  
14GHz-26.5GHz: 39dBuV

For AV:  
1GHz-3GHz: 10dBuV  
3GHz-14GHz: 16dBuV  
14GHz-26.5GHz: 28dBuV

EUT : WCP5102  
Test Condition : 802.11g Tx at channel 1

Frequency (MHz)	Spectrum Analyzer Detector	Antenna Polariz. (H/V)	Preamp. Gain (dB)	Correction Factor (dB/m)	Reading (dBuV)	Corrected Level (dBuV/m)	Limit @ 3 m (dBuV/m)	Margin (dB)	Ant. high (cm)	Turn Table angle (degree)
7230.00	PK	V	36.18	43.97	50.61	58.4	74	-15.6	299.00	101.00
7230.00	AV	V	36.18	43.97	34.88	42.67	54	-11.33	299.00	101.00

**Remark:**

1. Correction Factor = Antenna Factor + Cable Loss
2. Corrected Level = Reading + Correction Factor – Preamp. Gain
3. The frequency measured ranges from 1GHz to 25GHz. The data value listed above which is higher than the noise floor, the others please refer to noise floor level.

Noise floor level is :

For PK:  
1GHz-3GHz: 20dBuV  
3GHz-14GHz: 27dBuV  
14GHz-26.5GHz: 39dBuV

For AV:  
1GHz-3GHz: 10dBuV  
3GHz-14GHz: 16dBuV  
14GHz-26.5GHz: 28dBuV

EUT : WCP5102  
 Test Condition : 802.11g Tx at channel 6

Frequency (MHz)	Spectrum Analyzer Detector	Antenna Polariz. (H/V)	Preamp. Gain (dB)	Correction Factor (dB/m)	Reading (dBuV)	Corrected Level (dBuV/m)	Limit @ 3 m (dBuV/m)	Margin (dB)	Ant. high (cm)	Turn Table angle (degree)
7320.00	PK	V	36.18	43.97	50.13	57.92	74	-16.08	303.00	100.00
7320.00	AV	V	36.18	43.97	34.46	42.25	54	-11.75	303.00	100.00

**Remark:**

1. “\*”: Fundamental Frequency
2. Correction Factor = Antenna Factor + Cable Loss
3. Corrected Level = Reading + Correction Factor – Preamp. Gain
4. The frequency measured ranges from 1GHz to 25GHz. The data value listed above which is higher than the noise floor, the others please refer to noise floor level.

Noise floor level is:

For PK:

- 1GHz-3GHz: 20dBuV
- 3GHz-14GHz: 27dBuV
- 14GHz-26.5GHz: 39dBuV

For AV:

- 1GHz-3GHz: 10dBuV
- 3GHz-14GHz: 16dBuV
- 14GHz-26.5GHz: 28dBuV

EUT : WCP5102  
 Test Condition : 802.11g Tx at channel 11

Frequency (MHz)	Spectrum Analyzer Detector	Antenna Polariz. (H/V)	Preamp. Gain (dB)	Correction Factor (dB/m)	Reading (dBuV)	Corrected Level (dBuV/m)	Limit @ 3 m (dBuV/m)	Margin (dB)	Ant. high (cm)	Turn Table angle (degree)
6570.00	PK	V	36.58	42.96	43.62	50	74	-24	18.00	105.00
6570.00	AV	V	36.58	42.96	36.12	42.5	54	-11.5	18.00	105.00
7380.00	PK	V	36.18	43.97	47.32	55.11	74	-18.89	294.00	102.00
7380.00	AV	V	36.18	43.97	32.6	40.39	54	-13.61	294.00	102.00

**Remark:**

1. “\*”: Fundamental Frequency
2. Correction Factor = Antenna Factor + Cable Loss
3. Corrected Level = Reading + Correction Factor – Preamp. Gain
4. The frequency measured ranges from 1GHz to 25GHz. The data value listed above which is higher than the noise floor, the others please refer to noise floor level.

Noise floor level is:

For PK:

- 1GHz-3GHz: 20dBuV
- 3GHz-14GHz: 27dBuV
- 14GHz-26.5GHz: 39dBuV

For AV:

- 1GHz-3GHz: 10dBuV
- 3GHz-14GHz: 16dBuV
- 14GHz-26.5GHz: 28dBuV

## 6. Power Spectrum Density test

### 6.1 Operating environment

Temperature: 25  
 Relative Humidity: 55 %  
 Atmospheric Pressure 1023 hPa

### 6.2 Test setup & procedure

The power spectrum density per FCC §15.247(e) was measured from the antenna port of the EUT using a 50ohm spectrum analyzer with the resolution bandwidth set at 3kHz, the video bandwidth set at 10kHz, a span of 300kHz, and the sweep time set at 100 seconds. Power Density was read directly correction was added to the reading to obtain power at the EUT antenna terminals. The test was performed at 3 channels (lowest, middle and highest channel). The Power Spectral Density measured result is in the following table.

### 6.3 Measured data of Power Spectrum Density test results

Test Mode: 802.11b (DSSS Modulation) operating mode

Channel	Frequency (MHz)	Power spectrum density (dBm)	Limit (dBm)
1 (lowest)	2412	-9.06	8.00
6 (middle)	2437	-8.71	8.00
11 (highest)	2462	-9.22	8.00

Test Mode: 802.11g (OFDM Modulation) operating mode

Channel	Frequency (MHz)	Power spectrum density (dBm)	Limit (dBm)
1 (lowest)	2412	-11.75	8.00
6 (middle)	2437	-10.99	8.00
11 (highest)	2462	-10.10	8.00

Please see the plot below.

## Test Mode: 802.11b(Power Spectral Density) operating mode

	Max/Ref Lvl	Marker 1 [T1]	RBW	3 kHz	RF Att	10 dB
	13 dBm	-9.06 dBm	VBW	10 kHz		
	1.5 dBm	2.41386182 GHz	SWT	100 s	Unit	dBm

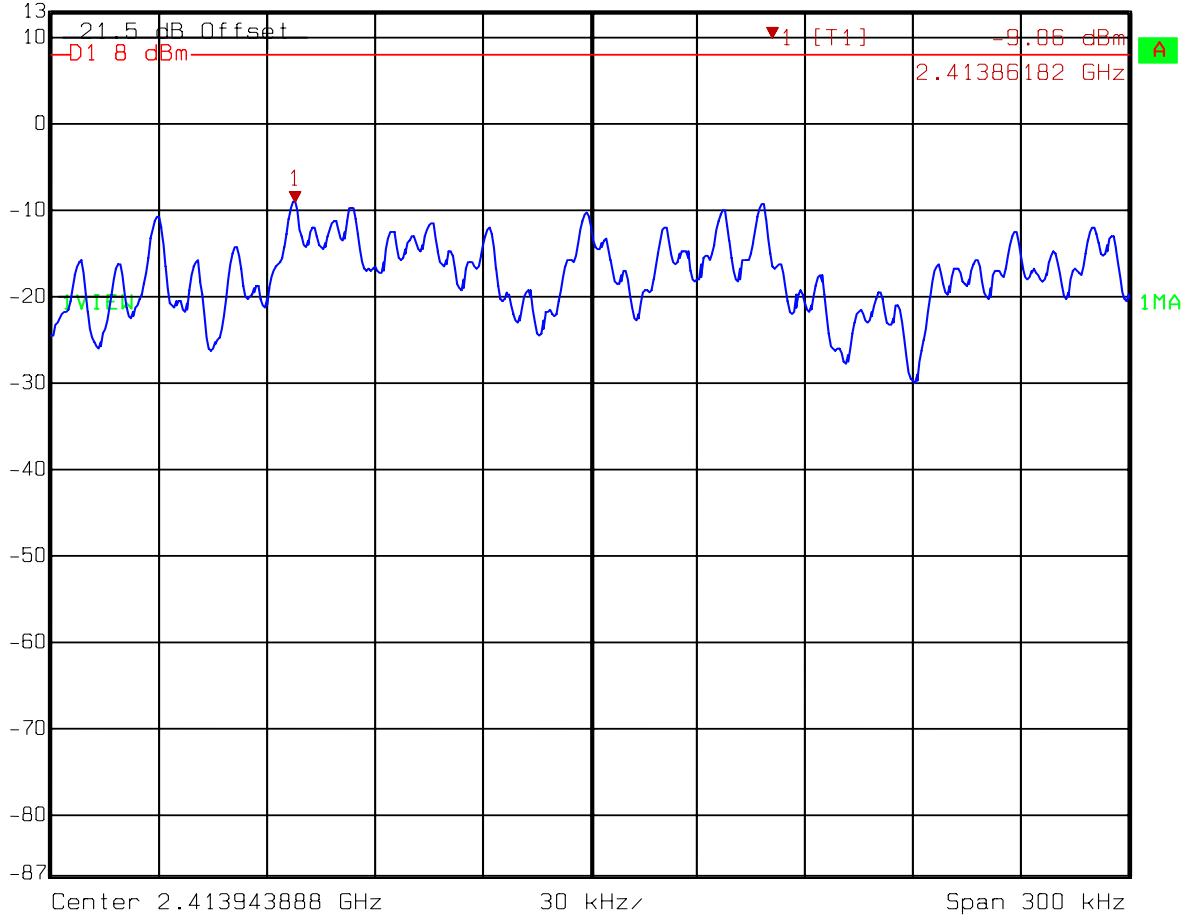

Title: Power Spectrum Density  
 Comment A: Channel 1 at 802.11b mode  
 Date: 09.MAR.2006 14:44:24



	Max/Ref Lvl	Marker 1 [T1]	RBW	3 kHz	RF Att	10 dB
	13 dBm	-8.71 dBm	VBW	10 kHz		
	1.5 dBm	2.43886182 GHz	SWT	100 s	Unit	dBm

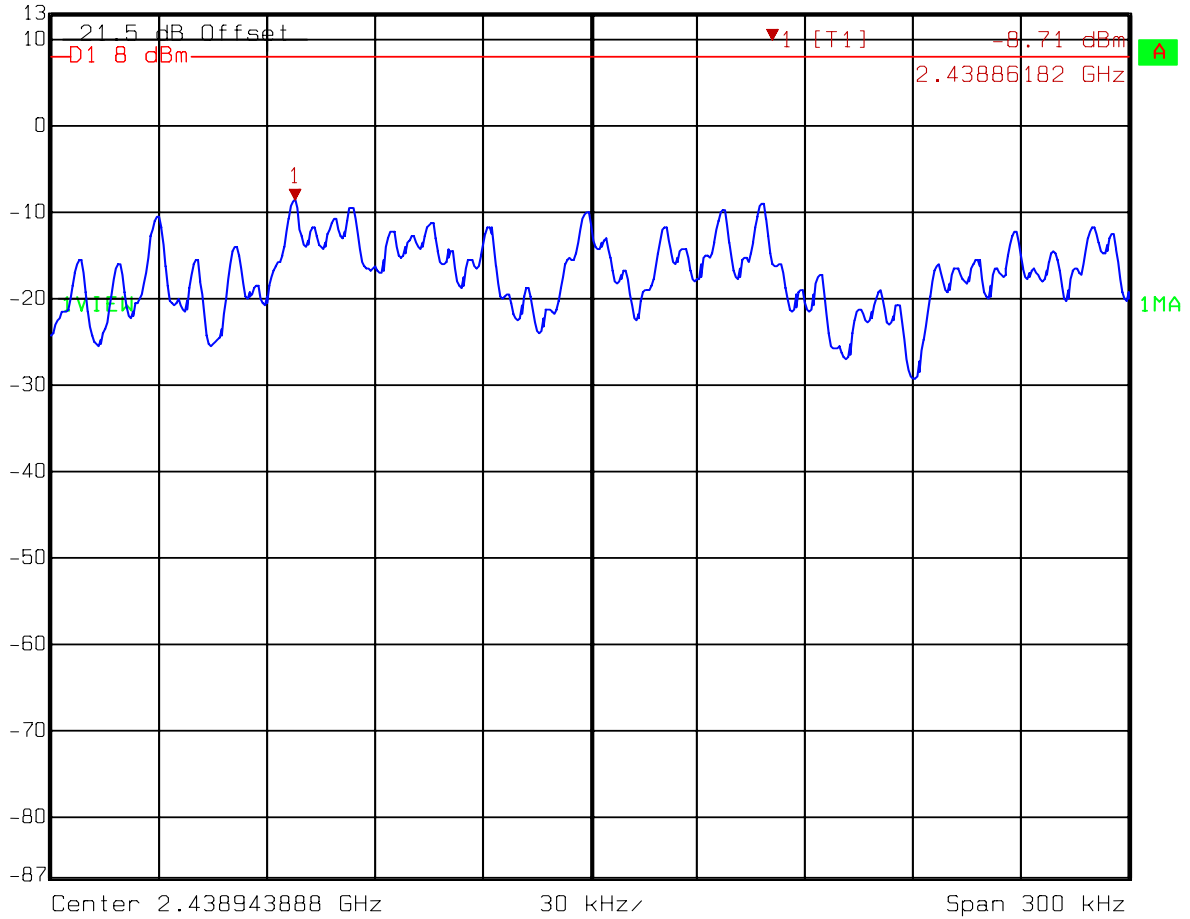

Title: Power Spectrum Density  
 Comment A: Channel 6 at 802.11b mode  
 Date: 09.MAR.2006 14:58:27

	Max/Ref Lvl	Marker 1 [T1]	RBW	3 kHz	RF Att	10 dB
	13 dBm	-9.22 dBm	VBW	10 kHz		
	1.5 dBm	2.46386182 GHz	SWT	100 s	Unit	dBm

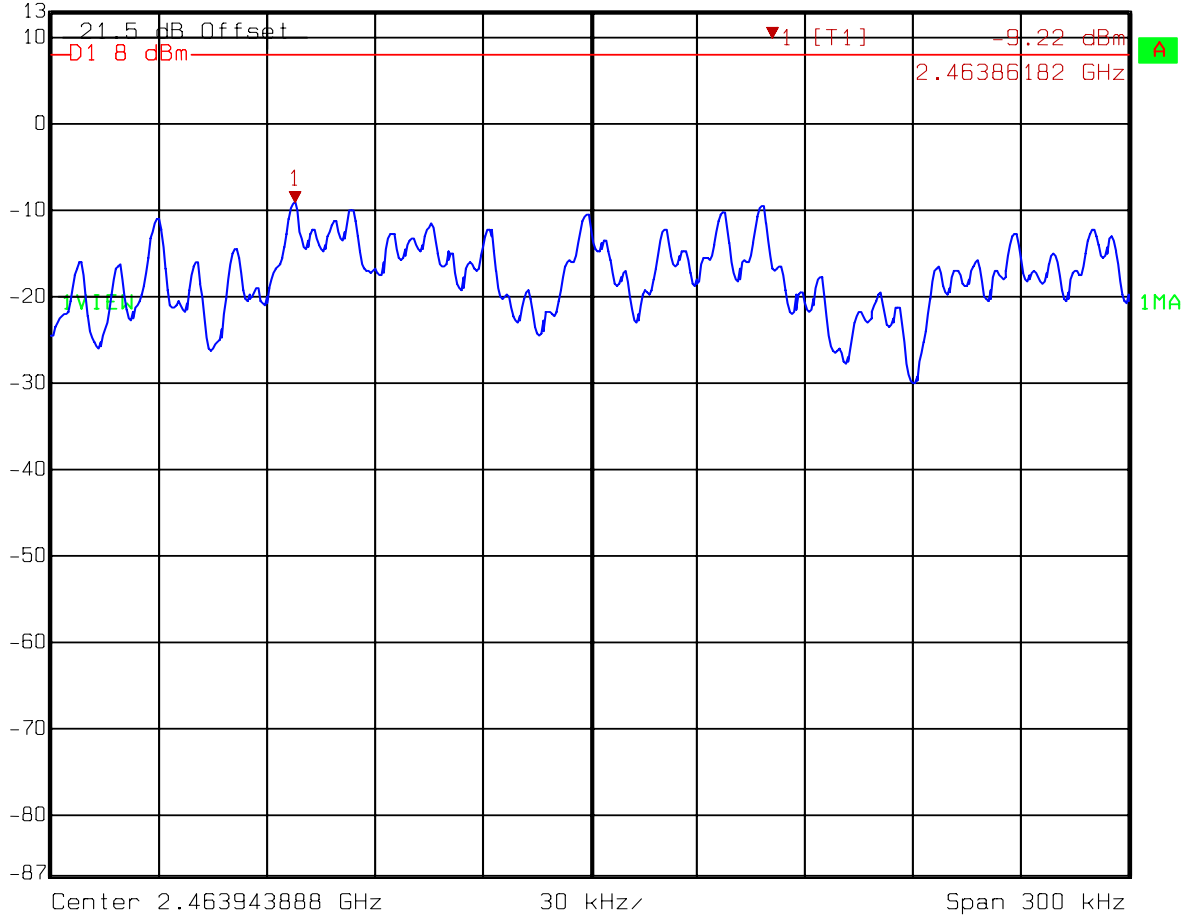

Title: Power Spectrum Density  
 Comment A: Channel 11 at 802.11b mode  
 Date: 09.MAR.2006 14:53:41

## Test Mode: 802.11g(Power Spectral Density) operating mode

	Max/Ref Lvl	Marker 1 [T1]	RBW	3 kHz	RF Att	10 dB
	13 dBm	-11.75 dBm	VBW	10 kHz		
	1.5 dBm	2.40640671 GHz	SWT	100 s	Unit	dBm

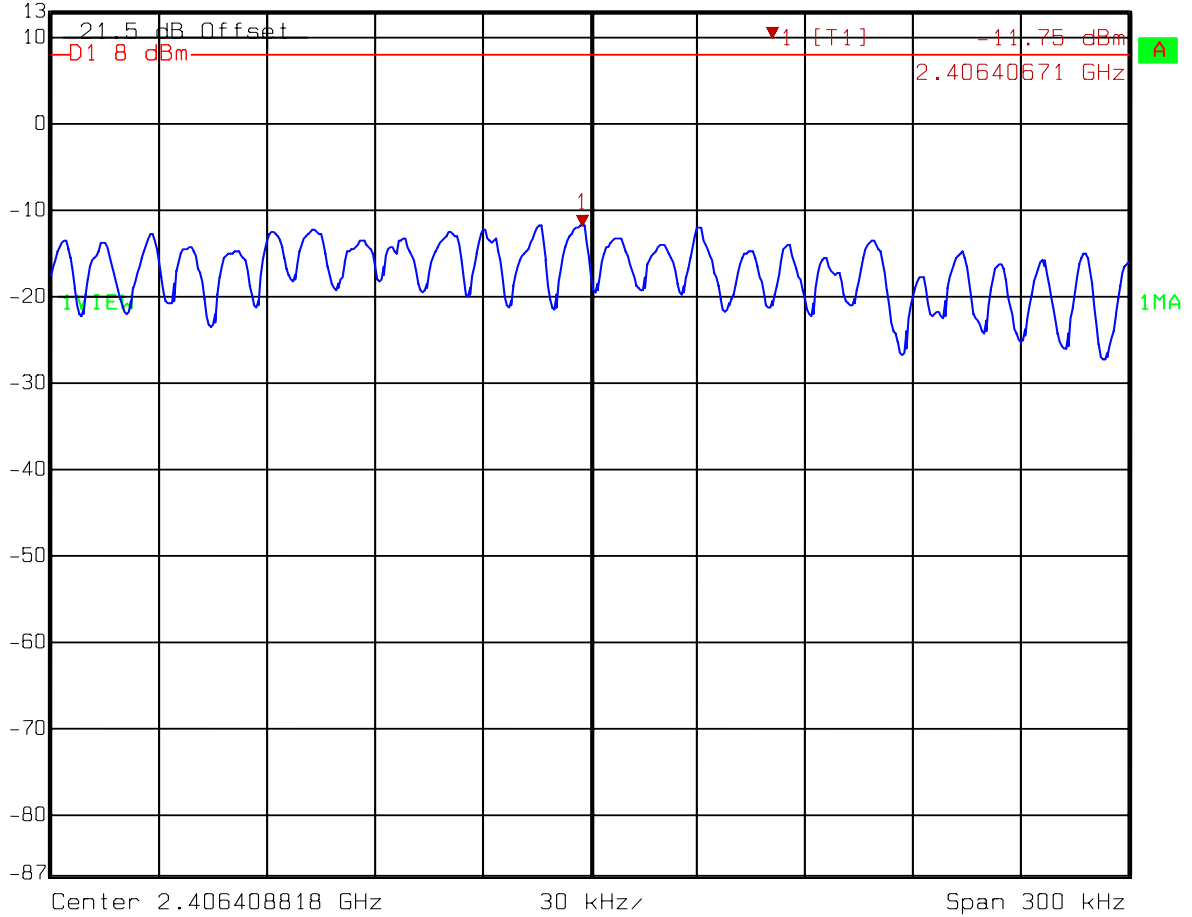

Title: Power Spectrum Density  
 Comment A: Channel 1 at 802.11g mode  
 Date: 09.MAR.2006 15:00:36

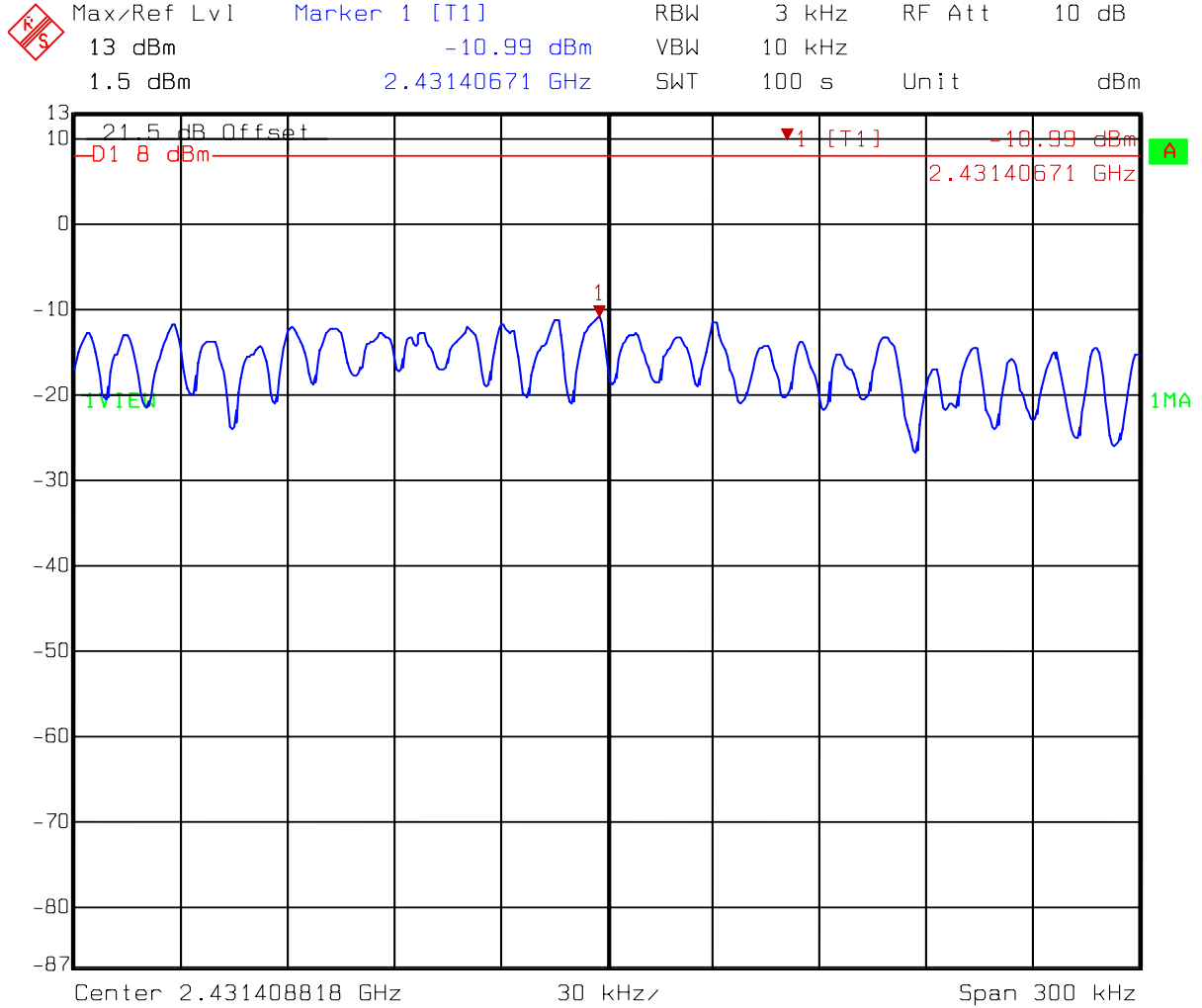

Title:            Power Spectrum Density  
 Comment A: Channel 6 at 802.11g mode  
 Date:            09.MAR.2006 15:11:54

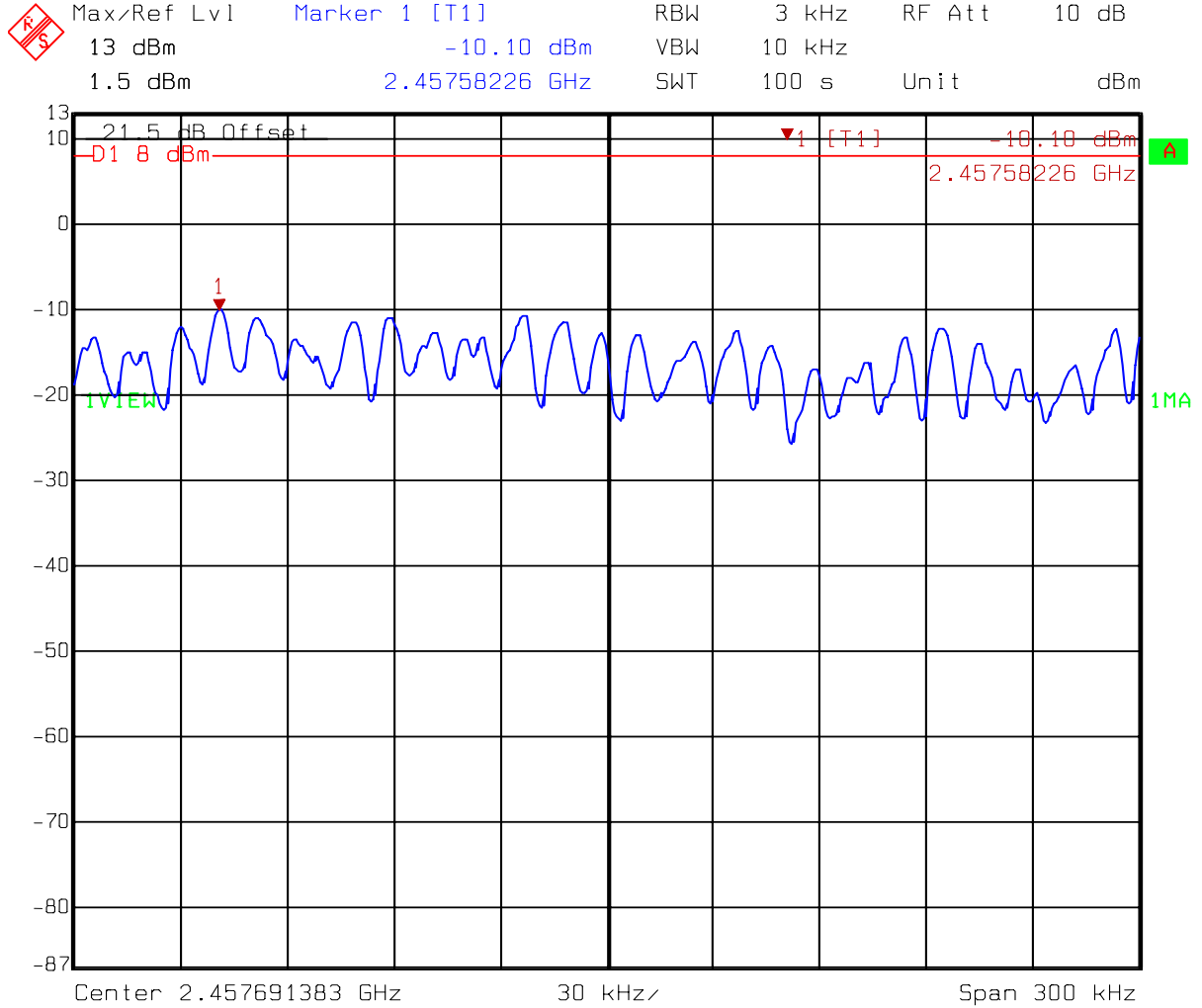

Title: Power Spectrum Density  
 Comment A: Channel 11 at 802.11g mode  
 Date: 09.MAR.2006 15:08:10

## **7. Emission on the band edge**

In any 100kHz bandwidth outside the frequency band in which the spread spectrum intentional radiator is operating, the radio frequency power that is produced by the intentional radiator shall be at least 20 dB below that in the 100 KHz bandwidth within the band that contains the highest level of the desired power, based on either an RF conducted or a radiated measurement.

### **7.1 Operating environment**

Temperature:	25	
Relative Humidity:	55	%
Atmospheric Pressure	1023	hPa

### **7.2 Test setup & procedure**

The output of EUT was connected to spectrum analyzer via a 50ohm cable.

The setting of spectrum analyzer is:

Peak:	RBW = 100kHz ;	VBW = 100kHz
Average:	RBW = 1MHz ;	VBW = 10Hz

## 7.3 Test Result

### 7.3.1 Conducted Method

#### Test Mode: 802.11b(DSSS Modulation) operating mode

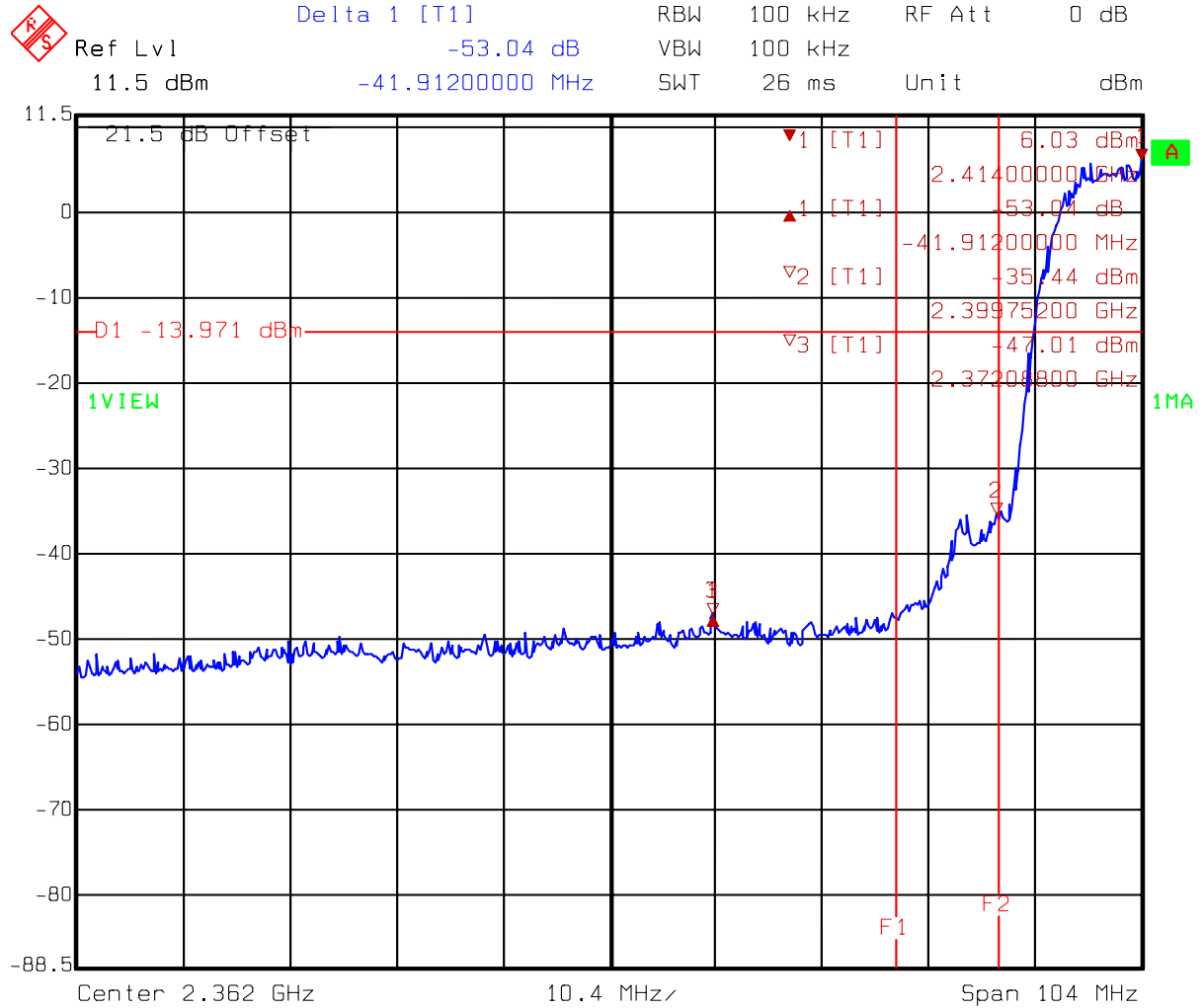

Title: Band Edge  
 Comment A: Channel 1 at 802.11b mode  
                   F1=2390MHz F2=2400MHz (Peak Detect)  
 Date: 09.MAR.2006 14:45:16

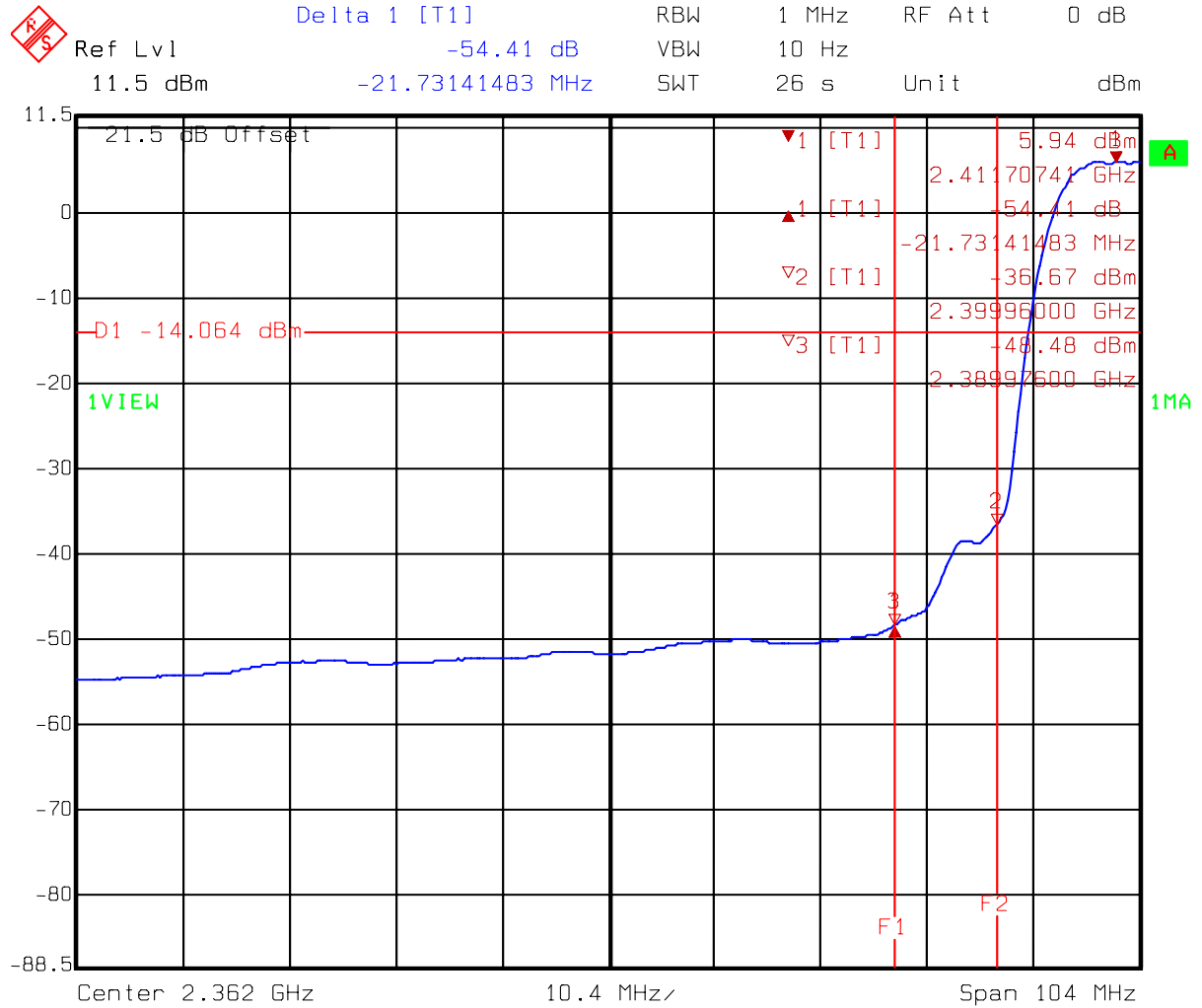

Title: Band Edge  
 Comment A: Channel 1 at 802.11b mode  
 F1=2390MHz F2=2400MHz (Average Detect)  
 Date: 09.MAR.2006 14:46:09



⚠ Delta 1 [T1]      RBW 100 kHz    RF Att 0 dB  
 Ref Lvl 11.5 dBm      -52.00 dB      VBW 100 kHz  
19.91214429 MHz      SWT 10 ms      Unit dBm

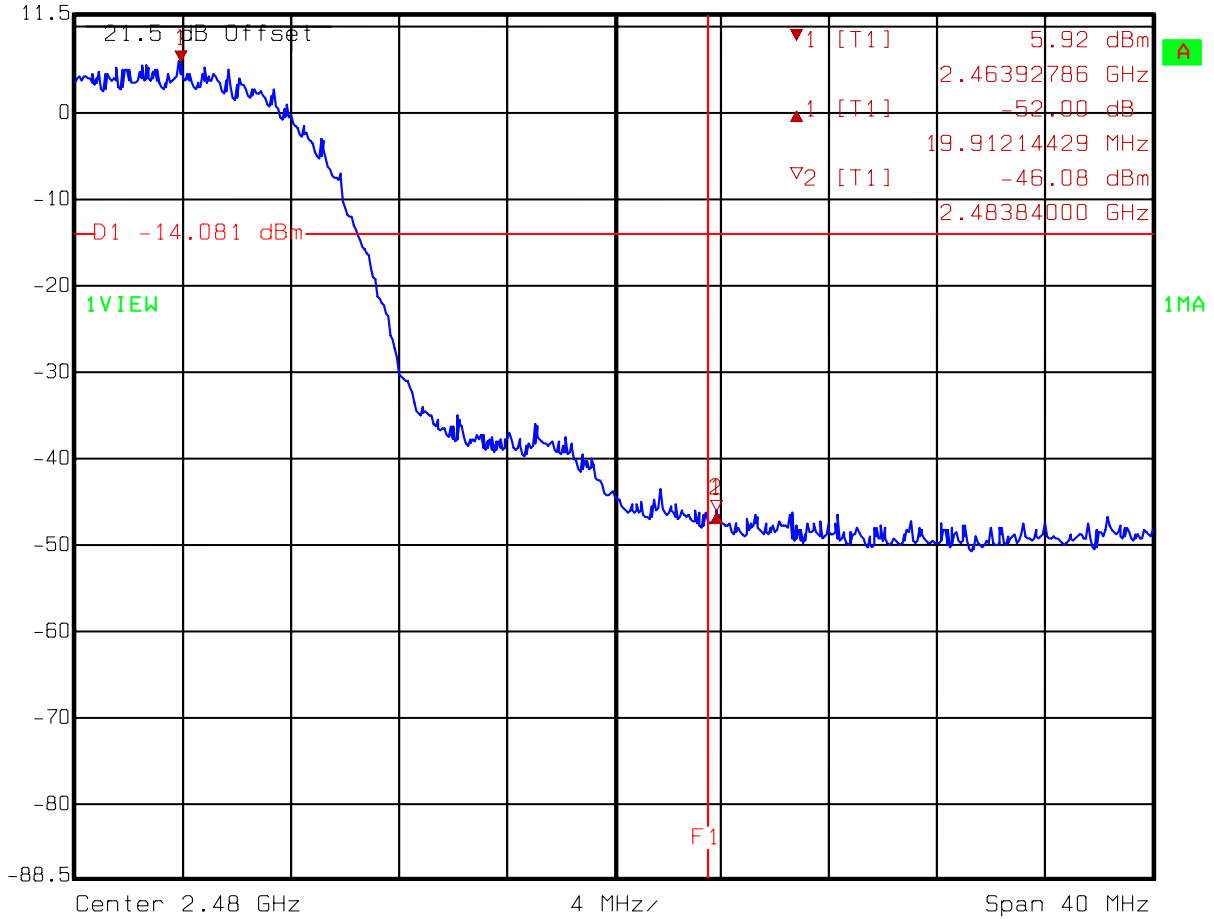

Title: Band Edge  
 Comment A: Channel 11 at 802.11b mode  
             F1=2483.5MHz (Peak Detect)  
 Date: 09.MAR.2006 14:54:10

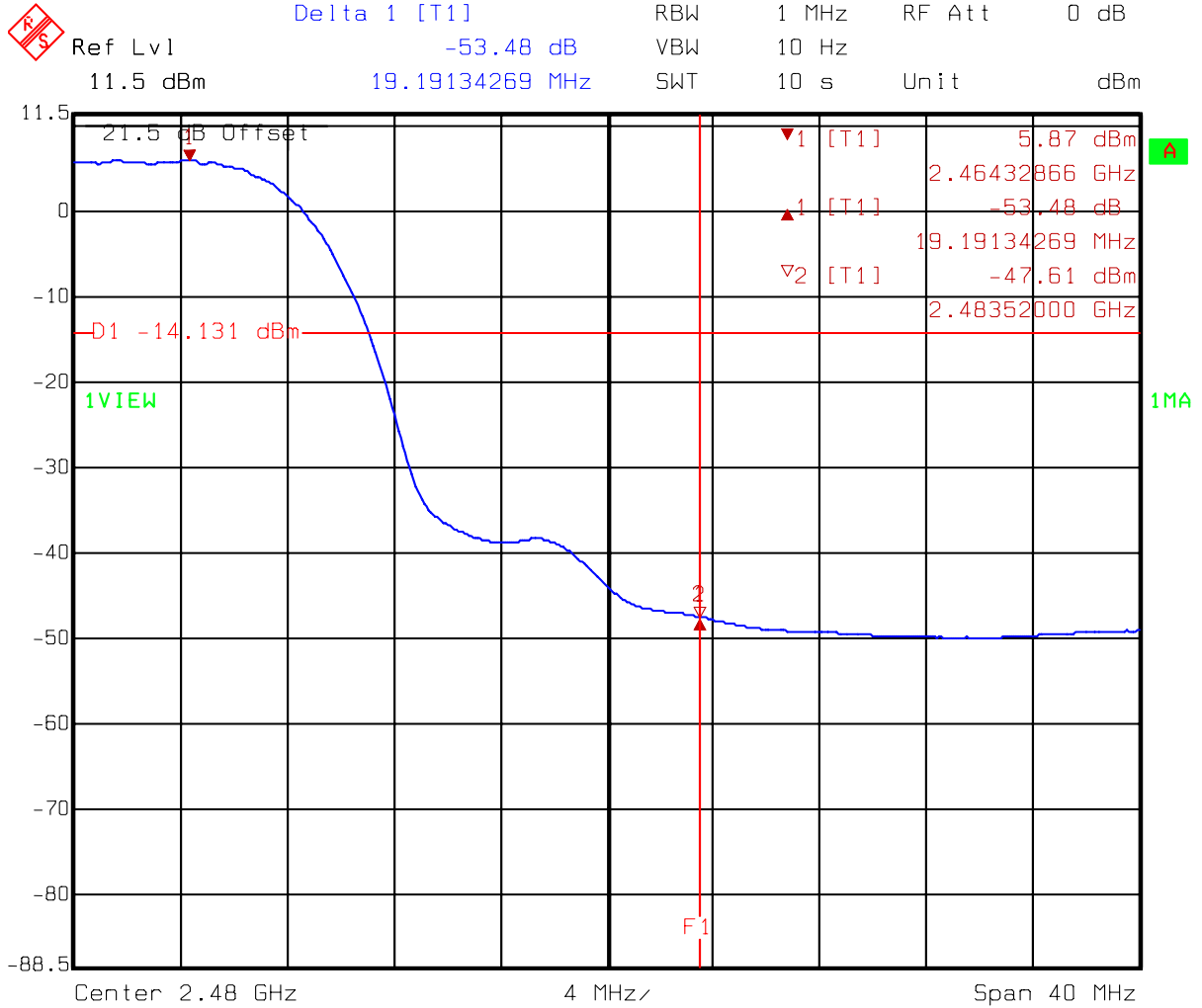

Title: Band Edge  
 Comment A: Channel 11 at 802.11b mode  
 F1=2483.5MHz (Average Detect)  
 Date: 09.MAR.2006 14:54:58

## Test Mode: 802.11g(OFDM Modulation) operating mode

	<b>Delta 1 [T1]</b>	RBW	100 kHz	RF Att	0 dB
	Ref Lvl		-49.31 dB	VBW	100 kHz
	11.5 dBm		-16.52099399 MHz	SWT	26 ms
				Unit	dBm

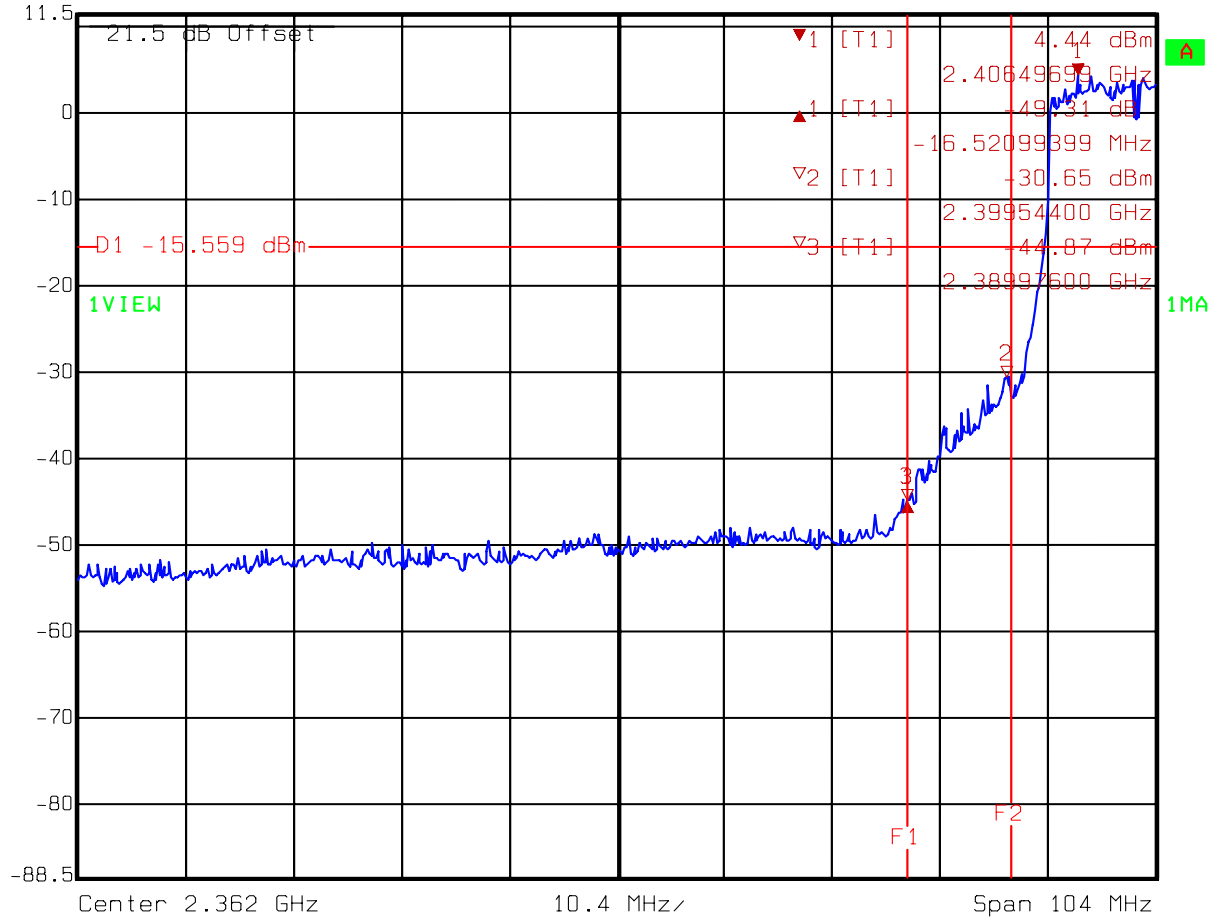

Title: Band Edge  
 Comment A: Channel 1 at 802.11g mode  
 F1=2390MHz F2=2400MHz (Peak Detect)  
 Date: 09.MAR.2006 15:01:09

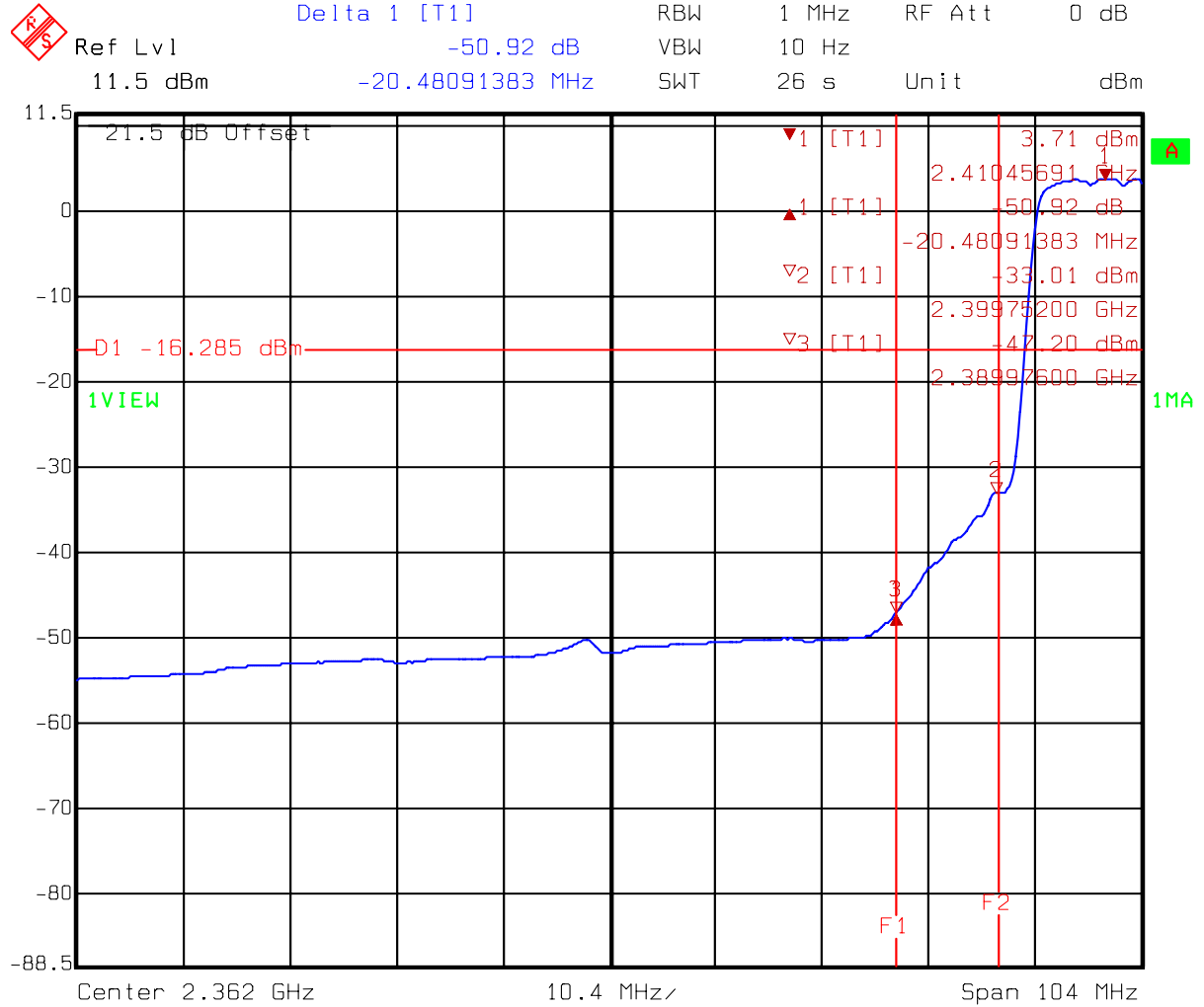

Title: Band Edge  
 Comment A: Channel 1 at 802.11g mode  
 F1=2390MHz F2=2400MHz (Average Detect)  
 Date: 09.MAR.2006 15:02:03

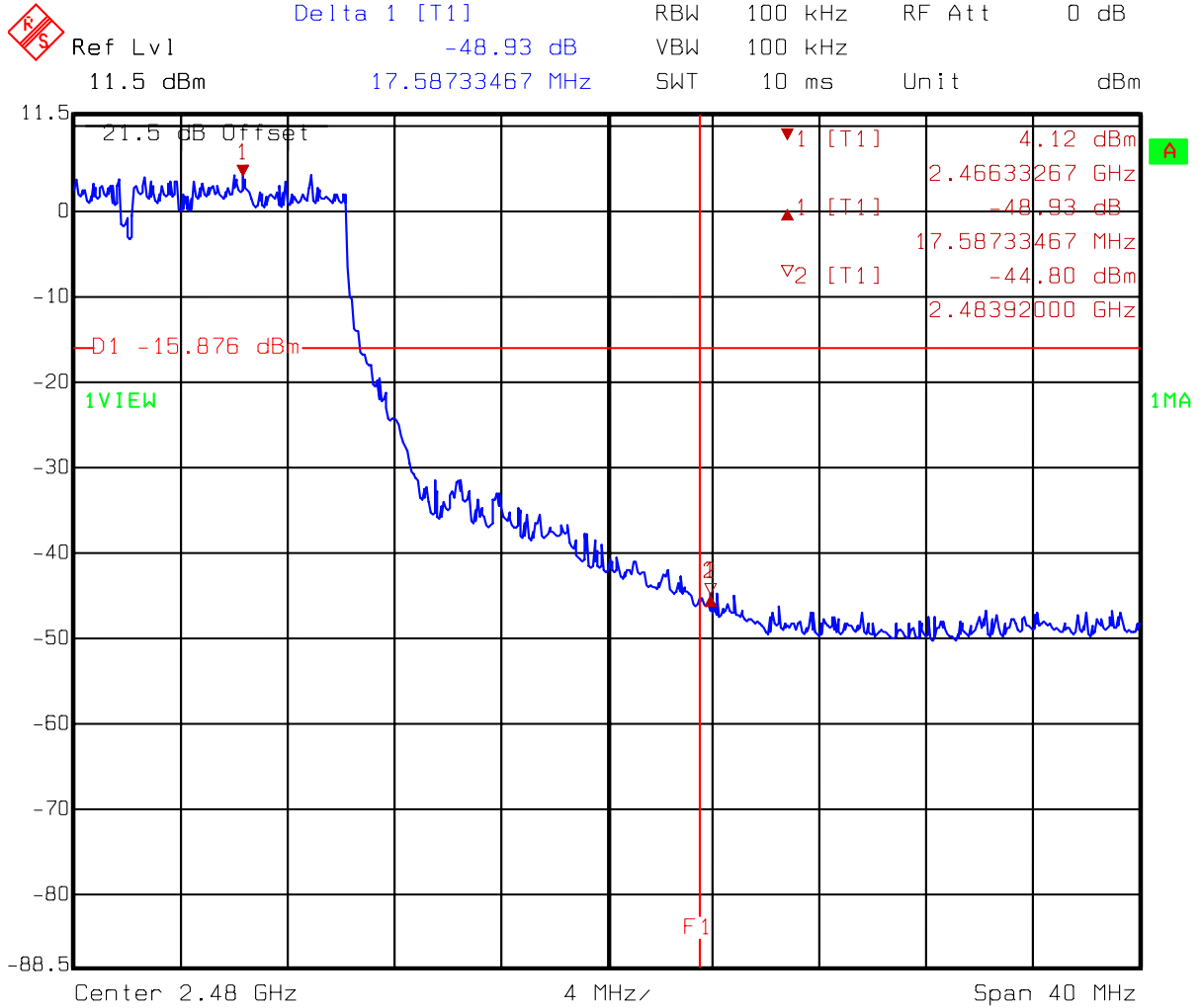

Title: Band Edge  
 Comment A: Channel 11 at 802.11g mode  
                   F1=2483.5MHz (Peak Detect)  
 Date: 09.MAR.2006 15:08:39

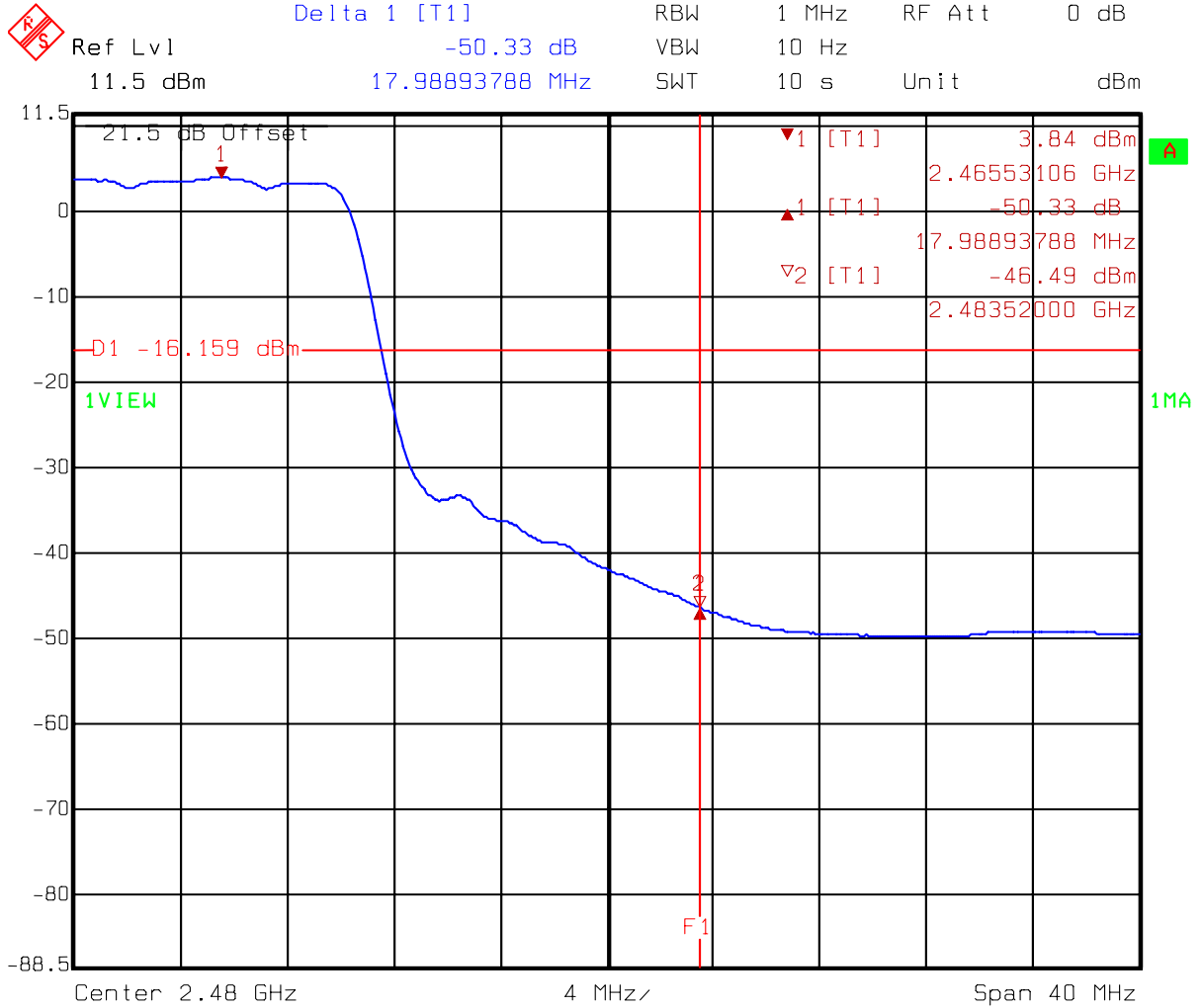

Title: Band Edge  
 Comment A: Channel 11 at 802.11g mode  
 F1=2483.5MHz (Average Detect)  
 Date: 09.MAR.2006 15:09:27

**7.3.2 Radiated Method**

**Test Mode: 802.11b(DSSS Modulation) operating mode**

Channel	Detector	Radiated Method	Conducted Method	The Max. Field Strength in Restrict Band (dBuV/m)	Limit @ 3 m (dBuV/m)	Margin (dB)
		Max. Field Strength of Fundamental @3m (dBuV/m)	Between Carrier Max. Power and Local Max. Emission in Restrict Band (dBc)			
		A	B			
1 (lowest)	PK	112.8	53.04	59.76	74	-14.24
	AV	108.1	54.41	53.69	54	-0.31
11 (highest)	PK	113.86	52	61.86	74	-12.14
	AV	107.2	53.48	53.72	54	-0.28

Remark: 1.  $C = A - B$

2.  $E = C - D$

**Test Mode: 802.11g(OFDM Modulation) operating mode**

Channel	Detector	Radiated Method	Conducted Method	The Max. Field Strength in Restrict Band (dBuV/m)	Limit @ 3 m (dBuV/m)	Margin (dB)
		Max. Field Strength of Fundamental @3m (dBuV/m)	Between Carrier Max. Power and Local Max. Emission in Restrict Band (dBc)			
		A	B			
1 (lowest)	PK	117.95	49.31	68.64	74	-5.36
	AV	104.6	50.92	53.68	54	-0.32
11 (highest)	PK	117.93	48.93	69.00	74	-5.00
	AV	103.5	50.33	53.17	54	-0.83

Remark: 1.  $C = A - B$

2.  $E = C - D$



## 8. Power Line Conducted Emission test §FCC 15.207

### 8.1 Operating environment

Temperature: 25  
Relative Humidity: 55 %  
Atmospheric Pressure 1023 hPa

### 8.2 Test setup & procedure

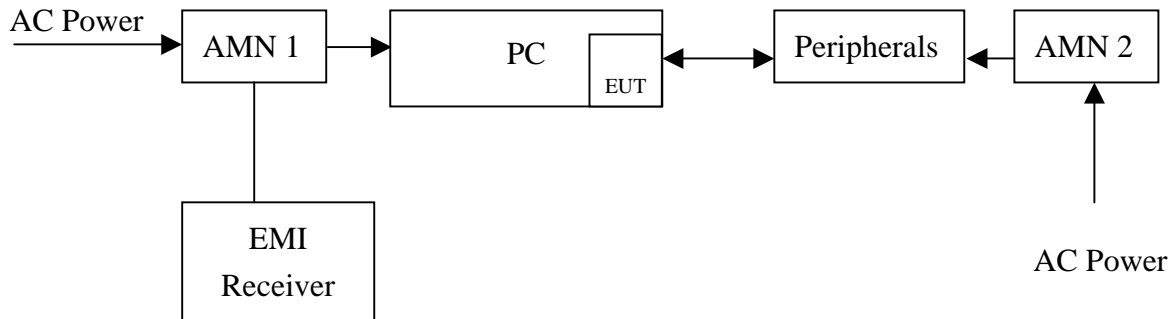

The EUT are connected to the main power through a line impedance stabilization network (LISN). This provides a 50 ohm/50uH coupling impedance for the measuring equipment. The peripheral devices are also connected to the main power through a LISN that provides a 50ohm/50uH coupling impedance with 50ohm termination.

Both sides (Line and Neutral) of AC line are checked for maximum conducted interference. In order to find the maximum emission, the relative positions of equipment and all of the interface cables must be changed according to ANSI C63.4/2003 on conducted measurement. The bandwidth of the field strength meter (R & S Test Receiver ESCS 30) is set at 9kHz.

The EUT configuration please refer to the “Conducted set-up photo.pdf”.

**8.3 Emission limit**

Freq. (MHz)	Conducted Limit (dBuV)	
	Q.P.	Ave.
0.15~0.50	66 – 56*	56 – 46*
0.50~5.00	56	46
5.00~30.0	60	50

\*Decreases with the logarithm of the frequency.

**8.4 Uncertainty of Conducted Emission**

Expanded uncertainty (k=2) of conducted emission measurement is  $\pm 2.6$  dB.

## 8.5 Power Line Conducted Emission test data

Phase : Line  
 EUT : WCP5102  
 Test Condition : Normal operating mode

Frequency (MHz)	Corr. Factor (dB)	Level Qp (dBuV)	Limit Qp (dBuV)	Level AV (dBuV)	Limit Av (dBuV)	Margin (dB)	
						Qp	Av
0.234	0.10	48.52	62.30	40.66	52.30	-13.78	-11.64
0.352	0.10	40.71	58.91	34.79	48.91	-18.20	-14.12
0.939	0.10	34.93	56.00	28.62	46.00	-21.07	-17.38
9.855	0.40	46.86	60.00	44.61	50.00	-13.15	-5.40
11.665	0.50	39.40	60.00	29.83	50.00	-20.60	-20.17
17.242	0.74	40.05	60.00	39.27	50.00	-19.95	-10.73

Remark:

1. Correction Factor (dB)= LISN Factor (dB) + Cable Loss (dB)
2. Margin (dB) = Level (dBuV) – Limit (dBuV)

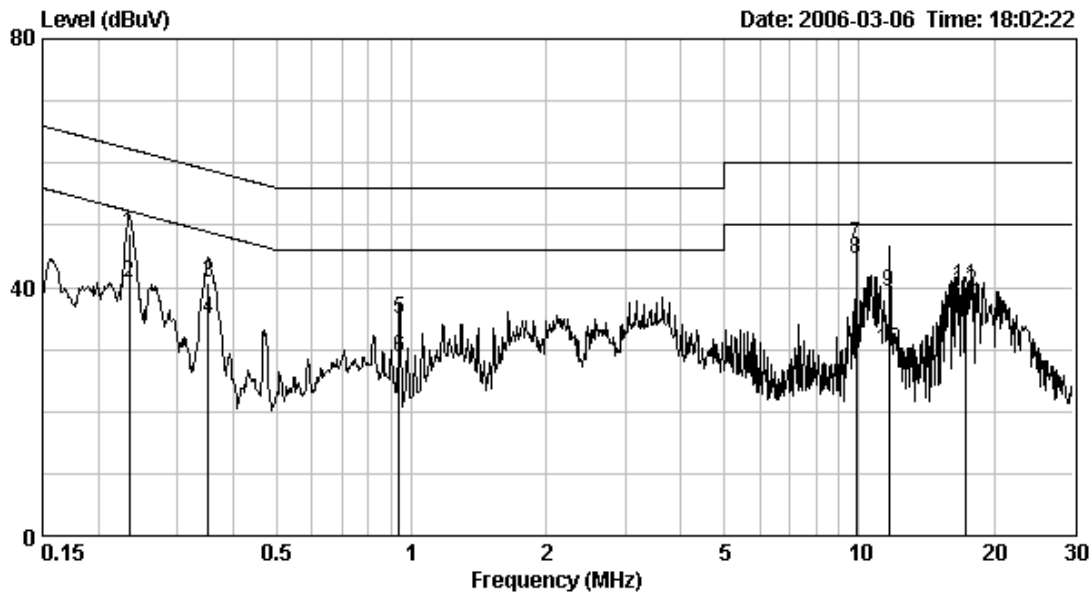

Phase : Neutral  
 EUT : WCP5102  
 Test Condition : Normal operating mode

Frequency (MHz)	Corr. Factor (dB)	Level Qp (dBuV)	Limit Qp (dBuV)	Level AV (dBuV)	Limit Av (dBuV)	Margin (dB)	
						Qp	Av
0.235	0.10	48.03	62.28	41.48	52.28	-14.25	-10.80
0.351	0.10	43.19	58.94	37.52	48.94	-15.75	-11.42
2.112	0.11	34.08	56.00	29.14	46.00	-21.92	-16.86
9.855	0.20	47.38	60.00	45.88	50.00	-12.62	-4.12
10.676	0.23	40.53	60.00	37.50	50.00	-19.47	-12.50
16.306	0.45	41.54	60.00	40.53	50.00	-18.46	-9.47

**Remark:**

1. Correction Factor (dB)= LISN Factor (dB) + Cable Loss (dB)
2. Margin (dB) = Level (dBuV) – Limit (dBuV)

