



SPORTON International Inc.

No. 52, Hwa Ya 1st Rd., Kwei-Shan Hsiang, TaoYuan Hsien, Taiwan, R.O.C.
Ph: 886-3-327-3456 / FAX: 886-3-327-0973 / www.sporton.com.tw

FCC RADIO TEST REPORT

Applicant's company	AboCom Systems, Inc
Applicant Address	No.77, Youyi Rd., Jhunan Township, Miaoli Country 350, Taiwan
FCC ID	MQ4SDW11G
Manufacturer's company	AboCom Systems, Inc
Manufacturer Address	No.77, Youyi Rd., Jhunan Township, Miaoli Country 350, Taiwan

Product Name	SDIO Wireless LAN Card
Brand Name	AboCom
Model Name	SDW11G
Test Rule	47 CFR FCC Part 15 Subpart C § 15.247
Test Freq. Range	2400 ~ 2483.5MHz
Receive Date	May 15, 2006
Test Date	Jun. 06, 2006
Submission Type	Original Equipment



Statement

Test result included is only for the 802.11b/g part of the product.

The test result in this report refers exclusively to the presented test model / sample.

Without written approval of SPORTON International Inc., the test report shall not be reproduced except in full.

The measurements and test results shown in this test report were made in accordance with the procedures

and found in compliance with the limit given in **ANSI C63.4-2003** and **47 CFR FCC Part 15 Subpart C**.

The test equipment used to perform the test is calibrated and traceable to NML/ROC.

NVLAQ®

Lab Code: 200079-0



Table of Contents

1. CERTIFICATE OF COMPLIANCE	1
2. SUMMARY OF THE TEST RESULT	2
3. GENERAL INFORMATION	3
3.1. Product Details.....	3
3.2. Table for Filed Antenna.....	3
3.3. Table for Carrier Frequencies	3
3.4. Table for Test Modes	4
3.5. Table for Testing Locations.....	4
3.6. Table for Supporting Units	4
3.7. Table for Parameters of Test Software Setting	5
3.8. Test Configurations	5
4. TEST RESULT	7
4.1. AC Power Line Conducted Emissions Measurement.....	7
4.2. Maximum Peak Output Power Measurement	11
4.3. Power Spectral Density Measurement	13
4.4. 6dB Spectrum Bandwidth Measurement	18
4.5. Radiated Emissions Measurement	23
4.6. Band Edge Emissions Measurement	41
4.7. Antenna Requirements	48
5. LIST OF MEASURING EQUIPMENTS	49
6. SPORTON COMPANY PROFILE	51
6.1. Test Location.....	51
7. NVLAP CERTIFICATE OF ACCREDITATION	52
APPENDIX A. PHOTOGRAPHS OF EUT.....	A1 ~ A3
APPENDIX B. TEST PHOTOS.....	B1 ~ B7

History of This Test Report

Original Issue Date: Jul. 20, 2006

Report No.: FR650607-02

No additional attachment.

Additional attachment were issued as following record:

Attachment No.	Issue Date	Description



1. CERTIFICATE OF COMPLIANCE

Product Name : SDIO Wireless LAN Card
Brand Name : AboCom
Model Name : SDW11G
Applicant : AboCom Systems, Inc
Test Rule Part(s) : 47 CFR FCC Part 15 Subpart C § 15.247

Sporton International as requested by the applicant to evaluate the EMC performance of the product sample received on May 15, 2006 would like to declare that the tested sample has been evaluated and found to be in compliance with the tested rule parts. The data recorded as well as the test configuration specified is true and accurate for showing the sample's EMC nature.

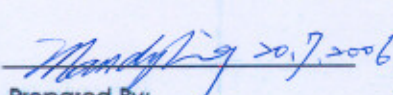
Prepared By:
Mandy Liang / Specialist

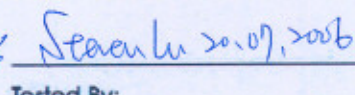
Tested By:
Steven Lu / Engineer

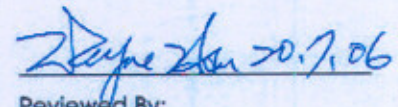
Reviewed By:
Wayne Hsu

2. SUMMARY OF THE TEST RESULT

Applied Standard: 47 CFR FCC Part 15 Subpart C				
Part	Rule Section	Description of Test	Result	Under Limit
4.1	15.207	AC Power Line Conducted Emissions	Complies	18.74 dB
4.2	15.247(b)(3)	Maximum Peak Conducted Output Power	Complies	18.11 dB
4.3	15.247(e)	Power Spectral Density	Complies	18.85 dB
4.4	15.247(a)(2)	6dB Spectrum Bandwidth	Complies	-
4.5	15.247(d)	Radiated Emissions	Complies	0.51 dB
4.6	15.247(d)	Band Edge Emissions	Complies	6.86 dB
4.7	15.203	Antenna Requirements	Complies	-

Test Items	Uncertainty	Remark
AC Power Line Conducted Emissions	± 2.26 dB	Confidence levels of 95%
Maximum Peak Conducted Output Power	± 0.5 dB	Confidence levels of 95%
Power Spectral Density	± 0.71 dB	Confidence levels of 95%
6dB Spectrum Bandwidth	$\pm 6.25 \times 10^{-7}$	Confidence levels of 95%
Radiated Emissions/ Band Edge Emissions	± 3.72 dB	Confidence levels of 95%

3. GENERAL INFORMATION

3.1. Product Details

Items	Description
Product Type	WLAN
Radio Type	Intentional Transceiver
Power Type	Host (Notebook)
Modulation	DSSS for IEEE 802.11b ; OFDM for IEEE 802.11g
Data Modulation	DSSS (BPSK / QPSK / CCK) ; OFDM (BPSK / QPSK / 16QAM / 64QAM)
Data Rate (Mbps)	DSSS (1/ 2/ 5.5/11) ; OFDM (6/9/12/18/24/36/48/54)
Frequency Range	2400 ~ 2483.5MHz
Channel Number	11
Channel Band Width (99%)	11b: 15.19 MHz ; 11g: 16.47 MHz
Conducted Output Power	11b: 11.24 dBm ; 11g: 11.89 dBm
Carrier Frequencies	Please refer to section 3.3
Antenna	Printed Antenna

3.2. Table for Filed Antenna

Ant.	Brand	Model Name	Antenna Type	Connector	Gain (dBi)
1	-	-	Printed Antenna	NA	1.98

3.3. Table for Carrier Frequencies

Frequency Band	Channel No.	Frequency	Channel No.	Frequency
2400~2483.5MHz	1	2412 MHz	7	2442 MHz
	2	2417 MHz	8	2447 MHz
	3	2422 MHz	9	2452 MHz
	4	2427 MHz	10	2457 MHz
	5	2432 MHz	11	2462 MHz
	6	2437 MHz		

3.4. Table for Test Modes

Preliminary tests were performed in different data rate to find the worst radiated emission. The data rate shown in the table below is the worst-case rate with respect to the specific test item. Investigation has been done on all the possible configurations for searching the worst cases. The following table is a list of the test modes shown in this test report.

Test Items	Mode	Data Rate	Channel	Antenna
AC Power Line Conducted Emissions	Normal Link	54 Mbps	6	1
Maximum Peak Conducted Output Power	11b/BPSK	1 Mbps	1/6/11	NA
Power Spectral Density	11g/BPSK	6 Mbps	1/6/11	NA
6dB Spectrum Bandwidth				
Radiated Emissions 9kHz~1GHz	11g/BPSK	6 Mbps	6	1
Radiated Emissions 1GHz~10 th Harmonic	11b/BPSK	1 Mbps	1/6/11	1
	11g/BPSK	6 Mbps	1/6/11	1
Band Edge Emissions	11b/BPSK	1 Mbps	1/11	1
	11g/BPSK	6 Mbps	1/11	1

3.5. Table for Testing Locations

Test Site No.	Site Category	Location	FCC Reg. No.	IC File No.	VCCI Reg. No
03CH03-HY	SAC	Hwa Ya	101377	IC 4088	-
CO04-HY	Conduction	Hwa Ya	101377	IC 4088	-
TH01-HY	OVEN Room	Hwa Ya	-	-	-

Open Area Test Site (OATS); Semi Anechoic Chamber (SAC); Fully Anechoic Chamber (FAC).

Please refer section 6 for Test Site Address.

3.6. Table for Supporting Units

Support Unit	Brand	Model	FCC ID
Notebook	Toshiba	PPS10T-00S015	DoC

3.7. Table for Parameters of Test Software Setting

During testing, Channel & Power Controlling Software provided by the customer was used to control the operating channel as well as the output power level. The RF output power selection is for the setting of RF output power expected by the customer and is going to be fixed on the firmware of the final end product.

Power Parameters of IEEE 802.11b/g

Test Software Version	RFTestUtil		
Frequency	2412 MHz	2437 MHz	2462 MHz
IEEE 802.11b	25	2a	31
IEEE 802.11g	33	35	36

An executive program, EMC TEST.EXE under WIN XP, which generates a complete line of continuously repeating " H " pattern was used as the test software.

Turn on the power of all equipment.

At the same time, the following programs were executed:

The NB sends " H " messages to the panel, and the panel displays " H " patterns on the screen.

Executed "ping.exe" to link with the remote workstation to receive and transmit data by WLAN.

"RF test" was executed to transmit function.

3.8. Test Configurations

3.8.1. Radiation Emissions Test Configuration

Test Configuration : 9kHz~1GHz

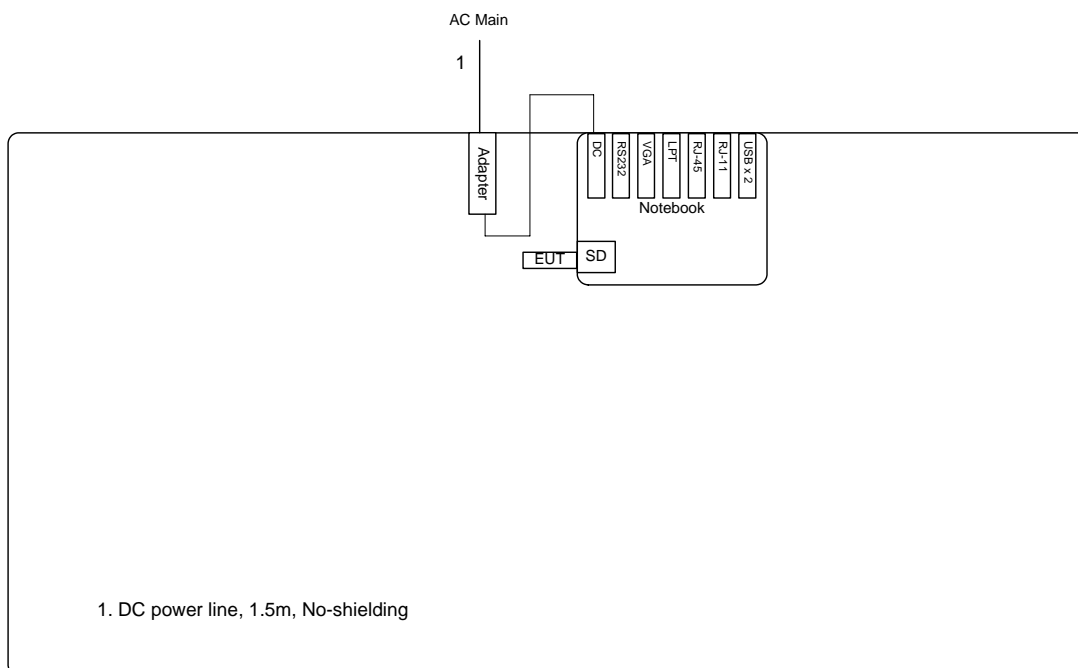

Test Configuration : Above 1GHz

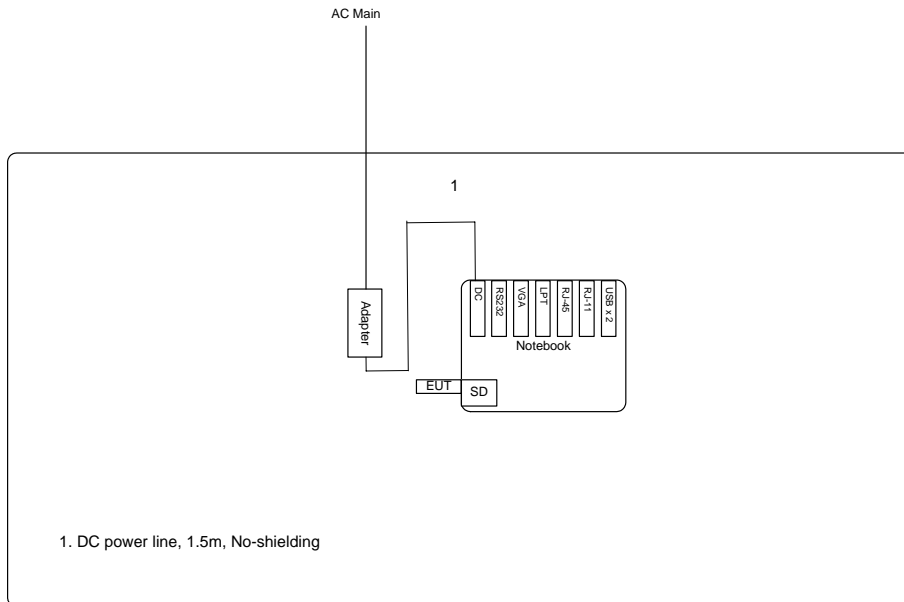

3.8.2. AC Power Line Conduction Emissions Test Configuration

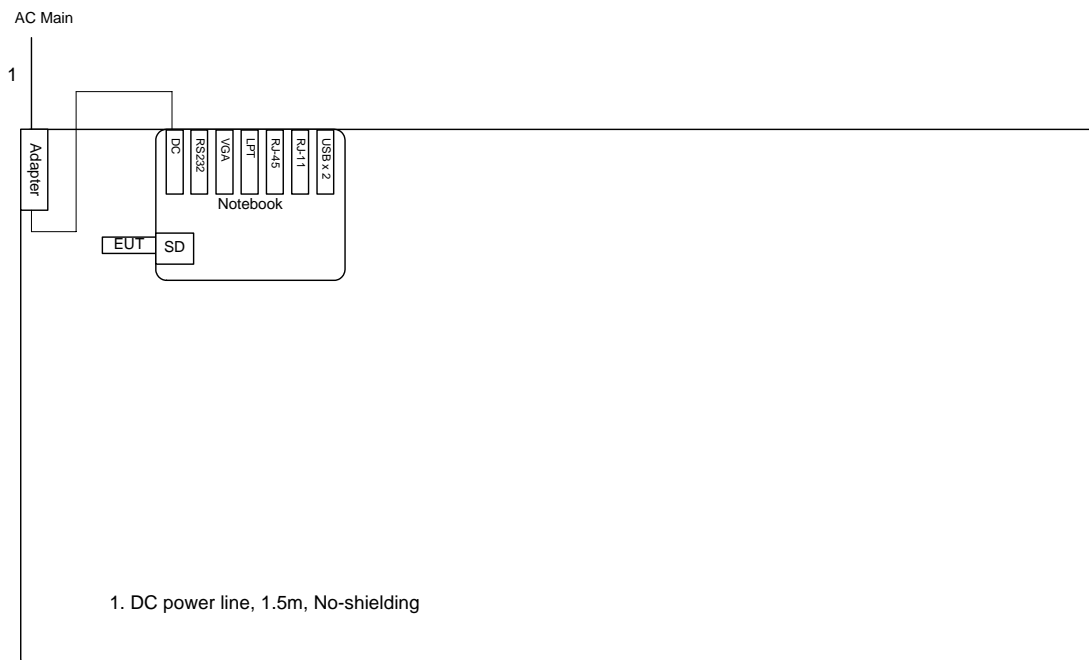

4. TEST RESULT

4.1. AC Power Line Conducted Emissions Measurement

4.1.1. Limit

For a Low-power Radio-frequency Device which is designed to be connected to the AC power line, the radio frequency voltage that is conducted back onto the AC power line on any frequency or frequencies within the band 150 kHz to 30 MHz shall not exceed below limits table.

Frequency (MHz)	QP Limit (dBuV)	AV Limit (dBuV)
0.15~0.5	66~56	56~46
0.5~5	56	46
5~30	60	50

4.1.2. Measuring Instruments and Setting

Please refer to section 5 in this report. The following table is the setting of the receiver.

Receiver Parameters	Setting
Attenuation	10 dB
Start Frequency	0.15 MHz
Stop Frequency	30 MHz
IF Bandwidth	9 KHz

4.1.3. Test Procedures

1. Configure the EUT according to ANSI C63.4. The EUT or host of EUT has to be placed 0.4 meter far from the conducting wall of the shielding room and at least 80 centimeters from any other grounded conducting surface.
2. Connect EUT or host of EUT to the power mains through a line impedance stabilization network (LISN).
3. All the support units are connected to the other LISNs. The LISN should provide 50uH/50ohms coupling impedance.
4. The frequency range from 150 KHz to 30 MHz was searched.
5. Set the test-receiver system to Peak Detect Function and Specified Bandwidth with Maximum Hold Mode.
6. The measurement has to be done between each power line and ground at the power terminal.

4.1.4. Test Setup Layout

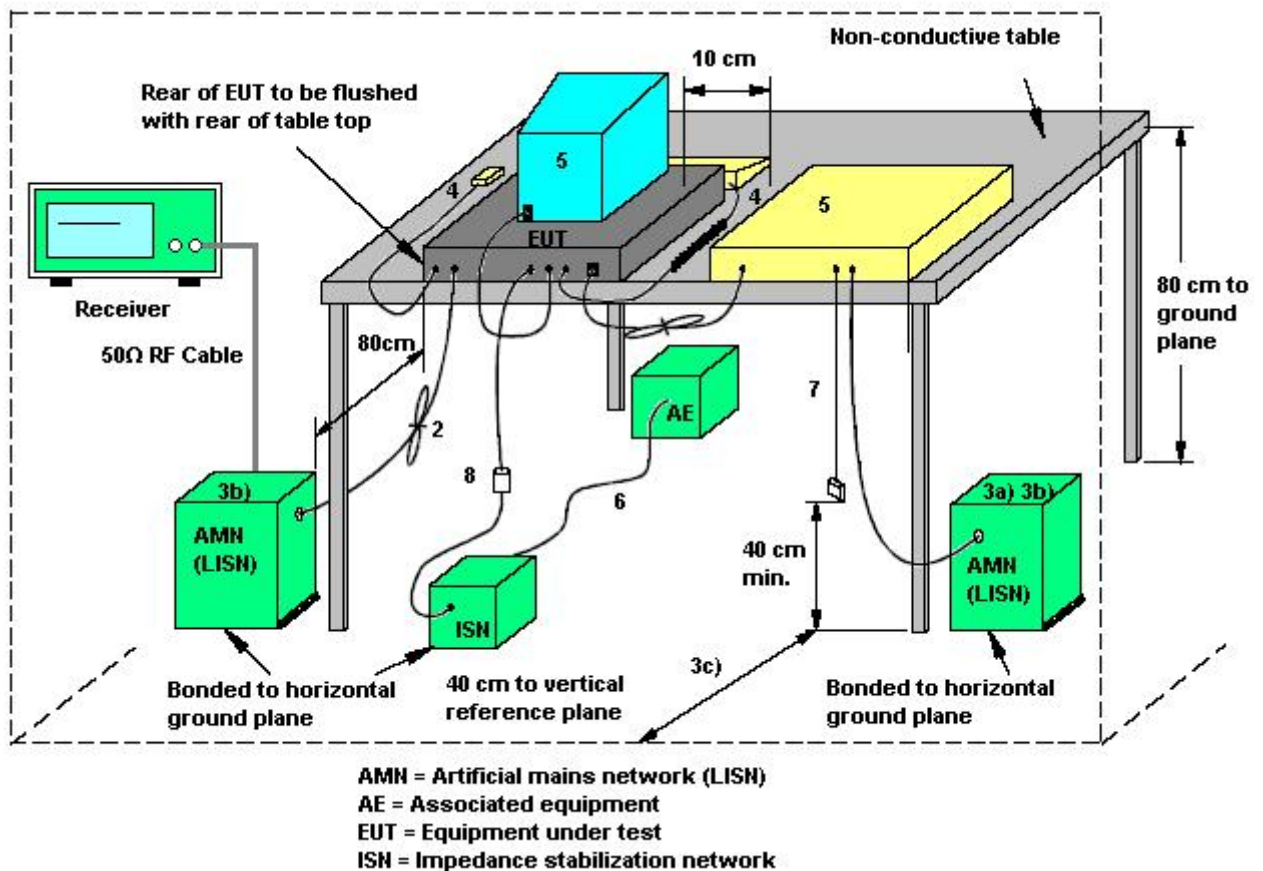

1. If cables, which hang closer than 40 cm to the horizontal metal groundplane, cannot be shortened to appropriate length, the excess shall be folded back and forth forming a bundle 30 cm to 40 cm long.
2. Excess mains cord shall be bundled in the centre or shortened to appropriate length.
3. EUT is connected to one artificial mains network (AMN). All AMNs and ISNs may alternatively be connected to a vertical reference plane or metal wall.
4. All other units of a system are powered from a second AMN. A multiple outlet strip can be used for multiple mains cords.
5. AMN and ISN are 80 cm from the EUT and at least 80 cm from other units and other metal planes.
6. Mains cords and signal cables shall be positioned for their entire lengths, as far as possible, at 40 cm from the vertical reference plane.
7. Cables of hand operated devices, such as keyboards, mice, etc. shall be placed as for normal usage.
8. Peripherals shall be placed at a distance of 10 cm from each other and from the controller, except for the monitor which, if this is an acceptable installation practice, shall be placed directly on the top of the controller.
9. I/O signal cable intended for external connection.
10. The end of the I/O signal cables which are not connected to an AE may be terminated, if required, using correct terminating impedance.
11. If used, the current probe shall be placed at 0,1 m from the ISN.

4.1.5. Test Deviation

There is no deviation with the original standard.

4.1.6. EUT Operation during Test

The EUT was placed on the test table and programmed in normal function.

4.1.7. Results of AC Power Line Conducted Emissions Measurement

Temperature	24°C	Humidity	65%
Test Engineer	Evelyn Shih	Phase	Line
Configuration	Normal Link		

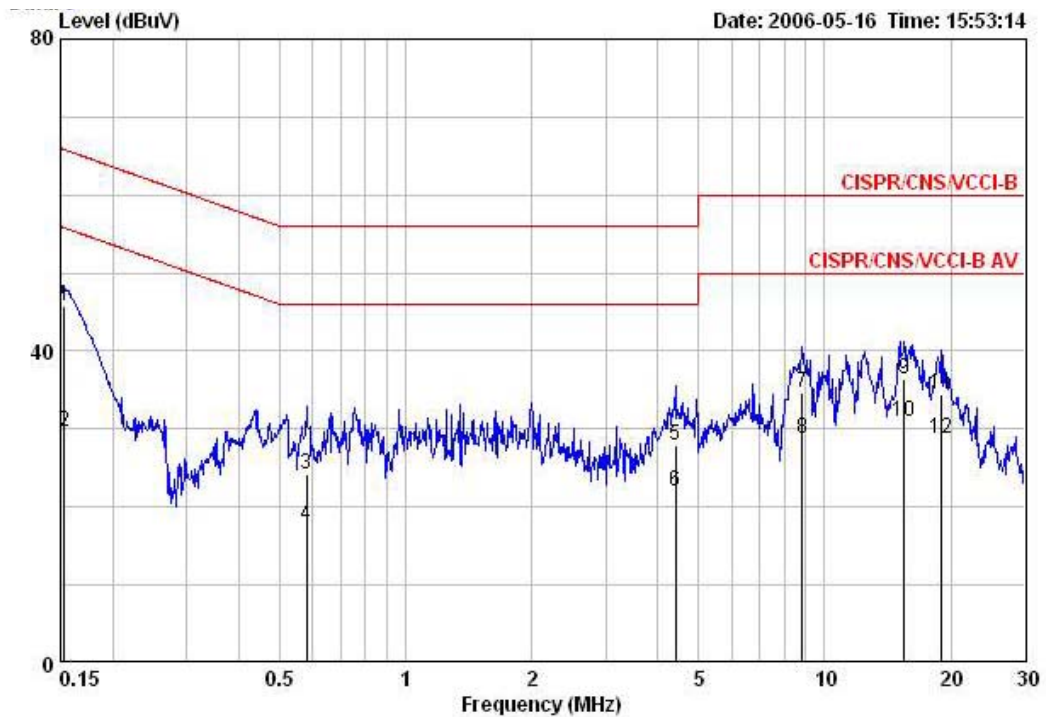

	Freq	Level	Over Limit	Limit Line	Read Level	LISN Factor	Cable Loss	Remark
	MHz	dBuV	dB	dBuV	dBuV	dB	dB	
1	0.15313	45.79	-20.04	65.83	45.40	0.19	0.20	QP
2	0.15313	29.55	-26.28	55.83	29.16	0.19	0.20	AVERAGE
3	0.57923	24.15	-31.85	56.00	23.95	0.00	0.20	QP
4	0.57923	17.63	-28.37	46.00	17.43	0.00	0.20	AVERAGE
5	4.407	27.94	-28.06	56.00	27.63	0.01	0.30	QP
6	4.407	22.06	-23.94	46.00	21.75	0.01	0.30	AVERAGE
7	8.822	34.60	-25.40	60.00	34.21	0.09	0.30	QP
8	8.822	28.88	-21.12	50.00	28.49	0.09	0.30	AVERAGE
9	15.470	36.40	-23.60	60.00	35.90	0.10	0.40	QP
10	15.470	30.94	-19.06	50.00	30.44	0.10	0.40	AVERAGE
11	18.920	34.51	-25.49	60.00	33.91	0.10	0.50	QP
12	18.920	28.71	-21.29	50.00	28.11	0.10	0.50	AVERAGE

Temperature	24°C	Humidity	65%
Test Engineer	Evelyn Shih	Phase	Neutral
Configuration	Normal Link		

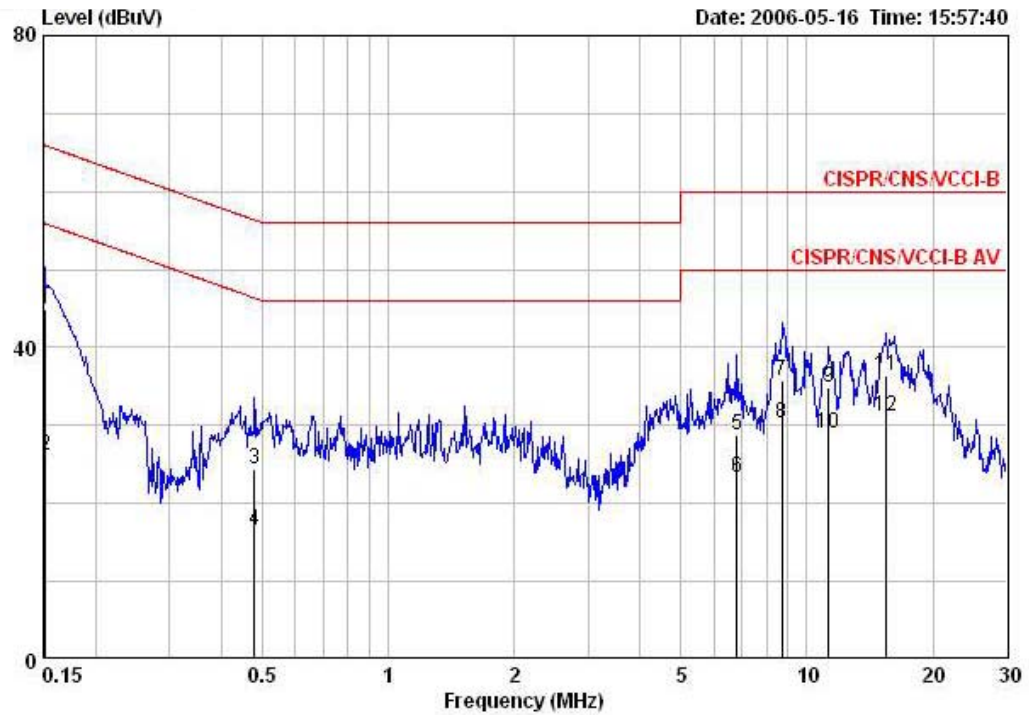

	Freq	Level	Over	Limit	Read	LISN	Cable	
	MHz	dBuV	Limit	Line	Level	Factor	Loss	Remark
			dB	dBuV	dBuV	dB	dB	
1	0.15155	44.99	-20.93	65.91	44.59	0.20	0.20	QP
2	0.15155	26.06	-29.86	55.91	25.66	0.20	0.20	AVERAGE
3	0.47865	24.33	-32.04	56.36	24.12	0.08	0.13	QP
4	0.47865	16.54	-29.83	46.36	16.33	0.08	0.13	AVERAGE
5	6.805	28.83	-31.17	60.00	28.49	0.00	0.34	QP
6	6.805	23.24	-26.76	50.00	22.90	0.00	0.34	AVERAGE
7	8.729	35.75	-24.25	60.00	35.45	0.00	0.30	QP
8	8.729	30.35	-19.65	50.00	30.05	0.00	0.30	AVERAGE
9	11.257	34.89	-25.11	60.00	34.49	0.00	0.40	QP
10	11.257	28.91	-21.09	50.00	28.51	0.00	0.40	AVERAGE
11	15.470	36.43	-23.57	60.00	36.02	0.01	0.40	QP
12	15.470	31.26	-18.74	50.00	30.85	0.01	0.40	AVERAGE

Note:

Level = Read Level + LISN Factor + Cable Loss.

4.2. Maximum Peak Output Power Measurement

4.2.1. Limit

For systems using digital modulation in the 2400-2483.5MHz, the limit for peak output power is 30dBm. The limited has to be reduced by the amount in dB that the gain of the antenna exceed 6dBi. In case of point-to-point operation, the limit has to be reduced by 1dB for every 3dB that the directional gain of the antenna exceeds 6dBi.

4.2.2. Measuring Instruments and Setting

Please refer to section 5 in this report. The following table is the setting of the power meter.

Power Meter Parameter	Setting
Filter No.	Auto
Measurement time	0.135 s ~ 26 s
Used Peak Sensor	NRV-Z32 (model 04)

4.2.3. Test Procedures

1. The transmitter output (antenna port) was connected to the power meter.
2. Turn on the EUT and power meter and then record the peak power value.
3. Repeat above procedures on all channels needed to be tested.

4.2.4. Test Setup Layout

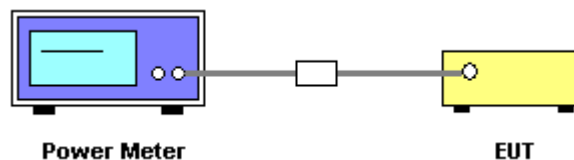

4.2.5. Test Deviation

There is no deviation with the original standard.

4.2.6. EUT Operation during Test

The EUT was programmed to be in continuously transmitting mode.

4.2.7. Test Result of Maximum Peak Output Power

Temperature	23°C	Humidity	64%
Test Engineer	Rush Kao	Configurations	802.11b/g

Configuration IEEE 802.11b

Channel	Frequency	Conducted Power (dBm)	Max. Limit (dBm)	Result
1	2412 MHz	11.21	30.00	Complies
6	2437 MHz	11.24	30.00	Complies
11	2462 MHz	11.23	30.00	Complies

Configuration IEEE 802.11g

Channel	Frequency	Conducted Power (dBm)	Max. Limit (dBm)	Result
1	2412 MHz	11.68	30.00	Complies
6	2437 MHz	11.89	30.00	Complies
11	2462 MHz	11.48	30.00	Complies

4.3. Power Spectral Density Measurement

4.3.1. Limit

For digitally modulated systems, the power spectral density conducted from the intentional radiator to the antenna shall not be greater than 8 dBm in any 3 kHz band during any time interval of continuous transmission.

4.3.2. Measuring Instruments and Setting

Please refer to section 5 in this report. The following table is the setting of Spectrum Analyzer.

Spectrum Parameter	Setting
Attenuation	Auto
Span Frequency	1.5MHz
RB	3 kHz
VB	30 kHz
Detector	Peak
Trace	Max Hold
Sweep Time	500s

4.3.3. Test Procedures

1. The transmitter output (antenna port) was connected to the spectrum analyser.
2. Set RBW of spectrum analyzer to 3kHz and VBW to 30kHz. Set Detector to Peak, Trace to Max Hold.
3. Mark the frequency with maximum peak power as the center of the display of the spectrum.
4. Set the span to 1.5MHz and the sweep time to 500s and record the maximum peak value.

4.3.4. Test Setup Layout

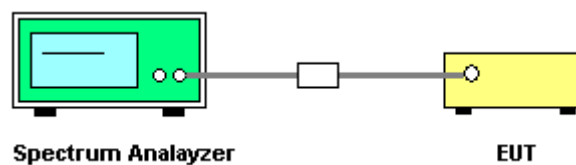

4.3.5. Test Deviation

There is no deviation with the original standard.

4.3.6. EUT Operation during Test

The EUT was programmed to be in continuously transmitting mode.

4.3.7. Test Result of Power Spectral Density

Temperature	23°C	Humidity	64%
Test Engineer	Rush Kao	Configurations	802.11b/g

Configuration IEEE 802.11b

Channel	Frequency	Power Density (dBm)	Max. Limit (dBm)	Result
1	2412 MHz	-13.18	8.00	Complies
6	2437 MHz	-10.85	8.00	Complies
11	2462 MHz	-13.19	8.00	Complies

Configuration IEEE 802.11g

Channel	Frequency	Power Density (dBm)	Max. Limit (dBm)	Result
1	2412 MHz	-17.74	8.00	Complies
6	2437 MHz	-17.42	8.00	Complies
11	2462 MHz	-17.07	8.00	Complies

Power Density Plot on Configuration IEEE 802.11b / 2412 MHz

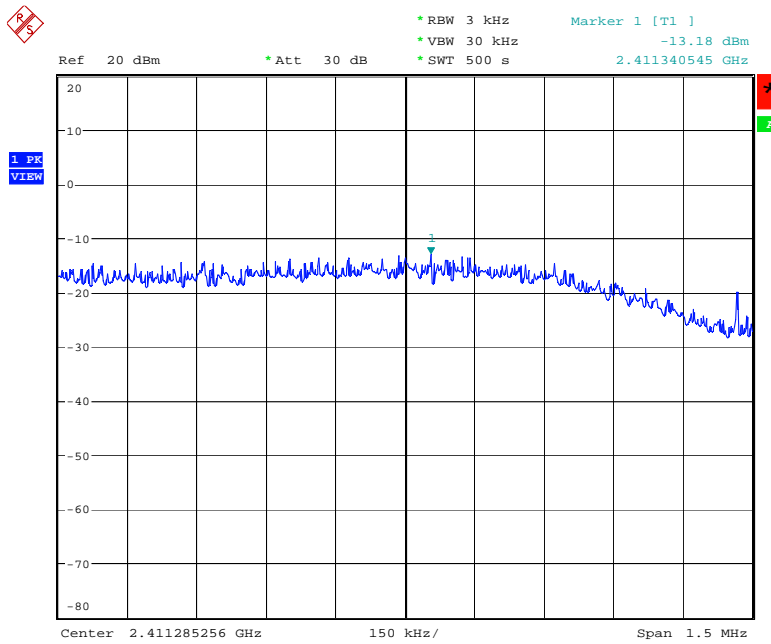

Date: 2.JUN.2006 16:30:04

Power Density Plot on Configuration IEEE 802.11b / 2437 MHz

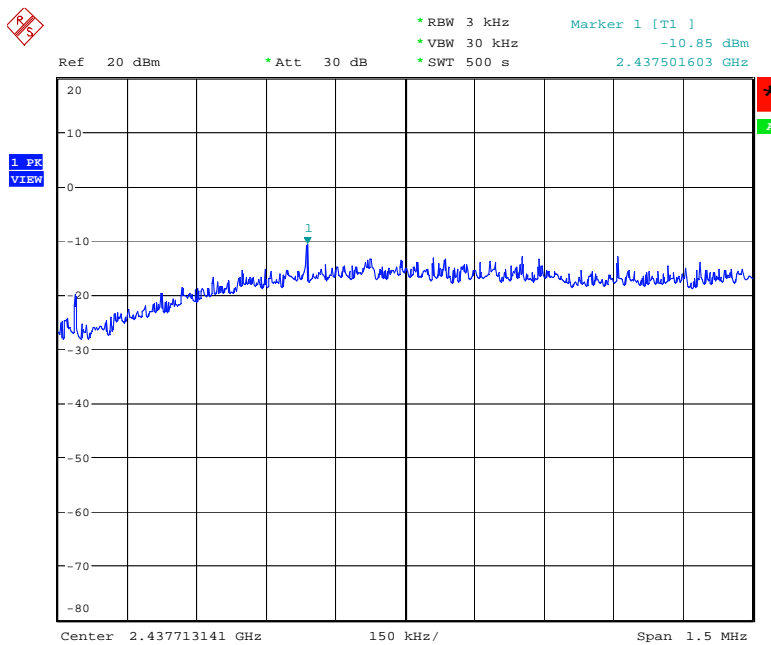

Date: 2.JUN.2006 16:33:13

Power Density Plot on Configuration IEEE 802.11b / 2462 MHz

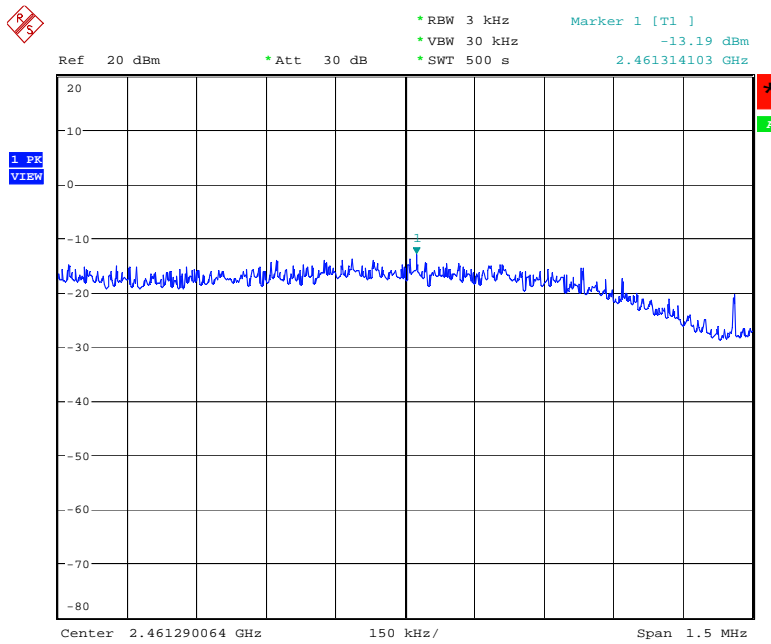

Date: 2.JUN.2006 16:36:58

Power Density Plot on Configuration IEEE 802.11g / 2412 MHz

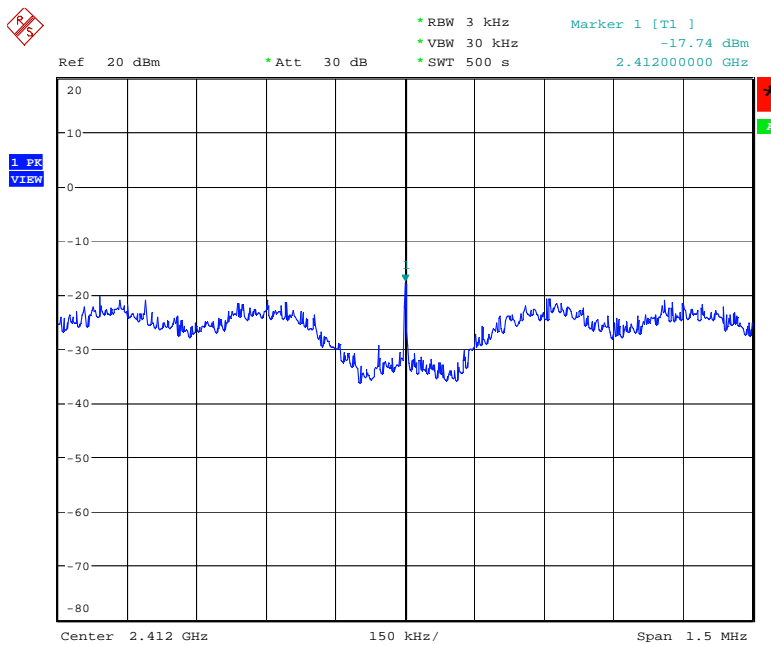

Date: 2.JUN.2006 16:45:27

Power Density Plot on Configuration IEEE 802.11g / 2437 MHz

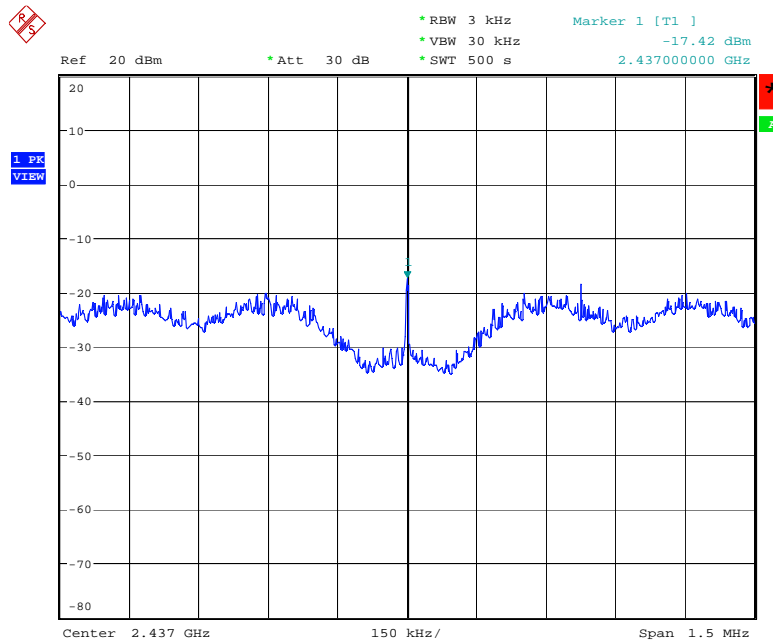

Date: 2.JUN.2006 16:42:20

Power Density Plot on Configuration IEEE 802.11g / 2462 MHz

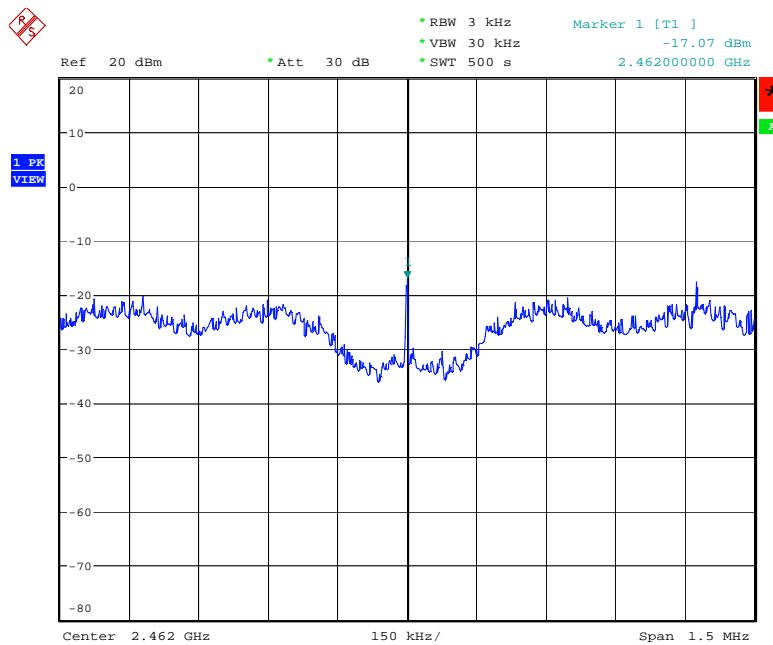

Date: 2.JUN.2006 16:41:30

4.4. 6dB Spectrum Bandwidth Measurement

4.4.1. Limit

For digital modulation systems, the minimum 6 dB bandwidth shall be at least 500 kHz.

4.4.2. Measuring Instruments and Setting

Please refer to section 5 in this report. The following table is the setting of the Spectrum Analyzer.

Spectrum Parameters	Setting
Attenuation	Auto
Span Frequency	> 6dB Bandwidth
RB	100 kHz
VB	100 kHz
Detector	Peak
Trace	Max Hold
Sweep Time	Auto

4.4.3. Test Procedures

1. The transmitter output (antenna port) was connected to the spectrum analyser in peak hold mode.
2. The resolution bandwidth of 100 kHz and the video bandwidth of 100 kHz were used.
3. Measured the spectrum width with power higher than 6dB below carrier.

4.4.4. Test Setup Layout

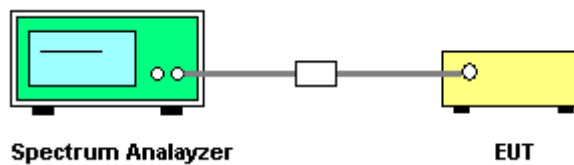

4.4.5. Test Deviation

There is no deviation with the original standard.

4.4.6. EUT Operation during Test

The EUT was programmed to be in continuously transmitting mode.

4.4.7. Test Result of 6dB Spectrum Bandwidth

Temperature	23°C	Humidity	64%
Test Engineer	Rush Kao	Configurations	802.11b/g

Configuration IEEE 802.11b

Channel	Frequency	6dB Bandwidth (MHz)	99% Occupied Bandwidth (MHz)	Min. Limit (kHz)	Test Result
1	2412 MHz	11.02	15.19	500	Complies
6	2437 MHz	10.03	15.19	500	Complies
11	2462 MHz	10.03	15.12	500	Complies

Configuration IEEE 802.11g

Channel	Frequency	6dB Bandwidth (MHz)	99% Occupied Bandwidth (MHz)	Min. Limit (kHz)	Test Result
1	2412 MHz	16.41	16.47	500	Complies
6	2437 MHz	16.41	16.44	500	Complies
11	2462 MHz	16.50	16.41	500	Complies

6 dB Bandwidth Plot on Configuration IEEE 802.11b / 2412 MHz

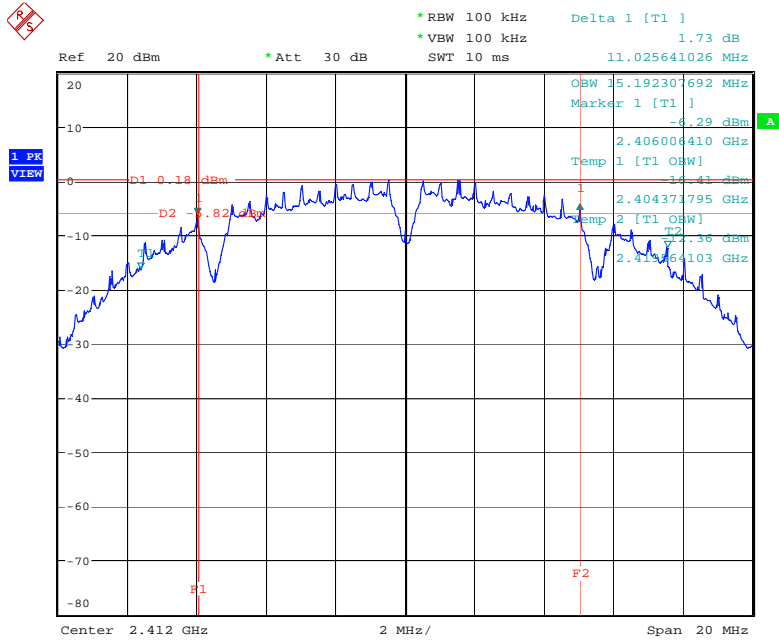

Date: 2.JUN.2006 16:28:04

6 dB Bandwidth Plot on Configuration IEEE 802.11b / 2437 MHz

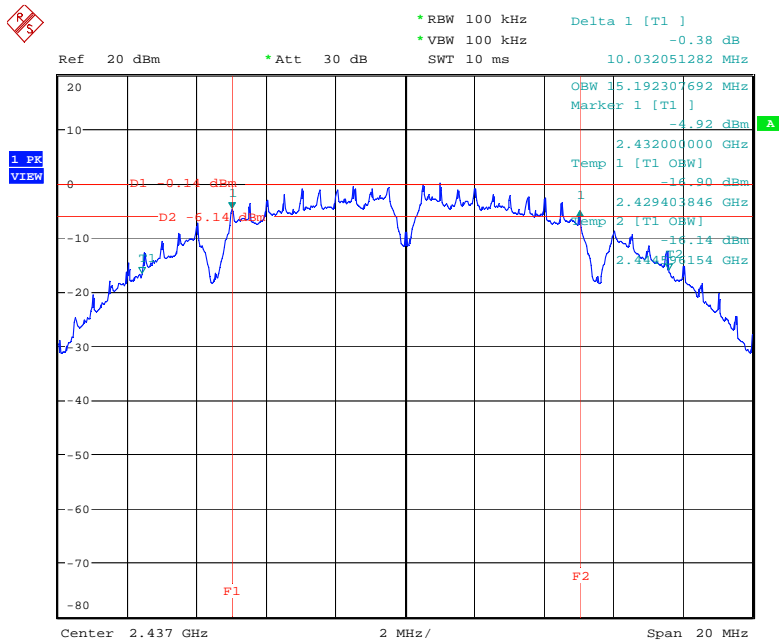

Date: 2.JUN.2006 16:34:06

6 dB Bandwidth Plot on Configuration IEEE 802.11b / 2462 MHz

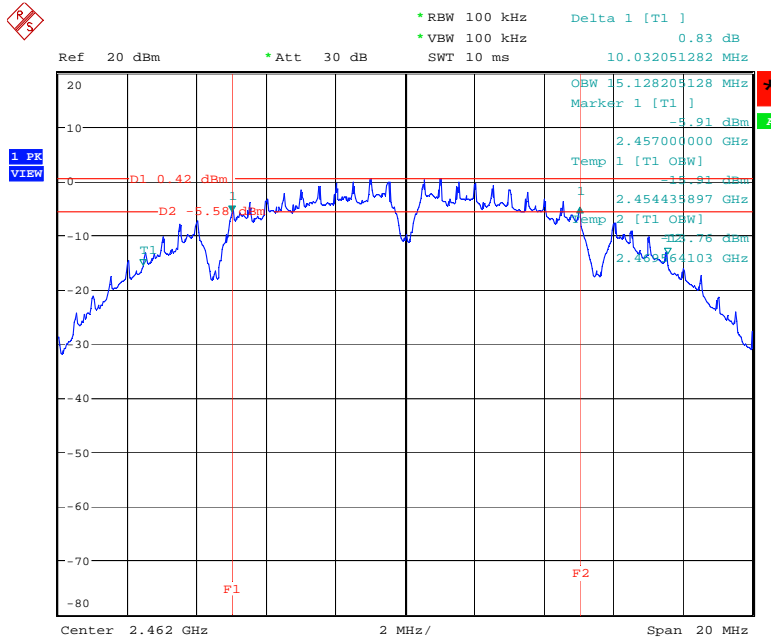

Date: 2.JUN.2006 16:35:09

6 dB Bandwidth Plot on Configuration IEEE 802.11g / 2412 MHz

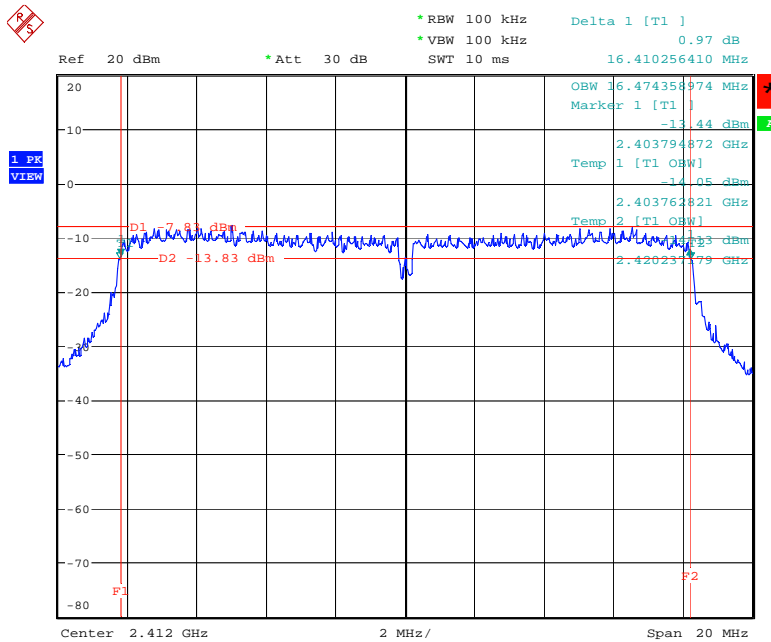

Date: 2.JUN.2006 16:46:23

6 dB Bandwidth Plot on Configuration IEEE 802.11g / 2437 MHz

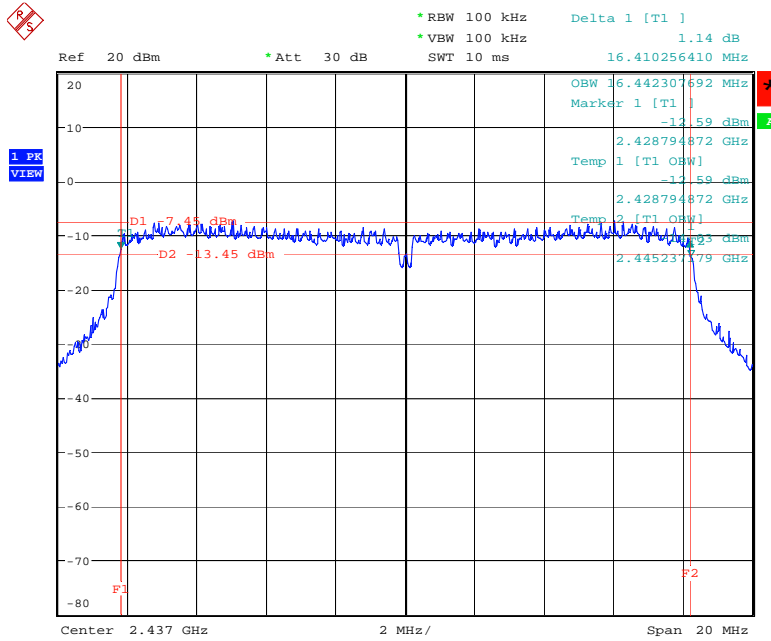

Date: 2.JUN.2006 16:43:15

6 dB Bandwidth Plot on Configuration IEEE 802.11g / 2462 MHz

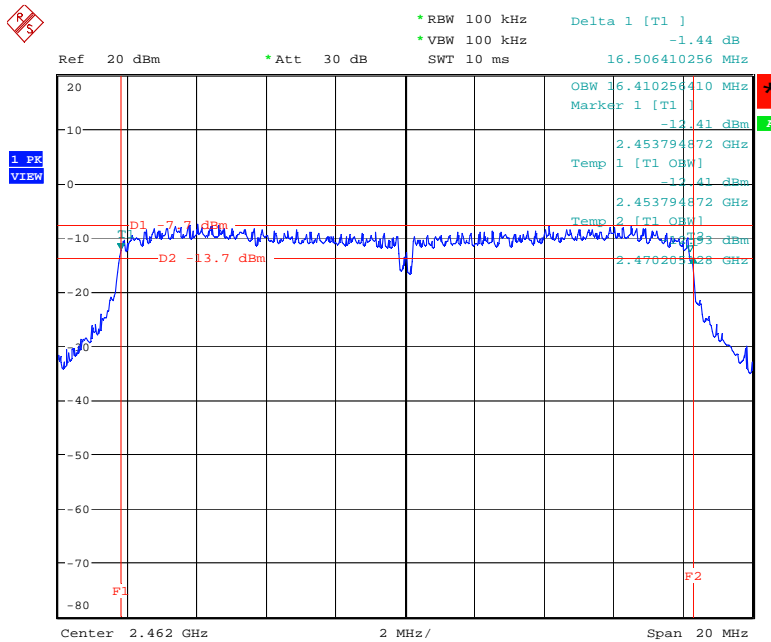

Date: 2.JUN.2006 16:41:00

4.5. Radiated Emissions Measurement

4.5.1. Limit

20dBc in any 100 kHz bandwidth outside the operating frequency band. In case the emission fall within the restricted band specified on 15.205(a), then the 15.209(a) limit in the table below has to be followed.

Frequencies (MHz)	Field Strength (micorvolts/meter)	Measurement Distance (meters)
0.009~0.490	2400/F(KHz)	300
0.490~1.705	24000/F(KHz)	30
1.705~30.0	30	30
30~88	100	3
88~216	150	3
216~960	200	3
Above 960	500	3

4.5.2. Measuring Instruments and Setting

Please refer to section 5 in this report. The following table is the setting of spectrum analyzer and receiver.

Spectrum Parameter	Setting
Attenuation	Auto
Start Frequency	1000 MHz
Stop Frequency	10th carrier harmonic
RB / VB (emission in restricted band)	1MHz / 1MHz for Peak, 1 MHz / 10Hz for Average
RB / VB (other emission)	100KHz / 100KHz for peak

Receiver Parameter	Setting
Attenuation	Auto
Start ~ Stop Frequency	9kHz~150kHz / RB 200Hz for QP
Start ~ Stop Frequency	150kHz~30MHz / RB 9kHz for QP
Start ~ Stop Frequency	30MHz~1000MHz / RB 120kHz for QP

4.5.3. Test Procedures

1. Configure the EUT according to ANSI C63.4. The EUT was placed on the top of the turntable 0.8 meter above ground. The phase center of the receiving antenna mounted on the top of a height-variable antenna tower was placed 3 meters far away from the turntable.
2. Power on the EUT and all the supporting units. The turntable was rotated by 360 degrees to determine the position of the highest radiation.
3. The height of the broadband receiving antenna was varied between one meter and four meters above ground to find the maximum emissions field strength of both horizontal and vertical polarization.
4. For each suspected emissions, the antenna tower was scan (from 1 M to 4 M) and then the turntable was rotated (from 0 degree to 360 degrees) to find the maximum reading.
5. Set the test-receiver system to Peak or CISPR quasi-peak Detect Function with specified bandwidth under Maximum Hold Mode.
6. For emissions above 1GHz, use 1MHz VBW and RBW for peak reading. Then 1MHz RBW and 10Hz VBW for average reading in spectrum analyzer.
7. When the radiated emissions limits are expressed in terms of the average value of the emissions, and pulsed operation is employed, the measurement field strength shall be determined by averaging over one complete pulse train, including blanking intervals, as long as the pulse train does not exceed 0.1 seconds. As an alternative (provided the transmitter operates for longer than 0.1 seconds) or in cases where the pulse train exceeds 0.1 seconds, the measured field strength shall be determined from the average absolute voltage during a 0.1 second interval during which the field strength is at its maximum value.
8. If the emissions level of the EUT in peak mode was 3 dB lower than the average limit specified, then testing will be stopped and peak values of EUT will be reported, otherwise, the emissions which do not have 3 dB margin will be repeated one by one using the quasi-peak method for below 1GHz.
9. For testing above 1GHz, the emissions level of the EUT in peak mode was lower than average limit (that means the emissions level in peak mode also complies with the limit in average mode), then testing will be stopped and peak values of EUT will be reported, otherwise, the emissions will be measured in average mode again and reported.
10. In case the emission is lower than 30MHz, loop antenna has to be used for measurement and the recorded data should be QP measured by receiver. High – Low scan is not required in this case.

4.5.4. Test Setup Layout

For radiated emissions below 30MHz

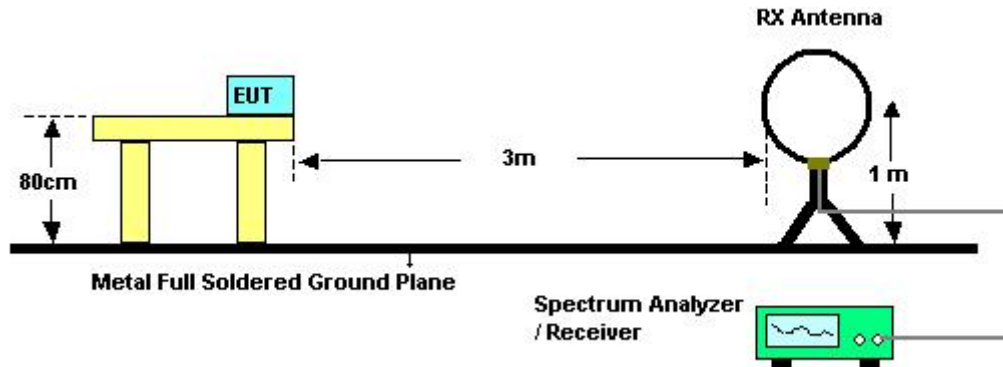

For radiated emissions above 30MHz

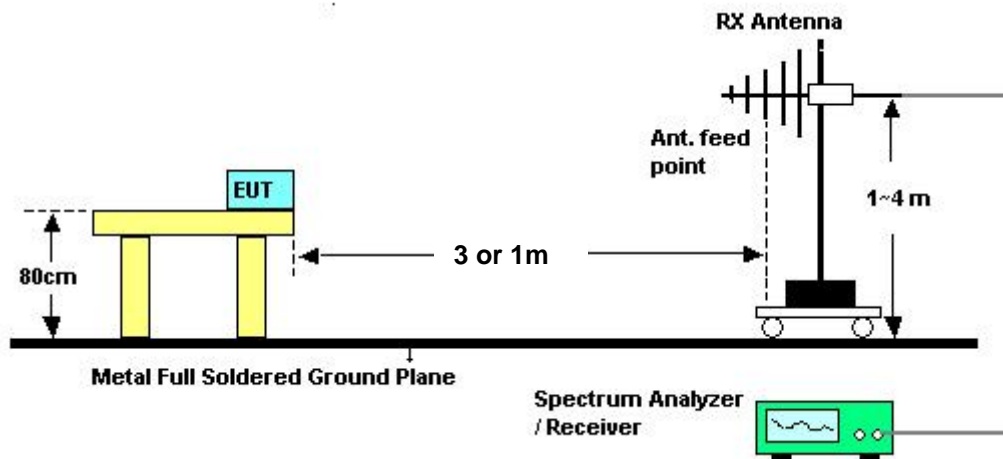

Above 10 GHz shall be extrapolated to the specified distance using an extrapolation factor of 20 dB/decade from 3m to 1m.

Distance extrapolation factor = $20 \log (\text{specific distance [3m]} / \text{test distance [1m]})$ (dB);

Limit line = specific limits (dBuV) + distance extrapolation factor [9.54 dB].

4.5.5. Test Deviation

There is no deviation with the original standard.

4.5.6. EUT Operation during Test

The EUT was programmed to be in continuously transmitting mode.

4.5.7. Results of Radiated Emissions (9kHz~30MHz)

Temperature	23°C	Humidity	64%
Test Engineer	Barry Chen	Configurations	802.11g Channel 6

Freq. (MHz)	Level (dBuV)	Over Limit (dB)	Limit Line (dBuV)	Remark
-	-	-	-	See Note

Note:

The amplitude of spurious emissions which are attenuated by more than 20 dB below the permissible value has no need to be reported.

Distance extrapolation factor = $40 \log(\text{specific distance} / \text{test distance})$ (dB);

Limit line = specific limits (dBuV) + distance extrapolation factor.

4.5.8. Results of Radiated Emissions (30MHz~1GHz)

Temperature	23°C	Humidity	64%
Test Engineer	Barry Chen	Configurations	802.11g Channel 6

Vertical

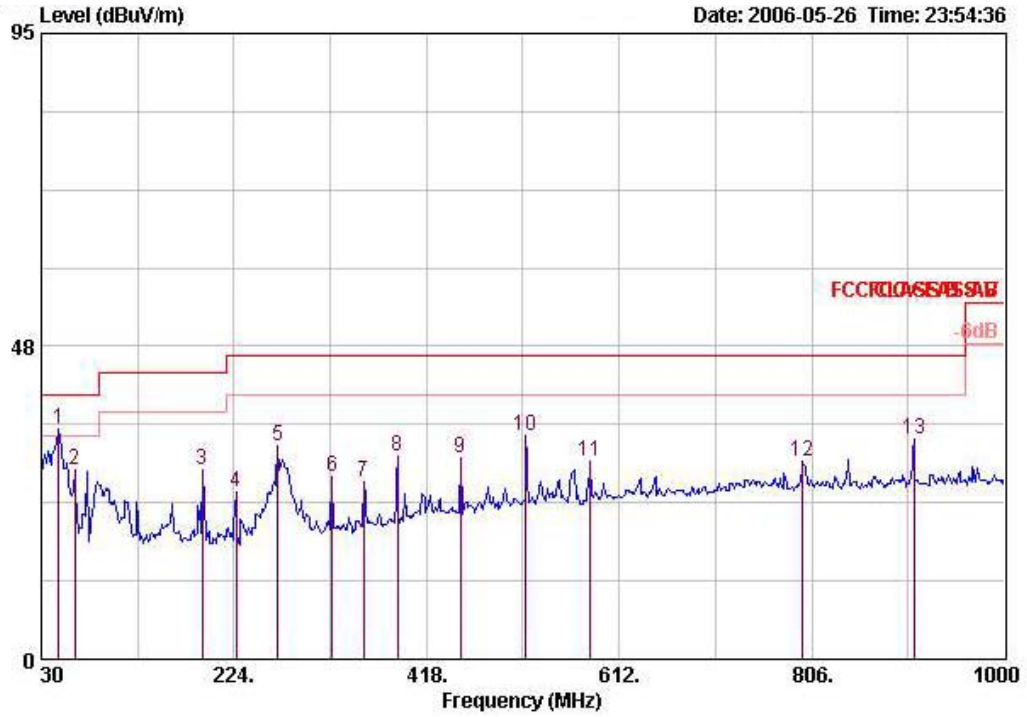

	Freq	Level	Over Limit	Limit Line	ReadAntenna Level	Antenna Factor	Cable Loss	Preamp Factor	Remark	Pol/Phase	Distance
	MHz	dBuV/m	dB	dBuV/m	dBuV	dB/m	dB	dB			m
1 !	47.460	34.87	-5.13	40.00	56.40	9.18	1.10	31.81	Peak	VERTICAL	3
2	63.950	28.75	-11.25	40.00	52.96	6.28	1.33	31.82	Peak	VERTICAL	3
3	191.990	28.75	-14.75	43.50	48.98	9.36	1.93	31.52	Peak	VERTICAL	3
4	225.940	25.28	-20.72	46.00	44.74	9.77	2.15	31.39	Peak	VERTICAL	3
5	268.620	32.44	-13.56	46.00	48.10	13.18	2.50	31.34	Peak	VERTICAL	3
6	322.940	27.77	-18.23	46.00	42.37	14.39	2.30	31.28	Peak	VERTICAL	3
7	354.950	27.01	-18.99	46.00	40.67	15.13	2.43	31.22	Peak	VERTICAL	3
8	388.900	30.71	-15.29	46.00	43.17	15.98	2.63	31.08	Peak	VERTICAL	3
9	451.950	30.54	-15.46	46.00	41.55	17.00	2.92	30.92	Peak	VERTICAL	3
10	517.910	33.90	-12.10	46.00	43.28	18.24	3.26	30.87	Peak	VERTICAL	3
11	582.900	30.01	-15.99	46.00	38.35	19.28	3.13	30.75	Peak	VERTICAL	3
12	797.270	29.94	-16.06	46.00	35.60	20.72	3.81	30.19	Peak	VERTICAL	3
13	908.820	33.32	-12.68	46.00	38.05	20.87	4.07	29.66	Peak	VERTICAL	3

Temperature	23°C	Humidity	64%
Test Engineer	Barry Chen	Configurations	802.11g Channel 6

Horizontal

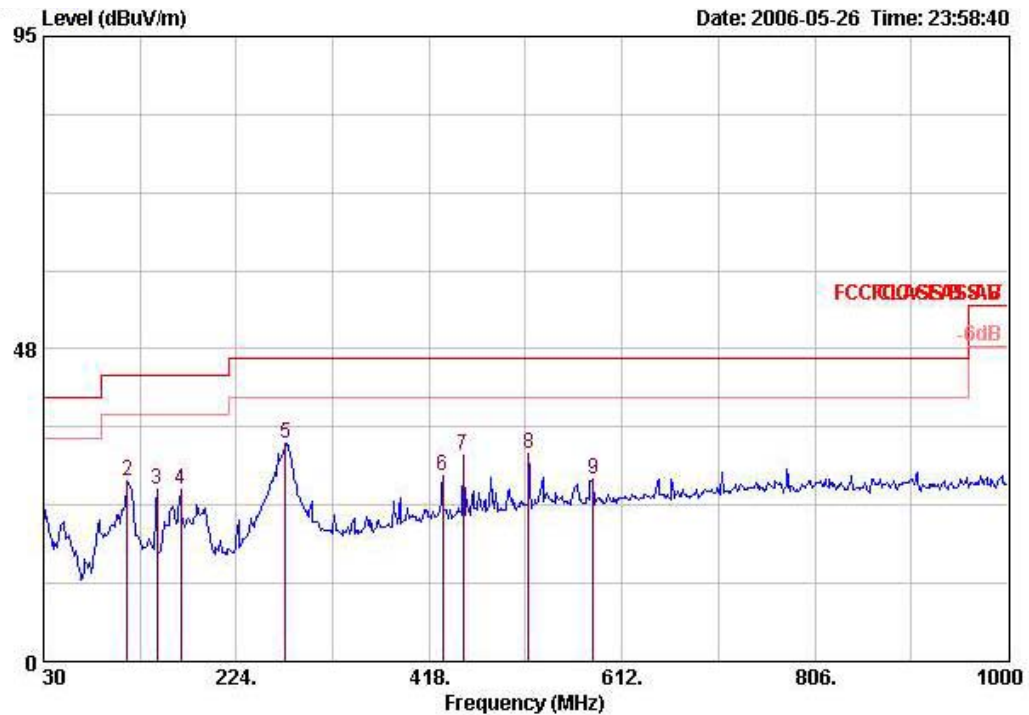

	Freq	Level	Over	Limit	Read	Antenna	Cable	Preamp	Remark	Pol/Phase	Distance
	MHz	dBUV/m	dB	dBUV/m	dBuV	dB/m	dB	dB			m
1	30.000	23.88	-16.12	40.00	36.27	18.48	0.80	31.67	Peak	HORIZONTAL	3
2	114.390	27.53	-15.97	43.50	45.31	12.47	1.50	31.75	Peak	HORIZONTAL	3
3	144.460	26.19	-17.31	43.50	45.09	10.95	1.70	31.56	Peak	HORIZONTAL	3
4	167.740	26.02	-17.48	43.50	45.93	9.76	1.90	31.56	Peak	HORIZONTAL	3
5	273.470	33.23	-12.77	46.00	48.96	13.10	2.50	31.34	Peak	HORIZONTAL	3
6	431.580	28.11	-17.89	46.00	39.19	17.06	2.83	30.96	Peak	HORIZONTAL	3
7	451.950	31.21	-14.79	46.00	42.22	17.00	2.92	30.92	Peak	HORIZONTAL	3
8	517.910	31.55	-14.45	46.00	40.93	18.24	3.26	30.87	Peak	HORIZONTAL	3
9	582.900	27.77	-18.23	46.00	36.11	19.28	3.13	30.75	Peak	HORIZONTAL	3

Note:

The amplitude of spurious emissions which are attenuated by more than 20 dB below the permissible value has no need to be reported.

Emission level (dBUV/m) = 20 log Emission level (uV/m).

Corrected Reading: Antenna Factor + Cable Loss + Read Level - Preamp Factor = Level.

4.5.9. Results for Radiated Emissions (1GHz~10th Harmonic)

Temperature	23°C	Humidity	64%
Test Engineer	Barry Chen	Configurations	802.11b Channel 1

Vertical

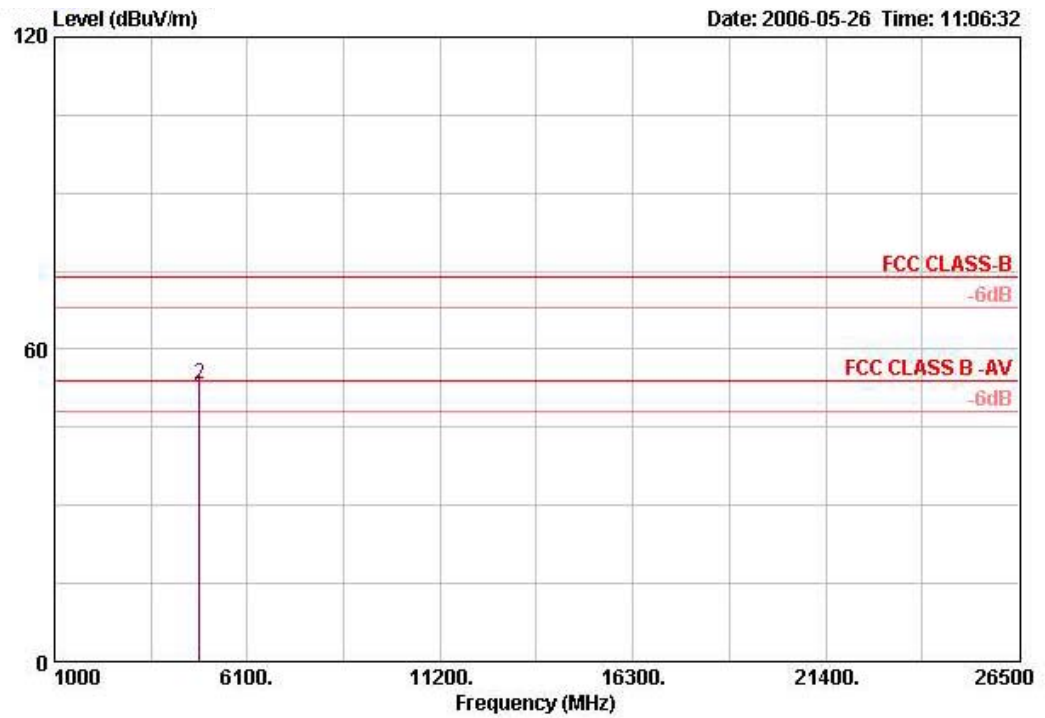

	Freq	Level	Over Limit	Limit Line	ReadAntenna Level	Antenna Factor	Cable Loss	Preamp Factor	Remark	Pol/Phase	Distance
	MHz	dBuV/m	dB	dBuV/m	dBuV	dB/m	dB	dB			m
1 !	4824.000	50.85	-3.15	54.00	48.89	32.83	4.30	35.16	AVERAGE	VERTICAL	3
2	4824.000	53.34	-20.66	74.00	51.38	32.83	4.30	35.16	PEAK	VERTICAL	3

Temperature	23°C	Humidity	64%
Test Engineer	Barry Chen	Configurations	802.11b Channel 1

Horizontal

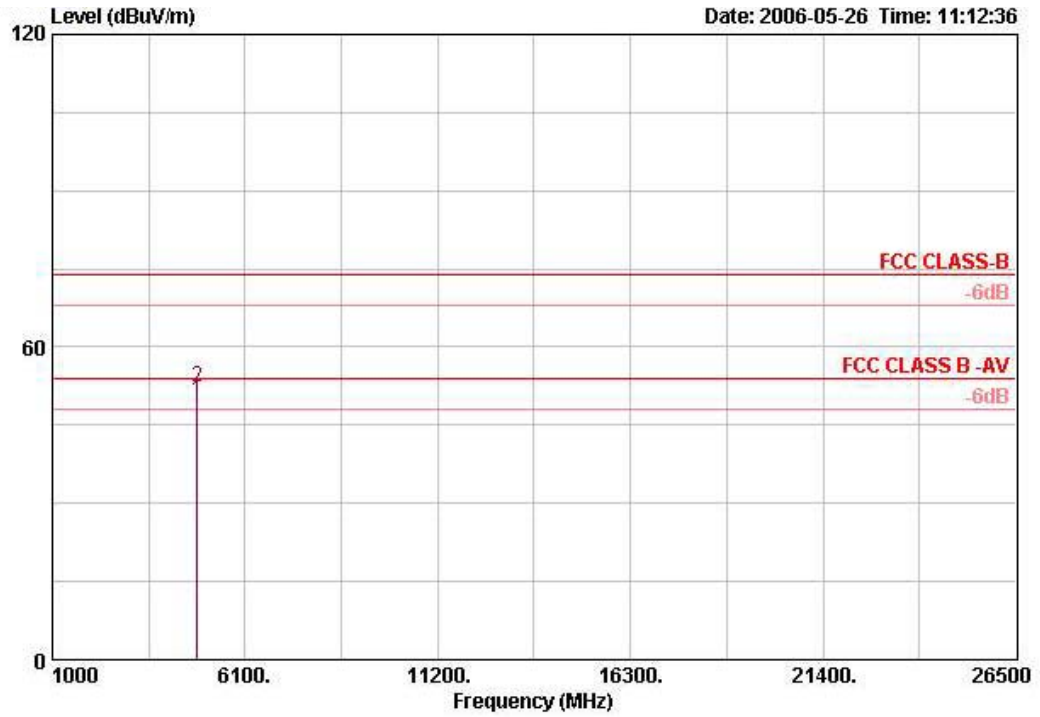

	Freq	Level	Over Limit	Limit Line	ReadAntenna Level	Antenna Factor	Cable Loss	Preamp Factor	Remark	Pol/Phase	Distance
	MHz	dBuV/m	dB	dBuV/m	dBuV	dB/m	dB	dB			m
1 !	4824.000	49.65	-4.35	54.00	47.68	32.83	4.30	35.16	AVERAGE	HORIZONTAL	3
2	4824.000	52.34	-21.66	74.00	50.37	32.83	4.30	35.16	PEAK	HORIZONTAL	3

Temperature	23°C	Humidity	64%
Test Engineer	Barry Chen	Configurations	802.11b Channel 6

Vertical

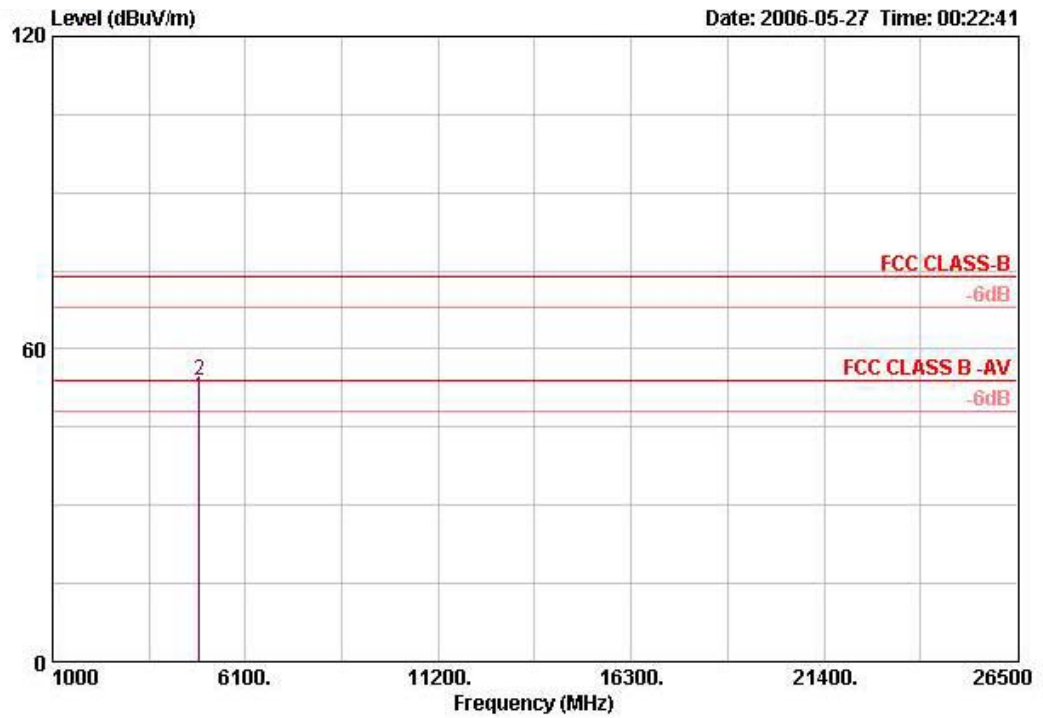

	Freq	Level	Over Limit	Limit Line	ReadAntenna Level	Antenna Factor	Cable Loss	Preamp Factor	Remark	Pol/Phase	Distance
	MHz	dBUV/m	dB	dBUV/m	dBuV	dB/m	dB	dB			m
1 !	4873.940	50.77	-3.23	54.00	48.74	32.88	4.30	35.15	AVERAGE	VERTICAL	3
2	4873.940	53.97	-20.03	74.00	51.94	32.88	4.30	35.15	PEAK	VERTICAL	3

Temperature	23°C	Humidity	64%
Test Engineer	Barry Chen	Configurations	802.11b Channel 6

Horizontal

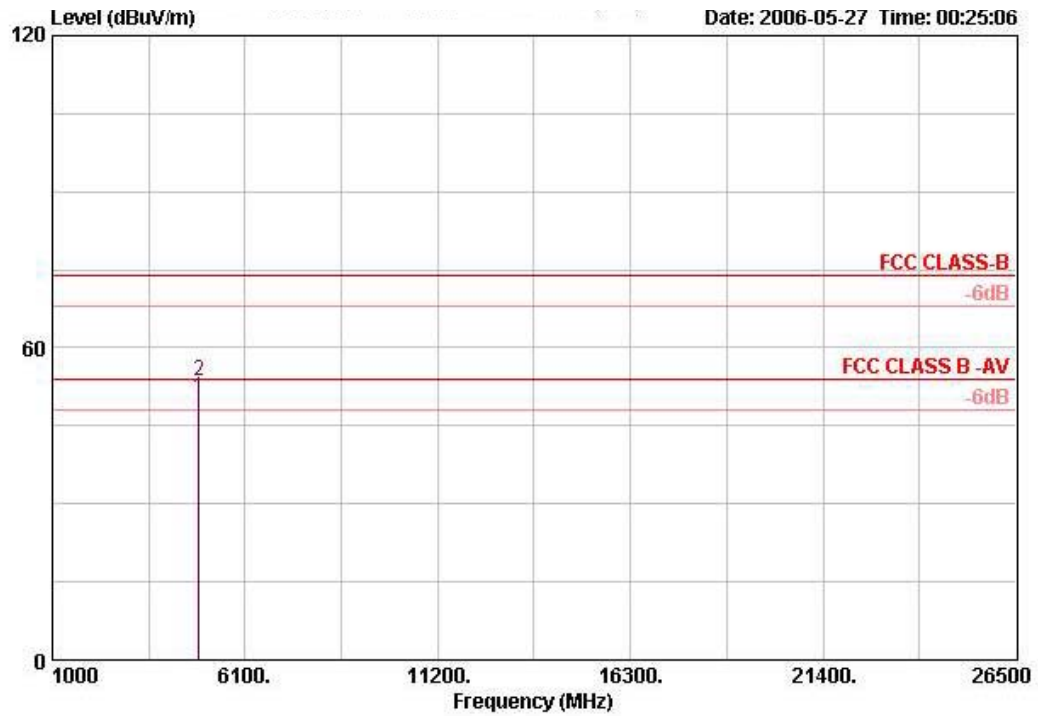

	Freq	Level	Over Limit	Limit Line	ReadAntenna Level	Antenna Factor	Cable Loss	Preamp Factor	Remark	Pol/Phase	Distance
	MHz	dBuV/m	dB	dBuV/m	dBuV	dB/m	dB	dB			m
1 !	4873.980	50.26	-3.74	54.00	48.23	32.88	4.30	35.15	AVERAGE	HORIZONTAL	3
2	4873.980	53.53	-20.47	74.00	51.51	32.88	4.30	35.15	PEAK	HORIZONTAL	3

Temperature	23°C	Humidity	64%
Test Engineer	Barry Chen	Configurations	802.11b Channel 11

Vertical

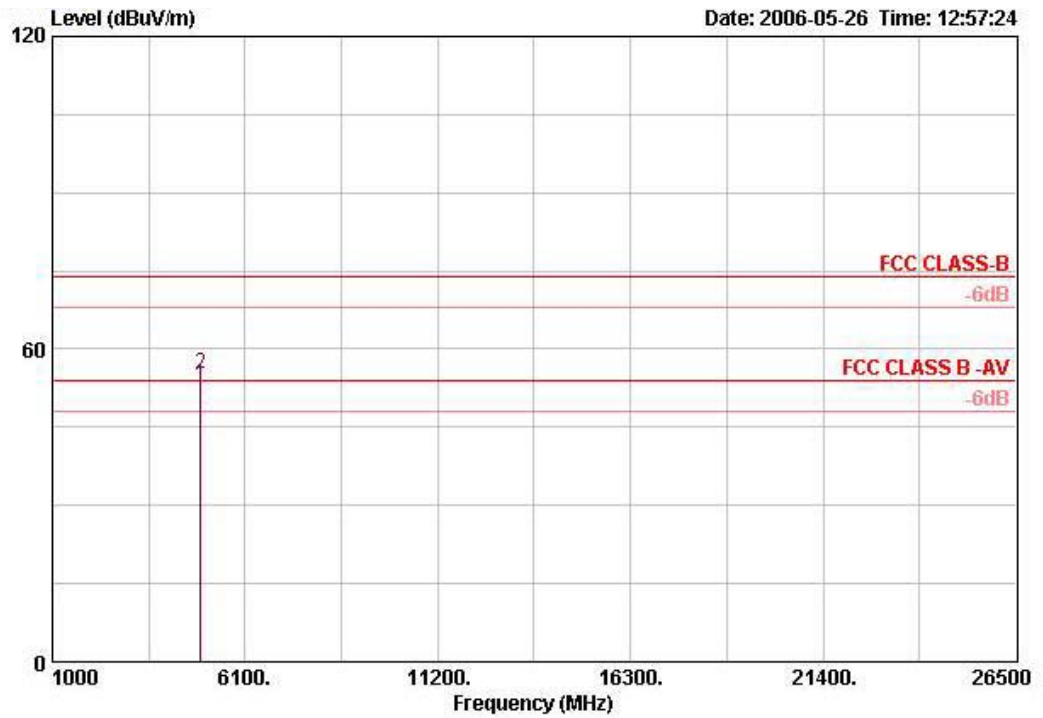

	Freq	Level	Over Limit	Limit Line	ReadAntenna Level	Antenna Factor	Cable Loss	Preamp Factor	Remark	Pol/Phase	Distance
	MHz	dBUV/m	dB	dBUV/m	dBuV	dB/m	dB	dB			m
1 !	4924.000	52.85	-1.15	54.00	50.76	32.93	4.30	35.14	AVERAGE	VERTICAL	3
2	4924.000	55.10	-18.90	74.00	53.01	32.93	4.30	35.14	PEAK	VERTICAL	3

Temperature	23°C	Humidity	64%
Test Engineer	Barry Chen	Configurations	802.11b Channel 11

Horizontal

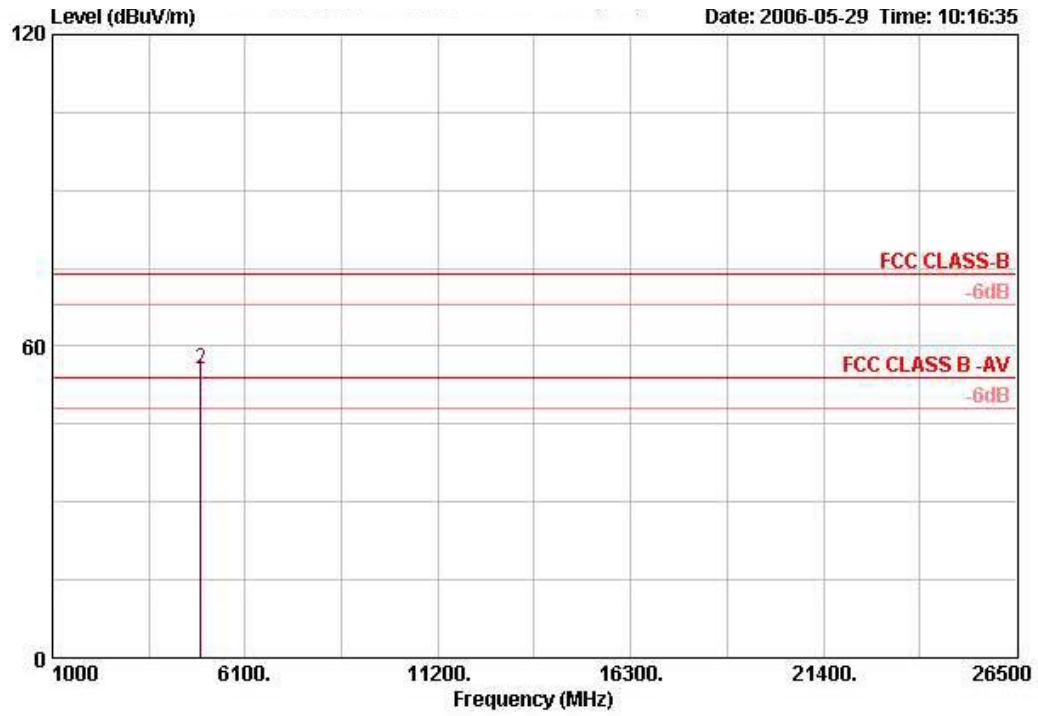

	Freq	Level	Over	Limit	Read	Antenna	Cable	Preamp	Remark	Pol/Phase	Distance
	MHz	dBuV/m	dB	dBuV/m	dBuV	dB/m	dB	dB			m
1 !	4924.040	53.49	-0.51	54.00	51.40	32.93	4.30	35.14	AVERAGE	HORIZONTAL	3
2	4924.040	55.46	-18.54	74.00	53.37	32.93	4.30	35.14	PEAK	HORIZONTAL	3

Temperature	23°C	Humidity	64%
Test Engineer	Barry Chen	Configurations	802.11g Channel 1

Vertical

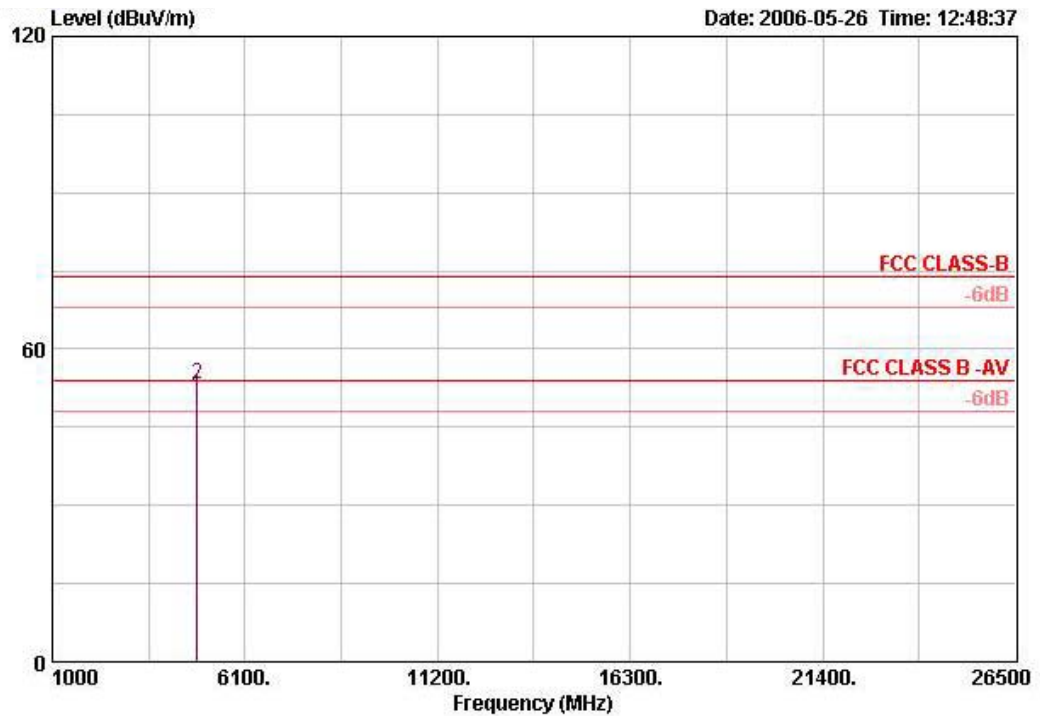

	Freq	Level	Over Limit	Limit Line	ReadAntenna Level	Antenna Factor	Cable Loss	Preamp Factor	Remark	Pol/Phase	Distance
	MHz	dBUV/m	dB	dBUV/m	dBuV	dB/m	dB	dB			m
1 !	4824.080	51.07	-2.93	54.00	49.11	32.83	4.30	35.16	AVERAGE	VERTICAL	3
2	4824.080	53.36	-20.64	74.00	51.40	32.83	4.30	35.16	PEAK	VERTICAL	3

Temperature	23°C	Humidity	64%
Test Engineer	Barry Chen	Configurations	802.11g Channel 1

Horizontal

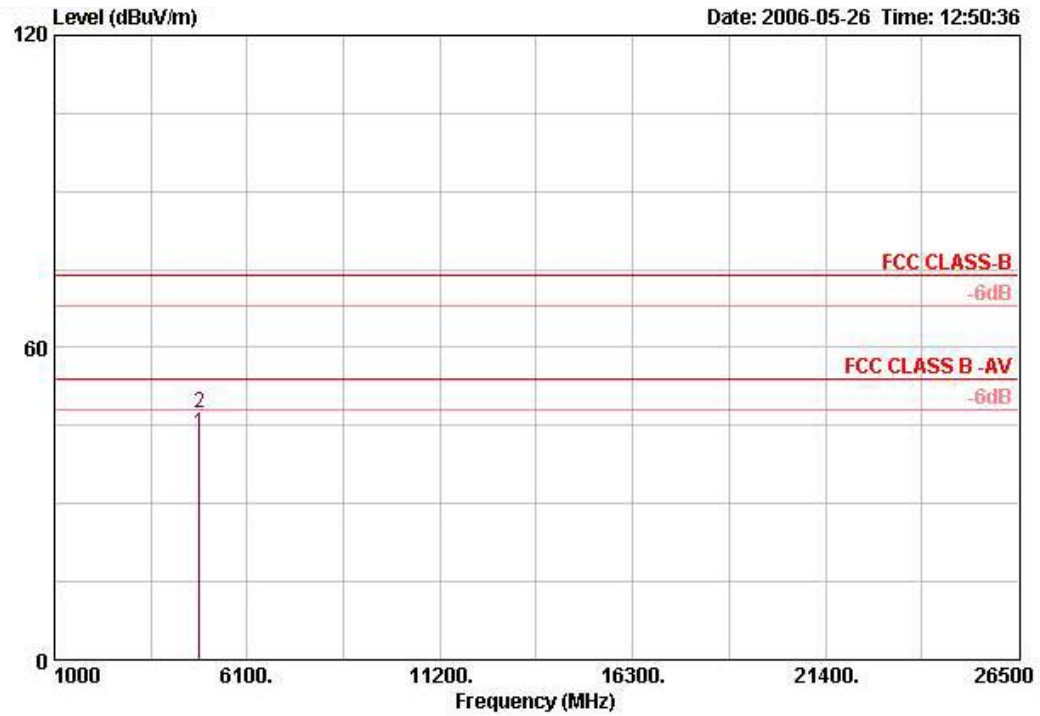

	Freq	Level	Over Limit	Limit Line	Read Level	Antenna Factor	Cable Loss	Preamp Factor	Remark	Pol/Phase	Distance
	MHz	dBuV/m	dB	dBuV/m	dBuV	dB/m	dB	dB			m
1	4824.040	43.38	-10.62	54.00	41.42	32.83	4.30	35.16	AVERAGE	HORIZONTAL	3
2	4824.040	47.39	-26.61	74.00	45.43	32.83	4.30	35.16	PEAK	HORIZONTAL	3

Temperature	23°C	Humidity	64%
Test Engineer	Barry Chen	Configurations	802.11g Channel 6

Vertical

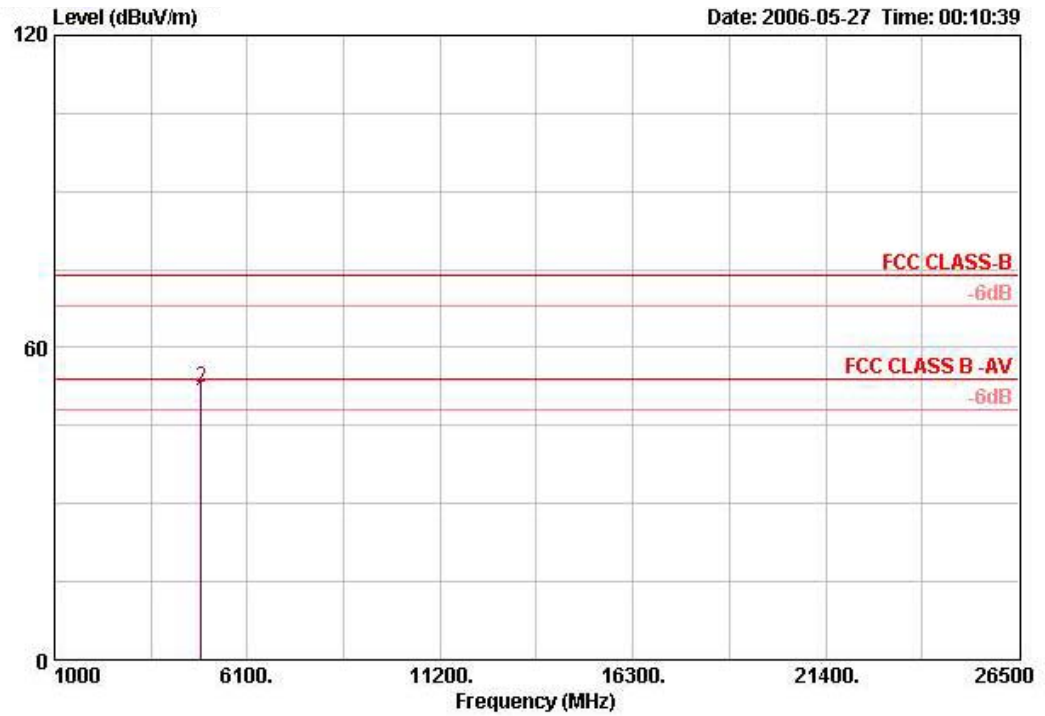

	Freq	Level	Over Limit	Limit Line	Read Level	Antenna Factor	Cable Loss	Preamp Factor	Remark	Pol/Phase	Distance
	MHz	dBuV/m	dB	dBuV/m	dBuV	dB/m	dB	dB			m
1 !	4874.000	49.63	-4.37	54.00	47.60	32.88	4.30	35.15	AVERAGE	VERTICAL	3
2	4874.000	52.29	-21.71	74.00	50.27	32.88	4.30	35.15	PEAK	VERTICAL	3

Temperature	23°C	Humidity	64%
Test Engineer	Barry Chen	Configurations	802.11g Channel 6

Horizontal

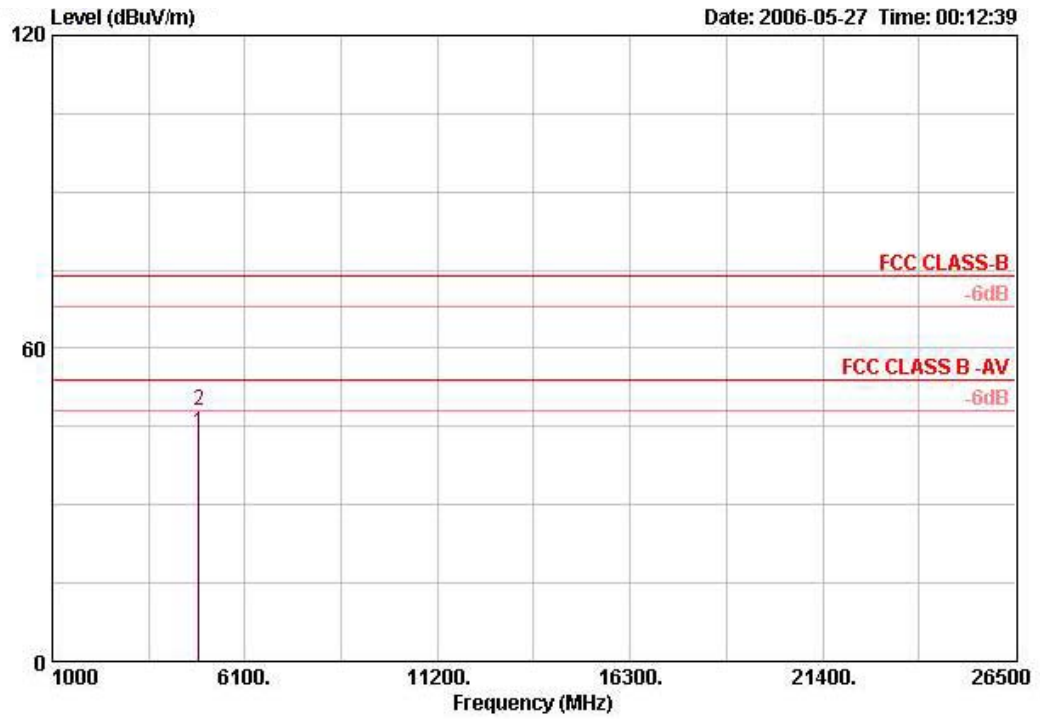

	Freq	Level	Over Limit	Limit Line	ReadAntenna Level	Antenna Factor	Cable Loss	Preamp Factor	Remark	Pol/Phase	Distance
	MHz	dBuV/m	dB	dBuV/m	dBuV	dB/m	dB	dB			m
1	4874.000	43.94	-10.06	54.00	41.92	32.88	4.30	35.15	AVERAGE	HORIZONTAL	3
2	4874.000	48.10	-25.90	74.00	46.07	32.88	4.30	35.15	PEAK	HORIZONTAL	3

Temperature	23°C	Humidity	64%
Test Engineer	Barry Chen	Configurations	802.11g Channel 11

Vertical

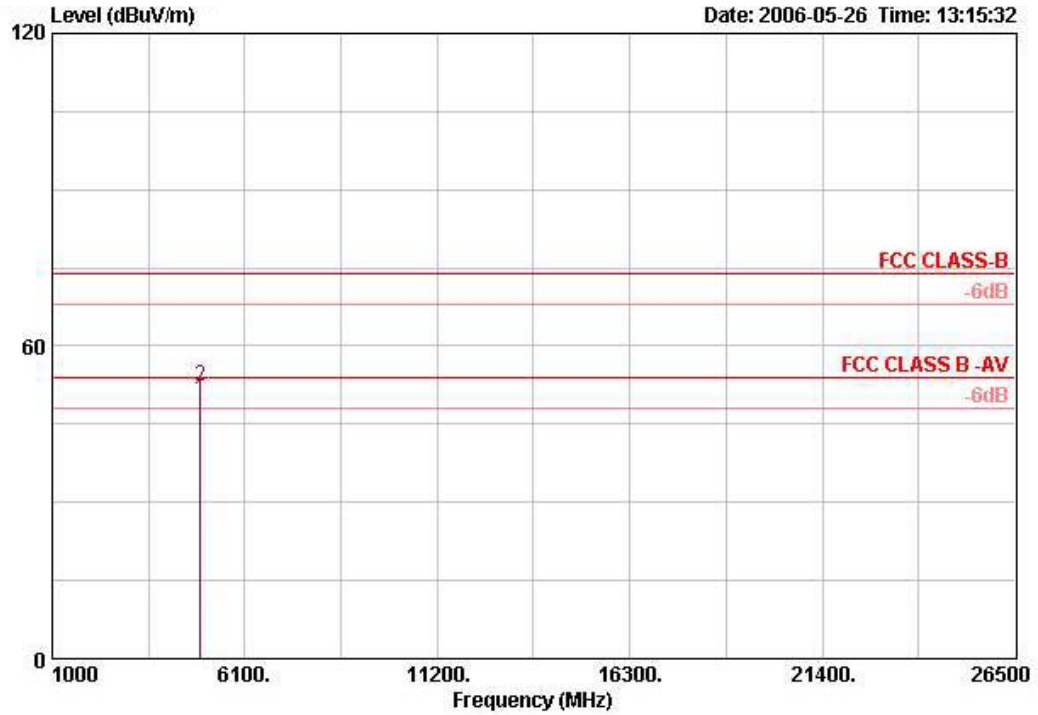

	Freq	Level	Over Limit	Limit Line	ReadAntenna Level	Antenna Factor	Cable Loss	Preamp Factor	Remark	Pol/Phase	Distance
	MHz	dBuV/m	dB	dBuV/m	dBuV	dB/m	dB	dB			m
1 !	4924.000	49.78	-4.22	54.00	47.69	32.93	4.30	35.14	AVERAGE	VERTICAL	3
2	4924.000	52.19	-21.81	74.00	50.10	32.93	4.30	35.14	PEAK	VERTICAL	3

Temperature	23°C	Humidity	64%
Test Engineer	Barry Chen	Configurations	802.11g Channel 11

Horizontal

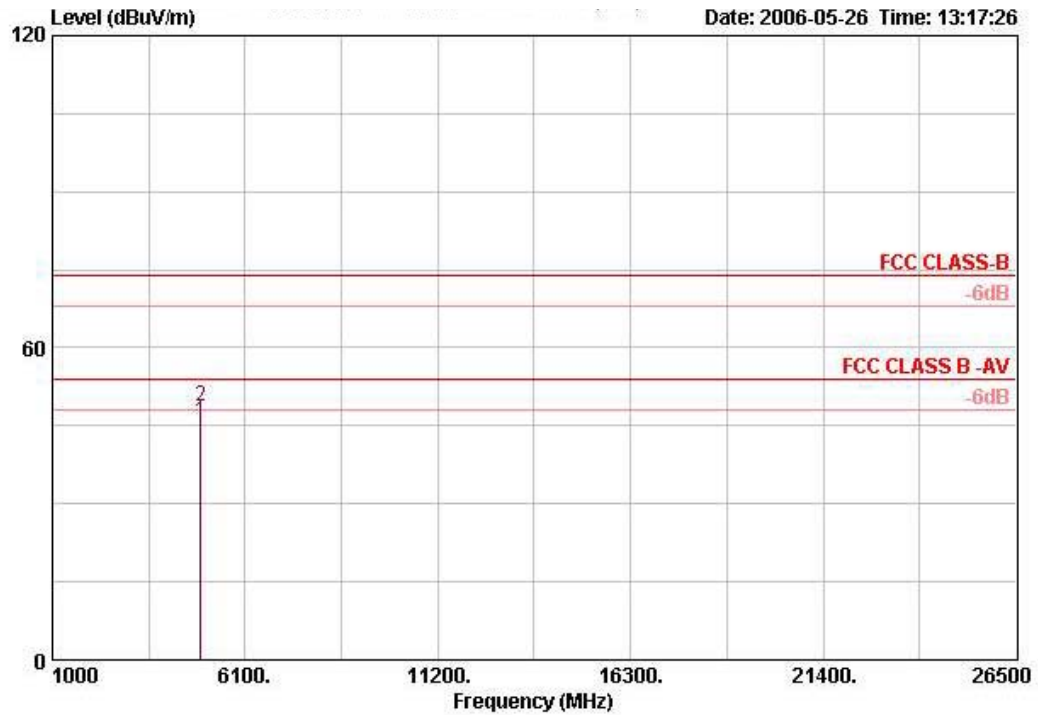

	Freq	Level	Over Limit	Limit Line	ReadAntenna Level	Antenna Factor	Cable Loss	Preamp Factor	Remark	Pol/Phase	Distance
	MHz	dBUV/m	dB	dBUV/m	dBuV	dB/m	dB	dB			m
1	4924.000	45.85	-8.15	54.00	43.76	32.93	4.30	35.14	AVERAGE	HORIZONTAL	3
2	4924.000	48.66	-25.34	74.00	46.58	32.93	4.30	35.14	PEAK	HORIZONTAL	3

Note:

The amplitude of spurious emissions which are attenuated by more than 20 dB below the permissible value has no need to be reported.

Emission level (dBUV/m) = 20 log Emission level (uV/m).

Corrected Reading: Antenna Factor + Cable Loss + Read Level - Preamp Factor = Level.

4.6. Band Edge Emissions Measurement

4.6.1. Limit

20dBc in any 100 kHz bandwidth outside the operating frequency band. In case the emission fall within the restricted band specified on 15.205(a), then the 15.209(a) limit in the table below has to be followed.

Frequencies (MHz)	Field Strength (micorvolts/meter)	Measurement Distance (meters)
0.009~0.490	2400/F(KHz)	300
0.490~1.705	24000/F(KHz)	30
1.705~30.0	30	30
30~88	100	3
88~216	150	3
216~960	200	3
Above 960	500	3

4.6.2. Measuring Instruments and Setting

Please refer to section 5 in this report. The following table is the setting of the spectrum analyzer.

Spectrum Parameter	Setting
Attenuation	Auto
Span Frequency	100 MHz
RB / VB (emission in restricted band)	1 MHz / 1MHz for Peak, 1 MHz / 10Hz for Average
RB / VB (other emission)	100 KHz / 100 KHz for Peak

4.6.3. Test Procedures

- The test procedure is the same as section 4.5.3, only the frequency range investigated is limited to 100MHz around bandedges.
- In case the emission is fail due to the used RB/VB is too wide, marker-delta method of FCC Public Notice DA00-705 will be followed.

4.6.4. Test Setup Layout

This test setup layout is the same as that shown in section 4.5.4.

4.6.5. Test Deviation

There is no deviation with the original standard.

4.6.6. EUT Operation during Test

The EUT was programmed to be in continuously transmitting mode.

4.6.7. Test Result of Band Edge and Fundamental Emissions

Temperature	23°C	Humidity	64%
Test Engineer	Barry Chen	Configurations	802.11b Channel 1, 11

Channel 1

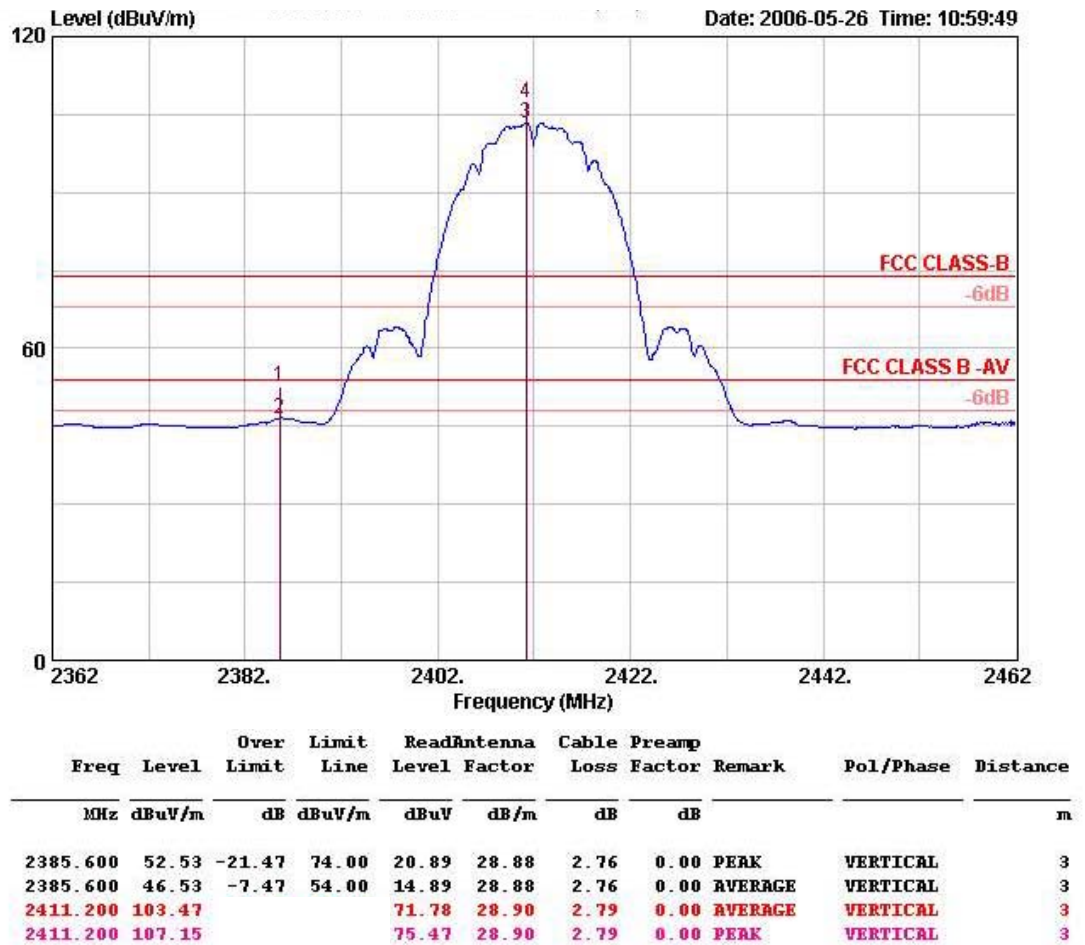

Item 3, 4 are the fundamental frequency at 2412 MHz.

Temperature	23°C	Humidity	64%
Test Engineer	Barry Chen	Configurations	802.11b Channel 11

Channel 11

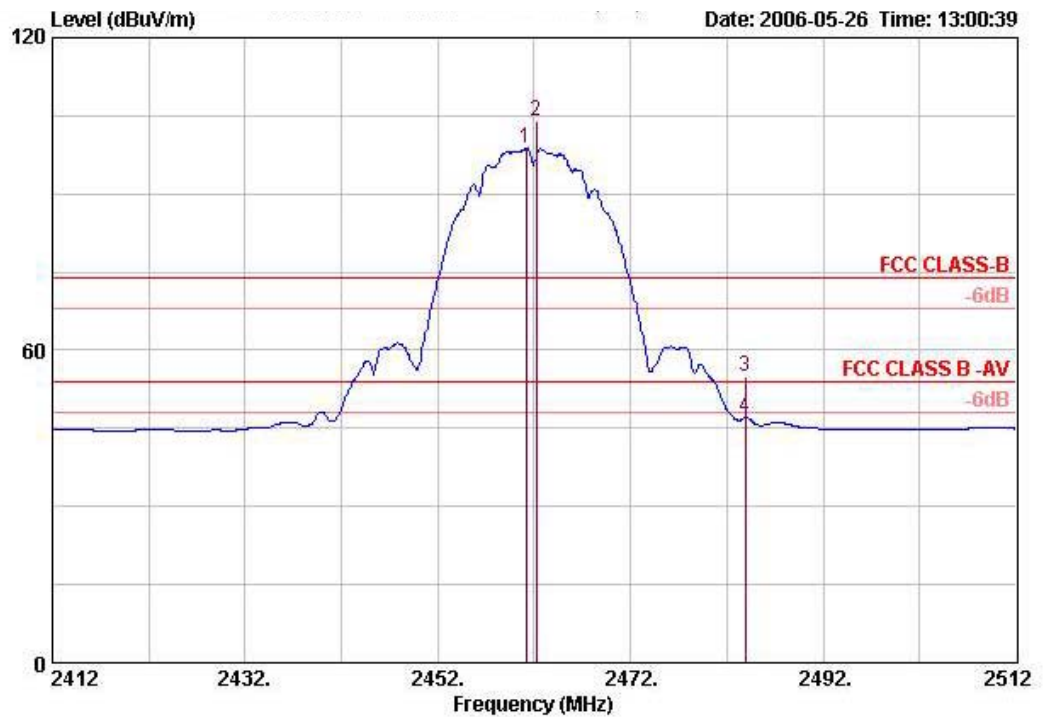

	Freq	Level	Over	Limit	Read	Antenna	Cable	Preamp	Remark	Pol/Phase	Distance
	MHz	dBUV/m	dB	dBUV/m	dBuV	dB/m	dB	dB			m
1 over	2461.200	98.79			67.01	28.96	2.81	0.00	AVERAGE	HORIZONTAL	3
2 over	2462.200	103.82			72.05	28.96	2.81	0.00	PEAK	HORIZONTAL	3
3	2483.900	54.80	-19.20	74.00	22.98	28.98	2.84	0.00	PEAK	HORIZONTAL	3
4	2483.900	47.14	-6.86	54.00	15.33	28.98	2.84	0.00	AVERAGE	HORIZONTAL	3

Item 1, 2 are the fundamental frequency at 2462 MHz.

Temperature	23°C	Humidity	64%
Test Engineer	Barry Chen	Configurations	802.11g Channel 1, 11

Channel 1

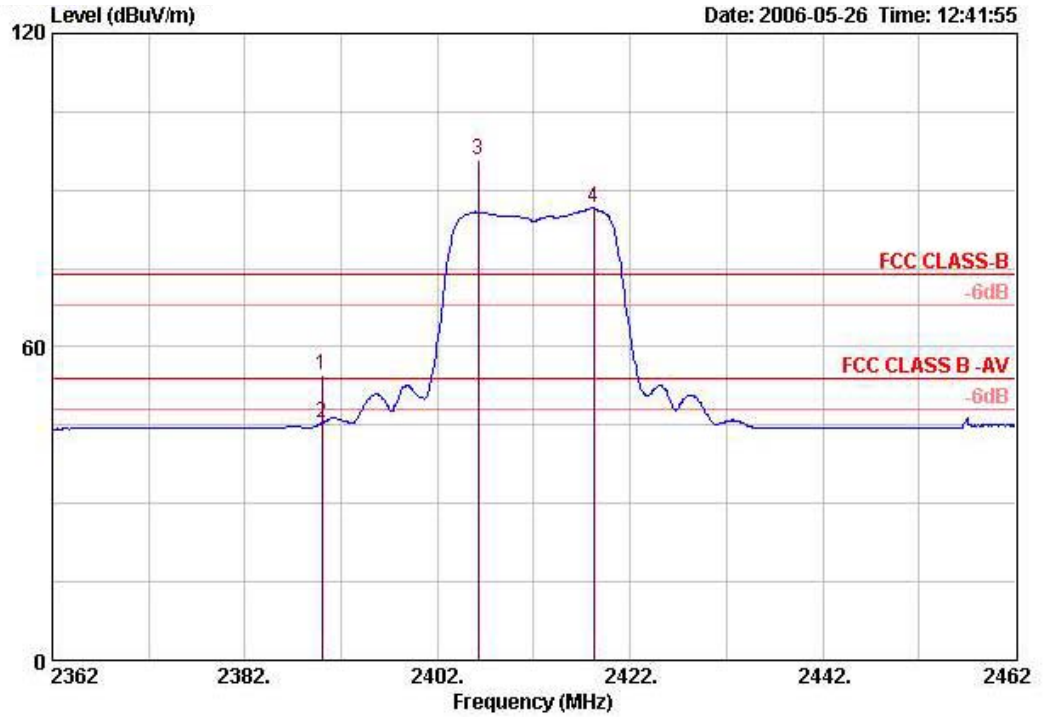

	Freq	Level	Over Limit	Limit Line	Read Level	Antenna Factor	Cable Loss	Preamp Factor	Remark	Pol/Phase	Distance
	MHz	dBuV/m	dB	dBuV/m	dBuV	dB/m	dB	dB			m
1	2390.000	54.66	-19.34	74.00	23.02	28.88	2.76	0.00	PEAK	HORIZONTAL	3
2	2390.000	45.31	-8.69	54.00	13.67	28.88	2.76	0.00	AVERAGE	HORIZONTAL	3
3 over	2406.200	95.69			64.01	28.90	2.79	0.00	PEAK	HORIZONTAL	3
4 over	2418.200	86.54			54.85	28.90	2.79	0.00	AVERAGE	HORIZONTAL	3

Item 3, 4 are the fundamental frequency at 2412 MHz.

Temperature	23°C	Humidity	64%
Test Engineer	Barry Chen	Configurations	802.11g Channel 1, 11

Channel 11

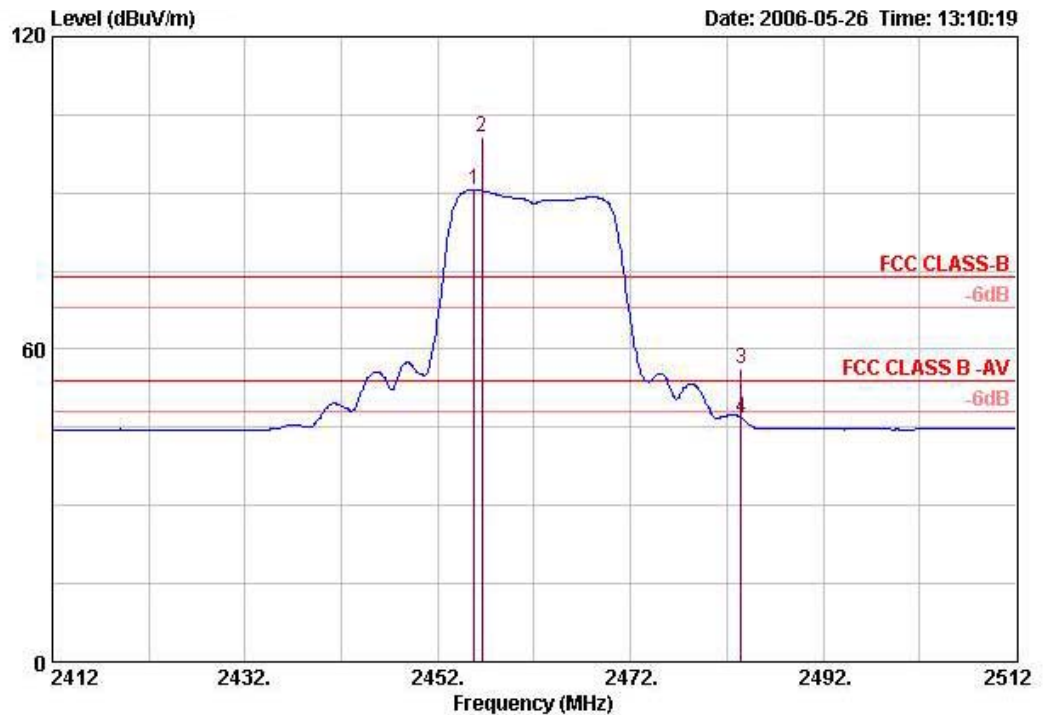

	Freq	Level	Over Limit	Limit Line	Read Level	Antenna Factor	Cable Loss	Preamp Factor	Remark	Pol/Phase	Distance
	MHz	dBuV/m	dB	dBuV/m	dBuV	dB/m	dB	dB			m
1 over	2455.800	90.62			58.84	28.96	2.81	0.00	AVERAGE	HORIZONTAL	3
2 over	2456.600	100.59			68.81	28.96	2.81	0.00	PEAK	HORIZONTAL	3
3	2483.500	56.25	-17.75	74.00	24.43	28.98	2.84	0.00	PEAK	HORIZONTAL	3
4	2483.500	46.71	-7.29	54.00	14.89	28.98	2.84	0.00	AVERAGE	HORIZONTAL	3

Item 1, 2 are the fundamental frequency at 2462 MHz.

Note:

Emission level (dBUV/m) = 20 log Emission level (uV/m).

Corrected Reading: Antenna Factor + Cable Loss + Read Level - Preamp Factor = Level.

Receiving maximum band edge emissions are Horizontal Polarization.

For Emission not in Restricted Band

Low Band Edge Plot on Configuration IEEE 802.11b / 2412 MHz

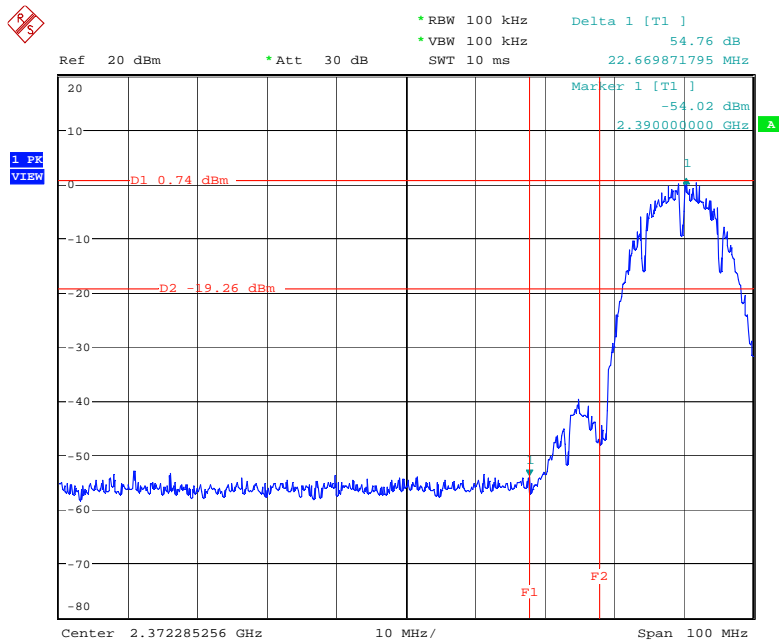

Date: 2.JUN.2006 16:30:59

High Band Edge Plot on Configuration IEEE 802.11b / 2462 MHz

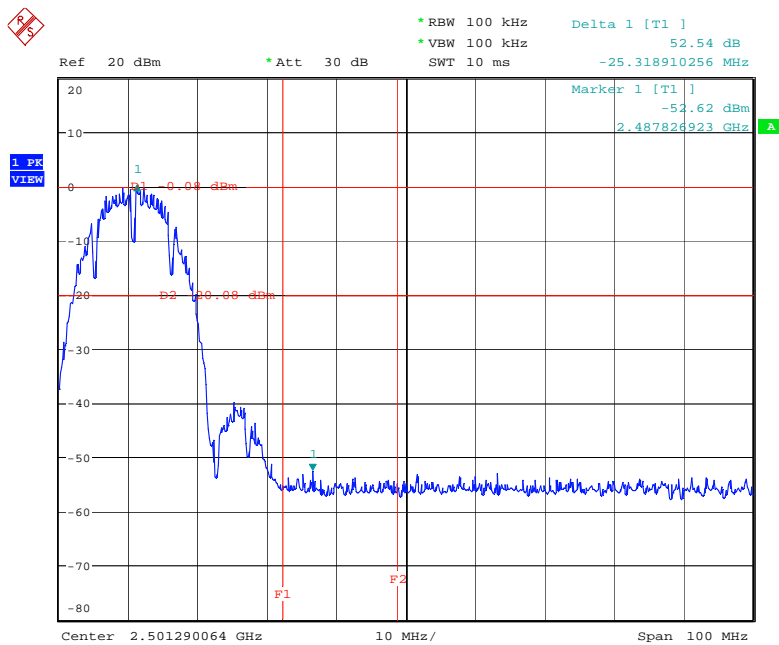

Date: 2.JUN.2006 16:37:49

Low Band Edge Plot on Configuration IEEE 802.11g / 2412 MHz

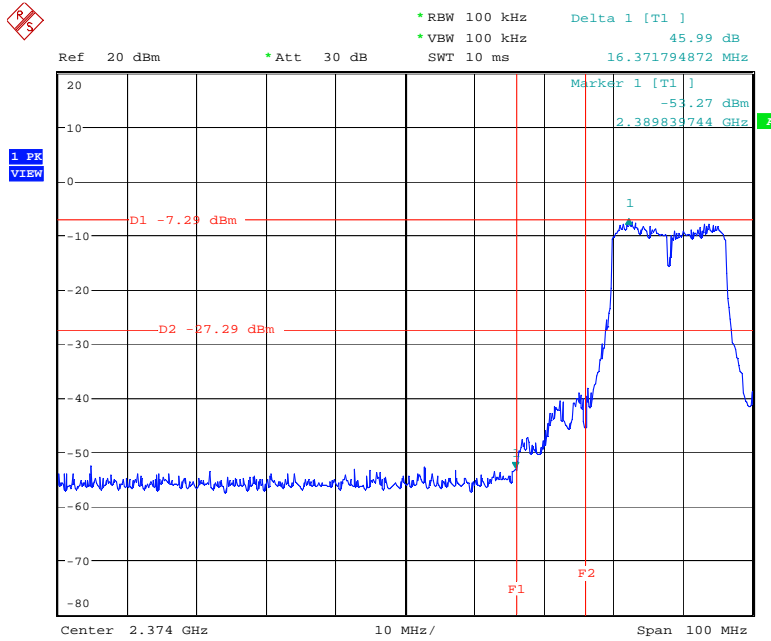

Date: 2.JUN.2006 16:47:09

High Band Edge Plot on Configuration IEEE 802.11g / 2462 MHz

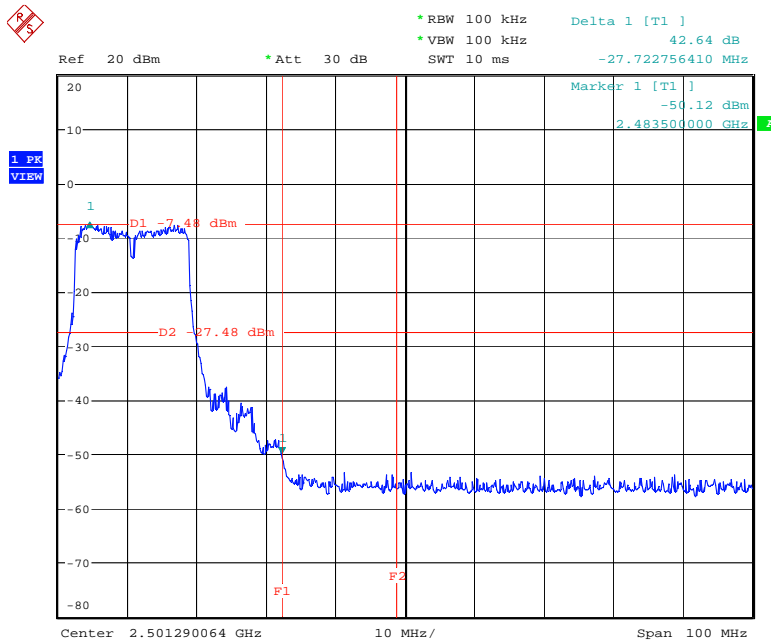

Date: 2.JUN.2006 16:39:37

4.7. Antenna Requirements

4.7.1. Limit

Except for special regulations, the Low-power Radio-frequency Devices must not be equipped with any jacket for installing an antenna with extension cable. An intentional radiator shall be designed to ensure that no antenna other than that furnished by the responsible party shall be used with the device. The use of a permanently attached antenna or of an antenna that uses a unique coupling to the intentional radiator shall be considered sufficient to comply with the provisions of this Section. The manufacturer may design the unit so that the user can replace a broken antenna, but the use of a standard antenna jack or electrical connector is prohibited. Further, this requirement does not apply to intentional radiators that must be professionally installed.

4.7.2. Antenna Connector Construction

Please refer to section 3.2 in this test report, all antenna connectors comply with the requirements.

5. LIST OF MEASURING EQUIPMENTS

Instrument	Manufacturer	Model No.	Serial No.	Characteristics	Calibration Date	Remark
EMC Receiver	R&S	ESCS 30	100174	9kHz – 2.75GHz	Feb. 22, 2006	Conduction (CO04-HY)
LISN	MessTec	NNB-2/16Z	99079	9kHz – 30MHz	Dec. 19, 2005	Conduction (CO04-HY)
LISN (Support Unit)	EMCO	3810/2NM	9708-1839	9kHz – 30MHz	Mar. 18, 2006	Conduction (CO04-HY)
RF Cable-CON	UTIFLEX	3102-26886-4	CB049	9kHz – 30MHz	Apr. 19, 2006	Conduction (CO04-HY)
EMI Filter	LINDGREN	LRE-2030	2651	< 450 Hz	N/A	Conduction (CO04-HY)
3m Semi Anechoic Chamber	SIDT FRANKONIA	SAC-3M	03CH03-HY	30 MHz - 1 GHz 3m	Jun. 16, 2005	Radiation (03CH03-HY)
Amplifier	SCHAFFNER	CPA9231A	3565	9 kHz - 2 GHz	Jan. 18, 2006	Radiation (03CH03-HY)
Amplifier	Agilent	8449B	3008A02120	1 GHz - 26.5 GHz	May 29, 2006	Radiation (03CH03-HY)
Amplifier	MITEQ	AMF-6F-260400	923364	26.5 GHz - 40 GHz	Jan. 24, 2006*	Radiation (03CH03-HY)
Spectrum Analyzer	R&S	FSP40	100004/040	9 kHz - 40 GHz	Sep. 30, 2005	Radiation (03CH03-HY)
Loop Antenna	R&S	HFH2-Z2	860004/001	9 kHz - 30 MHz	May 23, 2005*	Radiation (03CH03-HY)
Biconical Antenna	SCHWARZBECK	VHBB 9124	301	30 MHz - 200 MHz	Jul. 22, 2005	Radiation (03CH03-HY)
Log Antenna	SCHWARZBECK	VUSLP 9111	221	200 MHz - 1 GHz	Jul. 22, 2005	Radiation (03CH03-HY)
Horn Antenna	EMCO	3115	6903	1GHz ~ 18GHz	Mar. 15, 2006	Radiation (03CH03-HY)
Horn Antenna	SCHWARZBECK	BBHA9170	BBHA9170154	15 GHz - 40 GHz	Jun. 09, 2004*	Radiation (03CH03-HY)
RF Cable-R03m	Jye Bao	RG142	CB021	30 MHz - 1 GHz	Dec. 02, 2005	Radiation (03CH03-HY)
RF Cable-HIGH	SUHNER	SUCOFLEX 106	03CH03-HY	1 GHz - 40 GHz	Dec. 02, 2005	Radiation (03CH03-HY)
Turn Table	HD	DS 420	420/650/00	0 - 360 degree	N/A	Radiation (03CH03-HY)
Antenna Mast	HD	MA 240	240/560/00	1 m - 4 m	N/A	Radiation (03CH03-HY)
Spectrum analyzer	R&S	FSP30	100023	9kHz ~ 30GHz	Nov. 26, 2005	Conducted (TH01-HY)
Power meter	R&S	NRVS	100444	DC ~ 40GHz	Jul. 06, 2005	Conducted (TH01-HY)
Power sensor	R&S	NRV-Z55	100049	DC ~ 40GHz	Jul. 06, 2005	Conducted (TH01-HY)
Power Sensor	R&S	NRV-Z32	100057	30MHz ~ 6GHz	Apr. 27, 2006	Conducted (TH01-HY)
AC power source	HPC	HPA-500W	HPA-9100024	AC 0 ~ 300V	Apr. 21, 2005*	Conducted (TH01-HY)
DC power source	G.W.	GPC-6030D	C671845	DC 1V ~ 60V	Dec. 28, 2005	Conducted (TH01-HY)
Temp. and Humidity Chamber	KSON	THS-C3L	612	N/A	Oct. 01, 2005	Conducted (TH01-HY)
RF CABLE-1m	Jye Bao	RG142	CB034-1m	20MHz ~ 7GHz	Dec. 30, 2005	Conducted (TH01-HY)
RF CABLE-2m	Jye Bao	RG142	CB035-2m	20MHz ~ 1GHz	Dec. 30, 2005	Conducted (TH01-HY)
Oscilloscope	Tektronix	TDS1012	CO38515	100MHz / 1GS/s	Apr. 15, 2005*	Conducted (TH01-HY)

Instrument	Manufacturer	Model No.	Serial No.	Characteristics	Calibration Date	Remark
Signal Generator	R&S	SMR40	100116	10MHz ~ 40GHz	Dec. 30, 2005	Conducted (TH01-HY)
Data Generator	Tektronix	DG2030	063-2920-50	0.1Hz~400MHz	Jun. 01, 2006	Conducted (TH01-HY)

Note: Calibration Interval of instruments listed above is one year.

* Calibration Interval of instruments listed above is two year.

6. SPORTON COMPANY PROFILE

SPORTON Lab. was established in 1986 with one shielded room: the first private EMI test facility, offering local manufacturers an alternative EMI test facility apart from ERSO. In 1988, one 3M and 10M/3M open area test site were setup and also obtained official accreditation from FCC, VCCI and NEMKO. In 1993, a Safety laboratory was founded and obtained accreditation from UL of USA, CSA of Canada and TUV (Rhineland & PS) of Germany. In 1995, one EMC lab, including EMI and EMS test facilities was setup. In 1997, SPORTON Group has provided financial expense to relocate the headquarter to Orient Scientific Park in Taipei Hsien to offer more comprehensive, more qualified and better service to local suppliers and manufactures. In 1999, Safety Group and Component Group were setup. In 2001, SPORTON has established 3M/10M chamber in Hwa Ya Technology Park.

6.1. Test Location

SHIJR	ADD : 6Fl., No. 106, Sec. 1, Shintai 5th Rd., Shijr City, Taipei, Taiwan 221, R.O.C. TEL : 02-2696-2468 FAX : 02-2696-2255
HWA YA	ADD : No. 52, Hwa Ya 1st Rd., Kwei-Shan Hsiang, Tao Yuan Hsien, Taiwan, R.O.C. TEL : 03-327-3456 FAX : 03-318-0055
LINKOU	ADD : No. 30-2, Dingfu Tsuen, Linkou Shiang, Taipei, Taiwan 244, R.O.C TEL : 02-2601-1640 FAX : 02-2601-1695
DUNGHU	ADD : No. 3, Lane 238, Kangle St., Neihu Chiu, Taipei, Taiwan 114, R.O.C. TEL : 02-2631-4739 FAX : 02-2631-9740
JUNGHE	ADD : 7Fl., No. 758, Jungjeng Rd., Junghe City, Taipei, Taiwan 235, R.O.C. TEL : 02-8227-2020 FAX : 02-8227-2626
NEIHU	ADD : 4Fl., No. 339, Hsin Hu 2 nd Rd., Taipei 114, Taiwan, R.O.C. TEL : 02-2794-8886 FAX : 02-2794-9777
JHUBEI	ADD : No.8, Lane 728, Bo-ai St., Jhubei City, Hsinchu County 302, Taiwan, R.O.C. TEL : 03-656-9065 FAX : 03-656-9085

7. NVLAP CERTIFICATE OF ACCREDITATION

United States Department of Commerce
National Institute of Standards and Technology

NVLAP[®]

Certificate of Accreditation to ISO/IEC 17025:1999

NVLAP LAB CODE: 200079-0

Sporton International, Inc. Hwa Ya EMC Laboratory
Tao Yuan Hsien 333
TAIWAN

*is recognized by the National Voluntary Laboratory Accreditation Program for conformance with criteria set forth in
NIST Handbook 150:2001 and all requirements of ISO/IEC 17025:1999.
Accreditation is granted for specific services, listed on the Scope of Accreditation, for:*

ELECTROMAGNETIC COMPATIBILITY AND TELECOMMUNICATIONS

2006-01-01 through 2006-12-31
Effective dates



For the National Institute of Standards and Technology

NVLAP-01C (REV. 2005-05-19)