

FCC TEST REPORT

REPORT NO.: RF940518L08

MODEL NO.: BSH203

RECEIVED: May 18, 2005

TESTED: May 30 ~ Jun. 02, 2005

ISSUED: Jun. 06, 2005

APPLICANT: AboCom Systems, Inc.

ADDRESS: 1F, No. 21, Yanfa 2nd Rd., SBIP, Hsinchu City
300, Taiwan, R.O.C.

ISSUED BY: Advance Data Technology Corporation

LAB ADDRESS: No. 47, 14th Ling, Chia Pau Tsuen, Lin Kou
Hsiang 244, Taipei Hsien, Taiwan, R.O.C.

TEST LOCATION: No. 19, Hwa Ya 2nd Rd., Wen Hwa Tsuen,
Kwei Shan Hsiang, Taoyuan Hsien 333,
Taiwan, R.O.C.

This test report consists of 79 pages in total. It may be duplicated completely for legal use with the approval of the applicant. It should not be reproduced except in full, without the written approval of our laboratory. The client should not use it to claim product endorsement by CNLA, A2LA or any government agency. The test results in the report only apply to the tested sample.





TABLE OF CONTENTS

1	CERTIFICATION	4
2	SUMMARY OF TEST RESULTS	5
2.1	MEASUREMENT UNCERTAINTY	5
3	GENERAL INFORMATION	6
3.1	GENERAL DESCRIPTION OF EUT	6
3.2	DESCRIPTION OF TEST MODES	7
3.2.1	CONFIGURATION OF SYSTEM UNDER TEST	8
3.2.2	TEST MODE APPLICABILITY AND TESTED CHANNEL DETAIL	9
3.3	GENERAL DESCRIPTION OF APPLIED STANDARDS	11
3.4	DESCRIPTION OF SUPPORT UNITS	11
4	TEST PROCEDURES AND RESULTS	12
4.1	CONDUCTED EMISSION MEASUREMENT	12
4.1.1	LIMITS OF CONDUCTED EMISSION MEASUREMENT	12
4.1.2	TEST INSTRUMENTS	12
4.1.3	TEST PROCEDURES	13
4.1.4	DEVIATION FROM TEST STANDARD	13
4.1.5	TEST SETUP	14
4.1.6	EUT OPERATING CONDITIONS	14
4.1.7	TEST RESULTS	15
4.2	NUMBER OF HOPPING FREQUENCY USED	27
4.2.1	LIMIT OF HOPPING FREQUENCY USED	27
4.2.2	TEST INSTRUMENTS	27
4.2.3	TEST PROCEDURES	28
4.2.4	DEVIATION FROM TEST STANDARD	28
4.2.5	TEST SETUP	29
4.2.6	TEST RESULTS	29
4.3	DWELL TIME ON EACH CHANNEL	31
4.3.1	LIMIT OF DWELL TIME USED	31
4.3.2	TEST INSTRUMENTS	31
4.3.3	TEST PROCEDURES	32
4.3.4	DEVIATION FROM TEST STANDARD	32
4.3.5	TEST SETUP	32
4.3.6	TEST RESULTS	33
4.4	CHANNEL BANDWIDTH	37
4.4.1	LIMITS OF CHANNEL BANDWIDTH	37
4.4.2	TEST INSTRUMENTS	37
4.4.3	TEST PROCEDURE	38
4.4.4	DEVIATION FROM TEST STANDARD	38
4.4.5	TEST SETUP	38
4.4.6	EUT OPERATING CONDITION	38
4.4.7	TEST RESULTS	39
4.5	HOPPING CHANNEL SEPARATION	42



4.5.1	LIMIT OF HOPPING CHANNEL SEPARATION	42
4.5.2	TEST INSTRUMENTS.....	42
4.5.3	TEST PROCEDURES	43
4.5.4	DEVIATION FROM TEST STANDARD	43
4.5.5	TEST SETUP.....	43
4.5.6	TEST RESULTS	44
4.6	MAXIMUM PEAK OUTPUT POWER	47
4.6.1	LIMITS OF MAXIMUM PEAK OUTPUT POWER MEASUREMENT.....	47
4.6.2	INSTRUMENTS.....	47
4.6.3	TEST PROCEDURES	48
4.6.4	DEVIATION FROM TEST STANDARD	48
4.6.5	TEST SETUP.....	49
4.6.6	EUT OPERATING CONDITION	49
4.6.7	TEST RESULTS	50
4.7	RADIATED EMISSION MEASUREMENT	53
4.7.1	LIMITS OF RADIATED EMISSION MEASUREMENT.....	53
4.7.2	TEST INSTRUMENTS.....	54
4.7.3	TEST PROCEDURES	55
4.7.4	DEVIATION FROM TEST STANDARD	55
4.7.5	TEST SETUP.....	56
4.7.6	EUT OPERATING CONDITIONS	56
4.7.7	TEST RESULTS	57
4.8	BAND EDGES MEASUREMENT	67
4.8.1	LIMITS OF BAND EDGES MEASUREMENT.....	67
4.8.2	TEST INSTRUMENTS.....	67
4.8.3	TEST PROCEDURE.....	67
4.8.4	DEVIATION FROM TEST STANDARD	67
4.8.5	EUT OPERATING CONDITION	68
4.8.6	TEST RESULTS	68
4.9	ANTENNA REQUIREMENT	72
4.9.1	STANDARD APPLICABLE	72
4.9.2	ANTENNA CONNECTED CONSTRUCTION.....	72
5	PHOTOGRAPHS OF THE TEST CONFIGURATION.....	73
6	INFORMATION ON THE TESTING LABORATORIES	79



1 CERTIFICATION

PRODUCT : Bluetooth Stereo Headset
BRAND NAME : AboCom
MODEL NO. : BSH203
APPLICANT : AboCom Systems, Inc.
TESTED : May 30 ~ Jun. 02, 2005
TEST SAMPLE : ENGINEERING SAMPLE
STANDARDS : FCC Part 15, Subpart C (Section 15.247)
ANSI C63.4-2003

The above equipment has been tested by **Advance Data Technology Corporation**, and found compliance with the requirement of the above standards. The test record, data evaluation & Equipment Under Test (EUT) configurations represented herein are true and accurate accounts of the measurements of the sample's EMC characteristics under the conditions specified in this report.

PREPARED BY : Andrea Hsia , **DATE:** Jun. 06, 2005
(Andrea Hsia)

TECHNICAL
ACCEPTANCE : Gary Chang , **DATE:** Jun. 06, 2005
Responsible for RF (Gary Chang)

APPROVED BY : Cody Chang , **DATE:** Jun. 06, 2005
(Cody Chang / Deputy Manager)

2 SUMMARY OF TEST RESULTS

The EUT has been tested according to the following specifications:

APPLIED STANDARD: FCC Part 15, Subpart C			
Standard Section	Test Type and Limit	Result	REMARK
15.207	AC Power Conducted Emission	PASS	Meet the requirement of limit Minimum passing margin is -10.76dB at 0.384 MHz
15.247(a)(1) (iii)	Number of Hopping Frequency Used Spec.: At least 15 channels	PASS	Meet the requirement of limit
15.247(a)(1) (iii)	Dwell Time on Each Channel Spec. : Max. 0.4 second within 31.6 second	PASS	Meet the requirement of limit
15.247(a)(1)	1. Hopping Channel Separation Spec. : Min. 25 kHz or 20 dB bandwidth, whichever is greater 2. Spectrum Bandwidth of a Frequency Hopping Sequence Spread Spectrum System	PASS	Meet the requirement of limit
15.247(b)	Maximum Peak Output Power Spec.: max. 30dBm	PASS	Meet the requirement of limit
15.247(d)	Transmitter Radiated Emissions Spec.: Table 15.209	PASS	Meet the requirement of limit Minimum passing margin is -2.55 dB at 154.41 MHz
15.247(d)	Band Edge Measurement	PASS	Meet the requirement of limit

2.1 MEASUREMENT UNCERTAINTY

Where relevant, the following measurement uncertainty levels have been estimated for tests performed on the EUT as specified in CISPR 16-4:

MEASUREMENT	FREQUENCY	UNCERTAINTY
Conducted emissions	9kHz~30MHz	2.44 dB
Radiated emissions	30MHz ~ 200MHz	3.63 dB
	200MHz ~1000MHz	3.65 dB
	1GHz ~ 18GHz	2.20 dB
	18GHz ~ 40GHz	1.88 dB

3 GENERAL INFORMATION

3.1 GENERAL DESCRIPTION OF EUT

PRODUCT	Bluetooth Stereo Headset
MODEL NO.	BSH203
POWER SUPPLY	3.7Vdc from Battery 5.0Vdc from AC Adapter
MODULATION TYPE	GFSK
MODULATION TECHNOLOGY	FHSS
FREQUENCY RANGE	2402 MHz ~ 2480 MHz
NUMBER OF CHANNEL	79
OUTPUT POWER	0.834mW
ANTENNA TYPE	Refer to Note 1 as below
DATA CABLE	NA
I/O PORTS	NA

NOTE:

1. The following antenna were provided to this EUT.

Item	Antenna Type	Gain (dBi)
1	Chip	1.00
2	PIFA	-0.83

2. The EUT was tested with the following adapter:

BRAND :	DVE
MODEL :	DSA-0051-03
INPUT :	100-240Vac, 50/60Hz, 0.2A
OUTPUT :	5Vdc, 1.0A
POWER LINE :	AC 1.33m non-shielded cable without core

3. The above EUT information was declared by manufacturer and for more detailed features description, please refer to the manufacturer's specifications or User's Manual.

3.2 DESCRIPTION OF TEST MODES

Operated in 2400 ~ 2483.5MHz Band:

79 channels are provided to this EUT.

Channel	Freq. (MHz)	Channel	Freq. (MHz)	Channel	Freq. (MHz)	Channel	Freq. (MHz)
0	2402	20	2422	40	2442	60	2462
1	2403	21	2423	41	2443	61	2463
2	2404	22	2424	42	2444	62	2464
3	2405	23	2425	43	2445	63	2465
4	2406	24	2426	44	2446	64	2466
5	2407	25	2427	45	2447	65	2467
6	2408	26	2428	46	2448	66	2468
7	2409	27	2429	47	2449	67	2469
8	2410	28	2430	48	2450	68	2470
9	2411	29	2431	49	2451	69	2471
10	2412	30	2431	50	2452	70	2472
11	2413	31	2433	51	2453	71	2473
12	2414	32	2434	52	2454	72	2474
13	2415	33	2435	53	2455	73	2475
14	2416	34	2436	54	2456	74	2476
15	2417	35	2437	55	2457	75	2477
16	2418	36	2438	56	2458	76	2478
17	2419	37	2439	57	2459	77	2479
18	2420	38	2440	58	2460	78	2480
19	2421	39	2441	59	2461		

3.2.1 CONFIGURATION OF SYSTEM UNDER TEST

Test Mode 1, 2

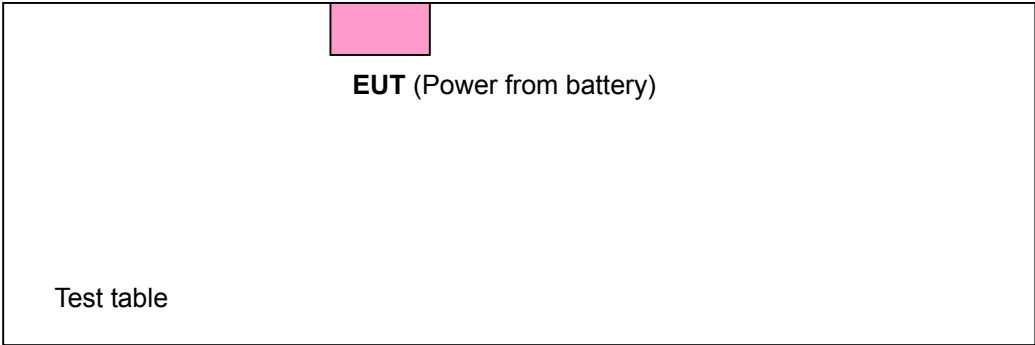

Test Mode 3, 4

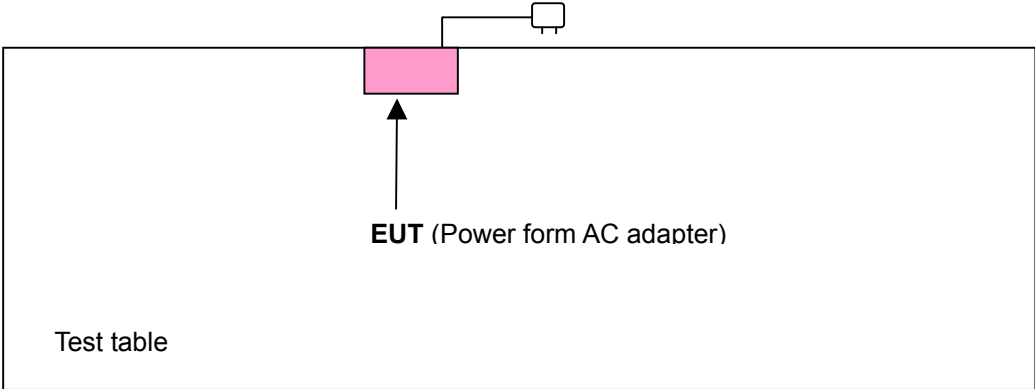



3.2.2 TEST MODE APPLICABILITY AND TESTED CHANNEL DETAIL

EUT configure mode	Applicable to				Description
	PLC	RE<1G	RE≥1G	APCM	
1	Note 1	v	Note 2	Note 3	For battery mode and EUT use Chip antenna
2	Note 1	v	Note 2	Note 3	For battery mode EUT use PIFA antenna
3	v	v	Note 2	Note 3	Charging mode EUT use Chip antenna
4	v	v	Note 2	Note 3	Charging mode EUT use PIFA antenna

Where PLC: Power Line Conducted Emission RE<1G RE: Radiated Emission below 1GHz
 RE≥1G: Radiated Emission above 1GHz APCM: Antenna Port Conducted Measurement

Note 1: No need to concern of Conducted Emission due to the EUT is powered by battery.

Note 2: No effect on Radiated Emission above 1GHz.

Note 3: Conducted RF measurement is independent on antenna.

Power Line Conducted Emission Test:

- Pre-Scan has been conducted to determine the worst-case mode from all possible combinations between available modulations and packet types.
- Following channel(s) was (were) selected for the final test as listed below.

EUT configure mode	Available Channel	Tested Channel	Modulation Technology	Modulation Type	Packet Type
3	0 to 78	0, 39, 78	FHSS	GFSK	DH5
4	0 to 78	0, 39, 78	FHSS	GFSK	DH5

Radiated Emission Test (Below 1 GHz):

- Pre-Scan has been conducted to determine the worst-case mode from all possible combinations between available modulations, X, Y and Z Axis and packet types
- Following channel(s) was (were) selected for the final test as listed below.

EUT configure mode	Available Channel	Tested Channel	Modulation Technology	Modulation Type	Packet Type	Axis
1	0 to 78	78	FHSS	GFSK	DH5	Z
2	0 to 78	78	FHSS	GFSK	DH5	Z
3	0 to 78	78	FHSS	GFSK	DH5	Z
4	0 to 78	78	FHSS	GFSK	DH5	Z

Radiated Emission Test (Above 1 GHz):

- Pre-Scan has been conducted to determine the worst-case mode from all possible combinations between available modulations, X, Y and Z Axis and packet types.
- Following channel(s) was (were) selected for the final test as listed below.

EUT configure mode	Available Channel	Tested Channel	Modulation Technology	Modulation Type	Packet Type	Axis
3	0 to 78	0, 39, 78	FHSS	GFSK	DH5	Z
4	0 to 78	0, 39, 78	FHSS	GFSK	DH5	Z



Bandedge Measurement:

- Pre-Scan has been conducted to determine the worst-case mode from all possible combinations between available modulations and packet types.
- Following channel(s) was (were) selected for the final test as listed below.

Available Channel	Tested Channel	Modulation Technology	Modulation Type	Packet Type
0 to 78	0, 78	FHSS	GFSK	DH5

Antenna Port Conducted Measurement:

- Pre-Scan has been conducted to determine the worst-case mode from all possible combinations between available modulations and packet types.
- Following channel(s) was (were) selected for the final test as listed below.

Available Channel	Tested Channel	Modulation Technology	Modulation Type	Packet Type
0 to 78	0, 39, 78	FHSS	GFSK	DH5

3.3 GENERAL DESCRIPTION OF APPLIED STANDARDS

The EUT is a Bluetooth Stereo Headset. According to the specifications of the manufacturer, it must comply with the requirements of the following standards:

FCC Part 15, Subpart C. (15.247)

ANSI C63.4-2003

All test items have been performed and recorded as per the above standards.

NOTE: The EUT is also considered as a kind of computer peripheral, because the connection to computer is necessary for typical use. It has been verified to comply with the requirements of FCC Part 15, Subpart B, Class B (DoC). The test report has been issued separately.

3.4 DESCRIPTION OF SUPPORT UNITS

NA

4 TEST PROCEDURES AND RESULTS

4.1 CONDUCTED EMISSION MEASUREMENT

4.1.1 LIMITS OF CONDUCTED EMISSION MEASUREMENT

FREQUENCY OF EMISSION (MHz)	CONDUCTED LIMIT (dB μ V)	
	Quasi-peak	Average
0.15-0.5	66 to 56	56 to 46
0.5-5	56	46
5-30	60	50

NOTE:

1. The lower limit shall apply at the transition frequencies.
2. All emanations from a class A/B digital device or system, including any network of conductors and apparatus connected thereto, shall not exceed the level of field strengths specified above.

4.1.2 TEST INSTRUMENTS

DESCRIPTION & MANUFACTURER	MODEL NO.	SERIAL NO.	CALIBRATED UNTIL
Test Receiver ROHDE & SCHWARZ	ESCS30	100288	Nov. 06, 2005
RF signal cable Woken	5D-FB	Cable-HyC02-01	Jan. 09, 2006
LISN ROHDE & SCHWARZ	ESH2-Z5	100100	Jan. 20, 2006
LISN ROHDE & SCHWARZ	ESH3-Z5	100311	Jan. 20, 2006
Software ADT	ADT_Cond_V3	NA	NA

- NOTE:**
1. The calibration interval of the above test instruments is 12 months and the calibrations are traceable to NML/ROC and NIST/USA.
 2. The test was performed in HwaYa Shielded Room 3.
 3. The VCCI Site Registration No. is C-2047.

4.1.3 TEST PROCEDURES

- a. The EUT was placed 0.4 meters from the conducting wall of the shielded room with EUT being connected to the power mains through a line impedance stabilization network (LISN). Other support units were connected to the power mains through another LISN. The two LISNs provide 50 ohm/ 50uH of coupling impedance for the measuring instrument.
- b. Both lines of the power mains connected to the EUT were checked for maximum conducted interference.
- c. The frequency range from 150kHz to 30MHz was searched. Emission levels under Limit - 20dB was not recorded.

4.1.4 DEVIATION FROM TEST STANDARD

No deviation.

4.1.5 TEST SETUP

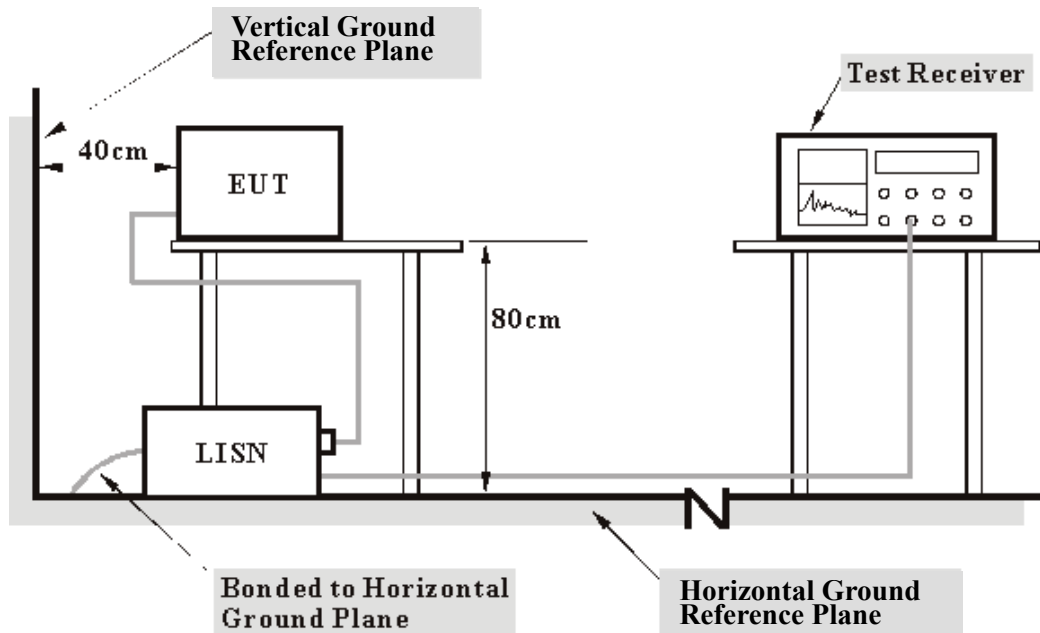

- Note:**
1. Support units were connected to second LISN.
 2. Both of LISNs (AMN) 80 cm from EUT and at the least 80 cm from other units and other metal planes support units.

For the actual test configuration, please refer to the related item – Photographs of the Test Configuration.

4.1.6 EUT OPERATING CONDITIONS

Set the transmitter part of EUT under transmission condition continuously at specific channel frequency.

4.1.7 TEST RESULTS

Conducted Worst-Case Data (Chip Antenna)

EUT	Bluetooth Stereo Headset	MODEL	BSH203
CHANNEL	Channel 0	6dB BANDWIDTH	9 kHz
MODULATION TYPE	GFSK	PHASE	Line 1
INPUT POWER (SYSTEM)	120 Vac, 60 Hz	ENVIRONMENTAL CONDITIONS	22deg. C, 62%RH, 991hPa
TEST MODE	3	TESTED BY	Morgan Chen

No	Freq. [MHz]	Corr. Factor (dB)	Reading Value		Emission Level		Limit		Margin	
			[dB (uV)]		[dB (uV)]		[dB (uV)]		(dB)	
			Q.P.	AV.	Q.P.	AV.	Q.P.	AV.	Q.P.	AV.
1	0.158	0.10	42.10	-	42.20	-	65.58	55.58	-23.38	-
2	0.315	0.10	46.62	28.76	46.72	28.86	59.83	49.83	-13.11	-20.97
3	0.632	0.14	34.52	-	34.66	-	56.00	46.00	-21.34	-
4	0.814	0.17	36.12	26.72	36.29	26.89	56.00	46.00	-19.71	-19.11
5	1.246	0.20	9.35	-	9.55	-	56.00	46.00	-46.45	-
6	1.793	0.20	28.21	-	28.41	-	56.00	46.00	-27.59	-

- REMARKS:**
1. Q.P. and AV. are abbreviations of quasi-peak and average individually.
 2. "-": The Quasi-peak reading value also meets average limit and measurement with the average detector is unnecessary.
 3. The emission levels of other frequencies were very low against the limit.
 4. Margin value = Emission level - Limit value
 5. Correction factor = Insertion loss + Cable loss
 6. Emission Level = Correction Factor + Reading Value.

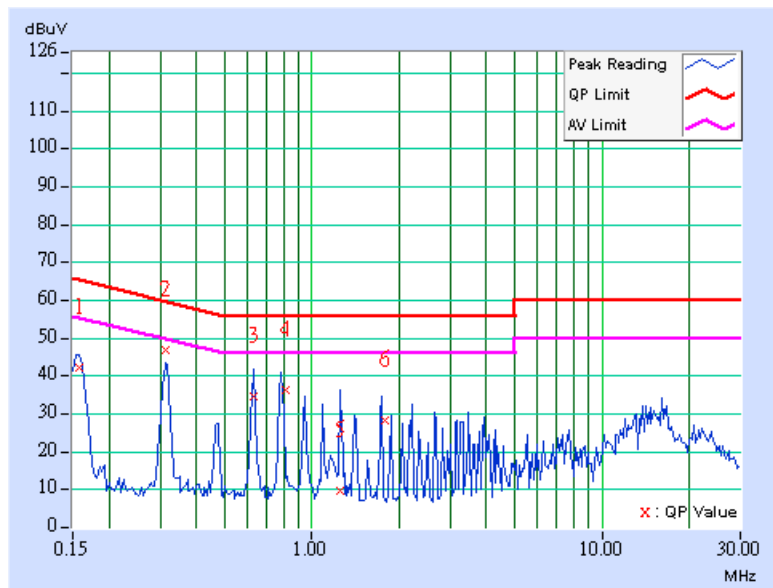



EUT	Bluetooth Stereo Headset	MODEL	BSH203
CHANNEL	Channel 0	6dB BANDWIDTH	9 kHz
MODULATION TYPE	GFSK	PHASE	Line 2
INPUT POWER (SYSTEM)	120 Vac, 60 Hz	ENVIRONMENTAL CONDITIONS	22deg. C, 62%RH, 991hPa
TEST MODE	3	TESTED BY	Morgan Chen

No	Freq. [MHz]	Corr. Factor (dB)	Reading Value		Emission Level		Limit		Margin	
			[dB (uV)]		[dB (uV)]		[dB (uV)]		(dB)	
			Q.P.	AV.	Q.P.	AV.	Q.P.	AV.	Q.P.	AV.
1	0.166	0.10	41.77	-	41.87	-	65.18	55.18	-23.31	-
2	0.330	0.10	40.70	33.41	40.80	33.51	59.46	49.46	-18.66	-15.95
3	0.662	0.14	35.45	-	35.59	-	56.00	46.00	-20.41	-
4	0.826	0.17	29.39	-	29.56	-	56.00	46.00	-26.44	-
5	1.313	0.20	6.38	-	6.58	-	56.00	46.00	-49.42	-
6	18.066	0.68	26.30	-	26.98	-	60.00	50.00	-33.02	-

- REMARKS:**
1. Q.P. and AV. are abbreviations of quasi-peak and average individually.
 2. "-": The Quasi-peak reading value also meets average limit and measurement with the average detector is unnecessary.
 3. The emission levels of other frequencies were very low against the limit.
 4. Margin value = Emission level - Limit value
 5. Correction factor = Insertion loss + Cable loss
 6. Emission Level = Correction Factor + Reading Value.

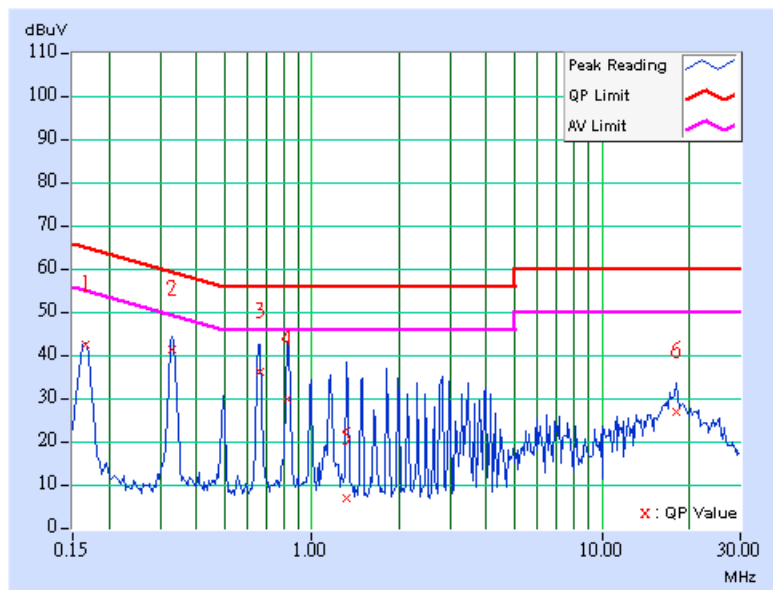



EUT	Bluetooth Stereo Headset	MODEL	BSH203
CHANNEL	Channel 39	6dB BANDWIDTH	9 kHz
MODULATION TYPE	GFSK	PHASE	Line 1
INPUT POWER (SYSTEM)	120 Vac, 60 Hz	ENVIRONMENTAL CONDITIONS	22deg. C, 62%RH, 991hPa
TEST MODE	3	TESTED BY	Morgan Chen

No	Freq. [MHz]	Corr. Factor (dB)	Reading Value		Emission Level		Limit		Margin	
			[dB (uV)]		[dB (uV)]		[dB (uV)]		(dB)	
			Q.P.	AV.	Q.P.	AV.	Q.P.	AV.	Q.P.	AV.
1	0.170	0.10	39.74	-	39.84	-	64.98	54.98	-25.14	-
2	0.338	0.10	34.85	-	34.95	-	59.26	49.26	-24.31	-
3	0.675	0.15	26.06	-	26.21	-	56.00	46.00	-29.79	-
4	0.853	0.18	34.79	-	34.97	-	56.00	46.00	-21.03	-
5	1.363	0.20	31.10	-	31.30	-	56.00	46.00	-24.70	-
6	1.868	0.20	9.77	-	9.97	-	56.00	46.00	-46.03	-

- REMARKS:**
1. Q.P. and AV. are abbreviations of quasi-peak and average individually.
 2. "-": The Quasi-peak reading value also meets average limit and measurement with the average detector is unnecessary.
 3. The emission levels of other frequencies were very low against the limit.
 4. Margin value = Emission level - Limit value
 5. Correction factor = Insertion loss + Cable loss
 6. Emission Level = Correction Factor + Reading Value.

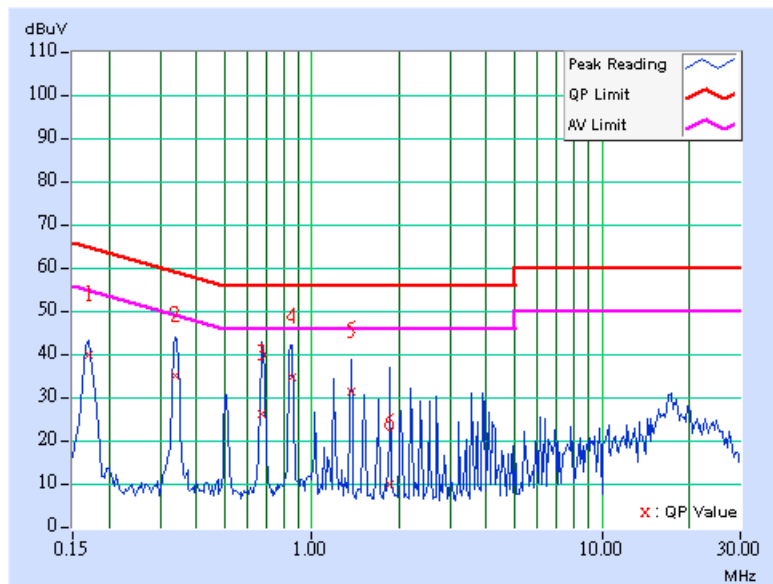



EUT	Bluetooth Stereo Headset	MODEL	BSH203
CHANNEL	Channel 39	6dB BANDWIDTH	9 kHz
MODULATION TYPE	GFSK	PHASE	Line 2
INPUT POWER (SYSTEM)	120 Vac, 60 Hz	ENVIRONMENTAL CONDITIONS	22deg. C, 62%RH, 991hPa
TEST MODE	3	TESTED BY	Morgan Chen

No	Freq. [MHz]	Corr. Factor (dB)	Reading Value		Emission Level		Limit		Margin	
			[dB (uV)]		[dB (uV)]		[dB (uV)]		(dB)	
			Q.P.	AV.	Q.P.	AV.	Q.P.	AV.	Q.P.	AV.
1	0.166	0.10	40.11	-	40.21	-	65.18	55.18	-24.97	-
2	0.338	0.10	43.03	36.37	43.13	36.47	59.26	49.26	-16.13	-12.79
3	0.670	0.14	29.01	-	29.15	-	56.00	46.00	-26.85	-
4	0.841	0.17	38.35	29.77	38.52	29.94	56.00	46.00	-17.48	-16.06
5	1.854	0.20	22.92	-	23.12	-	56.00	46.00	-32.88	-
6	2.360	0.20	14.92	-	15.12	-	56.00	46.00	-40.88	-

- REMARKS:**
1. Q.P. and AV. are abbreviations of quasi-peak and average individually.
 2. "-": The Quasi-peak reading value also meets average limit and measurement with the average detector is unnecessary.
 3. The emission levels of other frequencies were very low against the limit.
 4. Margin value = Emission level - Limit value
 5. Correction factor = Insertion loss + Cable loss
 6. Emission Level = Correction Factor + Reading Value.

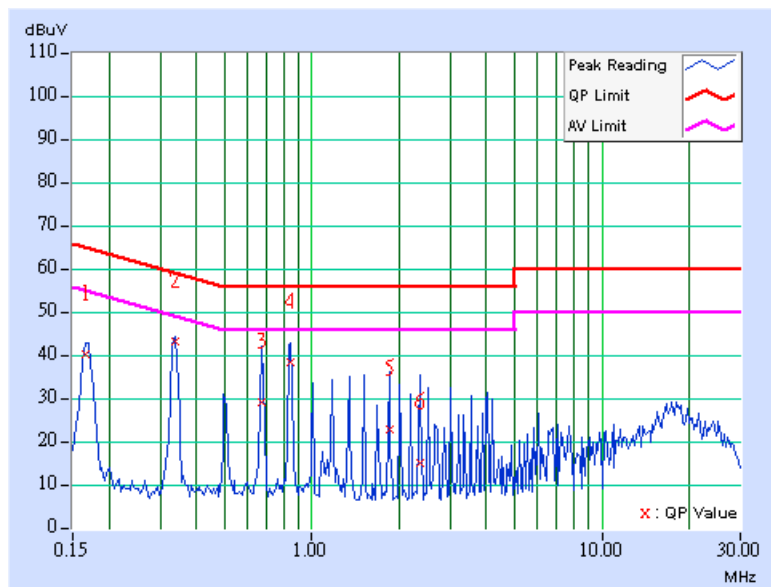



EUT	Bluetooth Stereo Headset	MODEL	BSH203
CHANNEL	Channel 78	6dB BANDWIDTH	9 kHz
MODULATION TYPE	GFSK	PHASE	Line 1
INPUT POWER (SYSTEM)	120 Vac, 60 Hz	ENVIRONMENTAL CONDITIONS	22deg. C, 62%RH, 991hPa
TEST MODE	3	TESTED BY	Morgan Chen

No	Freq. [MHz]	Corr. Factor (dB)	Reading Value		Emission Level		Limit		Margin	
			[dB (uV)]		[dB (uV)]		[dB (uV)]		(dB)	
			Q.P.	AV.	Q.P.	AV.	Q.P.	AV.	Q.P.	AV.
1	0.170	0.10	38.29	-	38.39	-	64.98	54.98	-26.59	-
2	0.345	0.10	38.56	-	38.66	-	59.07	49.07	-20.41	-
3	0.693	0.15	36.49	-	36.64	-	56.00	46.00	-19.36	-
4	0.865	0.18	35.57	-	35.75	-	56.00	46.00	-20.25	-
5	1.387	0.20	31.16	-	31.36	-	56.00	46.00	-24.64	-
6	18.645	0.69	21.90	-	22.59	-	60.00	50.00	-37.41	-

- REMARKS:**
1. Q.P. and AV. are abbreviations of quasi-peak and average individually.
 2. "-": The Quasi-peak reading value also meets average limit and measurement with the average detector is unnecessary.
 3. The emission levels of other frequencies were very low against the limit.
 4. Margin value = Emission level - Limit value
 5. Correction factor = Insertion loss + Cable loss
 6. Emission Level = Correction Factor + Reading Value.

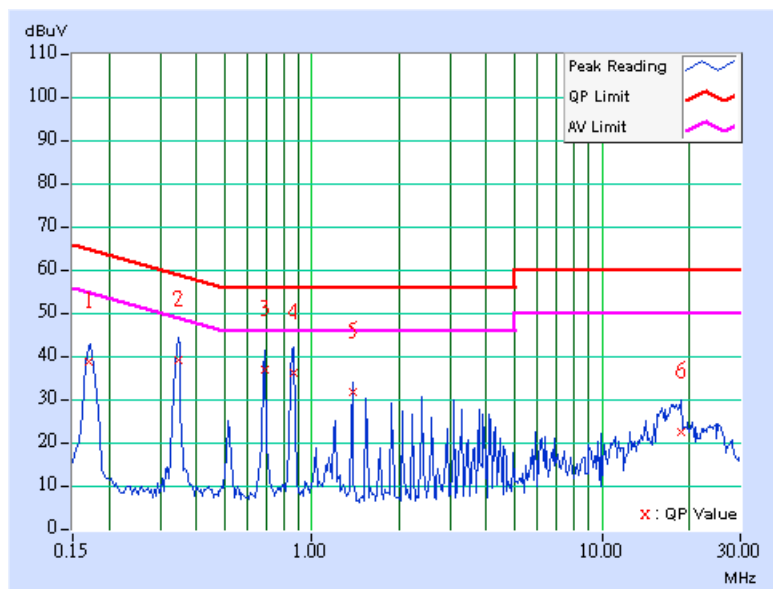



EUT	Bluetooth Stereo Headset	MODEL	BSH203
CHANNEL	Channel 78	6dB BANDWIDTH	9 kHz
MODULATION TYPE	GFSK	PHASE	Line 2
INPUT POWER (SYSTEM)	120 Vac, 60 Hz	ENVIRONMENTAL CONDITIONS	22deg. C, 62%RH, 991hPa
TEST MODE	3	TESTED BY	Morgan Chen

No	Freq. [MHz]	Corr. Factor (dB)	Reading Value [dB (uV)]		Emission Level [dB (uV)]		Limit [dB (uV)]		Margin (dB)	
			Q.P.	AV.	Q.P.	AV.	Q.P.	AV.	Q.P.	AV.
			1	0.173	0.10	42.28	-	42.38	-	64.79
2	0.345	0.10	42.96	-	43.06	-	59.07	49.07	-16.01	-
3	0.693	0.15	40.83	-	40.98	-	56.00	46.00	-15.02	-
4	0.865	0.18	39.42	-	39.60	-	56.00	46.00	-16.40	-
5	1.379	0.20	21.82	-	22.02	-	56.00	46.00	-33.98	-
6	17.418	0.65	23.13	-	23.78	-	60.00	50.00	-36.22	-

- REMARKS:**
1. Q.P. and AV. are abbreviations of quasi-peak and average individually.
 2. "-": The Quasi-peak reading value also meets average limit and measurement with the average detector is unnecessary.
 3. The emission levels of other frequencies were very low against the limit.
 4. Margin value = Emission level - Limit value
 5. Correction factor = Insertion loss + Cable loss
 6. Emission Level = Correction Factor + Reading Value.

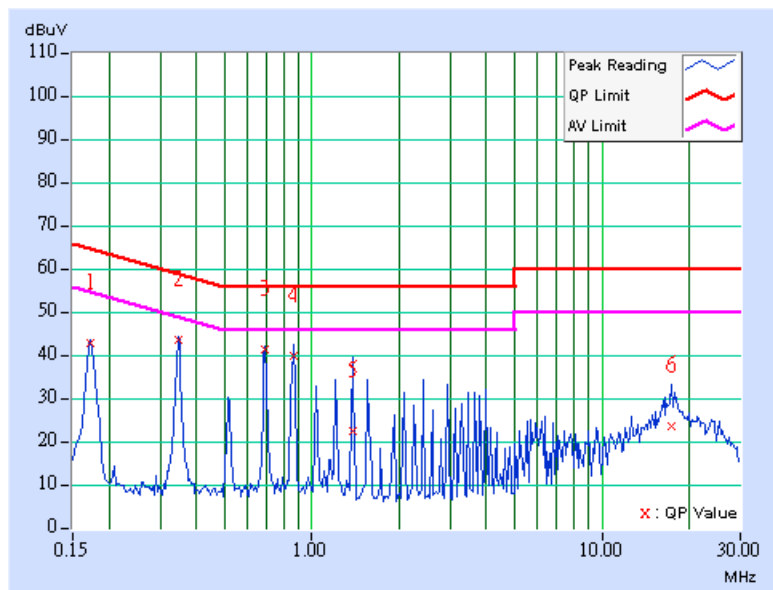



Conducted Worst-Case Data (PIFA Antenna)

EUT	Bluetooth Stereo Headset	MODEL	BSH203
CHANNEL	Channel 0	6dB BANDWIDTH	9 kHz
MODULATION TYPE	GFSK	PHASE	Line 1
INPUT POWER (SYSTEM)	120 Vac, 60 Hz	ENVIRONMENTAL CONDITIONS	22deg. C, 62%RH, 991hPa
TEST MODE	4	TESTED BY	Morgan Chen

No	Freq. [MHz]	Corr. Factor (dB)	Reading Value		Emission Level		Limit		Margin	
			[dB (uV)]		[dB (uV)]		[dB (uV)]		(dB)	
			Q.P.	AV.	Q.P.	AV.	Q.P.	AV.	Q.P.	AV.
1	0.177	0.10	38.74	-	38.84	-	64.61	54.61	-25.77	-
2	0.353	0.10	39.21	30.49	39.31	30.59	58.89	48.89	-19.58	-18.30
3	0.701	0.15	34.43	-	34.58	-	56.00	46.00	-21.42	-
4	0.873	0.18	34.09	-	34.27	-	56.00	46.00	-21.73	-
5	2.465	0.20	26.49	-	26.69	-	56.00	46.00	-29.31	-
6	17.766	0.62	22.47	-	23.09	-	60.00	50.00	-36.91	-

- REMARKS:**
1. Q.P. and AV. are abbreviations of quasi-peak and average individually.
 2. "-": The Quasi-peak reading value also meets average limit and measurement with the average detector is unnecessary.
 3. The emission levels of other frequencies were very low against the limit.
 4. Margin value = Emission level - Limit value
 5. Correction factor = Insertion loss + Cable loss
 6. Emission Level = Correction Factor + Reading Value.

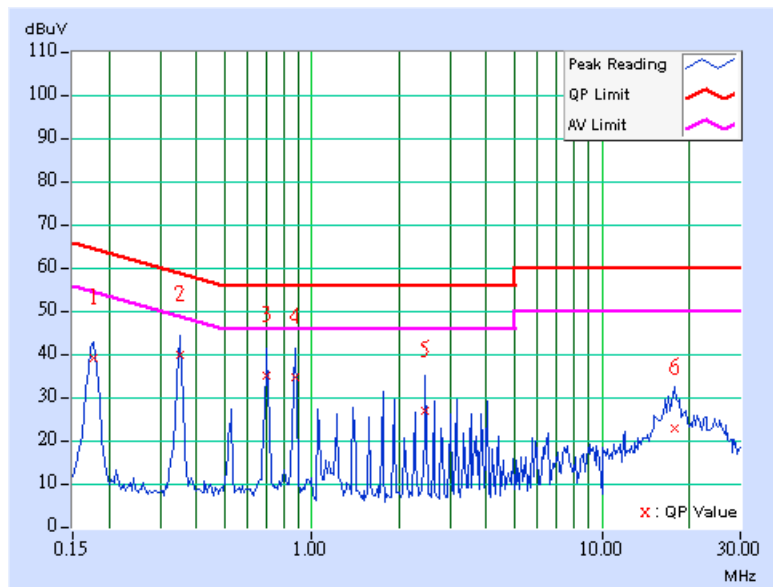



EUT	Bluetooth Stereo Headset	MODEL	BSH203
CHANNEL	Channel 0	6dB BANDWIDTH	9 kHz
MODULATION TYPE	GFSK	PHASE	Line 2
INPUT POWER (SYSTEM)	120 Vac, 60 Hz	ENVIRONMENTAL CONDITIONS	22deg. C, 62%RH, 991hPa
TEST MODE	4	TESTED BY	Morgan Chen

No	Freq. [MHz]	Corr. Factor (dB)	Reading Value		Emission Level		Limit		Margin	
			[dB (uV)]		[dB (uV)]		[dB (uV)]		(dB)	
			Q.P.	AV.	Q.P.	AV.	Q.P.	AV.	Q.P.	AV.
1	0.173	0.10	43.15	-	43.25	-	64.79	54.79	-21.54	-
2	0.349	0.10	42.78	36.29	42.88	36.39	58.98	48.98	-16.10	-12.59
3	0.869	0.18	39.31	31.30	39.49	31.48	56.00	46.00	-16.51	-14.52
4	1.391	0.20	35.37	-	35.57	-	56.00	46.00	-20.43	-
5	1.566	0.20	33.97	-	34.17	-	56.00	46.00	-21.83	-
6	3.137	0.20	31.20	-	31.40	-	56.00	46.00	-24.60	-

- REMARKS:**
1. Q.P. and AV. are abbreviations of quasi-peak and average individually.
 2. "-": The Quasi-peak reading value also meets average limit and measurement with the average detector is unnecessary.
 3. The emission levels of other frequencies were very low against the limit.
 4. Margin value = Emission level - Limit value
 5. Correction factor = Insertion loss + Cable loss
 6. Emission Level = Correction Factor + Reading Value.

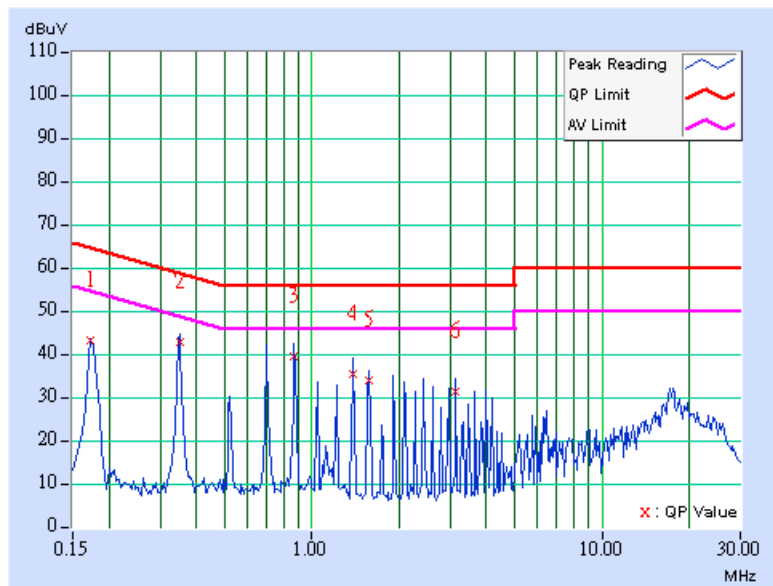



EUT	Bluetooth Stereo Headset	MODEL	BSH203
CHANNEL	Channel 39	6dB BANDWIDTH	9 kHz
MODULATION TYPE	GFSK	PHASE	Line 1
INPUT POWER (SYSTEM)	120 Vac, 60 Hz	ENVIRONMENTAL CONDITIONS	22deg. C, 62%RH, 991hPa
TEST MODE	4	TESTED BY	Morgan Chen

No	Freq. [MHz]	Corr. Factor (dB)	Reading Value [dB (uV)]		Emission Level [dB (uV)]		Limit [dB (uV)]		Margin (dB)	
			Q.P.	AV.	Q.P.	AV.	Q.P.	AV.	Q.P.	AV.
			1	0.177	0.10	39.44	-	39.54	-	64.61
2	0.357	0.10	38.66	-	38.76	-	58.80	48.80	-20.04	-
3	0.705	0.15	34.29	-	34.44	-	56.00	46.00	-21.56	-
4	0.888	0.18	36.73	26.25	36.91	26.43	56.00	46.00	-19.09	-19.57
5	1.418	0.20	30.06	-	30.26	-	56.00	46.00	-25.74	-
6	17.387	0.59	22.85	-	23.44	-	60.00	50.00	-36.56	-

- REMARKS:**
1. Q.P. and AV. are abbreviations of quasi-peak and average individually.
 2. "-": The Quasi-peak reading value also meets average limit and measurement with the average detector is unnecessary.
 3. The emission levels of other frequencies were very low against the limit.
 4. Margin value = Emission level - Limit value
 5. Correction factor = Insertion loss + Cable loss
 6. Emission Level = Correction Factor + Reading Value.

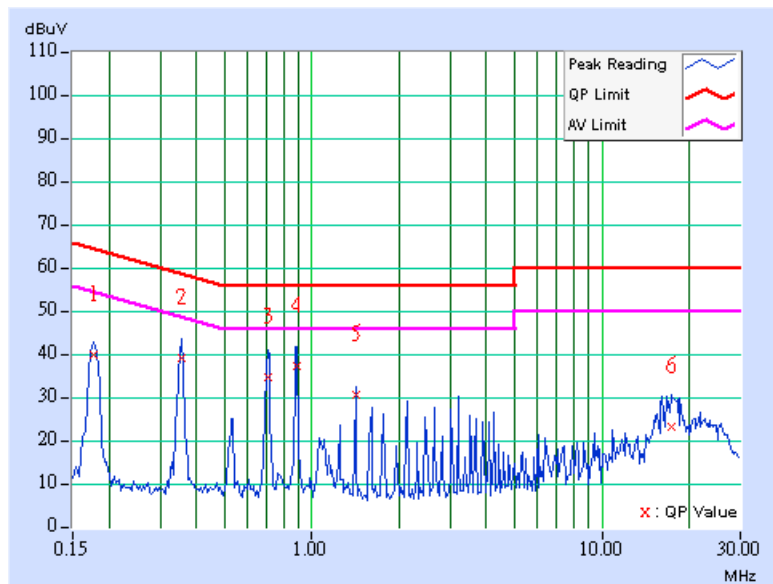



EUT	Bluetooth Stereo Headset	MODEL	BSH203
CHANNEL	Channel 39	6dB BANDWIDTH	9 kHz
MODULATION TYPE	GFSK	PHASE	Line 2
INPUT POWER (SYSTEM)	120 Vac, 60 Hz	ENVIRONMENTAL CONDITIONS	22deg. C, 62%RH, 991hPa
TEST MODE	4	TESTED BY	Morgan Chen

No	Freq. [MHz]	Corr. Factor (dB)	Reading Value		Emission Level		Limit		Margin	
			[dB (uV)]		[dB (uV)]		[dB (uV)]		(dB)	
			Q.P.	AV.	Q.P.	AV.	Q.P.	AV.	Q.P.	AV.
1	0.173	0.10	41.42	-	41.52	-	64.79	54.79	-23.27	-
2	0.349	0.10	42.05	35.43	42.15	35.53	58.98	48.98	-16.83	-13.45
3	0.697	0.15	31.47	-	31.62	-	56.00	46.00	-24.38	-
4	0.877	0.18	39.44	31.89	39.62	32.07	56.00	46.00	-16.38	-13.93
5	1.395	0.20	17.24	-	17.44	-	56.00	46.00	-38.56	-
6	17.145	0.63	23.37	-	24.00	-	60.00	50.00	-36.00	-

- REMARKS:**
1. Q.P. and AV. are abbreviations of quasi-peak and average individually.
 2. "-": The Quasi-peak reading value also meets average limit and measurement with the average detector is unnecessary.
 3. The emission levels of other frequencies were very low against the limit.
 4. Margin value = Emission level - Limit value
 5. Correction factor = Insertion loss + Cable loss
 6. Emission Level = Correction Factor + Reading Value.

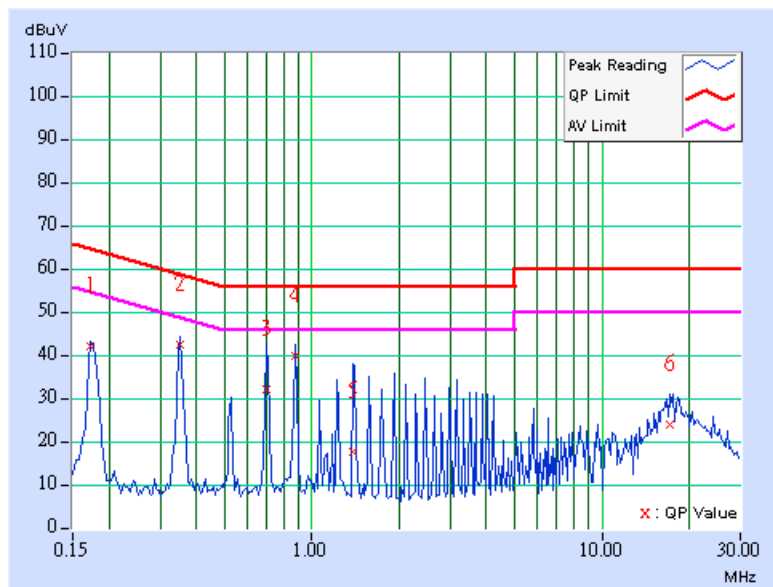



EUT	Bluetooth Stereo Headset	MODEL	BSH203
CHANNEL	Channel 78	6dB BANDWIDTH	9 kHz
MODULATION TYPE	GFSK	PHASE	Line 1
INPUT POWER (SYSTEM)	120 Vac, 60 Hz	ENVIRONMENTAL CONDITIONS	22deg. C, 62%RH, 991hPa
TEST MODE	4	TESTED BY	Morgan Chen

No	Freq. [MHz]	Corr. Factor (dB)	Reading Value [dB (uV)]		Emission Level [dB (uV)]		Limit [dB (uV)]		Margin (dB)	
			Q.P.	AV.	Q.P.	AV.	Q.P.	AV.	Q.P.	AV.
			1	0.177	0.10	39.42	-	39.52	-	64.61
2	0.357	0.10	39.25	30.20	39.35	30.30	58.80	48.80	-19.45	-18.50
3	0.713	0.15	36.29	27.76	36.44	27.91	56.00	46.00	-19.56	-18.09
4	0.884	0.18	34.56	-	34.74	-	56.00	46.00	-21.26	-
5	1.609	0.20	30.37	-	30.57	-	56.00	46.00	-25.43	-
6	17.422	0.59	22.30	-	22.89	-	60.00	50.00	-37.11	-

- REMARKS:**
1. Q.P. and AV. are abbreviations of quasi-peak and average individually.
 2. "-": The Quasi-peak reading value also meets average limit and measurement with the average detector is unnecessary.
 3. The emission levels of other frequencies were very low against the limit.
 4. Margin value = Emission level - Limit value
 5. Correction factor = Insertion loss + Cable loss
 6. Emission Level = Correction Factor + Reading Value.

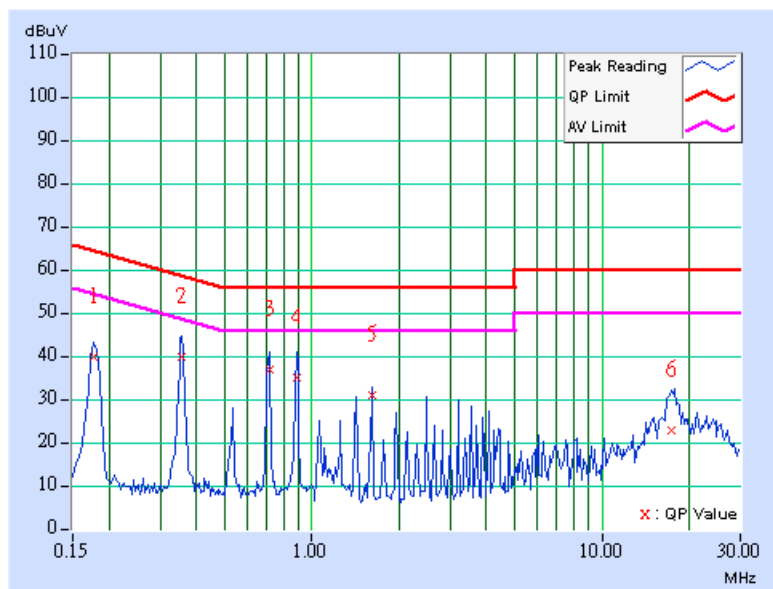



EUT	Bluetooth Stereo Headset	MODEL	BSH203
CHANNEL	Channel 78	6dB BANDWIDTH	9 kHz
MODULATION TYPE	GFSK	PHASE	Line 2
INPUT POWER (SYSTEM)	120 Vac, 60 Hz	ENVIRONMENTAL CONDITIONS	22deg. C, 62%RH, 991hPa
TEST MODE	4	TESTED BY	Morgan Chen

No	Freq. [MHz]	Corr. Factor (dB)	Reading Value		Emission Level		Limit		Margin	
			[dB (uV)]		[dB (uV)]		[dB (uV)]		(dB)	
			Q.P.	AV.	Q.P.	AV.	Q.P.	AV.	Q.P.	AV.
1	0.193	0.10	44.82	38.46	44.92	38.56	63.91	53.91	-18.99	-15.35
2	0.384	0.10	43.74	37.32	43.84	37.42	58.18	48.18	-14.34	-10.76
3	0.767	0.16	39.98	33.47	40.14	33.63	56.00	46.00	-15.86	-12.37
4	0.959	0.19	39.63	32.82	39.82	33.01	56.00	46.00	-16.18	-12.99
5	2.109	0.20	37.48	29.84	37.68	30.04	56.00	46.00	-18.32	-15.96
6	17.855	0.67	25.00	-	25.67	-	60.00	50.00	-34.33	-

- REMARKS:**
1. Q.P. and AV. are abbreviations of quasi-peak and average individually.
 2. "-": The Quasi-peak reading value also meets average limit and measurement with the average detector is unnecessary.
 3. The emission levels of other frequencies were very low against the limit.
 4. Margin value = Emission level - Limit value
 5. Correction factor = Insertion loss + Cable loss
 6. Emission Level = Correction Factor + Reading Value.

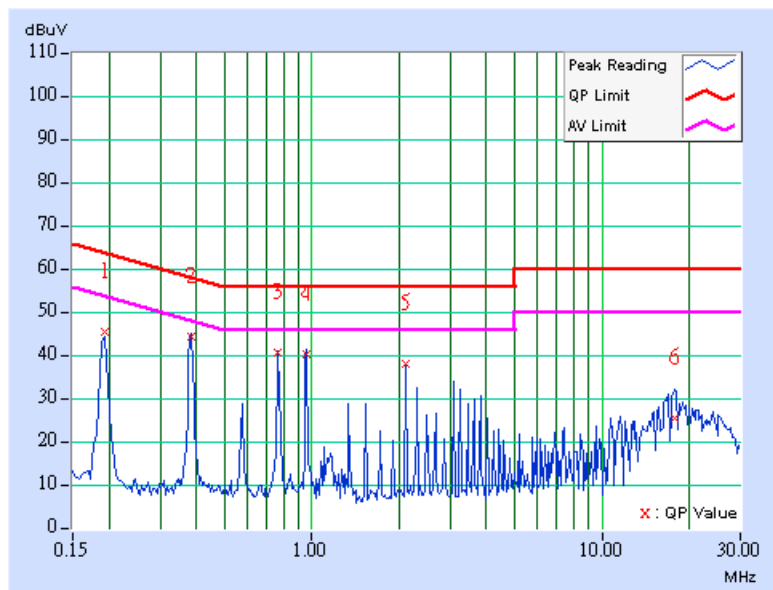

4.2 NUMBER OF HOPPING FREQUENCY USED

4.2.1 LIMIT OF HOPPING FREQUENCY USED

At least 15 channels frequencies, and should be equally spaced.

4.2.2 TEST INSTRUMENTS

Description & Manufacturer	Model No.	Serial No.	Calibrated Until
SPECTRUM ANALYZER	FSEK30	100049	Aug. 12, 2005

NOTE:

The calibration interval of the above test instruments is 12 months. And the calibrations are traceable to NML/ROC and NIST/USA.

4.2.3 TEST PROCEDURES

1. Check the calibration of the measuring instrument (SA) using either an internal calibrator or a known signal from an external generator.
2. Turn on the EUT and connect its antenna terminal to measurement via a low loss cable. Then set it to any one measured frequency within its operating range and make sure the instrument is operated in its linear range.
3. Set the SA on MaxHold Mode, and then keep the EUT in hopping mode. Record all the signals from each channel until each one has been recorded.
4. Set the SA on View mode and then plot the result on SA screen.
5. Repeat above procedures until all frequencies measured were complete.

4.2.4 DEVIATION FROM TEST STANDARD

No deviation.

4.2.5 TEST SETUP



4.2.6 TEST RESULTS

There are 79 hopping frequencies in the hopping mode. Please refer to next two pages for the test result. On the plots, it shows that the hopping frequencies are equally spaced.

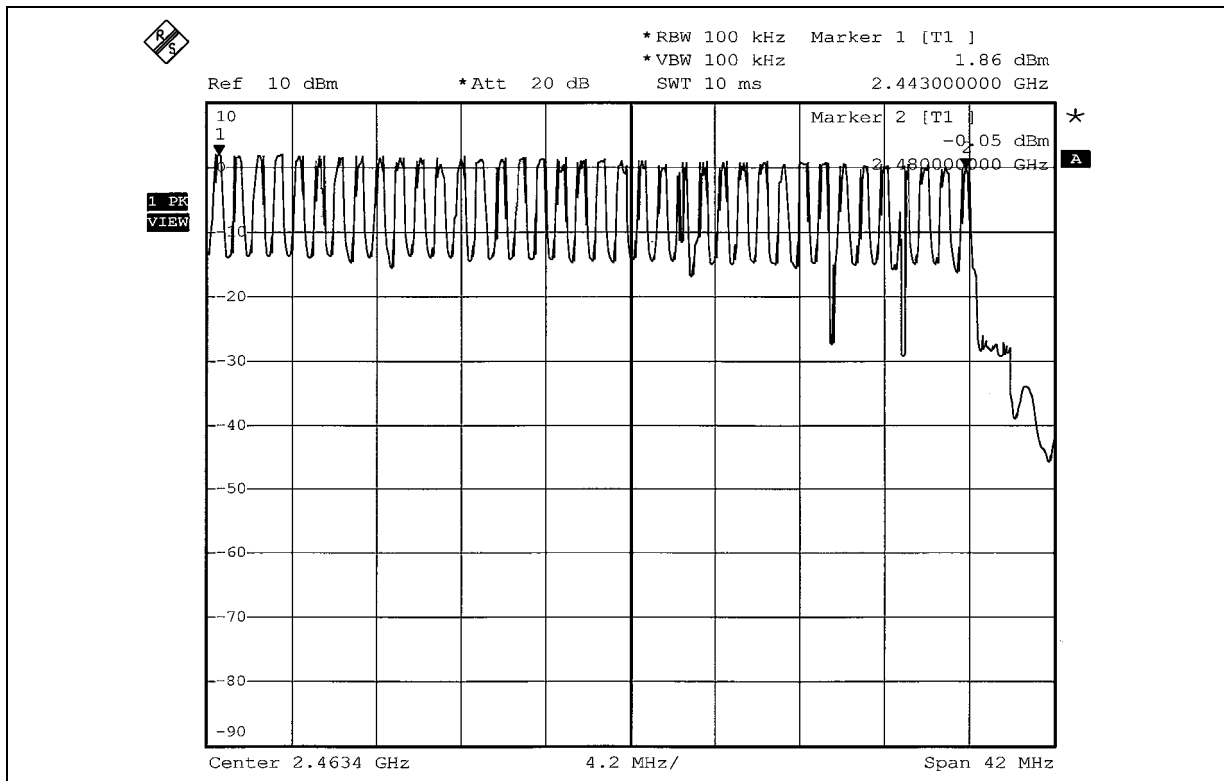
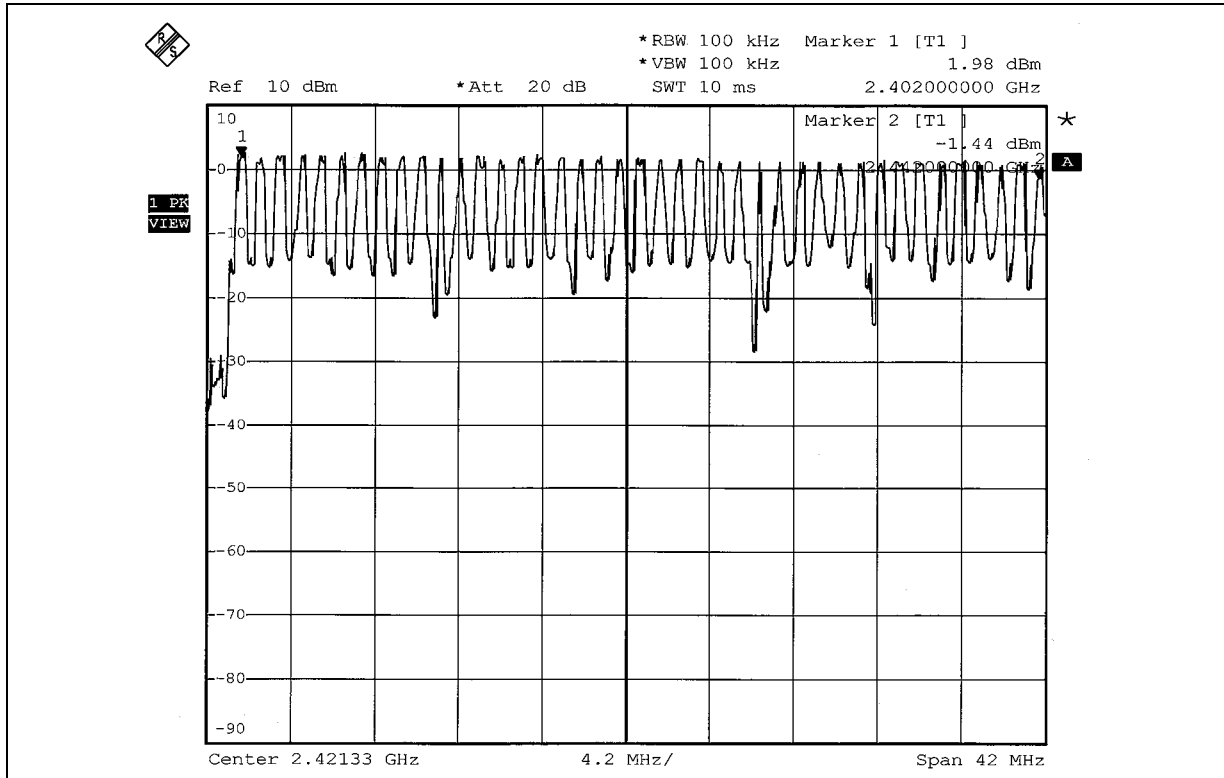

4.3 DWELL TIME ON EACH CHANNEL

4.3.1 LIMIT OF DWELL TIME USED

The average time of occupancy on any channel shall not be greater than 0.4 seconds within a period of 0.4 seconds multiplied by the number of hopping channels employed.

4.3.2 TEST INSTRUMENTS

Description & Manufacturer	Model No.	Serial No.	Calibrated Until
SPECTRUM ANALYZER	FSEK30	100049	Aug. 12, 2005

NOTES:

The calibration interval of the above test instruments is 12 months. And the calibrations are traceable to NML/ROC and NIST/USA.

4.3.3 TEST PROCEDURES

1. Check the calibration of the measuring instrument (SA) using either an internal calibrator or a known signal from an external generator.
2. Turn on the EUT and connect its antenna terminal to measurement via a low loss cable. Then set it to any one measured frequency within its operating range and make sure the instrument is operated in its linear range.
3. Adjust the center frequency of SA on any frequency be measured and set SA to zero span mode. And then, set RBW and VBW of spectrum analyzer to proper value.
4. Measure the time duration of one transmission on the measured frequency. And then plot the result with time difference of this time duration.
5. Repeat above procedures until different time-slot have been completed.

4.3.4 DEVIATION FROM TEST STANDARD

No deviation.

4.3.5 TEST SETUP



4.3.6 TEST RESULTS

Mode	Number of transmission in a 31.6 (79Hopping*0.4)	Length of transmission time (msec)	Result (msec)	Limit (msec)
DH1	49 (times / 5 sec) *6.32=309.68times	0.48	148.64	400
DH3	24 (times / 5 sec) *6.32= 151.68times	1.74	263.92	400
DH5	15 (times / 5 sec) *6.32= 94.80times	2.96	280.61	400

Test plots of the transmitting time slot are shown on next 3 pages.



DH1

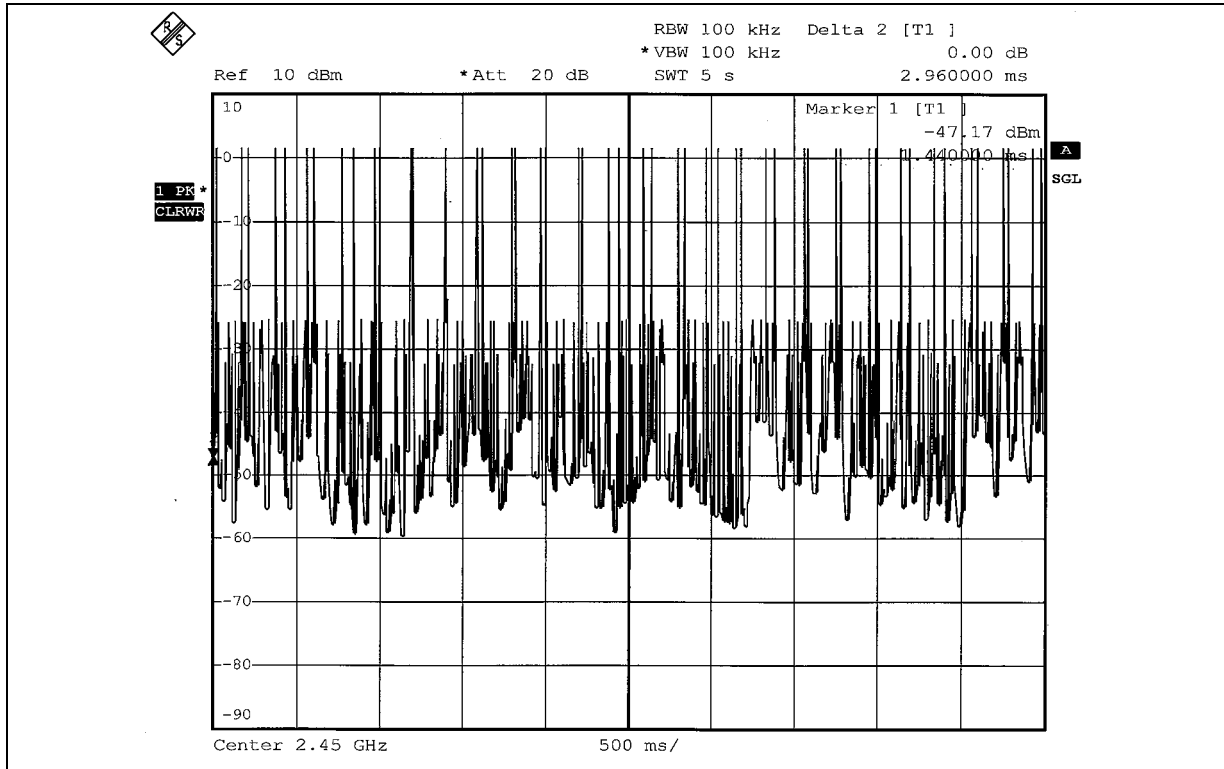

DH1

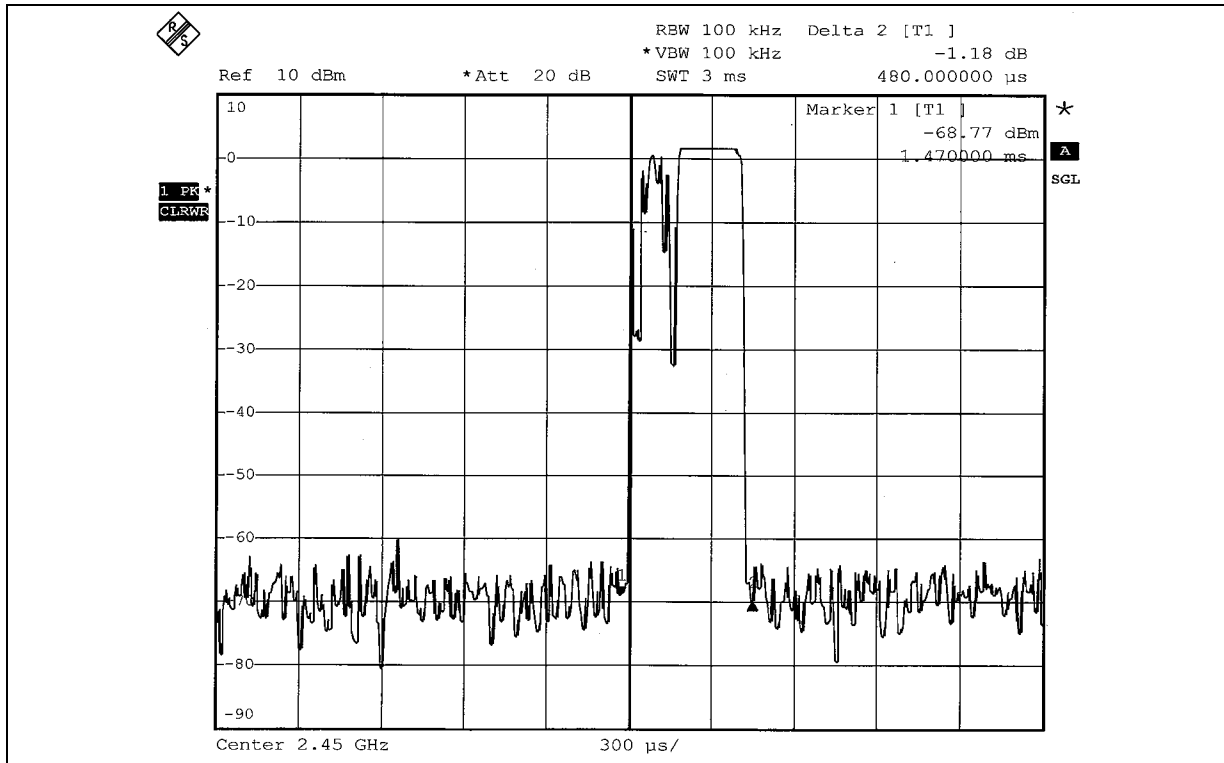



DH3

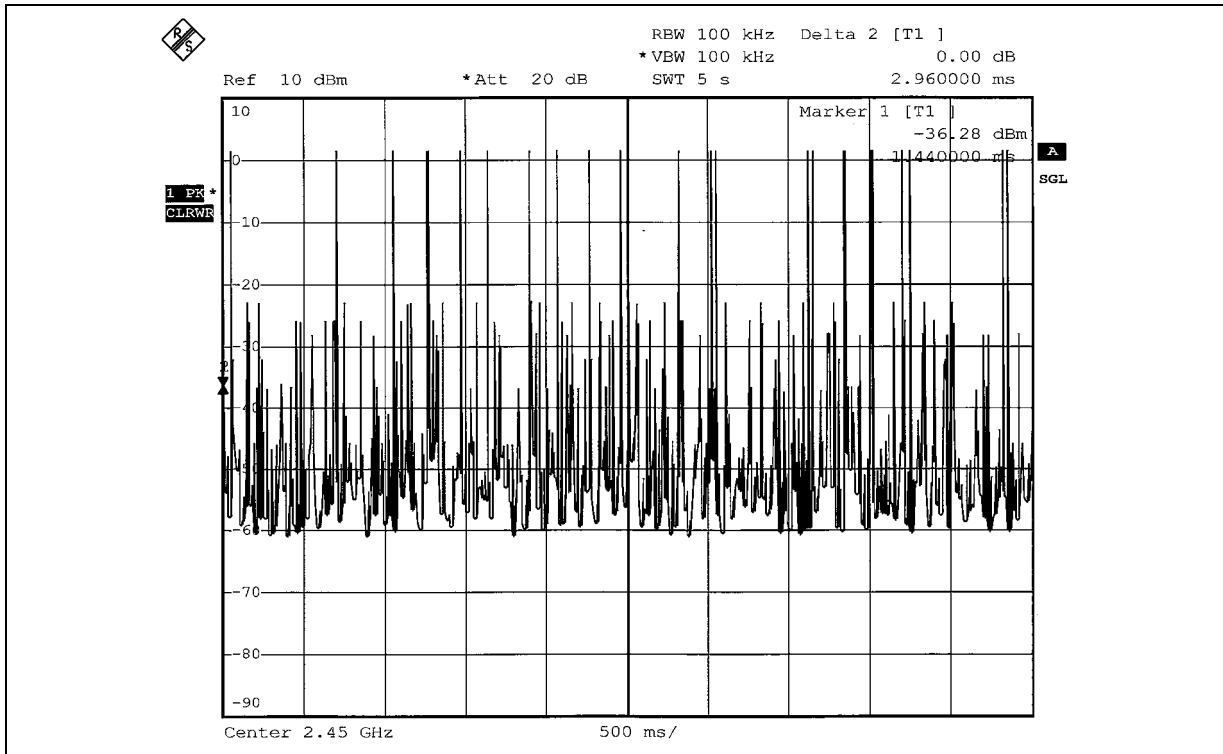

DH3

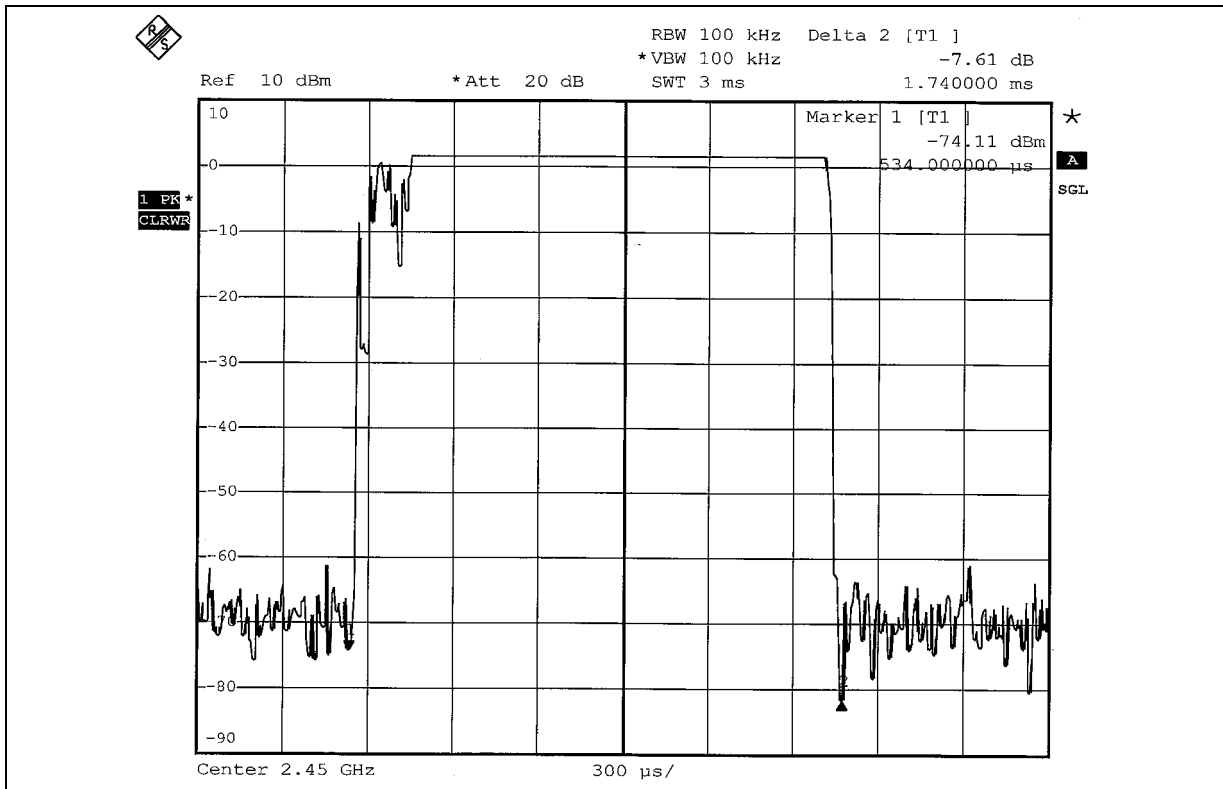



DH5

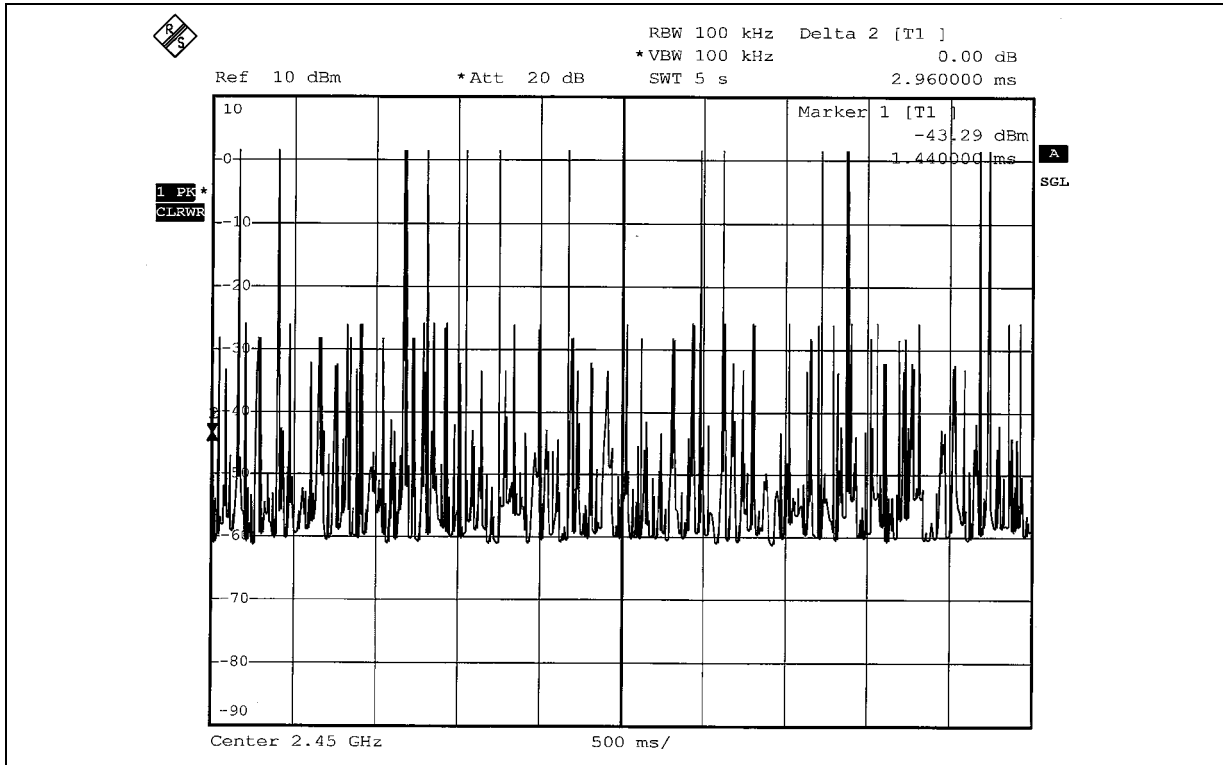

DH5

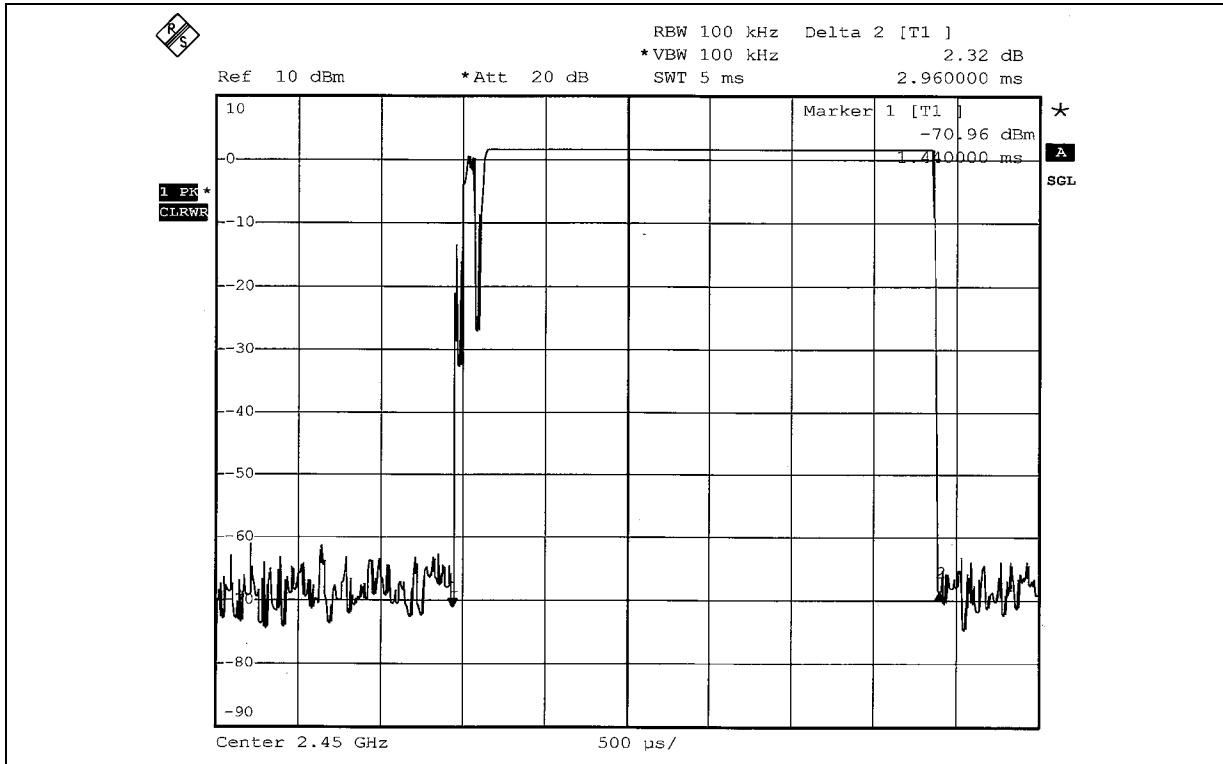

4.4 CHANNEL BANDWIDTH

4.4.1 LIMITS OF CHANNEL BANDWIDTH

For frequency hopping system operating in the 2400-2483.5MHz, If the 20dB bandwidth of hopping channel is greater than 25kHz, the 20dB bandwidth of hopping channel shall be a minimum limit for the hopping channel separation.

4.4.2 TEST INSTRUMENTS

Description & Manufacturer	Model No.	Serial No.	Calibrated Until
SPECTRUM ANALYZER	FSEK30	100049	Aug. 12, 2005

NOTE:

The calibration interval of the above test instruments is 12 months. And the calibrations are traceable to NML/ROC and NIST/USA.

4.4.3 TEST PROCEDURE

1. Check the calibration of the measuring instrument using either an internal calibrator or a known signal from an external generator.
2. Turn on the EUT and connect it to measurement instrument. Then set it to any one convenient frequency within its operating range. Set a reference level on the measuring instrument equal to the highest peak value.
3. Measure the frequency difference of two frequencies that were attenuated 20dB from the reference level. Record the frequency difference as the emission bandwidth.
4. Repeat above procedures until all frequencies measured were complete.

4.4.4 DEVIATION FROM TEST STANDARD

No deviation.

4.4.5 TEST SETUP

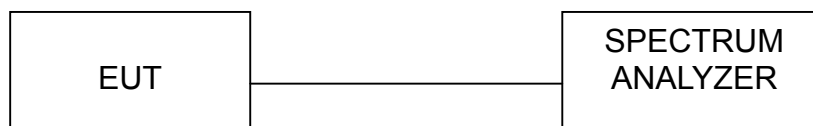

4.4.6 EUT OPERATING CONDITION

The software provided by client enabled the EUT to transmit and receive data at lowest, middle and highest channel frequencies individually.

4.4.7 TEST RESULTS

EUT	Bluetooth Stereo Headset	MODEL	BSH203
MODULATION TYPE	GFSK	ENVIRONMENTAL CONDITIONS	23deg. C, 54%RH, 991hPa
INPUT POWER (SYSTEM)	120Vac, 60 Hz	TESTED BY	Long Chen

CHANNEL	CHANNEL FREQUENCY (MHz)	20dB BANDWIDTH (MHz)
0	2402	0.963
39	2441	0.969
78	2480	0.963



Channel 0

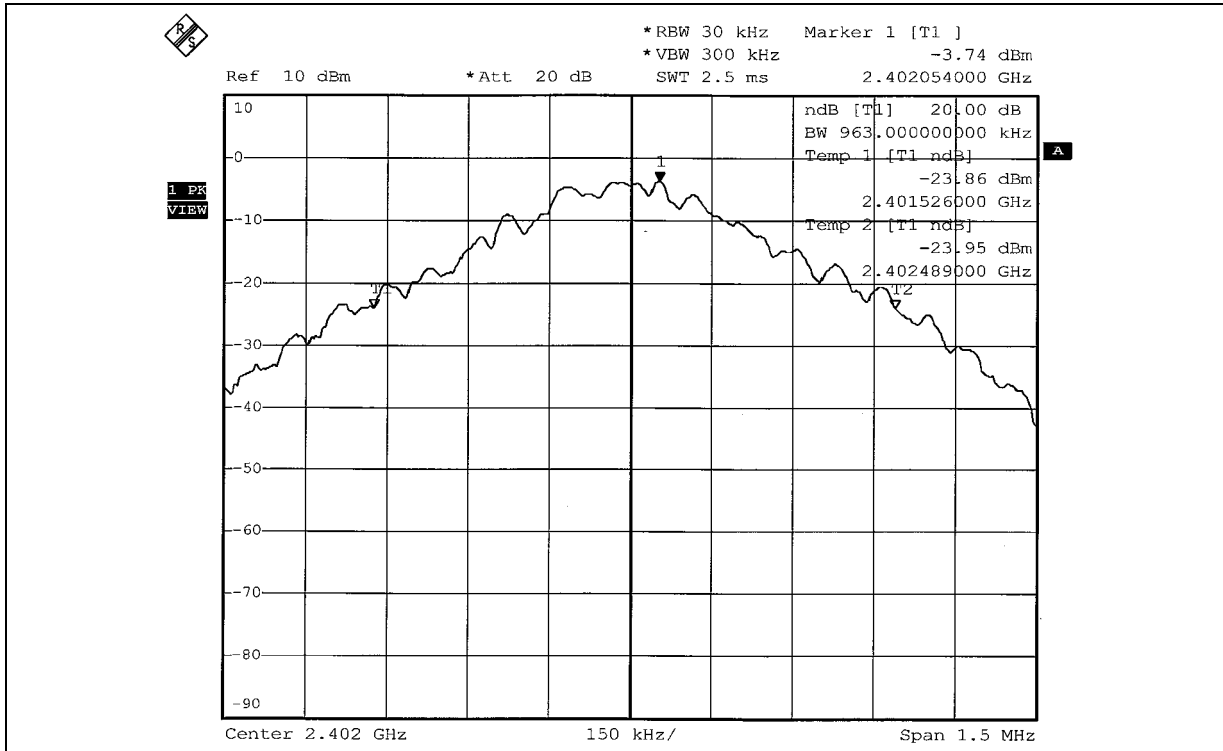

Channel 39

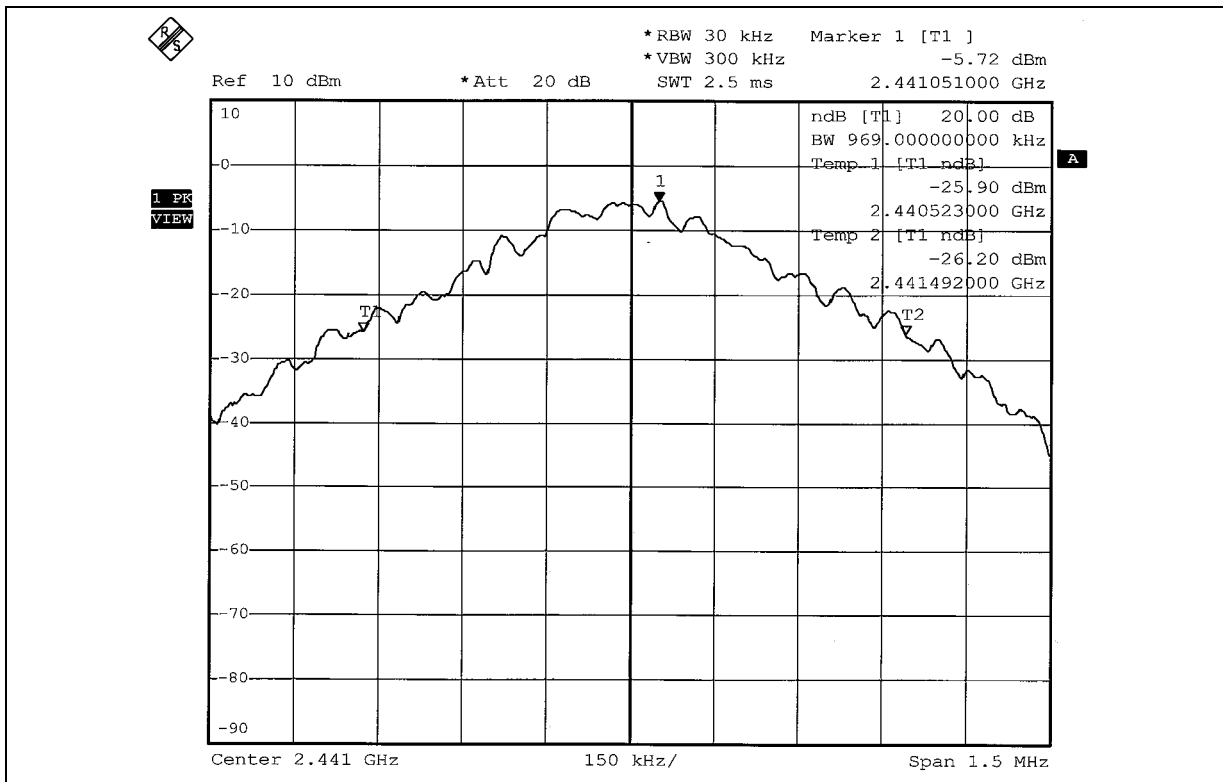



Channel 78

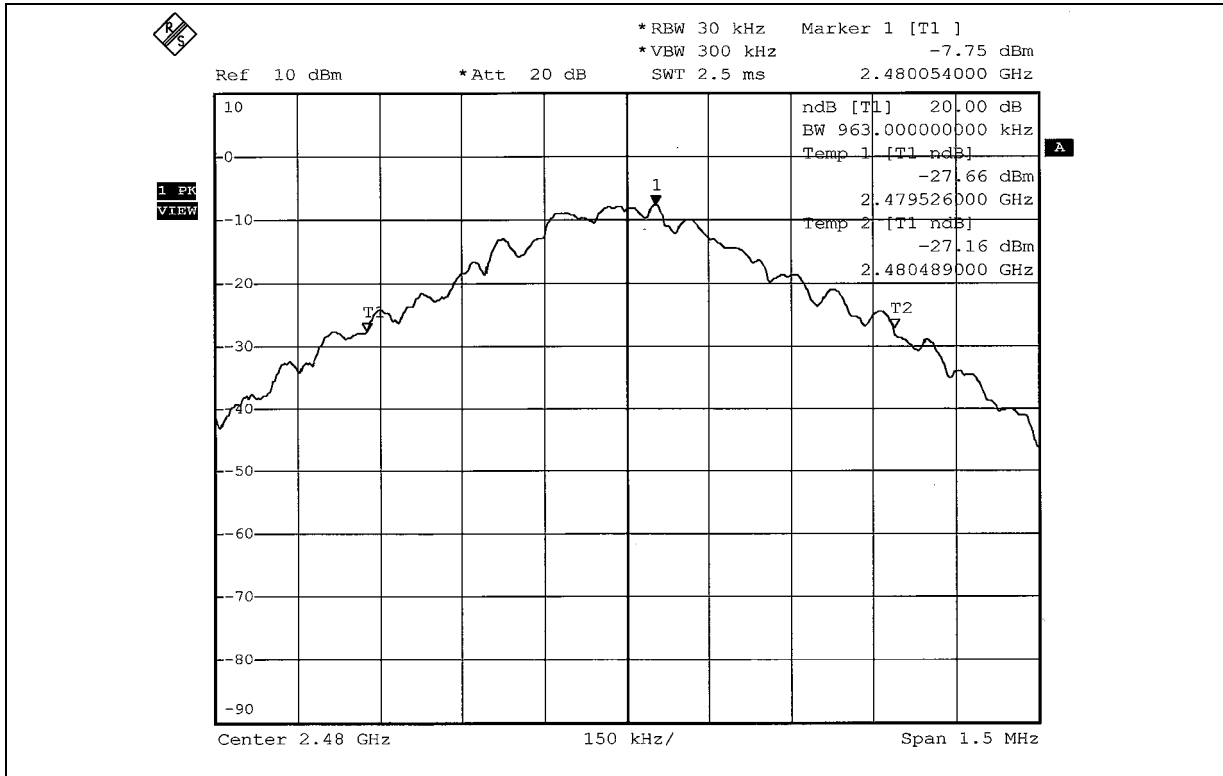

4.5 HOPPING CHANNEL SEPARATION

4.5.1 LIMIT OF HOPPING CHANNEL SEPARATION

At least 25kHz or two-thirds of 20dB bandwidth (whichever is greater).

4.5.2 TEST INSTRUMENTS

Description & Manufacturer	Model No.	Serial No.	Calibrated Until
SPECTRUM ANALYZER	FSEK30	100049	Aug. 12, 2005

NOTES:

The calibration interval of the above test instruments is 12 months. And the calibrations are traceable to NML/ROC and NIST/USA.

4.5.3 TEST PROCEDURES

1. Check the calibration of the measuring instrument using either an internal calibrator or a known signal from an external generator.
2. Turn on the EUT and connect it to measurement instrument. Then set it to any one convenient frequency within its operating range.
3. By using the MaxHold function record the separation of two adjacent channels.
4. Measure the frequency difference of these two adjacent channels by SA MARK function. And then plot the result on SA screen.
5. Repeat above procedures until all frequencies measured were complete.

4.5.4 DEVIATION FROM TEST STANDARD

No deviation

4.5.5 TEST SETUP

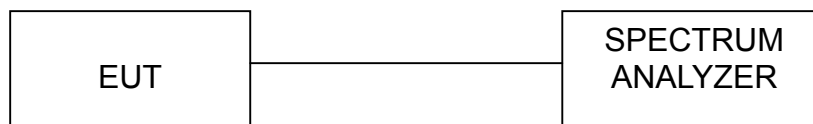

4.5.6 TEST RESULTS

EUT	Bluetooth Stereo Headset	MODEL	BSH203
MODULATION TYPE	GFSK	ENVIRONMENTAL CONDITIONS	23 deg. C, 54% RH, 991 hPa
INPUT POWER (SYSTEM)	120Vac, 60 Hz	TESTED BY	Gary Chang

Channel	Frequency (MHz)	Adjacent Channel Separation (MHz)	Minimum Limit (MHz)	Pass / Fail
0	2402	1.010	0.642	PASS
39	2441	1.000	0.646	PASS
78	2480	1.015	0.642	PASS

The minimum limit is two-thirds of 20dB bandwidth. Test results please refer to next two pages.



Channel 0

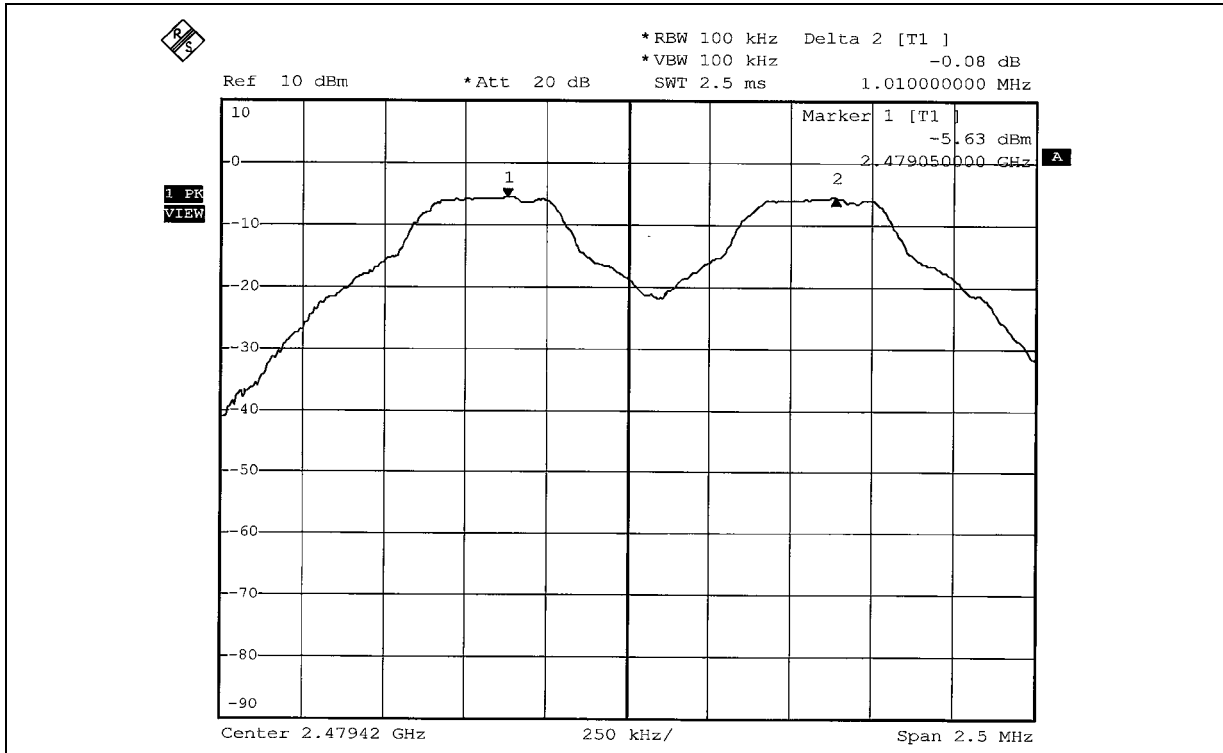

Channel 39

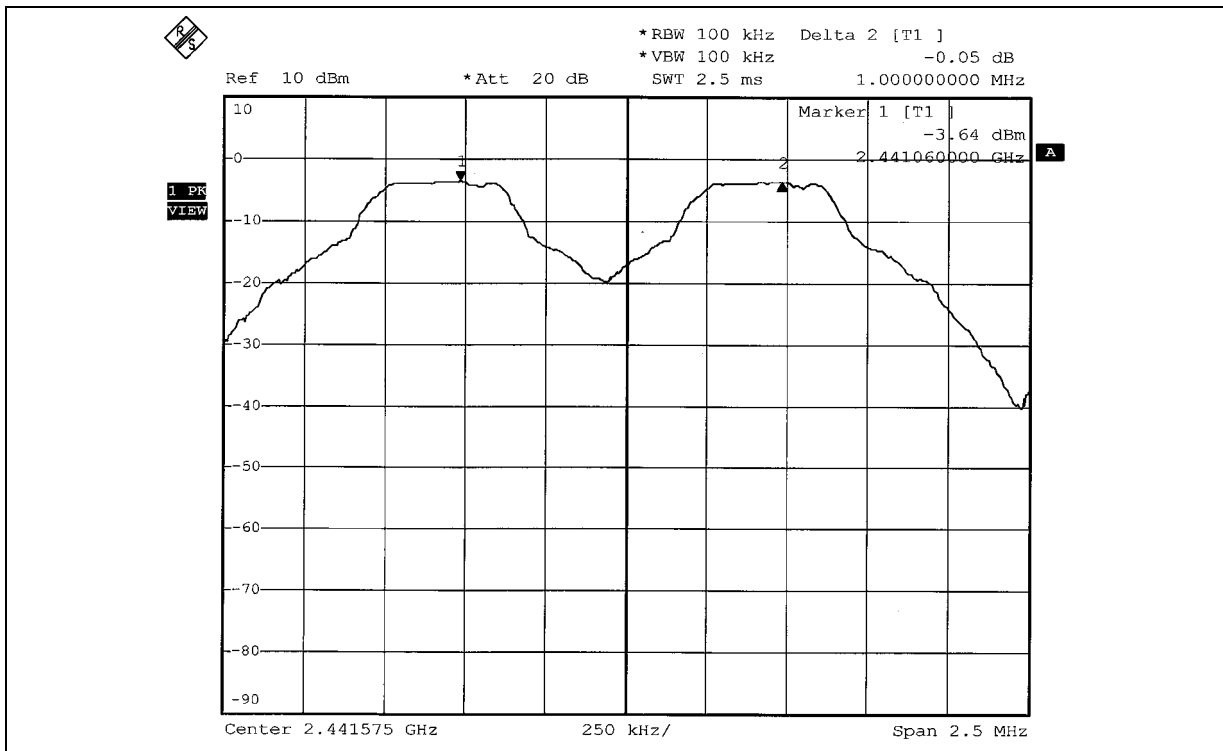



Channel 78

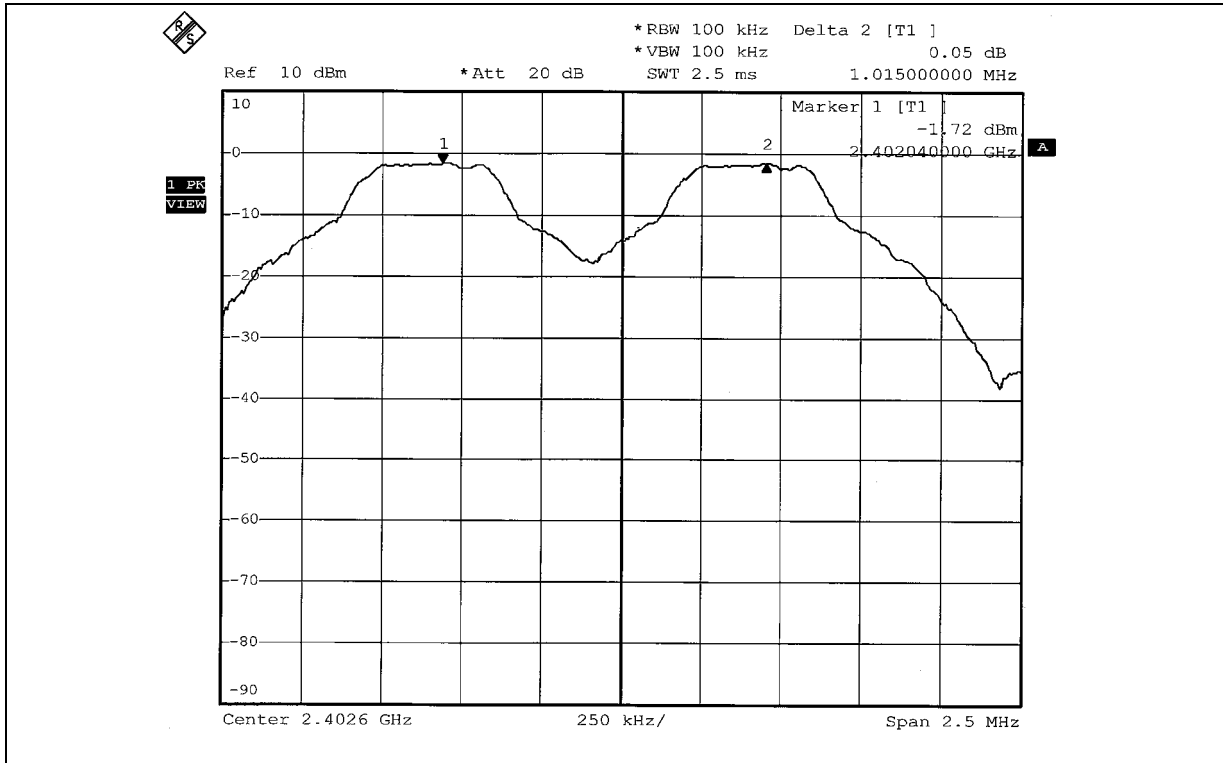

4.6 MAXIMUM PEAK OUTPUT POWER

4.6.1 LIMITS OF MAXIMUM PEAK OUTPUT POWER MEASUREMENT

The Maximum Peak Output Power Measurement is 30dBm.

4.6.2 INSTRUMENTS

Description & Manufacturer	Model No.	Serial No.	Calibrated Until
SPECTRUM ANALYZER	FSEK30	100049	Aug. 12, 2005

NOTE: The calibration interval of the above test instruments is 12 months and the calibrations are traceable to NML/ROC and NIST/USA.

4.6.3 TEST PROCEDURES

1. Check the calibration of the measuring instrument using either an internal calibrator or a known signal from an external generator.
2. Turn on the EUT and connect it to measurement instrument. Then set it to any one convenient frequency within its operating range. Set a reference level on the measuring instrument equal to the highest peak value.
3. The center frequency of the spectrum analyzer is set to the fundamental frequency and using 1 MHz RBW and 3 MHz VBW.
4. Measure the captured power with in the band and recording the plot.
5. Repeat above procedures until all frequencies measured were complete.

4.6.4 DEVIATION FROM TEST STANDARD

No deviation

4.6.5 TEST SETUP

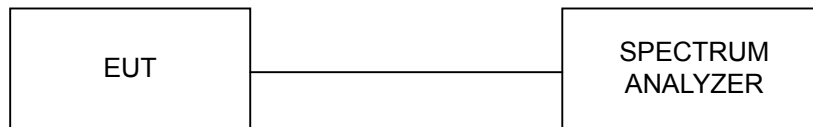

For the actual test configuration, please refer to the related Item – Photographs of the Test Configuration.

4.6.6 EUT OPERATING CONDITION

The software provided by client enabled the EUT to transmit and receive data at lowest, middle and highest channel frequencies individually.

4.6.7 TEST RESULTS

EUT	Bluetooth Stereo Headset	MODEL	BSH203
MODULATION TYPE	GFSK	ENVIRONMENTAL CONDITIONS	23deg. C, 54%RH, 991 hPa
INPUT POWER (SYSTEM)	120Vac, 60 Hz	TESTED BY	Gary Chang

CHANNEL	CHANNEL FREQUENCY (MHz)	PEAK POWER OUTPUT (mW)	PEAK POWER OUTPUT (dBm)	PEAK POWER LIMIT (dBm)	PASS/FAIL
0	2402	0.834	-0.79	30	PASS
39	2441	0.532	-2.74	30	PASS
78	2480	0.328	-4.84	30	PASS

Channel 0

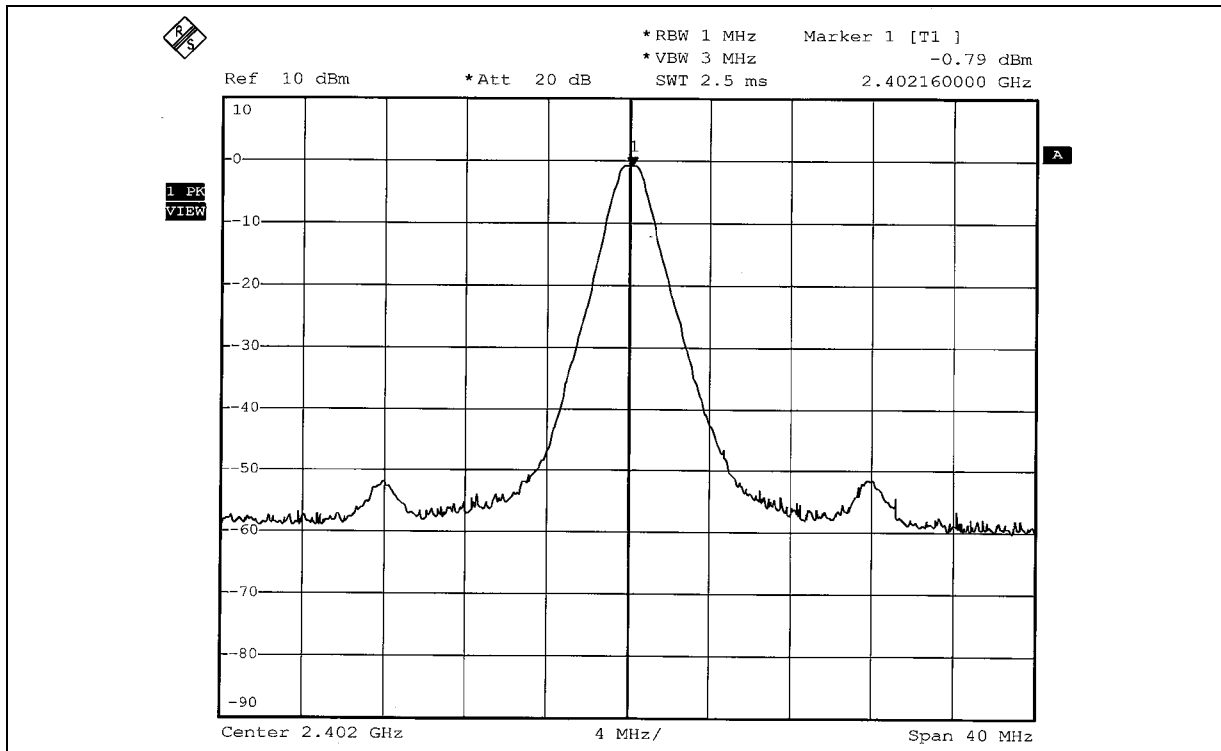

Channel 39

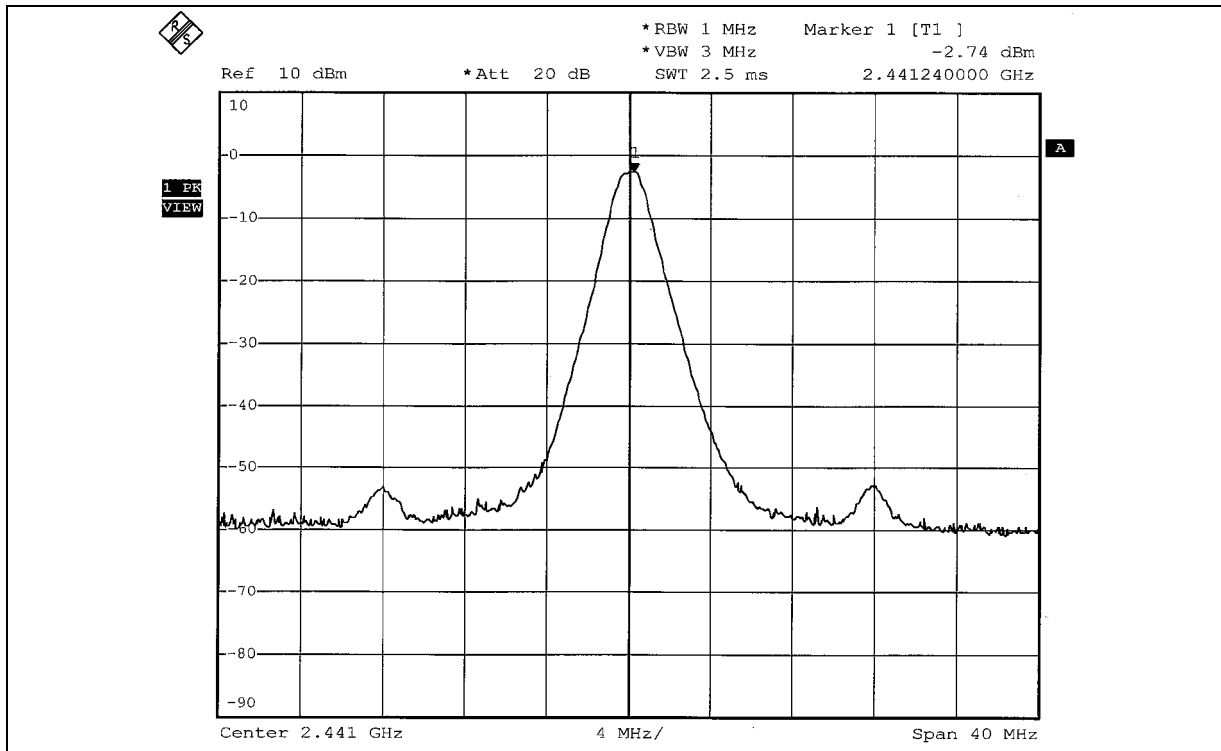



Channel 78

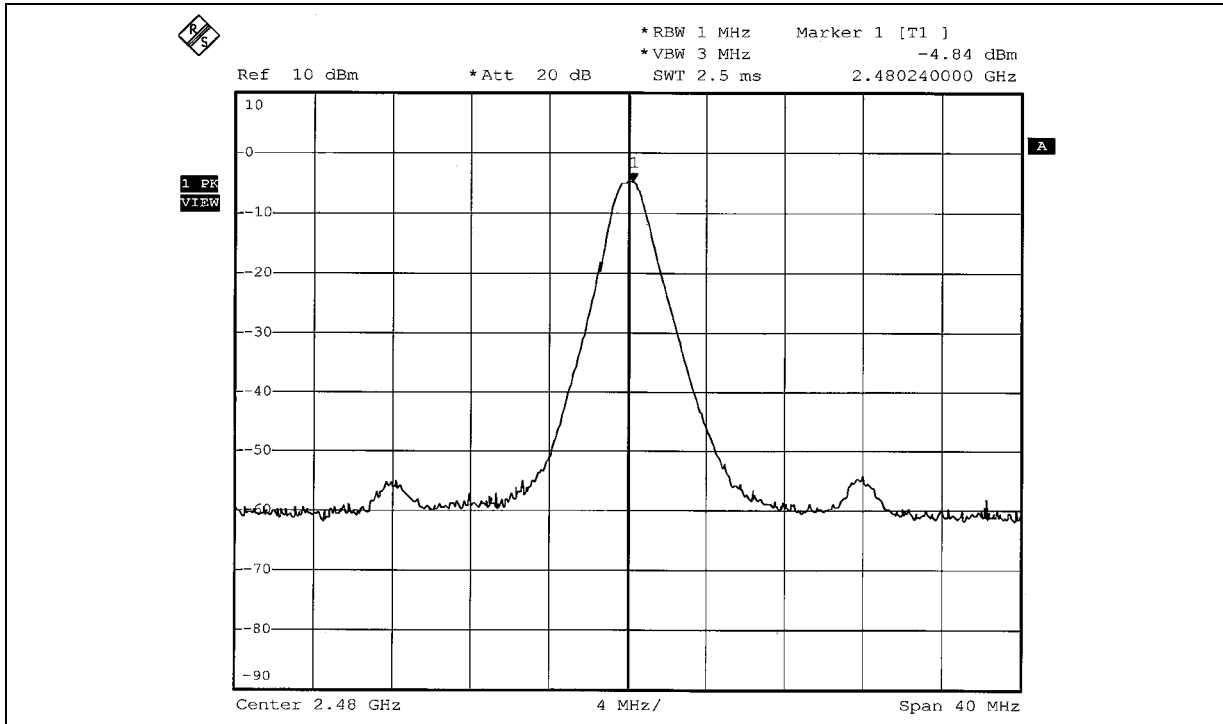

4.7 RADIATED EMISSION MEASUREMENT

4.7.1 LIMITS OF RADIATED EMISSION MEASUREMENT

Emissions radiated outside of the specified bands, shall be according to the general radiated limits in 15.209 as following:

Frequencies (MHz)	Field strength (microvolts/meter)	Measurement distance (meters)
0.009-0.490	2400/F(kHz)	300
0.490-1.705	24000/F(kHz)	30
1.705-30.0	30	30
30-88	100	3
88-216	150	3
216-960	200	3
Above 960	500	3

NOTE: The limit for radiated test was performed according to CISPR 22: 1997, which was specified in FCC PART 15B 15.109(g). Also the limits of ICES-003: 2004 and CISPR 22: 1997 are same.

4.7.2 TEST INSTRUMENTS

DESCRIPTION & MANUFACTURER	MODEL NO.	SERIAL NO.	CALIBRATED UNTIL
Test Receiver ROHDE & SCHWARZ	ESI7	838496/016	Jan. 07, 2006
Spectrum Analyzer ROHDE & SCHWARZ	FSP40	100041	Nov. 29, 2005
BILOG Antenna SCHWARZBECK	VULB9168	9168-155	Jan. 22, 2006
HORN Antenna SCHWARZBECK	BBHA 9120D	9120D-404	Jan. 05, 2006
HORN Antenna SCHWARZBECK	BBHA 9170	BBHA 9170242	Jan. 23, 2006
Preamplifier Agilent	8447D	2944A10631	Nov. 17, 2005
Preamplifier Agilent	8449B	3008A01960	Nov. 14, 2005
RF signal cable HUBER+SUHNNER	SUCOFLEX 104	219272/4	Jan. 26, 2006
RF signal cable HUBER+SUHNNER	SUCOFLEX 104	219275/4	Jan. 26, 2006
Software ADT.	ADT_Radiated_V5.14	NA	NA
Antenna Tower inn-co GmbH	MA 4000	010303	NA
Antenna Tower Controller inn-co GmbH	CO2000	019303	NA
Turn Table ADT.	TT100.	TT93021704	NA
Turn Table Controller ADT.	SC100.	SC93021704	NA

- NOTE:**
1. The calibration interval of the above test instruments is 12 months and the calibrations are traceable to NML/ROC and NIST/USA.
 2. The test was performed in HwaYa Chamber 3.
 3. The horn antenna and HP preamplifier (model: 8449B) are used only for the measurement of emission frequency above 1GHz if tested.
 4. The IC Site Registration No. is IC4924-4.

4.7.3 TEST PROCEDURES

- a. The EUT was placed on the top of a rotating table 0.8 meters above the ground at a 3 meters semi-anechoic chamber. The table was rotated 360 degrees to determine the position of the highest radiation.
- b. The EUT was set 3 meters away from the interference-receiving antenna, which was mounted on the top of a variable-height antenna tower.
- c. The antenna is a broadband antenna, and its height is varied from one meter to four meters above the ground to determine the maximum value of the field strength. Both horizontal and vertical polarizations of the antenna are set to make the measurement.
- d. For each suspected emission, the EUT was arranged to its worst case and then the antenna was tuned to heights from 1 meter to 4 meters and the rotatable table was turned from 0 degrees to 360 degrees to find the maximum reading.
- e. The test-receiver system was set to Peak Detect Function and Specified Bandwidth with Maximum Hold Mode.
- f. If the emission level of the EUT in peak mode was lower than the limit specified, then testing could be stopped and the peak values of the EUT would be reported. Otherwise the emissions would be re-tested one by one using peak, quasi-peak or average method as specified and then reported in a data sheet.

NOTE:

1. The resolution bandwidth and video bandwidth of test receiver/spectrum analyzer is 120kHz for Peak detection (PK) and Quasi-peak detection (QP) at frequency below 1GHz.
2. The resolution bandwidth and video bandwidth of test receiver/spectrum analyzer is 1 MHz for Peak detection at frequency above 1GHz.

4.7.4 DEVIATION FROM TEST STANDARD

No deviation.

4.7.5 TEST SETUP

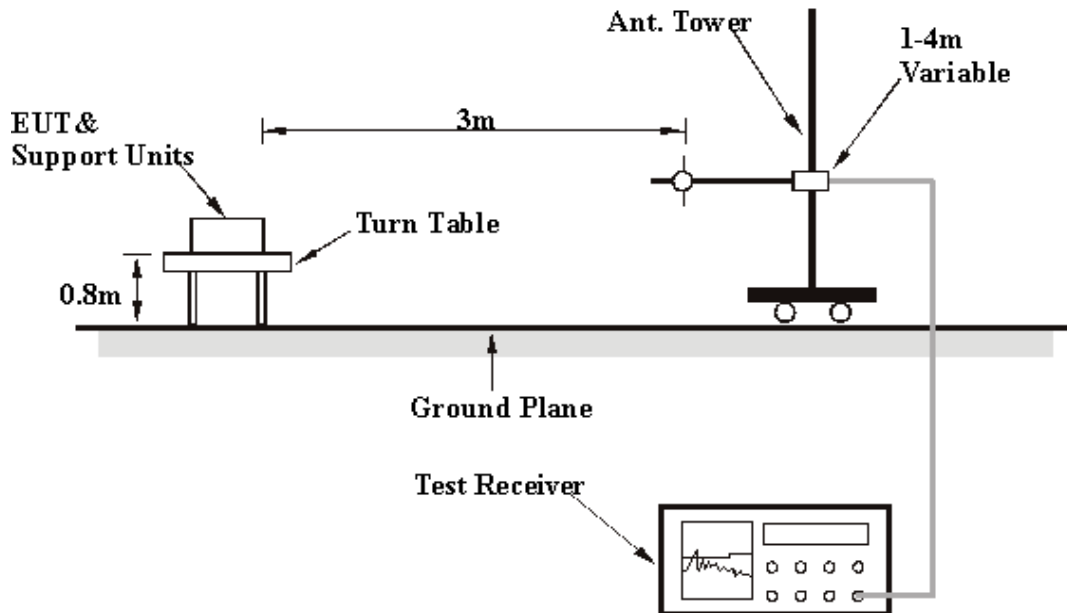

For the actual test configuration, please refer to the related item – Photographs of the Test Configuration.

4.7.6 EUT OPERATING CONDITIONS

Same as 4.1.6.

4.7.7 TEST RESULTS

Below 1GHz Worst-Case Data (For Battery Mode and EUT use Chip Antenna)

EUT	Bluetooth Stereo Headset	MODEL	BSH203
CHANNEL	Channel 78	FREQUENCY RANGE	Below 1 GHz
MODULATION TYPE	GFSK	DETECTOR FUNCTION	Quasi-Peak
INPUT POWER (SYSTEM)	120 Vac, 60 Hz	ENVIRONMENTAL CONDITIONS	23 deg. C, 64% RH, 991 hPa
TEST MODE	1	TESTED BY	Morgan Chen

ANTENNA POLARITY & TEST DISTANCE: HORIZONTAL AT 3 M

No.	Freq. (MHz)	Emission Level (dBuV/m)	Limit (dBuV/m)	Margin (dB)	Antenna Height (m)	Table Angle (Degree)	Raw Value (dBuV)	Correction Factor (dB/m)
1	113.59	27.06 QP	43.50	-16.44	1.00 H	94	14.83	12.23
2	206.89	28.66 QP	43.50	-14.84	1.00 H	106	17.24	11.42
3	292.42	30.98 QP	46.00	-15.02	1.00 H	55	16.69	14.29
4	399.34	38.91 QP	46.00	-7.09	1.00 H	187	22.19	16.71
5	634.55	30.87 QP	46.00	-15.13	1.00 H	82	9.60	21.27
6	667.60	32.25 QP	46.00	-13.75	1.00 H	103	10.59	21.66

ANTENNA POLARITY & TEST DISTANCE: VERTICAL AT 3 M

No.	Freq. (MHz)	Emission Level (dBuV/m)	Limit (dBuV/m)	Margin (dB)	Antenna Height (m)	Table Angle (Degree)	Raw Value (dBuV)	Correction Factor (dB/m)
1	115.53	29.75 QP	43.50	-13.75	1.00 V	46	17.33	12.42
2	166.07	28.79 QP	43.50	-14.71	1.50 V	133	14.47	14.32
3	399.34	30.99 QP	46.00	-15.01	1.00 V	172	14.27	16.71
4	533.47	26.51 QP	46.00	-19.49	1.00 V	142	7.35	19.17
5	665.65	34.84 QP	46.00	-11.16	1.00 V	241	13.20	21.64
6	999.00	34.17 QP	54.00	-19.83	1.25 V	61	8.68	25.49

- REMARKS:**
1. Emission level(dBuV/m)=Raw Value(dBuV) + Correction Factor(dB/m)
 2. Correction Factor(dB/m) = Antenna Factor (dB/m) + Cable Factor (dB)
 3. The other emission levels were very low against the limit.
 4. Margin value = Emission level – Limit value.

Below 1GHz Worst-Case Data (For Battery Mode and EUT use PIFA Antenna)

EUT	Bluetooth Stereo Headset	MODEL	BSH203
CHANNEL	Channel 78	FREQUENCY RANGE	Below 1 GHz
MODULATION TYPE	GFSK	DETECTOR FUNCTION	Quasi-Peak
INPUT POWER (SYSTEM)	120 Vac, 60 Hz	ENVIRONMENTAL CONDITIONS	23 deg. C, 64% RH, 991 hPa
TEST MODE	2	TESTED BY	Morgan Chen

ANTENNA POLARITY & TEST DISTANCE: HORIZONTAL AT 3 M

No.	Freq. (MHz)	Emission Level (dBuV/m)	Limit (dBuV/m)	Margin (dB)	Antenna Height (m)	Table Angle (Degree)	Raw Value (dBuV)	Correction Factor (dB/m)
1	207.83	35.80 QP	43.50	-7.70	1.25 H	292	24.35	11.45
2	673.43	26.96 QP	46.00	-19.04	1.25 H	148	5.24	21.72
3	774.74	26.81 QP	46.00	-19.19	1.75 H	298	3.46	23.35
4	849.11	28.72 QP	46.00	-17.28	1.25 H	130	4.82	23.90
5	883.60	27.66 QP	46.00	-18.34	2.00 H	214	3.15	24.51
6	942.88	29.38 QP	46.00	-16.62	1.50 H	328	4.12	25.26

ANTENNA POLARITY & TEST DISTANCE: HORIZONTAL AT 3 M

No.	Freq. (MHz)	Emission Level (dBuV/m)	Limit (dBuV/m)	Margin (dB)	Antenna Height (m)	Table Angle (Degree)	Raw Value (dBuV)	Correction Factor (dB/m)
1	205.68	32.87 QP	43.50	-10.63	1.50 V	76	22.72	10.14
2	766.12	26.25 QP	46.00	-19.75	2.00 V	262	2.33	23.93
3	812.47	27.02 QP	46.00	-8.98	2.00 V	358	2.53	24.49
4	860.97	28.35 QP	46.00	-17.65	1.00 V	106	2.67	25.68
5	911.62	28.30 QP	46.00	-17.70	1.00 V	196	2.73	25.57
6	959.04	31.72 QP	46.00	-14.28	2.00 V	52	5.26	26.46

- REMARKS:**
1. Emission level(dBuV/m)=Raw Value(dBuV) + Correction Factor(dB/m)
 2. Correction Factor(dB/m) = Antenna Factor (dB/m) + Cable Factor (dB)
 3. The other emission levels were very low against the limit.
 4. Margin value = Emission level – Limit value.

Below 1GHz Worst-Case Data (For Charging Mode and EUT use Chip Antenna)

EUT	Bluetooth Stereo Headset	MODEL	BSH203
CHANNEL	Channel 78	FREQUENCY RANGE	Below 1 GHz
MODULATION TYPE	GFSK	DETECTOR FUNCTION	Quasi-Peak
INPUT POWER (SYSTEM)	120 Vac, 60 Hz	ENVIRONMENTAL CONDITIONS	23 deg. C, 64% RH, 991 hPa
TEST MODE	3	TESTED BY	Brad Wu

ANTENNA POLARITY & TEST DISTANCE: HORIZONTAL AT 3 M

No.	Freq. (MHz)	Emission Level (dBuV/m)	Limit (dBuV/m)	Margin (dB)	Antenna Height (m)	Table Angle (Degree)	Raw Value (dBuV)	Correction Factor (dB/m)
1	133.03	26.24 QP	43.50	-17.26	2.00 H	292	12.35	13.89
2	399.34	39.44 QP	46.00	-6.56	2.00 H	220	22.72	16.71
3	632.61	29.96 QP	46.00	-16.04	1.00 H	58	8.71	21.25
4	665.65	31.17 QP	46.00	-14.83	1.00 H	55	9.53	21.64
5	733.69	28.25 QP	46.00	-17.75	1.00 H	136	5.41	22.84
6	931.96	28.83 QP	46.00	-17.17	1.00 H	295	3.68	25.14

ANTENNA POLARITY & TEST DISTANCE: VERTICAL AT 3 M

No.	Freq. (MHz)	Emission Level (dBuV/m)	Limit (dBuV/m)	Margin (dB)	Antenna Height (m)	Table Angle (Degree)	Raw Value (dBuV)	Correction Factor (dB/m)
1	113.59	30.67 QP	43.50	-12.83	1.00 V	229	18.44	12.23
2	154.41	40.95 QP	43.50	-2.55	1.00 V	145	26.14	14.80
3	177.74	39.62 QP	43.50	-3.88	1.00 V	148	26.49	13.13
4	210.78	32.71 QP	43.50	-10.79	1.00 V	148	21.20	11.51
5	665.65	30.69 QP	46.00	-15.31	1.00 V	358	9.05	21.64
6	935.85	35.39 QP	46.00	-10.61	1.00 V	67	10.21	25.18

- REMARKS:**
1. Emission level(dBuV/m)=Raw Value(dBuV) + Correction Factor(dB/m)
 2. Correction Factor(dB/m) = Antenna Factor (dB/m) + Cable Factor (dB)
 3. The other emission levels were very low against the limit.
 4. Margin value = Emission level – Limit value.

Below 1GHz Worst-Case Data (For Charging Mode and EUT use PIFA Antenna)

EUT	Bluetooth Stereo Headset	MODEL	BSH203
CHANNEL	Channel 78	FREQUENCY RANGE	Below 1 GHz
MODULATION TYPE	GFSK	DETECTOR FUNCTION	Quasi-Peak
INPUT POWER (SYSTEM)	120 Vac, 60 Hz	ENVIRONMENTAL CONDITIONS	25 deg. C, 70% RH, 991 hPa
TEST MODE	4	TESTED BY	Jamison Chan

ANTENNA POLARITY & TEST DISTANCE: HORIZONTAL AT 3 M

No.	Freq. (MHz)	Emission Level (dBuV/m)	Limit (dBuV/m)	Margin (dB)	Antenna Height (m)	Table Angle (Degree)	Raw Value (dBuV)	Correction Factor (dB/m)
1	111.91	25.66 QP	43.50	-17.84	1.50 H	64	15.47	10.19
2	159.33	26.34 QP	43.50	-17.16	2.00 H	106	13.61	12.73
3	192.74	29.92 QP	43.50	-13.58	1.00 H	208	19.39	10.53
4	296.21	29.77 QP	46.00	-16.23	1.25 H	52	15.15	14.62
5	858.81	28.24 QP	46.00	-17.76	1.75 H	286	2.54	25.70
6	959.04	29.69 QP	46.00	-16.31	1.50 H	184	3.23	26.46

ANTENNA POLARITY & TEST DISTANCE: VERTICAL AT 3 M

No.	Freq. (MHz)	Emission Level (dBuV/m)	Limit (dBuV/m)	Margin (dB)	Antenna Height (m)	Table Angle (Degree)	Raw Value (dBuV)	Correction Factor (dB/m)
1	50.48	28.53 QP	40.00	-11.47	1.00 V	172	15.49	13.04
2	156.10	29.76 QP	43.50	-13.74	1.00 V	238	17.06	12.70
3	197.06	27.66 QP	43.50	-15.84	1.00 V	88	17.49	10.18
4	366.27	31.16 QP	46.00	-14.84	1.00 V	154	15.20	15.96
5	921.32	28.95 QP	46.00	-17.05	1.00 V	232	3.15	25.79
6	959.04	32.56 QP	46.00	-13.44	2.00 V	46	6.10	26.46

- REMARKS:**
1. Emission level(dBuV/m)=Raw Value(dBuV) + Correction Factor(dB/m)
 2. Correction Factor(dB/m) = Antenna Factor (dB/m) + Cable Factor (dB)
 3. The other emission levels were very low against the limit.
 4. Margin value = Emission level – Limit value.



1 ~ 25GHz Worst-Case Data (Chip Antenna)

EUT	Bluetooth Stereo Headset	MODEL	BSH203
CHANNEL	0	FREQUENCY RANGE	1 ~ 25 GHz
MODULATION TYPE	GFSK	DETECTOR FUNCTION	Peak(PK) Average (AV)
INPUT POWER (SYSTEM)	120 Vac, 60 Hz	ENVIRONMENTAL CONDITIONS	23 deg. C, 64% RH, 991 hPa
TEST MODE	3	TESTED BY	Brad Wu

ANTENNA POLARITY & TEST DISTANCE: HORIZONTAL AT 3 M

No.	Freq. (MHz)	Emission Level (dBuV/m)	Limit (dBuV/m)	Margin (dB)	Antenna Height (m)	Table Angle (Degree)	Raw Value (dBuV)	Correction Factor (dB/m)
1	1598.00	51.38 PK	74.00	-22.62	1.00 H	300	22.05	29.34
1	1598.00	32.99 AV	54.00	-21.01	1.00 H	300	3.66	29.34
2	2390.00	38.60 PK	74.00	-35.40	1.06 H	160	6.73	31.87
3	*2402.00	91.12 PK			1.06 H	160	59.20	31.92
3	*2402.00	61.12 AV			1.06 H	160	29.20	31.92
4	7206.00	54.14 PK	74.00	-19.86	1.44 H	264	9.95	44.19
4	7206.00	42.93 AV	54.00	-11.07	1.44 H	264	-1.26	44.19

ANTENNA POLARITY & TEST DISTANCE: VERTICAL AT 3 M

No.	Freq. (MHz)	Emission Level (dBuV/m)	Limit (dBuV/m)	Margin (dB)	Antenna Height (m)	Table Angle (Degree)	Raw Value (dBuV)	Correction Factor (dB/m)
1	1598.00	48.57 PK	74.00	-25.43	1.06 V	214	19.23	29.34
2	2390.00	44.27 PK	74.00	-29.73	1.00 V	64	12.40	31.87
3	*2402.00	96.79 PK			1.00 V	64	64.87	31.92
3	*2402.00	66.79 AV			1.00 V	64	34.87	31.92
4	7206.00	52.43 PK	74.00	-21.57	1.10 V	146	8.24	44.19
4	7206.00	40.81 AV	54.00	-13.19	1.10 V	146	-3.38	44.19

- REMARKS:**
- 1 Emission level(dBuV/m)=Raw Value(dBuV) + Correction Factor(dB/m)
 2. Correction Factor(dB/m) = Antenna Factor (dB/m) + Cable Factor (dB)
 3. The other emission levels were very low against the limit.
 4. Margin value = Emission level – Limit value.
 5. The DH5 packet was the worse case duty cycle for a transmit dwell time on a channel, based upon bluetooth theory the transmitter is on 0.625*5 per 247 ms per channel. Therefore, the duty cycle be equal to: $20\log(3.125/100) = -30$ dB
 6. Average value = peak reading $-20\log(\text{duty cycle})$

EUT	Bluetooth Stereo Headset	MODEL	BSH203
CHANNEL	39	FREQUENCY RANGE	1 ~ 25 GHz
MODULATION TYPE	GFSK	DETECTOR FUNCTION	Peak(PK) Average (AV)
INPUT POWER (SYSTEM)	120 Vac, 60 Hz	ENVIRONMENTAL CONDITIONS	23 deg. C, 64% RH, 991 hPa
TEST MODE	3	TESTED BY	Brad Wu

ANTENNA POLARITY & TEST DISTANCE: HORIZONTAL AT 3 M

No.	Freq. (MHz)	Emission Level (dBuV/m)	Limit (dBuV/m)	Margin (dB)	Antenna Height (m)	Table Angle (Degree)	Raw Value (dBuV)	Correction Factor (dB/m)
1	1598.00	50.24 PK	74.00	-23.76	1.04 H	216	20.90	29.34
1	1598.00	32.41 AV	54.00	-21.59	1.04 H	216	3.07	29.34
2	*2441.00	87.41 PK			1.37 H	338	55.34	32.07
2	*2441.00	57.41 AV			1.37 H	338	25.34	32.07
3	7323.00	53.61 PK	74.00	-20.39	1.24 H	213	9.07	44.54
3	7323.00	41.22 AV	54.00	-12.78	1.24 H	213	-3.32	44.54

ANTENNA POLARITY & TEST DISTANCE: VERTICAL AT 3 M

No.	Freq. (MHz)	Emission Level (dBuV/m)	Limit (dBuV/m)	Margin (dB)	Antenna Height (m)	Table Angle (Degree)	Raw Value (dBuV)	Correction Factor (dB/m)
1	1598.00	47.53 PK	74.00	-26.47	1.02 V	198	18.19	29.34
2	*2441.00	92.85 PK			1.23 V	66	60.78	32.07
2	*2441.00	62.85 AV			1.23 V	66	30.78	32.07
3	7323.00	50.68 PK	74.00	-23.32	1.06 V	247	6.14	44.54
3	7323.00	38.27 AV	54.00	-15.73	1.06 V	247	-6.27	44.54

REMARKS:

1. Emission level(dBuV/m)=Raw Value(dBuV) + Correction Factor(dB/m)
2. Correction Factor(dB/m) = Antenna Factor (dB/m) + Cable Factor (dB)
3. The other emission levels were very low against the limit.
4. Margin value = Emission level – Limit value.
5. The DH5 packet was the worse case duty cycle for a transmit dwell time on a channel, based upon bluetooth theory the transmitter is on 0.625*5 per 247 ms per channel. Therefore, the duty cycle be equal to: $20\log(3.125/100) = -30$ dB
6. Average value = peak reading $-20\log(\text{duty cycle})$



EUT	Bluetooth Stereo Headset	MODEL	BSH203
CHANNEL	78	FREQUENCY RANGE	1 ~ 25 GHz
MODULATION TYPE	GFSK	DETECTOR FUNCTION	Peak(PK) Average (AV)
INPUT POWER (SYSTEM)	120 Vac, 60 Hz	ENVIRONMENTAL CONDITIONS	23 deg. C, 64% RH, 991 hPa
TEST MODE	3	TESTED BY	Brad Wu

ANTENNA POLARITY & TEST DISTANCE: HORIZONTAL AT 3 M

No.	Freq. (MHz)	Emission Level (dBuV/m)	Limit (dBuV/m)	Margin (dB)	Antenna Height (m)	Table Angle (Degree)	Raw Value (dBuV)	Correction Factor (dB/m)
1	1598.00	49.86 PK	74.00	-24.14	1.02 H	158	20.52	29.34
2	*2480.00	85.85 PK			1.34 H	336	53.62	32.23
2	*2480.00	55.85 AV			1.34 H	336	23.62	32.23
3	2483.50	37.70 PK	74.00	-36.30	1.34 H	336	5.46	32.24
4	7440.00	52.61 PK	74.00	-21.39	1.20 H	199	7.79	44.82
4	7440.00	40.37 AV	54.00	-13.63	1.20 H	199	-4.45	44.82

ANTENNA POLARITY & TEST DISTANCE: VERTICAL AT 3 M

No.	Freq. (MHz)	Emission Level (dBuV/m)	Limit (dBuV/m)	Margin (dB)	Antenna Height (m)	Table Angle (Degree)	Raw Value (dBuV)	Correction Factor (dB/m)
1	1598.00	46.35 PK	74.00	-27.65	1.07 V	206	17.01	29.34
2	*2480.00	89.04 PK			1.22 V	66	56.81	32.23
2	*2480.00	59.04 AV			1.22 V	66	26.81	32.23
3	2483.50	40.89 PK	74.00	-33.11	1.22 V	66	8.65	32.24
4	7440.00	50.16 PK	74.00	-23.84	1.02 V	241	5.34	44.82
4	7440.00	38.04 AV	54.00	-15.96	1.02 V	241	-6.78	44.82

- REMARKS:**
1. Emission level(dBuV/m)=Raw Value(dBuV) + Correction Factor(dB/m)
 2. Correction Factor(dB/m) = Antenna Factor (dB/m) + Cable Factor (dB)
 3. The other emission levels were very low against the limit.
 4. Margin value = Emission level – Limit value.
 5. The DH5 packet was the worse case duty cycle for a transmit dwell time on a channel, based upon bluetooth theory the transmitter is on 0.625*5 per 247 ms per channel. Therefore, the duty cycle be equal to: $20\log(3.125/100) = -30$ dB
 6. Average value = peak reading $-20\log(\text{duty cycle})$



1 ~ 25GHz Worst-Case Data (PIFA Antenna)

EUT	Bluetooth Stereo Headset	MODEL	BSH203
CHANNEL	0	FREQUENCY RANGE	1 ~ 25 GHz
MODULATION TYPE	GFSK	DETECTOR FUNCTION	Peak(PK) Average (AV)
INPUT POWER (SYSTEM)	120 Vac, 60 Hz	ENVIRONMENTAL CONDITIONS	25 deg. C, 70% RH, 991 hPa
TEST MODE	4	TESTED BY	Brad Wu

ANTENNA POLARITY & TEST DISTANCE: HORIZONTAL AT 3 M

No.	Freq. (MHz)	Emission Level (dBuV/m)	Limit (dBuV/m)	Margin (dB)	Antenna Height (m)	Table Angle (Degree)	Raw Value (dBuV)	Correction Factor (dB/m)
1	1200.00	39.19 PK	74.00	-34.81	1.18 H	258	10.06	29.13
1	1200.00	27.41 AV	54.00	-26.59	1.18 H	258	-1.72	29.13
2	2390.00	43.61 PK	74.00	-30.39	1.26 H	48	10.29	33.32
2	2390.00	33.61 AV	54.00	-20.39	1.26 H	48	0.29	33.32
3	*2402.00	98.71 PK			1.26 H	48	65.34	33.37
3	*2402.00	68.71 AV			1.26 H	48	35.34	33.37
4	4804.00	47.42 PK	74.00	-26.58	1.22 H	291	7.68	39.74
4	4804.00	17.42 AV	54.00	-36.58	1.22 H	291	-22.32	39.74

ANTENNA POLARITY & TEST DISTANCE: VERTICAL AT 3 M

No.	Freq. (MHz)	Emission Level (dBuV/m)	Limit (dBuV/m)	Margin (dB)	Antenna Height (m)	Table Angle (Degree)	Raw Value (dBuV)	Correction Factor (dB/m)
1	1200.00	38.38 PK	74.00	-35.62	1.00 V	73	9.25	29.13
1	1200.00	26.02 AV	54.00	-27.98	1.00 V	73	-3.11	29.13
2	2390.00	37.85 PK	74.00	-36.15	1.63 V	143	4.53	33.32
2	2390.00	27.85 AV	54.00	-26.15	1.63 V	143	-5.47	33.32
3	*2402.00	92.95 PK			1.63 V	143	59.58	33.37
3	*2402.00	62.95 AV			1.63 V	143	29.58	33.37
4	4804.00	46.55 PK	74.00	-27.45	1.04 V	45	6.81	39.74
4	4804.00	16.55 AV	54.00	-37.45	1.04 V	45	-23.19	39.74

- REMARKS:**
1. Emission level(dBuV/m)=Raw Value(dBuV) + Correction Factor(dB/m)
 - 2 Correction Factor(dB/m) = Antenna Factor (dB/m) + Cable Factor (dB)
 3. The other emission levels were very low against the limit.
 4. Margin value = Emission level – Limit value.
 5. The DH5 packet was the worse case duty cycle for a transmit dwell time on a channel, based upon bluetooth theory the transmitter is on 0.625*5 per 247 ms per channel. Therefore, the duty cycle be equal to: $20\log(3.125/100) = -30$ dB
 6. Average value = peak reading $-20\log(\text{duty cycle})$

EUT	Bluetooth Stereo Headset	MODEL	BSH203
CHANNEL	39	FREQUENCY RANGE	1 ~ 25 GHz
MODULATION TYPE	GFSK	DETECTOR FUNCTION	Peak(PK) Average (AV)
INPUT POWER (SYSTEM)	120 Vac, 60 Hz	ENVIRONMENTAL CONDITIONS	25 deg. C, 70% RH, 991 hPa
TEST MODE	4	TESTED BY	Brad Wu

ANTENNA POLARITY & TEST DISTANCE: HORIZONTAL AT 3 M

No.	Freq. (MHz)	Emission Level (dBuV/m)	Limit (dBuV/m)	Margin (dB)	Antenna Height (m)	Table Angle (Degree)	Raw Value (dBuV)	Correction Factor (dB/m)
1	1219.50	39.19 PK	74.00	-34.81	1.00 H	270	10.00	29.19
1	1219.50	26.65 AV	54.00	-27.35	1.00 H	270	-2.54	29.19
2	*2441.00	98.57 PK			1.34 H	329	65.03	33.54
2	*2441.00	68.57 AV			1.34 H	329	35.03	33.54
3	4882.00	48.43 PK	74.00	-25.57	1.32 H	54	8.48	39.95
3	4882.00	18.43 AV	54.00	-35.57	1.32 H	54	-21.52	39.95

ANTENNA POLARITY & TEST DISTANCE: VERTICAL AT 3 M

No.	Freq. (MHz)	Emission Level (dBuV/m)	Limit (dBuV/m)	Margin (dB)	Antenna Height (m)	Table Angle (Degree)	Raw Value (dBuV)	Correction Factor (dB/m)
1	1219.50	38.42 PK	74.00	-35.58	1.58 V	223	9.23	29.19
1	1219.50	26.43 AV	54.00	-27.57	1.58 V	223	-2.76	29.19
2	*2441.00	92.61 PK			1.59 V	281	59.07	33.54
2	*2441.00	62.61 AV			1.59 V	281	29.07	33.54
3	4882.00	47.53 PK	74.00	-26.47	1.00 V	164	7.58	39.95
3	4882.00	17.53 AV	54.00	-36.47	1.00 V	164	-22.42	39.95

- REMARKS:**
1. Emission level(dBuV/m)=Raw Value(dBuV) + Correction Factor(dB/m)
 2. Correction Factor(dB/m) = Antenna Factor (dB/m) + Cable Factor (dB)
 3. The other emission levels were very low against the limit.
 4. Margin value = Emission level – Limit value.
 5. The DH5 packet was the worse case duty cycle for a transmit dwell time on a channel, based upon bluetooth theory the transmitter is on 0.625*5 per 247 ms per channel. Therefore, the duty cycle be equal to: $20\log(3.125/100) = -30$ dB
 6. Average value = peak reading $-20\log(\text{duty cycle})$



EUT	Bluetooth Stereo Headset	MODEL	BSH203
CHANNEL	78	FREQUENCY RANGE	1 ~ 25 GHz
MODULATION TYPE	GFSK	DETECTOR FUNCTION	Peak(PK) Average (AV)
INPUT POWER (SYSTEM)	120 Vac, 60 Hz	ENVIRONMENTAL CONDITIONS	25 deg. C, 70% RH, 991 hPa
TEST MODE	4	TESTED BY	Brad Wu

ANTENNA POLARITY & TEST DISTANCE: HORIZONTAL AT 3 M

No.	Freq. (MHz)	Emission Level (dBuV/m)	Limit (dBuV/m)	Margin (dB)	Antenna Height (m)	Table Angle (Degree)	Raw Value (dBuV)	Correction Factor (dB/m)
1	1239.00	39.43 PK	74.00	-34.57	1.41 H	132	10.18	29.25
1	1239.00	26.76 AV	54.00	-27.24	1.41 H	132	-2.49	29.25
2	*2480.00	96.95 PK			1.31 H	336	63.25	33.70
2	*2480.00	66.95 AV			1.31 H	336	33.25	33.70
3	2483.50	44.69 PK	74.00	-29.31	1.31 H	336	10.97	33.72
3	2483.50	34.69 AV	54.00	-19.31	1.31 H	336	0.97	33.72
4	4960.00	48.76 PK	74.00	-25.24	1.21 H	162	8.55	40.21
4	4960.00	18.76 AV	54.00	-35.24	1.21 H	162	-21.45	40.21

ANTENNA POLARITY & TEST DISTANCE: VERTICAL AT 3 M

No.	Freq. (MHz)	Emission Level (dBuV/m)	Limit (dBuV/m)	Margin (dB)	Antenna Height (m)	Table Angle (Degree)	Raw Value (dBuV)	Correction Factor (dB/m)
1	1239.00	38.26 PK	74.00	-35.74	1.00 V	120	9.01	29.25
1	1239.00	26.05 AV	54.00	-27.95	1.00 V	120	-3.20	29.25
2	*2480.00	92.44 PK			1.45 V	140	58.74	33.70
2	*2480.00	62.44 AV			1.45 V	140	28.74	33.70
3	2483.50	40.18 PK	74.00	-33.82	1.45 V	140	6.46	33.72
3	2483.50	30.18 AV	54.00	-23.82	1.45 V	140	-3.54	33.72
4	4960.00	47.84 PK	74.00	-26.16	1.04 V	181	7.63	40.21
4	4960.00	17.84 AV	54.00	-36.16	1.04 V	181	-22.37	40.21

REMARKS:

1. Emission level(dBuV/m)=Raw Value(dBuV) + Correction Factor(dB/m)
2. Correction Factor(dB/m) = Antenna Factor (dB/m) + Cable Factor (dB)
3. The other emission levels were very low against the limit.
4. Margin value = Emission level – Limit value.
5. The DH5 packet was the worse case duty cycle for a transmit dwell time on a channel, based upon bluetooth theory the transmitter is on 0.625*5 per 247 ms per channel. Therefore, the duty cycle be equal to: $20\log(3.125/100) = -30$ dB
6. Average value = peak reading $-20\log(\text{duty cycle})$

4.8 BAND EDGES MEASUREMENT

4.8.1 LIMITS OF BAND EDGES MEASUREMENT

Below -20dB of the highest emission level of operating band (in 100KHz RBW).

4.8.2 TEST INSTRUMENTS

Description & Manufacturer	Model No.	Serial No.	Calibrated Until
SPECTRUM ANALYZER	FSEK30	100049	Aug. 12, 2005

NOTES:

The calibration interval of the above test instruments is 12 months. And the calibrations are traceable to NML/ROC and NIST/USA.

4.8.3 TEST PROCEDURE

The transmitter output was connected to the spectrum analyzer via a low lose cable. Set both RBW and VBW of spectrum analyzer to 100 kHz with suitable frequency span including 100 MHz bandwidth from band edge. The band edges was measured and recorded.

4.8.4 DEVIATION FROM TEST STANDARD

No deviation.

4.8.5 EUT OPERATING CONDITION

The software provided by client enabled the EUT to transmit and receive data at lowest, middle and highest channel frequencies individually.

4.8.6 TEST RESULTS

The spectrum plots are attached on the following 4 images. D2 line indicates the highest level, D1 line indicates the 20dB offset below D2. It shows compliance with the requirement in part 15.247(d).

Test Mode 3

NOTE 1: The band edge emission plot on page 70 shows 55.04dBc between carrier maximum power and local maximum emission in restrict band (2.3900GHz). The emission of carrier strength list in the test result of channel 0 at the item 4.7.7 is 96.79dBuV/m (Peak), so the maximum field strength in restrict band is $96.79 - 55.04 = 41.75$ dBuV/m which is under 74 dBuV/m limit.

The band edge emission plot on page 70 shows 55.04dBc between carrier maximum power and local maximum emission in restrict band (2.3900GHz). The emission of carrier strength list in the test result of channel 0 at the item 4.7.7 is 66.79dBuV/m (Average), so the maximum field strength in restrict band is $66.79 - 55.04 = 11.75$ dBuV/m which is under 54 dBuV/m limit.

NOTE 2: The band edge emission plot on page 71 shows 50.44dBc between carrier maximum power and local maximum emission in restrict band (2.4918GHz). The emission of carrier strength list in the test result of channel 78 at the item 4.7.7 is 89.04dBuV/m (Peak), so the maximum field strength in restrict band is $89.04 - 50.44 = 38.60$ dBuV/m which is under 74 dBuV/m limit.

The band edge emission plot on page 71 shows 50.44dBc between carrier maximum power and local maximum emission in restrict band (2.4918GHz). The emission of carrier strength list in the test result of channel 78 at the item 4.7.7 is 59.04dBuV/m (Average), so the maximum field strength in restrict band is $59.04 - 50.44 = 8.60$ dBuV/m which is under 54 dBuV/m limit.

Test Mode 4

NOTE 1: The band edge emission plot on page 70 shows 55.04dBc between carrier maximum power and local maximum emission in restrict band (2.3900GHz). The emission of carrier strength list in the test result of channel 0 at the item 4.7.7 is 100.71dBuV/m (Peak), so the maximum field strength in restrict band is $100.71 - 55.04 = 45.67$ dBuV/m which is under 74 dBuV/m limit.

The band edge emission plot on page 70 shows 55.04dBc between carrier maximum power and local maximum emission in restrict band (2.3900GHz). The emission of carrier strength list in the test result of channel 0 at the item 4.7.7 is 70.71dBuV/m (Average), so the maximum field strength in restrict band is $70.71 - 55.04 = 15.67$ dBuV/m which is under 54 dBuV/m limit.

NOTE 2: The band edge emission plot on page 71 shows 50.44dBc between carrier maximum power and local maximum emission in restrict band (2.4918GHz). The emission of carrier strength list in the test result of channel 78 at the item 4.7.7 is 98.95dBuV/m (Peak), so the maximum field strength in restrict band is $98.95 - 50.44 = 48.51$ dBuV/m which is under 74 dBuV/m limit.

The band edge emission plot on page 71 shows 50.44dBc between carrier maximum power and local maximum emission in restrict band (2.4918GHz). The emission of carrier strength list in the test result of channel 78 at the item 4.7.7 is 68.95dBuV/m (Average), so the maximum field strength in restrict band is $68.95 - 50.44 = 18.51$ dBuV/m which is under 54 dBuV/m limit.

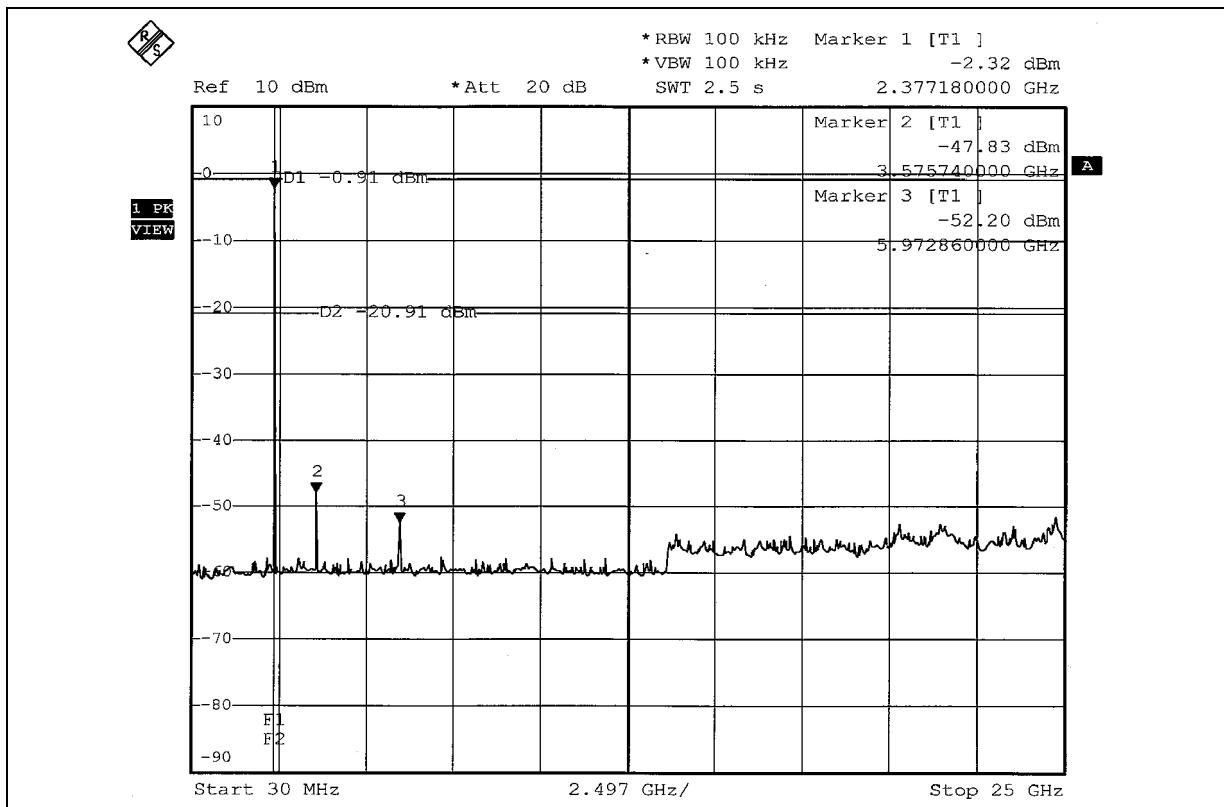
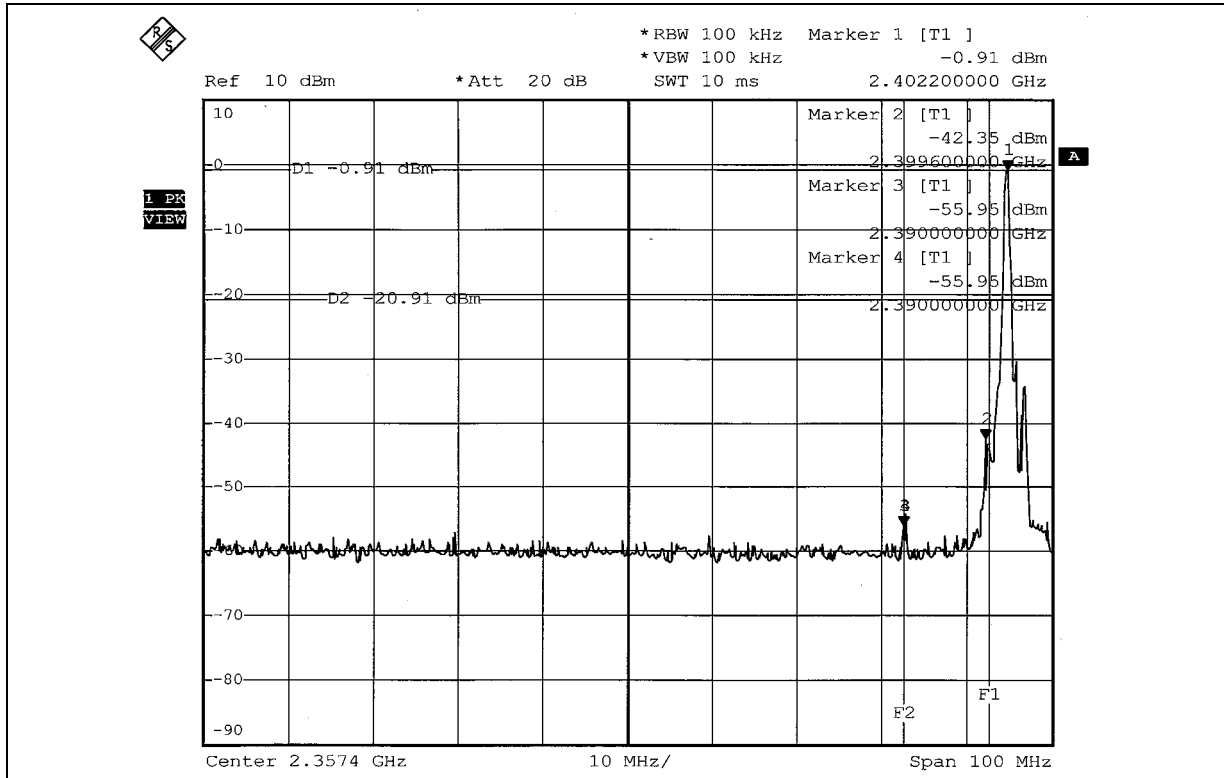

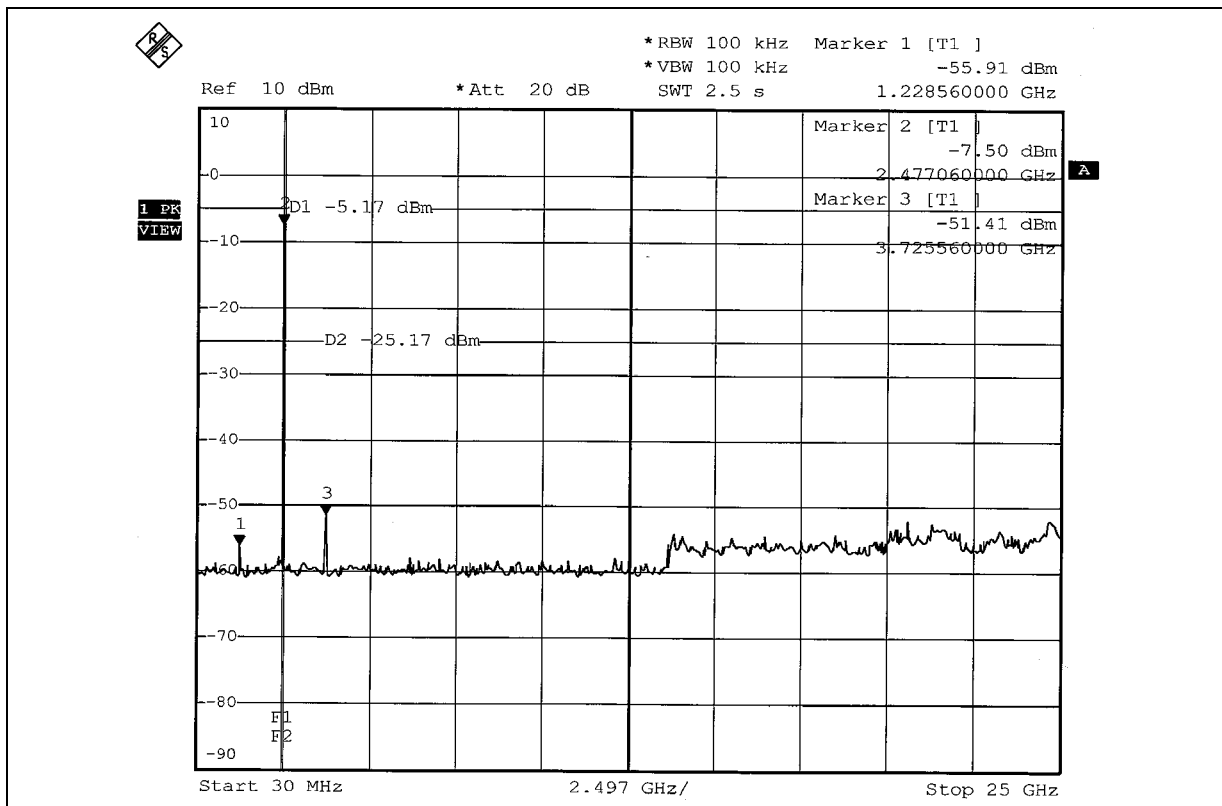
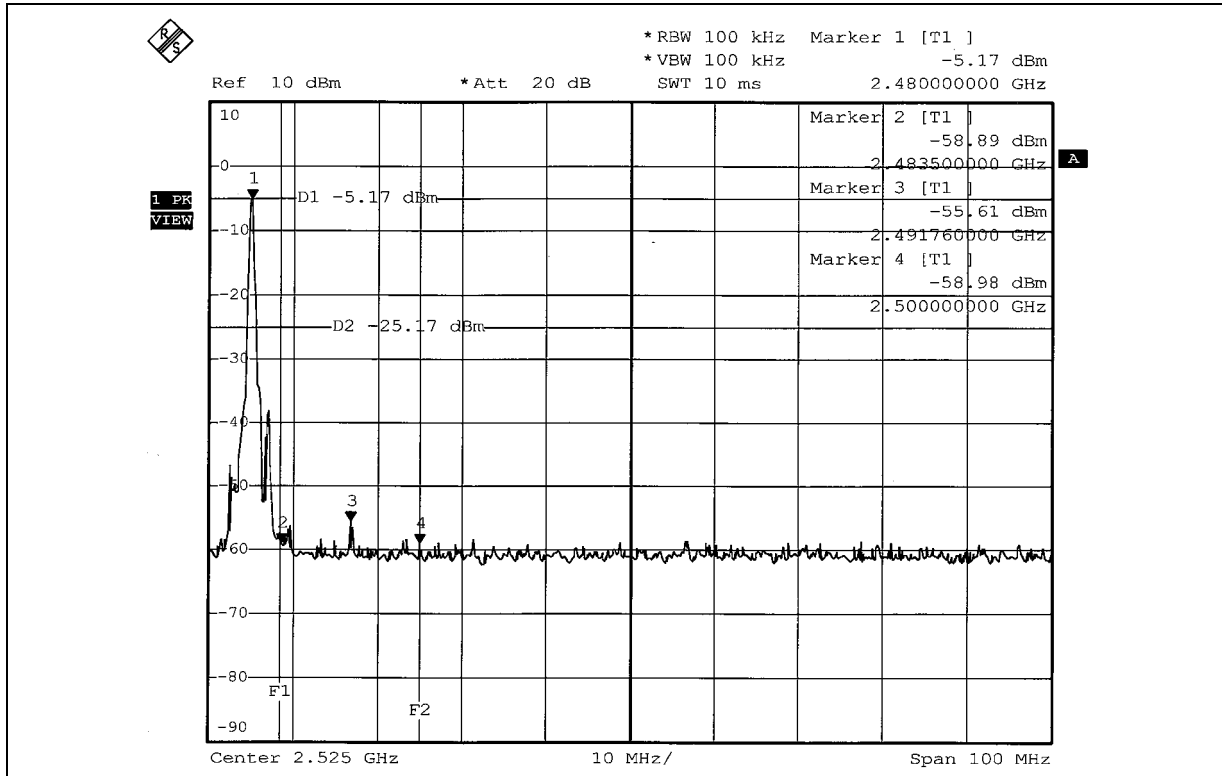



4.9 ANTENNA REQUIREMENT

4.9.1 STANDARD APPLICABLE

For intentional device, according to FCC 47 CFR Section 15.203, an intentional radiator shall be designed to ensure that no antenna other than that furnished by the responsible party shall be used with the device.

And according to FCC 47 CFR Section 15.247 (b), if transmitting antennas of directional gain greater than 6 dBi are used, the power shall be reduced by the amount in dB that the directional gain of the antenna exceeds 6 dBi.

4.9.2 ANTENNA CONNECTED CONSTRUCTION

The antenna used in this product are Chip and PIFA antennas without antenna connector. The maximum gain of this antenna is 1.00dBi.

5 PHOTOGRAPHS OF THE TEST CONFIGURATION
CONDUCTED EMISSION TEST
Test Mode 3



Test Mode 4



RADIATED EMISSION TEST
Test Mode 1

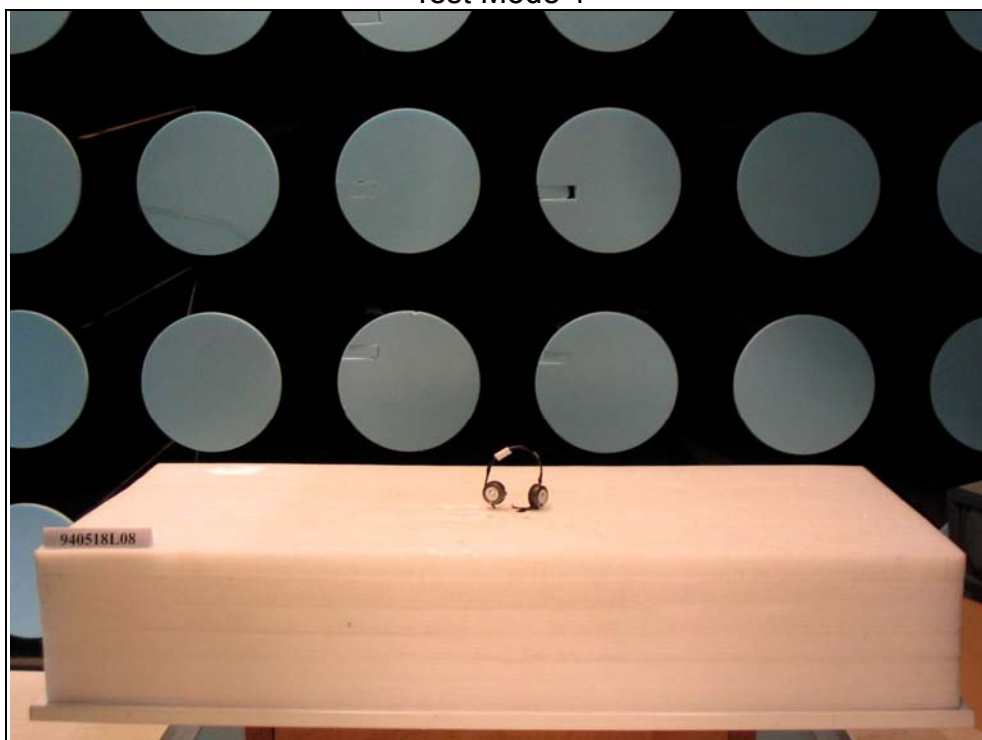

Test Mode 2

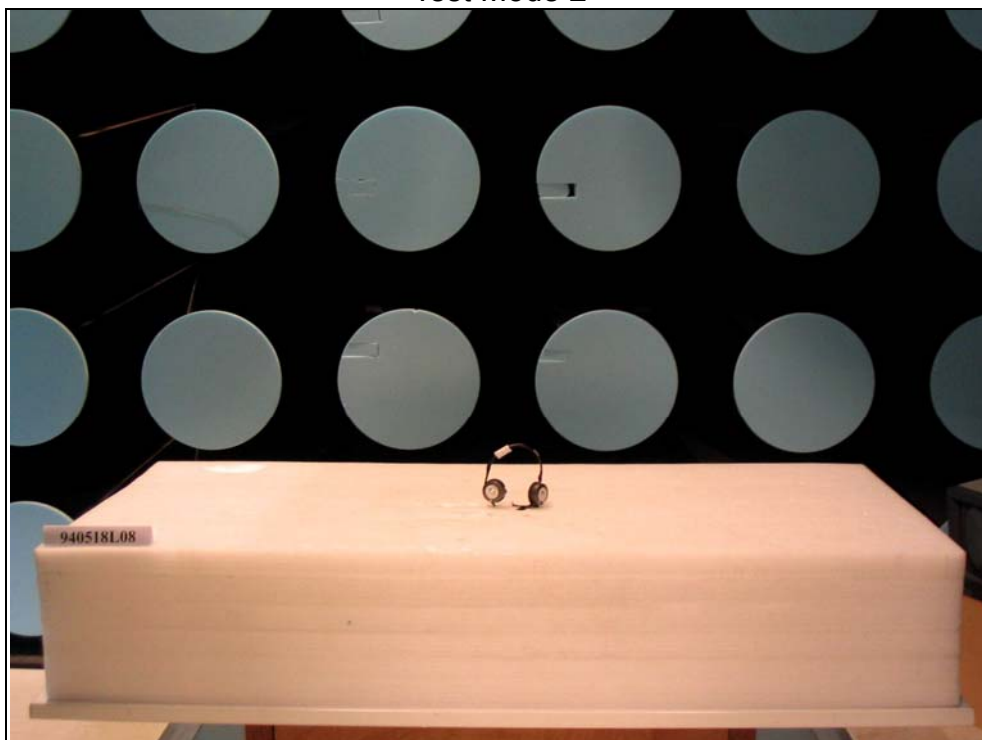

Test Mode 3

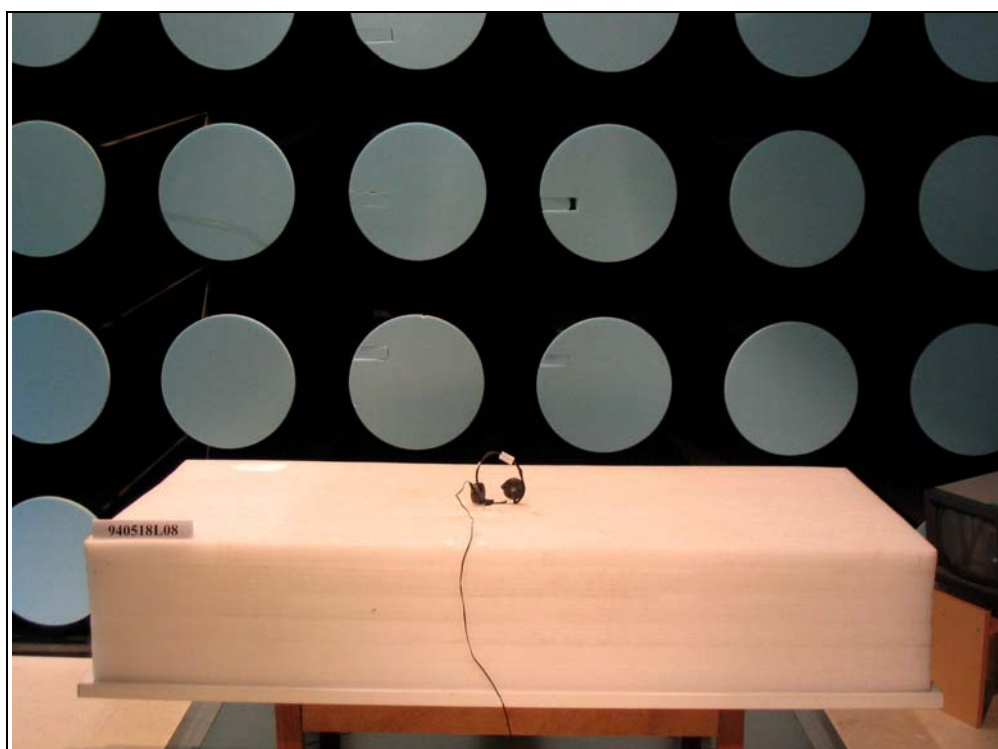

Test Mode 4

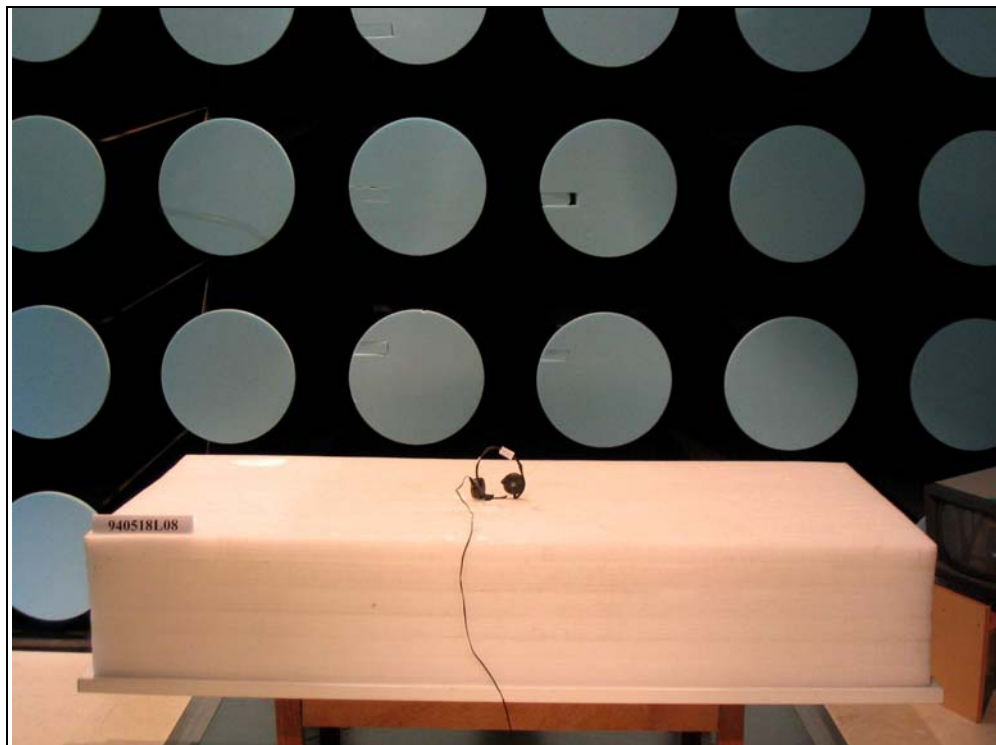
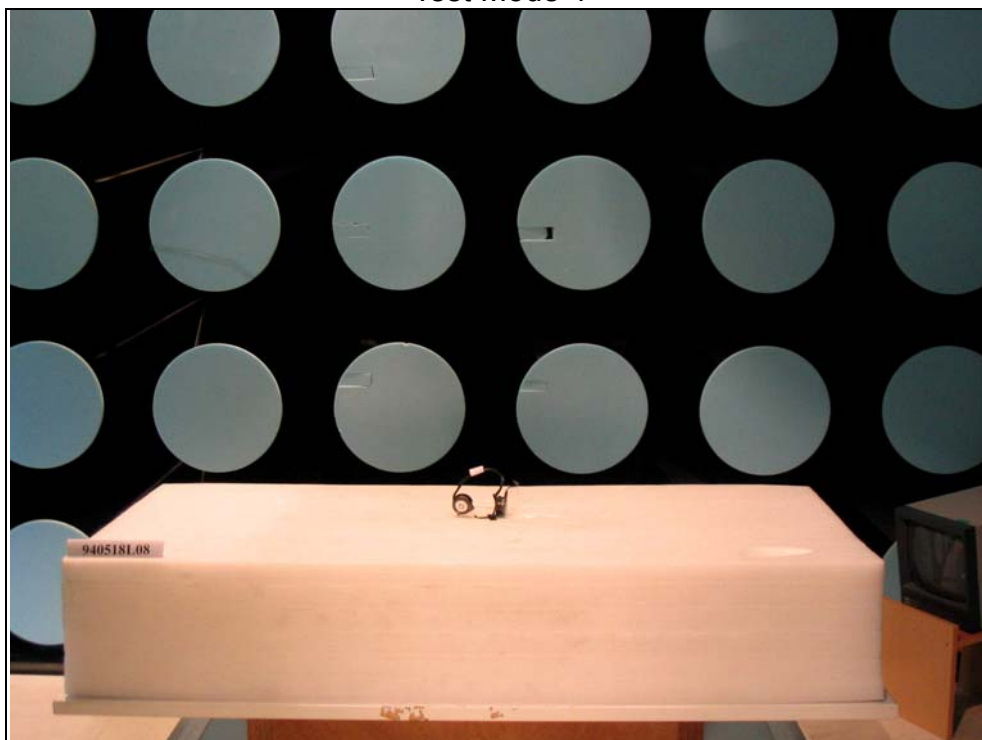



6 INFORMATION ON THE TESTING LABORATORIES

We, ADT Corp., were founded in 1988 to provide our best service in EMC, Radio, Telecom and Safety consultation. Our laboratories are accredited and approved by the following approval agencies according to ISO/IEC 17025.

USA	FCC, NVLAP, UL, A2LA
Germany	TUV Rheinland
Japan	VCCI
Norway	NEMKO
Canada	INDUSTRY CANADA , CSA
R.O.C.	CNLA, BSMI, DGT
Netherlands	Telefication
Singapore	PSB , GOST-ASIA(MOU)
Russia	CERTIS(MOU)

Copies of accreditation certificates of our laboratories obtained from approval agencies can be downloaded from our web site: www.adt.com.tw/index.5/phtml.

If you have any comments, please feel free to contact us at the following:

Linko EMC/RF Lab:

Tel: 886-2-26052180

Fax: 886-2-26052943

Hsin Chu EMC/RF Lab:

Tel: 886-3-5935343

Fax: 886-3-5935342

Hwa Ya EMC/RF/Safety/Telecom Lab:

Tel: 886-3-3183232

Fax: 886-3-3185050

Linko RF Lab.

Tel: 886-3-3270910

Fax: 886-3-3270892

Web Site: www.adt.com.tw

The address and road map of all our labs can be found in our web site also.