



SPORTON International Inc.

No. 52, Hwa Ya 1st Rd., Hwa Ya Technology Park, Kwei-Shan Hsiang, Tao Yuan Hsien, Taiwan, R.O.C.
Ph: 886-3-327-3456 / FAX: 886-3-327-0973 / www.sporton.com.tw

FCC RADIO TEST REPORT

Applicant's company	Abocom Systems, Inc.
Applicant Address	No.77, Yu-Yih Rd., Chu-Nan, Miao-Lih County 35059, Taiwan R.O.C.
FCC ID	MQ4AMB7220
Manufacturer's company	Abocom Systems, Inc.
Manufacturer Address	No.77, Yu-Yih Rd., Chu-Nan, Miao-Lih County 35059, Taiwan R.O.C.

Product Name	2x2 11ac+BT4.0 Wi-Fi Module
Brand Name	AboCom
Model No.	AMB7220
Test Rule	47 CFR FCC Part 15 Subpart C § 15.247
Test Freq. Range	2400 ~ 2483.5MHz
Received Date	Jan. 15, 2016
Final Test Date	Jan. 26, 2016
Submission Type	Original Equipment

Statement

Test result included in this report is for the IEEE 802.11n and IEEE 802.11b/g of the product.

The test result in this report refers exclusively to the presented test model / sample.

Without written approval of SPORTON International Inc., the test report shall not be reproduced except in full.

The measurements and test results shown in this test report were made in accordance with the procedures and found in compliance with the limit given in ANSI C63.10-2013, 47 CFR FCC Part 15 Subpart C, KDB558074 D01 v03r04 and KDB 662911 D01 v02r01.

The test equipment used to perform the test is calibrated and traceable to NML/ROC.



Table of Contents

1. VERIFICATION OF COMPLIANCE	1
2. SUMMARY OF THE TEST RESULT	2
3. GENERAL INFORMATION	3
3.1. Product Details.....	3
3.2. Accessories.....	4
3.3. Table for Filed Antenna.....	5
3.4. Table for Carrier Frequencies	6
3.5. Table for Test Modes.....	7
3.6. Table for Testing Locations.....	8
3.7. Table for Supporting Units	9
3.8. Table for Parameters of Test Software Setting	10
3.9. EUT Operation during Test	10
3.10. Duty Cycle.....	10
3.11. Test Configurations	11
4. TEST RESULT	14
4.1. AC Power Line Conducted Emissions Measurement.....	14
4.2. Maximum Conducted Output Power Measurement.....	18
4.3. Power Spectral Density Measurement	20
4.4. 6dB Spectrum Bandwidth Measurement	26
4.5. Radiated Emissions Measurement	33
4.6. Emissions Measurement	51
4.7. Antenna Requirements	69
5. LIST OF MEASURING EQUIPMENTS	70
6. MEASUREMENT UNCERTAINTY	71
APPENDIX A. TEST PHOTOS	A1 ~ A8
APPENDIX B. RADIATED EMISSION CO-LOCATION REPORT	B1 ~ B5



History of This Test Report

REPORT NO.	VERSION	DESCRIPTION	ISSUED DATE
FR611516AA	Rev. 01	Initial issue of report	Mar. 09, 2016



1. VERIFICATION OF COMPLIANCE

Product Name : 2x2 11ac+BT4.0 Wi-Fi Module
Brand Name : AboCom
Model No. : AMB7220
Applicant : Abocom Systems, Inc.
Test Rule Part(s) : 47 CFR FCC Part 15 Subpart C § 15.247

Sporton International as requested by the applicant to evaluate the EMC performance of the product sample received on Jan. 15, 2016 would like to declare that the tested sample has been evaluated and found to be in compliance with the tested rule parts. The data recorded as well as the test configuration specified is true and accurate for showing the sample's EMC nature.

A handwritten signature in black ink, appearing to read "Sam Chen", written over a horizontal line.

Sam Chen

SPORTON INTERNATIONAL INC.

2. SUMMARY OF THE TEST RESULT

Applied Standard: 47 CFR FCC Part 15 Subpart C				
Part	Rule Section	Description of Test	Result	Under Limit
4.1	15.207	AC Power Line Conducted Emissions	Complies	12.42 dB
4.2	15.247(b)(3)	Maximum Conducted Output Power	Complies	3.71 dB
4.3	15.247(e)	Power Spectral Density	Complies	6.86 dB
4.4	15.247(a)(2)	6dB Spectrum Bandwidth	Complies	-
4.5	15.247(d)	Radiated Emissions	Complies	0.06 dB
4.6	15.247(d)	Band Edge Emissions	Complies	0.15 dB
4.7	15.203	Antenna Requirements	Complies	-

3. GENERAL INFORMATION

3.1. Product Details

Items	Description
Product Type	IEEE 802.11b/g: WLAN (1TX, 1RX) IEEE 802.11n: WLAN (2TX, 2RX)
Radio Type	Intentional Transceiver
Power Type	From host system
Modulation	IEEE 802.11b: DSSS IEEE 802.11g: OFDM IEEE 802.11n: see the below table
Data Modulation	IEEE 802.11b: DSSS (BPSK / QPSK / CCK) IEEE 802.11g/n: OFDM (BPSK / QPSK / 16QAM / 64QAM)
Data Rate (Mbps)	IEEE 802.11b: DSSS (1/ 2/ 5.5/11) IEEE 802.11g: OFDM (6/9/12/18/24/36/48/54) IEEE 802.11n: see the below table
Frequency Range	2400 ~ 2483.5MHz
Channel Number	11 for 20MHz bandwidth ; 7 for 40MHz bandwidth
Channel Band Width (99%)	IEEE 802.11b: 12.33 MHz IEEE 802.11g: 28.31 MHz IEEE 802.11n MCS0 (HT20): 28.83 MHz IEEE 802.11n MCS0 (HT40): 37.19 MHz
Maximum Conducted Output Power	IEEE 802.11b: 17.28 dBm IEEE 802.11g: 23.37 dBm IEEE 802.11n MCS0 (HT20): 26.29 dBm IEEE 802.11n MCS0 (HT40): 21.65 dBm
Carrier Frequencies	Please refer to section 3.4
Antenna	Please refer to section 3.3

Items	Description	
Beamforming Function	<input type="checkbox"/> With beamforming	<input checked="" type="checkbox"/> Without beamforming

Antenna and Band width

Antenna	Single (TX)		Two (TX)	
	20 MHz	40 MHz	20 MHz	40 MHz
Band width Mode				
IEEE 802.11b	V	X	X	X
IEEE 802.11g	V	X	X	X
IEEE 802.11n	X	X	V	V

IEEE 11n Spec.

Protocol	Number of Transmit Chains (NTX)	Data Rate / MCS
802.11n (HT20)	2	MCS 0-15
802.11n (HT40)	2	MCS 0-15

Note 1: IEEE Std. 802.11n modulation consists of HT20 and HT40 (HT: High Throughput).
Then EUT supports HT20 and HT40.

Note 2: Modulation modes consist of below configuration: HT20/HT40: IEEE 802.11n

3.2. Accessories

N/A

3.3. Table for Filed Antenna

For WiFi Antenna:

Ant.	Brand	P/NO	Antenna Type	Connector	Gain (dBi)		
					2.4GHz	5GHz	
						Band1	Band4
1	WHA YU	-	Printed Antenna	I-PEX	3.8	1.4	1.9
2	WHA YU	-	Printed Antenna	I-PEX	2.6	1.1	1.2

For Bluetooth Antenna:

Ant.	Brand	P/NO	Antenna Type	Connector	Gain (dBi)
3	WHA YU	C068-510500-A	PCB Antenna	MHF	3.84

Note: The EUT has three antennas.

For WiFi Antenna:

For IEEE 802.11a/b/g mode (1TX, 1RX):

Only Ant. 1 can be used as transmitting antenna and receiving antenna.

For IEEE 802.11n/ac mode (2TX, 2RX):

Ant. 1 and Ant. 2 will transmit/receive the same signal simultaneously.

Ant. 1 and Ant. 2 can be used as transmitting/receiving antennas.

For Bluetooth Antenna:

For Bluetooth mode (1TX, 1RX):

Only Ant. 3 can be used as transmitting antenna and receiving antenna.

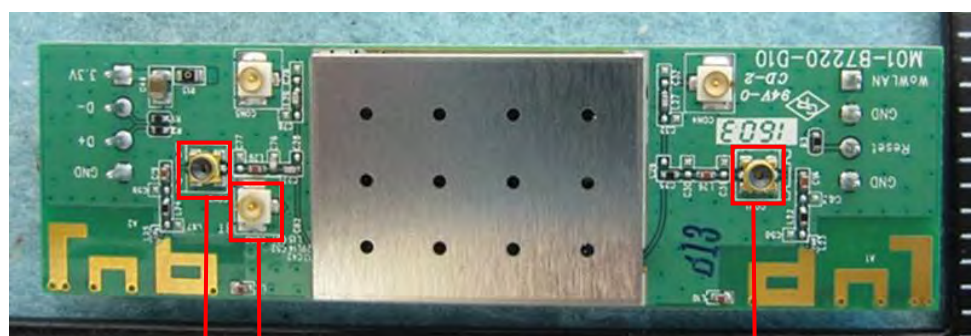

Chain 2 connect to Ant. 2
(For 2.4G and 5GHz)

Chain 3 connect to
Ant. 3 (For Bluetooth)

Chain 1 connect to Ant. 1
(For 2.4G and 5GHz)

3.4. Table for Carrier Frequencies

There are two bandwidth systems.

For 20MHz bandwidth systems, use Channel 1~Channel 11.

For 40MHz bandwidth systems, use Channel 3~Channel 9.

Frequency Band	Channel No.	Frequency	Channel No.	Frequency
2400~2483.5MHz	1	2412 MHz	7	2442 MHz
	2	2417 MHz	8	2447 MHz
	3	2422 MHz	9	2452 MHz
	4	2427 MHz	10	2457 MHz
	5	2432 MHz	11	2462 MHz
	6	2437 MHz	-	-

3.5. Table for Test Modes

Preliminary tests were performed in different data rate to find the worst radiated emission. The data rate shown in the table below is the worst-case rate with respect to the specific test item. Investigation has been done on all the possible configurations for searching the worst cases. The following table is a list of the test modes shown in this test report.

Test Items	Mode	Data Rate	Channel	Ant.
AC Power Line Conducted Emissions	Normal Link	-	-	-
Maximum Conducted Output Power	11b/CCK	1 Mbps	1/6/11	1
	11g/BPSK	6 Mbps	1/6/11	1
	11n HT20	MCS0	1/6/11	1+2
	11n HT40	MCS0	3/6/9	1+2
Power Spectral Density	11b/CCK	1 Mbps	1/6/11	1
	11g/BPSK	6 Mbps	1/6/11	1
	11n HT20	MCS0	1/6/11	1+2
	11n HT40	MCS0	3/6/9	1+2
6dB Spectrum Bandwidth	11b/CCK	1 Mbps	1/6/11	1
	11g/BPSK	6 Mbps	1/6/11	1
	11n HT20	MCS0	1/6/11	1+2
	11n HT40	MCS0	3/6/9	1+2
Radiated Emissions 9kHz~1GHz	Normal Link	-	-	-
Radiated Emissions 1GHz~10 th Harmonic	11b/CCK	1 Mbps	1/6/11	1
	11g/BPSK	6 Mbps	1/6/11	1
	11n HT20	MCS0	1/6/11	1+2
	11n HT40	MCS0	3/6/9	1+2
Band Edge Emissions	11b/CCK	1 Mbps	1/6/11	1
	11g/BPSK	6 Mbps	1/6/11	1
	11n HT20	MCS0	1/6/11	1+2
	11n HT40	MCS0	3/6/9	1+2

The following test modes were performed for all tests:

For Conducted Emission test:

Mode 1. EUT + 2.4G + BT with Ant.

Mode 2. EUT + 5G + BT with Ant.

Mode 1 is the worst case, so it was selected to record in this test report.

For Radiated Emission test (Below 1GHz):

Mode 1. EUT in X-axis + 2.4G + BT with Ant.

Mode 2. EUT in Y-axis + 2.4G + BT with Ant.

Mode 3. EUT in Z-axis + 2.4G + BT with Ant.

Mode 3 has been evaluated to be the worst case among Mode 1~3, thus measurement for Mode 4 will follow this same test mode.

Mode 4. EUT in Z-axis + 5G + BT with Ant.

Mode 3 is the worst case, so it was selected to record in this test report.

For Radiated Emission test (Above 1GHz):

The EUT was performed at X axis, Y axis and Z axis position, and the worst case was found at X axis. So the measurement will follow this same test configuration.

Mode 1. CTX - EUT in X-axis

For Radiated Emission Co-location Test:

Mode 1. 2.4GHz WLAN Function + Bluetooth Function

Mode 2. 5GHz WLAN Function + Bluetooth Function

For Co-location MPE and Radiated Emission Co-location Test:

The EUT could be applied with 2.4GHz WLAN function, 5GHz WLAN function and Bluetooth function; therefore Co-location Maximum Permissible Exposure (Please refer to FA611516) and Radiated Emission Co-location (please refer to Appendix B) tests are added for simultaneously transmit between 2.4GHz WLAN function, 5GHz WLAN function and Bluetooth function.

3.6. Table for Testing Locations

Test Site Location				
Address:	No.8, Lane 724, Bo-ai St., Jhubei City, Hsinchu County 302, Taiwan, R.O.C.			
TEL:	886-3-656-9065			
FAX:	886-3-656-9085			
Test Site No.	Site Category	Location	FCC Reg. No.	IC File No.
03CH01-CB	SAC	Hsin Chu	262045	IC 4086D
CO02-CB	Conduction	Hsin Chu	262045	IC 4086D
TH01-CB	OVEN Room	Hsin Chu	-	-

Open Area Test Site (OATS); Semi Anechoic Chamber (SAC).

3.7. Table for Supporting Units

For Test Site No: CO02-CB

Support Unit	Brand	Model	FCC ID
AP Router	Planex	GW-AP54SGX	KA220030603014-1
Bluetooth keyboard	Microsoft	1390	C3K1390
NB	DELL	E6430	DoC
Mouse	Logitech	M-U0026	DoC
Earphone	SHYARO CHI	MIC-04	N/A
Fixture	Abocom	AM7221T-X10	N/A

For Test Site No: 03CH01-CB (Below 1GHz)

Support Unit	Brand	Model	FCC ID
AP Router	Netgear	R6300V2	PY313200227
Bluetooth keyboard	iCooky	SK068	DoC
NB	DELL	E4300	DoC
Mouse	Logitech	M-U0026	DoC
Earphone	e-Power	S90W	N/A
Fixture	Abocom	AM7221T-X10	N/A

For Test Site No: 03CH01-CB (Above 1GHz)

Support Unit	Brand	Model	FCC ID
NB	DELL	E4300	DoC
Fixture	Abocom	AM7221T-X10	N/A

For Test Site No: TH01-CB

Support Unit	Brand	Model	FCC ID
NB	DELL	E4300	DoC
Fixture	Abocom	AM7221T-X10	N/A

3.8. Table for Parameters of Test Software Setting

During testing, Channel and Power Controlling Software provided by the customer was used to control the operating channel as well as the output power level. The RF output power selection is for the setting of RF output power expected by the customer and is going to be fixed on the firmware of the final end product.

Test Software Version	MT7662 QA Version 1.0.3.13					
Mode	Test Frequency (MHz)					
	NCB: 20MHz			NCB: 40MHz		
	2412 MHz	2437 MHz	2462 MHz	2422 MHz	2437 MHz	2452 MHz
802.11b	1B	1A	1C	-	-	-
802.11g	22	2C	23	-	-	-
802.11n MCS0 HT20	23/22	31/30	22/22	-	-	-
802.11n MCS0 HT40	-	-	-	21/20	24/24	1D/1C

3.9. EUT Operation during Test

The EUT was programmed to be in continuously transmitting mode.

3.10. Duty Cycle

Mode	On Time (ms)	On+Off Time (ms)	Duty Cycle (%)	Duty Factor (dB)	1/T Minimum VBW (kHz)
802.11b	8.692	8.856	98.15	0.08	0.01
802.11g	1.436	1.642	87.45	0.58	0.70
802.11n MCS0 HT20	1.344	1.560	86.15	0.65	0.74
802.11n MCS0 HT40	0.635	0.875	72.57	1.39	1.57

3.11. Test Configurations

3.11.1. AC Power Line Conduction Emissions Test Configuration

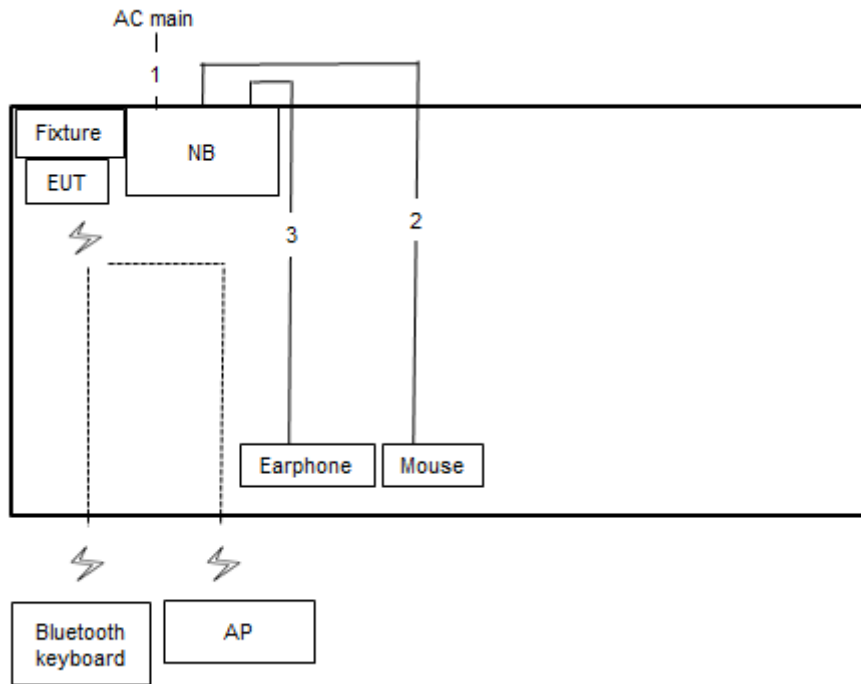

Item	Connection	Shielded	Length
1	Power cable	No	2.6m
2	USB cable	Yes	1.8m
3	Audio cable	No	1.5m

3.11.2. Radiation Emissions Test Configuration

Test Configuration: 30MHz~1GHz

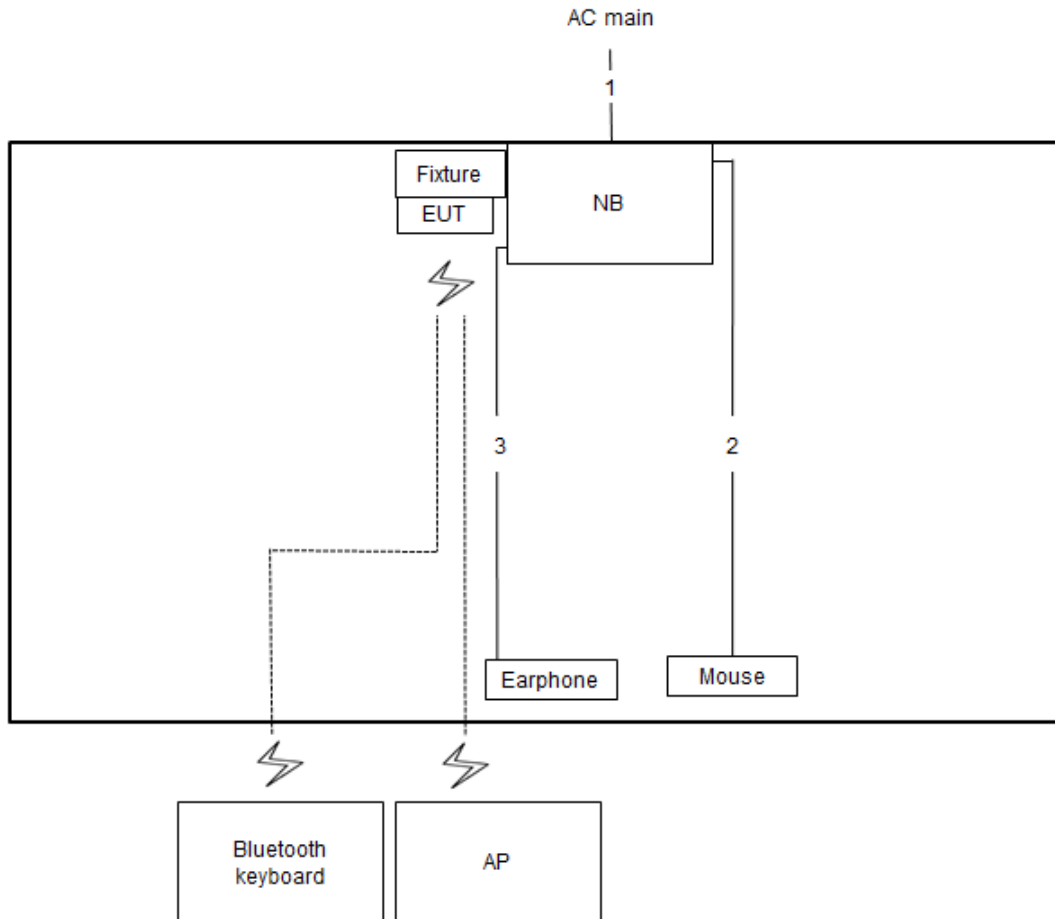

Item	Connection	Shielded	Length
1	Power cable	No	2.6m
2	USB cable	Yes	1.8m
3	Audio cable	No	1.4m

Test Configuration: above 1GHz

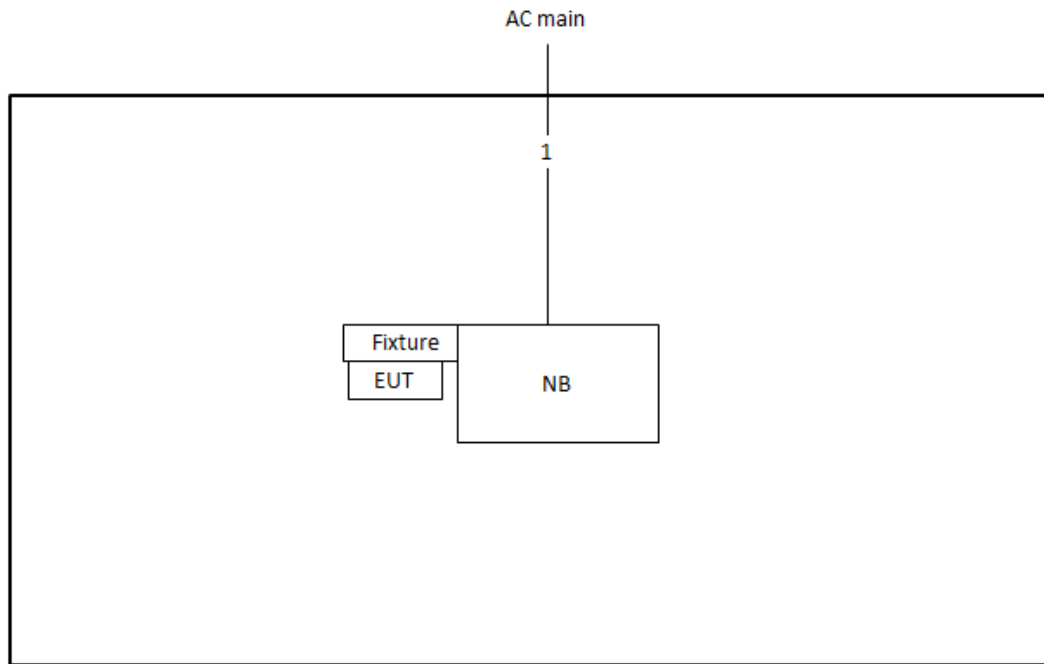

Item	Connection	Shielded	Length
1	Power cable	No	2.6m

4. TEST RESULT

4.1. AC Power Line Conducted Emissions Measurement

4.1.1. Limit

For this product which is designed to be connected to the AC power line, the radio frequency voltage that is conducted back onto the AC power line on any frequency or frequencies within the band 150 kHz to 30 MHz shall not exceed below limits table.

Frequency (MHz)	QP Limit (dBuV)	AV Limit (dBuV)
0.15~0.5	66~56	56~46
0.5~5	56	46
5~30	60	50

4.1.2. Measuring Instruments and Setting

Please refer to section 5 of equipments list in this report. The following table is the setting of the receiver.

Receiver Parameters	Setting
Attenuation	10 dB
Start Frequency	0.15 MHz
Stop Frequency	30 MHz
IF Bandwidth	9 kHz

4.1.3. Test Procedures

1. Configure the EUT according to ANSI C63.10. The EUT or host of EUT has to be placed 0.4 meter far from the conducting wall of the shielding room and at least 80 centimeters from any other grounded conducting surface.
2. Connect EUT or host of EUT to the power mains through a line impedance stabilization network (LISN).
3. All the support units are connected to the other LISNs. The LISN should provide 50uH/50ohms coupling impedance.
4. The frequency range from 150 kHz to 30 MHz was searched.
5. Set the test-receiver system to Peak Detect Function and Specified Bandwidth with Maximum Hold Mode.
6. The measurement has to be done between each power line and ground at the power terminal.

4.1.4. Test Setup Layout

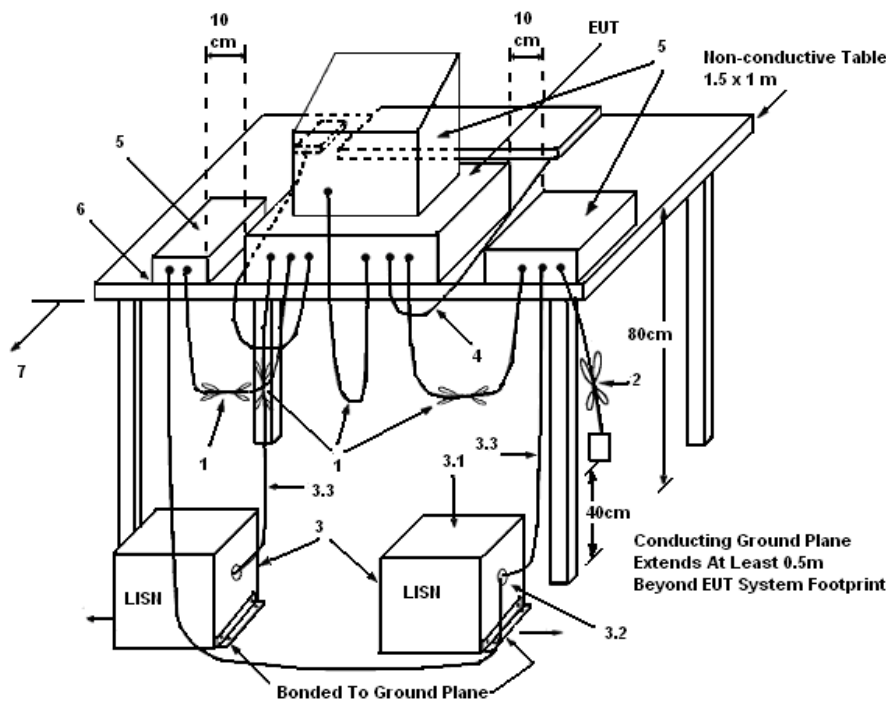

LEGEND:

- (1) Interconnecting cables that hang closer than 40 cm to the ground plane shall be folded back and forth in the center forming a bundle 30 to 40 cm long.
- (2) I/O cables that are not connected to a peripheral shall be bundled in the center. The end of the cable may be terminated, if required, using the correct terminating impedance. The overall length shall not exceed 1 m.
- (3) EUT connected to one LISN. Unused LISN measuring port connectors shall be terminated in 50 Ω . LISN can be placed on top of, or immediately beneath, reference ground plane.
- (3.1) All other equipment powered from additional LISN(s).
- (3.2) Multiple outlet strip can be used for multiple power cords of non-EUT equipment.
- (3.3) LISN at least 80 cm from nearest part of EUT chassis.
- (4) Cables of hand-operated devices, such as keyboards, mice, etc., shall be placed as for normal use.
- (5) Non-EUT components of EUT system being tested.
- (6) Rear of EUT, including peripherals, shall all be aligned and flush with rear of tabletop.
- (7) Rear of tabletop shall be 40 cm removed from a vertical conducting plane that is bonded to the ground plane.

4.1.5. Test Deviation

There is no deviation with the original standard.

4.1.6. EUT Operation during Test

The EUT was placed on the test table and programmed in normal function.

4.1.7. Results of AC Power Line Conducted Emissions Measurement

Temperature	24°C	Humidity	55%
Test Engineer	Da Deng	Phase	Line
Configuration	Normal Link		

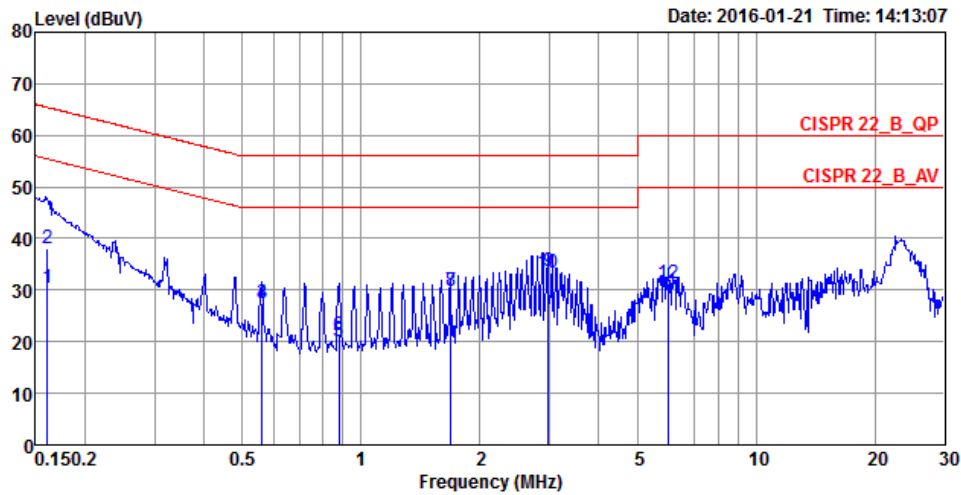

	Freq	Level	Over Limit	Limit Line	Read Level	LISN Factor	Cable Loss	Remark	Pol/Phase
	MHz	dBuV	dB	dBuV	dBuV	dB	dB		
1	0.1607	30.55	-24.88	55.43	20.43	9.96	0.16	Average	LINE
2	0.1607	38.18	-27.25	65.43	28.06	9.96	0.16	QP	LINE
3	0.5611	27.54	-18.46	46.00	17.32	10.02	0.20	Average	LINE
4	0.5611	27.55	-28.45	56.00	17.33	10.02	0.20	QP	LINE
5	0.8803	20.19	-25.81	46.00	9.96	10.04	0.19	Average	LINE
6	0.8803	21.37	-34.63	56.00	11.14	10.04	0.19	QP	LINE
7	1.6905	29.76	-16.24	46.00	19.45	10.07	0.24	Average	LINE
8	1.6905	29.92	-26.08	56.00	19.61	10.07	0.24	QP	LINE
9	2.9790	33.58	-12.42	46.00	23.19	10.10	0.29	Average	LINE
10	2.9790	33.30	-22.70	56.00	22.91	10.10	0.29	QP	LINE
11	5.9685	29.44	-20.56	50.00	18.96	10.13	0.35	Average	LINE
12	5.9685	31.35	-28.65	60.00	20.87	10.13	0.35	QP	LINE

Temperature	24°C	Humidity	55%
Test Engineer	Da Deng	Phase	Neutral
Configuration	Normal Link		

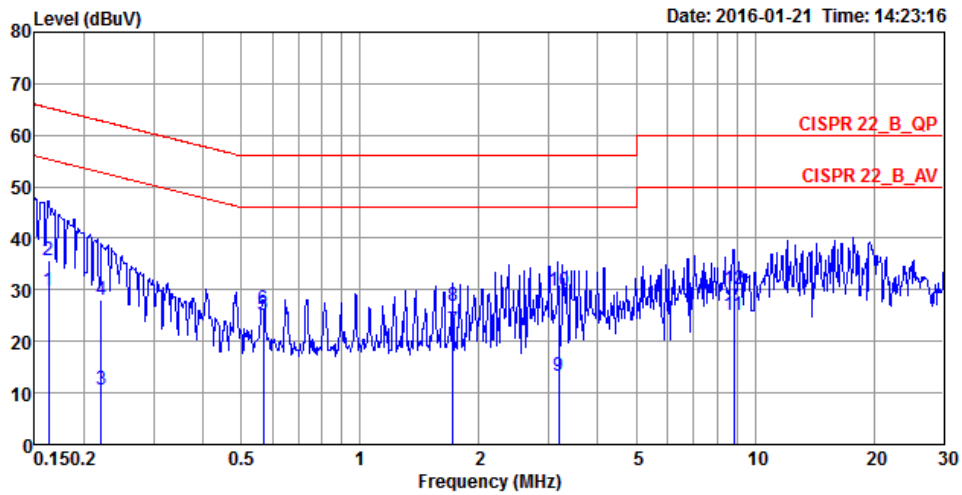

	Freq	Level	Over Limit	Limit Line	Read Level	LISN Factor	Cable Loss	Remark	Pol/Phase
	MHz	dBuV	dB	dBuV	dBuV	dB	dB		
1	0.1624	29.96	-25.38	55.34	19.84	9.96	0.16	Average	NEUTRAL
2	0.1624	35.77	-29.57	65.34	25.65	9.96	0.16	QP	NEUTRAL
3	0.2208	10.57	-42.22	52.79	0.43	9.96	0.18	Average	NEUTRAL
4	0.2208	28.02	-34.77	62.79	17.88	9.96	0.18	QP	NEUTRAL
5	0.5701	25.15	-20.85	46.00	14.98	9.97	0.20	Average	NEUTRAL
6	0.5701	26.18	-29.82	56.00	16.01	9.97	0.20	QP	NEUTRAL
7	1.7162	22.03	-23.97	46.00	11.80	9.99	0.24	Average	NEUTRAL
8	1.7162	26.95	-29.05	56.00	16.72	9.99	0.24	QP	NEUTRAL
9	3.1816	13.36	-32.64	46.00	3.05	10.01	0.30	Average	NEUTRAL
10	3.1816	29.68	-26.32	56.00	19.37	10.01	0.30	QP	NEUTRAL
11	8.8223	24.96	-25.04	50.00	14.46	10.13	0.37	Average	NEUTRAL
12	8.8223	30.02	-29.98	60.00	19.52	10.13	0.37	QP	NEUTRAL

Note:

$$\text{Level} = \text{Read Level} + \text{LISN Factor} + \text{Cable Loss.}$$

4.2. Maximum Conducted Output Power Measurement

4.2.1. Limit

The limit for output power is 30dBm.

4.2.2. Measuring Instruments and Setting

Please refer to section 5 of equipments list in this report. The following table is the setting of the power meter.

Power Meter Parameter	Setting
Bandwidth	50MHz bandwidth is greater than the EUT emission bandwidth
Detector	Average

4.2.3. Test Procedures

1. Test procedures refer KDB558074 D01 v03r04 section 9.2.3.2 Measurement using a power meter (PM).
2. Multiple antenna systems was performed in accordance with KDB 662911 D01 v02r01 Emissions Testing of Transmitters with Multiple Outputs in the Same Band.
3. This procedure provides an alternative for determining the RMS output power using a broadband RF average power meter with a thermocouple detector.

4.2.4. Test Setup Layout

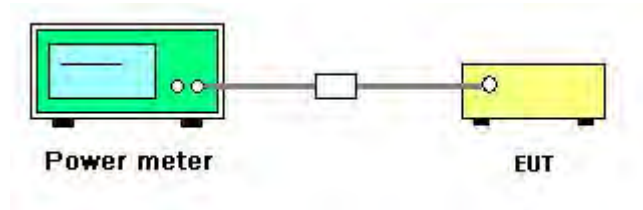

4.2.5. Test Deviation

There is no deviation with the original standard.

4.2.6. EUT Operation during Test

The EUT was programmed to be in continuously transmitting mode.

4.2.7. Test Result of Maximum Conducted Output Power

Temperature	25°C	Humidity	58%
Test Engineer	Serway Li / Peter Wu	Test Date	Jan. 26, 2016

Mode	Frequency	Conducted Power (dBm)			Max. Limit (dBm)	Result
		Ant. 1	Ant. 2	Total		
802.11b	2412 MHz	16.61			30.00	Complies
	2437 MHz	16.47			30.00	Complies
	2462 MHz	17.28			30.00	Complies
802.11g	2412 MHz	18.92			30.00	Complies
	2437 MHz	23.37			30.00	Complies
	2462 MHz	19.35			30.00	Complies

Mode	Frequency	Conducted Power (dBm)			Max. Limit (dBm)	Result
		Ant. 1	Ant. 2	Total		
802.11n MCS0 HT20	2412 MHz	17.51	17.41	20.47	30.00	Complies
	2437 MHz	23.90	22.56	26.29	30.00	Complies
	2462 MHz	17.12	17.18	20.16	30.00	Complies
802.11n MCS0 HT40	2422 MHz	16.74	16.69	19.73	30.00	Complies
	2437 MHz	18.53	18.75	21.65	30.00	Complies
	2452 MHz	14.62	14.49	17.57	30.00	Complies

4.3. Power Spectral Density Measurement

4.3.1. Limit

For digitally modulated systems, the power spectral density conducted from the intentional radiator to the antenna shall not be greater than 8 dBm in any 3 kHz band during any time interval of continuous transmission.

4.3.2. Measuring Instruments and Setting

Please refer to section 5 of equipments list in this report. The following table is the setting of the spectrum analyzer.

Spectrum Parameter	Setting
Attenuation	Auto
Span Frequency	Set the span to 1.5 times the DTS channel bandwidth.
RBW	$3 \text{ kHz} \leq \text{RBW} \leq 100\text{kHz}$
VBW	$\geq 3 \times \text{RBW}$
Detector	Peak
Trace	Max Hold
Sweep Time	Auto couple

4.3.3. Test Procedures

1. Test was performed in accordance with KDB558074 D01 v03r04 for Performing Compliance Measurements on Digital Transmission Systems (DTS) - section 10.2 Method PKPSD (peak PSD) and KDB 662911 D01 v02r01 section In-Band Power Spectral Density (PSD) Measurements option (b) Measure and sum spectral maximal across the outputs.
2. Use this procedure when the maximum conducted output power in the fundamental emission is used to demonstrate compliance. The EUT must be configured to transmit continuously at full power over the measurement duration.
3. Ensure that the number of measurement points in the sweep $\geq 2 \times \text{span}/\text{RBW}$ (use of a greater number of measurement points than this minimum requirement is recommended).
4. Use the peak marker function to determine the maximum level in any 3 kHz band segment within the fundamental EBW.
5. The resulting PSD level must be $\leq 8 \text{ dBm}$.

4.3.4. Test Setup Layout

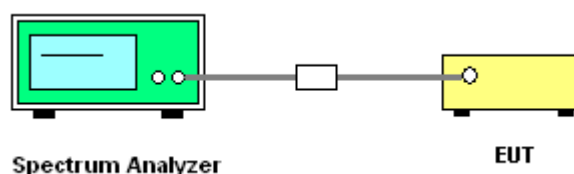

4.3.5. Test Deviation

There is no deviation with the original standard.

4.3.6. EUT Operation during Test

The EUT was programmed to be in continuously transmitting mode.

4.3.7. Test Result of Power Spectral Density

Temperature	25°C	Humidity	58%
Test Engineer	Serway Li / Peter Wu		

Mode	Frequency	Power Density (dBm/3kHz)		Power Density Limit (dBm/3kHz)	Result
		Ant. 1			
802.11b	2412 MHz	-6.79		8.00	Complies
	2437 MHz	-7.67		8.00	Complies
	2462 MHz	-6.49		8.00	Complies
802.11g	2412 MHz	-6.48		8.00	Complies
	2437 MHz	-0.41		8.00	Complies
	2462 MHz	-4.19		8.00	Complies

Mode	Frequency	Power Density (dBm/3kHz)			Power Density Limit (dBm/3kHz)	Result
		Ant. 1	Ant. 2	Total		
802.11n MCS0 HT20	2412 MHz	-7.58	-8.06	-4.80	7.77	Complies
	2437 MHz	-1.92	-2.28	0.91	7.77	Complies
	2462 MHz	-8.17	-8.95	-5.53	7.77	Complies
802.11n MCS0 HT40	2422 MHz	-11.74	-11.87	-8.79	7.77	Complies
	2437 MHz	-10.42	-10.25	-7.32	7.77	Complies
	2452 MHz	-13.58	-13.64	-10.60	7.77	Complies

Note: All the test values were listed in the report.

For plots, only the channel with worse result was shown.

$$\text{DirectionalGain} = 10 \cdot \log \left[\frac{\sum_{j=1}^{N_{SS}} \left\{ \sum_{k=1}^{N_{ANT}} g_{j,k} \right\}^2}{N_{ANT}} \right] = 6.23\text{dBi} > 6\text{dBi}, \text{ so Limit} = 8 - (6.23 - 6) = 7.77\text{dBm/3kHz}$$

Power Density Plot on Configuration IEEE 802.11b / 2462 MHz / Ant. 1



Date: 26.JAN.2016 16:20:31

Power Density Plot on Configuration IEEE 802.11g / 2437 MHz / Ant. 1

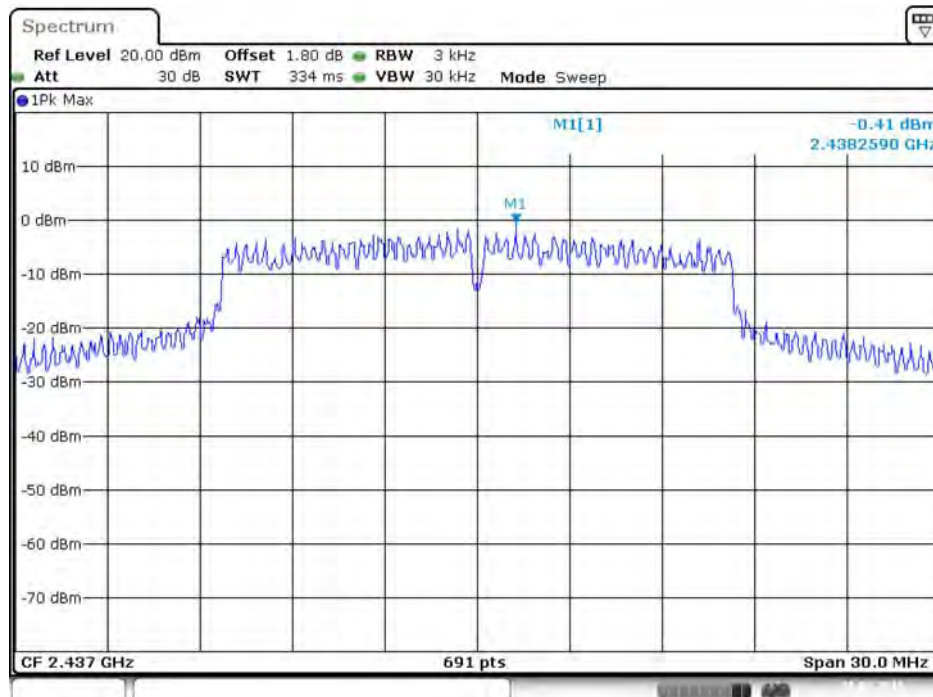

Date: 26.JAN.2016 16:23:36

Power Density Plot on Configuration IEEE 802.11n MCS0 HT20 / 2437 MHz / Ant. 1

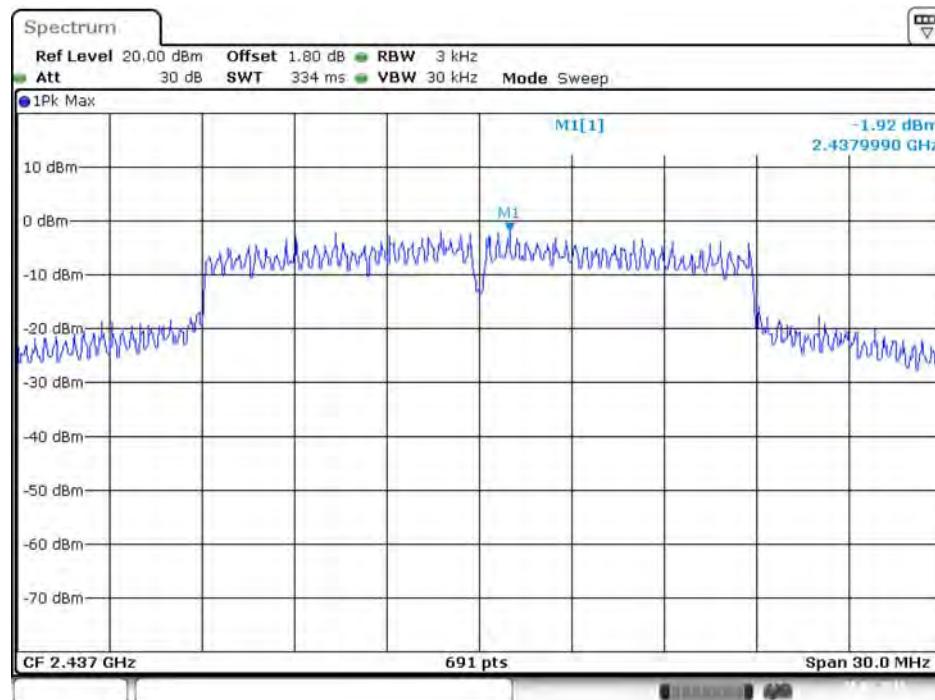

Date: 26.JAN.2016 16:35:50

Power Density Plot on Configuration IEEE 802.11n MCS0 HT20 / 2437 MHz / Ant. 2

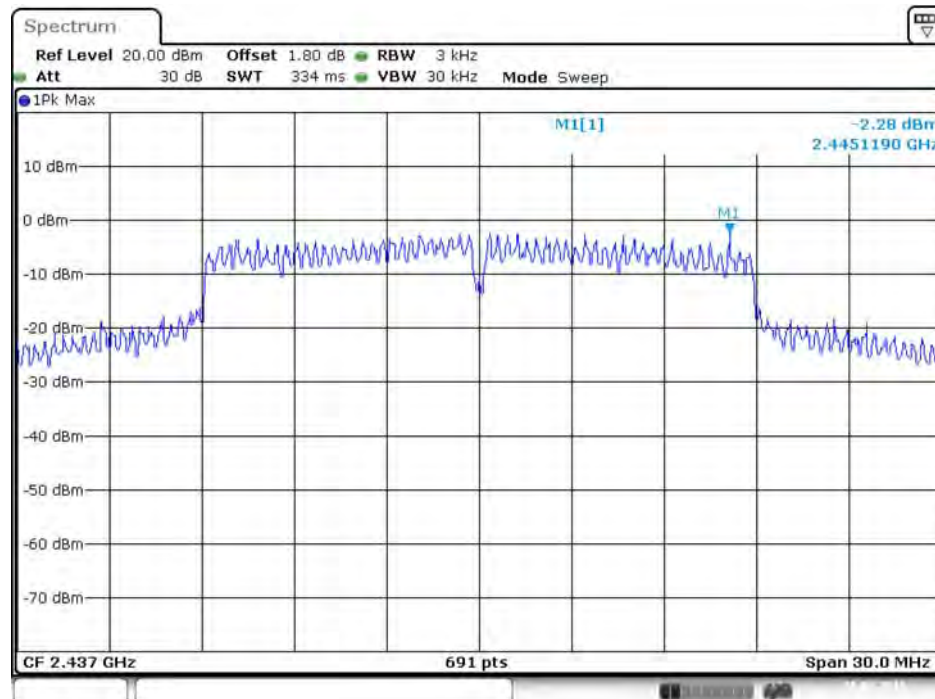

Date: 26.JAN.2016 16:35:36

Power Density Plot on Configuration IEEE 802.11n MCS0 HT40 / 2437 MHz / Ant. 1

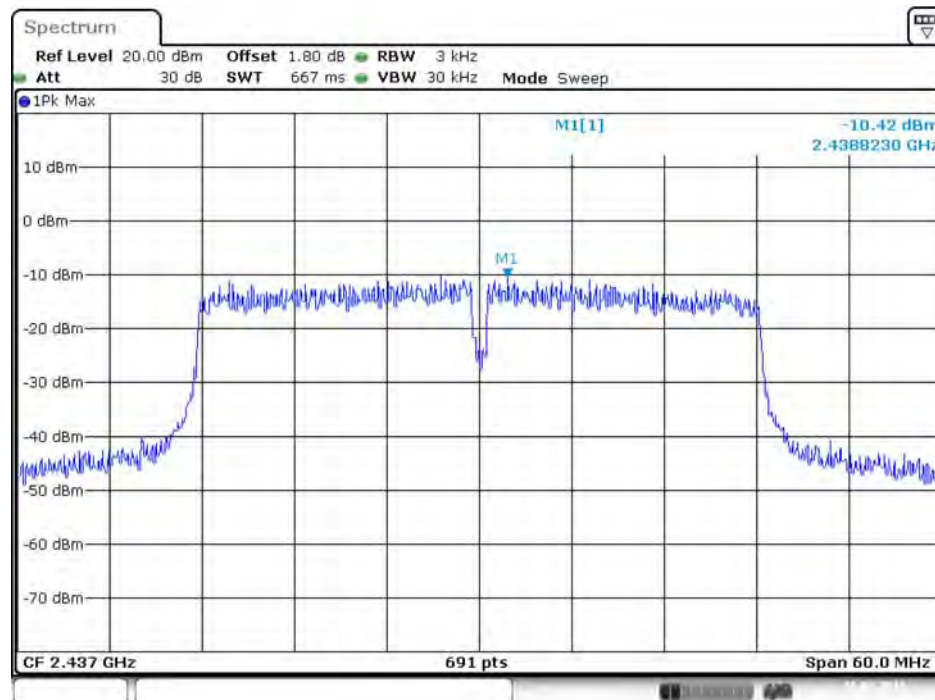

Date: 26.JAN.2016 16:44:13

Power Density Plot on Configuration IEEE 802.11n MCS0 HT40 / 2437 MHz / Ant. 2

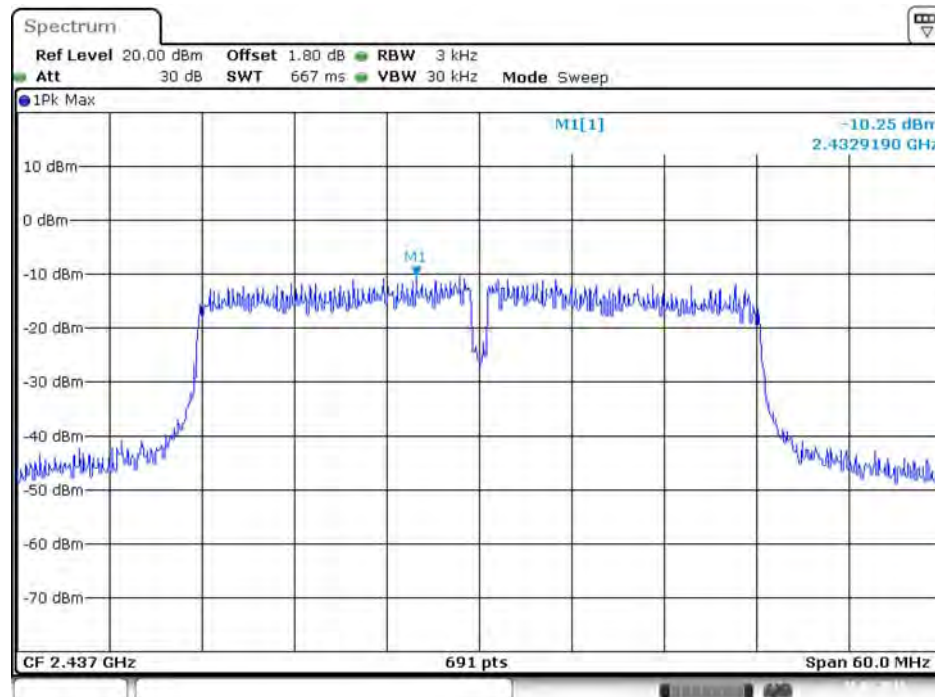

Date: 26.JAN.2016 16:44:34

4.4. 6dB Spectrum Bandwidth Measurement

4.4.1. Limit

For digital modulation systems, the minimum 6 dB bandwidth shall be at least 500 kHz.

4.4.2. Measuring Instruments and Setting

Please refer to section 5 of equipments list in this report. The following table is the setting of the Spectrum Analyzer.

6dB Spectrum Bandwidth	
Spectrum Parameters	Setting
Attenuation	Auto
Span Frequency	> 6dB Bandwidth
RBW	100kHz
VBW	$\geq 3 \times \text{RBW}$
Detector	Peak
Trace	Max Hold
Sweep Time	Auto
99% Occupied Bandwidth	
Spectrum Parameters	Setting
Span	1.5 times to 5.0 times the OBW
RBW	1 % to 5 % of the OBW
VBW	$\geq 3 \times \text{RBW}$
Detector	Peak
Trace	Max Hold

4.4.3. Test Procedures

For Radiated 6dB Bandwidth Measurement:

1. The transmitter was radiated to the spectrum analyzer in peak hold mode.
2. Test was performed in accordance with KDB558074 D01 v03r04 for Performing Compliance Measurements on Digital Transmission Systems (DTS) - section 8.0 DTS bandwidth = > 8.1 Option 1.
3. Multiple antenna system was performed in accordance with KDB 662911 D01 v02r01 Emissions Testing of Transmitters with Multiple Outputs in the Same Band.
4. Measured the spectrum width with power higher than 6dB below carrier.

4.4.4. Test Setup Layout

For Radiated 6dB Bandwidth Measurement:

This test setup layout is the same as that shown in section 4.5.4.

4.4.5. Test Deviation

There is no deviation with the original standard.

4.4.6. EUT Operation during Test

The EUT was programmed to be in continuously transmitting mode.

4.4.7. Test Result of 6dB Spectrum Bandwidth

Temperature	25°C	Humidity	58%
Test Engineer	Serway Li / Peter Wu		

Mode	Frequency	6dB Bandwidth (MHz)	99% Occupied Bandwidth (MHz)	Min. Limit (kHz)	Test Result
802.11b	2412 MHz	9.97	12.33	500	Complies
	2437 MHz	10.03	12.24	500	Complies
	2462 MHz	9.97	12.33	500	Complies
802.11g	2412 MHz	15.59	17.11	500	Complies
	2437 MHz	16.35	28.31	500	Complies
	2462 MHz	16.35	17.28	500	Complies
802.11n MCS0 HT20	2412 MHz	16.52	17.89	500	Complies
	2437 MHz	16.99	28.83	500	Complies
	2462 MHz	16.64	17.80	500	Complies
802.11n MCS0 HT40	2422 MHz	35.25	36.76	500	Complies
	2437 MHz	35.01	37.19	500	Complies
	2452 MHz	35.01	36.76	500	Complies

Note: All the test values were listed in the report.

For plots, only the channel with worse result was shown.

6 dB Bandwidth Plot on Configuration IEEE 802.11b / 2412 MHz / Ant. 1

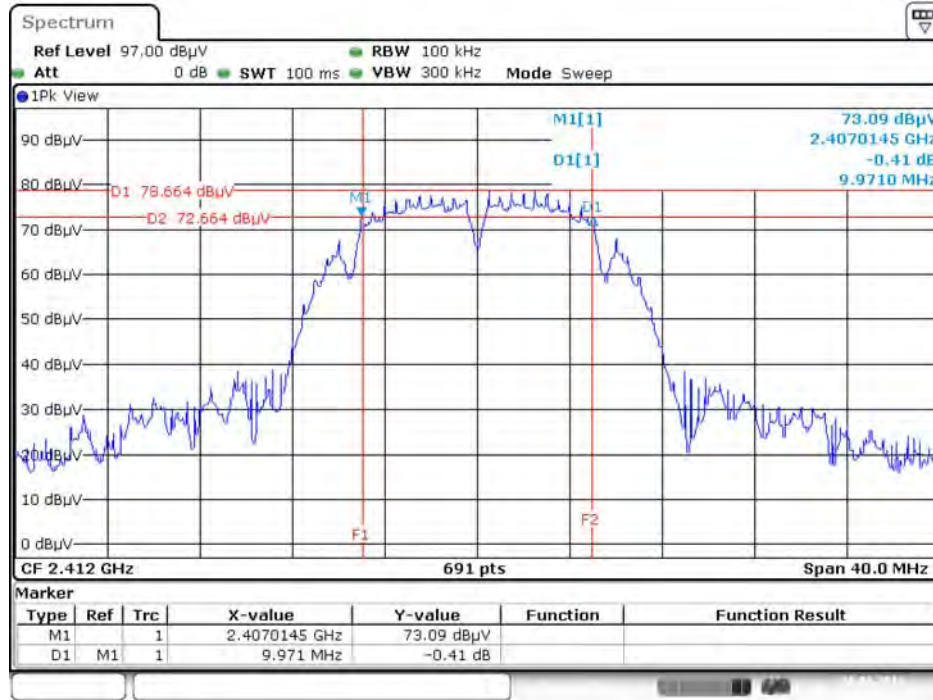

Date: 26.JAN.2016 15:31:32

99% Occupied Bandwidth Plot on Configuration IEEE 802.11b / 2412 MHz / Ant. 1

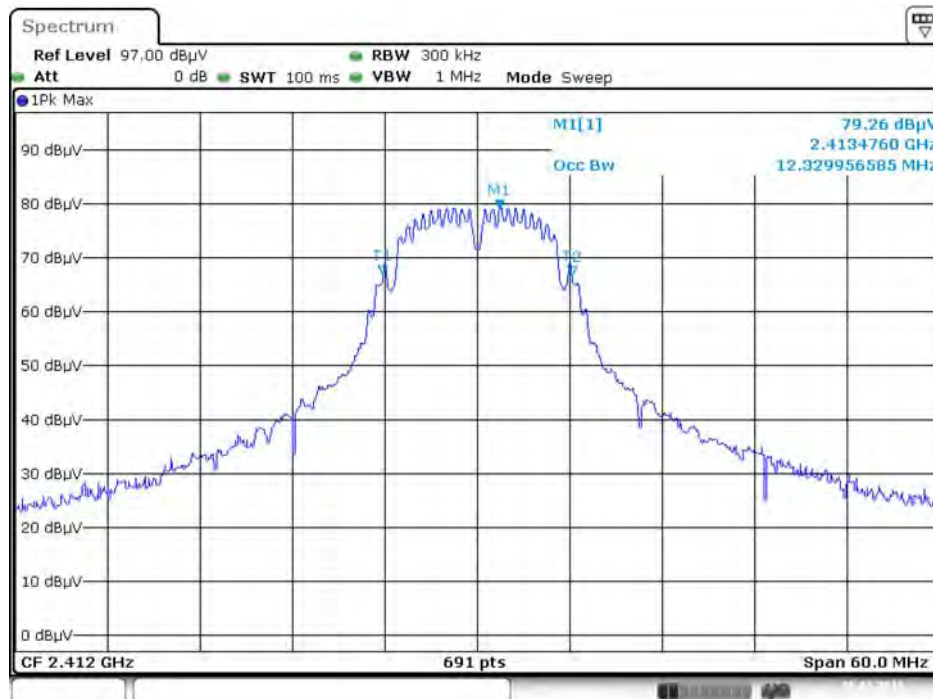

Date: 26.JAN.2016 16:05:28

6 dB Bandwidth Plot on Configuration IEEE 802.11g / 2412 MHz / Ant. 1

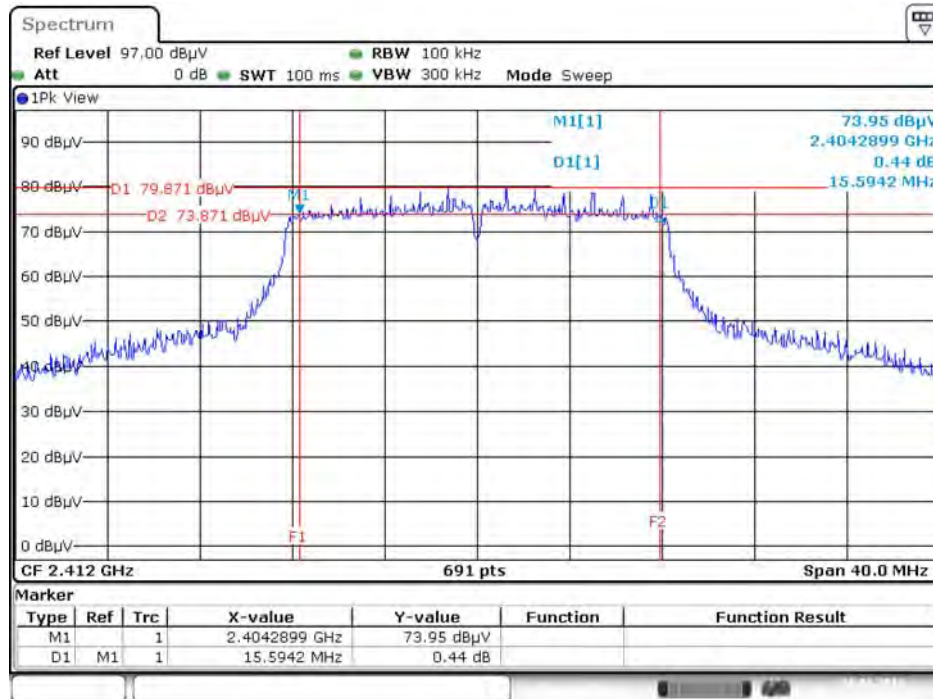

Date: 26.JAN.2016 15:34:49

99% Occupied Bandwidth Plot on Configuration IEEE 802.11g / 2437 MHz / Ant. 1



Date: 26.JAN.2016 16:02:08

6 dB Bandwidth Plot on Configuration IEEE 802.11n MCS0 HT20 / 2412 MHz / Ant. 1 + Ant. 2

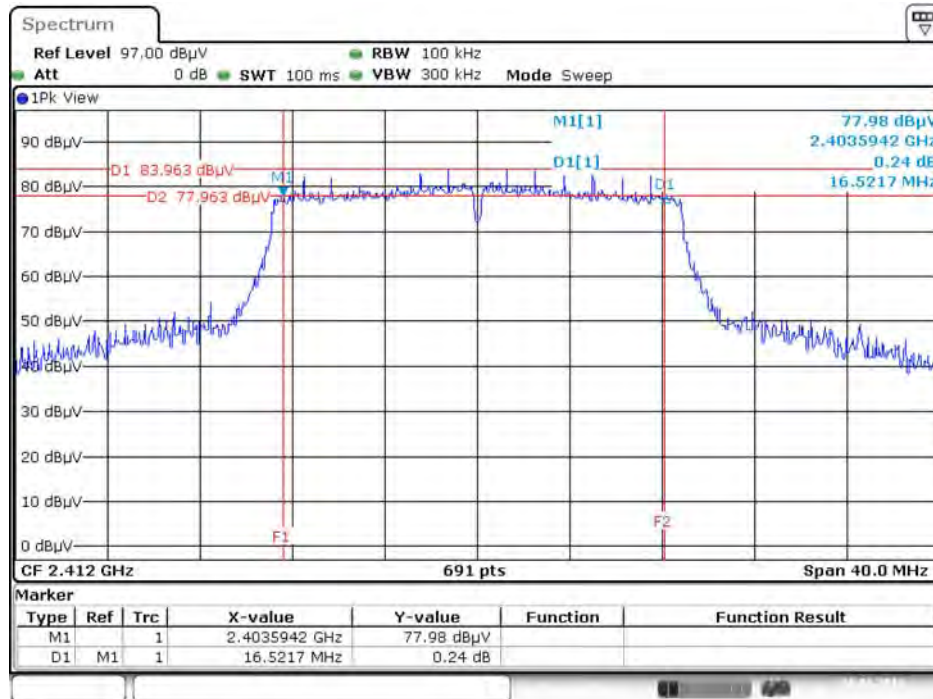

Date: 26.JAN.2016 15:38:27

99% Occupied Bandwidth Plot on Configuration IEEE 802.11n MCS0 HT20 / 2437 MHz / Ant. 1 + Ant. 2



Date: 26.JAN.2016 15:57:56

6 dB Bandwidth Plot on Configuration IEEE 802.11n MCS0 HT40 / 2437 MHz / Ant. 1 + Ant. 2

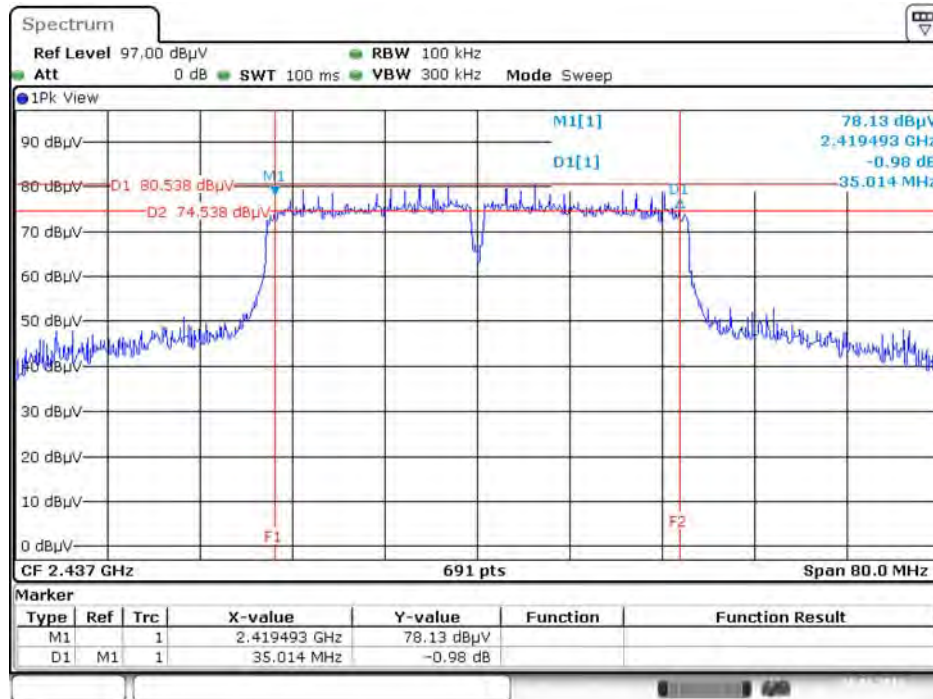

Date: 26.JAN.2016 15:43:50

99% Occupied Bandwidth Plot on Configuration IEEE 802.11n MCS0 HT40 / 2437 MHz / Ant. 1 + Ant. 2

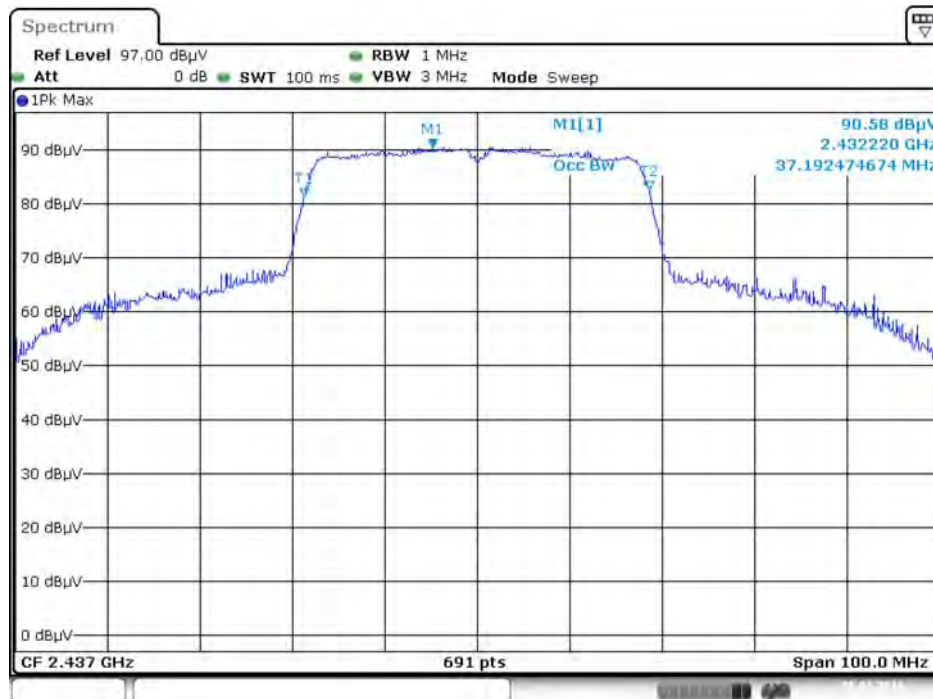

Date: 26.JAN.2016 15:53:12

4.5. Radiated Emissions Measurement

4.5.1. Limit

30dBc in any 100 kHz bandwidth outside the operating frequency band. In case the emission fall within the restricted band specified on 15.205(a), then the 15.209(a) limit in the table below has to be followed.

Frequencies (MHz)	Field Strength (micorvolts/meter)	Measurement Distance (meters)
0.009~0.490	2400/F(kHz)	300
0.490~1.705	24000/F(kHz)	30
1.705~30.0	30	30
30~88	100	3
88~216	150	3
216~960	200	3
Above 960	500	3

4.5.2. Measuring Instruments and Setting

Please refer to section 5 of equipments list in this report. The following table is the setting of spectrum analyzer and receiver.

Spectrum Parameter	Setting
Attenuation	Auto
Start Frequency	1000 MHz
Stop Frequency	10th carrier harmonic
RBW / VBW (Emission in restricted band)	1MHz / 3MHz for Peak, 1MHz / 1/T for Average
RBW / VBW (Emission in non-restricted band)	100kHz / 300kHz for peak

Receiver Parameter	Setting
Attenuation	Auto
Start ~ Stop Frequency	9kHz~150kHz / RBW 200Hz for QP
Start ~ Stop Frequency	150kHz~30MHz / RBW 9kHz for QP
Start ~ Stop Frequency	30MHz~1000MHz / RBW 120kHz for QP

4.5.3. Test Procedures

1. Configure the EUT according to ANSI C63.10. The EUT was placed on the top of the turntable 1.5 meter above ground. The phase center of the receiving antenna mounted on the top of a height-variable antenna tower was placed 1m & 3m far away from the turntable.
2. Power on the EUT and all the supporting units. The turntable was rotated by 360 degrees to determine the position of the highest radiation.
3. The height of the broadband receiving antenna was varied between one meter and four meters above ground to find the maximum emissions field strength of both horizontal and vertical polarization.
4. For each suspected emissions, the antenna tower was scan (from 1 m to 4 m) and then the turntable was rotated (from 0 degree to 360 degrees) to find the maximum reading.
5. Set the test-receiver system to Peak or CISPR quasi-peak Detect Function with specified bandwidth under Maximum Hold Mode.
6. For emissions above 1GHz, use 1MHz VBW and 3MHz RBW for peak reading. Then 1MHz RBW and 1/T VBW for average reading in spectrum analyzer.
7. If the emissions level of the EUT in peak mode was 3 dB lower than the average limit specified, then testing will be stopped and peak values of EUT will be reported, otherwise, the emissions which do not have 3 dB margin will be repeated one by one using the quasi-peak method for below 1GHz.
8. For testing above 1GHz, the emissions level of the EUT in peak mode was lower than average limit (that means the emissions level in peak mode also complies with the limit in average mode), then testing will be stopped and peak values of EUT will be reported, otherwise, the emissions will be measured in average mode again and reported.
9. In case the emission is lower than 30MHz, loop antenna has to be used for measurement and the recorded data should be QP measured by receiver. High – Low scan is not required in this case.

4.5.4. Test Setup Layout

For Radiated Emissions: 9kHz ~30MHz

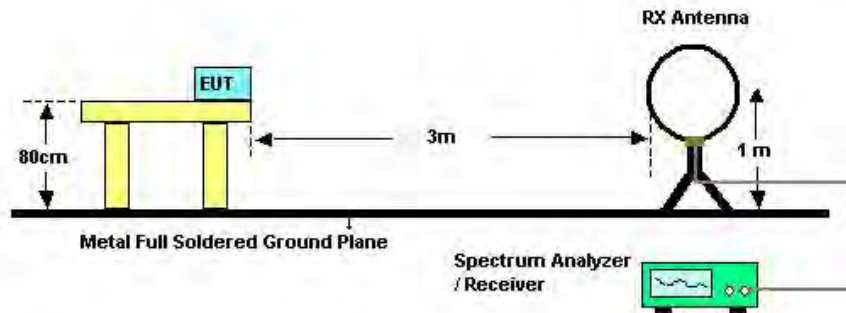

For Radiated Emissions: 30MHz~1GHz

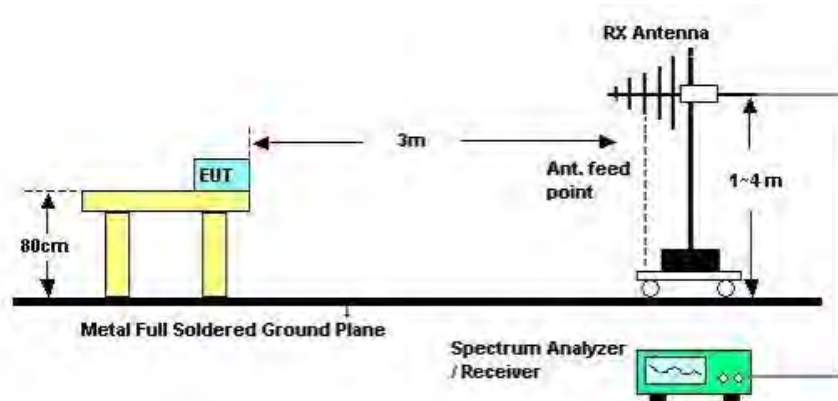

For Radiated Emissions: Above 1GHz

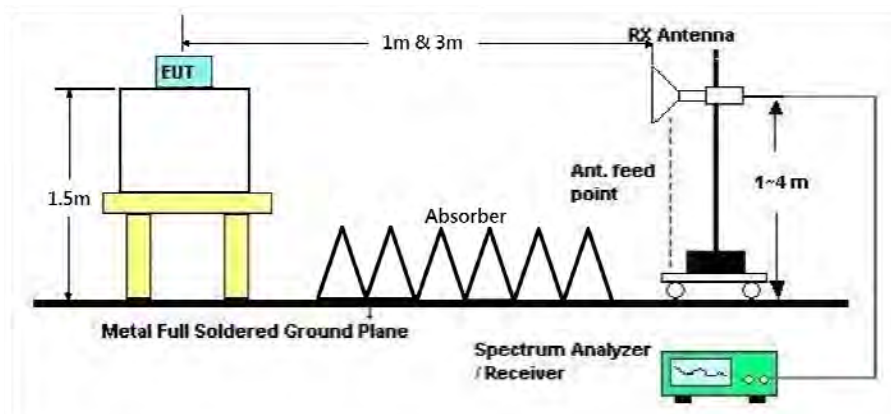

4.5.5. Test Deviation

There is no deviation with the original standard.

4.5.6. EUT Operation during Test

The EUT was programmed to be in continuously transmitting mode.

4.5.7. Results of Radiated Emissions (9kHz~30MHz)

Temperature	17°C	Humidity	38%
Test Engineer	Paul Chen	Configurations	Normal Link
Test Date	Jan. 22, 2016	Test Mode	Mode 3

Freq. (MHz)	Level (dBuV)	Over Limit (dB)	Limit Line (dBuV)	Remark
-	-	-	-	See Note

Note:

The amplitude of spurious emissions which are attenuated by more than 20 dB below the permissible value has no need to be reported.

Distance extrapolation factor = $40 \log(\text{specific distance} / \text{test distance})$ (dB);

Limit line = specific limits (dBuV) + distance extrapolation factor.

4.5.8. Results of Radiated Emissions (30MHz~1GHz)

Temperature	17°C	Humidity	38%
Test Engineer	Paul Chen	Configurations	Normal Link
Test Mode	Mode 3		

Horizontal

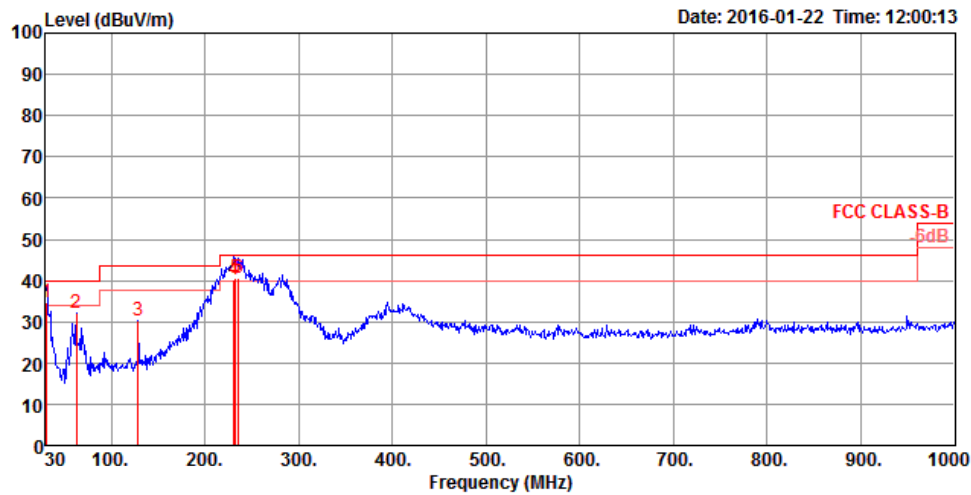

	Freq	Level	Limit	Over	Read	CableAntenna	Preamp	A/Pos	T/Pos	Remark	Pol/Phase
	MHz	dBuV/m	dBuV/m	dB	dBuV	dB	dB/m	dB	cm	deg	
1	30.97	34.75	40.00	-5.25	41.52	0.50	25.13	32.40	100	62 QP	HORIZONTAL
2	62.98	32.11	40.00	-7.89	50.35	0.70	13.46	32.40	200	187 Peak	HORIZONTAL
3	128.94	30.43	43.50	-13.07	42.99	0.98	18.83	32.37	150	236 Peak	HORIZONTAL
4	230.79	40.13	46.00	-5.87	53.56	1.30	17.58	32.31	150	80 QP	HORIZONTAL
5	232.73	40.59	46.00	-5.41	53.87	1.30	17.73	32.31	150	230 QP	HORIZONTAL
6	235.64	40.55	46.00	-5.45	53.53	1.31	18.02	32.31	200	207 QP	HORIZONTAL

Vertical

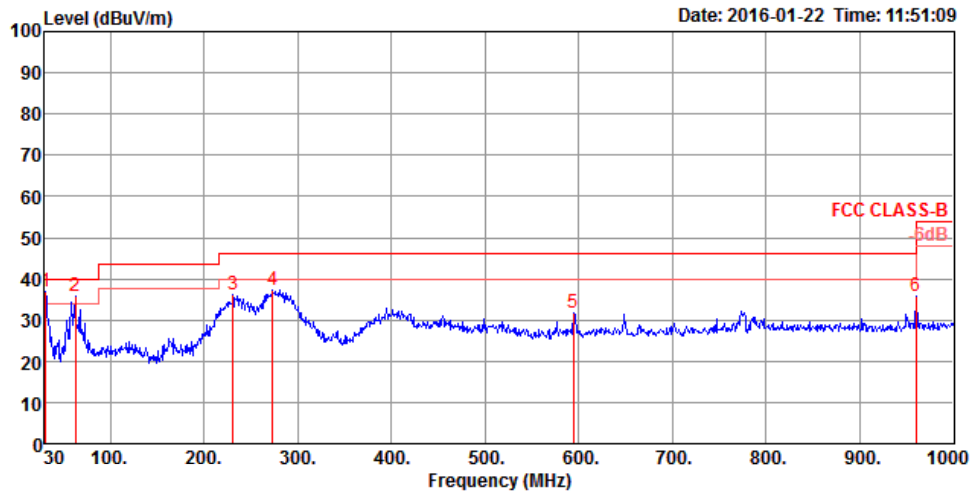

	Freq	Level	Limit Line	Over Limit	Read Level	CableAntenna Loss	Preamp Factor	A/Pos	T/Pos	Remark	Pol/Phase
	MHz	dBuV/m	dBuV/m	dB	dBuV	dB	dB/m	dB	cm	deg	
1	30.97	36.94	40.00	-3.06	43.71	0.50	25.13	32.40	100	257 Peak	VERTICAL
2	62.98	35.71	40.00	-4.29	53.95	0.70	13.46	32.40	150	266 Peak	VERTICAL
3	230.79	36.21	46.00	-9.79	49.64	1.30	17.58	32.31	200	140 Peak	VERTICAL
4	273.47	37.43	46.00	-8.57	48.68	1.41	19.63	32.29	200	2 Peak	VERTICAL
5	594.54	31.55	46.00	-14.45	36.50	2.11	25.35	32.41	100	359 Peak	VERTICAL
6	960.23	35.79	54.00	-18.21	36.09	2.69	28.20	31.19	100	126 Peak	VERTICAL

Note:

The amplitude of spurious emissions which are attenuated by more than 20 dB below the permissible value has no need to be reported.

Emission level (dBuV/m) = 20 log Emission level (uV/m).

Corrected Reading: Antenna Factor + Cable Loss + Read Level - Preamp Factor = Level.

4.5.9. Results for Radiated Emissions (1GHz~10th Harmonic)

Temperature	17°C	Humidity	38%
Test Engineer	Paul Chen	Configurations	IEEE 802.11b CH 1 / Ant. 1
Test Date	Jan. 19, 2016		

Horizontal

	Freq	Level	Limit	Over	Read	Cable	Preamp	Antenna		T/Pos	A/Pos	Remark
	MHz	dBuV/m	dBuV/m	dB	dBuV	Loss	Factor	Factor	Pol/Phase	deg	cm	
1	4823.94	53.21	74.00	-20.79	47.62	7.50	33.03	31.12	HORIZONTAL	279	189	Peak
2	4824.04	49.64	54.00	-4.36	44.05	7.50	33.03	31.12	HORIZONTAL	279	189	Average

Vertical

	Freq	Level	Limit	Over	Read	Cable	Preamp	Antenna		T/Pos	A/Pos	Remark
	MHz	dBuV/m	dBuV/m	dB	dBuV	Loss	Factor	Factor	Pol/Phase	deg	cm	
1	4823.98	53.86	54.00	-0.14	48.27	7.50	33.03	31.12	VERTICAL	26	101	Average
2	4824.02	56.31	74.00	-17.69	50.72	7.50	33.03	31.12	VERTICAL	26	101	Peak

Temperature	17°C	Humidity	38%
Test Engineer	Paul Chen	Configurations	IEEE 802.11b CH 6 / Ant. 1
Test Date	Jan. 19, 2016		

Horizontal

	Freq	Level	Limit Line	Over Limit	Read Level	Cable Loss	Preamp Factor	Antenna Factor	Pol/Phase	T/Pos	A/Pos	Remark
	MHz	dBuV/m	dBuV/m	dB	dBuV	dB	dB	dB/m		deg	cm	
1	4873.96	45.90	54.00	-8.10	40.11	7.59	33.01	31.21	HORIZONTAL	287	102	Average
2	4873.99	50.84	74.00	-23.16	45.05	7.59	33.01	31.21	HORIZONTAL	287	102	Peak

Vertical

	Freq	Level	Limit Line	Over Limit	Read Level	Cable Loss	Preamp Factor	Antenna Factor	Pol/Phase	T/Pos	A/Pos	Remark
	MHz	dBuV/m	dBuV/m	dB	dBuV	dB	dB	dB/m		deg	cm	
1	4873.96	56.56	74.00	-17.44	50.77	7.59	33.01	31.21	VERTICAL	20	160	Peak
2	4874.00	53.94	54.00	-0.06	48.15	7.59	33.01	31.21	VERTICAL	20	160	Average

Temperature	17°C	Humidity	38%
Test Engineer	Paul Chen	Configurations	IEEE 802.11b CH 11 / Ant. 1
Test Date	Jan. 19, 2016		

Horizontal

	Freq	Level	Limit Line	Over Limit	Read Level	Cable Loss	Preamp Factor	Antenna Factor	Pol/Phase	T/Pos	A/Pos	Remark
	MHz	dBuV/m	dBuV/m	dB	dBuV	dB	dB	dB/m		deg	cm	
1	4923.97	47.62	54.00	-6.38	41.65	7.67	32.99	31.29	HORIZONTAL	288	162	Average
2	4924.07	52.35	74.00	-21.65	46.38	7.67	32.99	31.29	HORIZONTAL	288	162	Peak

Vertical

	Freq	Level	Limit Line	Over Limit	Read Level	Cable Loss	Preamp Factor	Antenna Factor	Pol/Phase	T/Pos	A/Pos	Remark
	MHz	dBuV/m	dBuV/m	dB	dBuV	dB	dB	dB/m		deg	cm	
1	4923.95	57.00	74.00	-17.00	51.03	7.67	32.99	31.29	VERTICAL	23	158	Peak
2	4924.00	53.93	54.00	-0.07	47.96	7.67	32.99	31.29	VERTICAL	23	158	Average

Temperature	17°C	Humidity	38%
Test Engineer	Paul Chen	Configurations	IEEE 802.11g CH 1 / Ant. 1
Test Date	Jan. 19, 2016		

Horizontal

	Freq	Level	Limit Line	Over Limit	Read Level	Cable Loss	Preamp Factor	Antenna Factor	Pol/Phase	T/Pos	A/Pos	Remark
	MHz	dBuV/m	dBuV/m	dB	dBuV	dB	dB	dB/m		deg	cm	
1	4823.70	56.76	74.00	-17.24	51.17	7.50	33.03	31.12	HORIZONTAL	286	363	Peak
2	4823.90	44.03	54.00	-9.97	38.44	7.50	33.03	31.12	HORIZONTAL	286	363	Average

Vertical

	Freq	Level	Limit Line	Over Limit	Read Level	Cable Loss	Preamp Factor	Antenna Factor	Pol/Phase	T/Pos	A/Pos	Remark
	MHz	dBuV/m	dBuV/m	dB	dBuV	dB	dB	dB/m		deg	cm	
1	4819.40	62.53	74.00	-11.47	56.94	7.50	33.03	31.12	VERTICAL	24	159	Peak
2	4823.10	48.23	54.00	-5.77	42.64	7.50	33.03	31.12	VERTICAL	24	159	Average

Temperature	17°C	Humidity	38%
Test Engineer	Paul Chen	Configurations	IEEE 802.11g CH 6 / Ant. 1
Test Date	Jan. 19, 2016		

Horizontal

	Freq	Level	Limit Line	Over Limit	Read Level	Cable Loss	Preamp Factor	Antenna Factor	Pol/Phase	T/Pos	A/Pos	Remark
	MHz	dBuV/m	dBuV/m	dB	dBuV	dB	dB	dB/m		deg	cm	
1	4873.30	46.00	54.00	-8.00	40.21	7.59	33.01	31.21	HORIZONTAL	282	376	Average
2	4874.20	59.44	74.00	-14.56	53.65	7.59	33.01	31.21	HORIZONTAL	282	376	Peak

Vertical

	Freq	Level	Limit Line	Over Limit	Read Level	Cable Loss	Preamp Factor	Antenna Factor	Pol/Phase	T/Pos	A/Pos	Remark
	MHz	dBuV/m	dBuV/m	dB	dBuV	dB	dB	dB/m		deg	cm	
1	4874.30	66.50	74.00	-7.50	60.71	7.59	33.01	31.21	VERTICAL	20	141	Peak
2	4875.00	53.66	54.00	-0.34	47.87	7.59	33.01	31.21	VERTICAL	20	141	Average

Temperature	17°C	Humidity	38%
Test Engineer	Paul Chen	Configurations	IEEE 802.11g CH 11 / Ant. 1
Test Date	Jan. 19, 2016		

Horizontal

	Freq	Level	Limit Line	Over Limit	Read Level	Cable Loss	Preamp Factor	Antenna Factor	Pol/Phase	T/Pos	A/Pos	Remark
	MHz	dBuV/m	dBuV/m	dB	dBuV	dB	dB	dB/m		deg	cm	
1	4921.68	39.41	54.00	-14.59	33.48	7.65	32.99	31.27	HORIZONTAL	289	345	Average
2	4923.04	52.82	74.00	-21.18	46.89	7.65	32.99	31.27	HORIZONTAL	289	345	Peak

Vertical

	Freq	Level	Limit Line	Over Limit	Read Level	Cable Loss	Preamp Factor	Antenna Factor	Pol/Phase	T/Pos	A/Pos	Remark
	MHz	dBuV/m	dBuV/m	dB	dBuV	dB	dB	dB/m		deg	cm	
1	4921.20	57.59	74.00	-16.41	51.66	7.65	32.99	31.27	VERTICAL	27	132	Peak
2	4923.76	44.21	54.00	-9.79	38.24	7.67	32.99	31.29	VERTICAL	27	132	Average

Temperature	17°C	Humidity	38%
Test Engineer	Paul Chen	Configurations	IEEE 802.11n MCS0 HT20 CH 1 / Ant. 1 + Ant. 2
Test Date	Jan. 19, 2016		

Horizontal

	Freq	Level	Limit	Over	Read	Cable	Preamp	Antenna		T/Pos	A/Pos	Remark
	MHz	dBuV/m	dBuV/m	dB	dBuV	dB	dB	dB/m	Pol/Phase	deg	cm	
1	4819.04	33.98	54.00	-20.02	28.39	7.50	33.03	31.12	HORIZONTAL	79	150	Average
2	4819.52	45.54	74.00	-28.46	39.95	7.50	33.03	31.12	HORIZONTAL	79	150	Peak

Vertical

	Freq	Level	Limit	Over	Read	Cable	Preamp	Antenna		T/Pos	A/Pos	Remark
	MHz	dBuV/m	dBuV/m	dB	dBuV	dB	dB	dB/m	Pol/Phase	deg	cm	
1	4823.60	50.95	74.00	-23.05	45.36	7.50	33.03	31.12	VERTICAL	26	400	Peak
2	4823.76	38.46	54.00	-15.54	32.87	7.50	33.03	31.12	VERTICAL	26	400	Average

Temperature	17°C	Humidity	38%
Test Engineer	Paul Chen	Configurations	IEEE 802.11n MCS0 HT20 CH 6 / Ant. 1 + Ant. 2
Test Date	Jan. 19, 2016		

Horizontal

	Freq	Level	Limit	Over	Read	Cable	Preamp	Antenna		T/Pos	A/Pos	Remark
	MHz	dBuV/m	dBuV/m	dB	dBuV	Loss	Factor	Factor	Pol/Phase	deg	cm	
1	4873.04	41.07	54.00	-12.93	35.28	7.59	33.01	31.21	HORIZONTAL	288	100	Average
2	4874.80	53.81	74.00	-20.19	48.02	7.59	33.01	31.21	HORIZONTAL	288	100	Peak

Vertical

	Freq	Level	Limit	Over	Read	Cable	Preamp	Antenna		T/Pos	A/Pos	Remark
	MHz	dBuV/m	dBuV/m	dB	dBuV	Loss	Factor	Factor	Pol/Phase	deg	cm	
1	4873.68	46.62	54.00	-7.38	40.83	7.59	33.01	31.21	VERTICAL	24	142	Average
2	4876.56	59.19	74.00	-14.81	53.40	7.59	33.01	31.21	VERTICAL	24	142	Peak

Temperature	17°C	Humidity	38%
Test Engineer	Paul Chen	Configurations	IEEE 802.11n MCS0 HT20 CH 11 / Ant. 1 + Ant. 2
Test Date	Jan. 19, 2016		

Horizontal

	Freq	Level	Limit	Over	Read	Cable	Preamp	Antenna		T/Pos	A/Pos	Remark
	MHz	dBuV/m	dBuV/m	dB	dBuV	Loss	Factor	Factor	Pol/Phase	deg	cm	
1	4924.24	42.17	54.00	-11.83	36.20	7.67	32.99	31.29	HORIZONTAL	216	306	Average
2	4928.08	55.74	74.00	-18.26	49.76	7.67	32.98	31.29	HORIZONTAL	216	306	Peak

Vertical

	Freq	Level	Limit	Over	Read	Cable	Preamp	Antenna		T/Pos	A/Pos	Remark
	MHz	dBuV/m	dBuV/m	dB	dBuV	Loss	Factor	Factor	Pol/Phase	deg	cm	
1	4925.92	43.01	54.00	-10.99	37.03	7.67	32.98	31.29	VERTICAL	21	286	Average
2	4927.60	56.35	74.00	-17.65	50.37	7.67	32.98	31.29	VERTICAL	21	286	Peak

Temperature	17°C	Humidity	38%
Test Engineer	Paul Chen	Configurations	IEEE 802.11n MCS0 HT40 CH 3 / Ant. 1 + Ant. 2
Test Date	Jan. 19, 2016		

Horizontal

	Freq	Level	Limit	Over	Read	Cable	Preamp	Antenna		T/Pos	A/Pos	Remark
	MHz	dBuV/m	dBuV/m	dB	dBuV	dB	dB	dB/m	Pol/Phase	deg	cm	
1	4913.20	33.47	54.00	-20.53	27.54	7.65	32.99	31.27	HORIZONTAL	333	156	Average
2	4914.56	46.20	74.00	-27.80	40.27	7.65	32.99	31.27	HORIZONTAL	333	156	Peak

Vertical

	Freq	Level	Limit	Over	Read	Cable	Preamp	Antenna		T/Pos	A/Pos	Remark
	MHz	dBuV/m	dBuV/m	dB	dBuV	dB	dB	dB/m	Pol/Phase	deg	cm	
1	4915.92	33.45	54.00	-20.55	27.52	7.65	32.99	31.27	VERTICAL	151	152	Average
2	4928.08	46.50	74.00	-27.50	40.52	7.67	32.98	31.29	VERTICAL	151	152	Peak

Temperature	17°C	Humidity	38%
Test Engineer	Paul Chen	Configurations	IEEE 802.11n MCS0 HT40 CH 6 / Ant. 1 + Ant. 2
Test Date	Jan. 19, 2016		

Horizontal

	Freq	Level	Limit	Over	Read	Cable	Preamp	Antenna		T/Pos	A/Pos	Remark
	MHz	dBuV/m	dBuV/m	dB	dBuV	dB	dB	dB/m	Pol/Phase	deg	cm	
1	4873.16	43.50	54.00	-10.50	37.71	7.59	33.01	31.21	HORIZONTAL	220	308	Average
2	4879.46	58.20	74.00	-15.80	52.40	7.59	33.00	31.21	HORIZONTAL	220	308	Peak

Vertical

	Freq	Level	Limit	Over	Read	Cable	Preamp	Antenna		T/Pos	A/Pos	Remark
	MHz	dBuV/m	dBuV/m	dB	dBuV	dB	dB	dB/m	Pol/Phase	deg	cm	
1	4864.06	58.83	74.00	-15.17	53.09	7.57	33.01	31.18	VERTICAL	29	281	Peak
2	4874.28	44.02	54.00	-9.98	38.23	7.59	33.01	31.21	VERTICAL	29	281	Average

Temperature	17°C	Humidity	38%
Test Engineer	Paul Chen	Configurations	IEEE 802.11n MCS0 HT40 CH 9 / Ant. 1 + Ant. 2
Test Date	Jan. 19, 2016		

Horizontal

	Freq	Level	Limit Line	Over Limit	Read Level	Cable Loss	Preamp Factor	Antenna Factor	Pol/Phase	T/Pos	A/Pos	Remark
	MHz	dBuV/m	dBuV/m	dB	dBuV	dB	dB	dB/m		deg	cm	
1	4876.28	41.27	74.00	-32.73	35.48	7.59	33.01	31.21	HORIZONTAL	87	227	Peak
2	4905.12	33.70	54.00	-20.30	27.81	7.63	32.99	31.25	HORIZONTAL	87	227	Average

Vertical

	Freq	Level	Limit Line	Over Limit	Read Level	Cable Loss	Preamp Factor	Antenna Factor	Pol/Phase	T/Pos	A/Pos	Remark
	MHz	dBuV/m	dBuV/m	dB	dBuV	dB	dB	dB/m		deg	cm	
1	4876.10	34.89	54.00	-19.11	29.09	7.59	33.00	31.21	VERTICAL	356	156	Average
2	4876.10	45.89	74.00	-28.11	40.09	7.59	33.00	31.21	VERTICAL	356	156	Peak

Note:

The amplitude of spurious emissions that are attenuated by more than 20dB below the permissible value has no need to be reported.

Emission level (dBuV/m) = 20 log Emission level (uV/m).

Corrected Reading: Antenna Factor + Cable Loss + Read Level - Preamp Factor = Level.

4.6. Emissions Measurement

4.6.1. Limit

30dBc in any 100 kHz bandwidth outside the operating frequency band. In case the emission fall within the restricted band specified on 15.205(a), then the 15.209(a) limit in the table below has to be followed.

Frequencies (MHz)	Field Strength (micorvolts/meter)	Measurement Distance (meters)
0.009~0.490	2400/F(kHz)	300
0.490~1.705	24000/F(kHz)	30
1.705~30.0	30	30
30~88	100	3
88~216	150	3
216~960	200	3
Above 960	500	3

4.6.2. Measuring Instruments and Setting

Please refer to section 5 of equipments list in this report. The following table is the setting of the spectrum analyzer.

Spectrum Parameter	Setting
Attenuation	Auto
Span Frequency	100 MHz
RBW / VBW (Emission in restricted band)	1MHz / 3MHz for Peak, 1MHz / 1/T for Average
RBW / VBW (30dBc in any 100 kHz bandwidth emission)	100 kHz / 300 kHz for Peak

4.6.3. Test Procedures

For Radiated band edges Measurement:

1. The test procedure is the same as section 4.5.3.

For Radiated Out of Band Emission Measurement:

1. Test was performed in accordance with KDB558074 D01 v03r04 for Performing Compliance Measurements on Digital Transmission Systems (DTS) Operating Under §15.247 section 10.1 Unwanted Emissions into Non-Restricted Frequency Bands Measurement Procedure.

4.6.4. Test Setup Layout

For Radiated band edges Measurement:

This test setup layout is the same as that shown in section 4.5.4.

For Radiated Out of Band Emission Measurement:

This test setup layout is the same as that shown in section 4.5.4.

4.6.5. Test Deviation

There is no deviation with the original standard.

4.6.6. EUT Operation during Test

The EUT was programmed to be in continuously transmitting mode.

4.6.7. Test Result of Band Edge and Fundamental Emissions

Temperature	17°C	Humidity	38%
Test Engineer	Paul Chen	Configurations	IEEE 802.11b CH 1, 6, 11 / Ant. 1
Test Date	Jan. 19, 2016		

Channel 1

	Freq	Level	Limit	Over	Read	Cable	Preamp	Antenna	Pol/Phase	T/Pos	A/Pos	Remark
	MHz	dBuV/m	dBuV/m	dB	dBuV	dB	dB	dB/m		deg	cm	
1	2386.80	45.15	54.00	-8.85	12.87	5.23	0.00	27.05	HORIZONTAL	205	261	Average
2	2389.20	57.06	74.00	-16.94	24.78	5.23	0.00	27.05	HORIZONTAL	205	261	Peak
3	2409.40	99.10			66.74	5.26	0.00	27.10	HORIZONTAL	205	261	Peak
4	2410.40	95.61			63.25	5.26	0.00	27.10	HORIZONTAL	205	261	Average

Item 3, 4 are the fundamental frequency at 2412 MHz.

Channel 6

	Freq	Level	Limit	Over	Read	Cable	Preamp	Antenna	Pol/Phase	T/Pos	A/Pos	Remark
	MHz	dBuV/m	dBuV/m	dB	dBuV	dB	dB	dB/m		deg	cm	
1	2345.40	56.66	74.00	-17.34	24.51	5.19	0.00	26.96	VERTICAL	339	260	Peak
2	2389.80	44.80	54.00	-9.20	12.52	5.23	0.00	27.05	VERTICAL	339	260	Average
3	2435.40	94.42			61.98	5.28	0.00	27.16	VERTICAL	339	260	Average
4	2435.40	98.07			65.63	5.28	0.00	27.16	VERTICAL	339	260	Peak
5	2483.50	45.13	54.00	-8.87	12.53	5.33	0.00	27.27	VERTICAL	339	260	Average
6	2491.50	57.41	74.00	-16.59	24.79	5.34	0.00	27.28	VERTICAL	339	260	Peak

Item 3, 4 are the fundamental frequency at 2437 MHz.

Channel 11

	Freq	Level	Limit	Over	Read	Cable	Preamp	Antenna	Pol/Phase	T/Pos	A/Pos	Remark
	MHz	dBuV/m	dBuV/m	dB	dBuV	dB	dB	dB/m		deg	cm	
1	2463.00	100.12			67.59	5.31	0.00	27.22	VERTICAL	343	255	Peak
2	2463.80	96.67			64.14	5.31	0.00	27.22	VERTICAL	343	255	Average
3	2483.50	45.64	54.00	-8.36	13.04	5.33	0.00	27.27	VERTICAL	343	255	Average
4	2491.80	56.97	74.00	-17.03	24.35	5.34	0.00	27.28	VERTICAL	343	255	Peak

Item 1, 2 are the fundamental frequency at 2462 MHz.

Temperature	17°C	Humidity	38%
Test Engineer	Paul Chen	Configurations	IEEE 802.11g CH 1, 6, 11 / Ant. 1
Test Date	Jan. 19, 2016		

Channel 1

	Freq	Level	Limit	Over	Read	Cable	Preamp	Antenna		T/Pos	A/Pos	Remark
	MHz	dBuV/m	dBuV/m	dB	dBuV	dB	dB	dB/m	Pol/Phase	deg	cm	
1	2390.00	53.85	54.00	-0.15	21.57	5.23	0.00	27.05	HORIZONTAL	200	256	Average
2	2390.00	69.98	74.00	-4.02	37.70	5.23	0.00	27.05	HORIZONTAL	200	256	Peak
3	2410.40	104.67			72.31	5.26	0.00	27.10	HORIZONTAL	200	256	Peak
4	2411.00	95.77			63.41	5.26	0.00	27.10	HORIZONTAL	200	256	Average

Item 3, 4 are the fundamental frequency at 2412 MHz.

Channel 6

	Freq	Level	Limit	Over	Read	Cable	Preamp	Antenna		T/Pos	A/Pos	Remark
	MHz	dBuV/m	dBuV/m	dB	dBuV	dB	dB	dB/m	Pol/Phase	deg	cm	
1	2387.40	46.39	54.00	-7.61	14.11	5.23	0.00	27.05	VERTICAL	2	253	Average
2	2387.40	56.84	74.00	-17.16	24.56	5.23	0.00	27.05	VERTICAL	2	253	Peak
3	2435.80	98.48			66.04	5.28	0.00	27.16	VERTICAL	2	253	Average
4	2436.20	107.96			75.52	5.28	0.00	27.16	VERTICAL	2	253	Peak
5	2483.50	48.64	54.00	-5.36	16.04	5.33	0.00	27.27	VERTICAL	2	253	Average
6	2487.00	62.99	74.00	-11.01	30.39	5.33	0.00	27.27	VERTICAL	2	253	Peak

Item 3, 4 are the fundamental frequency at 2437 MHz.

Channel 11

	Freq	Level	Limit	Over	Read	Cable	Preamp	Antenna		T/Pos	A/Pos	Remark
	MHz	dBuV/m	dBuV/m	dB	dBuV	dB	dB	dB/m	Pol/Phase	deg	cm	
1	2461.20	96.17			63.64	5.31	0.00	27.22	VERTICAL	345	253	Average
2	2465.20	105.64			73.11	5.31	0.00	27.22	VERTICAL	345	253	Peak
3	2483.50	53.65	54.00	-0.35	21.05	5.33	0.00	27.27	VERTICAL	345	253	Average
4	2483.50	70.46	74.00	-3.54	37.86	5.33	0.00	27.27	VERTICAL	345	253	Peak

Item 1, 2 are the fundamental frequency at 2462 MHz.

Temperature	17°C	Humidity	38%
Test Engineer	Paul Chen	Configurations	IEEE 802.11n MCS0 HT20 CH 1, 6, 11 / Ant. 1 + Ant. 2
Test Date	Jan. 19, 2016		

Channel 1

	Freq	Level	Limit Line	Over Limit	Read Level	Cable Loss	Preamp Factor	Antenna Factor	Pol/Phase	T/Pos	A/Pos	Remark
	MHz	dBuV/m	dBuV/m	dB	dBuV	dB	dB	dB/m		deg	cm	
1	2389.60	67.42	74.00	-6.58	35.14	5.23	0.00	27.05	VERTICAL	318	270	Peak
2	2390.00	53.84	54.00	-0.16	21.56	5.23	0.00	27.05	VERTICAL	318	270	Average
3	2412.20	107.11			74.74	5.26	0.00	27.11	VERTICAL	318	270	Peak
4	2413.40	97.94			65.57	5.26	0.00	27.11	VERTICAL	318	270	Average

Item 3, 4 are the fundamental frequency at 2412 MHz.

Channel 6

	Freq	Level	Limit Line	Over Limit	Read Level	Cable Loss	Preamp Factor	Antenna Factor	Pol/Phase	T/Pos	A/Pos	Remark
	MHz	dBuV/m	dBuV/m	dB	dBuV	dB	dB	dB/m		deg	cm	
1	2388.60	61.25	74.00	-12.75	28.97	5.23	0.00	27.05	VERTICAL	326	289	Peak
2	2390.00	49.84	54.00	-4.16	17.56	5.23	0.00	27.05	VERTICAL	326	289	Average
3	2434.60	113.01			80.57	5.28	0.00	27.16	VERTICAL	326	289	Peak
4	2438.60	103.05			70.61	5.28	0.00	27.16	VERTICAL	326	289	Average
5	2483.80	50.70	54.00	-3.30	18.10	5.33	0.00	27.27	VERTICAL	326	289	Average
6	2484.20	67.15	74.00	-6.85	34.55	5.33	0.00	27.27	VERTICAL	326	289	Peak

Item 3, 4 are the fundamental frequency at 2437 MHz.

Channel 11

	Freq	Level	Limit Line	Over Limit	Read Level	Cable Loss	Preamp Factor	Antenna Factor	Pol/Phase	T/Pos	A/Pos	Remark
	MHz	dBuV/m	dBuV/m	dB	dBuV	dB	dB	dB/m		deg	cm	
1	2462.80	98.64			66.11	5.31	0.00	27.22	VERTICAL	292	314	Average
2	2465.00	107.87			75.34	5.31	0.00	27.22	VERTICAL	292	314	Peak
3	2483.50	53.78	54.00	-0.22	21.18	5.33	0.00	27.27	VERTICAL	292	314	Average
4	2484.20	71.55	74.00	-2.45	38.95	5.33	0.00	27.27	VERTICAL	292	314	Peak

Item 1, 2 are the fundamental frequency at 2462 MHz.

Temperature	17°C	Humidity	38%
Test Engineer	Paul Chen	Configurations	IEEE 802.11n MCS0 HT40 CH 3, 6, 9 / Ant. 1 + Ant. 2
Test Date	Jan. 19, 2016		

Channel 3

	Freq	Level	Limit Line	Over Limit	Read Level	Cable Loss	Preamp Factor	Antenna Factor	Pol/Phase	T/Pos	A/Pos	Remark
	MHz	dBuV/m	dBuV/m	dB	dBuV	dB	dB	dB/m		deg	cm	
1	2389.20	70.35	74.00	-3.65	38.07	5.23	0.00	27.05	VERTICAL	290	348	Peak
2	2389.60	53.81	54.00	-0.19	21.53	5.23	0.00	27.05	VERTICAL	290	348	Average
3	2420.00	105.14			72.74	5.27	0.00	27.13	VERTICAL	290	348	Peak
4	2423.20	94.85			62.45	5.27	0.00	27.13	VERTICAL	290	348	Average

Item 3, 4 are the fundamental frequency at 2422 MHz.

Channel 6

	Freq	Level	Limit Line	Over Limit	Read Level	Cable Loss	Preamp Factor	Antenna Factor	Pol/Phase	T/Pos	A/Pos	Remark
	MHz	dBuV/m	dBuV/m	dB	dBuV	dB	dB	dB/m		deg	cm	
1	2390.00	53.54	54.00	-0.46	21.26	5.23	0.00	27.05	VERTICAL	284	313	Average
2	2390.00	69.19	74.00	-4.81	36.91	5.23	0.00	27.05	VERTICAL	284	313	Peak
3	2420.80	95.17			62.77	5.27	0.00	27.13	VERTICAL	284	313	Average
4	2434.00	104.87			72.43	5.28	0.00	27.16	VERTICAL	284	313	Peak
5	2483.50	51.11	54.00	-2.89	18.51	5.33	0.00	27.27	VERTICAL	284	313	Average
6	2485.60	65.29	74.00	-8.71	32.69	5.33	0.00	27.27	VERTICAL	284	313	Peak

Item 3, 4 are the fundamental frequency at 2437 MHz.

Channel 9

	Freq	Level	Limit Line	Over Limit	Read Level	Cable Loss	Preamp Factor	Antenna Factor	Pol/Phase	T/Pos	A/Pos	Remark
	MHz	dBuV/m	dBuV/m	dB	dBuV	dB	dB	dB/m		deg	cm	
1	2453.80	92.18			59.67	5.30	0.00	27.21	VERTICAL	277	334	Average
2	2457.40	102.34			69.83	5.30	0.00	27.21	VERTICAL	277	334	Peak
3	2483.50	53.58	54.00	-0.42	20.98	5.33	0.00	27.27	VERTICAL	277	334	Average
4	2488.00	68.16	74.00	-5.84	35.56	5.33	0.00	27.27	VERTICAL	277	334	Peak

Item 1, 2 are the fundamental frequency at 2452 MHz.

Note:

Emission level (dBuV/m) = 20 log Emission level (uV/m).

Corrected Reading: Antenna Factor + Cable Loss + Read Level - Preamp Factor = Level.

For Emission not in Restricted Band

Plot on Configuration IEEE 802.11b / Reference Level

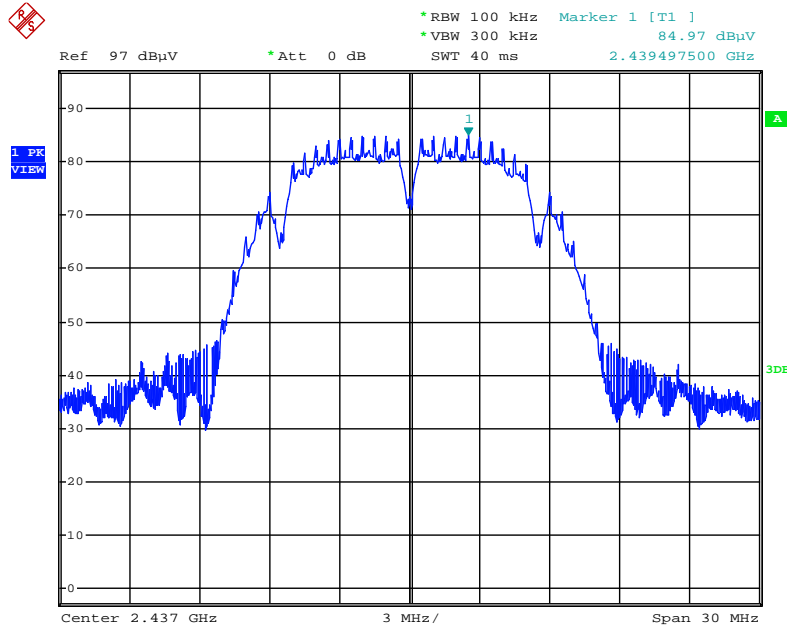

Date: 19.JAN.2016 20:52:37

Plot on Configuration IEEE 802.11b / CH 1 / 30MHz~2400MHz (down 30dBc)

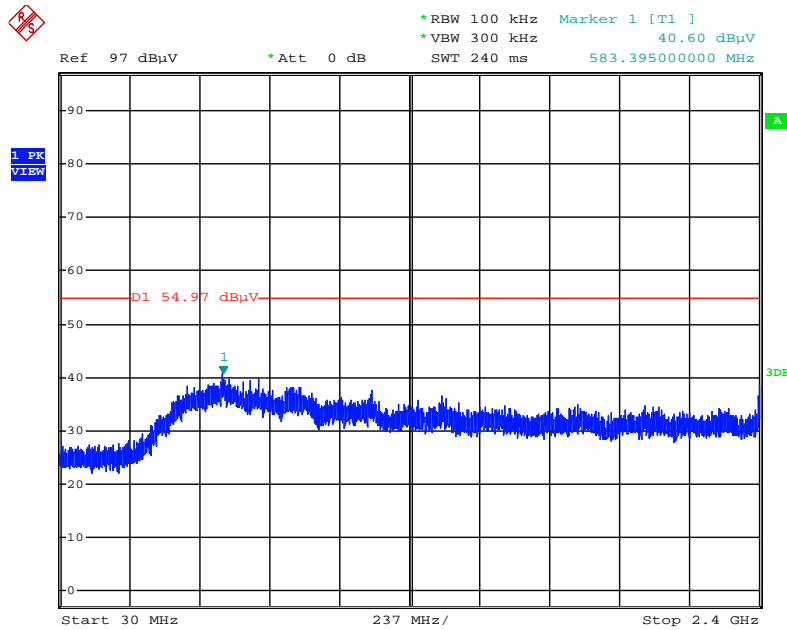

Date: 19.JAN.2016 20:53:25

Plot on Configuration IEEE 802.11b / CH 1 / 2500MHz~26500MHz (down 30dBc)

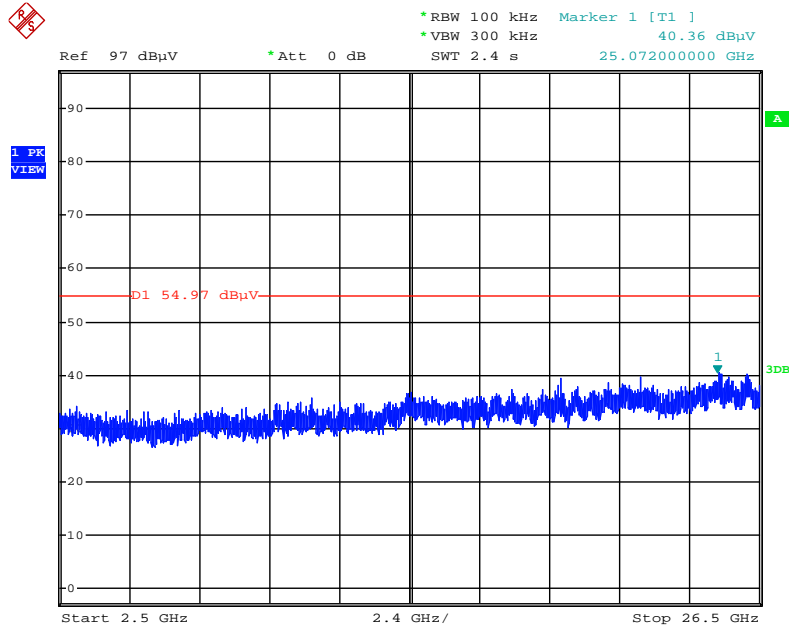

Date: 19.JAN.2016 20:53:53

Plot on Configuration IEEE 802.11b / CH 11 / 30MHz~2400MHz (down 30dBc)

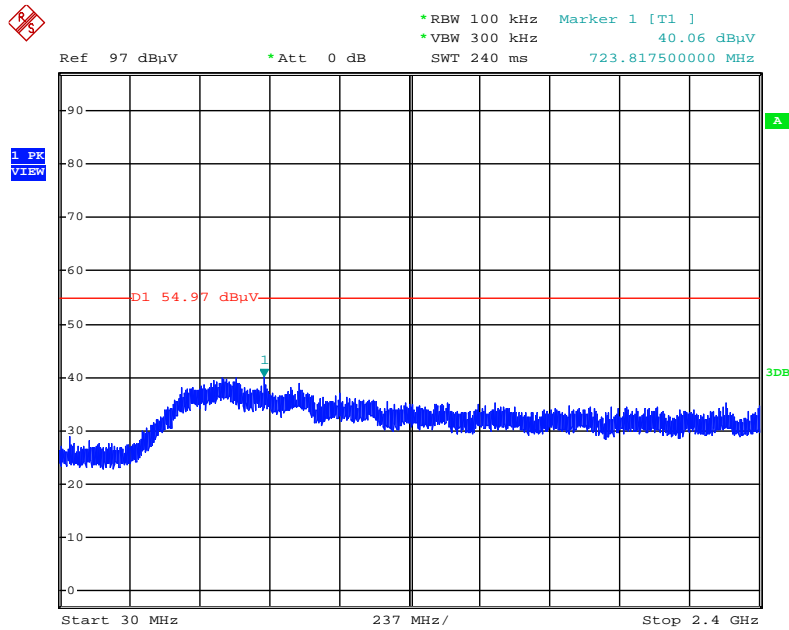

Date: 19.JAN.2016 20:55:24

Plot on Configuration IEEE 802.11b / CH 11 / 2500MHz~26500MHz (down 30dBc)

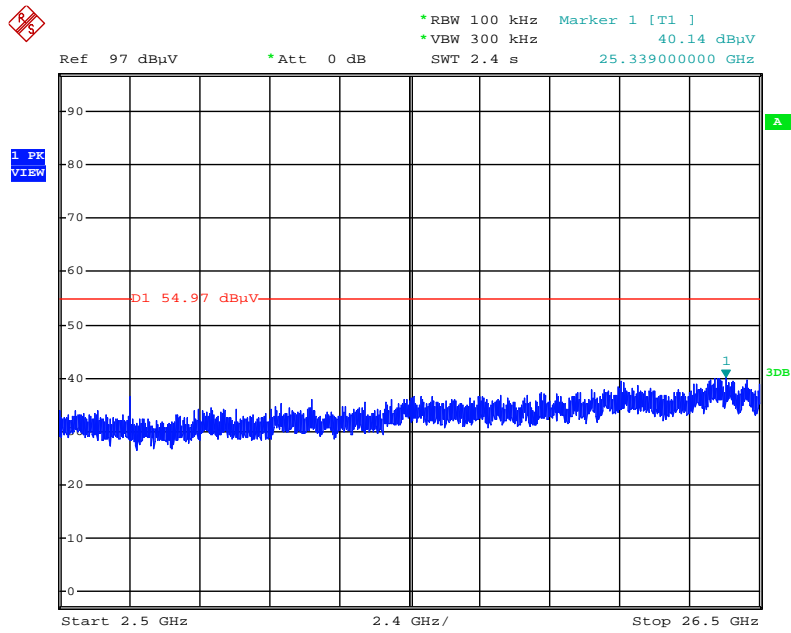

Date: 19.JAN.2016 20:54:42

Plot on Configuration IEEE 802.11g / Reference Level

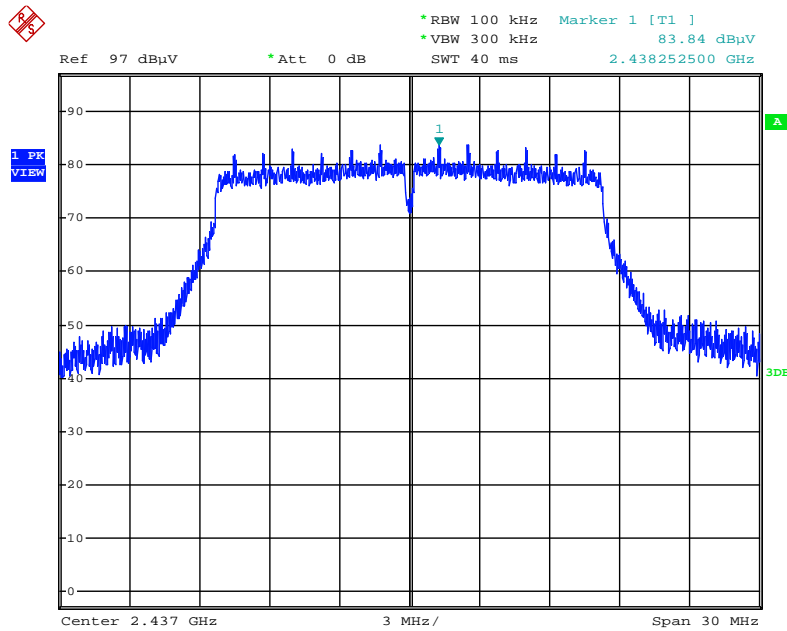

Date: 19.JAN.2016 20:57:47

Plot on Configuration IEEE 802.11g / CH 1 / 30MHz~2400MHz (down 30dBc)

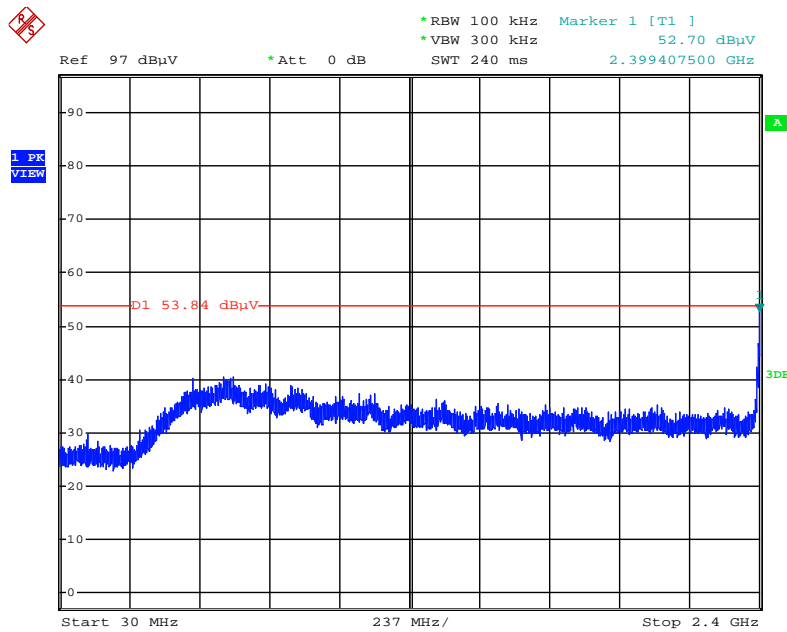

Date: 19.JAN.2016 20:58:50

Plot on Configuration IEEE 802.11g / CH 1 / 2500MHz~26500MHz (down 30dBc)

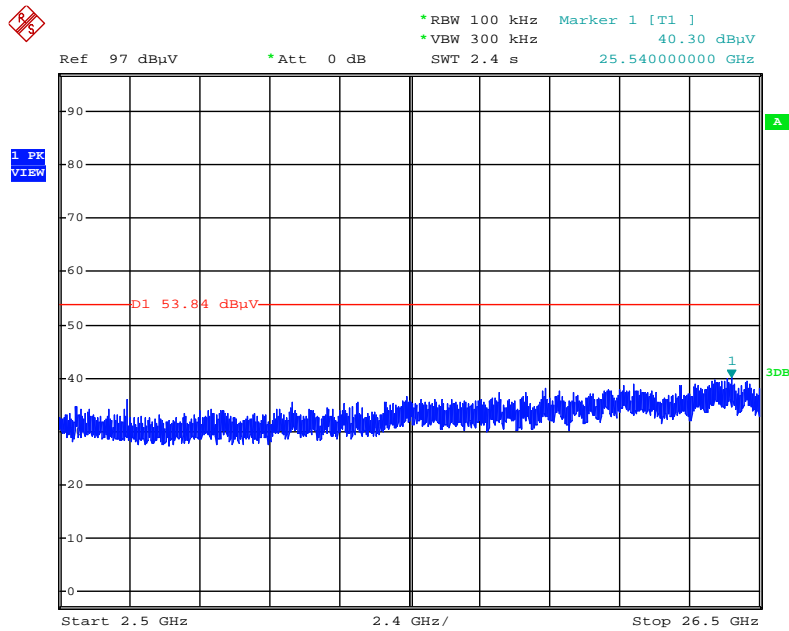

Date: 19.JAN.2016 20:59:17

Plot on Configuration IEEE 802.11g / CH 11 / 30MHz~2400MHz (down 30dBc)

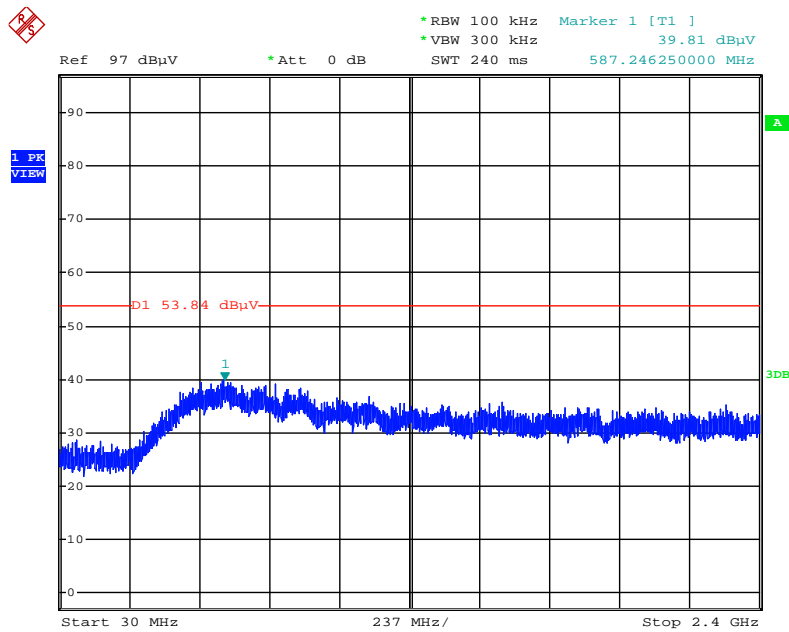

Date: 19.JAN.2016 21:00:57

Plot on Configuration IEEE 802.11g / CH 11 / 2500MHz~26500MHz (down 30dBc)

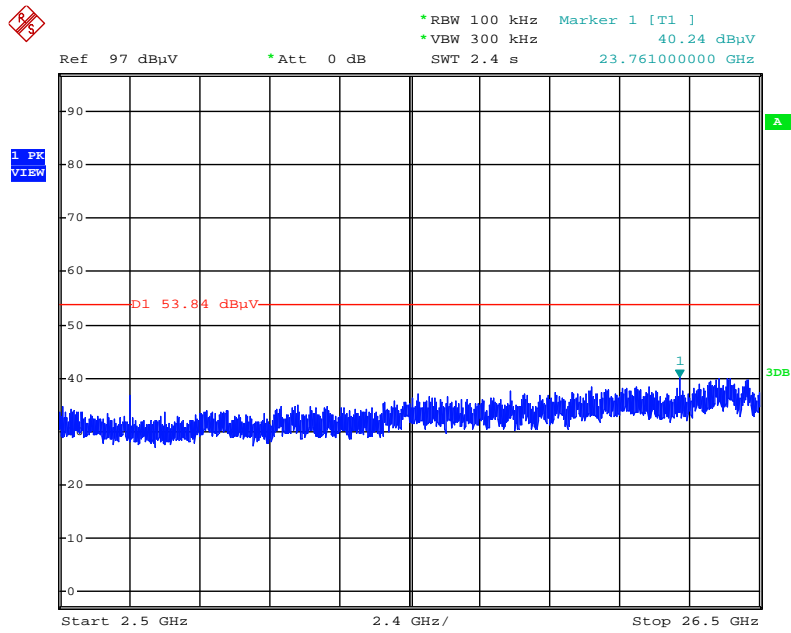

Date: 19.JAN.2016 21:01:21

Plot on Configuration IEEE 802.11n MCS0 HT20 / Reference Level

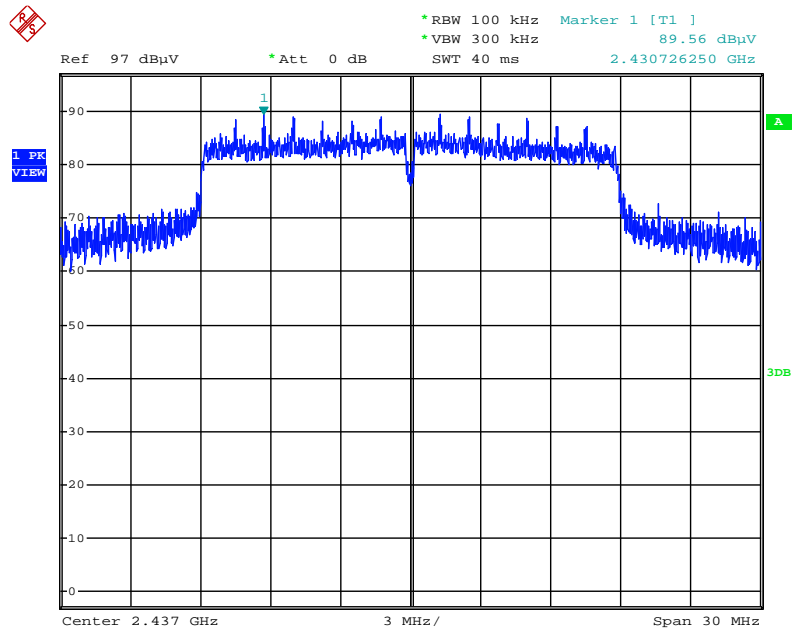

Date: 19.JAN.2016 21:04:24

Plot on Configuration IEEE 802.11n MCS0 HT20 / CH 1 / 30MHz~2400MHz (down 30dBc)

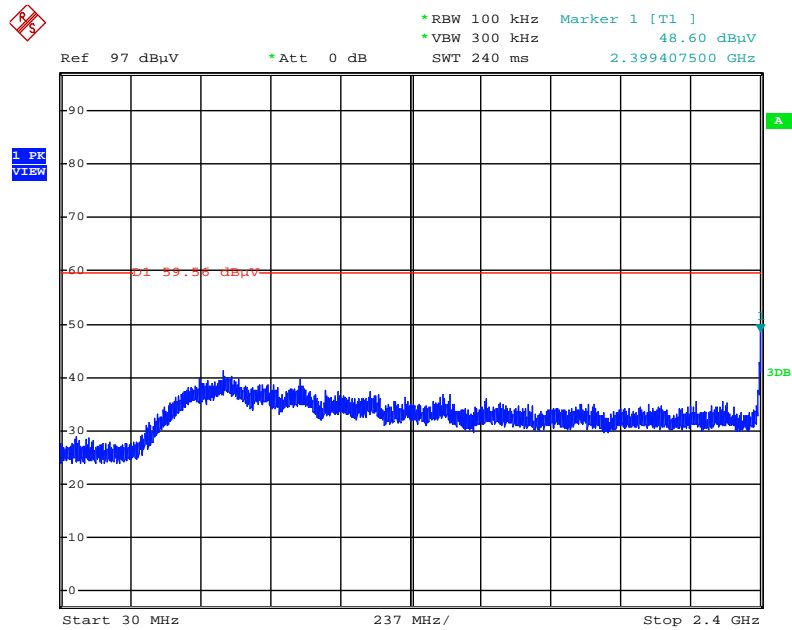

Date: 19.JAN.2016 21:06:19

Plot on Configuration IEEE 802.11n MCS0 HT20 / CH 1 / 2500MHz~26500MHz (down 30dBc)

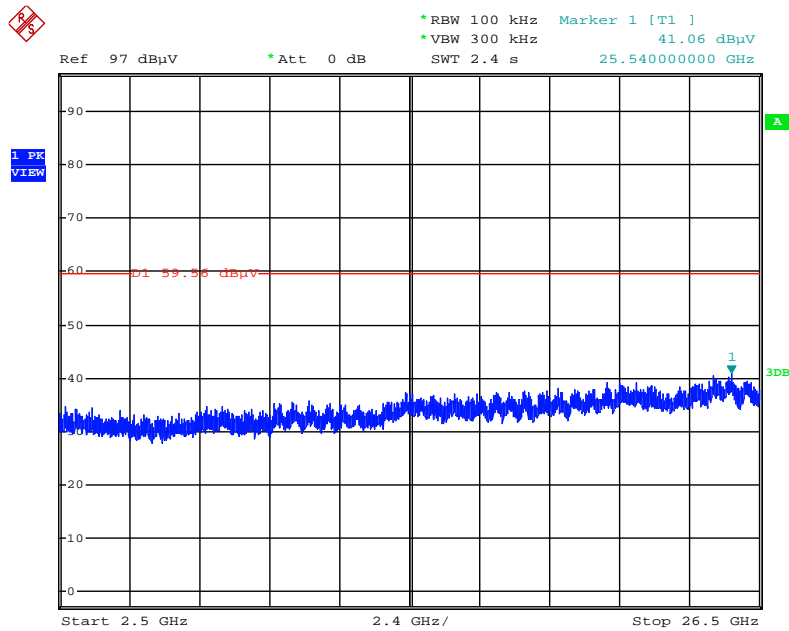

Date: 19.JAN.2016 21:07:17

Plot on Configuration IEEE 802.11n MCS0 HT20 / CH 11 / 30MHz~2400MHz (down 30dBc)

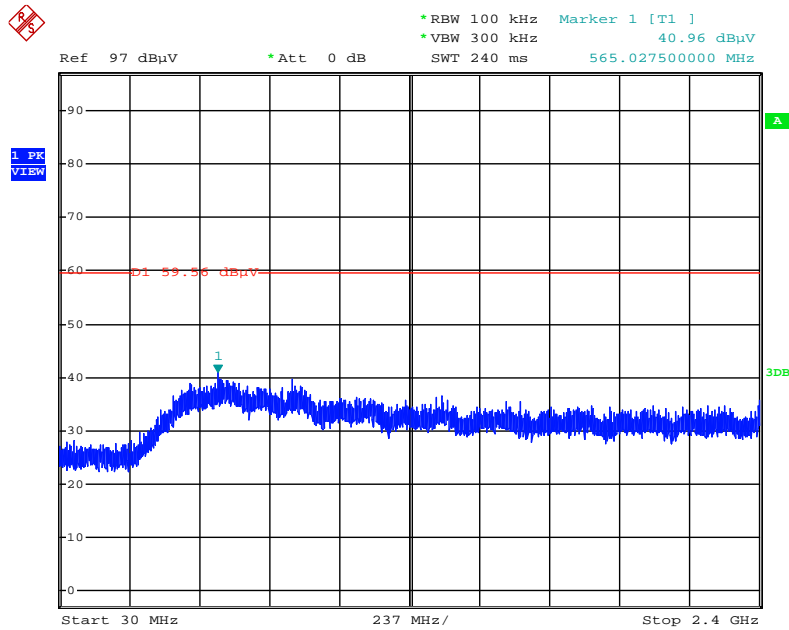

Date: 19.JAN.2016 21:16:32

Plot on Configuration IEEE 802.11n MCS0 HT20 / CH 11 / 2500MHz~26500MHz (down 30dBc)

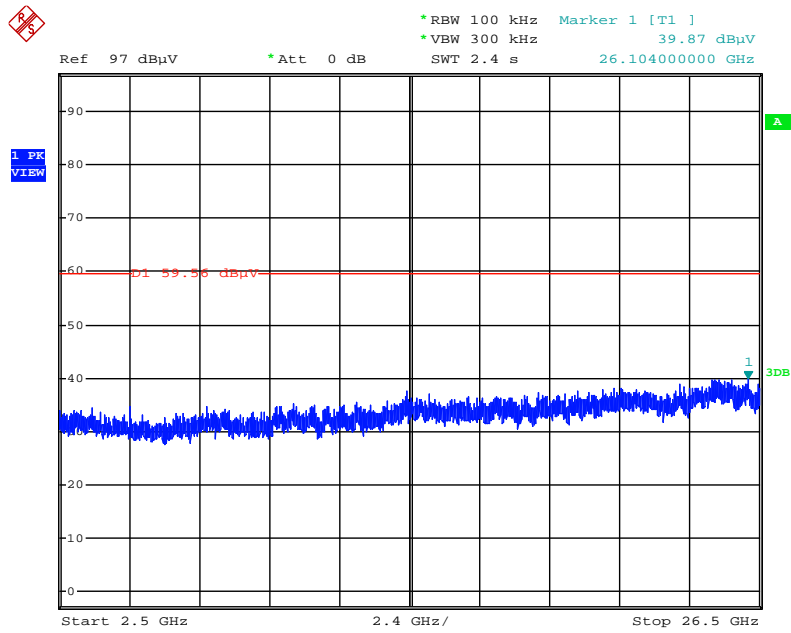

Date: 19.JAN.2016 21:09:09

Plot on Configuration IEEE 802.11n MCS0 HT40 / Reference Level

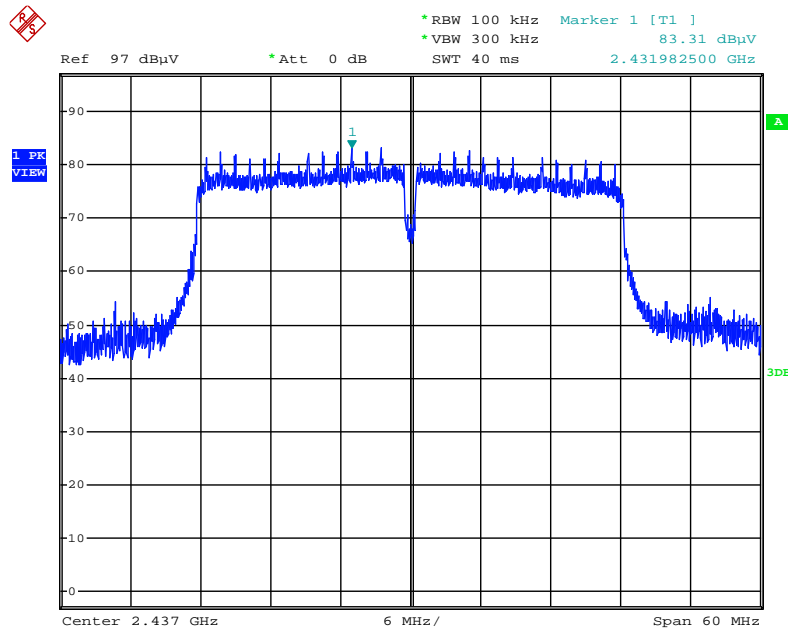

Date: 19.JAN.2016 21:12:13

Plot on Configuration IEEE 802.11n MCS0 HT40 / CH 3 / 30MHz~2400MHz (down 30dBc)

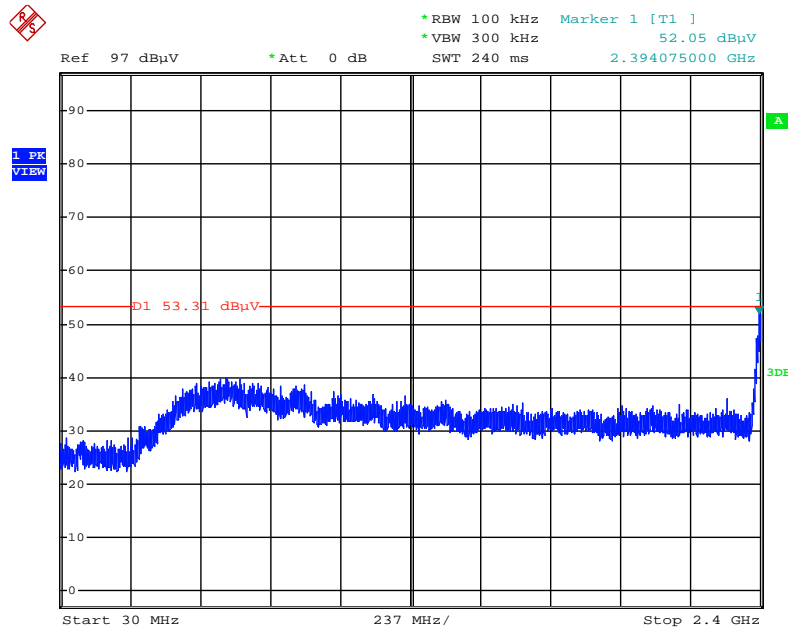

Date: 19.JAN.2016 21:13:39

Plot on Configuration IEEE 802.11n MCS0 HT40 / CH 3 / 2500MHz~26500MHz (down 30dBc)

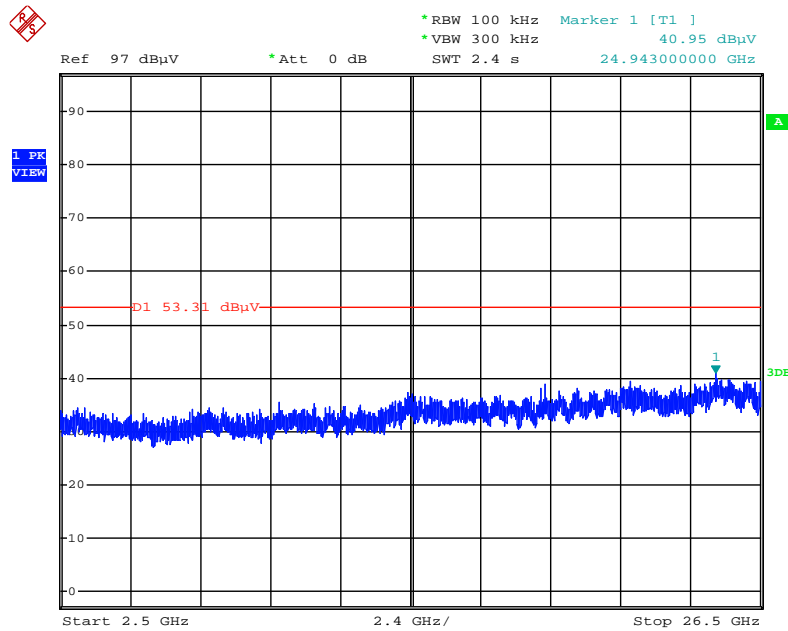

Date: 19.JAN.2016 21:14:10

Plot on Configuration IEEE 802.11n MCS0 HT40 / CH 9 / 30MHz~2400MHz (down 30dBc)

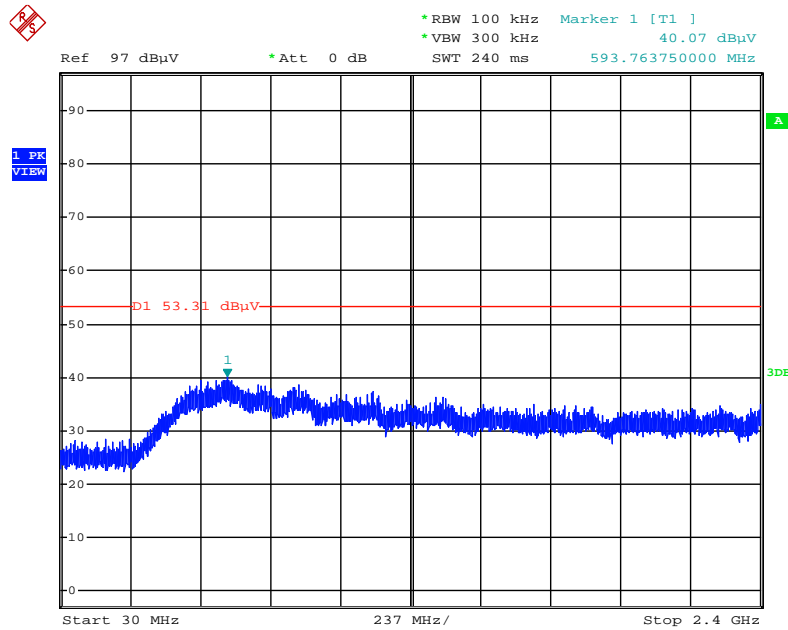

Date: 19.JAN.2016 21:15:53

Plot on Configuration IEEE 802.11n MCS0 HT40 / CH 9 / 2500MHz~26500MHz (down 30dBc)

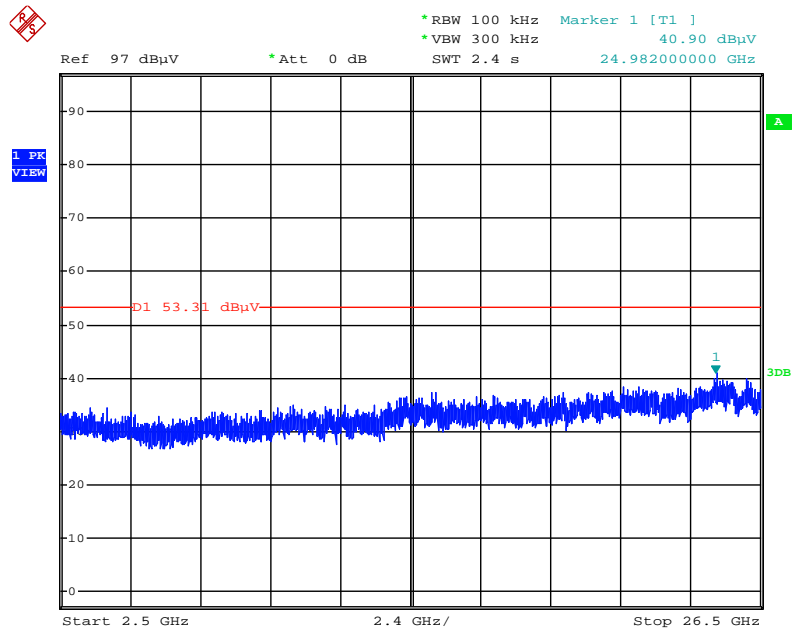

Date: 19.JAN.2016 21:15:27

4.7. Antenna Requirements

4.7.1. Limit

Except for special regulations, the Low-power Radio-frequency Devices must not be equipped with any jacket for installing an antenna with extension cable. An intentional radiator shall be designed to ensure that no antenna other than that furnished by the responsible party shall be used with the device. The use of a permanently attached antenna or of an antenna that uses a unique coupling to the intentional radiator shall be considered sufficient to comply with the provisions of this Section. The manufacturer may design the unit so that the user can replace a broken antenna, but the use of a standard antenna jack or electrical connector is prohibited. Further, this requirement does not apply to intentional radiators that must be professionally installed.

4.7.2. Antenna Connector Construction

Please refer to section 3.3 in this test report; antenna connector complied with the requirements.

5. LIST OF MEASURING EQUIPMENTS

Instrument	Manufacturer	Model No.	Serial No.	Characteristics	Calibration Date	Remark
LISN	Schwarzbeck	NSLK 8127	8127650	9kHz ~ 30MHz	Nov. 16, 2015	Conduction (CO02-CB)
LISN	Schwarzbeck	NSLK 8127	8127478	9kHz ~ 30MHz	Nov. 13, 2015	Conduction (CO02-CB)
EMI Receiver	Agilent	N9038A	MY52260140	9kHz ~ 8.4GHz	Jan. 18, 2016	Conduction (CO02-CB)
COND Cable	Woken	Cable	01	0.15MHz ~ 30MHz	Dec. 01, 2015	Conduction (CO02-CB)
Software	Audix	E3	6.120210n	-	N.C.R.	Conduction (CO02-CB)
Pulse Limiter	Schwarzbeck	VTSD 9561F	9561-F073	9kHz ~ 30MHz	Sep. 30, 2015	Conduction (CO02-CB)
BILOG ANTENNA	Schaffner	CBL6112D	37880	20MHz ~ 2GHz	Sep. 03, 2015	Radiation (O3CH01-CB)
Loop Antenna	Teseq	HLA 6120	24155	9kHz - 30 MHz	Mar. 12, 2015*	Radiation (O3CH01-CB)
Horn Antenna	EMCO	3115	00075790	750MHz ~ 18GHz	Oct. 22, 2015	Radiation (O3CH01-CB)
Horn Antenna	Schwarzbeck	BBHA 9170	BBHA9170252	15GHz ~ 40GHz	Jul. 21, 2015	Radiation (O3CH01-CB)
Pre-Amplifier	Agilent	8447D	2944A10991	0.1MHz ~ 1.3GHz	Feb. 24, 2015	Radiation (O3CH01-CB)
Pre-Amplifier	Agilent	8449B	3008A02310	1GHz ~ 26.5GHz	Jan. 18, 2016	Radiation (O3CH01-CB)
Pre-Amplifier	WM	TF-130N-R1	923365	26GHz ~ 40GHz	Feb.10, 2015	Radiation (O3CH01-CB)
Spectrum Analyzer	R&S	FSP40	100056	9kHz ~ 40GHz	Oct. 27, 2015	Radiation (O3CH01-CB)
RF Cable-low	Woken	Low Cable-1	N/A	30 MHz ~ 1 GHz	Nov. 02, 2015	Radiation (O3CH01-CB)
RF Cable-high	Woken	High Cable-16	N/A	1 GHz ~ 18 GHz	Nov. 02, 2015	Radiation (O3CH01-CB)
RF Cable-high	Woken	High Cable-17	N/A	1 GHz ~ 18 GHz	Nov. 02, 2015	Radiation (O3CH01-CB)
RF Cable-high	Woken	High Cable-40G-1	N/A	18GHz ~ 40 GHz	Nov. 02, 2015	Radiation (O3CH01-CB)
RF Cable-high	Woken	High Cable-40G-2	N/A	18GHz ~ 40 GHz	Nov. 02, 2015	Radiation (O3CH01-CB)
Test Software	Audix	E3	6.2009-I0-7	N/A	N/A	Radiation (O3CH01-CB)
Spectrum analyzer	R&S	FSV40	100979	9kHz~40GHz	Dec. 09, 2015	Conducted (TH01-CB)
RF Cable-high	Woken	RG402	High Cable-7	1 GHz – 26.5 GHz	Nov. 02, 2015	Conducted (TH01-CB)
RF Cable-high	Woken	RG402	High Cable-8	1 GHz – 26.5 GHz	Nov. 02, 2015	Conducted (TH01-CB)
RF Cable-high	Woken	RG402	High Cable-9	1 GHz – 26.5 GHz	Nov. 02, 2015	Conducted (TH01-CB)
RF Cable-high	Woken	RG402	High Cable-10	1 GHz – 26.5 GHz	Nov. 02, 2015	Conducted (TH01-CB)
RF Cable-high	Woken	RG402	High Cable-6	1 GHz – 26.5 GHz	Nov. 02, 2015	Conducted (TH01-CB)
Power Sensor	Agilent	U2021XA	MY53410001	50MHz~18GHz	Nov. 02, 2015	Conducted (TH01-CB)

Note: Calibration Interval of instruments listed above is one year.

“*” Calibration Interval of instruments listed above is two years.

N.C.R. means Non-Calibration required.

6. MEASUREMENT UNCERTAINTY

Test Items	Uncertainty	Remark
Conducted Emission (150kHz ~ 30MHz)	3.2 dB	Confidence levels of 95%
Radiated Emission (30MHz ~ 1,000MHz)	3.6 dB	Confidence levels of 95%
Radiated Emission (1GHz ~ 18GHz)	3.7 dB	Confidence levels of 95%
Radiated Emission (18GHz ~ 40GHz)	3.5 dB	Confidence levels of 95%
Conducted Emission	1.7 dB	Confidence levels of 95%